

Specifications



1800374343

ADGBA-1975

Deli Display

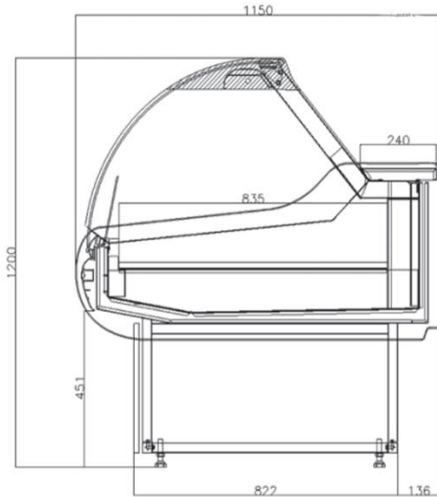

CABINET DIMENSIONS

	External
Height:	1200mm
Width:	1975mm
Depth:	1150mm
Floor area:	2.27m ²



CABINET SPECIFICATIONS

Refrigeration system:	Electronic controlled, Ventilate Cooling
Refrigerant / Charge:	R404A
Lid type :	Open doors
Cabinet temperature range:	0°C to +5°C
Condensate Water:	Stainless steel automatic evaporation
Electrical:	220-240 Volts a.c. 50 Hz
Power cord length:	2.5m
Internal lighting:	1LED
Bottom:	Stainless steel
Feet:	Wheel or feet
Insulation:	50mm polyurethane foam
Total weight:	140 kg

Austune Australia Pty Ltd reserve the right to alter specifications without notice.

Austune Australia Pty Ltd

Unit 3, 35 Davis Road Wetherill Park NSW 2164

Tel: 02 9725 1578