

Specifications



1800374343

ADSZB-3750

Deli Display

CABINET DIMENSIONS

	External
Height:	1222mm
Width:	3750mm
Depth:	1180mm
Floor area:	4.42m ²

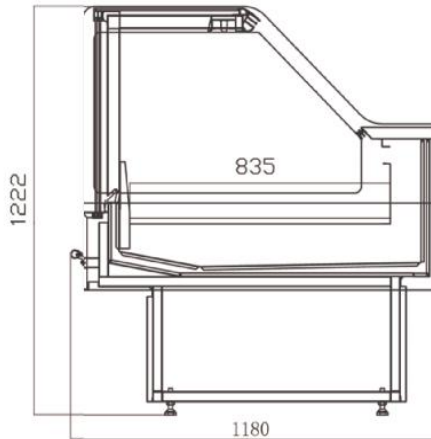

CABINET SPECIFICATIONS

Refrigeration system:	Electronic controlled, Ventilate Cooling
Refrigerant / Charge:	R404A
Nominal capacity:	900Watts
Lid type :	Lift up open doors
Cabinet temperature range:	0°C to +5°C
Condensing Water:	Stainless steel automatic evaporation
Electrical:	220-240 Volts a.c. 50 Hz
Power cord length:	2.5m
Internal lighting:	1LED
Bottom:	Stainless steel
Feet:	Wheel or feet
End Panel :	Hollow Side Panel
Total weight:	340 kg

Austune Australia Pty Ltd reserve the right to alter specifications without notice.

Austune Australia Pty Ltd

Unit 3, 35 Davis Road Wetherill Park NSW 2164

Tel: 02 9725 1578