

E8 纽约

E8 NEW YORK



E8 纽约 (玻璃门冷藏柜)

E8 NEW YORK (GLASS-DOOR CABINET)



小鸭智慧冷链 想您所享

产品用途 PURPOSE

- 运行温度为3M2 (-1~7℃)，用于展示和销售饮料、奶制品、香肠类、熟食等日配品。
- 运行温度为3H1 (1~10℃)，用于展示和销售各种水果、蔬菜等食品。
- 长度有997mm、1310mm、1935mm、2560mm (含两个侧肩厚度60mm) 四种基本规格，可以任意拼接。
- Running temperature 3M2 (-1~7℃) for daily necessities, such as beverage, milk, sausages and cooked food etc.
- Running temperature 3H1 (1~10℃) for fruit and vegetables etc.
- 4 basic lengths: 997mm、1310mm、1935mm and 2560mm (2 end wall thickness is 60mm), can be jointed together freely.

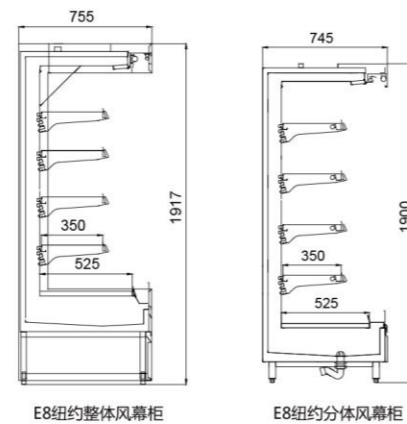

E8纽约整体风幕柜

E8纽约分体风幕柜

产品特点 FEATURES

- 不同柜体长度可自由拼接(包括玻璃门系列)，满足超市不同的布局要求。
- 盲肩、镜子肩、全景肩和拼接肩多种配置可选。
- 增加玻璃隔板可选配置，增加展示效果。多层搁板自由组合，角度可调，可根据展示物品进行调整。
- 低前沿高度，最大化的提高展示效果。前部装饰板拆卸方便，方便机组的维护和清洁。
- 低温/中温模式切换功能，满足不同环境工况及柜温要求。多种安全保护，确保冷柜使用中的安全性。
- Different cabinet length can be jointed freely (including with glass-door series), to meet different stores' layout demands.
- Various options are available for blind shoulder, mirror shoulder, panoramic shoulder and splice shoulder.
- Adding glass partition can be optional to increase display effect. Multi-layer shelves free combination with adjustable angle, can be regulated according to the display items. Low front edge height maximize to enhance display effect.
- Front decorative panel can be removed easily to make compressor unit cleaned and maintained conveniently.
- Low/medium temperature mode switching function to meet the different environmental conditions and cabinet temperature requirements. Multiple safety precautions ensure the safety of the freezer in use.

产品用途 PURPOSE

- 运行温度为3M1 (-1~5℃)，用于展示和销售海产品、鲜肉类。
- 运行温度为3M2 (-1~7℃)，用于展示和销售饮料、奶制品、香肠类、熟食等日配品。
- 长度有997mm、1310mm、1935mm、2560mm四种基本规格，可以任意拼接。
- Running temperature 3M1 (-1~5℃) for seafood, meat etc.
- Running temperature 3M2 (-1~7℃) for daily necessities, such as beverage, milk, sausages and cooked food etc.
- 4 basic lengths: 997mm、1310mm、1935mm and 2560mm, can be jointed together freely.

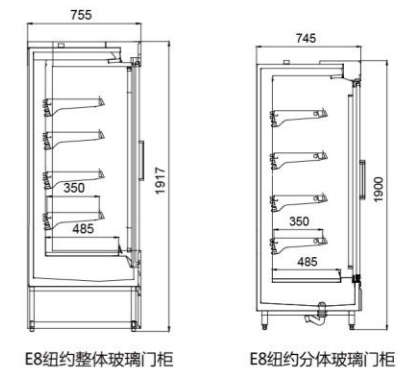

E8纽约整体玻璃门柜

E8纽约分体玻璃门柜

产品特点 FEATURES

- 不同柜体长度可自由拼接(包括风幕柜系列)，满足超市不同布局要求；盲肩、镜子肩和拼接肩多种配置可选。
- 增加玻璃隔板可选配置，增加展示效果。多层搁板自由组合，角度可调，可根据展示物品进行调整。
- 低前沿高度，最大化的提高展示效果。前部装饰板拆卸方便，方便机组的维护和清洁。
- 低温/中温模式切换功能，满足不同环境工况及柜温要求。多种安全保护，确保冷柜使用中的安全性。
- 中空防凝露玻璃门设计，节能降耗，保证展示食品安全。
- Different cabinet length can be jointed freely (including with air curtain series), to meet different stores' layout demands.
- Various options are available for blind shoulder, mirror shoulder, panoramic shoulder and splice shoulder.
- Adding glass partition can be optional to increase display effect. Multi-layer shelves free combination with adjustable angle, can be regulated according to the display items. Low front edge height maximize to enhance display effect.
- Front decorative panel can be removed easily to make compressor unit cleaned and maintained conveniently.
- Low/medium temperature mode switching function to meet the different environmental conditions and cabinet temperature requirements. Multiple safety precautions ensure the safety of the freezer in use.
- Insulating anti-condensation glass door design, energy-saving and cost-reducing, ensures the safety of display food.

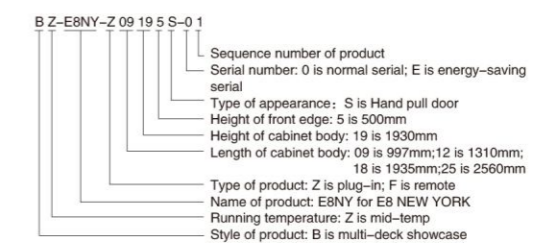
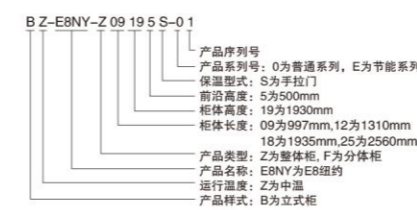
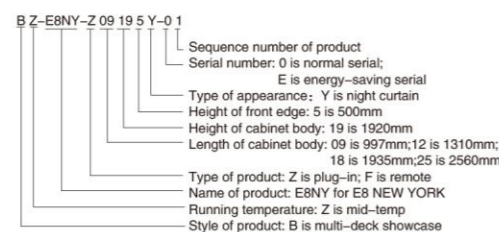

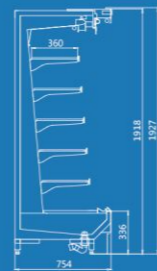

EA纽约分体冷藏柜

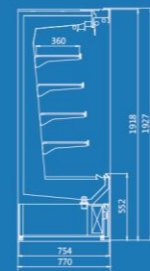

EA纽约整体冷藏柜

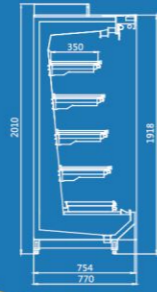

EA纽约分体冷热柜
BZR-EANY-F09203Y-01



EA纽约整体冷热柜
BZR-EANY-Z09195Y-01



产品用途 PURPOSE

- 冷藏柜根据不同的使用需求可以设定不同的温度范围: H1(1-10℃)用于展示和销售各种水果、蔬菜等; M2(-1-7℃)用于展示和销售饮料、香肠类、熟食等日配品; 热柜模式(45-55℃), 用于展示和销售咖啡、奶茶等热饮, 及汉堡等开袋即食产品。
- 冷藏柜为分体柜和整体柜两种柜型, 长度有: 937mm,1250mm,1875mm,2500mm四种规格(不含侧肩厚度), 可以任意拼接; 冷热柜长度为937mm(不含侧肩厚度)。
- Different temperature ranges can be set according to operating requirements: H1 (1-10℃) is for displaying fruits and vegetables; M2(-1-7℃) is used for exhibiting beverages, sausages and deli; heated temperature (45-55℃) is for displaying hot drinks, such as coffee and milky tea, and hamburger which is ready to be served.
- This model of freezer was divided into plug-in and remote type. Four basic lengths cabinets--937mm, 1250mm, 1875mm and 2500mm (without end wall) --can be jointed together freely; while the type of hot-cold cabinet is only 937mm length (without end wall).

产品特点 FEATURES

- 采用独特的梯形层流风幕设计和背板出风技术, 梯度出风均匀, 柜内温度均衡, 有效降低陈列柜能耗; 采用优质夜帘保温, 零部件进行防腐防锈处理, 美观大方、性能高, 更适用于便利店使用; 设计有可扣接式蒸发风机座板结构, 控制盒可抽拉, 方便安装和维修; 搁板倾斜角度可调, 可根据卖场要求调节不同的展示效果; 冷热搁板数量可以自由调节。
- The Unique technology of trapezoid laminar flow air-curtain and air outlet from back boards ensures gradient airflow uniformly and balanced temperature in the cabinet, which lower energy consumption efficiently. High-quality night curtain makes temperature stable in good performance. Spare parts are treated with anti-corrosion and -rust process, making the cabinet in good appearance. The design of snap-on evaporating fan holder and pull-out controller is easy for installation and daily maintenance. The angle of racks is adjustable to achieve different display effects accordingly. The quantity of partition can be optional. The multilayer shelf can be combined at any angle, and the angle can be adjusted, so that different display effects can be adjusted according to the requirements of the store.

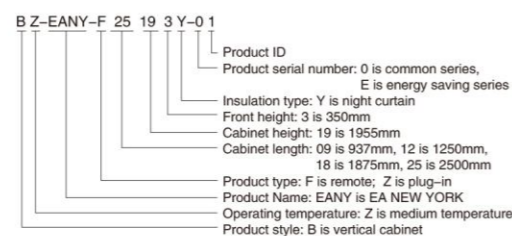

产品用途 PURPOSE

- 运行温度为 $\leq -18^{\circ}\text{C}$, 用于展示和销售各种速冻食品、海产品等。
- 长度有1350mm、1975mm两种基本规格, 可以任意拼接。
- Running temperature $\leq -18^{\circ}\text{C}$ for quick-frozen food and seafood etc.
- 2 basic lengths: 1350mm and 1975mm, can be jointed together freely.

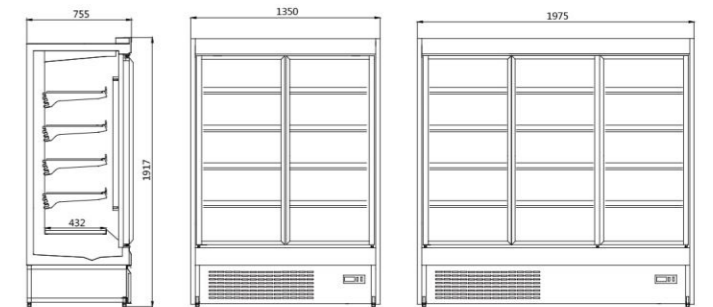

产品特点 FEATURES

- 不同柜体长度自由拼接, 满足超市不同的布局要求。
- 多层搁板/网层板自由组合, 角度可调, 可根据展示物品进行调整。
- 低前沿高度, 最大化的提高展示效果。
- 前部装饰板拆卸方便, 方便机组的维护和清洁。
- 多种安全保护, 确保冷柜使用中的安全性。
- 双中空防凝露玻璃门设计, 节能降耗, 保证展示食品安全。
- Different cabinet length can be jointed freely, to meet different stores' layout demands.
- Multi-layer shelves/grids free combination with adjustable angle, can be regulated according to the display items.
- Low front edge height maximize to enhance display effect.
- Front decorative panel can be removed easily to make compressor unit cleaned and maintained conveniently.
- Multiple safety protection ensures the safety performance of the freezer in use.
- Double insulating anti-condensation glass door design, energy-saving and cost-reducing, ensures the safety of display food.

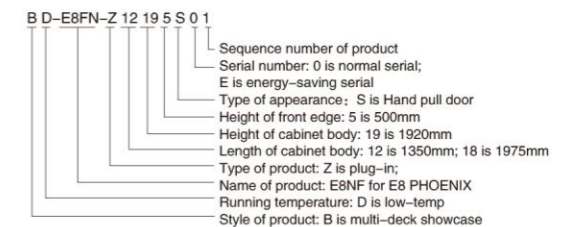



产品用途 PURPOSE

- 运行温度3H（3~10℃），用于展示奶制品、饮料、蔬果等冷藏食品。
- 多伦多为分体冷藏柜。
- Running temperature 3℃~10° for cooling food, such as milk, beverage, fruit and vegetables etc.
- TORONTO mostly for remote chilled cabinet.

产品特点 FEATURES

- 多维送风、瀑布式风幕，柜内温度均匀。层板梯度设计，展示效果好。
- 钢化玻璃层板，外观精致、大方。使用具有除湿效果的蒸发器，防止结霜影响柜内温度。
- 采用电子式控制器，数据精准，操作方便。
- Multi-dimensional air supply, waterfall air curtain, keep uniform temperature in the cabinet. Multi-layer shelf gradient design, better display effect.
- Tempered glass layer plate, elegant and generous in appearance. Using evaporator with dehumidifying effect prevents frosting from affecting the temperature in the cabinet.
- Electronic controller in precise data and easy operation.

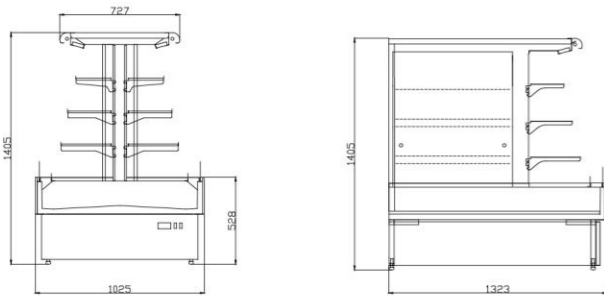

产品用途 PURPOSE

- 产品冷藏展示柜，高配置产品运行温度为1~10℃，适用于各种瓶装饮料及冷藏食品的展示和销售。
- Running temperature 1~10℃ for cooling food, such as milk, beverage.

产品特点 FEATURES

- 有三种长度规格可供选择（660mm，1310mm，1935mm）。
- 冷柜内部配有灯管，有效保证柜内照明。
- 钢化中空玻璃门，保温效果良好，节能降耗。
- High configuration product, 3 length for option（660mm, 1310mm, 1935mm）.
- light tubes equipped in cabinet to guarantee illumination inside.
- Tempered insulating glass door ensures better cooling effect and energy-saving and cost-reducing.

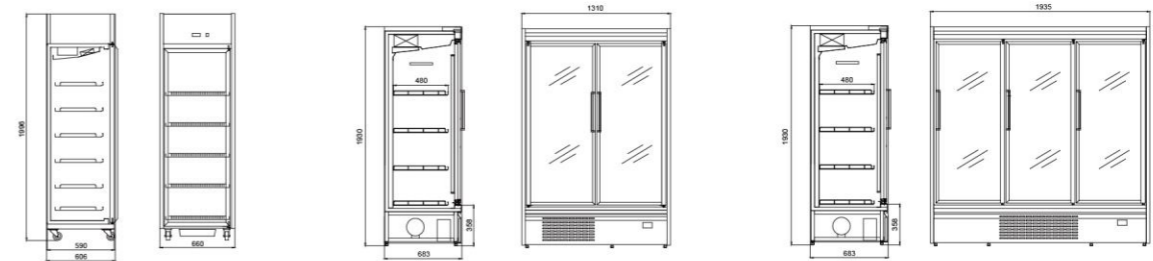

BZ-XZ-Z0620S-01

BZ-XZ-Z1320S-02

BZ-XZ-Z1920S-02

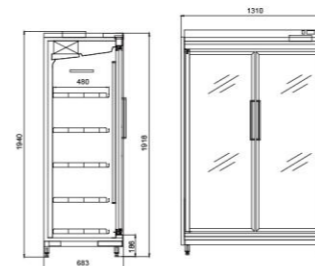

BZ-XZ-F1320S-02

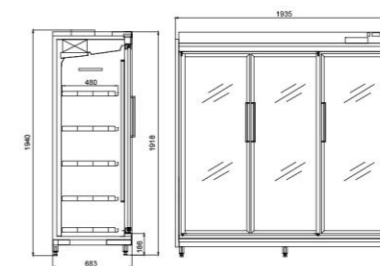

BZ-XZ-F1920S-02

新卡加利

NEW GALGARY

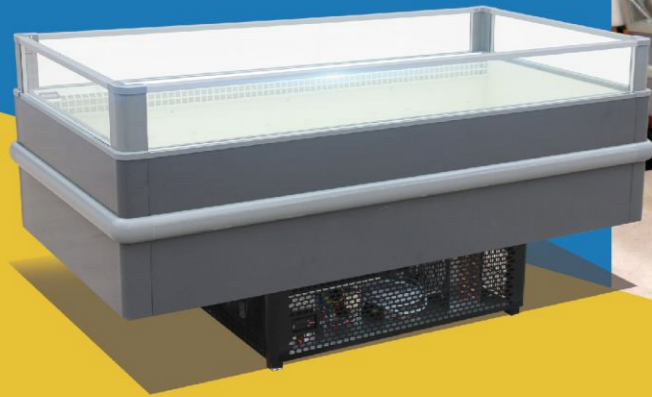

E9 兰辛

E9 LANSING



小鸭智慧冷链 想您所享

产品用途 PURPOSE

- 运行温度为-1~5℃时，用于冷藏展示和销售各种肉制品、海鲜品、熟食和乳制品等日配品。
- 运行温度为-18~-22℃时，用于冷冻展示和销售各种速冻食品、冰淇淋、海产品等。
- 长度有1580mm、2080mm和2580mm三种基本规格。
- Running temperature -1~5℃ for daily necessities, such as meat, seafood, cooked food and milk product etc.
- Running temperature -18~-22℃ for quick-frozen food, ice-cream, seafood etc.
- 3 basic lengths specification: 1580mm, 2080mm and 2580mm.

产品特点 FEATURES

- 有冷冻冷藏两种柜型可选，实现不同使用需求。采用先进的非对称层流风幕，有效减少柜内外热量和湿气交换。聚氨酯腔体整体发泡工艺，降低耗冷量，减少能耗。超薄大面积高效蒸发器，降温快，有效容积大。自蒸发式接水盘，使用方便、省心。产品可实现双温双控，方便用户使用。可选配推拉门结构，保证卫生，降低能耗。
- 2 kinds of cabinet type cooling-storage and freezing-storage for option, to achieve different use demands. Adopting the advanced asymmetric laminar flow air curtain effectively reduces the exchange of heat and humidity of the interior and exterior of the cabinet. Polyurethane frame work integral foaming process reduces cooling consumption and energy-saving. Ultra-thin and large area high-efficient evaporator rapidly reduce temperature. Large Effective volume. Self-evaporating water tray makes use conveniently and simply. Dual temperature & dual control are convenient for user. Sliding door structure can be optional ensures hygienic food and reducing energy-consumption.

D D-KJ-Z 15 Y-01

产品序列号
保温型式：Y为夜盖，Z为左右推拉门
柜体长度：15为1580mm，
20为2080mm，
25为2580mm
产品类型：Z为整体柜
产品名称：KJ为新卡加利
运行温度：D为低温
产品样式：D为岛柜

D D-KJ-Z 15 Y-01

Product ID
Y for night curtain, Z for slide door
Cabinet length: 15 is 1580mm,
20 is 2080mm,
25 is 2580mm
Product type: Z is plug-in
Product Name: KJ for NEW GALGARY
Operating temperature: D is low temperature
Product style: D is island cabinet

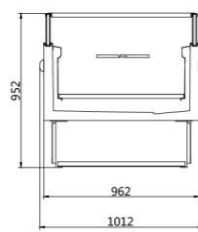

卡加利加夜盖

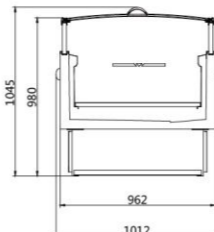

卡加利加推拉门

D D-E9LX-Z 18 Q-01

产品序列号
保温型式：Q为前后推拉门
柜体长度：15为1480mm,18为1880mm
25为2505mm,19为1905mm(封头柜)
产品类型：Z为整体柜
产品名称：E9LX为E9兰辛
运行温度：D为低温
产品样式：D为岛柜

D D-E9LX-Z 18 Q-01

Product serial number
Insulation type: Q for up and down sliding doors
Cabinet length: 15 is 1480mm, 18 is 1880mm
25 is 2505mm, 19 is 1905mm (terminal cabinet)
Product type: Z is plug-in
Product Name: E9LX is E9 LANSING
Operating temperature: D is low temperature
Product style: D is island cabinet

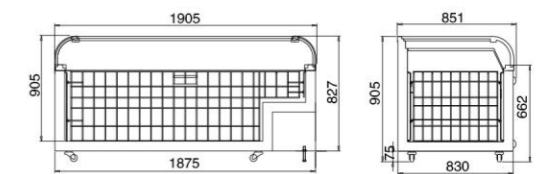

封头柜/Terminal cabinet

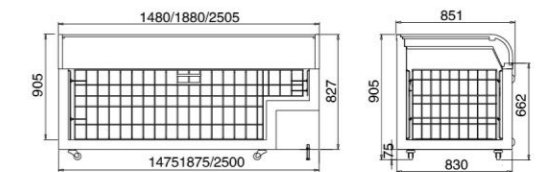

直柜/Direct cabinet



E8 哥伦比亚/维也纳

E8 COLUMBIA/VIENNA

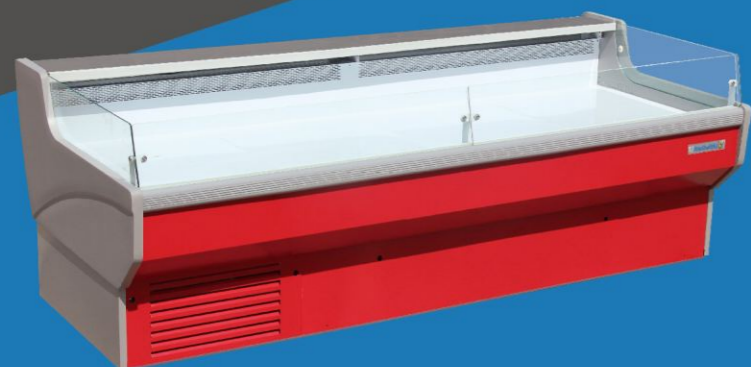

维也纳 平口式
VIENNA FLAT MOUTH



哥伦比亚 前推拉门
COLUMBIA FRONT PUSH AND PULL DOOR

制冷迅速

锁住水分更新鲜

精准控温

专用电子控制器

定时化霜

保证柜内无霜

能效比高

风幕制冷温度均匀

产品用途 PURPOSE

- 本产品主要用于冷藏展示和销售肉制品、海制品、熟食等，运行温度是3M1(-1~5℃)。
- 本产品为整体风冷柜，三种外观样式，多种长度可选，适应不同卖场和需求。
- 维也纳可选配90°圆弧外拐角。
- Running temperature M1 (-1℃~5℃) for meat, seafood, cooked food etc.
- This product is self-contained air curtain cabinet; there are three appearance styles and several lengths for option to suit different stores' demand.
- External angle of 90° in arc shape is optional for VIENNA.

产品特点 FEATURES

- 风冷展示柜利用通过蒸发器的强制冷风循环来实现制冷，降温速度快。
- 形成稳定风幕后，柜内温度均匀，无制冷死角。
- 冷风中的水蒸气冷凝在柜体内部的蒸发器上，采用定时化霜设计，变成冷凝水排出，保证了柜内展示商品的不结霜。
- 采用展示柜专用电子控制器，温度控制准确，保证商品展示温度。
- Air-cooled display cabinet use evaporator's forced cold-air circulation to achieve refrigeration, cooling fast.
- After forming a stable air curtain, the temperature inside of cabinet is uniform and even, no refrigerating dead ends.
- The vapors in cold air condensing on the evaporator of the cabinet turn into water to drain out, adopting the timed defrosting design ensures the commodities inside beyond frosted.
- Using special electronic temperature-controller keeps temperature in precision and ensures the display temperature.

FZ - E8GL - Z 20T-06

产品系列号
保温型式: T为推拉门系列
柜体长度: 12为1210mm, 15为1510mm
20为2010mm, 25为2510mm
产品类型: Z为整体柜
产品名称: EBGL为E8哥伦比亚
VN为维也纳
运行温度: Z为中温
产品样式: F为服务柜

FZ - E8GL - Z 20T-06

Product serial number
Insulation type: T is a sliding door series
Cabinet length: 12 for 1210mm, 15 for 1510mm
20 for 2010mm, 25 for 2510mm
Product type: Z is plug-in
Product Name: E8GL is E8 COLUMBIA
VN is VIENNA
Operating temperature: Z is medium temperature
Product style: F is service cabinet

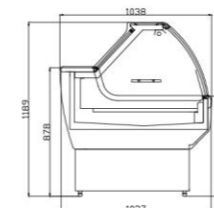

E8哥伦比亚 前推拉

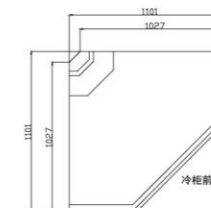

哥伦比亚外拐

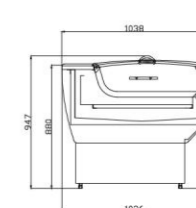

E8哥伦比亚平推拉

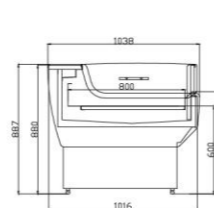

维也纳平口

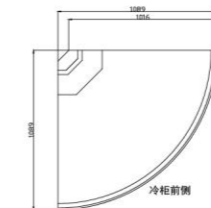

维也纳外拐

蛋糕柜

CAKE SHOWCASE

小鸭智慧冷链 想您所享



卖场展示图 STORE DISPLAY

小鸭智慧冷链 想您所享



产品用途 PURPOSE

- 温度范围: H1 (2~8℃) 用于展示和销售各类蛋糕, 面包等。
- 柜型为整体柜, 长度有: 1200mm, 1500mm, 1800mm 三种规格。
- Temperature range: H1 (2~8℃) is used for displaying and selling all kinds of cakes, breads, etc.
- The cabinet is a plug-in type with lengths of 1200mm, 1500mm and 1800mm.

产品特点 FEATURES

- 外观豪华气派, 展示面积大, 能最大限度的增加食品的展示效果;
- 全景式设计, 钢化中空加热玻璃, 自动除霜除雾, 强度大, 展示效果佳;
- 容积大, 占地面积小;
- 搁板角度可调, 可根据根据卖场要求调节不同的展示效果;
- 设计有高效预冷波纹翅片的蒸发器结构, 提高展示柜的制冷性能。
- Luxury appearance and large display area can maximize the display perspective for food;
- Panoramic design, hollow heated tempered glass and automatic defrosting and defogging ensure a good display effect;
- Large volume with using small floor area;
- The shelf angle can be adjusted to achieve different display effects according to users' requirement;
- The evaporator structure with efficient pre-cooling corrugated fins improves the refrigeration performance of display cabinets.

FZ-DG-Z 15 T-0 1

产品序列号
产品系列号: O为普通系列, E为节能系列
保温形式: T为推拉门
柜体长度: 12为1200mm, 15为1500mm
18为1800mm
产品类型: Z为整体
产品名称: DG为蛋糕柜
运行温度: Z为中温
产品样式: F为服务柜

FZ-DG-Z 15 T-0 1

Sequence Number of product
Serial number: O stands for normal serial, E stands for energy-saving serial
Insulation form: T stands for sliding door
length of cabinet body: 12 is 1200mm, 15 is 1500mm, 18 is 1800mm
Type of product: Z stands for plug-in type
Name of product: DG is cake showcase
Running temperature: Z is mid-temp
Style of product: F stands for counter showcase

