



# 壁式 冷冻冷藏展示柜

REMOTE FROZEN & REFRIGERATED  
MULTI-DECK DISPLAY CASE

- 07 E7 奥克兰/赫米特  
E7 AUCKLAND / E7 HEMET

---

- 09 E7 马里兰/麦克林  
E7 MARYLAND / E7 MCLEAN

---

- 11 E8 奥兰多  
E8 ORLANDO

---

- 13 EA 佐治亚  
EA GEORGIA

---

- 15 E7 亚特兰大/迈阿密  
E7 ATLANTA / E7 MIAMI

---

- 17 密苏里  
MISSOURI

---

- 19 E7 圣保罗  
E7 ST.PAWL

---

- 21 E7 奥斯汀  
E7 AUSTIN

---

- 23 E7 优瑞克  
E7 EURAKA

---

- 25 西西里  
SICILY



## E7 奥克兰/赫米特

E7 AUCKLAND / E7 HEMET



### 制冷迅速

锁住水分更新鲜

### 节能省电

顶灯隔板按需节能

### 展示性好

开口展示面更大

## 产品用途

## PURPOSE

- 运行温度为3M1(-1~5℃)时,用于展示和销售海产品、鲜肉类、奶制品等。
- 运行温度为3M2(-1~7℃)时,用于展示和销售饮料、香肠类、熟食品等日配品。
- 运行温度为3H(1~10℃)时,用于展示和销售各种水果、蔬菜等。
- 奥克兰长度有1250mm、1875mm、2200mm、2500mm、3750mm五种规格,可以任意拼接。
- 赫米特长度有1250mm、1875mm、2500mm、3750mm四种规格,可以任意拼接。

- 3M1(-1~5℃) for marine products and fresh meat and dairy products;
- 3M2(-1~7℃) for dairy products, such as beverage, sausages and cooked foods;
- 3H(1~10℃) for fruits and vegetables, etc.
- Auckland series have 5 basic length specifications: 1250mm, 1875mm, 2200mm, 2500mm and 3750mm, can being jointed together freely.
- Hemet series have 4 basic length specifications: 1250mm, 1875mm, 2500mm and 3750mm, can being jointed together freely.

## 产品特点

## FEATURES

- 容积大,占地面积小。
- 多层搁板任意组合,角度可调。
- 设计双灯开关,顶灯和搁板灯分开控制,按需节能。
- 可选配钢化中空玻璃门,安全、卫生、节能。
- 采用梯形层流风幕和背板出风技术,温度均匀,有效降低冷柜能耗。
- Large volume, small occupied area.
- Low height of the front edge and large open display area provide the better display effect.
- Multi-layer shelf board freely combine with angle adjustable,
- High efficiency pre-cooling corrugated fins of evaporator increases cooling performance.
- Top light and shelf light are controlled separately to save energy.
- Anti-condensation switch design suits for all different ambient condition.
- Optional tempered glass door ensures safe, hygienic and energy-efficient.
- Optional top mirror structure for better display effect.
- The technology of trapezoid laminar flow air curtain and air outlet from back board ensure the air flow evenly and energy-conservation.
- 前沿高度低,开口展示面积大,增加食品的展示效果。
- 采用高效预冷波纹翅片式蒸发器,提高展示柜的制冷性能。
- 防凝露开关设计,适应不同卖场环境工况。
- 可选顶部镜子结构,增加展示效果。

## 产品型号

## MODEL

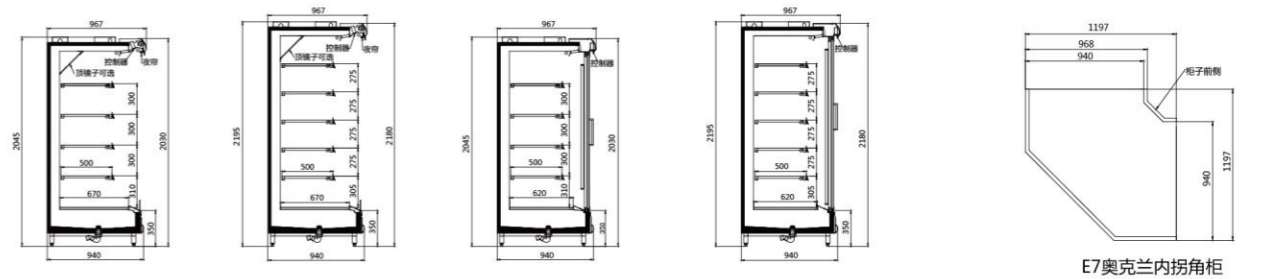

E7奥克兰

E7奥克兰玻璃门柜

E7奥克兰内拐角柜

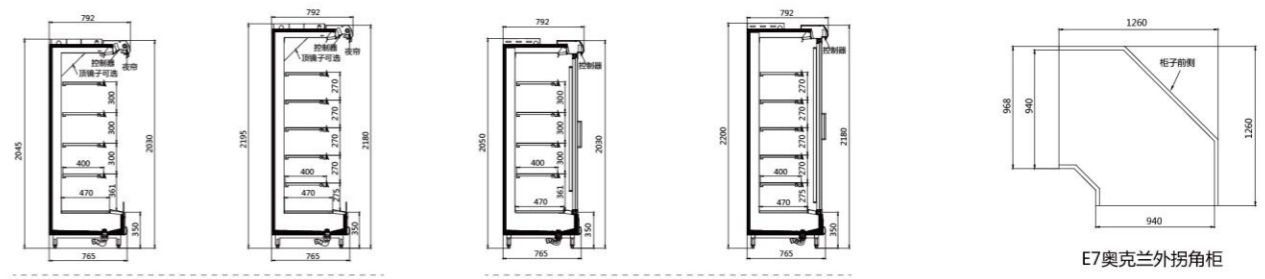

E7赫米特

E7赫米特玻璃门柜

E7奥克兰外拐角柜

B Z-E7OK-F 25 20 3 Y-0 1  
 产品序列号  
 产品系列号: 0为普通系列, E为节能系列  
 保温型式: Y为夜帘, S为把手玻璃门  
 前高高度: 3为350mm  
 柜体高度: 20为2030mm, 22为2180mm  
 柜体长度: 18为1875mm, 25为2500mm  
 37为3750mm  
 产品类型: F为分体柜  
 产品名称: E7OK为E7奥克兰,  
 E7MA为E7赫米特  
 运行温度: Z为中温  
 产品样式: B为立式柜

B Z-E7OK-F 25 20 3 Y-0 1  
 Sequence number of product  
 Serial number: 0 is normal serial;  
 E is energy-saving serial  
 Y is night curtain; S is door  
 Height of front edge: 3 is 350mm  
 Height of cabinet body: 20 is 2030mm;  
 22 is 2180mm  
 Length of cabinet body: 18 is 1875mm;  
 25 is 2500mm;  
 37 is 3750mm  
 Type of product: F is remote  
 Name of product: E7OK for E7 AUCKLAND;  
 E7HM for E7 HEMET  
 Running temperature: Z is mid-temp  
 Style of product: B is multi-deck showcase



## E7 马里兰/麦克林

E7 MARYLAND / E7 MCLEAN



### 外观大方

豪华气派 展示面大

### 双层风幕

风幕均匀 制冷迅速

### 制冷提鲜

制冷快 保鲜效果好

### 产品用途

### PURPOSE

- 3M1(-1~5℃)用于展示和销售海产品、鲜肉类。
- 3M2(-1~7℃)用于展示和销售饮料、奶制品、香肠类、熟食等日配品。
- 3H(1~10℃)用于展示和销售各种水果、蔬菜等食品。
- 长度有1875mm、2200mm、2500mm、3750mm四种规格，可以任意拼接。
- 3M1(-1~5℃) for marine products and fresh meat.
- 3M2(-1~7℃) for dairy products, such as beverage, milk, sausages and cooked foods.
- 3H(1~10℃) for fruits and vegetables, etc.
- 4 basic length specifications: 1875mm, 2200mm, 2500mm and 3750mm. Can be jointed together freely to suit your length requirements.



### 产品特点

### FEATURES

- 外观豪华气派，开口展示面积大，能最大限度的增加食品的展示效果。
- 双层风幕设计使风幕更加均匀，形成风幕的风速和温度梯度，减少冷柜的热负荷，达到节能的目的，比传统陈列柜节能35%以上。
- 该产品制冷快，温度均匀，提高了食品的保鲜品质。
- 排水管前置，控制盒盖可掀，方便安装、操作和维修，降低维护和维修成本。
- 该产品设计有双灯开关，顶灯和搁板灯分开控制，便于控制节电。
- 可选顶部镜子结构，增加展示效果。
- Luxury out-looking with big display area provides the best display effect.
- Double air curtain can make a even cooling environment and form the wind speed and temperature gradient, reduce the heat load of showcases to achieve the goal of energy conservation, so the efficient showcase consumes 35% less electricity than traditional models.
- Fast cooling and even temperature improve the quality of food preservation.
- Preposed drain-pipes and liftable cover of the controller box ensure easy to install/ operate/ repair and reduce maintenance cost.
- Top light and shelf light are controlled separately to save energy.
- Optional top mirror structure for better display effect.

### 产品型号

### MODEL

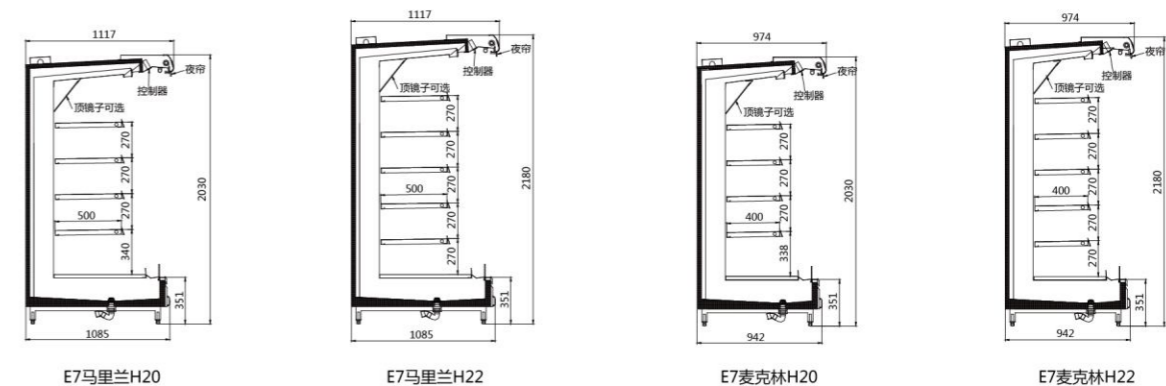

B Z-E7MK-F 25 20 3 Y-0 1

1 产品序列号  
 产品系列号: 0为普通系列, E为节能系列  
 保温型式: Y为夜帘  
 前背高度: 3为350mm, 22为2180mm  
 柜体高度: 20为2030mm, 22为2200mm  
 柜体长度: 18为1875mm, 22为2200mm  
 25为2500mm, 37为3750mm  
 产品类型: F为分体柜  
 产品名称: E7MK为E7麦克林, E7ML为马里兰  
 运行温度: Z为中温  
 产品样式: B为立式柜

B Z-E7MK-F 25 20 3 Y-0 1

1 Sequence number of product  
 Serial number: 0 is normal serial; E is energy-saving serial  
 Y is night curtain  
 Height of front edge: 3 is 350mm; 4 is 450mm  
 Height of cabinet body: 20 is 2030mm; 22 is 2180mm  
 Length of cabinet body: 18 is 1875mm; 22 is 2200mm; 25 is 2500mm;  
 37 is 3750mm  
 Type of product: F is remote  
 Name of product: E7MK for E7 MCLEAN; E7ML for E7 MARYLAND  
 Running temperature: Z is mid-temp  
 Style of product: B is multi-deck showcase



## E8 奥兰多

E8 ORLANDO



### 瀑布式风幕

独特梯形层流出风

### 美观大方

优质夜帘+抗氧化

### 优选零件

搭载名牌控制器

## 产品特点

- 采用阶梯式搁板，形成瀑布式风幕，柜内温度均衡。
- 采用优质夜帘保温，美观，性能好。
- 零部件进行防腐防锈处理，美观大方，适合各大小超市，也可环岛拼接。
- 蒸发风机采用挂接方式，控制盒可抽拉，方便安装和维修。
- 采用名牌控制器，可实现多方面控制调节。
- 采用独特的梯形层流风幕设计和背板出风技术，梯度出风均匀，有效降低陈列柜能耗。
- 多层搁板任意组合，角度可调，可根据卖场要求调节不同的展示效果。

## FEATURES

- Trapezoid shelves, waterfall air curtain and uniform temperature.
- High-quality cloth fibre curtain make the temperature stable with beautiful appearance and good performance.
- Anti-corrosion & anti-rust treatment for spare parts, good appearance, suitable for all kinds of supermarket and convenience store.
- Evaporator fan in hanging type and control box can be push-pull are easy to install and repair.
- Famous brand controller can realize various control adjustment.
- Unique technology of trapezoid laminar flow air curtain and air outlet from back board ensure the air flow evenly and energy-conservation.
- Multi-layer shelves can be combined freely with angle adjustable to achieve different display effects.

## 产品型号

## MODEL

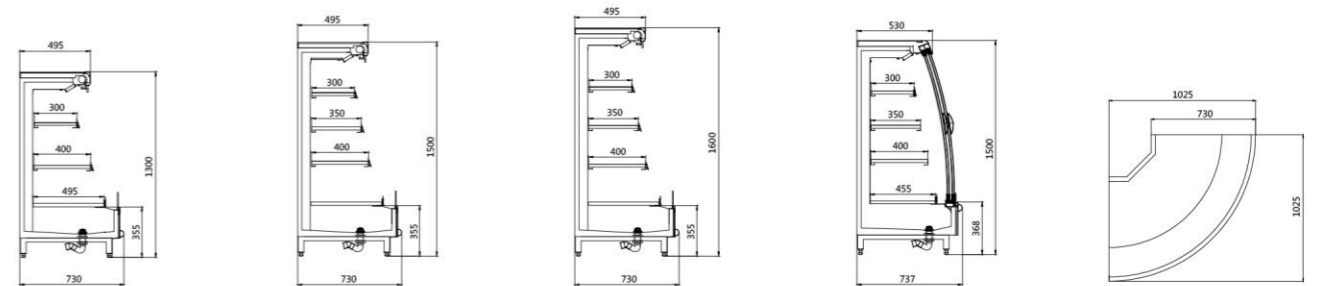

E8奥兰多H13

E8奥兰多H15

E8奥兰多H16

E8奥兰多前推拉H15

E8奥兰多90度外拐

## 产品用途

## PURPOSE

- 运行温度为3M1 (-1~5℃) 时，用于展示和销售各种海产品、鲜肉类等冷藏食品。
- 运行温度为3M2 (-1~7℃) 时，用于展示和销售各种饮料、奶制品、香肠类、熟食等日配品。
- 运行温度为3H1 (1~10℃) 时，用于展示和销售各种水果、蔬菜等食品。
- 高度有1300mm、1500mm、1600mm三种规格。长度有1250mm、1875mm、2500mm、3750mm四种基本规格，可以任意拼接，也可以与环岛柜拼接。
- 3M1(-1~5℃) for marine products and fresh meat.
- 3M2(-1~7℃) for dairy products, such as beverage, milk, sausages and cooked foods.
- 3H1(-10℃) for fruits and vegetables, etc.
- 3 specification of height: 1300mm、1500mm and 1600mm.
- 4 basic length specifications:1250mm, 1875mm, 2500mm and 3750mm. Can be jointed together freely to suit your length requirements, also can be jointed as a roundabout.

B Z-E8OL-F 25 16 3 Y-0 1  
 产品序列号  
 产品系列号: 0为普通系列, E为节能系列  
 保温形式: Y为夜帘  
 前帘高度: 3为350mm  
 柜体高度: 13为1300mm;16为1600mm  
 柜体长度: 12为1250mm;18为1875mm  
 25为2500mm;37为3750mm  
 产品类型: F为分体柜, Z为整体柜, FH为分体环岛  
 产品名称: E8OL为E8奥兰多  
 运行温度: Z为中温  
 产品样式: B为立式柜

B Z-E8OL-F 25 16 3 Y-0 1  
 Sequence number of product  
 Serial number: 0 is normal serial; E is energy-saving serial  
 Y is night curtain  
 Height of front edge: 3 is 350mm  
 Height of cabinet body: 13 is 1300mm; 16 is 1600mm  
 Length of cabinet body: 12 is 1250mm; 18 is 1875mm;  
 25 is 2500mm; 37 is 3750mm  
 Type of product: F is remote; Z is plug-in;  
 FH is remote round corner(180°)  
 Name of product: E8OL for E8 ORLANDO  
 Running temperature: Z is mid-temp  
 Style of product: B is multi-deck showcase



# EA 佐治亚

EA GEORGIA



节能50%

占地更少节能

外观大方

豪气气派 展示面大

瀑布式风幕

独特梯形层流吹风

多种灯饰

灯饰丰富展示性好

## 产品用途

## PURPOSE

- 运行温度为M1(-1~5℃)时，主要用于展示和销售海产品、鲜肉类、奶制品等冷藏食品。
  - 运行温度为M2(-1~7℃)时，用于展示和销售饮料、香肠类、熟食品等日配品；运行温度为H(1~10℃)时，用于展示和销售各种水果、蔬菜等食品。
  - 该柜型有整体柜和分体柜两种柜型。长度有1250mm、1875mm、2500mm和3750mm四种规格，有1300mm和1500mm两种高度，同时配有2050mm和2464mm两种长度的方形封头柜，有2050mm长度的圆形封头柜。可以任意拼接组合，满足客户卖场需求。
- Running temperature can be set according to the different demands: M1(-1~5℃) for seafood products, fresh meat, dairy products.
  - M2(-1~7℃) for beverages, sausage, deli. H(1~10℃) for fruits and vegetables, etc.
  - This freezer have two models — plug-in and remote type. Four basic lengths cabinets (1250mm, 1875mm, 2500mm and 3750mm) are equipped with two heights of 1300mm and 1500mm for option. Meanwhile there are two kinds of terminal end — square terminal ends in 2050mm and 2464mm and that of circle in 2050mm — can be jointed together freely to satisfy customers' requirement.

## 产品特点

## FEATURES

- 采用阶梯式搁板，瀑布式风幕设计，柜内温度均衡；
  - 独特的梯形层流风幕设计和背板出风技术，梯度出风均匀，有效降低陈列柜能耗；
  - 产品外形美观大方，直柜与封头可任意拼接，方便组合，适合超市卖场布局；
  - 采用可扣接式蒸发器风机座板结构设计，方便安装和维修；
  - 多层搁板任意组合，角度可调，可根据卖场要求调节不同的展示效果；
  - 标配LED灯，节能及展示效果突出。
- Trapezoid shelves forming waterfall-like air-curtain make cabinet's temperature uniform.
  - The Unique technology of trapezoid laminar flow air-curtain and air outlet from back boards ensures average airflow and energy conservation.
  - Vertical cabinets can be easily jointed together with terminal cabinets, very suitable for supermarket.
  - Buckled evaporator fan and pull-out control box are easy to install and repair.
  - Multi-layer shelves with adjustable angle can be combined freely to achieve different demonstration effects.
  - LED lights ensure great display effect.

## 产品型号

## MODEL

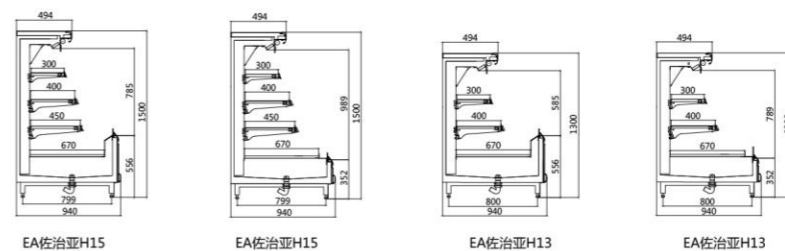

EA佐治亚H15 EA佐治亚H15 EA佐治亚H13 EA佐治亚H13

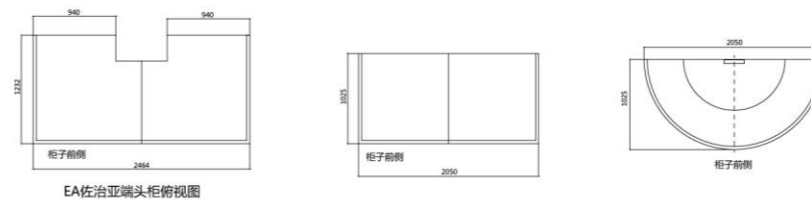

EA佐治亚端头柜俯视图 EA佐治亚端头柜俯视图 柜形前侧 柜形前侧



BZ-EAZZ-F 25 15 5 Y-0 1  
 产品序列号  
 产品系列号: 0为普通系列, E为节能系列  
 保温形式: Y为夜帘  
 前背高度: 5为550mm, 3为350mm  
 柜体高度: 15为1500mm, 13为1300mm  
 柜体长度: 12为1250mm, 18为1875mm, 25为2500mm, 37为3750mm  
 产品类型: F为分体柜  
 产品名称: EA佐治亚  
 运行温度: Z为中温柜  
 产品样式: B为立式柜



BZ-EAZZ-F H 25 15 5-0 1  
 产品序列号  
 产品系列号: 0为普通系列, E为节能系列  
 前背高度: 5为550mm, 3为350mm  
 柜体高度: 15为1500mm, 13为1300mm  
 柜体长度: 24为2464mm, 20为2050mm  
 柜型: 180°方形封头  
 产品类型: F为分体柜  
 产品名称: EA佐治亚  
 运行温度: Z为中温柜  
 产品样式: B为立式柜

## EA佐治亚分体

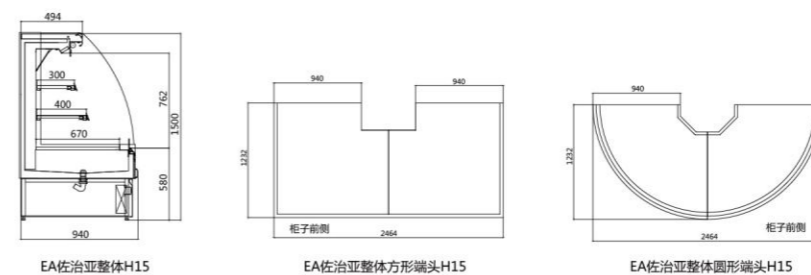

EA佐治亚整体H15 EA佐治亚整体方形端头H15 EA佐治亚整体圆形端头H15

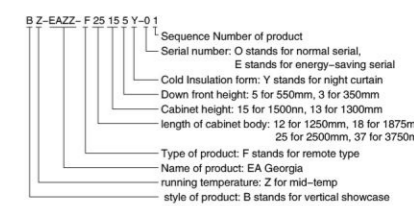

BZ-EAZZ-F 25 15 5 Y-0 1  
 Sequence Number of product  
 Serial number: 0 stands for normal serial, E stands for energy-saving serial  
 Cold insulation form: Y stands for right curtain  
 Down front height: 5 for 550mm, 3 for 350mm  
 Cabinet height: 15 for 1500mm, 13 for 1300mm  
 length of cabinet body: 12 for 1250mm, 18 for 1875mm, 25 for 2500mm, 37 for 3750mm  
 Type of product: F stands for remote type  
 Name of product: EA Georgia  
 running temperature: Z for mid-temp  
 style of product: B stands for vertical showcase

## EA佐治亚整体

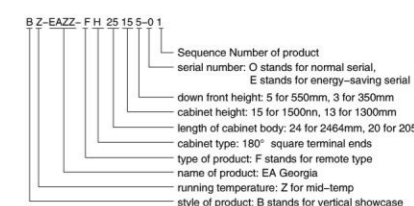

BZ-EAZZ-F H 25 15 5-0 1  
 Sequence Number of product  
 serial number: 0 stands for normal serial, E stands for energy-saving serial  
 down front height: 5 for 550mm, 3 for 350mm  
 cabinet height: 15 for 1500mm, 13 for 1300mm  
 length of cabinet body: 24 for 2464mm, 20 for 2050mm  
 cabinet type: 180° square terminal ends  
 type of product: F stands for remote type  
 name of product: EA Georgia  
 running temperature: Z for mid-temp  
 style of product: B stands for vertical showcase



## E7 / EA亚特兰大/迈阿密

E7/EA ATLANTA / E7/EA MIAMI



### 自动玻璃门

锁住水分更新鲜

### 冷风分流

制冷均匀 消除冷死角

### 多层网板

多层搁板角度调节

### 节能50%

比开口柜更节能

## 产品用途

## PURPOSE

- 运行温度为-1~5℃时，用于展示和销售生鲜、肉类、乳制品及饮料等。
- 运行温度为-18~-22℃时，用于展示和销售各种冷冻食品、冰淇淋、海产品等。
- 长度有1500mm(两门)、2250mm(三门)、3000mm(四门)、3750mm(五门)四种基本规格，可以任意拼接。
- 1~5℃ for fresh foods, fresh meat, milk, beverage and so on.
- 18~-22℃ for frozen foods, ice cream, sea foods, etc.
- 4 basic length specifications: 1550mm(2 doors), 2250mm(3 doors), 3000mm(4 doors) and 3750mm(5 doors). Can be jointed together freely.



## 产品特点

## FEATURES

- 采用冷风分流结构，制冷效果均匀，消除制冷死角。
- 电加热防凝露玻璃门设计，节能降耗。
- 玻璃门自动关闭设计，使用方便。
- 多层网层板自由组合，角度可调，增加展示效果。
- 充分利用卖场空间，与同容积岛柜相比，占地面积少60%。
- 运行成本低，同等情况下，比开口柜节能50%。一次投资，终生受益。
- The shunt structure of cooling air is adopted to achieve uniform cooling effect and to eliminate the cooling dead ends.
- Glass door with electrical heating and anti-condensation reduces power consumption.
- Glass door can close automatically.
- Multi-layer grid shelves can be combined freely with angle adjustable to augment display effects.
- Save 60% space compared to same volume island freezer.
- Save 50% energy compared to open type, Low running cost.invest one-off, benefit lifelong.

## 产品型号

## MODEL

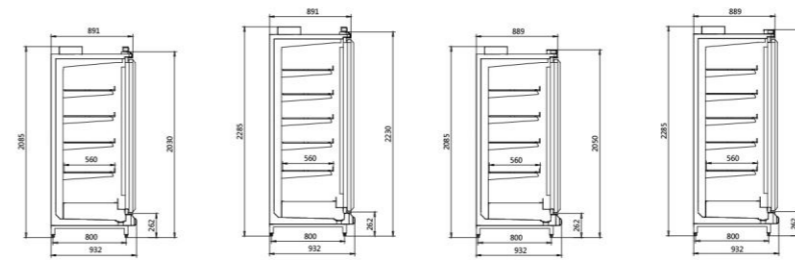

E7 亚特兰大/E7 ATLANTA

EA 亚特兰大/EA ATLANTA

B Z-E7YT-F 15 20-0 1  
 产品序列号  
 产品系列号: 0为普通系列, E为节能系列  
 柜体高度: 20为2030mm, 22为2230mm  
 柜体长度: 15为1500mm, 22为2250mm  
 30为3000mm, 37为3750mm  
 产品类型: F为分体柜  
 产品名称: E7YT为E7亚特兰大,  
 E7MA为E7迈阿密  
 运行温度: Z为中温, D为低温  
 产品样式: B为立式柜

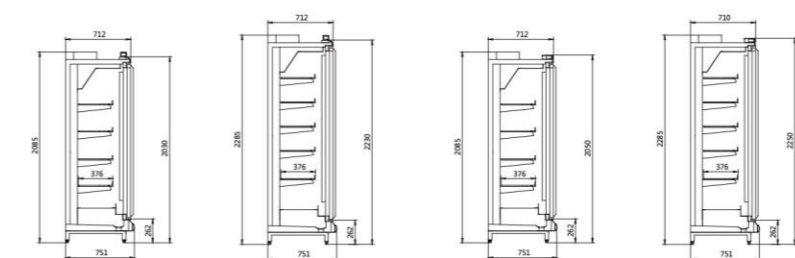

E7 迈阿密/E7 MIAMI

EA 迈阿密/EA MIAMI

B Z-E7YT-F 15 20-0 1  
 Sequence number of product  
 Serial number: 0 is normal serial;  
 E is energy-saving serial  
 Height of cabinet body: 20 is 2030mm; 22 is 2230mm  
 Length of cabinet body: 15 is 1550mm; 22 is 2250mm;  
 30 is 3000mm; 37 is 3750mm  
 Type of product: F is remote  
 Name of product: E7YT for E7 ATLANTA;  
 E7MA for E7 MIAMI  
 Running temperature: Z is mid-temp; D is low temp  
 Style of product: B is multi-deck showcase



# 密苏里

MISSOURI



### 容积超大

满足大量储存

### 节能省电

能耗降低20%

### 智能高效

高效水冷换热器

### 提高寿命

阻尼门铰链设计

## 产品用途

## PURPOSE

- 温度范围：L1 (≤ -18℃)，用于展示和销售各种冷冻食品、冰激凌、海产品等。
- 柜型为分体玻璃门冷冻柜，长度有1660mm(四门)、2410mm(六门)和3160mm(八门)三种规格。
- Temperature range: L1 (≤ -18℃) is used for displaying and selling all kinds frozen foods, ice cream and seafoods etc.
- The cabinet is a remote type with glass doors, in lengths of 1660mm(four doors), 2410mm(six doors) and 3160mm(eight doors).



## 产品特点

## FEATURES

- 超大容积，满足大量储存与高周转率的需求，专为互联网新零售开发。
- 配备新型双层节能门框，能耗降低20%；可选双路自动加热控制器，降低加热器工作时间，可节能50%以上。
- 上下双层玻璃门设计，配置有系统分隔板，有效减少冷气外漏，降低因频繁开关门引起的能耗增加。
- 选配高效水冷换热器，适应不同水质，确保换热效果。
- 阻尼门铰链设计，减小玻璃门关闭时的冲击力，提高设备使用寿命。
- Huge volume meets the needs of large container and frequent storage, and it is specially developed for Internet new retail;
- Equipped with new double-layer energy-saving door frame, it can reduce 20% energy consumption; Optional dual automatic heating controller cut down the heater working time, saving more than 50% energy;
- The double glass doors designed and equipped with systematic partitions can effectively reduce the leakage of cold air, decreasing the increase of energy consumption caused by frequent opening and closing;
- High efficiency water cooling exchanger is selected to adapt to different water quality and ensure heat exchange effect;
- Damped hinged door cut down on the impact force when the glass door is closed, improving the service life of the equipment.

## 产品型号

## MODEL

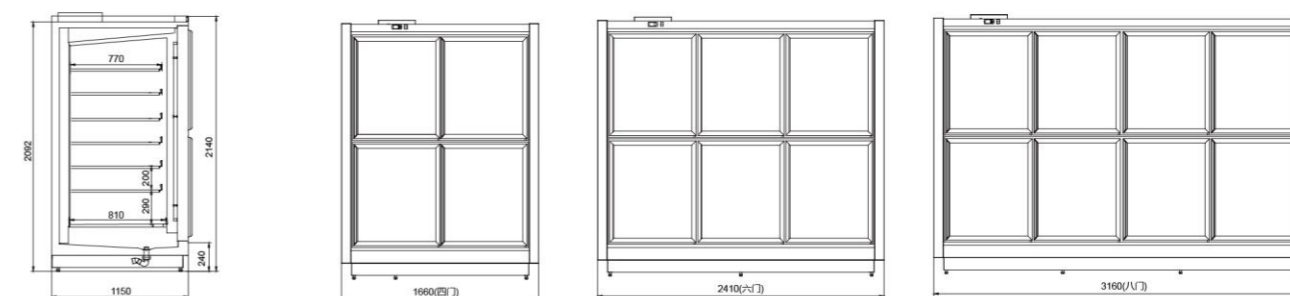

**B D - MS - F 16 21 - 01**

- 产品序列号
- 产品高度：21为2140mm
- 柜体长度：16为1660mm(四门)；24为2410mm(六门)；31为3160mm(八门)
- 产品类型：F为分体柜
- 产品名称：MS为密苏里
- 运行温度：D为低温
- 产品样式：B为立式柜

**B D - MS - F 16 21 - 01**

- Sequence Number of product
- Height of cabinet body: 21 is 2140mm
- length of cabinet body: 16 stands for 1660mm(four doors), 24 stands for 2410mm(six doors), 31 stands for 3160mm(eight doors)
- Product type: F stands for remote type
- Product name: MS stands for MISSOURI
- Running temperature: D stands for subzero
- Product pattern: B stands for vertical showcase



## E7 圣保罗

E7 ST.PAWL



### 占地空间小

占地少更节能

### 电热玻璃门

自锁结构更方便

### 多层网板

展示样式多 面积大

### 节能低耗

门式结构更节能

## 产品用途

## PURPOSE

- 运行温度为L1 ( $\leq -15^{\circ}\text{C}$ )，用于展示和销售各种冷冻食品、冰淇淋、海产品等。
- 长度有1250mm(两门)、1875mm(三门)、2200mm(三门)、2500mm(四门)、3750mm(六门)五种基本规格，可以任意拼接。
- $\leq -18^{\circ}\text{C}$  for frozen foods, ice cream, sea foods, etc.
- 5 basic length specifications: 1250mm (2 doors), 1875mm (3 doors), 2250mm (3 doors), 2500mm(4 doors) and 3750mm (6 doors). Can be jointed together freely.



## 产品特点

## FEATURES

- 充分利用卖场空间，比一般冷冻柜占地少50%。
- 运行成本低，比开口岛柜节能50%，一次投资终生受益。
- 电加热防凝露玻璃门设计，玻璃门自动关闭，自锁结构设计，使用方便。
- 多层网层板自由组合，可以满足商品不同展示效果。
- 顶部可选灯座板或装饰板结构，满足客户的不同需要。
- 可选LED灯，节能展示效果好。
- 可选夜帘或岛式推拉门结构，节能降耗。
- Save 50% space compared with normal freezer, make full use of store space.
- Save 50% energy compared with open type. Low running cost, invest one-off, benefit lifelong.
- Electrical heating anti-condensation glass door with auto-closed and auto-locked design is convenient to use.
- Multi-layer grid shelves combined freely can satisfy different display effects.
- Top with lamp holder or decorative sheet satisfy different customers demands.
- With LED light, good energy-saving and display effect.
- Night fibre curtain or top sliding door is optional for energy-saving.

## 产品型号

## MODEL

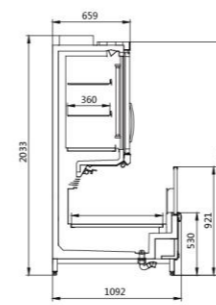

E7圣保罗子母柜

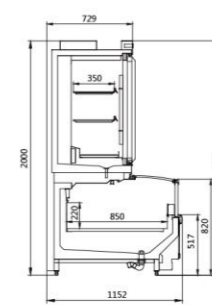
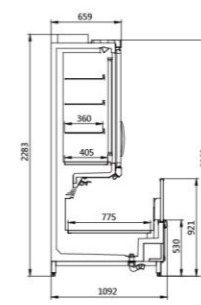

E8圣保罗子母柜

B D-E7SP-F 25 20 5 Y-0 1

产品序列号  
 产品系列号: 0为普通系列, E为节能系列  
 保温形式: Y为夜帘, T为推拉门  
 前罩高度: 5为530mm  
 柜体高度: 20为2030mm, 23为2280mm  
 柜体长度: 12为1250mm, 18为1875mm, 22为2200mm, 25为2500mm, 37为3750mm  
 产品类型: F为分体柜  
 产品名称: E7SP为E7圣保罗  
 运行温度: D为低温柜  
 产品样式: B为立式柜

B D-E7SP-F 25 20 5 Y-0 1

Sequence number of product  
 Serial number: 0 is normal serial; E is energy-saving serial  
 Y is night curtain; T is sliding door  
 Height of front edge: 5 is 530mm  
 Height of cabinet body: 20 is 2030mm; 23 is 2280mm  
 Length of cabinet body: 12 is 1250mm; 18 is 1875mm; 22 is 2200mm; 25 is 2500mm; 37 is 3750mm  
 Type of product: F is remote  
 Name of product: E7SP for E7 ST.PAWL  
 Running temperature: D is low temp  
 Style of product: B is multi-deck showcase





## E7 奥斯汀

E7 AUSTIN



### 冷冻/冷藏

满足不同使用需求

### 静电防锈

零部件更持久耐用

### 制冷均匀

超薄大面积蒸发器

### 绿色环保

新型环保发泡工艺

### 产品用途

### PURPOSE

- 底部冷冻部分运行温度为 $\leq -18^{\circ}\text{C}$ ，用于展示和销售各种肉制品、海产品、冰淇淋、速冻水饺等冷藏食品等。
- $\leq -18^{\circ}\text{C}$  of bottom cabinet for frozen foods, ice cream, sea foods, etc.
- 顶部冷藏部分运行温度 $-1 \sim 7^{\circ}\text{C}$ ，用于展示和销售各种饮料、奶制品、真空包装熟食等。
- $-1 \sim 7^{\circ}\text{C}$  of top cabinet for beverage, milk and cooked food.
- 柜子为分体柜，柜长有1875mm,2500mm,3750mm三种长度。根据客户卖场需求随意拼接。
- 3 basic length specifications: 1875mm, 2500mm and 3750mm. Can be jointed together freely to suit your length requirements.



### 产品特点

### FEATURES

- 冷冻冷藏两种柜型集一身，实现不同使用需求。
- 冷冻部分加热反射玻璃推拉门，减少冷量消耗，降低能耗。
- 超薄大面积蒸发器，降温快，有效容积大。
- 零部件进行静电喷涂防腐防锈处理。
- 新型绿色环保聚氨酯整体发泡工艺，保温性能好。
- Integration cooling and frozen two types of cabinets in one achieve different use requirements. Large Effective volume.
- Anti-reflective sliding glass-door for bottom freezer can reduce cooling consumption and save energy.
- Ultra-thin and large area high-efficient evaporator rapidly cool fast.
- Spare parts with anti-corrosion anti-rust treatment.
- New green environment-friendly polyurethane foaming process with good insulation performance.

### 产品型号

### MODEL

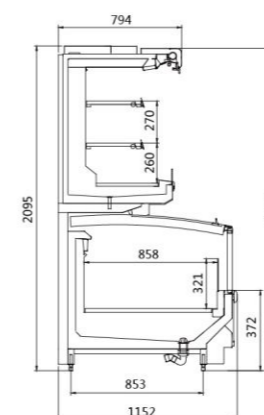

奥斯汀 上冷藏下冷冻

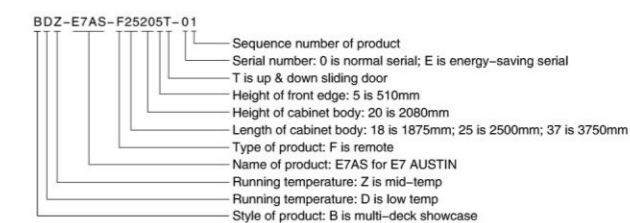



## E7 优瑞克

E7 EURAKA



### 风幕均匀

独特梯形层流出风

### 制冷提鲜

锁住水分更新鲜

### 展示极佳

开口展示面更大

### 易清洁保养

可扣接式座板结构

### 产品用途

### PURPOSE

- 该柜型的温度等级：3H（1~10℃），用于展示和销售各种水果、蔬菜等食品。
- 该柜型为分体柜，长度有：1250mm，1875mm，2500mm，3750mm四种规格，可以任意拼接。
- 3H(1~10℃) for fruits and vegetables, etc.
- 4 basic length specifications: 1250mm, 1875mm, 2500mm and 3750mm.
- Can be jointed together freely to suit your length requirements.



### 产品特点

### FEATURES

- 外观豪华气派，前沿高度低，开口展示面积大，能最大限度的增加食品的展示效果。
- 容积大，占地面积小。
- 采用独特的梯形层流风幕设计和背板出风技术，梯度出风均匀，有效降低陈列柜能耗。
- 该产品制冷快，温度均匀，提高了食品的保鲜品质。
- 设计有可扣接式蒸发风机座板结构，控制器置顶，方便安装、操作、维修及维护清洗保养。
- 采用框篮和倾斜隔板结构，适合水果、蔬菜的放置和展示。
- 顶部采用双排灯设计，增加柜内亮度，展示效果好。
- Luxury out-looking low front with big display area provide the best display effect.
- Big Volume and small floor space.
- Unique technology of trapezoid laminar flow air curtain and air outlet from back board ensure the air flow evenly and energy-conservation.
- Fast cooling and even temperature improve the quality of food preservation.
- The design of the buckle structure of evaporating fan holder and the controller ceiling-mounted is easy for installation, operation, daily maintenance and after-sales service.
- Basket and inclined partition board is suitable for placing and displaying fruit and vegetable.
- Double row of top lights augment the brightness and better display effect.

### 产品型号

### MODEL

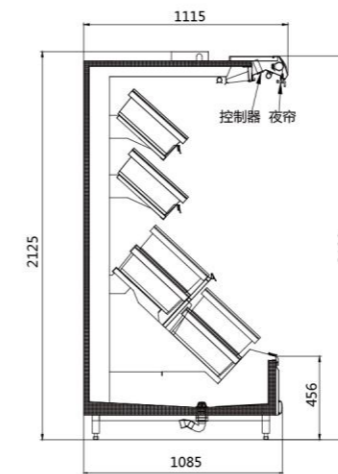

E7优瑞克蔬果柜

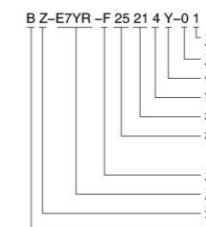

产品序列号  
 产品系列号：0为普通系列，E为节能系列  
 保温型式：Y为夜帘  
 前言高度：4为450mm  
 柜体高度：21为2100mm  
 柜体长度：12为1250mm,18为1875mm  
 25为2500mm,37为3750mm  
 产品类型：F为分体柜  
 产品名称：E7YR为E7优瑞克  
 运行温度：Z为中温  
 产品样式：B为立式柜

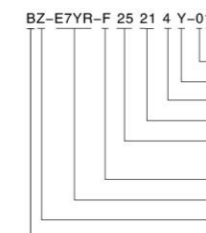

Sequence number of product  
 Serial number: 0 is normal serial; E is energy-saving serial  
 Y is night curtain  
 Height of front edge: 4 is 450mm  
 Height of cabinet body: 21 is 2100mm  
 Length of cabinet body: 12 is 1250mm; 18 is 1870mm;  
 25 is 2500mm; 37 is 3750mm  
 Type of product: F is remote  
 Name of product: E7YR for E7 EUREKA  
 Running temperature: Z is mid-temp  
 Style of product: B is multi-deck showcase



# 西西里

SICILY



### 容积超大

满足大量储存

### 温度均匀

有效降低能耗

### 方便使用

搭配移动推车

### 外观美观

适合仓储超市

## 产品用途

## PURPOSE

- 温度范围：H（1~10℃）用于仓储展示和销售各种水果、蔬菜、奶制品等食品。
- 该柜型为分体柜，长度有：1250mm，1875mm和2500mm三种规格，满足市场不同需求。
- Temperature range: H(1~10℃) is used for displaying and selling all kinds fruits, vegetable and dairy products etc.
- The cabinet is a remote type, with lengths of 1250,1875mm and 2500mm to meet different store.



## 产品特点

## FEATURES

- 适合大容量展示和销售，存储货物能力强。
- 前沿可掀式设计，搭配仓储移动推车，方便日常大量补货取货。
- 多层搁板角度可调，可根据根据卖场要求调节不同的展示效果。
- 采用独特的风幕设计和背板出风技术，温度均匀，有效降低陈列柜能耗。
- 统一外观设计，卖场效果美观大方，适合仓储超市、后置仓统一布局。
- 多种长度可选，满足卖场布局要求。
- Good storage capacity is suitable for big volume display and sales;
- The design of liftable down edge combined with movable storage cart is convenient daily bulk replenishment goods;
- Shelf layers can be adjusted the angle according to the requirements of different display effect;
- Unique technology of air curtain and air outlet from back board ensures the air flow evenly and energy-conservation;
- Uniform appearance can enhance shops' beauty;
- Many lengths can be selected to meet the requirements of store layout.

## 产品型号

## MODEL

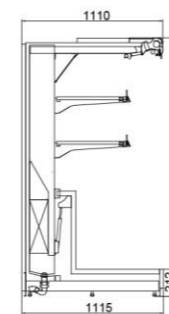

西西里

B Z-XX-F 25 20 2 Y-0 1

产品系列号  
产品系列号：0为普通系列，E为节能系列  
保温型式：Y为夜帘  
前沿高度：2为212mm  
柜体高度：20为2030mm  
柜体长度：12为1250mm，18为1875mm，25为2500mm  
产品类型：F为分体  
产品名称：西西里  
运行温度：Z为中温  
产品样式：B为立式柜

B Z-XX-F 25 20 2 Y-0 1

Serial number: 0 stands for normal serial, E stands for energy-saving serial  
Insulation form: Y stands for night curtain  
Front edge: 2 stands for 212mm  
Height of cabinet body: 20 stands for 2030mm  
Length of cabinet body: 12 is 1250mm for short, 18 is 1875mm for short, 25 is 2500mm for short  
Product type: F stands for remote type  
Product name: XX for SICILY  
Running temperature: Z is medium temperature  
Product style: B stands for vertical cabinet



# 岛式 冷冻展示柜

REMOTE ISLAND SELF SERVICE  
FROZEN & REFRIGERATED MERCHANDISER

- 29 E7夏威夷/华盛顿  
E7 HAWAII / E7 WASHINGTON
- 31 E7印第安纳  
E7 INDIANA
- 33 E7加利福尼亚  
E7 CALIFORNIA
- 35 悉尼  
SYDNEY
- 37 悉尼子母柜  
SYDNEY
- 38 悉尼双面组合岛柜  
SYDNEY



## E7 夏威夷/华盛顿

E7 HAWAII / E7 WASHINGTON

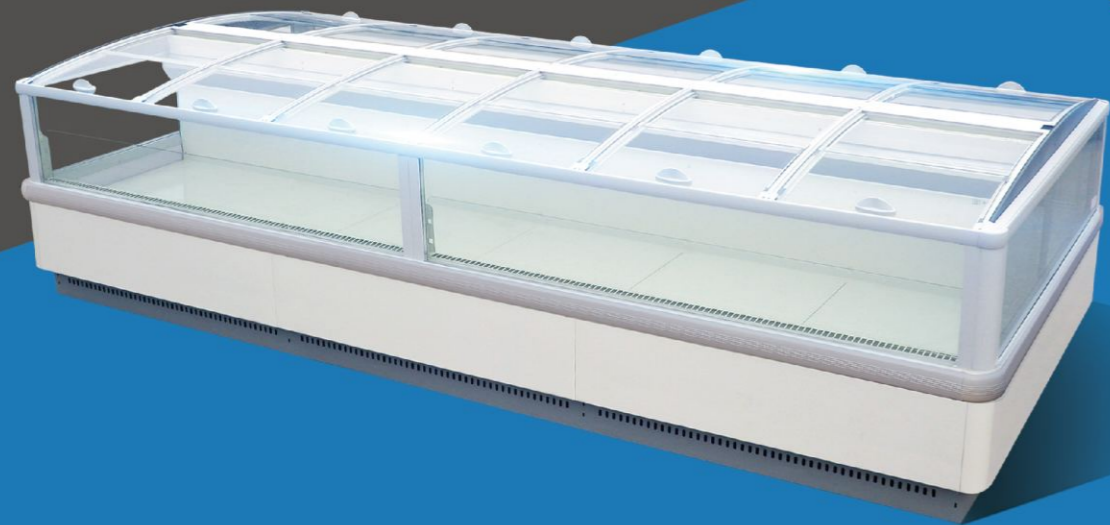

**制冷迅速**

锁住水分更新鲜

**制冷均匀**

非对称层流风幕

**防锈防氧化**

静电喷涂防氧化

**能效比高**

进口热力膨胀阀

### 产品用途

### PURPOSE

- 运行温度为-18~-22℃时，用于展示和销售各种冷冻食品、冰淇淋、海产品等。
- 长度有1875mm、2500mm、3750mm三种基本规格，可以任意拼接，可选配封头柜。
- 18~-22℃ for frozen foods, ice cream, sea foods, etc.
- 3 basic length specifications: 1875mm, 2500mm and 3750mm. Can be jointed together freely to suit your length requirements. Terminal cabinet is available.



### 产品特点

### FEATURES

- 采用非对称层流风幕结构，制冷效果均匀，彻底解决了霜堵问题。
- 采用高效蒸发器和进口热力膨胀阀，减少除霜时间，降低能耗。
- 零部件进行防腐防锈处理，铝合金采用磨砂氧化处理，外观件采用静电喷涂处理。
- 可选配夜帘、夜盖或玻璃推拉门，节能降耗，保证展示食品卫生。
- 可选配非冷货架，实现商品关联陈列，优化卖场环境，促进展品销售。
- 可配备电脑远程监控系统，对产品运行情况进行实时监控。
- Asymmetric laminar flow air curtain effects the cooling evenly and thoroughly solve the problem of frost-blocking.
- High efficiency evaporator and imported expansion valve are used to cut down the defrost time and save energy.
- Spare parts for anti-corrosion anti-rust treatment, aluminum alloy with matte oxidation treatment, exterior appearance parts in electrostatic spraying treatment.
- Night fibre curtain, night cover or top sliding door are optional to help in energy-saving and cost-reducing and general hygiene of commodity.
- Optional non-cooling storage rack can be mounted on top of the freezer for correlated non-refrigerated product selling.
- Optional computer remote monitoring system can monitor the running of all commodities.

### 产品型号

### MODEL

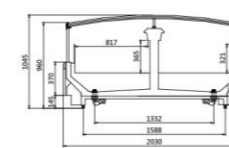

E7 华盛顿三推拉门柜

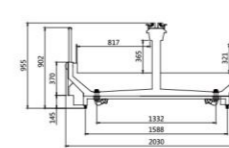

E7 华盛顿夜帘柜

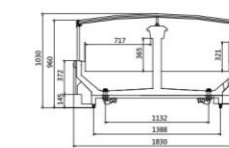

E7 夏威夷三推拉门柜

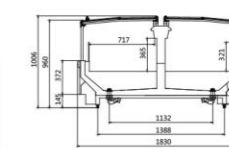

E7 夏威夷四推拉门柜

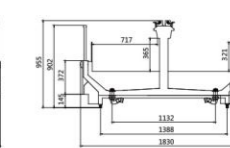

E7 夏威夷夜帘柜

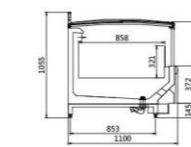

E7 华盛顿封头推拉门柜

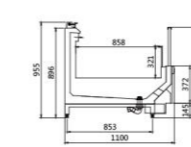

E7 华盛顿封头夜帘柜

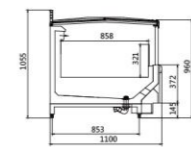

E7 夏威夷封头推拉门柜

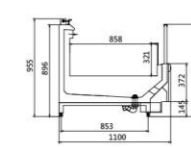

E7 夏威夷封头夜帘柜

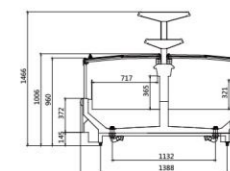

E7 夏威夷四推拉门柜加双层货架

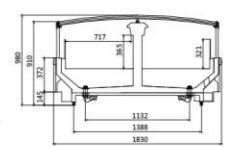
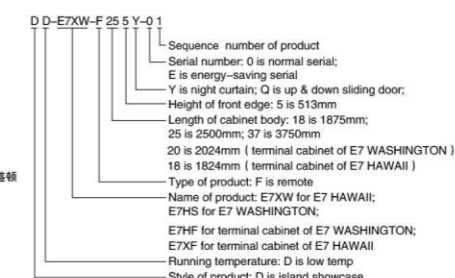
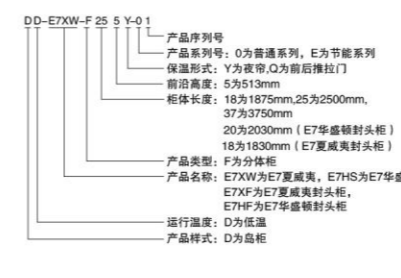

EA 夏威夷三推拉门柜

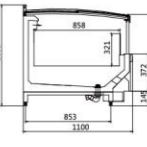

EA 夏威夷封头推拉门柜



## E7 印第安纳

E7 INDIANA



制冷迅速

非对称层流风幕技术

节能省电

高效蒸发器

防锈抗氧化

零部件更持久耐用

智能控制

可配备电脑远程监控

### 产品特点

### FEATURES

- 采用非对称层流风幕结构，制冷效果均匀，彻底解决了霜堵问题。
  - 采用高效蒸发器和进口热力膨胀阀，减少除霜时间，降低能耗。
  - 零部件进行防腐防锈处理，铝合金采用磨砂氧化处理，外观件采用静电喷涂处理。
  - 可选配夜帘、夜盖或玻璃推拉门，节能降耗，保证展示食品卫生。
  - 可选配非冷货架，实现商品关联陈列，优化卖场环境，促进展品销售。
  - 可配备电脑远程监控系统，对产品运行情况进行实时监控。
- Asymmetric laminar flow air curtain effects the cooling evenly and thoroughly solve the problem of frost-blocking.
  - High efficiency evaporator and imported expansion valve are used to cut down the defrost time and save energy.
  - Spare parts for anti-corrosion anti-rust treatment, aluminum alloy with matte oxidation treatment, exterior appearance parts in electrostatic spraying treatment.
  - Night fibre curtain, night cover or top sliding door are optional to help in energy-saving and cost-reducing and general hygiene of commodity.
  - Optional non-cooling storage rack can be mounted on top of the freezer for correlated non-refrigerated product selling.
  - Optional computer remote monitoring system can monitor the running of all commodities.

### 产品型号

### MODEL

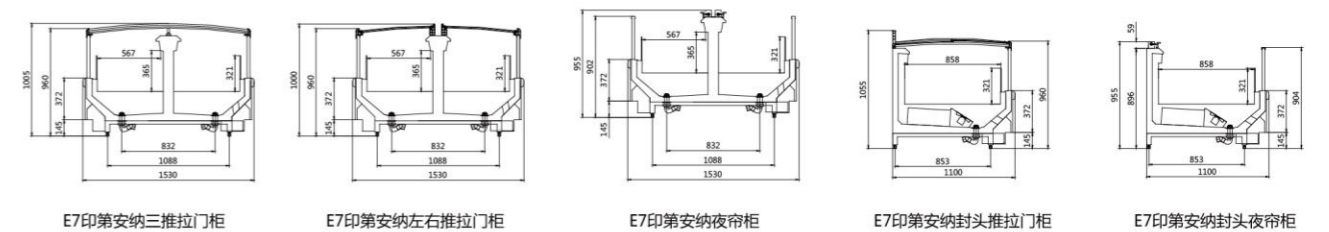

E7印第安纳三推拉门柜

E7印第安纳左右推拉门柜

E7印第安纳夜帘柜

E7印第安纳封头推拉门柜

E7印第安纳封头夜帘柜

### 产品用途

### PURPOSE

- 运行温度为-18~-22℃时，用于展示和销售各种冷冻食品、冰淇淋、海产品等。
- 长度有1875mm、2500mm、3750mm三种基本规格，可以任意拼接，可选配封头柜。
- -18~-22℃ for frozen foods, ice cream, sea foods, etc.
- 3 basic length specifications: 1875mm, 2500mm and 3750mm. Can be jointed together freely to suit your length requirements. Terminal cabinet is available.

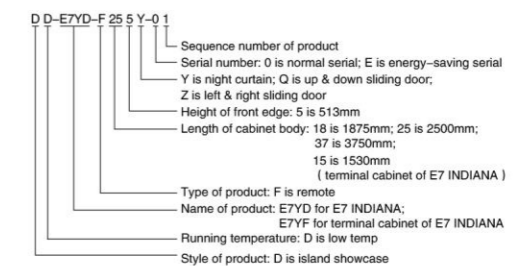
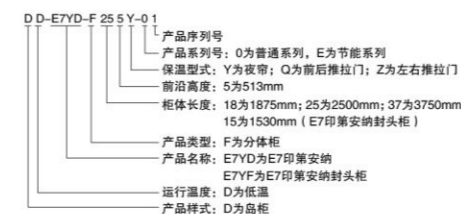



## E7 加利福尼亚

E7 CALIFORNIA



### 节能省电

热力膨胀阀

### 静音运行

能耗低部件精密

### 防锈防氧化

静电喷涂防氧化

### 智能控制

可配备电脑远程监控

## 产品用途

## PURPOSE

- 运行温度为-18~-22℃时，用于展示和销售各种冷冻食品、冰淇淋、海产品等。
- 长度有1875mm、2500mm、3750mm三种基本规格，可以任意拼接，背靠背使用时，配有封头柜。
- 18~-22℃ for frozen foods, ice cream, sea foods, etc.
- 3 basic length specifications: 1875mm, 2500mm and 3750mm, Can be jointed together to suit your length requirements. Terminal cabinet is available.



## 产品特点

## FEATURES

- 采用非对称层流风幕结构，制冷效果均匀，降低耗冷量。
- 采用高效蒸发器和进口热力膨胀阀，减少除霜时间，降低能耗。
- 零部件全部进行防腐防锈处理，铝合金采用磨砂氧化处理，外观件采用静电喷涂处理。
- 配置夜盖、夜帘或推拉门结构，节能降耗，保证展示食品卫生。
- 可配备电脑远程监控系统，对产品运行情况进行实时监控。
- Asymmetric laminar flow air curtain effects the cooling evenly and reduce cooling amount.
- High efficiency evaporator and imported expansion valve are used to cut down the defrost time and save energy.
- Spare parts for anti-corrosion anti-rust treatment, aluminum alloy with matte oxidation treatment, exterior appearance parts in electrostatic spraying treatment.
- Night fibre curtain, night cover or top sliding door are optional to help in energy-saving and cost-reducing and general hygiene of commodity.
- Optional computer remote monitoring system can monitor the running of all commodities.

## 产品型号

## MODEL

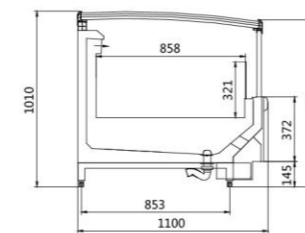

E7 加利福尼亚推拉门柜

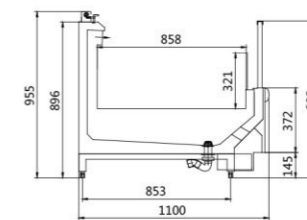

E7 加利福尼亚夜帘柜

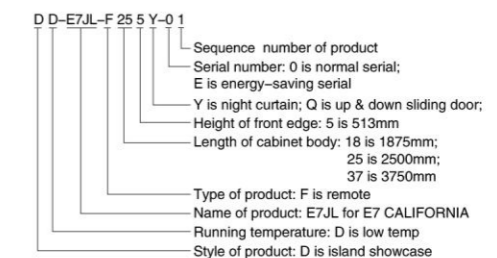



# 悉尼 SYDNEY



## 产品特点

## FEATURES

- 双制冷方式，降温速度快，制冷效果好。
  - 恒温除霜设计，保证食品品质。
  - 模块化设计，积木式拼装，自由组合，满足卖场需要。
  - 标配LED照明灯设计，超大展示面积，展示效果突出。
  - 采用R290新型环保冷媒，践行绿色发展理念。
  - 即插即用设计，使用方便快捷。
  - 可选配非冷货架，进行商品关联陈列。
- Double cooling mold makes cooling rate faster and effect better.
  - Defrosting in constant temperature ensures the quality of the storage foods.
  - Modular design can achieve joint freely to meet different sizes of stores.
  - LED lights used in freezer make foods in good luster.
  - Adopting R290 new refrigerant follows the concept of go green.
  - No need installation make use more convenient.
  - It can be put together with goods shelves to display pertinent goods.

## 产品型号

## MODEL

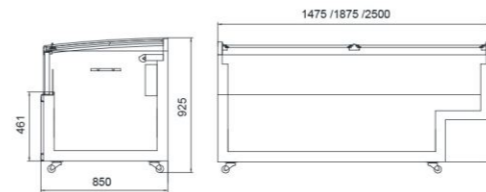

直柜/Direct Cabinet

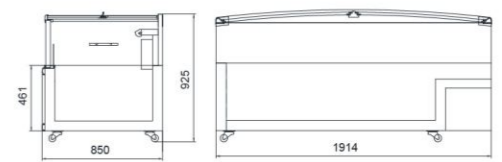

封头柜/Terminal Cabinet

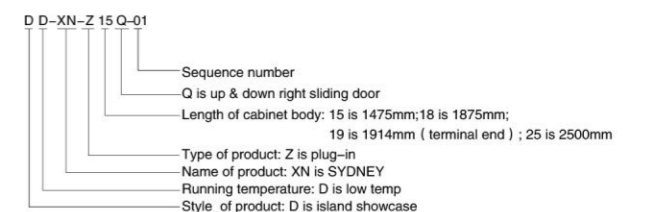

### 自由组合

模块积木式拼装

### 恒温除霜

保证食品品质

### R290冷媒

践行绿色发展理念

### 美观大方

LED灯 展示面积大

## 产品用途

## PURPOSE

- 运行温度为L1 ( $\leq -15^{\circ}\text{C}$ )，用于展示和销售各种肉制品、海产品、冰淇淋、速冻水饺等冷冻食品。
- 运行温度为L1 ( $\leq -15^{\circ}\text{C}$ ) for meat, seafood, ice cream and frozen dumpling, etc.
- 柜子为整体柜，柜长有1475mm，1875mm，2500mm和1914mm（封头柜）四种长度，可根据卖场布局灵活组合。
- Plug-in type, 4 basic length specifications: 1475mm, 1875mm, 2500mm and 1914mm (terminal type), can be jointed flexibly according to store layout.





# 悉尼 SYDNEY

## 悉尼子母柜

### 产品用途

### PURPOSE

- 温度范围: L1 ( $\leq -15^{\circ}\text{C}$ ), 用于展示和销售各种冷冻食品、冰激凌、海产品等。
- 柜型为整体柜, 长度有1875mm和2500mm两种规格。
- Temperature range: L1 ( $\leq 15^{\circ}\text{C}$ ) is used for displaying and selling all kinds frozen foods, ice cream and seafoods etc.
- The cabinet is a plug-in type with lengths of 1875mm and 2500mm.

### 产品特点

### FEATURES

- 采用上下冷冻组合柜设计, 充分利用卖场的展示空间。
- 即插即用型设计, 无需现场制冷管路安装, 使用方便。
- 分离式柜体设计, 方便日常检修和维护。
- 上部选用外挂式无边框玻璃门, 外观大气美观, 展示效果好。
- 隐藏式肩膀设计, 任意拼接组合时, 提升卖场档次。
- The integration of up-down two cabinets makes full use of store space to enlarge displaying areas;
- Plug-and-work type is convenient to use without pipe installation on site;
- Two separated cabinets are easy for daily check and maintenance;
- The upper part of the external hanging glass door without frame shows beautiful appearance and good display effect.;
- Hidden side wall make the cabinet joint freely to improve stores' grade.



### 产品型号

### MODEL

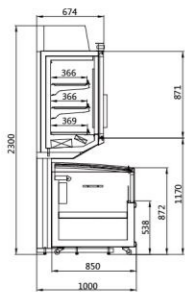

悉尼子母柜

BD-3XN-Z 18 23 5 S -0 1

产品改进序列号  
产品系列号: 0为普通系列  
保温形式: S为手拉手  
前沿高度: 538mm  
柜体高度: 2300mm  
柜体长度: 18为1875mm, 25为2500mm  
产品类型: Z为整体  
产品名称: 悉尼子母柜  
运行温度: D为低温  
产品样式: B为壁柜

BD-3XN-Z 18 23 5 S -01

Serial number  
0 stands for normal serial, E stands for energy-saving serial  
Insulation form: S stands for sliding door  
Height of cabinet body: 538mm  
Length of cabinet body: 18 is 1875mm, 25 is 2500mm  
Product type: Z stands for plug-in type  
Product name: SYDNEY  
Running temperature: D stands for subzero  
Product style: B stands for vertical cabinet



## 悉尼双面组合岛柜

### 产品用途

### PURPOSE

- 温度范围: L1 ( $\leq -15^{\circ}\text{C}$ ), 用于展示和销售各种冷冻食品、冰激凌、海产品等。
- 柜型为整体柜, 长度有1875mm和2500mm两种规格。
- Temperature range: L1 ( $\leq 15^{\circ}\text{C}$ ) is used for displaying and selling all kinds frozen foods, ice cream and seafoods etc.
- The cabinet is a plug-in type with lengths of 1875mm and 2500mm.

### 产品特点

### FEATURES

- 采用R290制冷剂, 翅片式蒸发器直冷技术, 高效环保
- 双面一体式设计, 占地面积少, 充分利用卖场空间
- 采用三推拉门设计, 开口面尺寸大, 方便顾客取放商品
- 超大展示玻璃, 透视面积大, 展示效果好
- 机组和控制盒维护方便, 打开装饰板即可
- 可选变频制冷系统, 静音运行, 节能降耗
- R290 combined with straight cold by finned evaporator ensure the freezer high efficiency and environmental friendly ;
- Two-sided integral design makes full use of floor space;
- Three overlapping sliding doors guarantee big opening, convenient for access for goods;
- Large glasses make displaying better due to large perspective areas;
- It is easy to maintain compressor unit and controller box, only need to open the decorative plate.
- Optional frequency conversion refrigeration system--mute operation saves energy.

### 产品型号

### MODEL

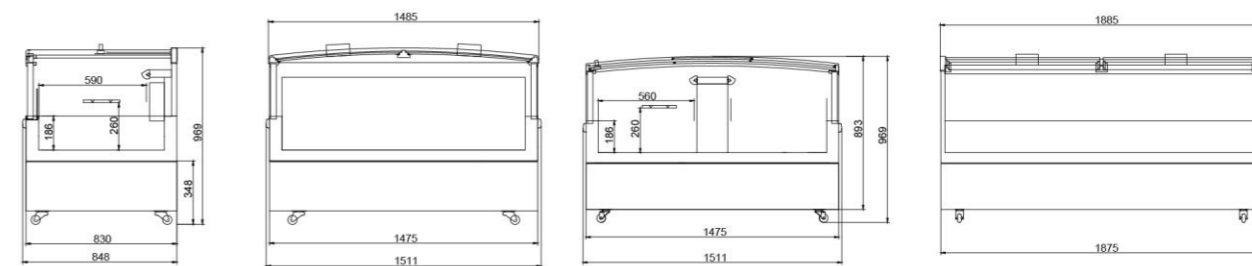

双面悉尼岛柜封头柜

双面悉尼岛柜直柜

D D- 2XN-Z15 Q-01

产品序列号  
保温形式: Q为前后推拉门  
柜体长度: 18为1875mm; 25为2500mm (直柜)  
15为1511mm (封头柜)  
产品类型: Z为整体柜  
产品名称: 2XN为悉尼双面组合岛柜  
运行温度: D为低温  
产品样式: D为岛柜

D D- 2XN-Z15 Q-01

Sequence Number of product  
Insulation form: Q stands for sliding door  
Length of cabinet body: 18 is 1875mm, 25 is 2500mm, 15 is 1511mm (terminal end),  
Type of product: Z stands for plug-in type  
Product name: 2XN stands for two-sided joint freezer  
Running temperature: D stands for subzero  
Product pattern: D stands for island freezer

# 柜台式 展示柜

REMOTE & SELF-CONTAINED  
COUNTER TYPE MERCHANDISER

- 41 E6阿拉斯加(冷柜)  
E6 ALASKA (REFRIGERATOR)

---

- 43 E7维多利亚  
E7 VICTORIA

---

- 45 E7匹兹堡  
E7 PITTSBURGH

---

- 47 E7加利鲜肉柜  
E7 CARY

---

- 49 孟菲斯熟食柜  
MEMPHIS DELI SHOWCASE

---

- 51 EA波尔多/圣菲  
EA BORDEAUX SANTA FE

---

- 53 双面熟食柜  
TWO-SIDE DELI SHOWCASE

---

- 55 E6阿拉斯加(干热柜)/E6波士顿(湿热柜)  
E6 ALASKA(DRY HEAT)  
E6 BOSTON(MOIST HEAT)



## E6 阿拉斯加(冷柜)

E6 ALASKA(REFRIGERATOR)



三款可选

圆弧/平口/前推

制冷更佳

三层均风无霜堵

展示性好

开口展示面更大

实时监控

可配备远程监控

### 产品用途

PURPOSE

- 运行温度为3M1(-1~5℃)，用于展示和销售各种肉类、熟食、乳品及冷饮等食品。
- 有整体式和分体式两种型式，长度有1250mm、1875mm、2500mm和3750mm四种基本规格，可以任意拼接，可选配90°拐角柜。
- 3M1(-1~5℃) for all kinds of meat, cooked foods, milk, cold drink, etc.
- 2 types: Remote and Self-contained, in 4 basic length specifications: 1250mm, 1875mm, 2500mm and 3750mm, Can be jointed freely, optionally choose 90 degree angle corner cabinet.



### 产品特点

FEATURES

- 有圆弧型可掀盖式、平口型和前推拉玻璃三种外观型式，满足不同使用需求。
- 三层均风设计，风幕更优化，制冷效果更佳，彻底解决霜堵问题。
- 大圆弧钢化玻璃，抗冲击力强，展示效果佳。
- 独有台阶式推拉门、电子秤专用插座等，人本设计，方便使用。
- 分体柜可配备电脑远程监控系统，对产品运行情况进行实时监控。
- Available in 3 types: round arc liftable glass, flat without cover, front slide glass door, can satisfy different use requirement.
- 3-layer uniform air flow design, air curtain more optimum, cooling effect more perfect, thoroughly solve the frost-blocking problem.
- Large arc tempered glass is used, strong anti-impact and better display.
- The unique stepped sliding door and socket of electronic scale, Human Oriented Design, convenient to use.
- Optional computer remote monitoring system can real-time monitor the running of the freezers.

### 产品型号

MODEL

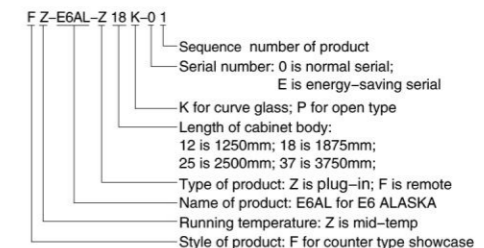
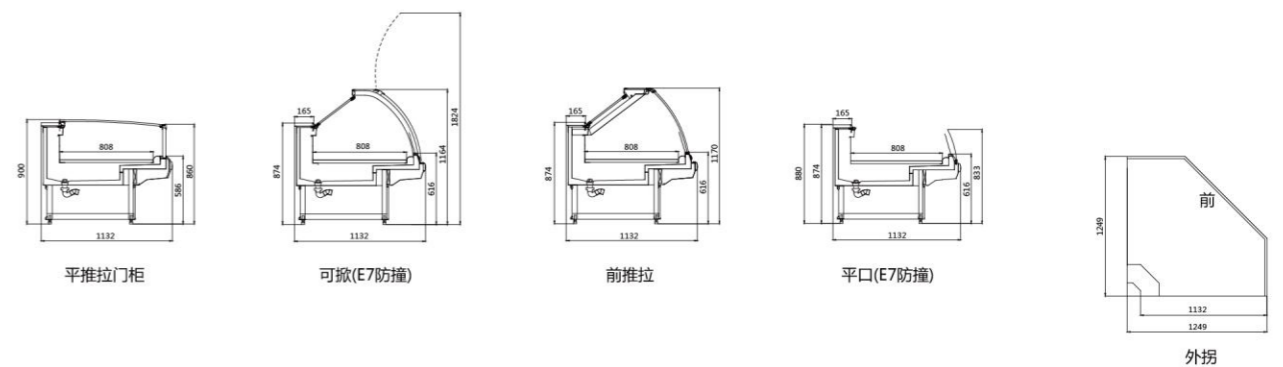



## E7 维多利亚

E7 VICTORIA

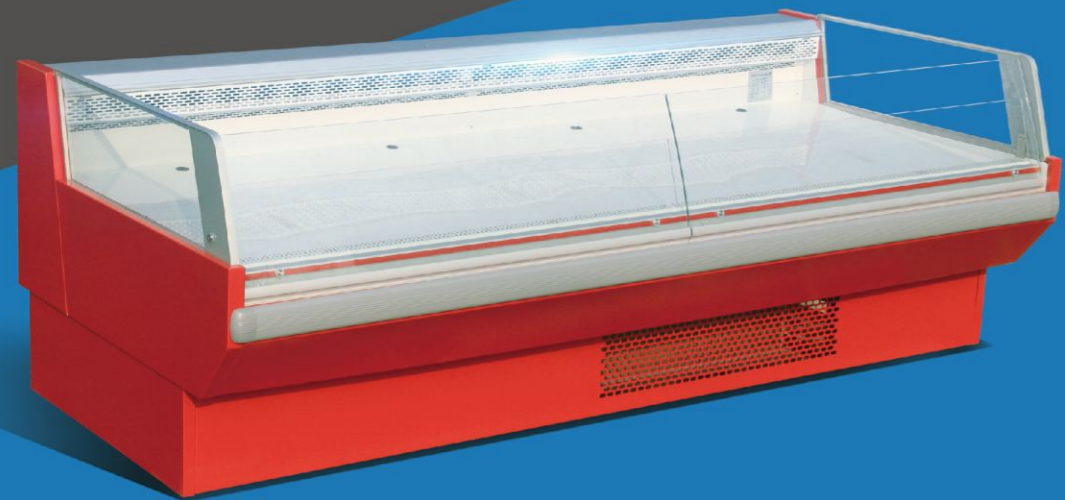

便捷补取

前后部均可推拉

多种操控

照明制冷防凝露分控制

微电脑控温

多方面控制调节

能效比高

风幕均匀稳定

### 产品用途

### PURPOSE

- 运行温度为3M1 (-1 ~ 5℃) 时, 用于展示和销售各种熟食、鲜肉、真空包装食品等冷藏食品。
- 长度有1875mm、2500mm、3750mm三种基本规格, 可以任意拼接, 也可单独使用。
- 3M1 (-1℃~ 5℃) for all kinds of cooked-food, fresh meat, Vacuum-packed food etc.
- 3 basic length specifications: 1875mm, 2500mm and 3750mm, Can be jointed freely, also can be use separately.



### 产品特点

### FEATURES

- 采用全景展示的圆弧玻璃结构, 使您所展示的食品一目了然, 展示效果好。
- 顶部配有明亮柔和的灯光, 使食品的展示效果达到最佳。
- 采用微电脑控制器, 可实现多方面控制调节。
- 前部圆弧玻璃可掀开, 后部带有可推拉玻璃, 最大程度方便用户上货、取货;
- 控制盒可抽拉, 方便安装和维修。
- 后部超大冷藏储藏室, 增加储物空间, 方便商品储存和补货。
- 顶部照明, 储藏室照明, 制冷系统, 防凝露系统等分开控制, 方便您的日常使用。
- Using panoramic display of arc glass structure, make food inside be clear at a glance and better display effect.
- Bright and soft light, on the top make food visual effects better.
- Adopting microcomputer controller can achieve a wide range of control and regulation.
- Front arc glass can be lifted up, rear glass can be slid, which is most convenient for user to load and take out commodities; the controller box can be pulled, easy to install and repair.
- Rear with oversize storage room in same temperature as cabinet inside, enlarging storage space and convenient to supplement commodities.
- Top lighting, storage room lighting, refrigeration systems and anti-condensation system are controlled separately, convenient to daily use.

### 产品型号

### MODEL

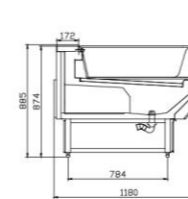

维多利亚平口服务柜

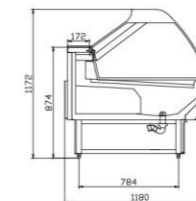

维多利亚可掀服务柜

F Z-E7WD-Z 25 K-0 1

产品序列号  
产品系列号: 0为普通系列, E为节能系列  
保温型式: K为可掀玻璃, P为平口型  
柜体长度: 18为1875mm, 25为2500mm, 37为3750mm  
产品类型: F为分体柜, Z为整体柜  
产品名称: E7WD为E7维多利亚  
运行温度: Z为中温  
产品样式: F为服务柜

F Z-E7WD-Z 25 K-0 1

Sequence number of product  
Serial number: 0 is normal serial; E is energy-saving serial  
K for curve glass; P for open type  
Length of cabinet body: 18 is 1875mm; 25 is 2500mm; 37 is 3750mm  
Type of product: Z is plug-in; F is remote  
Name of product: E7WD for E7 VICTORIA  
Running temperature: Z is mid-temp  
Style of product: F for counter type showcase



## E7 匹兹堡

E7 PITTSBURGH

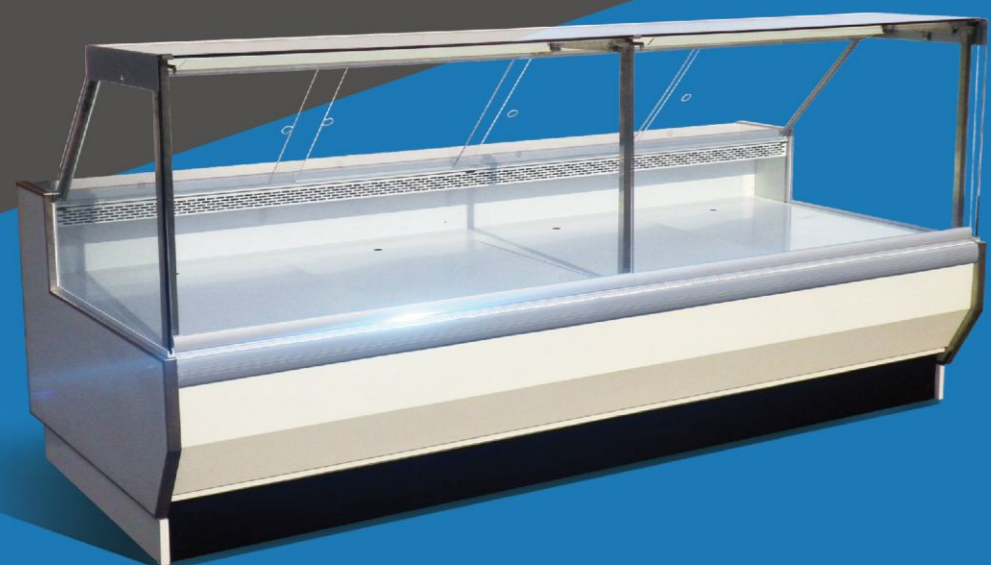

### 两种外观

直玻璃 / 平口型

### 优化风幕

双层风幕制冷更佳

### 构造结实

钢化玻璃抗冲击力

### 节能卫生

后配有台阶推拉门

### 产品用途

### PURPOSE

- 冷柜运行温度3M1(-1~5℃)时, 用于展示和销售各种肉类、水果、熟食、乳品及冷饮等。
- 热柜运行温度60~65℃时, 干热柜用于展示和销售各种烤、熏、煎、炸等熟食。
- 湿热柜用于展示和销售成品热菜、蒸煮食品、肉制品等。
- 长度有1250mm、1875mm、2500mm、3750mm四种基本规格,可任意拼接。
- M1(-1~5℃) for kinds of meat, fruit, cooked-food, dairy product and cold beverage etc.
- 60~65℃, dry heat cabinet is for baked, smoked, pan fried and deep fried food etc.
- Moist heat cabinet is for hot-dishes, steamed-boiled food and cooked meat etc.
- 4 basic length specifications:1250mm, 1875mm, 2500mm and 3750mm, Can be jointed together freely.

### 产品特点

### FEATURES

- 有直玻璃和平口型两种外观, 可以满足不同使用需求。
- 冷柜采用双层均风设计, 风幕更优化, 制冷效果佳。
- 前面与顶部采用钢化玻璃, 抗冲击力强。
- 超大容积、超大展示面积, 展示效果好。
- 后面配有台阶式推拉门, 节能卫生。
- Vertical glass type and flat top-open type can meet different use requirement.
- Double-layer uniform air flow design makes air curtain more optimum and better cooling effect.
- Tempered glass used in front and top guarantee strong anti-impact performance.
- Extra large capacity with extra large display area provides best display effect.
- Sliding door design in rear ensures energy-saving and hygienic.

### 产品型号

### MODEL

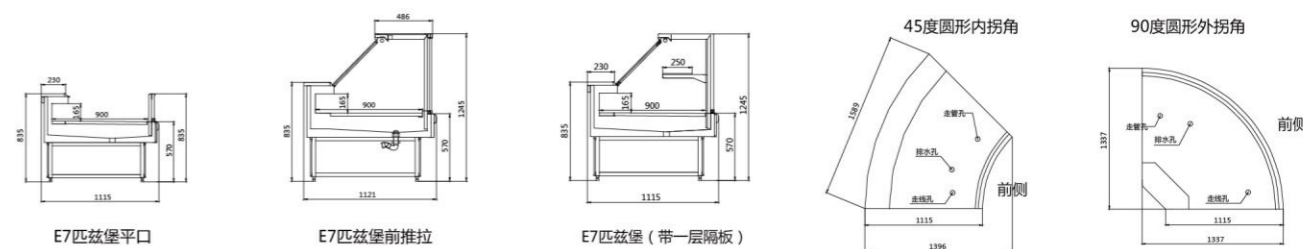

E7匹兹堡平口

E7匹兹堡前推拉

E7匹兹堡(带一层隔板)

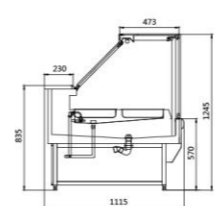

E7匹兹堡湿热柜

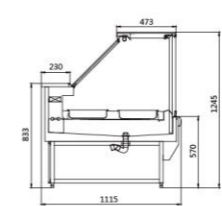

E7匹兹堡干热柜

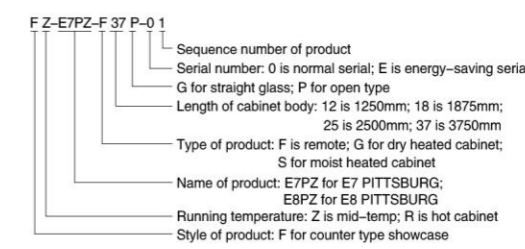
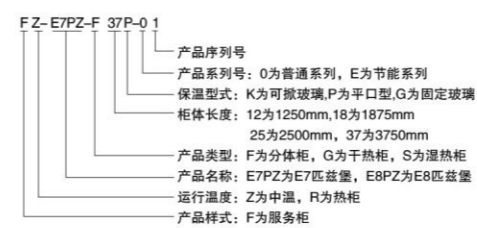



## E7 加利鲜肉柜

E7 CARY



### 展示面大

前沿高度低开口大

### 快冷保鲜

独特梯形层流吹风

### 防锈防氧化

零部件更持久耐用

### 随心调节

多层搁板满足不同需求

### 产品用途

### PURPOSE

- 温度范围：S ( $\leq 5^{\circ}\text{C}$ ) 用于展示和销售海产品、鲜肉类、熟食等。
- 该柜型为整体柜，长度有：1875mm, 2500mm两种规格，可以任意拼接。
- It is used to display and sell seafood, fresh meat and cooked-food etc. at the running temperature of S ( $\leq 5^{\circ}\text{C}$ ).
- Both plug-in and remote type, two length specification 1875mm and 2500mm .can be jointed randomly.



### 产品特点

### FEATURES

- 外观豪华气派，前沿高度低，开口展示面积大，能最大限度的增加食品的展示效果。
- 容积大，占地面积小。
- 采用独特的梯形层流风幕设计和背板出风技术，梯度出风均匀，有效降低陈列柜能耗。
- 采用名牌压缩机，制冷快，温度均匀，提高了食品的保鲜品质。
- 蒸发风机采用挂接方式，控制盒和机组可抽拉，方便安装和维修。
- 采用搁板配置，角度可调，可根据卖场要求调节不同的展示效果。
- 零部件进行防腐防锈处理，铝合金采用磨砂氧化处理，外观件采用静电喷涂处理。
- Luxury appearance, low height of the front edge, large open display area, maximally enlarge display effect.
- Large volume, small occupied area.
- Unique technology of trapezoid laminar flow air curtain and air outlet from back board ensure the air flow evenly and energy-conservation.
- Adopting famous brand compressor, quick cooling, temperature uniformity, improve the quality of fresh food.
- Evaporator fan in hanging type and control box can be push-pull, which is easy to install and repair.
- VUsing shelf configuration with adjustable angle, regulate display effect according to store requirements.
- Spare parts for anti-corrosion anti-rust treatment, aluminum alloy with matte oxidation treatment, exterior appearance parts in electrostatic spraying treatment.

### 产品型号

### MODEL

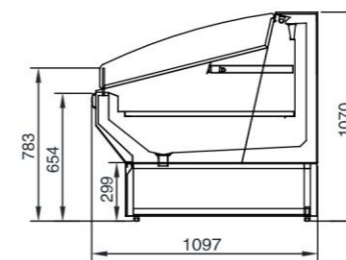

E7 加利鲜肉柜

B Z-E7JX-Z 2510 6-0 1

- 产品序列号
- 产品系列号：0为普通系列，E为节能系列
- 前沿高度：6为660mm
- 柜体高度：10为1070mm
- 柜体长度：18为1875mm, 25为2500mm
- 产品类型：Z为整体
- 产品名称：E7JX为E7加利鲜肉柜
- 运行温度：Z为中温
- 产品样式：B为立式柜

B Z-E7JX-Z 2510 6-0 1

- Sequence number of product
- Serial number: 0 is normal serial; E is energy-saving serial
- Height of front edge: 6 is 660mm
- Height of cabinet body: 10 is 1070mm
- Length of cabinet body: 18 is 1875mm; 25 is 2500mm
- Type of product: Z is plug-in
- Name of product: E7JX for E7 CARY
- Running temperature: Z is mid-temp
- Style of product: B is multi-deck showcase



## 孟菲斯熟食柜

MEMPHIS DELI SHOWCASE

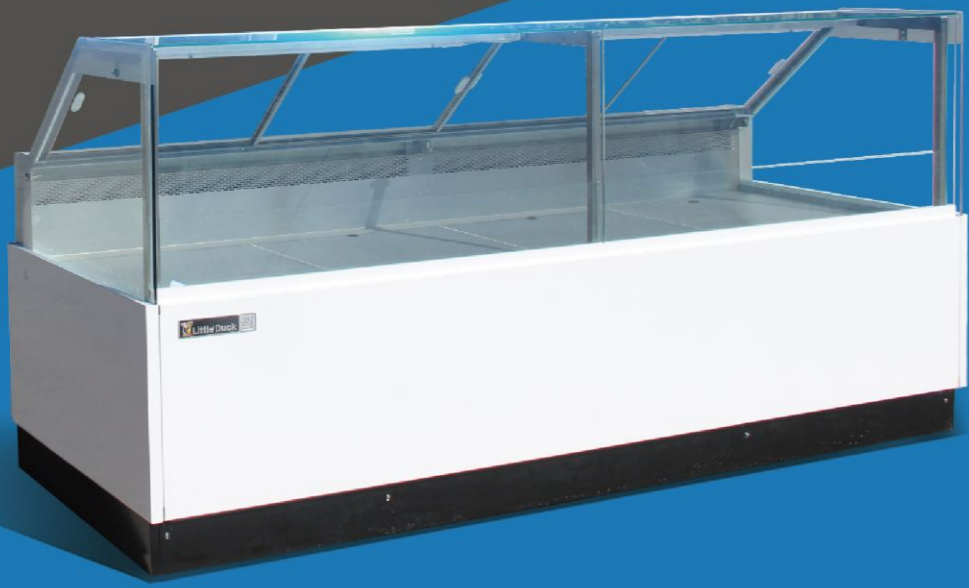

展示面大

玻璃面大好展示

制冷无死角

柜内风幕稳定

更人性化

机组自蒸发设计

美观大方

精细部件喷涂处理

### 产品用途

### PURPOSE

- M2 (-1~7℃) 用于展示和销售肉制品、海制品、熟食品等；
- H1 (1~10℃) 用于展示和销售各种水果、蔬菜等食品。
- 该柜型为整体风冷柜，长度有：1500mm，1800mm，2000mm，2500mm四种基本规格。可以任意拼接，满足市场需求。

- M2 (-1℃~7℃) for meat meat, seafoods and deli foods, etc.;
- H1 (1℃~10℃) for fruits and vegetables, etc.
- 4 basic lengths: 1500mm, 1800mm, 2000mm and 2500mm. can be jointed together freely.

### 产品特点

### FEATURES

- 柜内风幕稳定，柜内温度均匀，无制冷死角。
- 零部件进行表面喷涂处理，美观大方。
- 采用电子控制器，温度控制准确，保证柜内温度。
- 前面与顶部采用钢化玻璃，展示效果好。
- 采用后推拉门设计，节能、卫生。
- 机组自蒸发设计，无需清理接水盒。
- 后装饰板可拆卸，方便清洁卫生。
- A steady air-curtain formed by air flow makes the temperature of cabinet even and no dead band.
- Components and parts adopting anti-corrosion & anti-rust treatment reveal beautiful appearance.
- High quality electronic controllers gurantee the data of temperature precise.
- Tempered glasses used in front and top provide a good exhibition.
- The design of rear sliding door makes sure of energy saving and sanitation.
- The water box is no need to clean due to self-evaporating design.
- The removable rear decorative plate is convenient to clean condenser.

### 产品型号

### MODEL

F Z-MF-Z 25 G-0 1

产品序列号  
产品系列号：0为普通系列，E为节能系列  
保温形式：G为固定玻璃系列  
柜体长度：15为1500mm，18为1800mm  
20为2000mm，25为2500mm  
产品类型：Z为整体  
产品名称：孟菲斯  
运行温度：Z为中温  
产品样式：F为服务柜

F Z-MF-Z 25 G-0 1

Sequence number of product  
Serial number: 0 is ordinary series,  
E is energy-saving series  
Insulation form: G is fixed glass series  
Length of cabinet body: 1500mm for 15, 1800mm for 18  
2000mm for 20, 2500mm for 25  
Type of product: Z is plug-in  
Name of product: Memphis  
Running temperature: Z is medium temperature  
Style of product: F for service cabinet

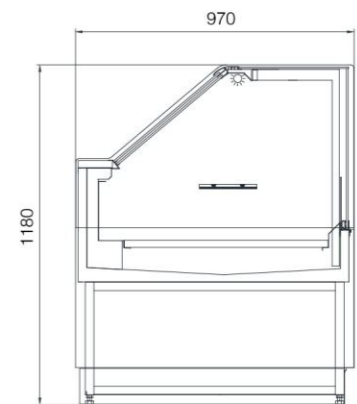

孟菲斯熟食柜



## EA 波尔多/圣菲

EA BORDEAUX/ SANTA FE

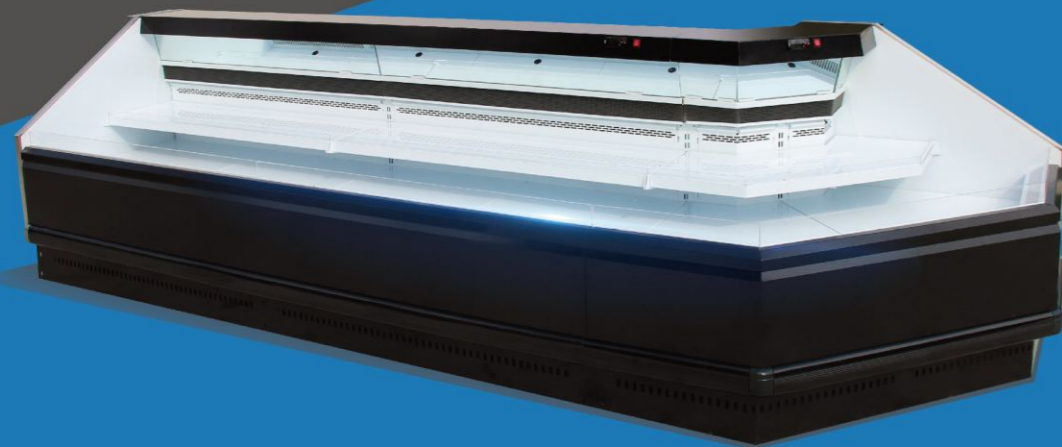

### 容易布局

不同宽度设计

### 展示效果好

增大展示面积

### 维保方便

电器件顶部设计

### 设计美观

灯饰丰富更美观

### 产品用途

### PURPOSE

- 运行温度为M1(-1~5℃)，主要用于展示和销售海产品、鲜肉类、奶制品、熟食等冷藏食品。
- EA波尔多柜型宽度为940mm，EA圣菲柜型宽度为1085mm。
- 长度有1250mm、1875mm、2500mm和3750mm四种规格，配有90°外拐，可以任意拼接。

- Running temperature M1(-1~5℃) is mainly for displaying seafood products, fresh meat, dairy product and del.
- There are 2 heights--1300mm and 1500mm--for EA Bordeaux/Santa Fe
- 4 basic lengths cabinets--1250mm, 1875mm, 2500mm and 3750mm--can be jointed together freely. It also can be chosen 90° angle corner cabinet for better vision.



### 产品特点

### FEATURES

- 采用均匀风幕设计，柜内温度均匀，保证展示商品品质，防凝露效果好；
  - 搁板角度可调，增大展示面积，突出商品展示效果；
  - 优化风幕、风速，避免冷风外溢，节能效果突出；
  - 顶部镜子设计，完美展示商品效果；
  - 电器件顶部设计，观察、使用、维修方便；
  - 不同宽度设计，满足不同卖场布局需求。
- Uniform air curtain makes the temperature of the cabinet even and guarantee the quality of the displaying products. The cabinet is also in good anti-condensation.
  - Angle-changed shelves enlarge the display areas and effect.
  - Optimized air curtain and speed reduce cold wind flow out and make the cabinet more energy-saving.
  - Top mirror improve the exhibition of products.
  - Electronic components put on top make observation, use and maintenance more easy.
  - Different lengths can match different size of the store room.

### 产品型号

### MODEL

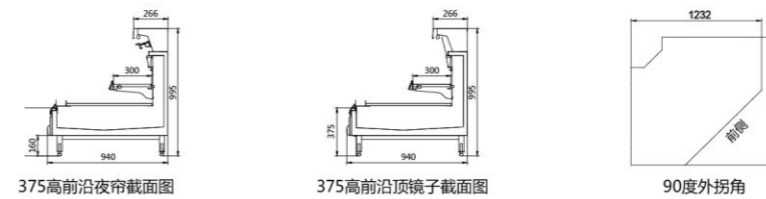

#### EA波尔多

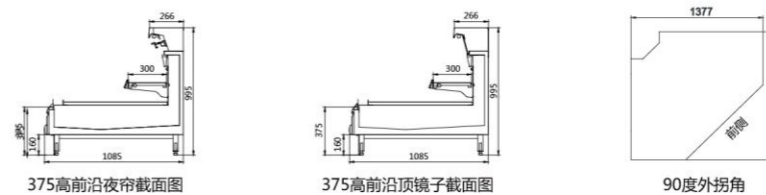

#### EA圣菲

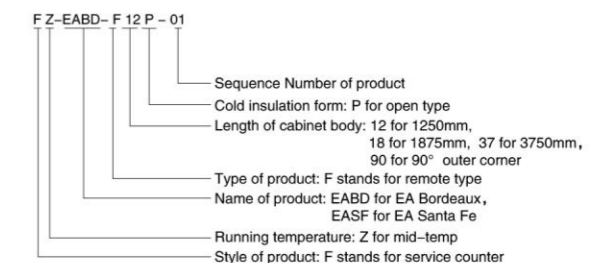





## 双面熟食柜

TWO-SIDE DELI SHOWCASE



### 人性化设计

两面取物更方便

### 容积大

更大容积更实用

### 制冷快速

食品保鲜一流

### 安全卫生

304食品级不锈钢内饰

## 产品用途

PURPOSE

- 运行温度为M1 (-1~5℃)，用于展示销售熟食等商品。
- 冷柜采用双面推拉门，使用更加方便。

- Operating temperature M1 (-1~5℃) for displaying cooked foods.
- The refrigerator adopts double-sided sliding door, more convenient to use.



## 产品特点

FEATURES

- 上面采用大圆弧钢化玻璃推拉门，可以两面拿取商品，方便安全。
  - 采用全景式设计，四周均为钢化玻璃，柜内商品360°展示，展示效果佳。
  - 容积大，占地面积小。
  - 制冷快，温度均匀，提高了食品的保鲜品质。
  - 冷柜内部采用304食品级不锈钢装饰，安全卫生，清洁方便。
  - 采用高效预冷波纹翅片的蒸发器结构，制冷性能佳。
- By using large arc toughened glass sliding door, you can take out of goods on both sides.
  - Panoramic design and tempered glass all around secure goods seen from 360° in good visual effect.
  - With large volume, the showcase occupies small areas.
  - Fast refrigerating and uniform temperature improve the quality of food inside.
  - Adopted food-grade 304 stainless steel inside, the refrigerator is sanitary for foods stored and convenient to be cleaned.
  - A good refrigerating performance was guaranteed thanks to the corrugated fin evaporators that is high efficient and pre-cooling ensure.

## 产品型号

MODEL

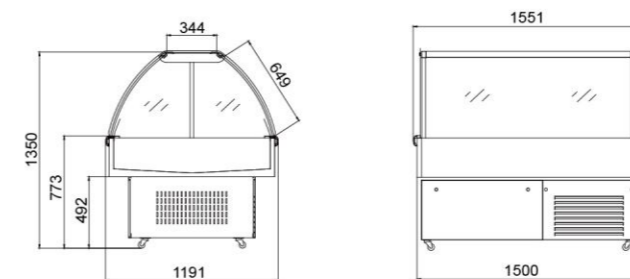

双面熟食柜

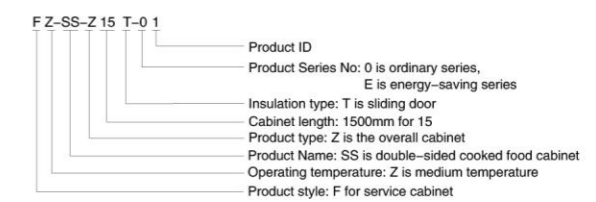
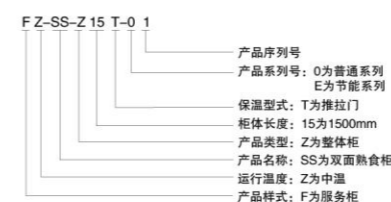



## E6 阿拉斯加(干热柜) 波士顿(湿热柜)

E6 ALASKA(DRY HEAT)  
E6 BOSTON(MOIST HEAT)



### 国家专利

更权威更安全高效

### 节能省电

加热照明分开控制

### 使用方便

全自动进水加热保温

### 人本设计

各功能配有专用插座

## 产品用途

## PURPOSE

- 运行温度为60~65℃, 干热柜主要用于保温展示和销售各种烤、熏、煎、炸等熟食; 湿热柜主要用于保温展示和销售成品热菜、蒸煮食品、熟肉制品等。
- 长度有1250mm、1875mm、2500mm、3750mm四种基本规格, 可任意拼接。
- Running temperature at 60~65℃. Dry heat cabinets for baked, smoked, pan fried and deep fried food, etc. Moist heat cabinet is for hot dishes, steamed-boiled food, cooked meat etc.
- 4 basic length specifications: 1250mm, 1875mm, 2500mm and 3750mm. Can be jointed together freely.



## 产品特点

## FEATURES

- 干热柜采用已获国家专利加热技术——热风循环加热方式, 温度均匀恒定, 食品不易变色, 口感好; 不会出现传统热柜局部温度过高的现象, 且食品干耗比传统热柜低30%。
- 干热柜加热和照明分开控制, 操作方便, 节能省电。
- 湿热柜采用水加热保温方式, 柜温更均匀, 全自动进水装置, 使用更方便。
- 大圆弧钢化玻璃, 抗冲击力强, 展示效果佳。
- 独有台阶式推拉门、电子秤专用插座等, 人本设计, 方便使用。
- Adopting national patent heating technology hot: air circulation heating mode in dry heat cabinet effects the inner temperature uniform and constant, the food keep fresh, taste well and do not discolor. It will not appear the inner temperature is much higher in some area like the traditional hot cabinet, and the consumption lower 30% than traditional hot cabinets.
- Heating and lighting of dry heat cabinet is controlled separately, easy to be operated and save energy.
- With automatic water inlet device, water heating and heat preservation mode used for moist heat cabinet keep the inner temperature more uniform and in convenient use.
- Large arc tempered glass is used, strong anti-impact and better display.
- The unique stepped sliding door and socket of electronic scale, Human Oriented Design, convenient to use.

## 产品型号

## MODEL

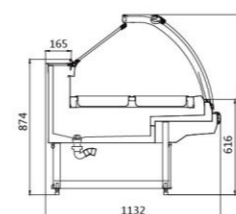

E6阿拉斯加可掀干热柜

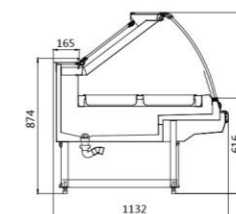

E6阿拉斯加前推拉干热柜

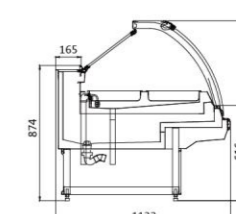

E6波士顿(E7防撞)  
湿热柜

FR-E6AL-G 18 K-0 1

产品序列号  
产品系列号: 0为普通系列, E为节能系列  
保温型式: K为圆弧可掀型  
柜体长度: 12为1250mm, 18为1875mm  
25为2500mm, 37为3750mm  
产品类型: F为干热柜, S为湿热柜  
产品名称: E6AL为E6阿拉斯加;  
E6BS为E6波士顿  
运行温度: R为热柜  
产品样式: F为服务柜

FR-E6AL-G 18 K-0 1

Sequence number of product  
Serial number: 0 is normal serial; E is energy-saving serial  
K for rounded and liftable glass  
Length of cabinet body: 12 is 1250mm; 18 is 1875mm;  
25 is 2500mm; 37 is 3750mm  
Type of product: G for dry heated cabinet; S for moist heated cabinet  
Name of product: E6AL for E6 ALASKA; E6BS for E6 BOSTON  
Running temperature: R is hot cabinet  
Style of product: F for counter type showcase