

A better solution in supermarket and convenience store refrigeration

 Austune Australia Pty Ltd
 Free Call 1800 FRIDGE(37 43 43)
 Unit 3, 35 Davis Road Wetherill Park NSW 2164



☎ 1800374343



Austune Australia Pty Ltd

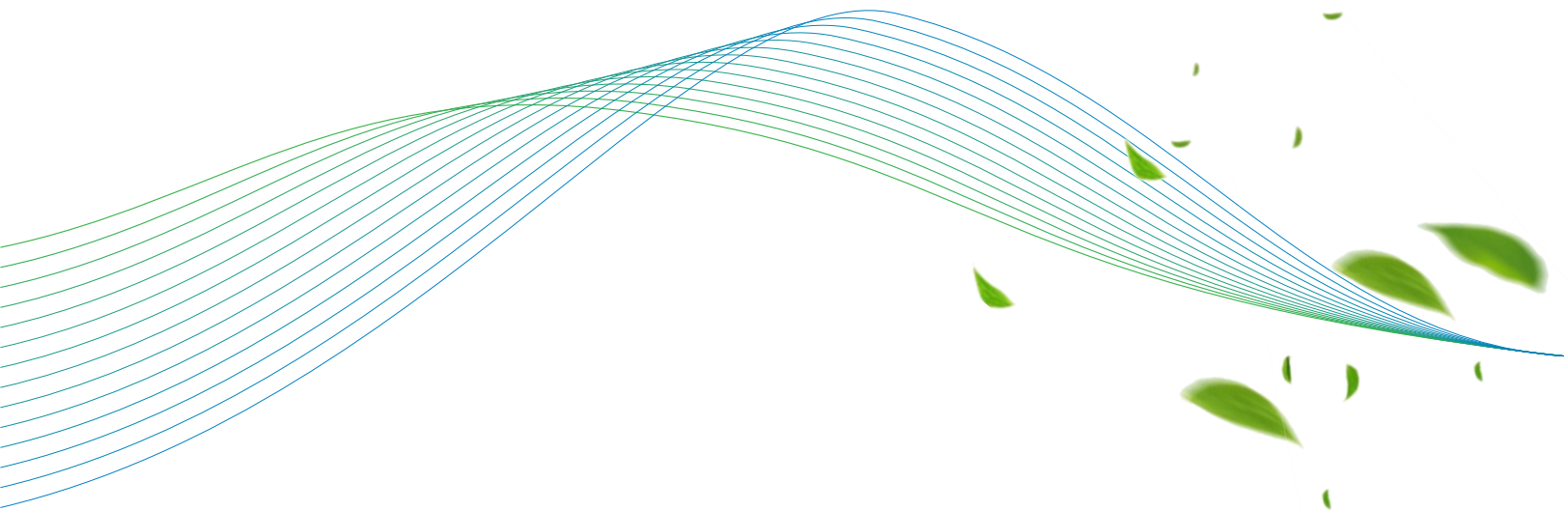



01 Supermarket

31 Convenience Store



☎ 1800374343

Product Description for Supermarket

Best Partner for You





Dual Air Curtain Multidecks-Remote

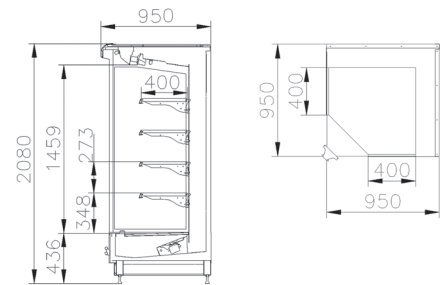

Product Features

- Innovatively Designed
- Clean modern style
- Equipped with dual-jet air curtain
- Retractable Night Blind as Standard
- Four adjustable shelves
- Interior LED lighting
- Corner unit available
- Optional products stopper

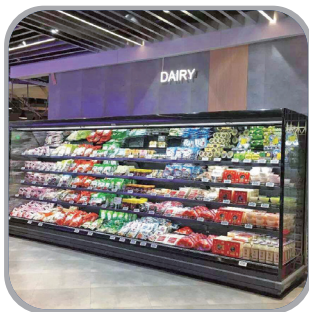

Technical specifications

Model	LF1.5ES	LF2.0ES	LF3.0ES
Size without end panel,mm	1875*950*2080	2500*950*2080	3750*950*2080
Temperature Range, °C	2~8°C	2~8°C	2~8°C
Net volume,L	1250	1670	2500

Specifications subject to change without notice



Deluxe Dual Air Curtain Multidecks-Remote

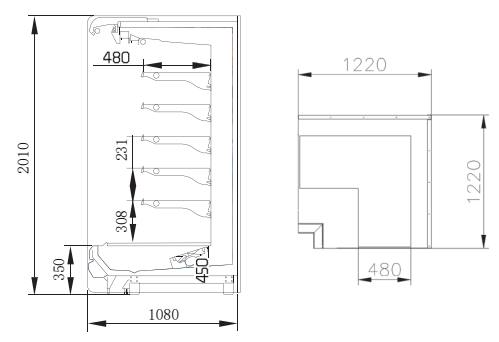

Product Features

- Innovatively Designed
- Clean modern style with low front
- Equipped with dual-jet air curtain
- Retractable Night Blind as Standard
- Four adjustable shelves
- Interior LED lighting
- Corner unit available
- Optional products stopper



Technical specifications

Model	LF18SM01	LF25SM01	LF37SM01
Size without end panel,mm	1875*1080*2010	2500*1080*2010	3750*1080*2010
Temperature Range, °C	0~8°C	0~8°C	0~8°C
Net volume,L	1500	1920	2900

Specifications subject to change without notice

Glass Door Chiller-Remote



Product Features

- Innovatively Designed Chiller
- Clean modern style
- Intelligent Digital Controller
- Display Doors reduce energy consumption
- Full length Moulded Door handles
- Four adjustable shelves
- Interior LED lighting



Technical specifications

Model	LF1.5C	LF2.0C	LF3.0C
Size without end panel,mm	1875*950*2080	2500*950*2080	3750*950*2080
Temperature Range, °C	0~8°C	0~8°C	0~8°C
Net volume,L	1290	1710	2570
Doors	3	4	6

Specifications subject to change without notice





E6 Dual Air Curtain Multidecks-Remote

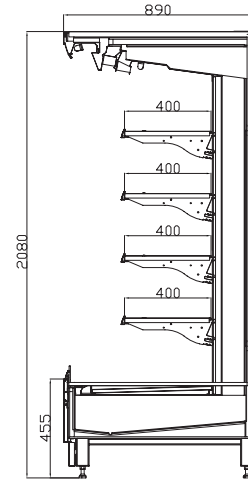

Product Features

- Innovatively Designed
- Clean modern style with Low front
- Equipped with dual-jet air curtain
- Retractable Night Blind as Standard
- Four adjustable shelves
- Interior LED lighting
- Optional products stopper

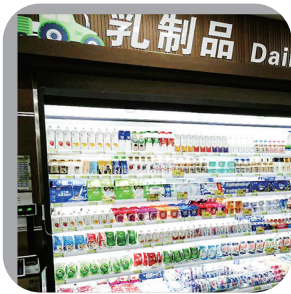

Technical specifications

Model	LF1.5ES-E6	LF2.0ES-E6	LF3.0ES-E6
Size without end panel,mm	1875*890*2080	2500*890*2080	3750*890*2080
Temperature Range, °C	0~8°C	0~8°C	0~8°C
Net volume,L	1250	1670	2500

Specifications subject to change without notice



E6 Glass Door Chiller-Remote

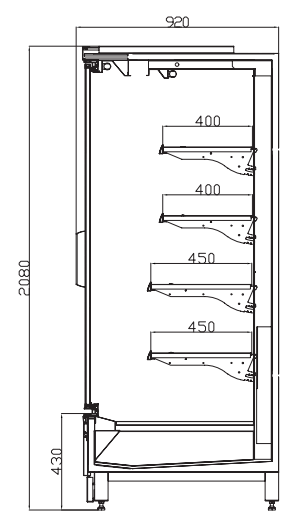

Product Features

- Innovatively Designed Chiller
- Clean modern style
- Intelligent Digital Controller
- Display Doors reduce energy consumption
- Four adjustable shelves
- Interior LED lighting



Technical specifications

Model	LF1.5C-E6	LF2.0C-E6	LF3.0C-E6
Size without end panel,mm	1875*920*2080	2500*920*2080	3750*920*2080
Temperature Range, °C	0-8°C	0~8°C	0~8°C
Net volume,L	1290	1710	2570
Doors	3	4	6

Specifications subject to change without notice



Glass Door Freezer-Remote

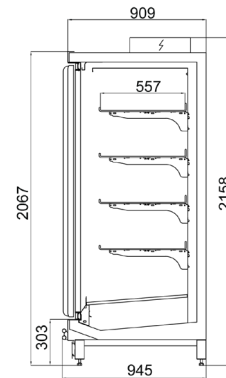

Product Features

- Innovatively Designed Chiller
- Clean modern style
- Intelligent Digital Controller
- Large Insulated Display Doors reduce energy consumption
- Four adjustable shelves
- Interior LED lighting

Technical specifications

Model	DBL-2D	DBL-3D	DBL-4D	DBL-5D
Size without end panel,mm	1562*945*2067/2158	2343*945*2067/2158	3124*945*2067/2158	3900*945*2067/2158
Temperature Range, °C	≤-18 °C	≤-18 °C	≤-18 °C	≤-18 °C
Net volume,L	1000	1400	1900	2400
Doors	2	3	4	5

Specifications subject to change without notice

Semi Vertical Round Island Remote

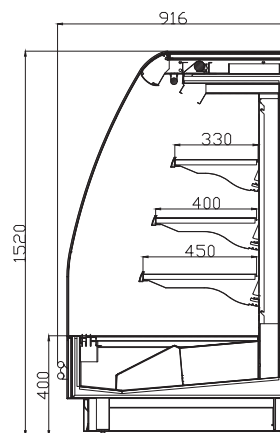

Product Features

- Innovatively Designed Chiller
- Clean modern style and Concept
- Intelligent Digital Controller
- Lower Front for optimum display
- Three adjustable shelves
- Interior LED lighting



Technical specifications

Model	HLF188AM38159	HLF250AM38159	HLF375AM38159	HLF188AM38159MO
Panel,mm	1875*920*1560	2500*920*1560	3750*920*1560	2120*1060*1560
Temperature, °C	2~8°C	2~8°C	2~8°C	2~8°C
Net volume,L	710	940	1420	460

Specifications subject to change without notice

Semi Vertical Multidecks

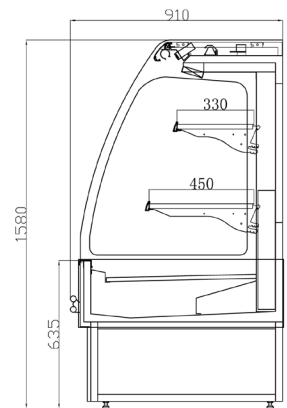

Product Features

- Attractive low profile open Display
- Clean modern style
- Intelligent Digital Controller
- Retractable night blinds to reduce energy consumption
- Two adjustable shelves
- Interior LED lighting
- Secop Compressor
- Optional products stopper

Technical specifications

Model-Plug in	AMSM-1250	AMSM-1950	AMSM-2580	AMSMT-1950
Model-Remote	HLF0.8E	HLF1.0E	HLF1.3E	HLFMTU
Size without end panel,mm	1250*910*1580	1950*910*1580	2580*910*1580	1950*910*1580
Temperature Range, °C	3~8°C	3~8°C	3~8°C	3~8°C
Net volume,L	560	730	1110	730

Specifications subject to change without notice

Slim Multidecks Plug In

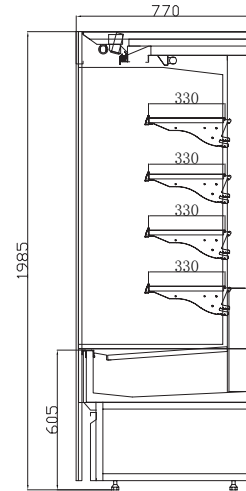

Product Features

- Attractive open display
- Clean modern style
- Intelligent Digital Controller
- Retractable night blinds to reduce energy consumption
- Standard 4 adjustable shelves
- Interior LED lighting
- Self Evaporating
- Optional products stopper



Technical specifications

Model	AMD1006	AMD1310	AMD1943	AMD2568
Size without end panel,mm	1006*770*1985	1310*770*1985	1943*770*1985	2568*770*1985
Temperature Range, °C	3~8°C	3~8°C	3~8°C	3~8°C
Net volume,L	450	600	900	1200

Specifications subject to change without notice

Slim Glass Door Chiller

CE CB

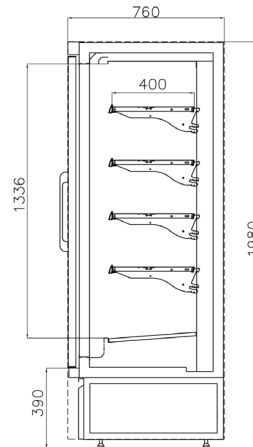

Product Features

- Attractive Refrigerated display
- Clean modern style
- Intelligent Digital Controller
- Large Insulated Display Doors reduce energy consumption
- Standard 4 adjustable shelves
- Interior LED lighting
- Self Evaporating

Technical specifications

Model	LB0.8B(F)	LB1.2B(F)	LB1.5B(F)
Size without end panel,mm	1325*760*1980	1935*760*1980	2560*760*1980
Temperature Range, °C	3~8°C	3~8°C	3~8°C
Net volume,L	600	900	1200
Doors	2	3	4

Specifications subject to change without notice



Mini Island Freezer -750mm Deepth



Product Features

- Sliding curved tempered glass door
- Interior LED lighting
- Electronic controller
- Steel wire pvc coated basket/dividers
- Adjustable feet or multidirectional castor with brake
- Bumpers and price strips included
- Optional:copper evaporator
- Optional:automatic defrost

Technical specifications

Model	AISF-1200E	AISF-1470E	AISF-2000E	AISF-1605E
Size ,mm	1200*750*850	1470*750*850	2000*750*850	1605*750*850
Temperature Range, °C	-18°C ~-25°C	-18°C ~-25°C	-18°C ~-25°C	-18°C ~-25°C
Net volume,L	400	515	745	576

Specifications subject to change without notice

Island Freezer-Individual 3 Pieces Push & Pull Glass



Product Features

- 3 Stgs Push back sectioned Glass Lid
- Interior LED lighting
- Steel wire pvc coated basket/dividers
- Auto Defrost

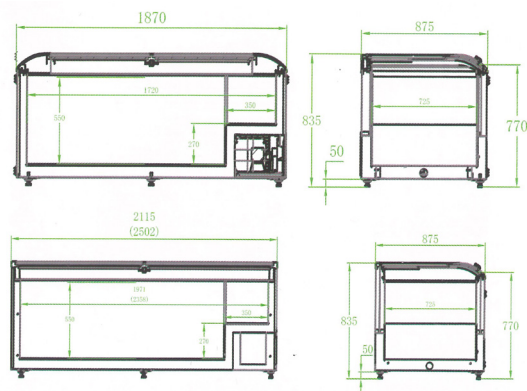

Technical specifications

Model	AISF-1871U	AISF-2115U	AISF-2502U
Size ,mm	1871*875*772	2115*875*832	2502*875*832
Temperature Range, °C	≤-18°C	≤-18°C	≤-18°C
Net volume,L	560	570	690

Specifications subject to change without notice

Island Freezer -Classic Sliding Glass Lid

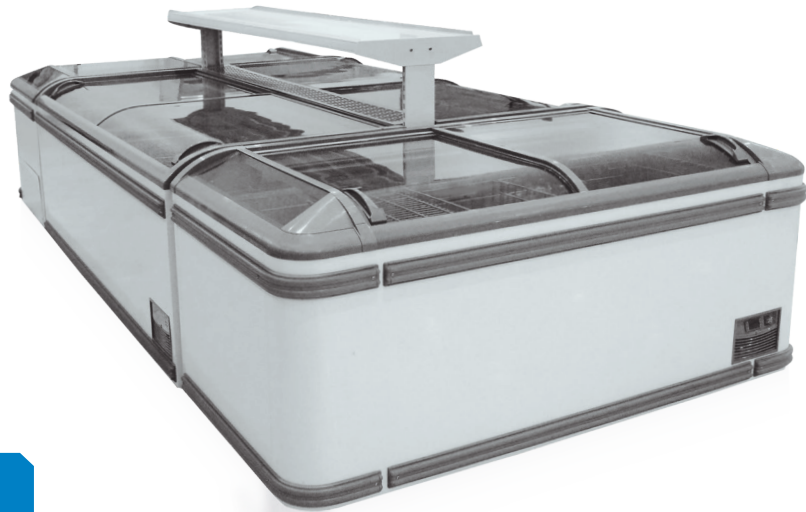

Product Features

- Highest standards of technology and construction
- LED interior lighting
- Maximum energy efficiency with use of Electronic speed-controlled compressor
- 100% CFC-and PEC-free
- Ready to Plug-in,no sdditional assembly required
- Mauntenance-free cooling technology
- Large max view left and right opening sliding Glass lids
- Bumper rails and Price strips
- PVC coated wire ad justable Dividers

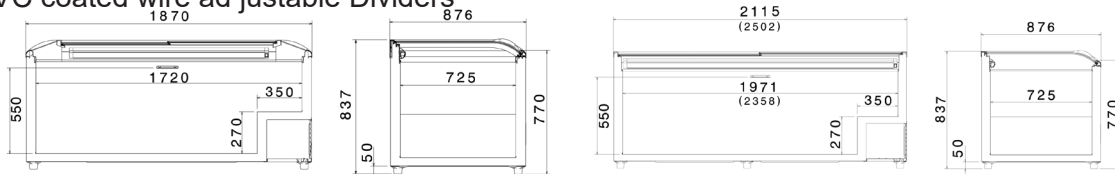

Technical specifications

Model	AISF-1870	AISF-1470	AISF-2115	AISF-2502
Size ,mm	1870*875*835	1470*875*835	2115*875*835	2502*875*835
Temperature Range, °C	≤ -18 °C	≤ -18 °C	≤ -18 °C	≤ -18 °C
Net volume,L	560	460	570	690

Specifications subject to change without notice

Island Freezer-Euro Windows



Product Features

- Professional New European Design
- Flat top Glass side to side opening
- Highest standards of technology and construction
- LED interior lighting
- 100% CFC- and PFC-free
- Ready to plug-in, no additional assembly required
- Maintenance-free cooling technology
- Bumper rails and Price strips
- PVC coated wire adjustable Dividers

Technical specifications

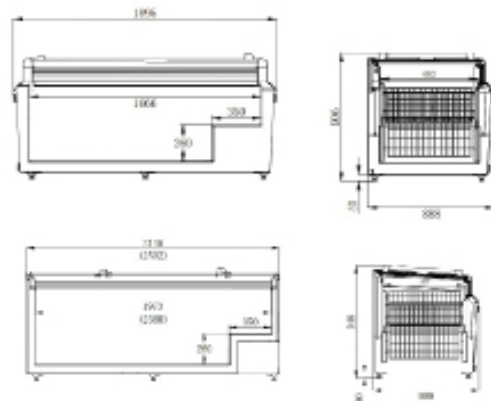

Model	ZD18C01-L	ZP21C01-L	ZP25C01-L
Size ,mm	1895*888*906	2115*888*948	2502*888*948
Temperature Range, °C	≤-18°C	≤-18°C	≤-18°C
Net volume,L	600	700	820

Specifications subject to change without notice



Island Freezer-Big Windows (Glass Side Panel)



Product Features

- Professional New European Design
- 3 Stage Push back sectioned Glass Lid
- Highest standards of technology and construction
- LED interior lighting
- 100% CFC- and PFC-free
- High Vision side panels for ultimate product display
- Maintenance-free cooling technology
- Bumper rails and Price strips
- PVC coated wire adjustable Dividers



Technical specifications

Model	AISF-1895G	AISF-2115G	AISF-2502G
Size ,mm	1895*888*906	2115*888*948	2502*888*948
Temperature Range, °C	≤-18°C	≤-18°C	≤-18°C
Net volume,L	600	700	820

Specifications subject to change without notice

Bilateral Glass Top Chest Freezer

CE CB



Product Features

- Internal LED illumination (in the top middle)
- Electronic controller
- Shelf or basket
- Bilateral curved sliding tempered glass door
- Six big wheels, front two with brake
- Price tag
- Bumper in the front and back side

Technical specifications

Model	SDQ1100(H)
Dimension , mm	2000*1000*850
Temperature , °C	≤-18 °C
Net volume, L	1000

Specifications subject to change without notice

FS Series Display Cabinet

CE CB



Product Features

- New product, the first model in China
- This product has drawers for easy access to goods at the bottom
- Electronic temperature controller
- Product double evaporation system
- The upper part of the product is full basket design



Technical specifications

Model	FS-700	FS-800
Dimension , mm	1750*800*922	2000*800*922
Temperature , °C	700	800
Net volume, L	≤18°C	≤18°C

Specifications subject to change without notice

B Series Deli Service Over Counter



Product Features

- Curved Glass Deli Display
- Electronic controlled, Ventilate Cooling
- Temperature range: 0°C to +5°C
- Self Evaporating
- Stainless interior base
- LED internal Lighting
- Multidirectional Rollers
- Plexiglass sliding rear doors

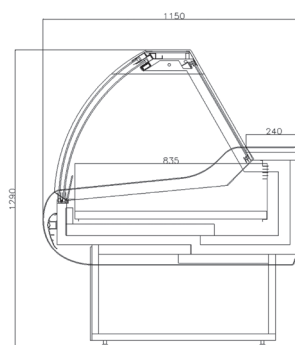

Technical specifications

Model	ADGBT-1350	ADGBT-1975	ADGBT-2600	ADGBT-3850
Size ,mm	1350*1150*1200	1975*1150*1200	2600*1150*1200	3850*1150*1200
Temperature Range, °C	0~5°C	0~5°C	0~5°C	0~5°C
Net volume,L	170	250	330	500

Technical specifications A-lift up front glass T-slide front glass

Model	ADGBA-1350	ADGBA-1975	ADGBA-2600	ADGBA-3850
Size ,mm	1350*1150*1290	1975*1150*1290	2600*1150*1290	3850*1150*1290
Temperature Range, °C	0~5°C	0~5°C	0~5°C	0~5°C
Net volume,L	170	250	330	500

Specifications subject to change without notice

H Series Deluxe Service Over Counter

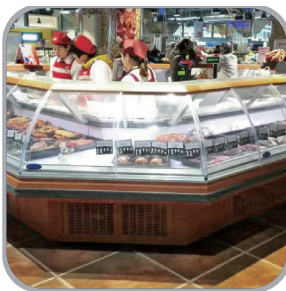
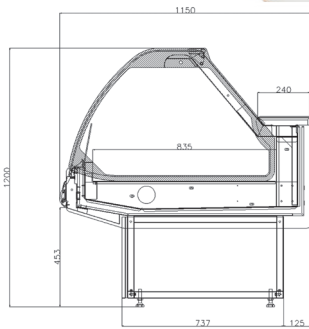

Product Features

- Luxury Curved Glass Deli Display
- Lift-up front glass for easy cleaning
- Energy Efficient Ventilated
- Refrigeration
- technology significantly reduces energy consumption
- Temperature range: 0°C to +5°C
- Self Evaporating
- Stainless interior base
- LED internal Lighting
- Multidirectional Rollers
- Plexiglass sliding rear doors
- Also available in remote

Technical specifications T-slide front glass

Model	GB0.25H(T)	GB0.4H(T)	GB0.5H(T)	GB0.7H(T)
Size ,mm	1410*1150*1200	2035*1150*1200	2660*1150*1200	3910*1150*1200
Temperature Range, °C	0-5°C	0-5°C	0-5°C	0-5°C
Net volume,L	170	250	330	500

Specifications subject to change without notice



Right Angle Flat Top Service Over Counter

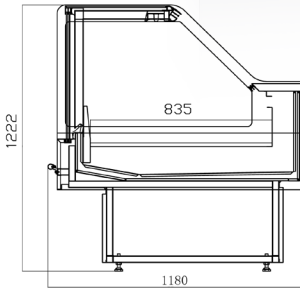

Product Features

- Elegant Square Glass Deli
- Hydraulic strut assisted Lift up Front Tempered Glass
- Energy Efficient Ventilated Refrigeration technology significantly reduces energy consumption
- Temperature range: 0°C to +5°C
- Self Evaporating
- Stainless interior base
- LED internal Lighting
- Multidirectional Rollers
- Plexiglass sliding rear doors
- Also available in remote

Technical specifications

Model	ADSZB-1875	ADSZB-2500	ADSZB-3750	ADSZBT-1875	ADSZBT-2500	ADSZBT-3750
Size ,mm	1875*1180*1222	2500*1180*1222	3750*1180*1222	1875*1180*1222	2500*1180*1222	3750*1180*1222
Temperature Range, °C	0~5°C	0~5°C	0~5°C	0~5°C	0~5°C	0~5°C
Net volume,L	250	330	500	250	330	500

Specifications subject to change without notice

Right Angle Flat Top Service Over Counter With Refrigeration Cabinet



Product Features

- Elegant Square Glass Deli with refrigerated storage under
- Hydraulic strut assisted Lift up Front Tempered Glass
- Energy Efficient Ventilated Refrigeration technology significantly reduces energy consumption
- Temperature range: 0°C to +5°C
- Self Evaporating
- Stainless interior base
- LED internal Lighting
- Multidirectional Rollers
- Plexiglass sliding rear doors
- Also available in remote

Technical specifications

Model	ADUGB-1945	ADUGB-2570	ADUGB-3820	ADUGBT-1945	ADUGBT-2570	ADUGBT-3820
Size ,mm	1945*1180*1222	2570*1180*1222	3820*1180*1222	1945*1180*1222	2570*1180*1222	3820*1180*1222
Temperature Range, °C	0~5°C	0~5°C	0~5°C	0~5°C	0~5°C	0~5°C
Net volume,L	250	330	500	250	330	500

Specifications subject to change without notice

E Series Self Service Counter

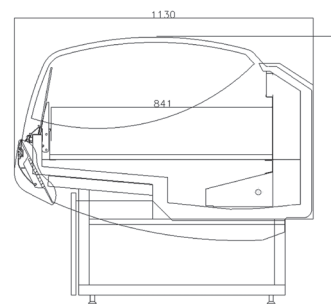
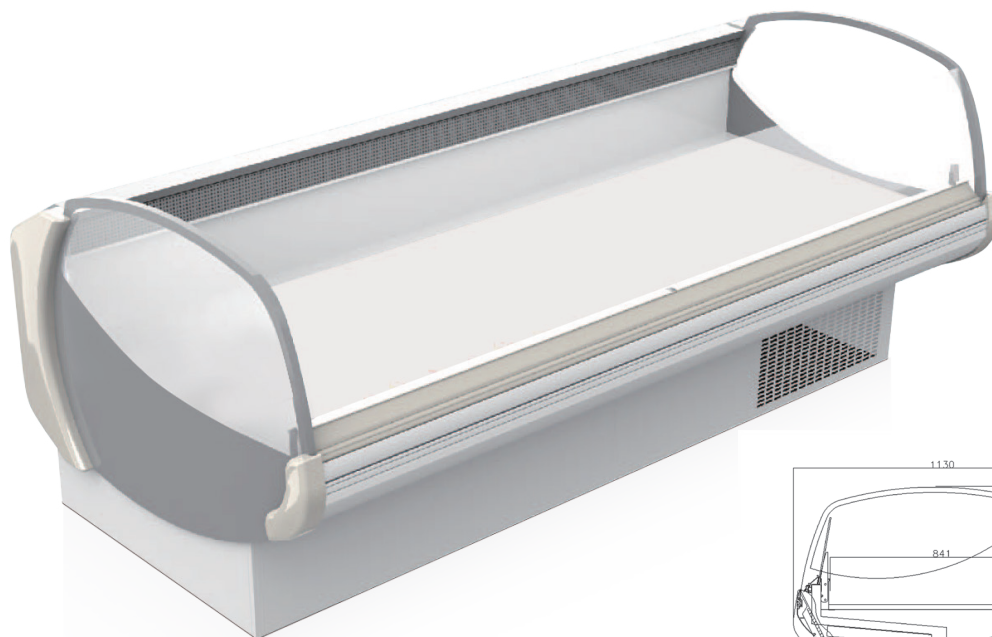

Product Features

- Elegant open-style self service showcase
- Energy Efficient Ventilated Refrigeration technology significantly reduces energy consumption
- Temperature range: 0°C to +5°C
- Self Evaporating
- Multidirectional Rollers
- Also available in remote

Technical specifications

Model	GK0.25E (F)	GK0.4E (F)	GK0.5E (F)	GK0.7E (F)
Size ,mm	1350*1130*1000 (970)	1975*1130*1000 (970)	2600*1130*1000 (970)	3850*1130*1000 (970)
Temperature Range, °C	2~5°C	2~5°C	2~5°C	2~5°C
Net volume,L	170	250	330	500

Specifications subject to change without notice



E Series Service Over Counter

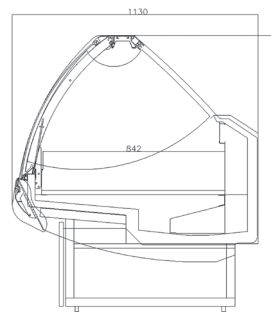
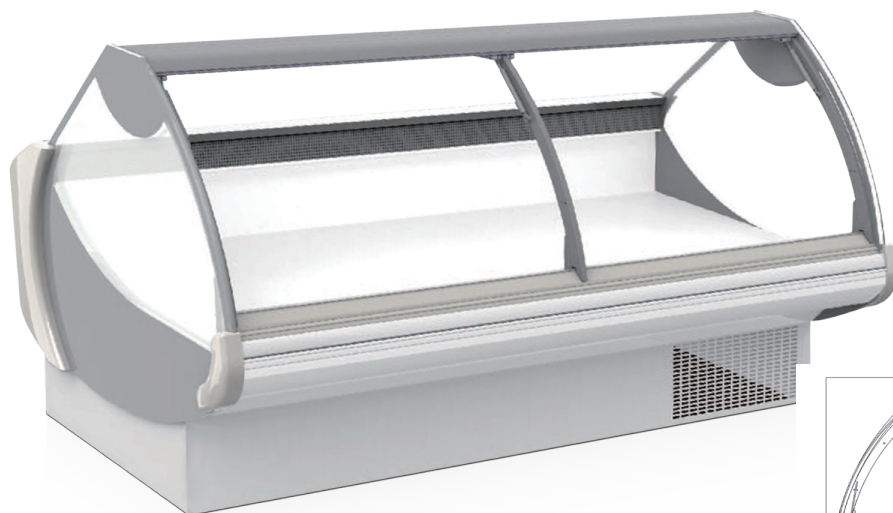

Product Features

- Luxury Curved Glass Service Deli
- Lift-up front glass for easy cleaning
- Energy Efficient Ventilated Refrigeration technology significantly reduces energy consumption
- Temperature range: 0°C to +5°C
- Self Evaporating
- LED internal Lighting
- Multidirectional Rollers
- Plexiglass sliding rear doors
- Also available in remote

Technical specifications

Model	GB0.25E(F)	GB0.4E(F)	GB0.5E(F)	GB0.7E(F)
Size ,mm	1350*1130*1300	1975*1130*1300 (1230)	2600*1130*1300 (1230)	3850*1130*1300 (1230)
Temperature Range, °C	0-5°C	0-5°C	0-5°C	0-5°C
Net volume,L	170	250	330	500

Specifications subject to change without notice

K Series Self Service Counter

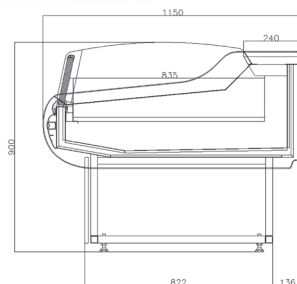

Product Features

- Elegant open-style showcase
- Energy Efficient Ventilated Refrigeration technology significantly reduces energy consumption
- Temperature range: 0°C to +5°C
- Gentle angle design with anti-condensation technology
- Also available with Sliding Glass Covers

Technical specifications

Model	GK0.25	GK0.4	GK0.5	GK0.7
Size ,mm	1350*1150*900	1975*1150*900	2600*1150*900	3850*1150*900
Temperature Range, °C	2~5°C	2~5°C	2~5°C	2~5°C
Net volume,L	170	250	330	500

Specifications subject to change without notice

K Series Self Service Freezer

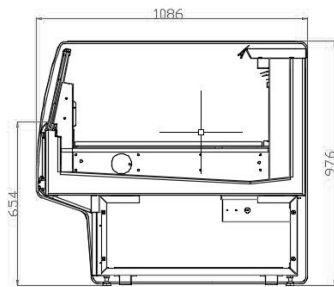
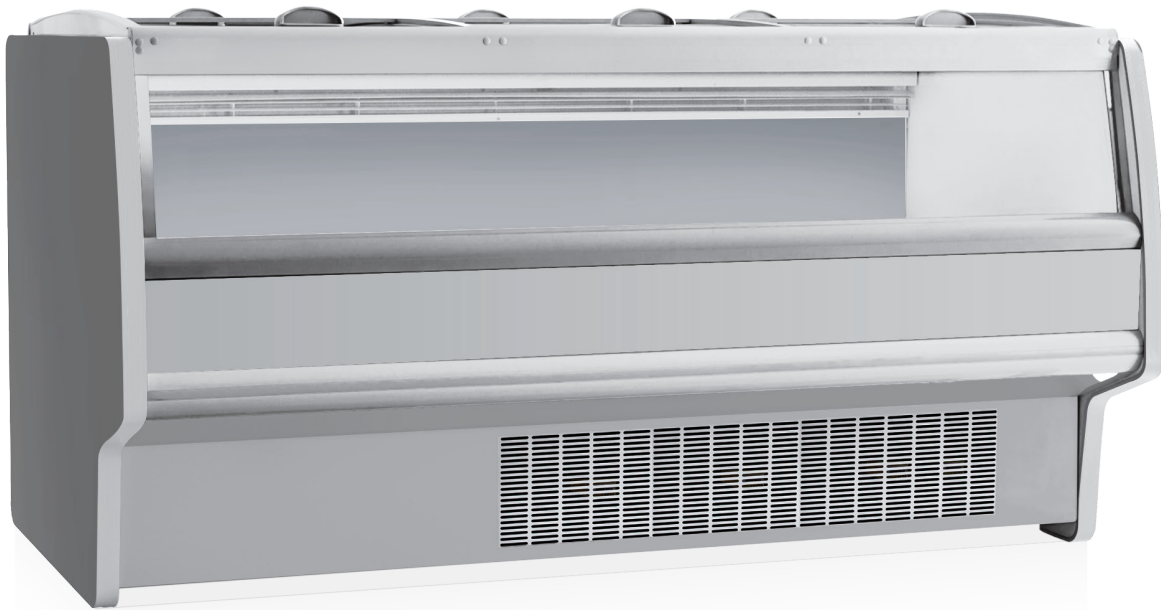
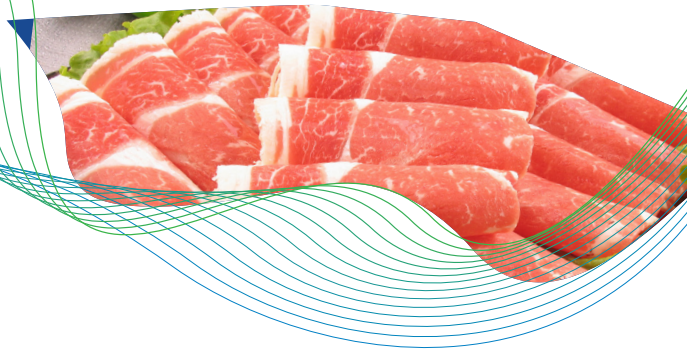

Product Features

- Elegant reach in -style showcase Freezer
- Energy Efficient Ventilated Refrigeration technology significantly reduces energy consumption
- Ergonomic front to back sliding lids
- High Vision Glass Front

Technical specifications

Model	GKD0.4	GKD0.5
Size ,mm	1955*1086*976	2570*1086*976
Temperature Range, °C	-18~22°C	-18~22°C
Net volume,L	330	440

Specifications subject to change without notice



H Series Deluxe Self Service Counter

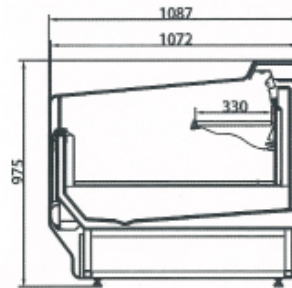

Product Features

- Elegant open-style self service showcase
- Energy Efficient Ventilated Refrigeration
- Technology significantly reduces energy consumption
- Intelligent Digital Controller
- Also available in remote

Technical specifications

Model	GK0.25H	GK0.4H	GK0.5H	GK0.7H
Size ,mm	1410*1150*900	2035*1150*900	2660*1150*900	3910*1150*900
Temperature Range, °C	2~5°C	2~5°C	2~5°C	2~5°C
Net volume,L	170	250	330	500

Specifications subject to change without notice

Dual Compressors Dual Temp Chiller & Freezer 2 in 1

Promotion Showcase 



Product Features

- Reach in open Chiller/ Freezer
- Dual Compressors
- Set as Chiller or Freezer
- Intelligent Digital Controller
- Optional Sliding Glass Lids

Technical specifications

Model	ZX0.3D	ZX0.4D	ZX0.5D
Size ,mm	1570*1070*910	2070*1070*910	2570*1070*910
Temperature Range, °C	0-8°C or ≤-18°C	0-8°C or ≤-18°C	0-8°C or ≤-18°C
Net volume,L			

Specifications subject to change without notice



Ultra Low Freezer



Product Features

- Suitable for Meat and Seafood
- Suitable for Medical or Laboratory Use

Technical specifications

Model	DW40W-200	DW40W-300	DW40W-400	DW40W-500
Size ,mm	940*680*850	1270*680*850	1530*680*850	1900*680*850
Temperature Range, °C	≤-40°C	≤-40°C	≤-40°C	≤-40°C
Net volume,L	200	310	400	500
40"HQ Loading (sets)	105	80	66	

Specifications subject to change without notice

1 piece foaming Glass Door Freezer & Chiller Plug In



Product Features

- Premium Glass Door Chillers and Freezers
- Elegantly Presented
- Intelligent digital temperature control
- Matching Chiller and Freezer models
- 4 Adjustable shelves per Door
- LED Internal Lighting
- Energy Efficient 70mm CFC free Insulation
- 1,2 and 3 Door models
- Options include Light Boxes



Technical specifications

Model	AGR1-600-LB	AGR2-1200-LB	AGR3-1800-LB	AGF1-600-LB	AGF2-1200-LB	AGF3-1800-LB
Size ,mm	600*770*2010	1200*770*2010	1800*770*2010	600*770*2010	1200*770*2010	1800*770*2010
Temperature Range, °C	2~8°C	2~8°C	2~8°C	≤-18°C	≤-18°C	≤-18°C
Net volume,L	550	1100	1500	550	1100	1500
Doors	1	2	3	1	2	3

Specifications subject to change without notice

Overhead Combined Island Freezer Plug In



Product Features

- Display and Chest Freezer Combination
- LED Internal Lighting
- Insulated Swing doors above with three adjustable Shelves
- Reach in Freezer Below with sliding left to right glass lids
- Hi Vision Display Panel
- Elegant Black Colorbond Finish

Technical specifications



AZP25

Model	AZD08	AZD09	AZD18C2	AZD18C3	AZP21	AZP25
Size ,mm	2115*1100*2390	2502*1100*2390	2115*1100*2390	2502*1100*2390	2115*1100*2390	2502*1100*2390
Temperature Range, °C	≤-18°C	≤-18°C	≤-18°C	≤-18°C	≤-18°C	≤-18°C
Net volume,L	420+570	640+760	420+570	640+760	420+570	640+760
Upper Doors	3	4	3	4	3	4

Specifications subject to change without notice

Product Description for Convenience Stores

Best Partner for You



Slim Open Showcase Remote



Product Features

- Attractive Modular Space Saving Design
- Dual Air Curtain for optimal Performance
- LED Lighting on Each Shelf
- Display Light Box
- Retractable Night Blinds as Standard
- Suitable for Meat and Produce -2c ~ 2c
- Remote Refrigeration and drainage required
- Optional products stopper

Technical specifications

Model	LFK092WS-M03	LFK122WS-M03	LFK183WS-M03	LFK244WS-M03	LFK275WS-M03
Size ,mm	915*760*1915	1220*760*1915	1830*760*1915	2440*760*1915	2745*760*1915
Temperature ,°C	2-8°C	2-8°C	2-8°C	2-8°C	2-8°C
Net volume,L	460	610	960	1220	1410

Specifications subject to change without notice

Slim Open Showcase Plug In

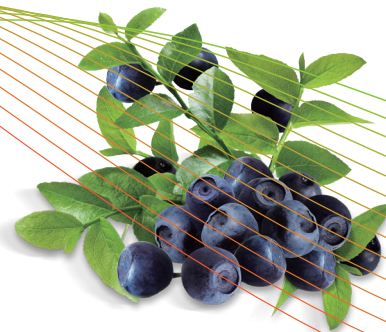

Product Features

- Attractive Modular Space Saving Design
- Dual Air Curtain for optimal Performance
- LED Lighting on Each Shelf
- Display Light Box
- Retractable Night Blinds as Standard
- Temp range 3~8c
- Intelligent Digital Controller
- Optional products stopper

Technical specifications

Model	AMDKS-905	AMDK-980	AMDK-1285	AMDK-1895	AMDK-2500
Size ,mm	905*600*1400	980*760*1915	1285*760*1915	1895*760*1915	2500*760*1915
Temperature ,°C	3~8°C	3~8°C	3~8°C	3~8°C	3~8°C
Net volume,L	300	400	530	800	1060

Specifications subject to change without notice

Slim Glass Door Freezer & Chiller Remote

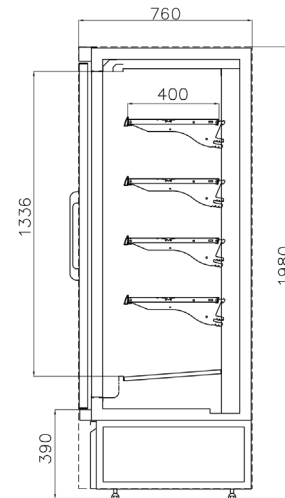

Product Features

- Intelligent digital temperature control
- Large maximum vision Insulated Doors
- To reduce condensation and energy consumption
- Brilliant LED Internal Lighting
- Digital Temp Display
- Remote Units require drainage



Technical specifications

Model	LBF2DAM7	LDF2DAL7	LBF3DAM	LDF3DAL7
Size ,mm	1447*760*1915	1447*760*1915	2160*760*1915	2160*760*1915
Temperature , °C	2~8°C	-20±2°C	2~8°C	-20±2°C
Net volume,L	1150	1050	1700	1500
Doors	2	2	3	3

Specifications subject to change without notice

Slim Glass Door Freezer Plug-in & Remote

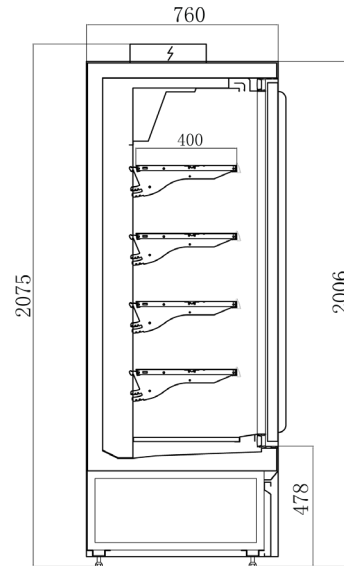

Product Features



- Attractive Modular Space Saving Design
- Unique Design Anti Fog Glass
- To reduce condensation and energy consumption
- Brilliant LED Internal Lighting
- Digital Temp Display and Controller
- Remote Units require drainage

Technical specifications

Model	LD0.8(F)	LD1.2(F)
Size ,mm	1350*760*2006/2075	1960*760*2006/2075
Temperature , °C	≤-18°C	≤-18°C
Net volume,L	500	700
Doors	2	3

Specifications subject to change without notice



Island Chiller

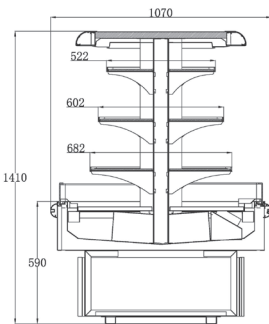

Product Features

- Suitable for fast moving Bread, Fruit, Vegetable and Beverages
- Multi Layers well Lit with Interior LED
- Adjustable shelf Angles and Levels
- May Require Drainage



Technical specifications

Model	HNF273H02
Size ,mm	1365*1055*1410*2
Temperature ,°C	5~10°C

Specifications subject to change without notice

Combined Island Freezer Plug In



Product Features

- Compact design Raised freezer Section
- Elegent Island Freezer under
- Display Light Box
- LED Internal Lighting

Technical specifications

Model	ZMD-700 (2 doors)	ZMD-800(3 doors)
Size ,mm	1200*800*2150	1470*800*2150
Temperature , °C	≤-18°C	≤-18°C
Net volume,L	320+375	360+430

Specifications subject to change without notice

Rear Replenishment Cold Room Remote



Product Features

- Modular Cold Room and Display Doors
- Perfect For ant Convenience store
- Walk in space
- Adjustable Shelving modules
- Requires Professional Assembly and installation
- Remote Refrigeration Required



Technical specifications

Model	TWQ-3G6H	TWQ-4G6H	TWQ-5G6H
Size ,mm	2280*2250*2300	2990*2250*2300	3800*2250*2300
Temperature ,°C	2180*2150*2200	2890*2150*2200	3700*2150*2200
Net volume,L	2~8°C	2~8°C	2~8°C
Doors	3	4	5

Specifications subject to change without notice



RAL international color chart



RAL 3020
Traffic Red



RAL 1018
Zinc Yellow



RAL 6018
Yellow Green



RAL 7040
Window Grey



RAL 9006
White aluminum



RAL 7024
Graphite Grey

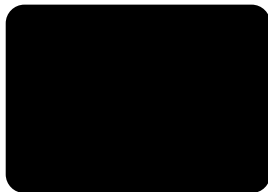

RAL 9005
Jet Black



RAL 9016
Traffic White