

24" DEEP BACK BAR COOLERS

EBB - Series



▲ E124BB(620)



▲ E146BB(620)



▲ E172BB(620)



▲ E226BB(620)

Cabinet Construction

- Heavy duty stainless steel countertop with textured laminate, black vinyl exterior.
- Galvanized steel interior walls and high quality stainless steel floor.
- 1 3/4" thick high density polyurethane insulation.
- Built-in caster thread receptacles for all models.

Refrigeration System

- Side mounted, self-contained and fully detachable Blizzard R290 condensing unit uses environmentally friendly, EPA-compliant R290 refrigerant with zero (0) Ozone Depletion Potential (ODP) and three (3) Global Warming Potential (GWP). Blizzard R290 is easily replaceable and requires no on-site brazing.
- Electronically commutated (ECM) fan motors achieve rapid cooling with less energy consumption.
- Full-length air duct system ensures optimal circulation of cold air.
- Time-initiated and temperature-terminated auto defrost cycle for seamless operation.
- Large capacity, corrosion-resistant condenser and evaporator coils.
- Self-maintaining, energy-efficient condensate drain pan requires no external drains or electric heaters.
- High performance, auto-reverse condenser fan motor supports compressor ventilation and condenser coil cleaning. Refer to owner's manual for full maintenance instructions.
- Pre-wired and ready to plug, 240V/50Hz/1Ph, 10Amp Australian Plug

Lighting

- Shielded LED bar lighting with on/off switch provides bright, high color illumination at lower heat output.

Doors

- Textured laminate, black vinyl exterior with galvanized steel interior.
- 1 3/4" thick high density polyurethane insulation.
- Snap-in magnetic door gasket make cleaning and replacement an easy process.
- High strength, recessed door handles.
- Pre-installed door locks keep your items safe from theft.

Shelving

- Two epoxy coated, steel wire shelves per section.
- Height adjustable stainless steel clips.

Temperature Control

- Multi-function digital controller with easy to read LED display.
- Factory preset temperature, 2°C
- Audible overheat protection alarm for compressor and condenser coil.

Options

- Additional shelving.
- 3" or 5" swivel casters with locks.
- 3.5" – 6" height-adjustable and interchangeable legs.



Dimensions

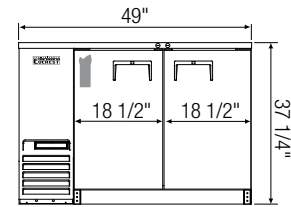
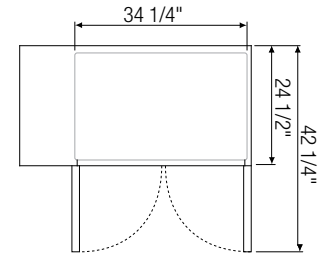
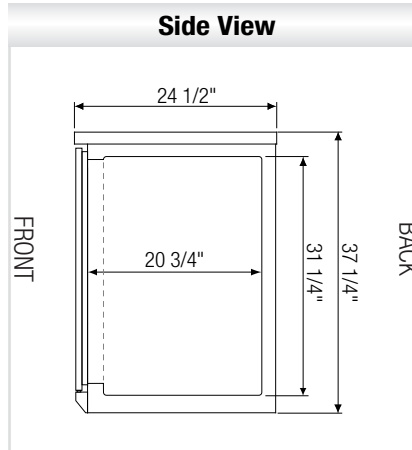
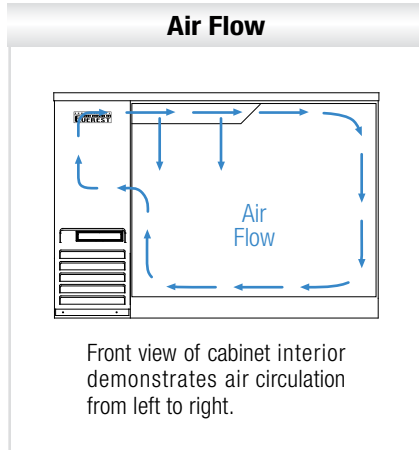

Equipped with 10Amp Australian Plug

▲ E124BB(620)

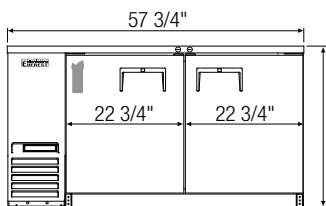
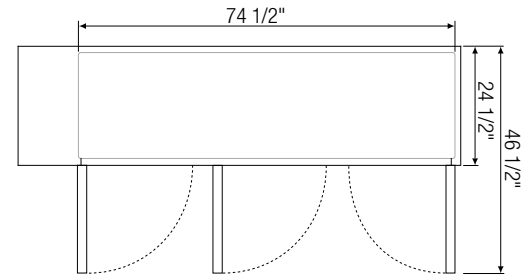
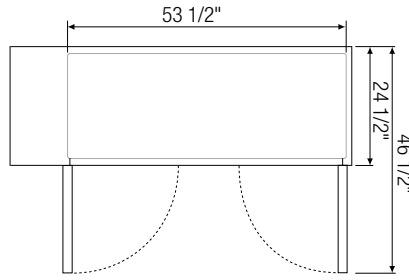
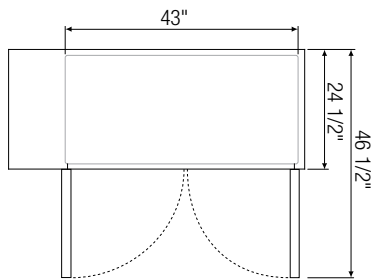

▲ E146BB(620)

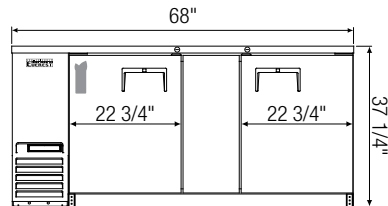

▲ E172BB(620)

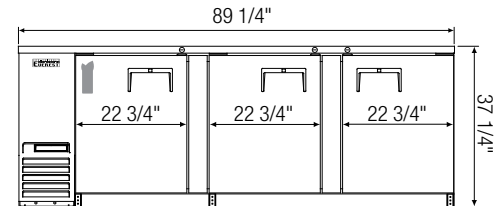

▲ E226BB(620)

Model	Ref/ Frz/ Dual	# of Doors	Shelves	Capacity (Cu. Ft.)	HP	BTU/HR †	Refrigerant	Capacity		Power (V-Hz-Ph)	Amps	Crated Weight (LBS)	Exterior Dimensions (Inches)		
								12 oz. Cans	12 oz. Bottles				L	D	H
E124BB(620)	Ref	2	4	13	1/4+	1,926	R290	420	294	240-50-1	3.5	262	49	24 1/2	37 1/4
E146BB(620)	Ref	2	4	17	1/4+	1,926	R290	560	357	240-50-1	3.5	274	57 3/4	24 1/2	37 1/4
E172BB(620)	Ref	2	4	20	1/4+	1,926	R290	700	441	240-50-1	3.5	301	68	24 1/2	37 1/4
E226BB(620)	Ref	3	6	28	1/3	2,311	R290	980	609	240-50-1	2.5	397	89 1/4	24 1/2	37 1/4

† : Based on evaporating temperature of 23°F (-5°C) & condensing temperature of 131°F (55°C).

Ref = Refrigerator

Specifications subject to change without notice.

Product dimensions are for general purposes and not absolute value. Product capacity (▶) is calculated based on standard industry figures. Slight variations may exist. If dimensions and capacity are critical, please contact Austune Refrigeration. Blizzard R290 replacement is at the sole discretion of Everest Refrigeration.



Please visit our website for updated Energy Efficiency information.