

BOTTOM MOUNT UPRIGHT REACH-IN DUAL TEMPS

Bottom Mounted Condensing Unit

EB - Series



▲ EBRF74-2



▲ EBRF126-2



▲ EBRF137-2



▲ EBRF190-3

Cabinet Construction

- Heavy duty stainless steel interior / exterior with rounded corners for a hazard-free workspace.
- Galvanized steel top, bottom and rear.
- 2.5" thick high density polyurethane insulation.
- Deeper cabinet interior for more storage options.
- Four 5" swivel casters with locks on front set Leg stabilizers standard for all models.

Refrigeration System

- Bottom mounted, self-contained and retractable condensing unit uses environmentally friendly R404A* refrigerant with zero (0) Ozone Depletion Potential (ODP) and EPA compliant R290 refrigerant with zero (0) Ozone Depletion Potential (ODP) and three (3) Global Warming Potential (GWP). R290 condensing units are replaceable and require no on-site brazing. *Ask about alternative refrigerant.
- PSC evaporator fan motors for R404A models. Electronically commutated (ECM) fan motors for R290 models.
- Airflow guard ensures optimal circulation of cold air. R290 models include full-length air duct system.
- Time-initiated and temperature-terminated auto defrost heater for R404A and R290 freezers. Air defrost for R290 refrigerators.
- Large capacity, corrosion-resistant condenser and evaporator coils.
- Self-maintaining, energy-efficient condensate drain pan requires no external drains or electric heaters.
- High performance condenser fan motors ensure efficient compressor ventilation. R290 models use auto-reverse condenser fan motors which also support condenser coil cleaning. Refer to owner's manual for full maintenance instructions.
- Pressure relief devices allow smooth access to cabinet interior when re-opening doors.
- Pre-wired and ready to plug, 240V/50Hz/1Ph, 10Amp Australian Plug

Lighting

- Energy efficient silicone coated and shatter-proof LED lighting provides bright, high color illumination with low heat output.

Doors

- Heavy duty stainless steel interior / exterior.
- 2.5" thick high density polyurethane insulation.
- Frame heaters prevent exterior moisture build up.
- Self-closing with adjustable torsion system for a positive seal.
- Snap-in magnetic door gasket make cleaning and replacement an easy process.
- High strength, recessed door handles.
- Pre-installed door locks keep your items safe from theft.
- Field reversible.

Shelving

- Epoxy coated, steel wire shelves (see table for quantity).
- Height adjustable stainless steel clips.

Temperature Control

- Multi-function digital controller with easy to read LED display.
- Factory preset temperature, 2°C for refrigerators and -20°C for freezers.
- R290 models include audible overheat protection alarm for compressor and

condenser coil.

Options

- Additional shelving.
- 3" swivel casters with locks.
- 3.5" – 6" height-adjustable and interchangeable legs.
- Left hinged door.



Dimensions

ABS Legs



Two additional front adjustable stainless steel clad ABS legs to provide extra stability when opening and closing door.

Vacuum Relief Mechanism



The vacuum relief valve equalizes cabinet pressure for rapid door re-entry.



Equipped with 10Amp Australian Plug

Side View

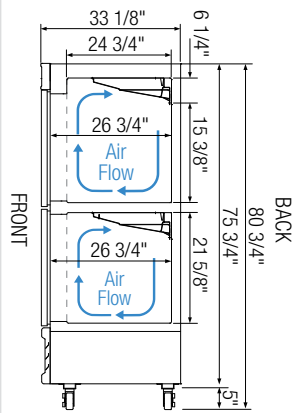

Side View

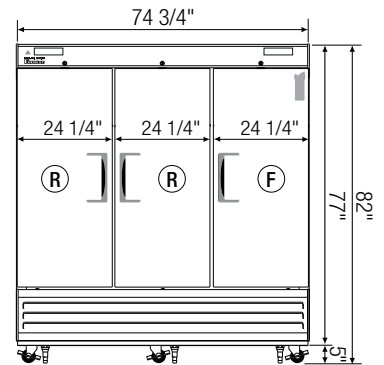
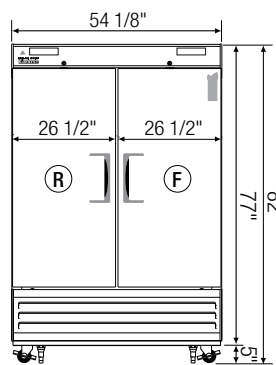
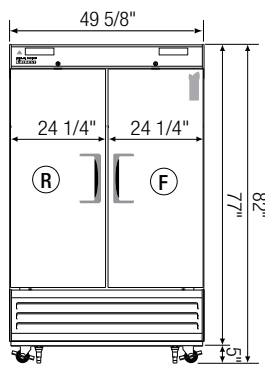
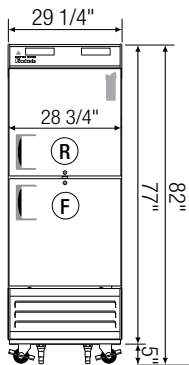
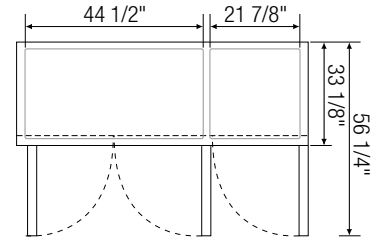
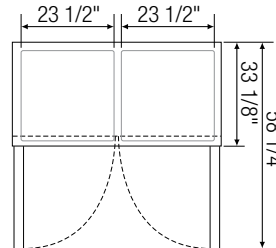
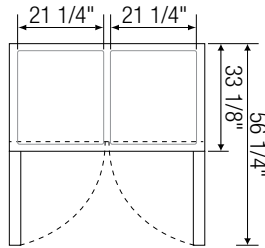
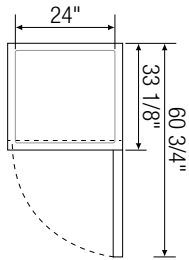
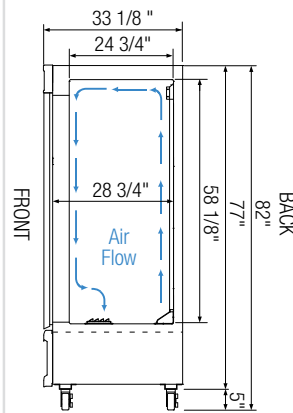

▲ EBRF74-2

▲ EBRF126-2

▲ EBRF137-2

▲ EBRF190-3

| Model | Ref/ Frz/ Dual | # of Doors | Capacity (Cu. Ft.) | HP | BTU/HR † | Refrigerant | # of Shelves | Power (V-Hz-Ph) | Amps | Crated Weight (LBS) | Exterior Dimensions (Inches) | | |
|-----------|----------------|------------|--------------------|---------------------|------------------------|------------------------------------|--------------|-----------------|-------|---------------------|------------------------------|--------|----|
| | | | | | | | | | | | L | D | H* |
| EBRF74-2 | Dual | 2 (H) | 11 (R) 11 (F) | 1/2 | 3,435 | R-404A / R290 [^] | 2 | 240-50-1 | 7.59 | 341 | 29 1/4 | 33 1/8 | 77 |
| EBRF126-2 | Dual | 2 | 22 (R) 22 (F) | 1/4+ (R) 1/2 (F) | 1,672 (R) 3,435 (F) | R290 R-404A / R290 [^] | 6 | 240-50-1 | 10.27 | 546 | 49 5/8 | 33 1/8 | 77 |
| EBRF137-2 | Dual | 2 | 24 (R) 24 (F) | 1/4+ (R) 1/2 (F) | 1,672 (R) 3,435 (F) | R290 R-404A / R290 [^] | 6 | 240-50-1 | 10.87 | 613 | 54 1/8 | 33 1/8 | 77 |
| EBRF190-3 | Dual | 3 | 46 (R) 22 (F) | 1/3+ (R) 1/2 (F) | 2,612 (R) 3,435 (F) | R290 R-404A / R290 [^] | 9 | 240-50-1 | 14.06 | 698 | 74 3/4 | 33 1/8 | 77 |

*: Height does not include 5" for casters.

†: Based on evaporating temperature of 23°F (-5°C) & condensing temperature of 131°F (55°C).

[^]: Contact factory for R290 information.

(R) = Refrigerator | (F) = Freezer
Dual = Ref & Frz Combo | (H) = Half Door

Specifications subject to change without notice.

Product dimensions are for general purposes and not absolute value. Product capacity (▶) is calculated based on standard industry figures. Slight variations may exist. If dimensions and capacity are critical, please contact Austune Refrigeration.

Blizzard R290 replacement is at the sole discretion of Everest Refrigeration.



Please visit our website for updated Energy Efficiency information.