

REFRIGERATION UNDERBENCH

3 DRAWER MODEL

FDU-1500

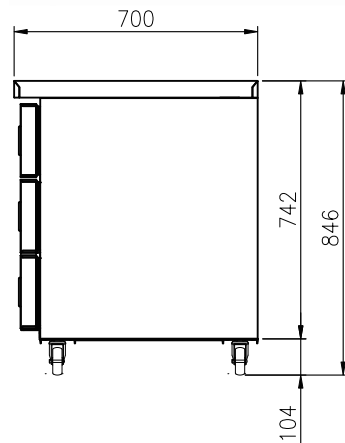
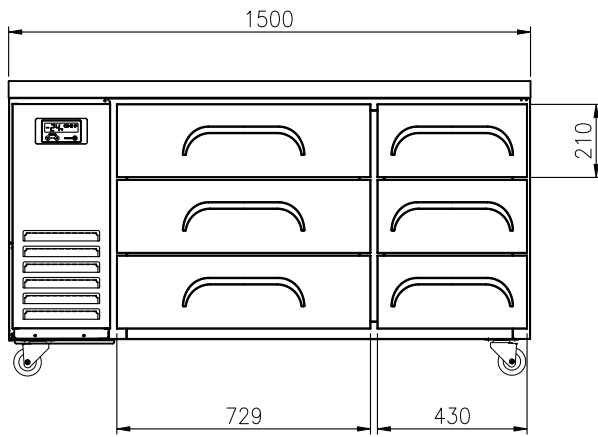
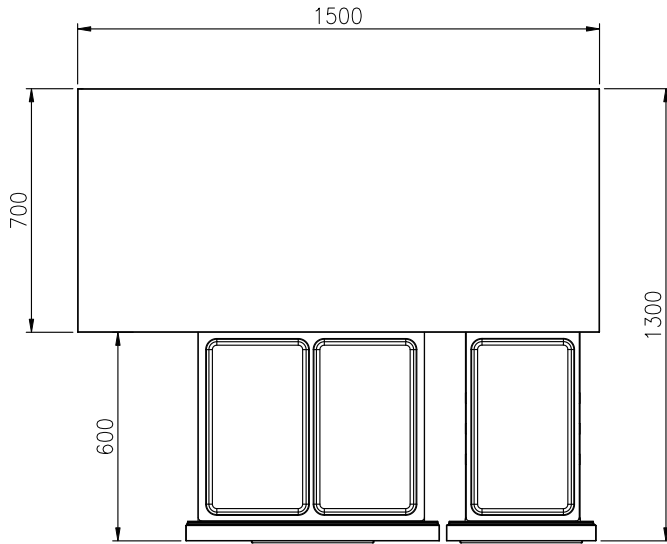

FEATURES

- Digital temperature control & monitor system
- 3" casters (brakes at front)
- Fully stainless steel finished cabinet
- PE coated sturdy wire shelves
- Auto-closing doors & stopper
- Door pressure release device
- Magnetic door gasket

Drawer Model

- Telescoping drawer slide
- Drawer can hold up to 30kg
- Accommodates 15cm deep pan (* pans are optional)

TEMPERATURE

- Fridge: 0°C ~ 5°C
- Freezer: -18°C

OPTIONAL MODELS

- Leg model
- 4" or 5" casters

Model	Capacity (ℓ)	Exterior Dimension (mm)			Net Weight (kg)	Gross Weight (kg)	Power Supply	Amps	Voltage (V/Hz/Ø)	Watt	HP	Refrigerant	No. Doors	No. Pans (1/1")
		W	D	H										
FDU-1500	388	1,500	700	845	120	128	10A	2.0	240/50/1	340	1/3	R-134a	6	9

* The heights include the caster (104mm) * D: Defrost
 * Design and specifications subject to change without notice
 * Actual shipping weight may differ due to extra packing materials for product protection.