



KARVER[®]
sailing experience



2024
ENGLISH CATALOG V.1

KARVER 

INTRODUCTION	P3
NEW PRODUCTS	P4/5
1 - REEFING FURLERS P6 to 11	
KRS NEW - INTRODUCTION	P6/9
KRS - RANGE	P10
2 - FURLERS P12 to 25	
KFV3 NEW - RANGE INTRODUCTION	P12/15
KF STANDARD	P16
KF ECOCONCEPT / RACING	P17
KF SINGLE LINE DRUM / WOOD VENEER.....	P18
KTS - TOP DOWN ADAPTOR	P19
KFX STRUCTURAL FURLERS	P20/21
KFO.9 / OPEN RINGS / SHEAVE FAIRLEADS	P22
KF OPTIONS	P23 to 25
3 - LOCKS P26 to 33	
KARVERPEDIA	P27
KFH - EXTERNAL FURLING LOCKS	P28/29
KMH - INTERNAL LOCKS	P30
KHL - EXTERNAL LOCKS	P31
KHR - REEF LOCKS	P32
KMS - MAINSAIL LOCKS	P33
4 - BLOCKS & SHEAVES P34 to 47	
KBO - UNIVERSAL LASHING BLOCKS	P36/37
KBO - SPECIAL BLOCKS & SOFT SHACKLES	P38/39
KB - ROUND BLOCKS	P40
KBR RACING BLOCKS - RANGE INTRODUCTION	P41/45
KDS & KDSB - SHEAVES & SHEAVE BOXES	P46
KR - KRO & KRTI - LOW FRICTION RINGS	P47
5 - DECK EQUIPMENTS/JAMMERS P48 to 57	
KJ - HIGH LOAD JAMMERS	P50/51
KW - WINCHLESS - NEW KJSK	P52
KJ2/3 & KSC - CAM CLEATS & BASES	P53/54
KJH - JAWS HANDLES	P55
KORG - HIGH LOAD ORGANIZERS	P56
KOMINO & KSO - ORGANIZERS	P57
6 - WINCHES P58 to 65	
KSW - WINCHES SPEED RANGE	P60
KPW - WINCHES POWER RANGE	P61
KCW - WINCHES COMPACT RANGE.....	P62
KWH - CARBON WINCH HANDLES	P63
KARVERPEDIA / TESTIMONIES	P64/65
7 - MAST TRACKS & CARS P66 to 80	
KMS FOCUS (GAFF LOCK, FUSE...)	P70 to 73
KMS30/KMS40/KMS60/KMS80/KMS100	P74 to 80
WOOD RANGE	P81
KARVER & THE ENVIRONMENT	P82
NEWS CONTACT	P83

NEW PRODUCTS

If you've been cut off from the world in recent months, here are the latest Karver releases.

KRS NEW REEFING FURLERS

Our most faithful customers have been waiting for 20 years a Karver Reefing furler.

The KRS is an eco concepted beautiful, robust and sustainable reefing furler. A full option reefing furler easy to install and use. KRS the reefing furler by KARVER.



KJSK - STAY SAIL JAMMER KIT

This kit consists of a 3:1 purchase and our famous KJC jammer. Fast and easy stay sail installation.

Deck remains clean once your sail is stored.

DAME
SPECIAL MENTION
2022



KF V3 ECO CONCEPT... TO FOLLOW

A furler with less impact for our planet: swap carbon by linen/wax fiber. Bio sourced plastic and sustainable stainless steel toggle plates.

Available for KF1.5 large, KF3.0 large, KF4.5 and KF6.0.

eco
ECOCONCEPT
by KARVER



LOW FRICTION RINGS KR

Friction is by definition performance enemy, but in many circumstances a low friction ring can deliver excellent services.

A complement to our open rings and titanium ones.



THE OFFSHORE RACING CORNER

If we develop cruising products we do not forget that we come from a racing background.

Specialists will appreciate: Structural furler drum with integrated cunningham, titanium version of the KF Racing and "Ultime" version of the KFH hook: Lighter, more compact and stronger, adapted to faster hook operation.



FREE 3D FILES

A concept more than a product: We offer for free 3D files in our library for simple and useful products.

Available on our website.



NEWS 2021, 2022 & 2023

This is not 100 % new anymore, but those products are now on the market for less than 3 years. Check them now!



▶ Glow in the dark KJH



▶ Aluminum open ring KRO



▶ Carbon Winch Handle KWH

AND ALWAYS OUR EXTRAORDINARY 4-SPEED WINCHES

KCW - KSW - KPW. If you are tired of struggling with your winches or looking for an easy way to gain a few lengths at each tack.



**A SIMPLE, ROBUST, DESIGN
AND EFFICIENT PRODUCT.**

REEFING FURLERS

1



KRS

Headsail reefing furlers

by **KARVER** 

SIMPLICITY AND ROBUSTNESS, DESIGN AND PERFORMANCE.

Our products are known to be the most reliable on the market. we have thousands and thousands of miles of experience on the forces submitted to the deck equipment.

We took our time to design a new generation of reefing furlers combining a multitude of advantages without forgetting our DNA: a simple, robust, design and efficient product.



+ PRODUCT

A full-option reefing furler accessible to all.

+ Performance

- Reduced mechanical dimensions: drums as slim as a reefing furler, shortest swivel on the market
- Very low friction maintenance free sealed bearings
- Attach tack and halyard points with textile ties
- Reduced weight
- Reinforced mechanism as standard
- Tube profile reinforced with 6082T6
- Materials Insulation against corrosion

+ Built-in options

- Elliptical and double groove profile as standard
- Removable single line drum as standard
- Removable stainless steel luff guide as standard

+ Eco Concept

- Robust design ensures durability
- Compact = less raw material consumption
- Use of bio-sourced plastic, from linen fibre

THE KARVER REEFING FURLER IN DETAIL:

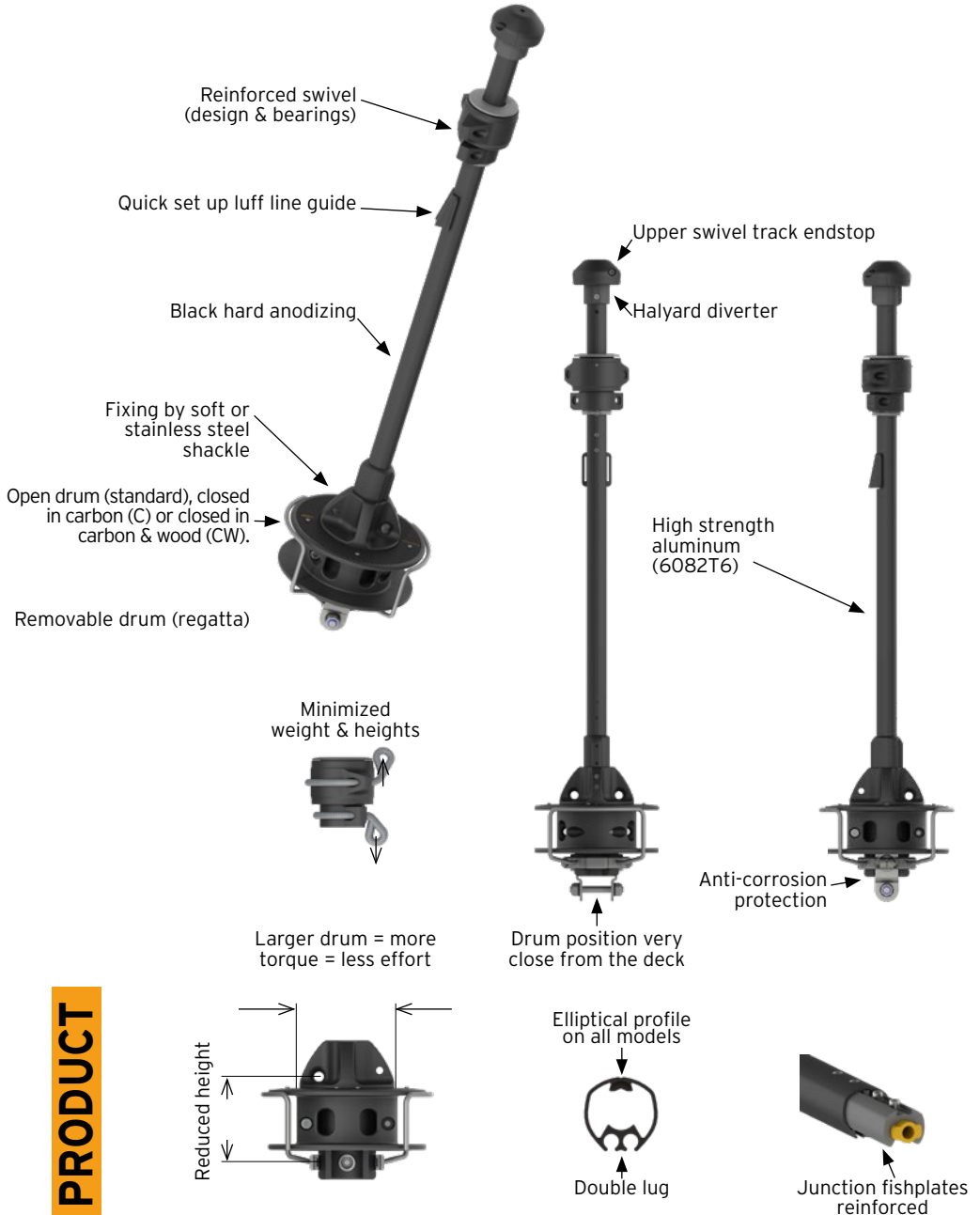

+ PRODUCT

A simple range, just as efficient for cruising and racing, 6 models for sailboats from 7 to 26 m.

We want to get rid of distinctions between "racing" reefing furlers or "cruise ". The expectations in terms of reliability or performance are the same. Whatever your program, Karver reefing furlers are your allies of choice.

Unlike what is currently proposed on the market, all these options are included as standard when you choose Karver:

- Double groove extrusion profile
- Elliptical profile
- Removable drum
- Removable stainless steel luff guide
- Black hard anodizing
- Reinforced mechanism



Standard...

+ PRODUCT

Stand out!

To better fit your deck plan, we offer a variety of finishings on the top of the drum, as well as the standard finish being in carbon fibre, it can also be linen fibre or natural wood veneer.

For the most demanding users, stainless steel wire guide can be upgraded with the option of a carbon drum, and can also be offered with a real wood veneer finish.

We can also personalize the drum cover with the name or logo of your sailboat.



Standard version
+ wooden veneer on top (W)



Carbon closed drum version (C)



Carbon closed drum
+ wooden veneer (CW)

A model for each unit

MODEL	KRS20	KRS25	KRS30	KRS40	KRS45	KRS50
References	PF333 200	PF333 250	PF333 300	PF333 400	PF333 450	PF333 500
Sailboat length (m)	7 à 9	9 à 10,5	10,5 à 13	13 à 16	16 à 20	20 à 26
Sail area in m ²	30	45	55	100	150	220
Max forestay diameter without removable end fitting (mm)	6	8	8	10	14	14
Forestay diameters max. with removable end fitting (mm)	7,5	10	10	13	20	20
Available lower pin diameter (mm)*	10,12,14	12,14,16	12,14,16,19	16,19,22,25	19,22,25,28	25,28,32,35
Joiner bearing max space (mm)**	7,5	8,5 ou 10,5	8,5 ou 10,5	11 ou 13,5	16,5 ou 20,5	16,5 ou 20,5
Width between plates	41	41	41	41	61	61
Drum diameter (mm)	180	180	220	260	320	320
Foil model	KP29	KP33	KP33	KP40	KP54	KP54R
Foil external diameter (mm)	29	33	33	40	54	54
Foil weight (Kg/m)	0,578	0,708	0,708	0,965	1,29	1,59
Delivered foil length (m)*	10,5	12,5	14,5	16,5	18,8	20,8
Luff line diameter (mm)	5	5	5	5	6	6
Elliptical double groove foil	Yes	Yes	Yes	Yes	Yes	Yes
Removable drum	Yes	Yes	Yes	Yes	Yes	Yes
Luff line guide	Yes	Yes	Yes	Yes	Yes	Yes
Long and intermediate plates	Optional	Optional	Optional	Optional	Optional	Optional
Turnbuckle cover	Optional	Optional	Optional	Optional	Optional	Optional
Closed carbon drum version	Optional	Optional	Optional	Optional	Optional	Optional

* including short lower extrusion

**Bold = delivered as standard. Change at no extra cost on request.

Selection guide

Three parameters to define your choice.

Forestay diameter, boat length and sail area.

Length (m)	6	7	8	9	10	11	12	13	14	15	16	17	18	19	20	21	22	23	24	25	
Length (feet)	20	23	26	30	33	36	40	43	46	50	53	56	59	63	66	69	73	76	79	83	
Forestay max																					
KRS20	6/7,5																				
KRS25	8/10																				
KRS30	8/10																				
KRS40	10/13																				
KRS45	14/20																				
KRS50	14/20																				
Genoa area (m ²)		15	20	25	30	40	50	55	60	75	90	100	115	130	140	150	160	170	180	200	210
Genoa area (ft ²)		160	215	270	320	430	540	590	645	810	970	1080	1240	1400	1500	1600	1700	1830	1940	2150	2260

**ONE
STEP
AHEAD**



PERFORMANCE NOW RHYMES WITH EASE, AESTHETICS, PRICE AND ECO-RESPONSIBILITY.

FURLERS

2



Standard



EcoConcept



Racing

Single line version and Wood / Classic finishing
available for all our models.

NEW GENERATION* OF FURLERS. THE PATH FINDER... IS KARVER!

KF^{V3}*

For the 3rd time in 18 years, we are very proud to present a new range of furlers 100% faithful to our DNA: INNOVATION - PERFORMANCE - DESIGN.

We designed the first furler with a patented composite material continuous line wheel. In addition to performance, price and aesthetics, this major innovation allows us to offer for the first time a much more virtuous furlers for the environment.

On the strength of our know-how started more than 15 years ago with linen blocks, all our plastics will be replaced over time by bio-sourced plastics and we are offering an "EcoConcept" version where we replace carbon with linen fiber and also more virtuous mirror-polished stainless steel forks. An identity and strong values accessible to all.



Everything is there for this new furler to quickly become the global market benchmark.

** 3rd generation of Karver furlers.*

3 PRE-DEFINED VERSIONS... OR À LA CARTE

Example of the different versions of the KF1.5



STANDARD



ECO CONCEPT



RACING



REGISTER YOUR FURLER ON OUR WEBSITE AND BENEFIT FROM AN ADDITIONAL YEAR OF WARRANTY

Several Imoca, Class 40 and Figaro 3 have tested this new model for several months. We are sure of our product and give you an additional year of warranty if you register your furler on our website.



THE BENCHMARK FURLER

10 reasons to choose a Karver furler



(1) **Carbon wheel & Kevlar®** or linen fibers / Kevlar® patented. Strong innovations and a unique identity.



New (2) **Captive fast pins** more ergonomic and reliable.



(7) **Automatic Lock** of the standard continuous line wheel and (8) **Karver high performance bearings**. Performance and ease of use.



EcoConcept (9) process to reduce the environmental impact of our products.



New (3) **Design** even more robust and allowing easy disassembly.



New "K Krok"
(4) **Impact-resistant protections** on the swivel and the drum.



New division of the range: 1.5, 3.0, 4.5, 6.0, 8.0, 10, 12... and up to 50T. KF1.5 and 3.0 available in (5) **large versions** for less effort. The right model for the right use (6) **at the right price**.



New (10) **Snap shackle** 2 in 1 compact and resistant "**K Snap**": snap shackle + 2: 1 hoist as standard on the Cruise and Classic version. Easy orientation.

+ PRODUCT

- The furler is a lightweight, removable system for installing an additional fore sail and furling it from the cockpit.
- A furled sail is easier to handle and can be comfortably stored in a locker.
- The same furler can usually be used for several types of sails: gennakers, stormsails, staysails and more recently on asymmetrical spinnakers the operation safety is total.
- The continuous line wheel has been designed to prevent trapping your fingers or letting the line slip through your hands. There is, however, enough room for the line to pull out of the way during quick unwind.

Online support

The choice of furler model depends on the boat, sail and use.

On our website, this pictogram guides you to our new tool which will help you choose the right furler model for your sailboat. Over 2000 models are listed.



Furler recommendation for cruising yachts

If you don't have internet access, this simplified table should help. For special cases or simply if in doubt, do not hesitate to contact us.

BOAT LENGTH	STRUCTURAL	STAYSAIL	CODE 0	GENNAKER	ASY SPINNAKER
< 32'	KFX0.9/KFX1.5	KF1.5	KF0.9 / KF1.5	KF0.9 / KF1.5	KTS1.5
Max 32'	KFX3.0	KF1.5	KF1.5	KF0.9 / KF1.5	KTS1.5
Max 42'	KFX4.5	KF3.0	KF3.0	KF1.5 / KF3.0	KTS3.0
Max 52'	KFX6.0	KF4.5	KF4.5	KF4.5	KTS4.5
Max 65'	KFX8.0	KF8.0	KF8.0	KF6.0	KTS8.0
Max 95'	KFX14.0	KF12.0	KF12.0	KF8.0	KTS12.0

> 95'

Contact us

KF

KF^{EC}

KF^R

KF^X

Options included for each version	Standard	EcoConcept	Racing	Structural
Patented carbon & Kevlar® continuous line wheel	✓		✓	✓
Patented linen & Kevlar® continuous line wheel		✓		
Automatic anti-return lock removable without tools	✓	✓	✓	✓
K Krok swivel protection	✓	✓	✓	✓
K Krok single line protection	✓	✓		✓
3:1 friction sheave on captive fast pin			✓	
2 in 1 snap shackle K Snap: Snap + tackle 2 falls	✓	✓		
Carbon drum casing			✓	
Stainless steel fork		✓		✓
Secured structural bolted pins				✓

In the box



Drum



Swivel



Automatic lock as standard



User manual



Storage bag

Not in the box: thimble, furling line, anti torsion cable... and sail!

KF PURE SIMPLICITY!

Cruisers or racers, KF furlers simplify your operations.



© Karver Systems

KF Standard

+ Performance

- Extremely light.
- Unequally compact.
- Low friction bearing.
- KF1.5 and KF3.0 available in large version for more power.

+ Value for money

- The largest number of innovations and features on the market.
- A fierce desire to offer the best of technology at the best price.



For almost 20 years our furlers have been on board performance sailing yachts. Available for 20 feet cruisers up to 150 feet Super Yachts.

Never has a furler presented so many advantages.

DESCRIPTION	PART NUMBER*	WORKING LOADS	DRUM DIAMETER	FURLING LINE	SERIAL LOCK
KF0.9	PF350 000	0.9 T	85 mm	6 mm	NO
KF1.5	PF300 150	1.5 T	120 mm	6 mm	YES
KF1.5 Large	PF300 150 [L]	1.5 T	160 mm	8 mm	YES
KF3.0	PF300 300	3 T	160 mm	8 mm	YES
KF3.0 Large	PF300 300 [L]	3 T	195 mm	10 mm	YES
KF4.5	PF300 450	4.5 T	195 mm	10 mm	YES
KF6.0	PF300 600	6 T	220 mm	10 mm	YES
KF8.0	PF300 800	8 T	220 mm	10 mm	YES
KF10.0	PF300 1000	10 T	220 mm	10 mm	YES
KF12.0	PF300 1200	12 T	220 mm	10 mm	YES

SUPER YACHTS & MAXIS: Furlers from 14 to 50 T custom. Please ask us.

* Each part number includes a drum and a swivel. Contact us for your specific projects



KF^{EC}

EcoConcept

+ Environment

- Use of sourced organic materials.
- Use of linen fibers instead of carbon.
- Less environmental impact.
- Longer life.

+ Benefits

- No loss of performance.
- No higher price.
- Identical guarantee.

Karver has taken concrete actions since 2005 to reduce the environmental impact of our products. The EcoConcept version of our KF is the best in the field with the use of linen fibers in the continuous line wheel and in all plastics.

The molded stainless steel forks prevent material waste and extend service life.



KF^R

Racing

+ Efficiency

- Quick fitting mechanism for the sail thanks to captive fast pins.
- Quick installation system of the furling line.
- Very low friction bearings by Karver.
- Automatic unhooking of the furling line for ultra fast unwinding.

+ Safety feature

- Drum locking mechanism control from the cockpit (Patented).
- Breaking load over twice the safe working load.
- Swivel lightness prevents impact on the mast when hoisting/lowering the sail.

A "full" carbon version of our KF: continuous line wheel + casing. The forks are made of aluminum for more lightness. The 3:1 friction sheave is suitable for bowsprit or the use of locks..

Add the extension [R] to the part numbers to order a Racing version or [EC] for the EcoConcept version.

KF 2 OPTIONS THAT WILL MAKE THE DIFFERENCE

Whatever model you choose, transform the look of your furler.



The single line option is often preferred for structural furlers or low overlap sails.

KF

SINGLE LINE DRUM OPTION

+ Benefits

- Only one rope run on the deck. Less friction in the operation.
- Aesthetics.
- The insertion of the fork in the drum makes the whole very compact.
- A simple and reliable system.



The continuous line wheel in composite materials makes it very easy to add a natural wood veneer to make your furler even more beautiful.

KF

NATURAL WOOD VENEER OPTION

+ Benefits

- Unique aesthetics.
- No performance loss.
- Use of natural wood.
- Perfect marriage with sailboats fitted with a teak deck.

KTS FURL ALSO YOUR ASY. SPINNAKER

Simply connect to your furler.



© Karver Systems

The KTS (Karver Tack Swivel) is a top down adaptor that enable to convert a bottom-up furler into a top-down unit.

The KTS can remain on the sail. In this case, the furler can be stored or remain on the bow to be used with other sails.

The KTS is an alternative to the Spinnaker sock. It allows easy control from the cockpit and considerably reduces the weights at the top of the mast.

Product references on page 24

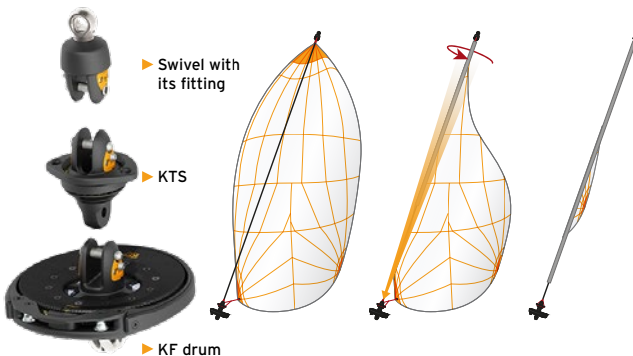

? HOW DOES IT WORK?

Top down furlers

- The tack of the spinnaker is fixed on the swivel of the KTS.
- Unlike a classic sail (gennaker), the anti torsion is outside the luff and has 2 uses: be a winding support and make the connection between the top and down part of the furler.
- Since the tack is fixed on a swivel, the furling starts from the top.

KF^x HIGH TECHNOLOGY STRUCTURAL FURLER!

The furler holds the mast and remains in place.



► KF6.0
continuous line wheel version



© Hudson Yachts HH66

Present on all high-performance racing or cruising sailboats, the structural furler replaces the traditional reefing furlers.

It is an ultimate compromise between performance and safety. It is used with a textile anti torsion forestay. Like a furler, the sail cannot be reduced and reefed.

Range available for sailboats from 6 to 50 m.



► KF6.0
single line version



Structural

+ Benefits

- Extremely light.
- Unequally compact.
- Low friction bearing.

KARVERPEDIA

Read the article "Differences between a reefing furler and a flying furler".



**Compared
to a reefing furler,
a structural furler
is around
8 times lighter!**

Characteristics

DESCRIPTION	PART NUMBER	WORKING LOADS	DRUM DIAMETER	INTERFACE CODE LOCK
KFX0.9	PF350 000 [X]	0.9 T	85 mm	X
KFX1.5	PF300 150 [X]	1.5 T	120 mm	X
KFX1.5L	PF300 150 [XL]	1.5 T	160 mm	X
KFX3.0	PF300 300 [X]	3 T	160 mm	PF094026
KFX3.0L	PF300 300 [XL]	3 T	195 mm	PF094026
KFX4.5	PF300 450 [X]	4.5 T	195 mm	PF084428
KFX6.0	PF300 600 [X]	6 T	220 mm	PF084428
KFX8.0	PF300 800 [X]	8 T	220 mm	PF110600
KFX10.0	PF300 1000 [X]	10 T	220 mm	PF030600
KFX12.0	PF300 1200 [X]	12 T	220 mm	PF030600

SUPER YACHTS & MAXIS: Furlers from 14 to 50 T custom. Please ask us.

Hoist & drop your sail with a KFX

Racing yachts fitted with a structural furler attach their sail directly to the swivel. To avoid climbing the mast, however, we have designed a simple external lock system fixed to an interface between the forestay and the swivel.

This system is installed on several efficient cruising catamarans. Smaller units can also use a halyard swivel.



2 ways to fix your sail on a structural swivel



KF^{0.9} THE SMALLEST FURLER EVER DESIGNED BY KARVER

A Karver concentrate at an unbeatable price!
Fast pins, snap shackle, protections... everything is here!

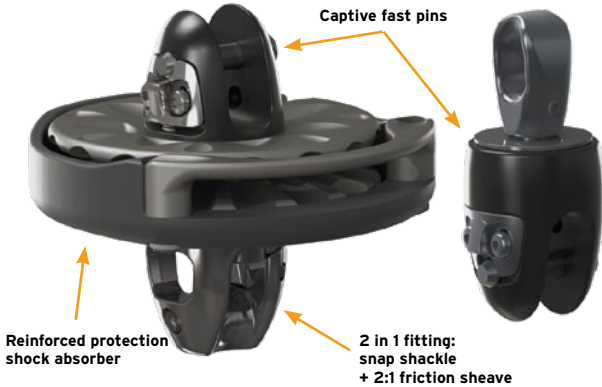

© Karver Systems

The KF0.9 can be used for all sails up to approx. 40m² and 900 kg of working load.



OPEN RINGS & SHEAVE FAIRLEADS

Friction is the enemy of performance.

2 new accessories are dedicated to reducing the friction of the furling line.

KRO open rings to perfectly align the furling line.

- The opening allows a very fast installation
- Ultra versatile ring: stanchion line lead, barber-haulers...



DESCRIPTION	PART NUMBER	SWL (T)	DIAM. EXT	INNER DIAM	ATTACHED	MAX PASSAGE.
KRO6	PF102 6738	0,6	28,4 mm	12 mm	4,5 mm	6 mm
KRO8	PF102 6735	1	36,4 mm	15 mm	6 mm	8 mm
KRO10	PF102 6740	1,5	46 mm	19 mm	7,5 mm	10 mm
KRO12	PF102 6741	2	53 mm	22 mm	9 mm	12 mm

Low friction sheaves fairlead

(For KF1.5 wide, KF3.0, KF3.0 Large and KF4.5).

- Easy to install kit.
- Used by many Figarists.



OPTIONS THIMBLES & CLAMPS

Details and knowledge make the difference.

The thimble create the link between the sail, its anti torsion and the furler. A perfect fit is a guarantee of performance and durability. We offer 3 types of thimbles:

Standard thimbles for sails with anti torsion in the luff.

- Compact & light.
- Aluminum machined in hard anodized mass.



DESCRIPTION	PART NUMBER	ANTI TORSION MAX	PIN DIAMETER	TRACK HEIGHT
KF0.9 Thimble (stain.)	PF310 8129	9 mm	6	
KF1.5 Thimble	PF350 150	11 mm	8	14
KF3.0 Thimble	PF350 300	14 mm	10	18
KF4.5 Thimble	PF350 450	16 mm	12	20
KF6.0 Thimble	PF350 600	16 mm	12	20
KF8.0 Thimble	PF350 800	18 mm	14	24

Trick: If your sail is fitted with a simple stainless steel ring, we recommend choosing our EcoConcept furler fitted with molded stainless steel forks.

Cableless thimbles for all new sails without anti torsion

- Design made with the largest sailmakers.
- Compatible with all furlers on the market.
- Compact, light (aluminum) and without edges.



DESCRIPTION	PART NUMBER	PIN DIAMETER	BUSHING OPTION*	TRACK HEIGHT
KF1.5 Cableless	PF106 460	8	X	10
KF3.0 Cableless	PF096 461	10	X	14,5
KF4.5 Cableless	PF086 462	12	10	18
KF6.0 Cableless	PF086 462	12	10	18
KF8.0 Cableless	PF116 463	14	12 or 16	23
KF10.0 Cableless	PF036 460 [18]	18	16 or 20	21,6
KF12.0 Cableless	PF036 460 [20]	20	18 or 22	21,6

Cableless thimbles can be ordered as a top and down set with the extension [T&D] or only one of the 2: Thimble for the tack, use the extension [D]. Thimble for the swivel, use the extension [T] Example: Cableless tack KF6.0 code = PF 350 600 [D]

*On request, we deliver adapter rings for larger or smaller pins Cableless thimbles for furlers up to 50T are available on request.

Our new KRE clamps are both a clamp and a thimble.

They are exclusively dedicated to downwind sails (130 ° to 180 ° to the wind).

- 2 in 1 clamp.
- Quick installation with a simple allen key.
- Adjustable on board the sailboat.



FEATURES & CODES OF SWIVEL FURLER SETS

	KF0.9	KF1.5	KF1.5 Large	KF3.0	KF3.0 Large	KF4.5	KF6.0	KF8.0	KF10	KF12
SAILBOAT SIZE RECOMMENDATION*	20 - 30'	25 - 35'	25 - 40'	30 - 40'	30 - 45'	40 - 55'	50 - 60'	55 - 65'	60 - 80'	70 - 100'
WORKING LOAD & BREAKING LOAD	0.9 - 1.8 T	1.5 - 3 T	1.5 - 3 T	3 - 6 T	3 - 6 T	4.5 - 9 T	6 - 12 T	8 - 16 T	10 - 20 T	12 - 24 T
CONTINUOUS LINE WHEEL DIAMETER	87	120	160	160	195	195	220	220	220	220
FAST PINS DIAMETER	6	8	8	10	10	12	12	14	18	20
FORK WIDTH	11,4	14,6	14,6	18	18	20	20	24	22,2	22,2
FURLING LINE DIAMETER	6	6	8	8	10	10	10	10	10	10
KF STANDARD VERSION	PF350 000	PF300 150	PF300 150 [L]	PF300 300	PF300 300 [L]	PF300 450	PF300 600	PF300 800	PF300 1000	PF300 1200
KF^{EC} VERSION ECOCONCEPT	X	PF300 150 [EC]	X	PF300 300 [EC]	X	PF300 450 [EC]	PF300 600 [EC]	PF300 800 [EC]	PF300 1000 [EC]	PF300 1200 [EC]
KF^R RACING VERSION	X	PF300 150 [R]	PF300 150 [RL]	PF300 300 [R]	PF300 300 [RL]	PF300 450 [R]	PF300 600 [R]	PF300 800 [R]	PF300 1000 [R]	PF300 1200 [R]
KF^X STRUCTURAL VERSION	PF350 000 [STRUCT]	PF300 150 [X]	X	PF300 300 [X]	X	PF300 450 [X]	PF300 600 [X]	PF300 800 [X]	PF300 1000 [X]	PF300 1200 [X]

CODES FOR MAIN OPTIONS

	KF0.9	KF1.5	KF1.5 Large	KF3.0	KF3.0 Large	KF4.5	KF6.0	KF8.0	KF10	KF12
Standard thimble (black) x 1 Ø Anti-torsion max	X	PF310 8129 9 mm	PF350 150 11 mm	PF350 300 14 mm	PF350 300 14 mm	PF350 450 16 mm	PF350 600 16 mm	PF350 800 18 mm	PF034742[18] 17 mm	PF034742 17 mm
Cableless thimble (tack) x 1 For the swivel thimble: replace [D] par [T]	X	PF106 460 [D]	PF106 460 [D]	PF096461 [D]	PF096461 [D]	PF086462 [D]	PF086462 [D]	PF116463 [D]	PF036460 [18D]	PF036460 [20D]
Ready-to-use furling line *	X	PF101231 [D6L16]	PF091232 [D8L16]	PF091232 [D8L20]	PF081233 [D10L26]	PF081233 [D10L26]	PF081233 [D10L26]	PF081233 [D10L32]	PF081233 [D10L42]	PF081233 [D10L50]
Karver Open Ring / line lead	X	PF102 6738	PF102 6738	PF102 6735	PF102 6740	PF102 6740	PF102 6740	PF102 6740	PF102 6740	PF102 6740
KTS (Adapter for easy spinnaker)	X	PF100 022	PF340 150	PF340 300	PF340 300	PF340 450	PF340 600	PF340 800	PF340 1000	PF340 1200
Lock KFH (instead of the standard swivel) Add [KFH] for a single lock	X	X	PF320 150	PF320 300	PF320 300	PF320 450	PF320 600	PF320 800	PF320 1000	PF320 1200
3:1 friction sheave (instead of K-Snap or eye) KFR	X	X	PF317 150	PF317 300	PF317 300	PF317 450	PF317 600	PF317 800	PF317 1200	PF317 1200
3:1 additional sheave	X	X	PF314 150	PF314 300	PF314 300	PF314 450	PF314 600	PF114 226	PF034 787	PF034 787

FOLLOWING

	In series on...	KF0.9	KF1.5	KF1.5 Large	KF3.0	KF3.0 Large	KF4.5	KF6.0	KF8.0	KF10	KF12
Optional 2:1 block (instead of the lash eye.)		X	PF330 150	PF330 150	PF330 300	PF330 300	PF330 450	PF330 600	PF330 800	PF330 1000	PF330 1200
Single line version		X	PF305 150	X	PF305 300	X	PF305 450	PF305 600	PF305 800	PF305 1000	PF305 1200
Additional aluminum swivel Add [SS] for stainless steel version		X	PF300 152	X	PF300 302	X	PF300 452	PF300 602	PF300 802	PF300 1002	PF300 1202
Remove lock of continuous line wheel (capital loss)		X	PF382 150 [NO]	PF382 150 [NO]	PF382 150 [NO]	PF382 150 [NO]	PF382 450 [NO]	PF382 450 [NO]	X	X	X
K Snap (instead of 3:1)	KF, KFEC	X	PF316 150	PF316 150	PF316 300	PF316 300	PF316 450	PF316 600	X	X	X
Carbon drum housing (instead of ABS)	KFR	X	PF380 150	PF380 300	PF380 300	PF380 450	PF380 450	PF380 600	PF380 800	PF380 1000	PF380 1200
ABS housing (instead of carbon)	KF, KFEC, KFX	X	PF381 150	PF381 300	PF381 300	PF381 450	PF381 450	PF381 600	PF381 800	PF381 800	PF381 800
Wood veneer of the continuous line wheel	X	X	PF385 150	PF385 300	PF385 300	PF385 450	PF385 450	PF385 600	PF385 800	PF385 1200	PF385 1200
Wood veneer of the carbon housing	X	X	PF383 150	PF383 300	PF383 300	PF383 450	PF383 450	PF383 600	PF383 800	PF383 800	PF383 800
Stainless steel drum fork (instead of alu)	KFEC, KFX	X	PF384 150	X	PF384 300	X	PF384 450	PF384 600	PF384 800	PF384 1000	PF384 1200

* L12 = Loop x 6 m. Other lengths available.



KARVER: THE LOCK SPECIALIST!

LOCKS

3



KFH

Furling lock



KMH

Internal halyard lock



KHL

External halyard lock



KMS

Headboard car lock



KHR

Reef lock

KARVER: THE LOCKING SPECIALIST

KARVER[®]PEDIA

Choosing the right sailing hardware can improve your boat's performance. The latest equipment is **lighter, takes less room and is more efficient** - it is now able to block and lock heavy loads.

Every lock mechanism aims to incorporate these benefits by replacing ropes with mechanical devices. Today's fabrics are more and more advanced (3DL, Titanium, Laminated...) to help reduce the overall weight of the sail and maintain its shape thus minimising power loss due to its distortion. To benefit from the power of this type of sail, it is important to minimize the possible stretch of the lines. Installing a lock, regardless of the brand and technology, makes it possible to avoid a halyard stretch thus releasing the full power of the sails.

Besides this mechanical concept, the diameter of the halyard can be reduced as it no longer carries the load of the sail when sailing. For example, a 12mm halyard in Dyneema[®] could be replaced by a 6mm halyard.

The difference from a standard KF drum is the addition of an independent swivel on the top which helps keep the system light.

The installation of a halyard lock reduces the compression in the mast, as the halyard is no longer strained. For high performance sailing yachts, locks may help reduce the weight aloft as rigs can be designed to bear minimal compression. Every kilo saved in the rigging can allow the removal of several tens of kilos in the bulb.

It would be a mistake to think that these advantages are only for the racing scene. Weight gain in the highs can also translate into better stability: it decreases the amplitude of roll and pitch in heavy seas. Wouldn't you appreciate getting ashore a few hours or days earlier, without worrying about damage to the halyards?

Our locking solutions:



100% of the Imoca fleet use at least one of our locking devices.
70% use our KFH and furlers.

KFH FURLING LOCKS SWIVEL

Less stretch, less wear, more performance.



© Karver Systems

+ Safety

- Once "locked", the halyard is no longer under tension. The compression in the mast is halved and halyard wear is minimised.

+ Light weight

- Removal of the 2:1 optional block the luff is pulled from the bottom of the drum with a block, eliminating the need for a 2:1 halyard set up.
- It is also possible to use a smaller and lighter halyard as it carries only the weight of the sail.

+ Performance

- Once "unlocked", only the lightest part of the system remains at the top of the mast. The swivel and the lock are on the deck, easy to maintain.



The KFH halyard locks have been tried and tested for many years in the world's toughest oceans. 70% of the last Vendee Globe yachts have used this lock!

Halyard stretch is a major factor in the loss of performance in upwind sails.

The KFH eliminates stretch and creep ensuring your halyard is at perfect hoist everytime and also reduces mast compression. The KFH combines a lock and a swivel to be used with a furling drum.

Application examples:

CODE SAILS/LIGHT GENOA

As most standard sailing yachts do not include a mast fitted with 2:1 halyard purchase for foresails, it is easier to have a powerful code sail or light genoa using an accurate setting.

STAYSAIL

A better solution than a fixed forestay. The sail can be furled and easily stored, leaving the foredeck uncluttered and for the genoa.

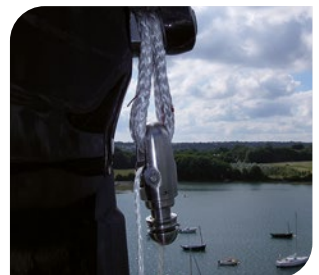

© Karver Systems

? HOW DOES IT WORK?

To lock

Lift up to the stop then take up the tension from below. The furling-lock becomes a standard top swivel: Just unfurl and enjoy your sail.

To unlock

Simply pull on the halyard again to max hoist. The sail can now be lowered.



MODEL	PART NUMBER KFH ONLY	PART NUMBER KFH OPTION	WEIGHT (Kg)	OVERALL (mm)	SAFE WORKING LOAD (T)	PASSAGE MAX.* (mm)
KFH1.5	PF320 150 [KFH]	PF320 150	0.313	131.3	1.5	5
KFH3.0	PF320 300 [KFH]	PF320 300	0.674	160.9	3	7.5
KFH4.5	PF320 450 [KFH]	PF320 450	0.670	175.1	4.5	7.5
KFH6.0	PF320 600 [KFH]	PF320 600	1.112	174.4	6	9.5
KFH8.0	PF320 800 [KFH]	PF320 800	1.078	174.7	8	9.5
KFH8.0 TI	PF320 800 [KFHTi]	PF320 800 [Ti]	0.888	173.1	8	10
KFH10.0	PF320 1000 [KFH]	PF320 1000	2.190	217.3	10	11
KFH12.0	PF320 1200 [KFH]	PF320 1200	2.400	219.4	12	11

SUPER YACHTS & MAXIS: Furlers from 14 to 50 T custom. Please ask us.

** Maximum available space. ** Best halyard diameter before splicing.

The “KFH Option” part number should be added to your furler part number if you want us to replace the standard swivel with a KFH lock.



► 3 jaws take up the load over 360°



► Option KFH+ : KFH lock replace standard swivel



KMH INTERNAL HALYARD LOCK FOR HEADSAILS

Simple and aesthetic.

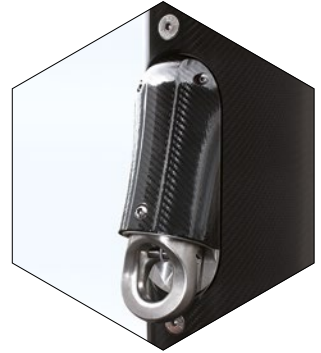

© Karver Systems

+ Benefits

- The locking mechanism can be removed without tools as soon as the cover is opened.
- Compact & Light.
- Essential for racing yachts, super yachts and long cruiser yachts.
- No trip line. Use with the halyard.
- No high load strope.
- Perfect to lock a spinnaker snuffer during a long navigation.

Easy maintenance.

The KMH internal halyard lock is a locking device for headsails installed by mast manufacturers.

This mechanism is integrated into the mast and allows maximum luff length.



MODEL	PART NUMBER	SAFE WORKING LOAD (T)	WEIGHT (Kg)	PASSAGE MAX* (mm)	IDEAL HALYARD** (mm)	MAST CUT (mm)
KMH2	PF370002	2	0.370	6.4	6	83 x 26
KMH5	PF370005	5	1.230	9.5	6	44 x 125
KMH8	PF370008	8	2.070	10.5	8	56 x 156
KMH10	PF370010	10	2.800	10.5	8	75 x 175

SUPER YACHTS & MAXIS: Furlers from 14 to 50 T custom. Please ask us.

* Maximum available space. ** Best halyard diameter before splicing.

KHL EXTERNAL LOCK (WITHOUT SWIVEL FUNCTION)

Multiple applications.



© Karver Systems

+ Benefits

- Compact & Light.
- Essential for Racing yachts, Super Yachts and cruising yachts.
- No additional order: use with the halyard.
- No high load strope.
- Perfect to lock a spinnaker snuffer during a long navigation.

The KHL external lock is an easy to install lock for headsails. It removes tension from the halyard to prevent wear and elongation. It can also be used as a mainsail reef lock.

The halyard jammer will no longer be used.

MODEL	PART NUMBER	SAFE WORKING LOAD (T)	WEIGHT (Kg)	OVERALL (mm)	MAX PASSAGE* (mm)	IDEAL HAL-YARD** (mm)
YACHTS						
KHL2	PF480020 [KHL]	2	0.435	117.7	7.5	6
KHL3	PF485859	3	0.475	173.0	7.5	6
KHL5	PF470020 [KHL]	5	0.850	172.2	9.5	6
KHL8	PF410020 [KHL]	8	0.620	166.3	9.5	6
KHL10	PF400020 [KHL]	10	2.090	217.7	11.0	8
KHL12	PF400020 [KHL12]	12	1.550	217.7	11.0	8
SUPER YACHTS						
KHL16	PF400020 [KHL16]	16	-	-	-	-
KHL20	PF400020 [KHL20]	20	-	-	-	-
KHL25	PF570020 [KHL25]	25	-	-	-	-
KHL30	PF440030	30	-	-	-	-

* Maximum available space. ** Best halyard diameter before splicing.

KHR REEF LOCK

The end of excessive reef lines lenght.



© Karver Systems

A complete range for cruising, racing and Super Yachts to deal with the problems of reef breakage (too much load, too many friction points or jammers that slip).

These locks make it lighter due to a reduction in strapping and avoid reef line stretch.

HISTORICAL

Designed for ORMA trimarans, redesigned for MOD70s, locks are more and more present on ocean cruisers and Super Yachts.

MODEL	PART NUMBER	SAFE WORKING LOAD (T)	WEIGHT (Kg)	MAXIMUM AVAILABLE SPACE (mm)	BEST LINE (mm)	LOOP* (mm)	MATERIAL
YACHTS							
KHR1	PF0265276	1	0.067	5.5	5	13	ALU
KHR2	PF0263125	2	0.188	6.2	5.50	19	ALU
KHR4	PF0263440	4	0.299	9	7	20	ALU
KHR5	PF0263414	5	0.488	10	6	24	ALU
KHR8	PF0264562	8	0.660	11.2	7	24	ALU
KHR10	PF0263222	10	0.834	10	6	20	ALU
KHR6+	PF0263440 [INOX]	6	0.884	9	7	20	STAINLESS STEEL
KHR8+	PF0263414 [INOX]	8	1.442	10	8	24	STAINLESS STEEL
KHR12+	PF0264022 [INOX]	12	2.200	10	8	28	STAINLESS STEEL
SUPER YACHTS							
KHR15+	PF0263388	15	-	-	-	-	STAINLESS STEEL
KHR20+	PF0264856 [INOX]	20	-	-	-	-	STAINLESS STEEL
KHR25+	PF0264857 [INOX]	25	-	-	-	-	STAINLESS STEEL
KHR30+	PF0264858 [INOX]	30	-	-	-	-	STAINLESS STEEL

All models can also be ordered in titanium.

* Max high load loop (not provided) to install on the mainsail leech (1 on each reefing eye).

KMS LOCKED HEADBOARD CAR

Used by racers for over fifteen years.



© Karver Systems

+ Benefits

- Compact & Light.
- External and /or internal remote.
- Optional electronic position sensor.
- Many finishes available (lashing, hinge, ...).

Locking a mainsail is a common solution on many racing yachts, Super Yachts, and offshore cruising yachts.

TECHNOLOGY ADAPTED TO THE LOAD

We supply a headboard car featuring a lock for the whole KMS product line. Depending on the load requirements and the yacht size, the "locking system" would be activated with one or two inserts (in red) into the track or with two locks on the side for the bigger units.

Part numbers and characteristics available in the KMS section (p62/76).

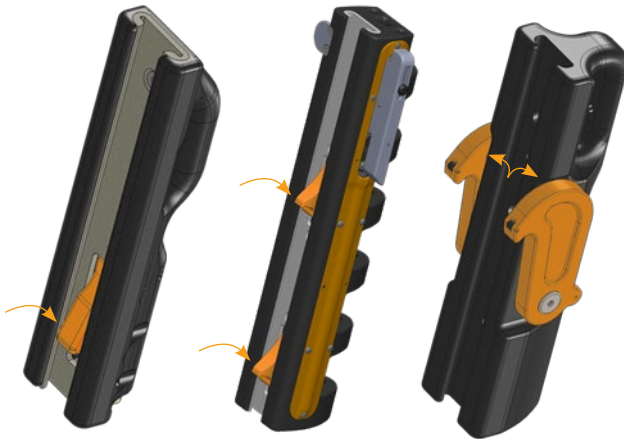

▶ 1 lock in the rail
30 to 70 feet.

▶ 2 locks in the rail
60 to 120 feet.

▶ One lock on each side
of the track.
110 to 200 feet.

LASHING BLOCKS FAST ATTACHMENT FOR PERFORMANCE AND SAFETY

BLOCKS AND SHEAVES

4



KBO

Rope lashing blocks



KB

Versatile blocks



KBR

High load blocks

WHY CHOOSE KARVER'S BLOCKS?



► SAFETY FEATURE

The evolution of modern textiles has made it possible to replace metal anchors by ropes of much higher resistance.



► LOW FRICTION

Karver high load blocks with very low friction (titanium and ceramic bearings) are the lightest and most efficient on the market.



► DESIGN

The design of Karver blocks has been simplified as much as possible in order to be accessible to all sailors, regattas and cruise passengers.



► UNIVERSAL

Karver now offers the widest range of lashing blocks for boats from 2 to 70 meters.

MODEL	KBO	KB	KBR
SIDE PLATES	KBO1 to 8: Plastic + fibers KBO10 to 50: Aluminum	KB6 and KB8: Plastic + fibers KB10 to KB12: Aluminum	Carbon/Aluminum/ Stainless steel
SIDE BALL BEARINGS	POM from KBO8	NO	Ceramic
CENTRE ROLLER BEARINGS	PEEK®	PEEK®	Titanium
ROPE SHACKLE INCLUDED	Up to KBO30	Option	Option
LEATHER OR WOOD OPTION	NO	NO	YES
FRICTION RATIO	5 to 7%	5 to 7%	2%
INSTALLATION	Easy	Rope-work required	Rope-work required
DOUBLE AND TRIPLE OPTION	Up to KBO8	With link	NO
WEIGHT TO MWL RATIO	**	*	***
COST TO MWL RATIO	**	***	*

KBO ROPE LASHING BLOCKS

Sail lighter!



© Karver Systems

The rope shackle will never break due to the load or rust over the years.

KBO lashing blocks have the best size to weight ratio on the market. The KBO reconciles all sailors with the textile binding: it is easier to install a KBO than a block mounted on a standard steel shackle !

+ Fast attachment

- The rope shackle is included with the block up to KBO30.

+ Simplicity

- Easy fitting from the lashing guide and rope shackle attachment simplifies the use of the KBO block.

+ Lightweight

- The design and material optimisation make the block extremely light.

+ Performance

- The KBO block incorporates side balls (from KBO8) and central rollers. The coefficient of friction is minimum.



© Karver Systems



► KBO10 bearings

KB01 to KB08 > Composite plastic cheeks



MODEL	PART NUMBER	SAFE WORKING LOAD(T)	WEIGHT (Kg)	ROPE MAX. (mm)	IDEAL ROPE (mm)	DIAM. SHEAVES (mm)	ROPE SHACKLE
KB01 SINGLE	PF830030	0.15	0.010	6	5	22.5	MP551865
KB02 SINGLE	PF790030	0.22	0.026	8	7	32	MP551701
KB04 SINGLE	PF650030	0.40	0.028	8	7	32	MP551701
KB06 SINGLE	PF800030	0.60	0.047	10	9	38	MP551148
KB08 SINGLE	PF890030	0.85	0.080	12	11	47	MP551148
KB01 DOUBLE	PF830030 [D]	0.25	0.018	6	5	22.5	MP553117
KB02 DOUBLE	PF790030 [D]	0.35	0.050	8	7	32	MP553119
KB04 DOUBLE	PF650030 [D]	0.65	0.066	8	7	32	MP553319
KB06 DOUBLE	PF800030 [D]	0.95	0.103	10	9	38	MP553121
KB08 DOUBLE	PF890030 [D]	1.30	0.148	12	11	47	MP553123
KB01 TRIPLE	PF830030 [T]	0.35	0.025	6	5	22.5	MP553118
KB02 TRIPLE	PF790030 [T]	0.45	0.072	8	7	32	MP553120
KB04 TRIPLE	PF650030 [T]	0.90	0.084	8	7	32	MP553120
KB06 TRIPLE	PF800030 [T]	1.30	0.148	10	9	38	MP553122
KB08 TRIPLE	PF890030 [T]	1.80	0.213	12	11	47	MP553124

KB010 to KB050 > Aluminum cheeks



KB010	PF660030	1.2	0.083	12	11	52	MP551148
KB015	PF670030	1.8	0.143	14	13	63	MP551149
KB020	PF680030	2.6	0.186	14	13	74	MP551149
KB020 LARGE	PF680030 [L]	2.6	0.244	16	2 x 10	74	MP551150
KB030	PF690030	3.5	0.334	16	15	97	MP551150
KB050	PF810030	5	0.610	18	17	123	X

From KB010 to KB050, it's now possible to order them as snatch block version.

KB010 SNATCH	PF660030 [OP]	1.2	0.083	12	11	52	MP551148
KB015 SNATCH	PF670030 [OP]	1.8	0.143	14	13	63	MP551149
KB020 SNATCH	PF680030 [OP]	2.6	0.186	14	13	74	MP551149
KB030 SNATCH	PF690030 [OP]	3.5	0.334	16	15	97	MP551150
KB050 SNATCH	PF810030 [OP]	5	0.610	18	17	123	X

KBO^{FB} FOOT BLOCK

Minimum dimensions.



© Karver Systems

Karver technology is screwed to the deck!

MODEL	PART NUMBER	SAFE WORKING LOAD (T)	WEIGHT (Kg)	ROPE MAX. (mm)	IDEAL STRING (mm)	DIAM. SHEAVES (mm)
KB02FB	PF790030 [FB]	0.22	0.025	8	7	32
KB04FB	PF650030 [FB]	0.40	0.027	8	7	32
KB06FB	PF800030 [FB]	0.60	0.046	10	9	38
KB08FB	PF890030 [FB]	0.80	0.080	12	11	47
KB010FB	PF660030 [FB]	1.20	0.114	12	11	52
KB015FB	PF670030 [FB]	1.80	0.196	14	13	63
KB020FB	PF680030 [FB]	2.60	0.261	14	13	74
KB030FB	PF690030 [FB]	3.50	0.482	16	15	97

KBO^W RATCHET BLOCK

Reversible.



© Karver Systems

It doesn't matter which way you pass the line through the block! Attached through the centre, the Karver ratchet block is the only block in which the ratchet can work in either direction.

MODEL	PART NUMBER	SAFE WORKING LOAD (T)	WEIGHT (Kg)	ROPE MAX. (mm)	DIAM. SHEAVES (mm)
KBO^w RATCHET BLOCK	PF760030	0.3	0.073	10	55

KBO^J TRIPLE BLOCK + CAM CLEAT

Lighter purchase systems.



© Karver Systems

Unique: Transfixed by its center, this 6-fall hoist incorporates a jam cleat whose inclination is adjustable without tools.

MODEL	PART NUMBER	SAFE WORKING LOAD (T)	WEIGHT (Kg)	ROPE MAX. (mm)	DIAM. SHEAVES (mm)
KB06J TRIPLE + CAM CLEAT	PF800030 [TKJ3]	0.8	0.348	10	38
KB06J + KB06T	PF800030 [TKJ3T]	0.8	0.496	10	38

Delivered with or without the triple block.

KRS ROPE SHACKLE 4T

Modern solution.



© Karver Systems

MODEL	PART NUMBER	SAFE WORKING LOAD (T)
ROPE SHACKLE 4T	MP551701	0.5
ROPE SHACKLE 4T	MP551148	1
ROPE SHACKLE 4T	MP551149	2
ROPE SHACKLE 4T	MP551150	4
HIGH LOAD STROP + T-BONE	PF084853 [SS]	5
HIGH LOAD STROP + T-BONE	PF110040 [SS]	8
HIGH LOAD STROP + T-BONE	PF030040 [SS]	12
HIGH LOAD STROP + T-BONE	PF034854 [SS]	16

KB ORIGINAL ROUND BLOCKS

Simplicity and design.



© Karver Systems

+ Light weight

- Compared to traditional blocks (at equal working load), the use of a soft attachment through the centre of the block reduces weight up to 50%.

+ Versatility

- With the use of lashing materials, multiple attachments are possible when installing the block (e.g. Backstay systems), or even just to tie it up (eg. to prevent capsizing).

+ Safety feature

- If the sheave breaks, the circulating rope is captive to the transfilage. Although the block no longer ensures the circulation of the rope, the rope linkage point of attachment of the block remains.

Simple, reliable and efficient, the Karver KB block leaves free choice as to fixing and offers extreme safety.

Multiple possibilities:

- KB: Roller bearings adapted for general usage.
- KBc: Self-lubricating plain bearings, KBc blocks are ideal for applications when the line is required to run under a very high load for a short distance (backstay, cunningham, boom vang, outhaul, etc).



MODEL	PART NUMBER	SAFE WORKING LOAD (T)	WEIGHT (Kg)	ROPE MAX. (mm)	DIAM. SHEAVES (mm)	LINK REF
KB6	PF190030 [GRISE]	0.22	0.020	6	30	PL191142
KB8	PF040030 [GRISE]	0.60	0.051	10	35	PL040774
KB10	PF020030	1.00	0.086	10	46	PL021143
KB12	PF180030	1.40	0.119	12	54	PL181094
KB8C	PF040031	0.80	0.044	8	33	PL041089
KB10C	PF020031	1.90	0.096	10	46	PL022210
KB12C	PF180031	3.00	0.167	12	56	PL182211

KB blocks are not provided with a soft shackle.



HIGH LOAD BLOCKS RANGE

The KBR range features our high load lashing blocks (from 1.5T and up to over 40T). Built with our low friction technology, it is dedicated to racers and Super Yachts. Available in 3 different materials: carbon, aluminum, and stainless steel. The carbon version can be covered with a wood or leather veneer. No matter which one you choose, your block will always feature:

- A reliable and resistant block design to handle high loads.
- A very low friction bearing mechanism under load.
- Titanium sheaves, a two-stage bearing technology with rollers in titanium and balls in ceramic.
- An anti-capsizing design.
- An enlarged inner diameter to enable multiple attachments through the center.



KBR^C

Carbon



KBR^{SPECIALS}

Extra large, wood, leather



KBR^A

Aluminum



KBR^{OP}

Snatch blocks



KBR^M

Stainless steel

KBR^C HIGH LOAD BLOCKS

The highest performing block on the market.



KBr⁸⁰

SAFE
WORKING LOAD
8T

WEIGHT
385g!



Hetairos © Karver Systems

+ Performance

- Low friction ratio even under very high load (Titanium bearings).

+ Light Weight

- Design optimisation and high tech component use make the KBR the lightest roller bearing block on the market.

+ Compact

- The Titanium bearing system (Karver patent) ensures that the blocks hold high loads on smaller diameter sheaves.

2% friction, carbon fibre, ceramic and titanium.

The new design avoids any possible block breakage. The closed structure prevents the block from being crushed.

MODEL	PART NUMBER	SAFE WORKING LOAD (T)	WEIGHT (Kg)	ROPE MAX. (mm)	DIAM. SHEAVES (mm)
YACHTS					
KBRC10	PF330000 [C]	1	0.076	12	45
KBRC15	PF330001 [C]	1.5	0.090	12	49
KBRC30	PF330002 [C]	3	0.097	12	49
KBRC50	PF330003 [C]	5	0.175	14	64
KBRC65	PF330005 [C]	6.5	0.280	16	75
KBRC80	PF330007 [C]	8	0.385	18	89
SUPER YACHTS					
KBRC105	PF330009 [C]	10.5	0.557	18	102
KBRC130	PF330012 [C]	13	0.800	20	115
KBRC160	PF330016 [C]	16	1.080	20	135
KBRC180	PF330018 [C]	18	1.350	22	147
KBRC250	PF330025 [C]	25	2.017	30	160
KBRC300	PF330030 [C]	30	3.620	35	180
KBRC400	PF330040 [C]	40	4.980	40	206

KBR^{CX} KBR^{CW} KBR^L SPECIAL HIGH LOAD BLOCKS

One concept. Several variations.



Because our clients always ask for more, here are several variations of our famous KBRC.

This should satisfy yachties in the quest of beauty and special solutions.

		KBRC X	KBRC W	KBRC L
SAFE WORKING LOAD (T)	DIAM. SHEAVES (mm)	EXTRA LARGE	WOOD	LEATHER
YACHTS				
1.5	49	NO	PF330001 [CW]	PF330001 [CL]
3	49	PF330002 [CX]	PF330002 [CW]	PF330002 [CL]
5	64	PF330003 [CX]	PF330003 [CW]	PF330003 [CL]
6.5	75	PF330005 [CX]	PF330005 [CW]	PF330005 [CL]
8	89	PF330007 [CX]	PF330007 [CW]	PF330007 [CL]
SUPER YACHTS				
10.5	102	PF330009 [CX]	PF330009 [CW]	PF330009 [CL]
13	115	PF330012 [CX]	PF330012 [CW]	PF330012 [CL]
16	135	PF330016 [CX]	PF330016 [CW]	PF330016 [CL]
18	147	PF330018 [CX]	PF330018 [CW]	PF330018 [CL]
25	160	PF330025 [CX]	PF330025 [CW]	PF330025 [CL]
30	180	PF330030 [CX]	PF330030 [CW]	PF330030 [CL]
40	206	PF330040 [CX]	PF330040 [CW]	PF330040 [CL]

Consult our website for the technical characteristics of these blocks.

KBR^A ALU HIGH LOAD BLOCKS

More traditional than its sister ship, the KBRa block feature side plates made of aluminum and a two stages bearing mechanism with titanium rollers and Torlon ball bearing for very low friction.



MODEL	PART NUMBER	SAFE WORKING LOAD (T)	WEIGHT (Kg)	ROPE MAX. (mm)	DIAM. SHEAVES (mm)
YACHTS					
KBRA30	PF330002 [AL]	3	0.139	12	49
KBRA50	PF330003 [AL]	5	0.227	14	64
KBRA65	PF330005 [AL]	6.5	0.323	16	75
KBRA80	PF330007 [AL]	8	0.494	18	89
SUPER YACHTS					
KBRA105	PF330009 [AL]	10.5	0.660	18	102
KBRA130	PF330012 [AL]	13	0.994	20	115
KBRA160	PF330016 [AL]	16	1.321	20	135
KBRA180	PF330018 [AL]	18	1.667	22	147
KBRA250	PF330025 [AL]	25	2.522	30	160
KBRA300	PF330030 [AL]	30	4.480	35	180
KBRA400	PF330040 [AL]	40	6.152	40	206

KBR^{OP} ALU SNATCH BLOCKS

The entire KBRa range is available as a snatch block. One of the side plates pivots from the centre to open. A self-gripping strap keeps the block closed.

Operating the block takes only a few seconds with the soft shackle.



MODEL	PART NUMBER	SAFE WORKING LOAD (T)	WEIGHT (Kg)	ROPE MAX. (mm)	DIAM. SHEAVES (mm)
YACHTS					
KBRA65 SNATCH	PF330005 [OP]	6.5	0.330	16	75
KBRA80 SNATCH	PF330007 [OP]	8	0.476	18	89
SUPER YACHTS					
KBRA105 SNATCH	PF330009 [OP]	10.5	0.630	18	102
KBRA130 SNATCH	PF330012 [OP]	13	0.964	20	115
KBRA160 SNATCH	PF330016 [OP]	16	1.291	20	135
KBRA180 SNATCH	PF330018 [OP]	18	1.637	22	147
KBRA250 SNATCH	PF330025 [OP]	25	2.492	30	160
KBRA300 SNATCH	PF330030 [OP]	30	4.450	35	180
KBRA400 SNATCH	PF330040 [OP]	40	6.122	40	206

KBR^M HIGH LOAD STAINLESS STEEL BLOCKS

A gem of performance.



© Karver Systems

+ Benefits

- All the benefits of the modern KBR block in a classic version.
- Reliability with minimum wearing and maintenance.
- Compact & light.
- Long life bearing.

The KBRm blocks feature the same low friction bearing technology as the KBR carbon. The side plates are made of polished stainless steel.

MODEL	PART NUMBER	SAFE WORKING LOAD (T)	WEIGHT (Kg)	ROPE MAX. (mm)	DIAM. SHEAVES (mm)
YACHTS					
KBRM15	PF330001 [M]	1.5	0.205	12	49
KBRM30	PF330002 [M]	3.0	0.223	12	49
KBRM50	PF330003 [M]	5.0	0.405	14	64
KBRM65	PF330005 [M]	6.5	0.644	16	75
KBRM80	PF330007 [M]	8.0	0.897	18	89
SUPER YACHTS					
KBRM105	PF330009 [M]	10.5	1.264	18	102
KBRM130	PF330012 [M]	13.0	1.830	20	115
KBRM160	PF330016 [M]	16.0	2.490	20	135
KBRM180	PF330018 [M]	18.0	3.105	22	147
KBRM250	PF330025 [M]	25.0	4.600	30	160
KBRM300	PF330030 [M]	30.0	8.300	35	180
KBRM400	PF330040 [M]	40.0	11.450	40	206

KDS SHEAVES

High load and low friction.

KDS sheaves feature a plain bearing for high working loads and ball bearings for lateral loads. The Karver sheave range offers a very low weight to working load ratio.



MODEL	PART NUMBER	PART NUMBER	SAFE WORKING LOAD (T)	WEIGHT (Kg)	ROPE MAX. (mm)	DIAM. SHEAVES (mm)	AXIS (mm)
KDS25	○ PF980025 [FP]	○ PF980025	2.5	0.098	12	65	12
KDS40	○ PF980040 [FP]	○ PF980040	4	0.266	18	80	16
KDS60	○ PF980060 [FP]	○ PF980060	6	0.419	24	100	26
KDS100	○ PF980100 [FP]	○ PF980100	10	0.703	26	113	32
KDS150	○ PF980150 [FP]	○ PF980150	15	1.382	28	160	60

KDSTi TITANIUM SHEAVES

The KDSTi is a combo between our KDS and KBR range. The KDSTi is perfect for applications where friction should remain to the minimum. All parts are machined from titanium.

The bearing mechanism is the same as the one featured for our KBR blocks (2% friction only, made possible by high precision machining and design of the titanium rollers).



KDSB SHEAVE BOXES

Our sheaves and sheave boxes are manufactured in aluminum alloy (6000 series), hard anodised, and they enable main, staysail and ORC halyards to go through with minimum friction.



MODEL	PART NUMBER	SAFE WORKING LOAD (T)	WEIGHT (Kg)	ROPE MAX. (mm)	DIAM. SHEAVES (mm)	AXIS (mm)
○ KDSB25	PF970025	2.5	0.279	12	65	12
○ KDSB40	PF970040	4	0.519	18	80	16
○ KDSB60	PF970060	6	0,967	24	100	26
○ KDSB100	PF970100	10	1.465	26	113	32
○ KDSB150	PF970150	15	2.904	28	160	60

Contact us for custom sheaves or sheave boxes.

LOW FRICTION RINGS

Strength and light weight.

Closed, opened, aluminum or Titanium, Karver low friction rings are high-performance alternatives and complements to our blocks and organizers.



KR ALUMINUM RINGS

MODEL	PART NUMBER	SAFE WORKING LOAD (T)	WEIGHT (g)	DIAM. EXT. (A mm)	DIAM. INT. (B mm)	THICKNESS (C mm)	GROOVE (mm)
KR7	PF102 0700	0,6	2	17,55	7	12	4
KR10	PF102 1000	1	6	25,4	11	16	7
KR15	PF102 1500	1,5	10	32,4	15	20	10
KR20	PF102 2000	3	36	47,9	21	20	15
KR30	PF102 3000	6	106	67,75	30	30	20
KR40	PF102 4000	12	332	96,75	40	32	30

KRO OPEN RINGS



MODEL	PART NUMBER	SAFE WORKING LOAD (T)	WEIGHT (Kg)	DIAM. EXT. (mm)	DIAM. INT. (mm)	ATTACHED (mm)	MAX. PASSAGE (mm)
KRO6	PF102 6738	0.60	0.49	28.4	12	4.5	6
KRO8	PF102 6735	1.00	0.33	36.4	15	6	8
KRO10	PF102 6740	1.50	0.15	46	19	7.5	10
KRO12	PF102 6741	2.00	0.08	53	22	9	12

KRTi TITANIUM RINGS

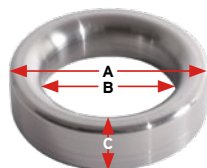

MODEL	PART NUMBER	SAFE WORKING LOAD (T)	WEIGHT (Kg)	DIAM. EXT. (A mm)	DIAM. INT. (B mm)	THICKNESS (C mm)
KRTi35	PL1024601	3.5	0.060	50	30	12
KRTi45	PL1024602	4.5	0.127	65	40	16
KRTi60	PL1024603	6.0	0.236	80	50	20
KRTi70	PL1024604	7.0	0.312	90	55	20
KRTi150	PL1024605	15.0	0.870	120	70	30
KRTi250	PL1024606	25.0	1.100	130	75	32
KRTi400	PL1024607	40.0	1.971	150	80	40

THE JAMMER THAT WON'T GIVE UP!

DECK EQUIPMENT

5



KJ

High load jammer



KJ 2&3

Cam cleat



KW

Winchless



KJH

Jaws handle

We innovate every year to provide effective solutions to usual rope holding and deck organizers issues.

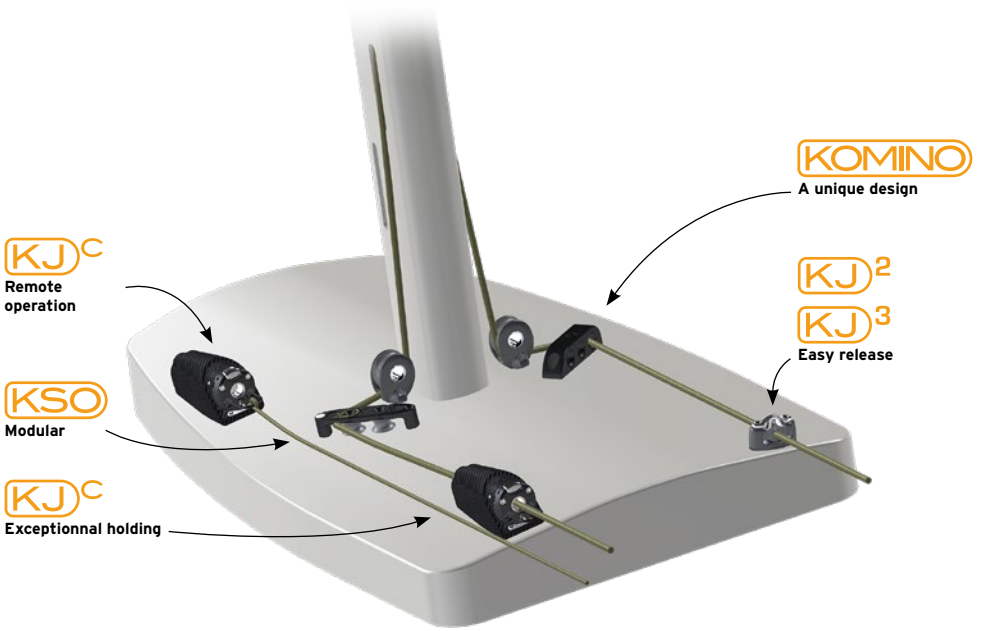

From the mast to the cockpit, organize and efficiently hold your lines.



© Karver Systems

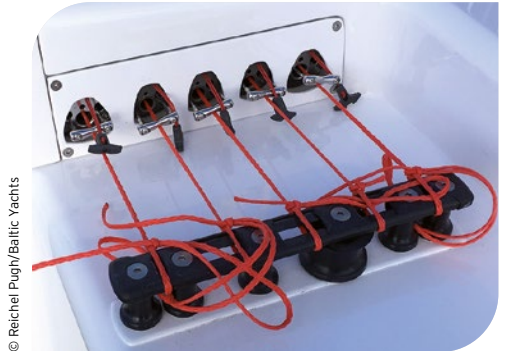

© Reichel Pugh/Baltic Yachts

KJ HIGH LOAD JAMMER

KJ Alu or Carbon: The jammer that won't give up!

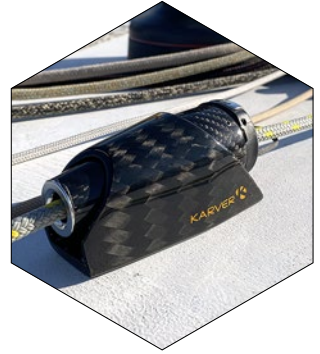

© Karver Systems

Unlike traditional jammers that squeeze lines between 2 jaws, Karver KJ jammer secures the line evenly around its cover with 3 jaws.

The conical-shaped KJ jammer can be dismantled, it is housed in a base fixed on the deck or the mast: waterproofing will then be guaranteed for life !

+ Rope holding

- No slipping when under high load. No rope wear.
- No recoil when blocking.

+ Performance

- Up to 50% lighter than the competition.
- Up to 3 different rope diameters can be used on the same jammer
- Blocks both small and large ropes.

+ Benefits

- Remote control possible.
- Can be built in without its support.
- Easy maintenance.



© Karver Systems



MODEL	PART NUMBER KJ	REFERENCE KJC	SAFE WORKING LOAD (T)	MINI-MAXI ROPE (mm)	DIAM. IDEAL (mm)
KJ10 - KJC10	PF840 100	PF850 100	1	5-10	8
KJ15 - KJC15	PF840 150	PF850 150	1.5	6-12	10
KJ25 - KJC25	PF840 250	PF850 250	2.5	8-14	12
KJ50 - KJC50	PF840 500	PF850 500	5	12-20	18

Weight, size & advice on our website

MODEL	ALU CONE ONLY	KJ FOOTPRINT	CARBON CONE ONLY	KJC FOOTPRINT
KJ10 - KJC10	PF840 100 [CONE]	NO	PF850 100 [CONE]	PF850 800
KJ15 - KJC15	PF840 150 [CONE]	PL843 800	PF850 150 [CONE]	PF850 801
KJ25 - KJC25	PF840 250 [CONE]	PL843 801	PF850 250 [CONE]	PF850 802
KJ50 - KJC50	PF840 500 [CONE]	PL843 802	PF850 500 [CONE]	PF850 803

Weight, size & advice on our website

A SIMPLE AND EFFICIENT CONCEPT

Whether in aluminum or carbon, all KJ ascenders are designed on the same principle: 3 concentric jaws that can be separated from their base and have the ability to be operated remotely.

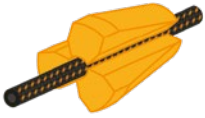

► UNIQUE CONCEPT

The rope is tight and not crushed by 3 concentric stainless steel jaws.

Jaw surface area has been maximized to prevent rope wear.

Unrivalled holding power.



► OPERATION

The trip line (above) allows the jammer to open after to have released the tension of the rope with your winch.

The red line closes the jammer.

These 2 operations can be carried out remotely.



► SPECIAL FEATURES

The conical body of the jammer is inserted in an alloy base and screwed onto the deck or mast.

The KJ jammer can be dismantled in 30 seconds for maintenance or servicing.

Custom carbon conical part possible.



► INSTALLATION

The conical jammer is held in place by a single screw in its base.

The version ready for bonding into the boat is integrated into a conical socket.

ALU OR CARBON VERSION?

It is above all a question of aesthetics and weight. The carbon version does, however, benefit from some improvements:

- Textile controls instead of stainless steel cables.
- Locking button on the top of the ascender.
- Stainless steel jaws.

For the rest, both are equally effective for holding a rope subjected to heavy loads.



► KJ Cone only

► Complete KJ



KJ cones can be purchased without their bases for direct integration.

All KJs can be controlled remotely by disabling the open position lock.

KW WINCHLESS

An automatic purchase instead of a winch!



© Karver Systems

+ Benefits

- Can replace a winch on small sailboats.
- Allows you to control the tension of a rope remotely (recall for example).

Using the mechanism of the KJ jammers, the Winchless Karver allows tension to be taken up on a sheet or a halyard using a hoist.

MODEL	PART NUMBER	SAFE WORKING LOAD (T)	WEIGHT (Kg)	LENGTH x WIDTH x HEIGHT (mm)	MIN. / MAX. (mm)	MAX DIAM. (mm)
WINCHLESS	PF840040	0.3	0.24	100 x 72 x 53	5 - 10	8
KMS40 Adaptor	PF845329	0.3	0.24	100 x 72 x 53	5 - 10	8

KJSK JAMMER STAYSAIL KIT

The KJSK kit facilitates the installation and use of a staysail / storm sail. The kit incorporates our very effective 3-jaws KJ jammer and a hoist for tensioning the forestay.

The addition of a flying furler (Karver or other) allows safe use from the cockpit. The set is light, easy to set up and effective in the breeze.



MODEL	PART NUMBER	FITTING	KJ MODEL	MAX ROPE (mm)	SWL	COMPATIBILITY
KJSK10-M10	PF855 100 [M10]	M10 PIN	KJC10	8	1	KF3.0
KJSK10-LASH	PF855 100	LASHING	KJC10	8	1	KF3.0
KJSK15-M14	PF855 150 [M14]	M14 PIN	KJC15	10	1.5	KF4.5
KJSK15-LASH	PF855 150	LASHING	KJC15	10	1.5	KF4.5
KJSK25-LASH	PF855 250	LASHING	KJC25	12	2.5	KF6.0

KJ^{2&3} CAM CLEATS

High performance.

► KJ2 cam cleat



► KJ3 cam cleat



High strength and reliability.



© Karver Systems

+ Benefits

- Double working load compared to a traditional cleat: 310 Kg.
- The only cam cleat fitted with 4 stainless steel ball bearings (KJ3).
- Jaw design optimized for easier use under load.
- Body available in 3 versions: aluminum, stainless steel or reinforced plastic.

MODEL	PART NUMBER	BODY MATERIAL	SAFE WORKING LOAD (T)	WEIGHT (Kg)	MAX DIAM. (mm)	STANDARD FASTENING SPACE (mm)
KJ2 CAM CLEAT	PF840050	Plastic	0.200	0.045	10	38
KJ3 CAM CLEAT	PF840010	Aluminum	0.310	0.069	10	38
KJ3 CAM CLEAT FAIRLEAD	PF840010 [INOX]	Stainless	0.310	0.107	10	38
FAIRLEAD	SF842531	-	-	0.009	10	38
FAIRLEAD	SF842531 [INOX]	-	-	0.015	10	38



► KJ3 Stainless steel



► KJ3 Fairlead



© Karver Systems

KSC CAM CLEAT

Universal.



© Karver Systems

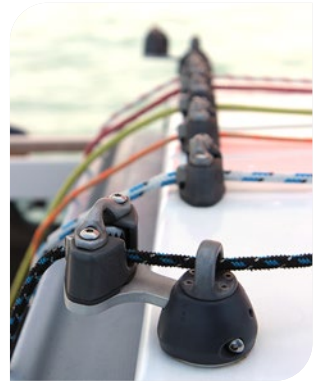

► Cam cleat bases for winch block*

Assembly with the KJ cam cleat, compact and weight optimized.

MODEL	PART NUMBER	SAFE WORKING LOAD (T)	WEIGHT (Kg)	MAX DIAM. (mm)	ARM LENGTH (mm)
KSC SHORT - EYE & KJ3	PF840030	0.2	0.195	10	72
KSC SHORT - LASHING & KJ3	PF840031	0.2	0.179	10	72
KSC LONG - EYE & KJ3	PF840033	0.2	0.199	10	93
KSC LONG - LASHING & KJ3	PF840032	0.2	0.190	10	93

*Sold without block. - **Same parts for different applications.

► Eye drum** Fairlead drum



► Swivel cleat bases with eye**



KJH JAWS HANDLE

Unique to the market!



© Karver Systems

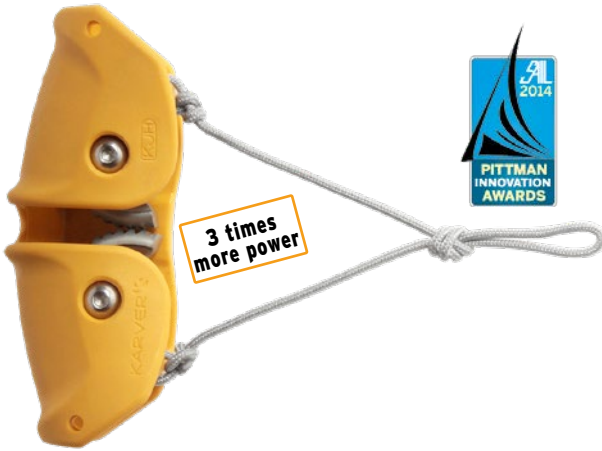

+ Application

- Emergency rope clamp for a stuck or damaged rope.
- Halyard or crossbow blocking.
- Free up a winch when striking a new sail.

The KJH "Jaws Handle" is the ideal system to tighten up a sheet without hurting your hands!

MODEL	PART NUMBER	SAFE WORKING LOAD (T)	WEIGHT (Kg)	MAX DIAM. (mm)				
KJH YELLOW	PF840020	0.110	0.130	10				
KJH GREY	PF840020 [GRIS]	0.110	0.130	10				
KJH PINK	PF840020 [ROSE]	0.110 <td 0.130	10	KJH PHOSPHO	PF 840020 [FLUO]	0.110	0.130	10
KJH PHOSPHO	PF 840020 [FLUO]	0.110	0.130	10				

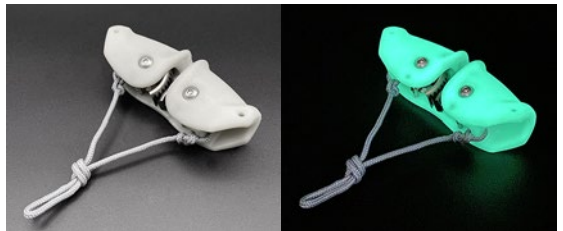

► Glow in the dark KJH



► Pink KJH



© Karver Systems

Ready for high loads.

This low friction organizer is lightweight and designed to handle high loads.



© Karver Systems



MODEL	PART NUMBER	SAFE WORKING LOAD (T)	WEIGHT (Kg)	MAX DIAM. (mm)	HOLES
KORG18-1	PL781679	1.000	0.085	18	1
KORG18-1W	PL781678	1.000	0.111	18	1
KORG18-2	PL781440	1.000	0.147	18	2
KORG18-3	PL781043	1.000	0.205	18	3
KORG18-4	PL781265	1.000	0.328	18	4
KORG18 CUSTOM	PL781180	-	-	18	-
KORG22-1	PL784859	2.000	0.092	22	1
KORG22-1W	PL784860	2.000	0.186	22	1
KORG22-2	PL784861	2.000	0.222	22	2
KORG22-3	PL784862	2.000	0.280	22	3
KORG22-4	PL784863	2.000	0.403	22	4
KORG22 CUSTOM	PL784865	-	-	22	-
KORG30-1	PL784866	3.000	0.289	30	1
KORG30-1W	PL784867	3.000	0.383	30	1
KORG30-2	PL784868	3.000	0.418	30	2
KORG30-3	PL784869	3.000	0.478	30	3
KORG30-4	PL784870	3.000	0.601	30	4
KORG30 CUSTOM	PL784871	-	-	30	-

KSO ORGANIZERS

You can stack them up!



© Karver Systems

Low friction deck organizer featuring a plain bearing sheave, each component can fit into another and be installed as a curve.

The fastening pattern makes it possible to install a KJ2 or KJ3 cam cleat on top of it.

Shipyards will appreciate to be able to realize any configuration with only 3 part numbers.

MODEL	PART NUMBER	MWL 60° (T)	WEIGHT (Kg)	MAX DIAM. (mm)	SHEAVE (mm)	SHEAVE
KSO8 - FIRST (INCLUDE 1 SHEAVE)	PF784531	0.85	0.045	14	30	1
KSO8 ADDITIONAL SHEAVE	PF784533	0.85	0.036	14	30	1
KSO8 END (WITHOUT SHEAVE)	PF784532	0.85	0.031	14	-	0

To order a complete KSO: PF784533 [3] for a KSO8 3 sheaves.



© Karver Systems

FASTER OR EASIER? GO TO KARVER WINCH

WINCHES

6



KCW

Compact range



KSW

Speed range



KPW

Power range



KWH

Carbon winch handles

THE GREATEST INNOVATION ON WINCHES FOR OVER 40 YEARS!

Karver winches are fitted with a double gear mechanism, a classic first stage identical to current winch design and a second consisting of an epicyclic gear. This patented technology is used for the first time on a winch and has the effect of multiplying efforts. Thus and according to its original set up, our winches are either 6 times faster than any other winch on the market (Speed Range), or 3 times more powerful (Power Range). Wow effect guaranteed!

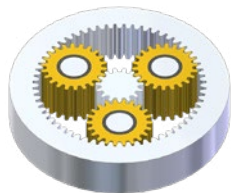

► Planetary or Epicyclic gear



The Pontos company was the originator of this major innovation in sheet winches. It sought a way to drastically reduce the physical effort to operate on a sailboat and make the practice of sailing accessible to the greatest number of people. Bought by Karver in 2018 and taking advantage of their 15 years of boating experience, these winches have evolved into even more performance and reliability.

Apart from the Compact (2 speeds), all winches are fitted with 4 automatic speeds. As soon as the efforts are too much, simply operate the handle in the opposite direction. Speeds pass instinctively from one to the other without activating any extra mechanism. Once the tension on the rope is released, the winch will return to the initial speed.

Designed to last: Aluminum hard anodized drum, 17-4PH stainless steel gearboxes and clutch, triple polyoxymethylene needle bearing cage, plus full 5 year warranty.

Karver winches have been successfully tested in extreme conditions and proven in the toughest races like the Route du Rhum, 20% of Class 40s have adopted it.

Find testimonials from many customers on our website (product page).

Make your own opinion and contact your nearest dealer to find out where to try it.



© Vincent Riou sur PRB, crédit Benoit Stichelbaut

KSW WINCH-RANGE SPEED

6 TIMES FASTER THAN A TRADITIONAL WINCH



© Nicolas Troussel - Jean-Marie Liot

“Be careful, it’s going to be fast! Very very very fast!”.

The extra speeds of the KSW provide the ability to trim much faster than standard winches. In first gear, a single handle turn embeds times the length of rope of a two-speed winch. The gear change is simple.

The simplicity and speed of the operations will certainly make you save accurate seconds for the overall leader board.

To hoist a main sail with a 20m halyard requires 142 turns of handle with a traditional winch against 29 turns with a Speed Karver!

+ Performance

- 6 times faster: Trim in faster. Trim for extraspeed and acceleration out of the tack.
- 4 automatic speeds: 2 standard speeds + 2 extra fast speeds.
- The sails are not blowing free longer in the tack and end up less damaged.

+ Safety feature

- No need to take the slack by hand. Use the handle from A to Z.

+ Simple

- Instinctive shift in gears. No mechanism to operate.
- Dimensioned to replace most standard winches.

	KSW 40				KSW 46				KSW 52			
PART NUMBER	PF1205830				PF1205831				PF1205832			
BASE	171 mm				206 mm				220 mm			
ROPE DIAMETER	8-12 mm				8-14 mm				8-14 mm			
WEIGHT	5.3 Kg				7.6 Kg				8.2 Kg			
MAX LOAD	850 Kg				1 300 Kg				1 500 Kg			
SPEED	1	2	3	4	1	2	3	4	1	2	3	4
POWER RATIO	2.3	8	11.6	40	2.3	9.3	11.7	46.6	2.3	10.6	11.6	52.8
TAILING LENGTH	70 cm	20 cm	14 cm	4 cm	68 cm	17 cm	14 cm	3,5 cm	69 cm	15 cm	14 cm	3 cm

KPW WINCH-RANGE POWER

3 TIMES MORE POWERFUL = 3 TIMES LESS EFFORT



© Gustus sur Maeva

Re-discover the pleasure of setting a sail without effort!

What delights KPW users is the multiplication ratio that converts minimal effort on the handle into maximum effort on the line. The operation become accessible to the whole family.

This winch is really dedicated to cruisers but racers will also have noted that at similar sizes our winches are 20% stronger than the others. This allows you to come down in winch size if needed.

On a 38-foot, with a 40 m² genoa, in 2 knots of wind, a standard winch will require 13 kg to tuck the sail. The effort required with a KARVER Power will be only 4.7 Kg!

+ Performance

- 3 times more powerful: Trim at your fingertips and save your strength..
- 4 automatic speeds: 2 standard speeds + 2 extra fast speeds .
- Our superior working load capacity makes it possible to use a smaller size.

+ Economic

- A real alternative to electric winches.

+ Convenient

- KWPs are so powerful that you can use a shorter handle, useful for winches under roof cover.

	KPW 110				KPW 130				KPW 150			
PART NUMBER	PF1205833				PF1205834				PF1205835			
BASE	171 mm				206 mm				220 mm			
ROPE DIAMETER	8-12 mm				8-14 mm				8-14 mm			
WEIGHT	5.2 Kg				7.4 Kg				8.6 Kg			
MAX LOAD	1 000 Kg				1 500 Kg				1 800 Kg			
SPEED	1	2	3	4	1	2	3	4	1	2	3	4
POWER RATIO	11.6	40	112.9	32.7	11.7	46.6	131.3	33	11.6	52.8	148.7	32.7
TAILING LENGTH	14 cm	4 cm	1,4 cm	5 cm	14 cm	3,5 cm	1,2 cm	5 cm	14 cm	3 cm	1,1 cm	5 cm

KCW WINCH COMPACT

THE BEST OF KARVER TECHNOLOGY

DECK EQUIPMENT, SAILS AND RIGGING
DAME
 CATEGORY WINNER
 2019
 KARVER KCW COMPACT WINCH



© Karver Systems

Two speeds: The first ultra fast and the second ultra powerful!

Total concentrated innovation in a two-speed self-tailing winch. By transposing the technology of its 4-speed winches, Karver invented the most powerful small winch.

The winch Compact has the size of a winch 20 but the power of a winch 45. In first gear, you enjoy a tailing speed twice the speed of a conventional winch, and in second gear, you benefit from the power of a winch 45.

The unique combination of a small size and a workload of 850 Kg makes the Compact an extremely versatile winch.

The Compact winch can replace any winch up to and including size 40 and accepts 8 to 11 mm ropes, providing increased comfort and improved performance.

+ Performance

- Ultra Compact (size of a Winch 20).
- 2 times faster (24 cm per handle round).
- Unbeatable weight / power ratio and dimensions / power ratio.



► Size with equivalent power.



► Multiple rope angle entries. Replace all winches up to size 40.

PART NUMBER	PF1205836	
BASE	130 mm	
HEIGHT	142 mm	
ROPE ENTRY HEIGHT	58 mm	
ROPE DIAMETER	8-11 mm	
WEIGHT	3.2 Kg	
MAX LOAD	850 Kg	
SPEED	1	2
POWER RATIO	6,05 Kg	45 Kg
TAILING LENGTH	26.4 cm	3.5 cm

KWH CARBON WINCH HANDLES

EFFICIENCY, PERFORMANCE, DURABILITY & AESTHETICS

DECK EQUIPMENT, SAILS AND RIGGING
DAME
 CATEGORY WINNER
 2019
 KWH WINCH HANDLE



© Karver Systems

The winch handle is an iconic tool for all sailors. This is why it feels natural to propose a KARVER one reflecting our own DNA: Performance - Innovation - Design.

MODEL	PART NUMBER	LENGHT	POMMEL	WEIGHT (g)
KWH20	PF1206312	199 mm/8'	NO	415
KWH20G	PF1206313	199 mm/8'	YES	486
KWH25	PF1206310	254 mm/10'	NO	456
KWH25G	PF1206311	254 mm/10'	YES	528

Add the extension code [W] to order the wooden version.

Available in wood veneer with the name of your boat or its owner.



+ Benefits

- Body structure 100 % Carbon: Lighter, stiffer.
- Double stainless steel low friction ball bearings. Extended life.
- User friendly locking system, left and right hand users.
- Customized Design and cover finish.
- The weight gained by the carbon allows the use of stainless steel more resistant than aluminum on the handle and the footprint.
- Our racing customers say that the use of carbon makes the handle more "dynamic and efficient".
- Very competitive price.



© Karver Systems

ONLINE SUPPORT: UNDERSTANDING THE CHARACTERISTICS OF A WINCH

KARVERPEDIA

The significant efforts on sailboats forced sailors to find technical solutions to pull loads that exceeded their own strength. Since antiquity, until today, many techniques have been used (capstan, winch, etc.), to finally arrive today at the generalized use of modern winches.

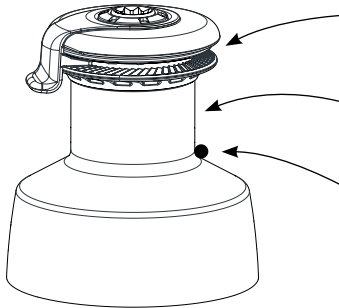

Self tailing: Device invented in the 1970s, which allows to capture the rope in a system of jaws and to use the winch with one hand for the handle.

Drum: Cylinder which constitutes the external body of the winch on which the rope is furled and which will receive a handle in its upper part. The grip is the surface condition of the drum which can be from smooth to very aggressive.

Rope entry height & angle: The height is used to define the angle which should generally be between 5 and 8°. Respecting this angle guarantees correct operation and more particularly for fast winches.

- **Maximum working load (MWL):** each winch must be able to withstand the loads present. Shipyards and yacht designers define these values. In the event of a winch replacement, you will find this information in the documentation for your current winch.
- **Power ratio:** represents the tensile force generated by the winch for 1 kg of force applied to a standard handle (254 mm). It generally defines the size of the winch: a size 40 = 40 kg of traction for 1 kg in the handle (1: 40). The larger this number is, the less force you will have to use on the handle. Thus a 40ST2A is a winch of max power 1:40 fitted with a self tailing (ST), with 2 speeds (2) and fitted with an aluminum drum (A)
- **Gear ratio:** defined the number of handle turns to be given to make 1 complete turn of the drum. Conversely, and depending on the diameter of the drum, this ratio will make it possible to define the length of strop engaged at each turn of the handle. Example: 6.28: 1 = 6.28 turns of the handle for one turn of the drum. A ratio less than 1 means that one turn of the handle turns the drum several times.
- **Output length (or speed):** this is more concrete than the speed ratio since it is the length of the rope engaged for one turn of the handle. This data is very rarely provided and it must therefore be calculated: speed ratio x π (3.14) x drum diameter.
- **Dimensions:** It is worth comparing winches of equivalent sizes (in addition to the load capacity). The reference values are generally the diameters of the base and the drum as well as the total height of the winch
- **Weight:** argument more sensitive for the racers than for the pleasure boaters
- **Number of speeds:** 95% of winches have 1 or 2 speeds. Like a car, a winch can have several possible gear ratios. The speed change is effected by reversing the direction of rotation of the handle.
- **Materials:** the drum can be in aluminum (A), in chrome-plated bronze (C), in stainless steel,... Aluminum drums are the most common and the lightest
- **Price:** an important criteria for most sailors but which must be put in relation with the technical elements above.

Karver winches have a very particular technical positioning since we are the only ones to use 4 fully automatic speeds and a planetary gear system that offers a rotation speed 5 to 6 times greater than our competitors (KSW models) or 3 times more power (KPW models).

FIND OTHER KARVERPEDIA ARTICLES ON OUR WEBSITE WWW.KARVER-SYSTEMS.COM

OUR CLIENTS ARE OUR BEST AMBASSADORS... HERE ARE THEIR TESTIMONIES:

« This is the biggest winch innovation for a generation. I was amazed by the performance. A single transfer was enough to impress me! The jib was tacked even before I looked up to check its position. A pair of tack later I was definitely seduced... The power involved is so present that it is no longer necessary to install an electric winch. For me, this is the most incredible point of these winches.

The advantages are not only speed and power in regatta: it's even more about making life easier for boaters... The more I look at conventional two-speed winches, the more they seem to me unnecessarily slow, and laborious... Try these winches and you will find that it is difficult to go back. »

**Toby Hodges Journalist
at Yachting Monthly**

“The Speed winch makes it possible to sheet out so quickly that the sheet to the wind no longer leaves its self-tailing from the start to the final adjustment: Practical, Fast, Efficient!”

Patrice Carpentier “Boats” magazine

“Karver has reinvented the winch by working on points which seem to have been taken for granted but which are never definitively so. It's the same approach that we follow for the America's Cup. I found that Karver brought a plus, an ease which corresponded to the size and the problematic of my multihull. I also like to test new things. The principle of 4 speeds on a winch without button seduced me ! Karver has reinvented the winch by bringing real innovation. They made the revolution in the village.”

Loic Peyron aboard Happy

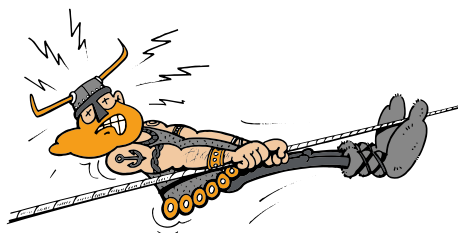

“When we're in awe of something, we like to say it: Karver is bringing something new to boating, and it's no exaggeration to say that they make operation much easier.”

**Paola Bertelli journalist
to Sail Republic**

“The first thing I look for in a winch is its reliability. Karver achieved this goal. Then comes performance... Based on our recent experiences, we can confirm that Karver's four speed winches make a big difference on the water... a definite advantage. All the guys who have sailed with me are unanimous on this. These winches are great.”

**Sébastien Rogues, (GC32/Class40),
GDF Suez**

“The Speed winch is the ultimate weapon for quickly picking up slack in sheets, halyards, lines, etc...”

**Bertrand Castelnerac,
Professional racer**

“Karver 4-speed winches are revolutionary.”

NW Yachting

“The Karver winches played a key role in our victory by reducing our physical effort and therefore our fatigue when operating the A3 and Code spinnaker.”

Racing couple aboard a C&C 115

“We have taken simplicity, performance and safety to the next level.”

**Thibaut Vauchel-Camus
Professional skipper
Class 40 / Ocean Fifty**



LOW FRICTION AND HIGH RESISTANCE SYSTEMS

TRACK AND CAR SYSTEMS

7



KMS 30



KMS 40



KMS 60



KMS 80&100

TRACK AND CAR SYSTEMS: DESIGNED TO LAST!

Developed in collaboration with major offshore racing teams, Karver track and car systems combine reliability, size and minimum weight.

4 reasons to choose a Karver mast system:

- An extremely optimized product line for greater performance.
- Modern design and continual innovation.
- Reliable and efficient locking solutions.
- An unmatched capacity to produce custom systems in a short timeframe.



© Karver Systems

CHARACTERISTICS	UNIT	KMS30	KMS40	KMS60	KMS80	KMS100
Yacht size	foot	< 35	35-50	50-70	70-110	100-140
Track upper width	mm	19.6	21	29	34	48
Base track width	mm	19.6	24	29	34	48
Track height	mm	11.4	12.2	14	16	22.5
Weight / m - Standard	g / m	250	304	488	664	1490
Weight / m - Lightened	g / m	X	X	418	564	1245
Length	m	2	3	3 & 6	3 & 6	3 & 6
Fastener	mm	6	5 or 6	6	8	10
Standard fastening space	mm	25	30	25	50	50
Headboard with lock	-	NO	YES	YES	YES	YES
Batten cars - Standard pin	-	M10	M10	M14	M16	M18

Our mast cars are designed to fit some competitor tracks.

MODEL	HARKEN	RONSTAN	ANTAL
KMS30	AA	Serie 14	X
KMS40	A, ST18	Series 19 & 22	HS22
KMS60	B, ST26	Series 22 & 24	HS22, HS24, HS30
KMS80	C, ST32	Serie 26	HS30
KMS100	ST50	Series 30 & 42	X

- > A track section can be ordered with reinforced and enlightened sections.
- > Batten car screw diameter & length can be modified.
- > Our mast cars can be installed on many competitor tracks. Please ask us!
- > You can use ball bearing and friction cars on the same track.
- > Batten receptacles can be ordered for others batten models.

KARVER MAST SYSTEM

▶ Locking area track

▶ Track joiner

▶ Standard track

▶ Track joiner

▶ Custom track reinforced + alighten zone

▶ Car charger



▶ Standard headboard car + CV plate



▶ Lashing headboard car



▶ Lashing locking headboard car



▶ Gaff lock headboard car (P. 66)



▶ 2:1 headboard car



▶ Automatic locking headboard car (P. 68)



▶ Square top batten car fast pin



▶ Square top batten reinforced car

LONG DESIGN



▶ Batten cars



▶ Intermediate car



▶ Tack/reef car lighten

COMPACT DESIGN



▶ Batten cars with fuse (P. 67)



▶ Batten cars reinforced with fuse



▶ Intermediate car



▶ Tack/reef car



▶ Batten receptacle (P. 69)

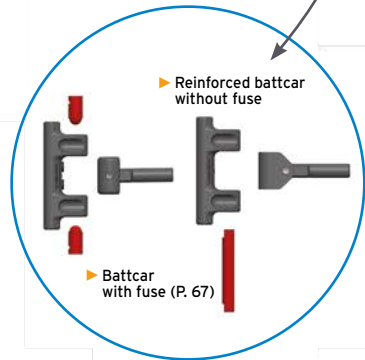

▶ Reinforced battcar without fuse

▶ Battcar with fuse (P. 67)

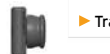

▶ Track endstop

PRODUCT

FEATURES AND BENEFITS

TRACKS



- All our tracks are precision made.
- Possibility to reinforce zones where reefs will be taken.
- Possibility to lighten zones where loads will be minimized.
- Possibility to mix reinforce, lighten & locking zones on the same track section.
- Permanent stock of raw track to shorten lead time for custom machinery.
- Ball bearing or sliders cars fitting on the standard track shape.

CARS

GENERAL:

- Ultra compact, light & modern design.
- Machined cars for better reliability & resistance.
- Toggles on the cars are close to the mast aft face to limit tearing risks.
- All cars are available with a short or long design to fit the right load.
- All cars can be ordered with ball bearings but we recommend the friction.
- Sliders made of self-lubricated material for lower friction & limited wear.
- As every project is unique, custom cars are available on request (60% of our sales).
- We can shape our car sliders to fit competitor's track.

HEADBOARD CARS:

- Many headboard car configurations with or without lock.
- 2 to 1 Gaff lock developed to easily hoist and flake square top mainsails.
- Locking headcar: external and/or internal remote control with or without position sensor.

TOP BATTEN CAR:

- Available with or without fast pin.
- Optimized angular displacement for the batten box screw.

BATTEN CARS:

- Our batten cars feature a fuse mechanism to prevent any damage to the cars or the track if overloaded.
- Reinforced version available (without fuse).

INTERMEDIATE CARS:

- Ultra compact design & light (machined in one piece).

REEF/TACK CARS:

- A reinforced car for the highest load.

BATTEN RECEPTACLES:

- Many batten receptacle models available.
- New "Rocket" design.



KGL GAFF LOCK

Simple is beautiful!



DAME
NOMINATED
2016



© Karver Systems



The KGL Gaff Lock was design to facilitate the process of hoisting and flaking big square top mainsails. The system is simple and reliable and can be featured on existing tracks and cars (even from our competitors).

There is one restriction to it though, the KGL Gaff Lock would only work if the mainsail of the halyard can pass through a sheave at the end of the mast crane.

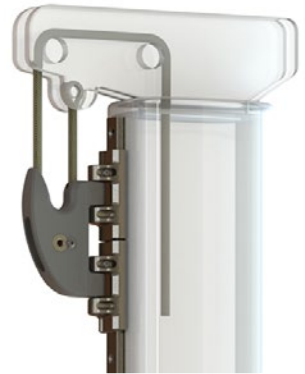

MODEL	SAFE WORKING LOAD (T)	RECOMMENDED HALYARD (mm)	KGL ONLY	KGL + KMS HB CAR	HIGH LOAD STROPE
KGL30	0.25	7	PF1044813	PF1044813 [CHRT]	MP1044826
KGL40	3	14	PF1404581	PF1404581 [CHRT]	MP1404478
KGL60	6	16	PF1604748	PF1604748 [CHRT]	MP1604479
KGL80	8	18	PF1804749	PF1804749 [CHRT]	MP1804828

Please contact us to custom made our KGL Gaff lock to your existing set of cars. Some part numbers already available:

- Harken: AA, A, B, C, ST18, ST26, ST32
- Ronstan: Series 14, 19, 22, 26
- Antal: HS22, HS24, HS30

KMS FUSE BATTCAR

Never break a batten again!



+ Innovation

- The only fuse cart on the market.

+ Performance

- Prevents breakage of the battcars.
- Reduces downtime.
- The "quick-fuse" version allows the mainsail to be dismantled more quickly without removing the cars.

Racing yachts and big boats often have mainsails with long carbon battens that can be fragile and difficult to replace after a breakage.

Our KMS40 and KMS60 batten cars can feature an anti-breakage mechanism that will protect the battens.

If overloaded, after an accidental jibe for instance, the part will shear and free the batten pin before damaging the battens. You would only have to change the fuse then.



KMS AUTOMATIC HEADBOARD CAR LOCK

An efficient solution to meet Super Yachts requirements.



+ Performance

- Lightweight and compact.
- Designed not to get stuck.
- Unlocking without order: hoist the mainsail.
- Tools for fitting the triggers to the millimeter.

+ Design

- We adapt to all specific requests.
- Available across our entire range.
- No complex mechanics.

Many sailboats feature our locking headboard cars for their mainsail. Many of the Imoca are doing so, for instance. To ease the way to operate the system and make it more mainstream, we have designed an automated version of our headboard car lock to be reliable and easy to use: flippers are fitted around each locking area.

The locking mechanism of the headboard car automatically engages once it is in contact with the flippers. An external command remains on the car as a back up.

MODEL	PART NUMBER	NB OF INSERTS	SAFE WORKING LOAD (T)	CAR LENGTH (mm)	WEIGHT (Kg)
KMS40	PF1405533	1	3	140	0.284
KMS60 / 5T	PF1605442	1	5	200	0.589
KMS60 / 8T	PF1605431	2	8	350	2.400
KMS80 / 7T	PF1805431	1	7	200	1.100
KMS80 / 12 T	PF1804657	2	12	350	2.400
KMS100	PF1004957	2	20	400	3.100

ACCESSORIES	KMS40	KMS60	KMS80	KMS100
Flipper x 1	PF1405511	PF1804655	PF1005515	
Exit box with cam cleat for flipper command	PF1405512	PF1804554	PF1005516	
Position sensor display	PF1405513	PF1804793	PF1005517	
Installation tool for flipper and sensor	PF1405514	PF1604760	PF1804760	PF1005518

KMS BATTEN RECEPTACLES

Karverized to the end of the battens...



+ Performance

- Resistance +++
- Available in aluminum, carbon, plastic and soon in sourced organic plastic.

+ Design

- Limited series produced to your specifications
- Possibility to add your logo on the carbon version.

When you make the choice of performance with quality sails, it makes sense to apply this principle to accessories. Here again, Karver is there to offer batten receptacles suitable for all situations.

We have solutions for all programs.

MODEL	MAX BATTEN	STD PIN	OPTIONS	MATERIAL	REF. 14 X 30	REF. M10/M12
KMS60	14 x 30	M14	M10/M12	PA6	PF1614541	PF1615454
KMS60	14 x 30	M14	M10/M12	ALU	PF1614568	PF1615450
KMS80	20 x 40	M16	M12/M14	ALU	PF1815148	PF1815348
KMS100	26 x 39	M18	M14/M16	ALU	PF1015508	PF1015509



CARBON VERSION

Available for everyone from 25 order units. Entrust us with your specifications.



▶ Lashing batten Rockets



In partnership with one of the biggest sail loft in the world, we designed a new batten receptacle made of one-piece and fitted symmetrically within the sail to optimize the air laminar flow.

The finished part is compact, light and can fit several sizes of carbon battens.

The KMS 30 range is designed for yachts from 20 to 35 feet long. The sliding is done using Teflon sliders.

Minimal friction in a compact and lightweight range.



MODEL	STD	PART NUMBER	WEIGHT (Kg)	HEIGHT (mm)
TRACKS				
22 mm STANDARD RAIL (M6 / 25 mm)	STD	PF1042549	0.250 / m	2000
LOCKING AREA	-	PF1045086	0.150 / m	300
HEADBOARD CARS				
A HEADBOARD CAR LASHING	-	PF1043734	0.073	81
B LOCKING HEADBOARD CAR	-	PF1045087	0.120	86
HEADBOARD CAR + GAFF LOCK	-	PF1044813 [CHRT]	0.860	88
BATTEN CARS				
C BATTEN CAR M10	STD	PF1043362	0.043	40
TACK / REEF CARS				
D TACK / INTERMEDIATE CAR	STD	PF1043735	0.023	40
INTERMEDIATE CARS				
D TACK / INTERMEDIATE CAR	STD	PF1043735	0.023	40
ACCESSORIES				
TRACK JOINER	STD	PL1044872	0.013	50
TRACK END STOP	STD	PL1044873	0.022	25
CAR LOADER	-	PL1044874	0.040	150
GAFF LOCK (ONLY)	-	PF1044813	0.045	62
HR STROPE FOR GAFF LOCK	-	MP1044826	0.020	80
BATTEN RECEPTACLES				
BATTEN BOX M10	-	PF1043321	0.080	-



The KMS40 range benefits from Karver's knowledge of mainsail track systems.

Available for boats from 35 to 50 feet long for unrivalled performance and reliability.

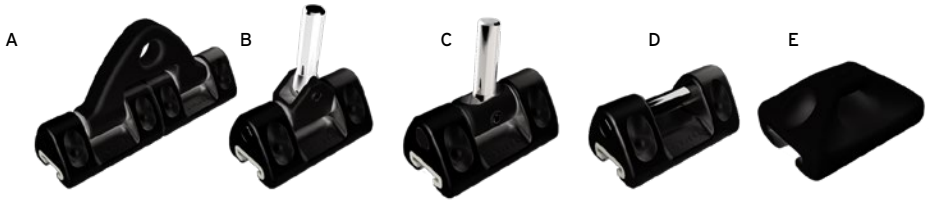

	MODEL	STD	PART NUMBER	WEIGHT (Kg)	HEIGHT (mm)
TRACKS					
	21MM STANDARD TRACK (M5 / 30 mm) 3M	STD	PF1402711 [M5]	0.304 g/m	3000
	21MM STANDARD TRACK (M6 / 30 mm) 3M	-	PF1402711	0.290 g/m	3000
	LOCKING TRACK M5	-	PF1403564	0.136	510
	LOCKING TRACK M6	-	PF1403564 [M6]	0.134	510
HEADBOARD CARS					
A	HEADBOARD CAR - STANDARD	STD	PF1403035	0.388	140
	HEADBOARD CAR - LASHING	-	PF1402992	0.279	140
	HEADBOARD CAR LOCK + LASHING	-	PF1403036	0.284	140
	HEADBOARD CAR GAFF LOCK	-	PF1404581 [CHRT]	0.842	153
SQUARE TOP BATTEN CARS					
	SQUARE TOP BATTCAR FAST PIN M10	STD	PF1404876	0.220	70
BATTEN CARS					
B	BATTCAR REINFORCED M10 WITHOUT FUSE	STD	PF1402710 [R]	0.230	70
C	BATTCAR M10 WITH FUSE	-	PF1402710	0.149	70
	BATTCAR M10 WITH FAST FUSE	-	PF1403020	0.155	70
TACK / REEF CARS					
D	TACK / REEF CAR	STD	PF1403031	0.250	70
INTERMEDIATE CARS					
E	INTERMEDIATE CAR	STD	PL1403588	0.025	50
ACCESSORIES					
	REMOVABLE TRACK DOOR	STD	PF1403054	0.094	200
	TRACK DOOR - CAR CHARGER	STD	PF1404052	0.071	200
	TRACK ENDSTOP (x1)	-	PL1403277	0.011	25
	TRACK JOINER	-	PL1404013	0.007	50
	GAFF LOCK ONLY	-	PF1404581	0.473	127
	HL STROPE FOR GAFF LOCK	STD	MP1404478	0.400	80

- > The standard batten car screw is M10 but can be ordered with M8 or M12.
- > Our mast cars can be installed on many competitor tracks. Please ask us!
- > A track section can be ordered with reinforced and enlighthed sections).

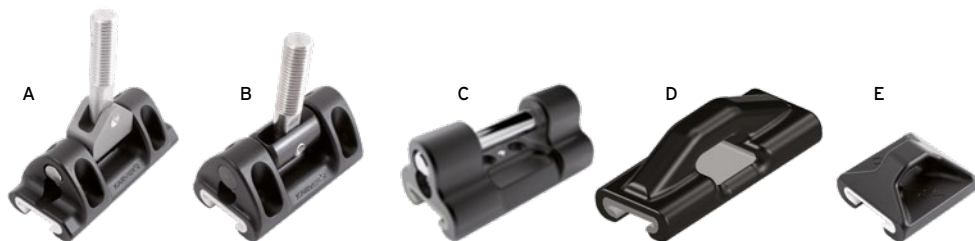

MODEL	STD	PART NUMBER	WEIGHT (Kg)	HEIGHT (mm)
TRACKS				
STANDARD 29MM TRACK (M6 / 25 mm) 3M	STD	PF1602744 [3M]	0.510	3000
REINFORCED 29MM TRACK (M6CSH / 25 mm) 3M	-	PF1604883 [3M]	0.480	3000
ENLIGHTED V1 29MM TRACK (M6 / 50 mm) 3M	-	PF1604882 [3M]	0.429	3000
ENLIGHTED V2 29MM TRACK (M6 / 75 mm) 3M	-	PF1604881 [3M]	0.423	3000
ENLIGHTED V3 29MM TRACK (M6 / 100 mm) 3M	-	PF1604888 [3M]	0.418	3000
LOCKING TRACK / 5T	-	PF1603545	0.480	600
CUSTOM KMS60 TRACK	-	PF1602744 [CUST]	-	-
HEADBOARD CARS				
STANDARD HEADBOARD CAR	STD	PF1604050	0.496	200
HEADBOARD CAR + 2:1 BLOCK + LASHING	-	PF1603271	0.827	200
HEADBOARD CAR + LOCK + LASHING	-	PF1602999	0.589	200
HEADBOARD CAR DOUBLE LASHING	-	PF1604321	0.496	180
HEADBOARD CAR + GAFF LOCK	-	PF1604748 [CHRT]	1.347	201
CUSTOM KMS60 HEADBOARD CAR	-	PF1604050 [CUST]	-	-
SQUARE TOP BATTEN CARS				
A SQUARE TOP BATTCAR L110 M14 + FAST PIN	STD	PF1604209	0.380	110
BATTCAR REINFORCED L110 M14	-	PF1602778	0.423	110
BATTEN CARS				
B BATTCAR L90 M14 WITH FAST FUSE		PF1602878 [90]	0.302	90
BATTCAR L110 M14 WITH FAST FUSE		PF1602878	0.317	110
BATTCAR REINFORCED L90 M14	STD	PF1602778 [90]	0.338	90
A BATTCAR REINFORCED L110 M14		PF1602778	0.423	110

MODEL	STD	PART NUMBER	WEIGHT (Kg)	HEIGHT (mm)
BALL BEARING BATT CARS				
BALL BEARING SQUARE TOP BATT CAR L113 M14 FAST PIN		PF1603507	0.410	113
BALL BEARING BATT CAR REINFORCED L93 M14 + FAST FUSE		PF1602939 [90]	0.390	93
BALL BEARING BATT CAR REINFORCED L113 M14 + FAST FUSE		PF1602939	0.557	116
BALL BEARING BATT CAR REINFORCED L113 M14 + FAST FUSE		PF1604890 [90]	0.405	93
BALL BEARING BATT CAR REINFORCED L113 M14		PF1604890	0.560	113
BALL BEARING BATT CAR REINFORCED L93 M14				
TACK / REEF CAR L90	-	PF1602942	0.227	90
C TACK / REEF CAR L110	STD	PF1602944	0.260	110
D TACK / REEF ALIGHTEN MONOBLOC	-	PF1602943	0.189	110
INTERMEDIATE CARS				
INTERMEDIATE CAR 50MM (PA6)	-	PF1602932	0.026	50
E INTERMEDIATE CAR 50MM (ALU)	STD	PF1602881	0.062	50
INTERMEDIATE CAR 70MM	-	PF1604433	0.095	70
ACCESSORIES				
TRACK JOINER	STD	PF1603525	0.018	50
REINFORCED INSERT	-	PF1603528	0.018	50
TRACK ENDSTOP	STD	PF1604883	0.055	50
TRACK DOOR - CAR CHARGER	STD	PF1604849	0.012	200
GAFF LOCK ONLY	-	PF1604748	0.907	148.60
HIGH LOAD STROP FOR GAFF LOCK	-	MP1604479	0.220	110
BATTEN RECEPTACLES				
BATTEN RECEPTACLE 30x20 M14 (ALU)	-	PF1612889	0.348	-
BATTEN RECEPTACLE 30x20 M14 (PA6)	-	PF1612891	0.180	-
BATTEN RECEPTACLE 39x20 M14 (ALU) - LONG	-	PF1682883	0.465	-
BATTEN RECEPTACLE D22 M14 (ALU)	-	PF1613288	0.418	-
BATTEN RECEPTACLE D22 M14 (PA6)	-	PF1612890	0.206	-
BATTEN RECEPTACLE 30x20 FOR TOP BATTEN M14 (PA6)	-	PF1613257	0.196	-
BATTEN RECEPTACLE 30x20 FOR TOP BATTEN M14 (ALU)	-	PF1604920	0.348	-
ROCKET BATTEN RECEPTACLE				

See page 69

** Track lengths are available in 3 or 6 meters or custom.

* A track section can be ordered with reinforced and enlightened sections.

> The standard batten car screw is M14 but can be ordered with M12 or M16.

> Our mast cars can be installed on many competitor tracks. Please ask us!

> You can use ball bearing and friction cars on the same track.

> Batten receptacles can be ordered for others batten models.

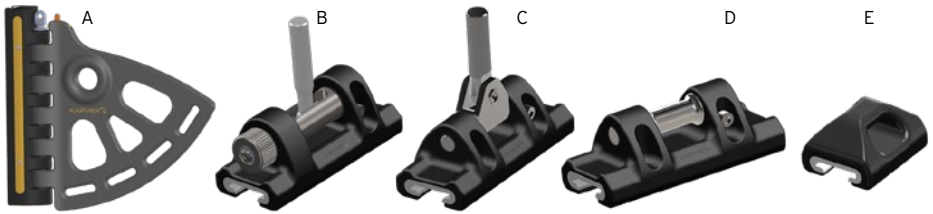

	MODEL	STD	PART NUMBER	WEIGHT (Kg)	HEIGHT (mm)
TRACKS					
	STANDARD 34MM TRACK (M8 / 25 mm) 3M	STD	PF1804542	0.664	3000
	ENLIGHTED 34MM TRACK (M8 / 25 mm) 3M	-	PF1804543	0.579	3000
	REINFORCED 34 MM TRACK (M8CSH / 25mm) 3M	-	PF1804544	2.100	3000
	LOCKING AREA (DOUBLE) IN THE TRACK	-	PF1804548	1.220	800
	LOCK TRIGGER BOX (INTERNAL REMOTE CONTROL - AUTOLOCK)	-	PF1804655	0.148	66
	CUSTOM KMS80 TRACK	-	PF1804542 [CUST]	x	x
HEADBOARD CARS					
A	HEADBOARD CAR STANDARD	STD	PF1804690	2.200	280
	HEADBOARD CAR 2:1 LASHING	STD	PF1805263	1.578	280
	HEADBOARD CAR AUTOLOCK / 12T	-	PF1804657	2.600	400
	HEADBOARD CAR + GAFF LOCK	-	PF1804749 [CHRT]	2.100	300
	HEADBOARD CAR CUSTOM	-	PF1804692	x	x
SQUARE TOP BATTEN CARS					
B	BATTCAR 140MM SQUARE TOP BATTEN M16	STD	PF1804677 [M16]	0.727	140
	BATTCAR L140 REINFORCED M16	-	PF1804695 [M16]	0.650	140
BATTEN CARS					
	BATTCAR L110 REINFORCED M16	-	PF1804694 [M16]	0.560	110
C	BATTCAR L140 REINFORCED M16	STD	PF1804695 [M16]	0.600	140

MODEL	STD	PART NUMBER	WEIGHT (Kg)	HEIGHT (mm)
BALL BEARING BATTMARS				
HEADBOARD CAR (BALL BEARING)	-	PF1804690 [BB]	2.050	382
SQUARE TOP BATTEN CAR (BALL BEARING)	-	PF1804898 [BBM16]	1.100	172
BATTEN CAR 142MM (BALL BEARING)	-	PF1804896 [BBM16]	0.870	142
BATTEN CAR 172 (BALL BEARING)	-	PF1805614 [BBM16]	0.950	172
TACK / REEF CAR (BALL BEARING)	-	PF1804686 [BB]	0.810	172
INTERMEDIATE CAR (BALL BEARING)	-	PF1804688 [BB]	0.510	102
TACK OR REEF CARS				
D TACK / REEF CAR L140	STD	PF1804686	0.481	140
INTERMEDIATE CARS				
INTERMEDIATE CAR 70MM (PA6)	-	PF1803454	0.100	70
E INTERMEDIATE CAR 70MM	STD	PF1804688	0.204	70
ACCESSORIES				
TRACK JOINER 100MM	STD	PL1805477	0.730	100
EXIT FLIPPER LINE	-	PF1804554	0.150	66
KMS POSITION SENSOR + 90° PTHIMBLE	-	PF1804793	x	x
POSITION SENSOR DISPLAY	-	MP1804795	x	x
TRACK DOOR - CAR CHARGER	STD	PF1804547	0.298	500
HIGH LOAD STROP FOR GAFF LOCK	-	MP1804828	0.500	200
GAFF LOCK ONLY	-	PF1804749	1.100	197
TRACK ENDSTOP x 1	-	PF1804763	0.099	60
MAINSAIL HEAD PLATE 60°	-	PF1804750	2.400	300
BATTEN RECEPTACLES				
BATTEN RECEPTACLES 20x30 M16 (ALU)	-	PF1612889 [M16]	0.690	120
BATTEN RECEPTACLES 26x39 M16 (ALU)	-	PF1812883 [M16]	0.735	120
ROCKET BATTEN RECEPTACLE				

See page 69

- ** Track lengths are available in 3 or 6 meters or custom.
- * A track section can be ordered with reinforced and enlighthed sections.
- > The standard batten car screw is M16 but can be ordered with M12 or M14.
- > Our mast cars can be installed on many competitor tracks. Please ask us!
- > You can use ball bearing and friction cars on the same track.
- > Batten receptacles can be ordered for others batten models.





MODEL	PART NUMBER	WEIGHT (Kg)	HEIGHT (mm)
TRACKS*			
STANDARD 48MM TRACK 3M	PF1004550 [3M]	1.490	3000
REINFORCED 48MM TRACK 3M	PF1004953	1.490	3000
ENLIGHTED 48MM TRACK 3M	PF1004954	1.245	3000
EXTRA ENLIGHTED 48MM TRACK 3M	PF1004955	1.050	3000
LOCKING AREA	PF1004956	1.205	800
HEADBOARD CARS			
HEADBOARD CAR	PF1004912	2.500	280
HEADBOARD CAR AUTOLOCK	PF1004957	2.800	400
BATTEN CARS			
TOP BATTCAR FAST 140MM M18 (FAST PIN)	PF1004913	1.050	140
BATTCAR REINFORCED 140 MM M18	PF1004914	0.850	140
INTERMEDIATE / REEF / TACK CARS			
INTERMEDIATE CAR 70MM	PF1004915	0.290	70
INTERMEDIATE CAR 110MM	PF1004916	0.450	110
TACK / REEF CAR 140MM	PF1004917	1.130	140
ROCKET BATTEN RECEPTACLE		See page 69	

* All cars are available with ball bearings.

- KMS100 is an ultra customizable range of tracks and cars. Call us to share your project.

WOOD RANGE

Classic modern, performance and aesthetics for all.

The use of carbon or linen fibers in our products makes it easy to incorporate a thin layer of natural wood. This slight touch of refinement is not reserved for an elite or only so-called classic sailboats.

Products now available in wood veneer version: the whole range of furlers, KBRC blocks, KJC jammers, KWH handles, carbon batten housings...



© Karver Systems

KWH

HANDLES



KBR

BLOCKS



KF

FURLERS



KJ

JAMMERS



+ Benefits

- Unique aesthetics.
- Differentiation.
- Does not affect performances.
- Accessible prices.
- Several types of wood available.



KARVER & THE ENVIRONMENT

Karver is above all a team of sea enthusiasts. When you deeply love the sea, you strive to take the greatest care of it.

In 2005, we were pioneers by integrating sourced organic linen into the plastics of our KB blocks. This was the opportunity to be one of the first nautical companies to reduce our carbon footprint.

In 2015, while ecological awareness is awakening, we were integrating the principle of eco-design in our new products.

In 2021, we file the patent which consists in using composite materials for the continuous line wheel of our furlers. There is only one step to take to gradually replace carbon fibers with linen fibers. On the strength of this progress, we now offer the EcoConcept version which offers a much more virtuous Life Cycle Analysis than aluminum furlers.

When we work with materials such as aluminum, stainless steel, titanium or carbon, we cannot be faultless. This is even truer when our industrial process is based on subcontracting. However, we are perfectly honest and legitimate in our approach to improve. When there is a long way to go, the first step is often the most important.

We are doing our best. Our approach is sincere and professional. We are members of the "Communauté des Coqs Verts", the EcoVoile group and many other associations whose vocation is to improve sustainability across our industries. While waiting to be perfect, we continue to offset our carbon impact by planting trees in central France, with over 1,500 trees in 2021.



© FlyUp Drone / Karver-Systems.



► KB Linen (2005).



► KF EC furler in linen fibers.



NEW WEBSITE

WWW.KARVER-SYSTEMS.COM

Info, advice, plans, prices, videos, choice aids,
educational articles, interactive maps...

And much more !

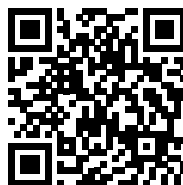

www.karver-systems.com



NEWS

Launch of an online store



We offer a database over 2,000 sailboats
to help you find the perfect furler for your use.



We offer for free 3D files in our library
for simple and useful products.

CONTACT US

- ▶ Karver Systems Headquarter: Avenue Marcel Liabastre - 14600 Honfleur - France
- ▶ Karver Systems Sales & showroom: 1 rue d'Estienne d'Orves - 56100 Lorient - France

Email: contact@karver-systems.com

Phone: + 33 (0)2 31 88 37 98 - Fax: + 33 (0)2 31 88 56 43

**ONE
STEP
AHEAD**

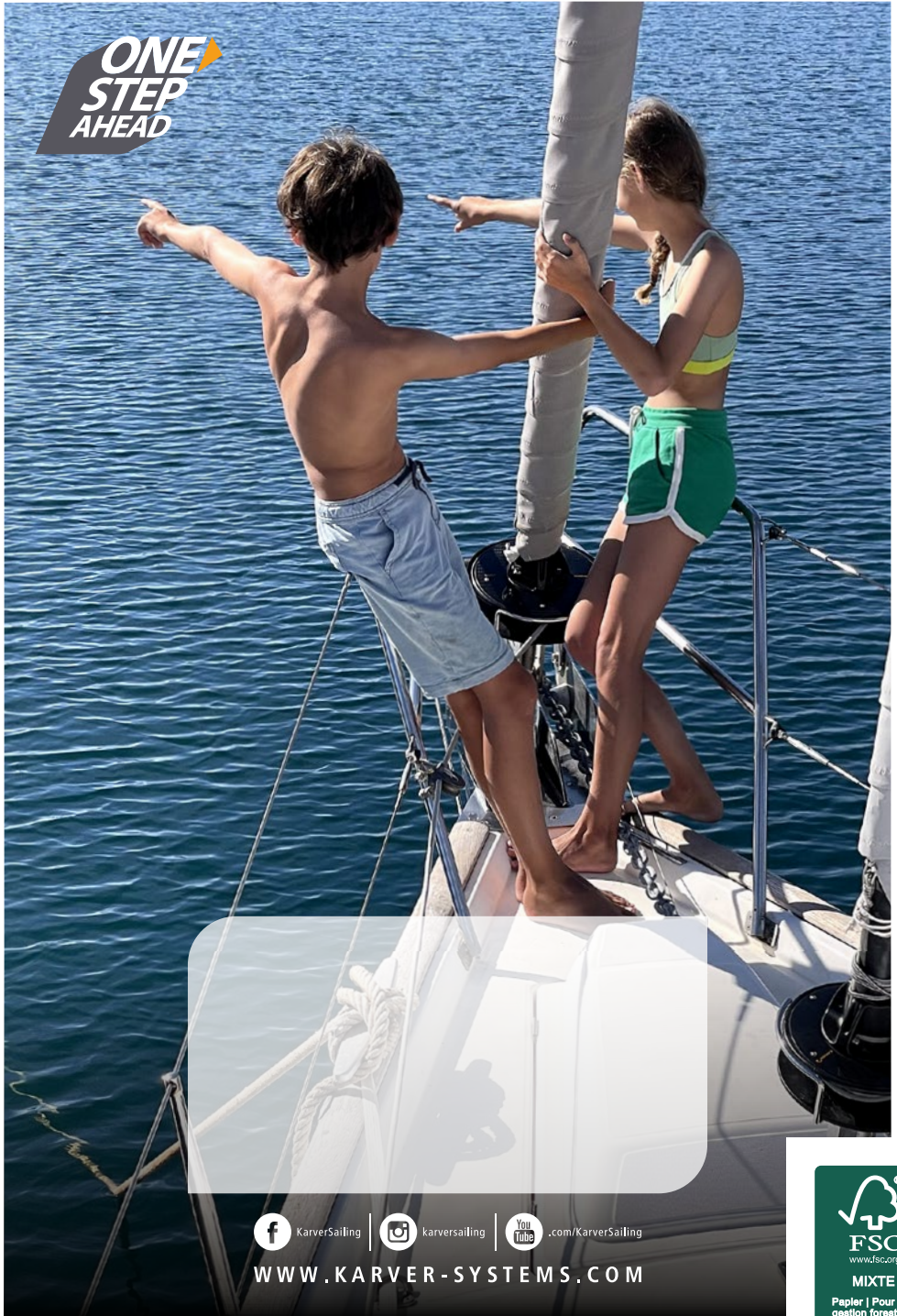

Cover © Jean-Marie LIOT V&B MAYENNE / Graphic design JASouyris



KarverSailing



karversailing



.com/KarverSailing

WWW.KARVER-SYSTEMS.COM



FSC
www.fsc.org

MIXTE

Papier | Pour une
gestion forestière
responsable

FSC® C174460