

# The New RC10 Team Car's Latest Technology

**NEW STEALTH TRANSMISSION**

**NEW DUST COVER**

**NEW TURNBUCKLES,  
FRONT AND REAR**

**NEW LOW PROFILE REAR WHEELS**

**NEW LOW PROFILE REAR TIRES**

**NEW REAR UNIVERSAL-DOGBONE/STUB AXLE**

**NEW ONE-PIECE, LOW PROFILE FRONT WHEELS**

**NEW VIPER BODY**

**NEW INLINE FRONT AXLE  
AND STEERING BLOCKS**

**NEW HARD ANODYZED, TEFLON COATED SHOCKS  
AND NEW SPRINGS FRONT AND REAR**

**NEW REAR HUB CARRIERS**

**NEW FRONT SHOCK TOWER**

**NEW SHOCK MOUNTING POSITIONS**

**NEW LONGER FRONT SHOCKS**

**NEW BLACK ANODYZED CHASSIS**

**NEW LONGER FRONT A-ARMS**

**NEW LOW PROFILE FRONT TIRES**



## Advanced, Competition Version of the RC10

# FIRST, A WORD

Your RC10 Team Car is the latest state-of-the-art, 2WD off-road racer in the world. There is none better.

Our original RC10 car has won more IFMAR World Championships and ROAR Nationals than all the other 2WD off-road winning cars put together. It is by far the most popular 2WD off-road RACE car in the world. The READERS of RC CAR ACTION magazine voted the RC10 as CAR OF THE YEAR by a 6 to 1 margin over the 2nd place car! The racers know which car is best.

As great as the original RC10 is, we wanted something better, and we know you did too, so we've brought out the new RC10 Team Car. At first glance it looks like an RC10. But it's much more than that. It has NEW longer front A-arms with two NEW shock mounting positions. NEW inline front axle and steering blocks which greatly improve the steering. NEW front shock towers which give more ideal shock mounting positions. NEW rear universal-dog-bone driveshaft, giving freer suspension and eliminating lost dogbones. NEW rear hub carriers with more toe-in for greater stability. NEW turnbuckles for easier adjustments. NEW low profile front and rear wheels and tires, giving more steering in the front end and more traction in the rear end.

This kit also contains our NEW STEALTH TRANSMISSION and our newly-designed shock absorbers with hard anodized plating and Teflon coating.

At the 1990 Off Road ROAR Nationals, Team Associated finished 1st, 2nd and 3rd using these new parts. Cliff Lett won the Nats, which didn't surprise anyone, but the big surprise was Brent Wallace and J. D. Beckwith, both who finished 2nd and 3rd at the very first race they ever ran the new STEALTH TRANSMISSION! We are getting similar reports of equal success from racers all around the world after using the STEALTH TRANSMISSION in their older RC10's. But you now have the complete, NEW TEAM CAR and we know this combination will also help you greatly improve your performance. Good luck in your racing!

You'll find the photos in the instructions so easy to follow that you may be tempted to put the car together from the photos alone. However, although you have the best car kit, if you want the best COMPLETED model race car, then you will want to put it together correctly—by following these instructions. All that's required is to read the few lines of text near each photo.

**DON'T OPEN ANY OF THE PARTS BAGS UNTIL THESE INSTRUCTIONS TELL YOU, otherwise you'll get the parts mixed up and then you will have trouble assembling your car.**

While you are building the car you will sometimes be working with several parts bags at the same time. These bags are referred to by number in the instructions, and you will find a number label on each of the main parts

bags. There are also more bags inside the main parts bags; these are not numbered and belong to the bag they came out of.

Bags and parts will start multiplying like rabbits as you build, so try to keep the bags separate. One good way is to use large paper plates (picnic plates with partitions are best). Mark the plates with bag numbers and dump the parts into them. When the parts are used up, relabel the plate for another bag. It's much easier to find the part you need if it's spread out where you can see it.

**TOOLS.** The kit contains the shock wrench and all the Allen wrenches you'll need, but you will have to supply the following:

#2 Phillips screwdriver (Associated #SP76)

A needle-nose pliers

A hobby knife, such as an X-acto with a pointed blade

A soldering iron (25 to 50 watts), and a small amount of ROSIN (not acid) core 60/40 solder.

The kit can be assembled even easier if you have the following:

3/32" straight Allen wrench with handle. Will make installing the Allen screws much faster and easier (Associated #SP73)

A ruler with decimal inches or metric measure

A 3/16" nut driver will make installing the ball ends easier (Associated #SP86)

A 1/4" nut driver will speed up installing the 1/4" nuts (#SP85)

Socket or open-end wrench

Small screwdriver

Thread-locking compound

ZAP or Hot Stuff (cyanoacrylate adhesive)

Vise

File

Drill with #43 (2.3 mm) bit

**WARNING!** Do not use a power screwdriver. They spin too fast, causing screws to heat up when being driven into plastic and will strip out.

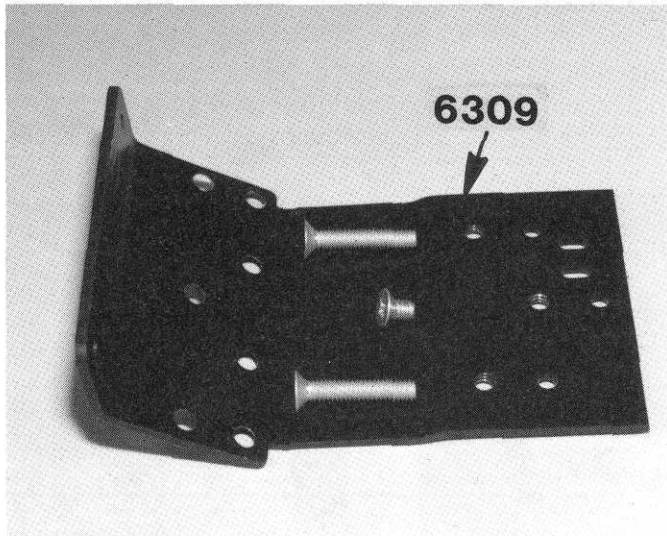
**Take your time assembling the car.** It's not a race to see how fast you put the car together; it's how well you put it together that determines how fast you'll be able to race.

Boxes at each step are provided so you can put a check mark for each assembly after each step is completed. So when you stop during assembly time, you'll be able to come back and start in the correct step.

One final note for you experienced builders and racers: **please build the car our way first!!** The RC10 Team Car is a remarkably fast car right out of the box. There's a reason for everything on the car, and very few compromises were made in its design. Work with the car first and see what it can do before you experiment or make changes.

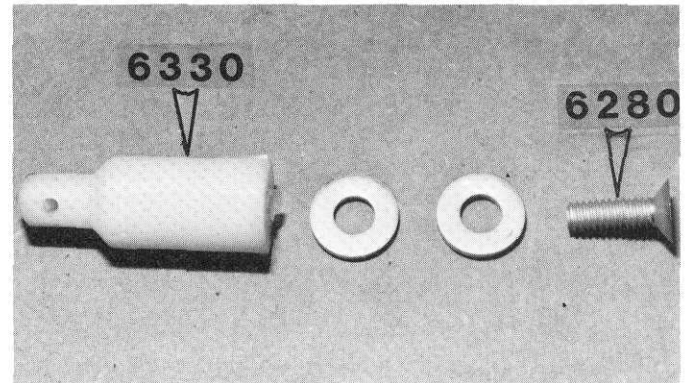
Clear off your workbench, line up some paper plates, grab a sandwich, and *let's begin.* . .

□ **Fig. 1** We'll start with fig. 1. Only take the parts out of the bag that we tell you, and no others. Look for Bag #6-4 and take the #6309 black anodized nose piece out of the bag, as shown in the photo, and the shortest Phillips flat head screw, as shown. DO NOT take anything else out of the bag. Now take the 2 Phillips screws out of Bag #6-2, but nothing else.



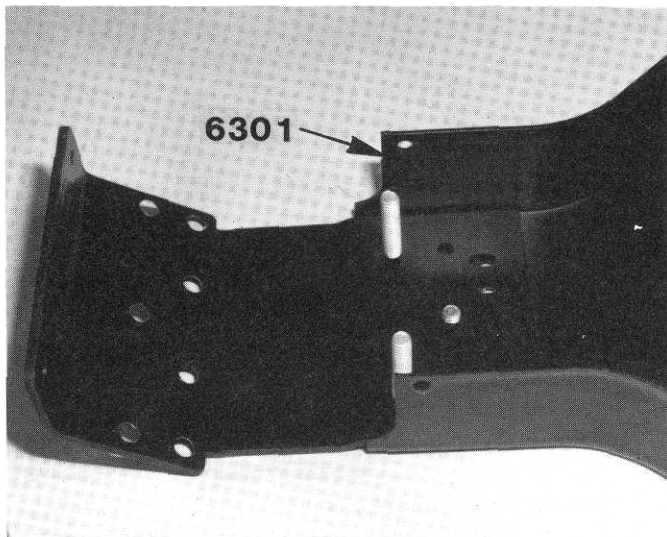
**Fig. 1**

□ **Fig. 3** In Bag #6-5, take one #6330 body mount, 2 washers and one short screw. (The long screw is used to extend the body mounts for other body styles.)



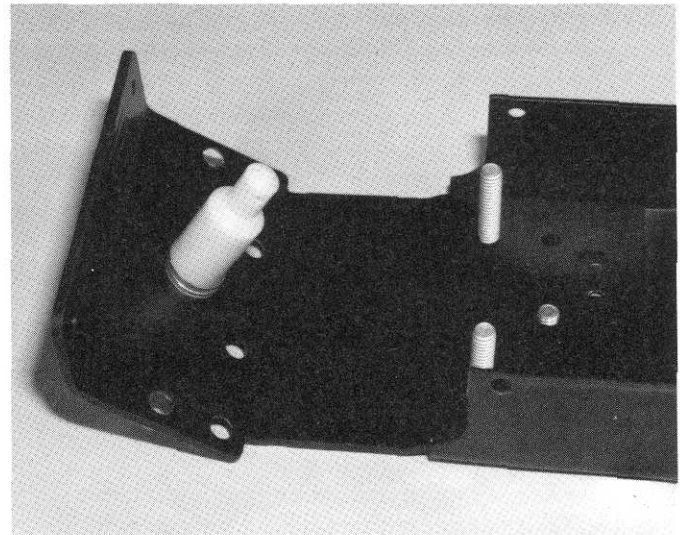
**Fig. 3**

□ **Fig. 2** Take the black aluminum chassis #6301 and install the nose piece, as shown, with the #2 Phillips screwdriver. Note that all the chassis screws are aluminum and can be easily damaged by a worn screwdriver. Be sure yours is in good condition.



**Fig. 2**

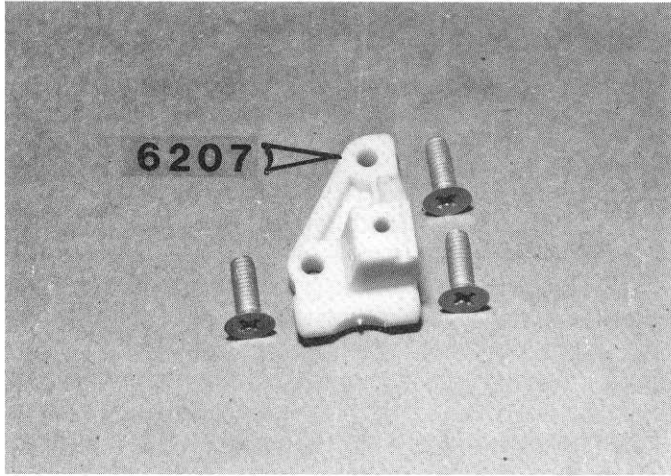
□ **Fig. 4** Install body mount as shown with body clip hole going left to right.



**Fig. 4**

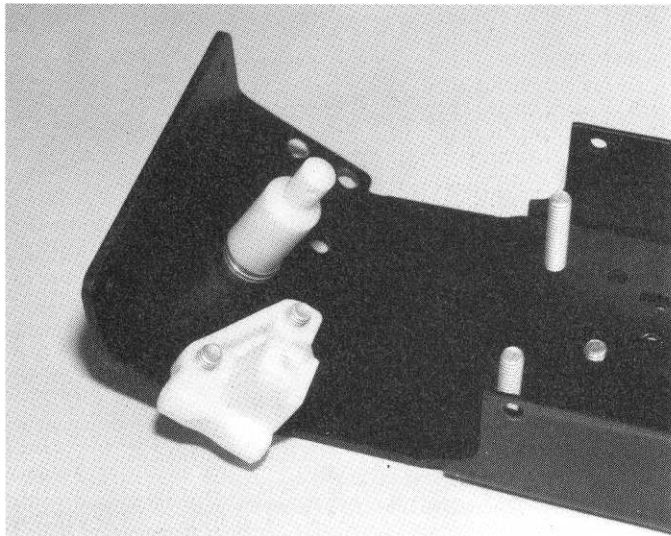
□ **Fig. 5** In Bag #6-1, take out the left hand front suspension mount #6207. This mount will have the letter L on the bottom. The left or right hand side of the car is determined by the driver as he sits in the car. His left hand will be the left side of the car and his right hand the right side.

NOTE: The left and right front suspension mounts are attached together by a thin "runner" that must be removed with scissors or a knife.



**Fig. 5**

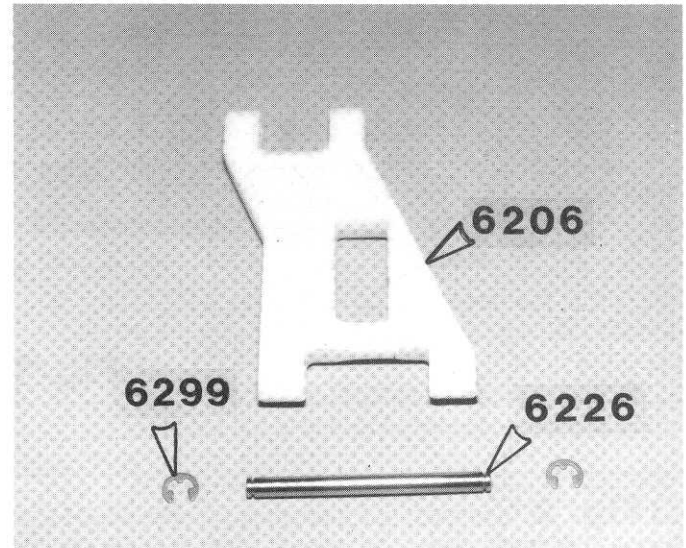
□ **Fig. 6** Install the L.H. suspension mount, as shown, with the 3 Phillips screws. Now install the right hand mount.



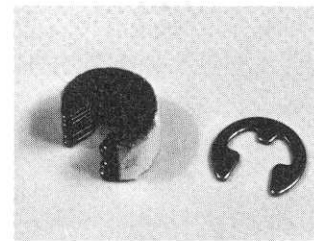
**Fig. 6**

□ **Figs. 7 & 7a** In the same bag, take out the #6206 L.H. front A-arm, the #6226 inner pin and the package of "E" clips, as shown.

NOTE: The package of "E" clips is in the form of a "stack" or short roll with white paper glued around the outside (see fig. 7a). There is a roll of "E" clips in three different bags. You will have more than enough to complete your car. Slip the pin into each end of the front A-arm #6206 to check the pin fit. The A-arm should be able to swing freely on the pin. Most racers keep a .126" and a .128" reamer in their toolbox to free up A-arms and to clean them after racing. We want the pin to fit tight in the mount #6207.

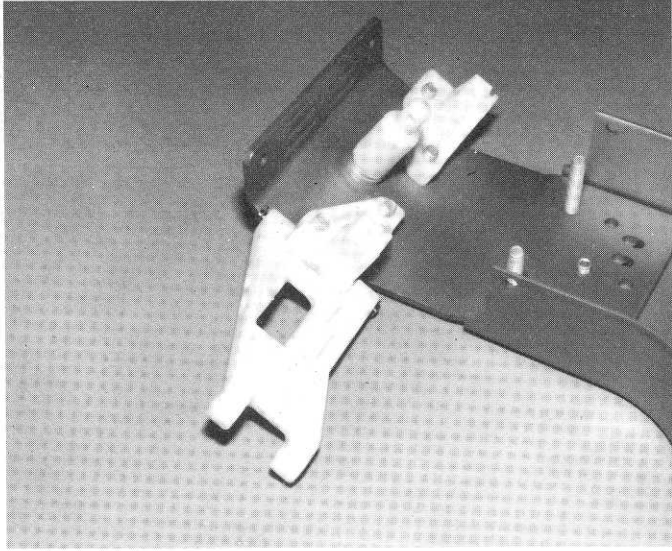


**Fig. 7**



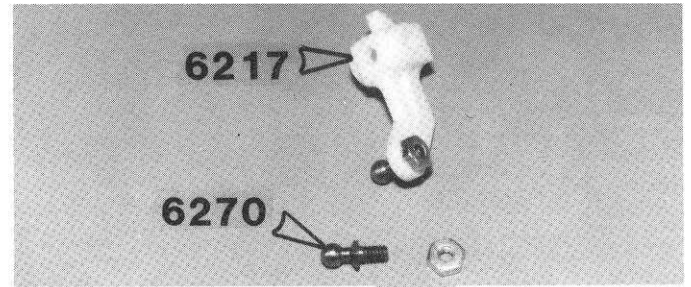
**Fig. 7a**

□ **Fig. 8** Line up the A-arm with the mount and push the pin through. Using a small screwdriver, install an "E" clip on each end of the pin. Now install the R.H. side.



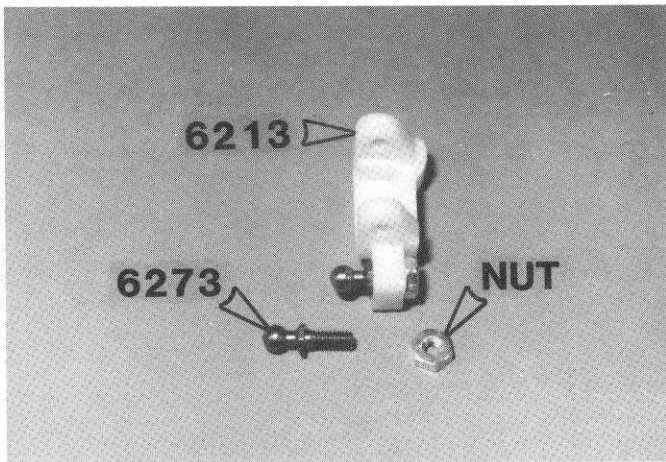
**Fig. 8**

□ **Fig. 10** Screw the short ball end #6270 into the #6217 steering block and secure it with the nut as shown. Assemble the right hand side, which will be inserted into the opposite side shown in fig. 10.



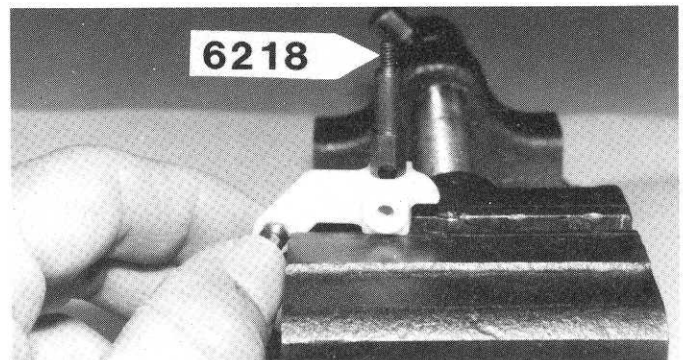
**Fig. 10**

□ **Fig. 9** From Bag #6-14 screw the long ball end #6273 into the left hand front block carrier #6213 as shown, then screw on the locking nut. Assemble the right hand parts.



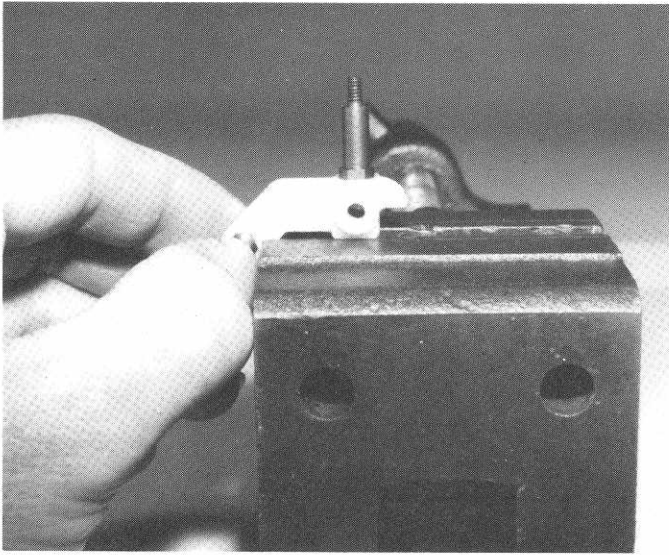
**Fig. 9**

□ **Fig. 11** Push the front axle #6218 into the steering block #6217 as shown so the hole in the axle lines up with the hole in the steering block. It may push together with your fingers. If not, LIGHTLY tap it into the hole. Assemble the right hand side in the same way.



**Fig. 11**

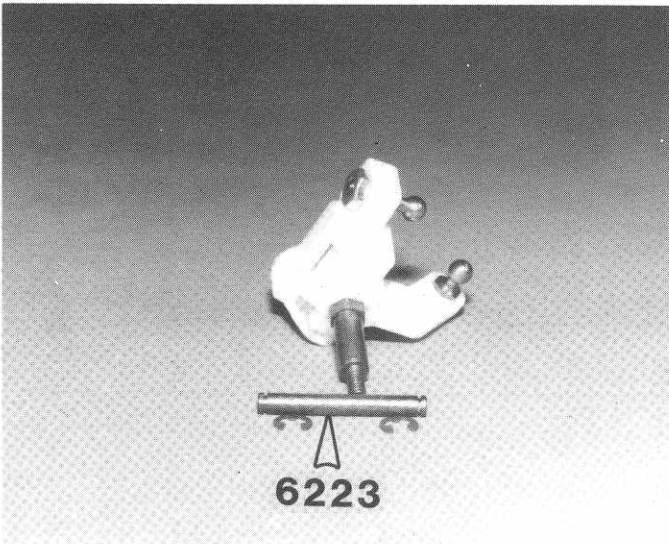
□ **Fig. 11a** You'll notice that the hex part of the axle does not go all the way into the steering block. That's O.K. Just make sure the hole in the axle is lined up with the hole in the steering block.



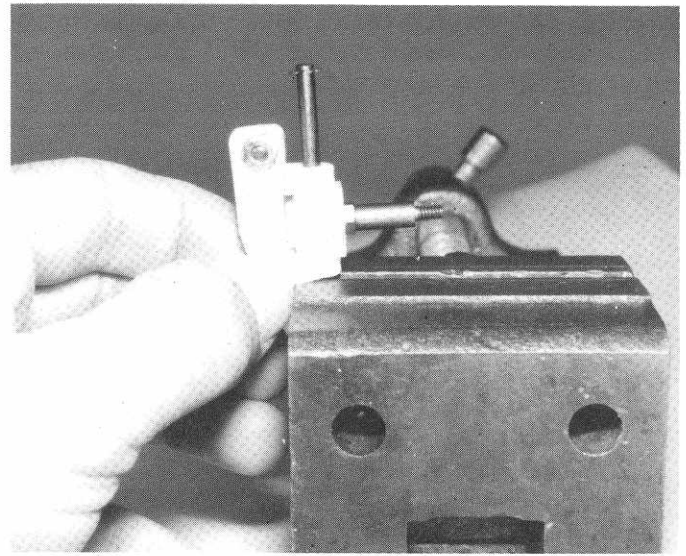
**Fig. 11a**

□ **Figs. 12 & 12a** Line up the steering block in the block carrier, as shown, and push the #6223 king pin through. Now, install "E" clips on the top and bottom ends of the pin. If you run out of "E" clips, there are extras in the shock bags. Install the R.H. steering block.

The pin will be loose in the block carrier but will be snug in the steering block, so you might have to lightly tap it in.

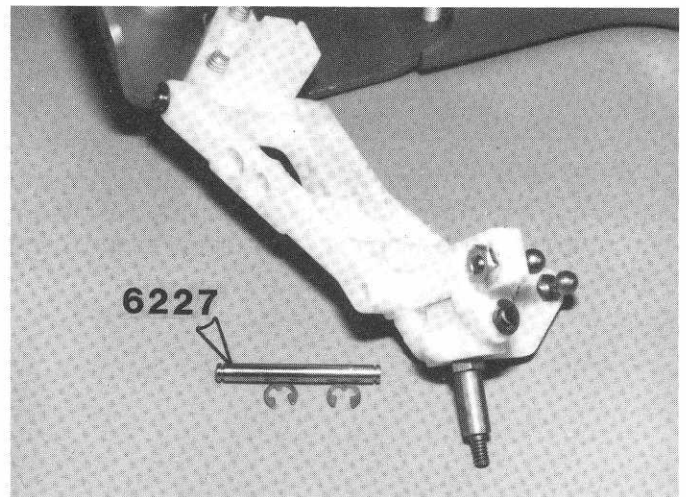


**Fig. 12**

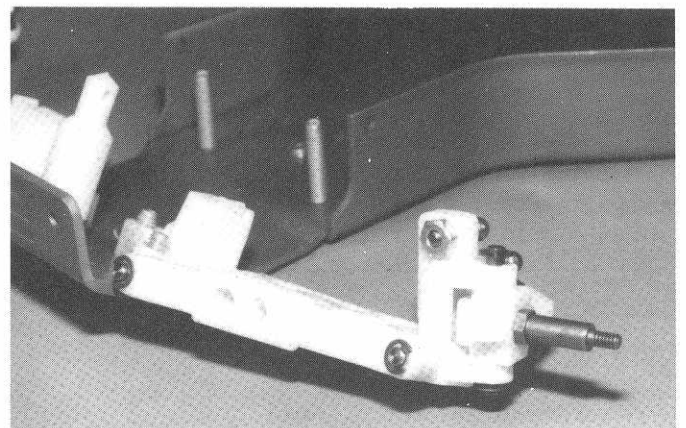


**Fig. 12a**

□ **Figs. 13 & 13a** Line up the holes in the block carrier with the holes in the A-arm and push the #6227 outer pin into the arm. Install the "E" clips. Do the R.H. side.

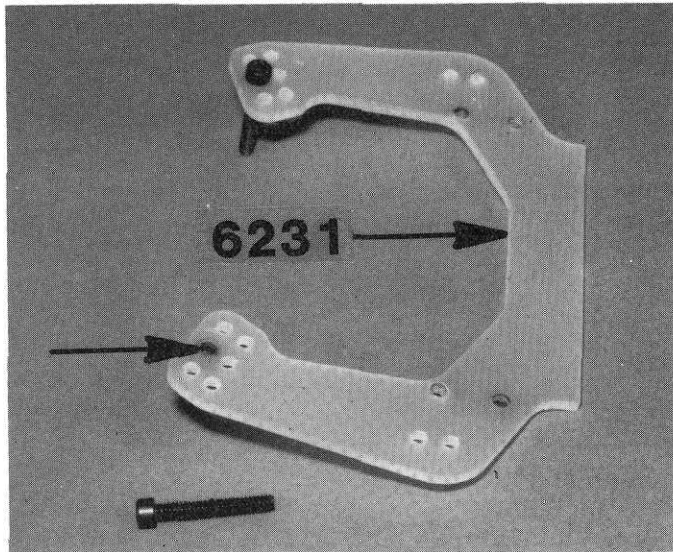


**Fig. 13**



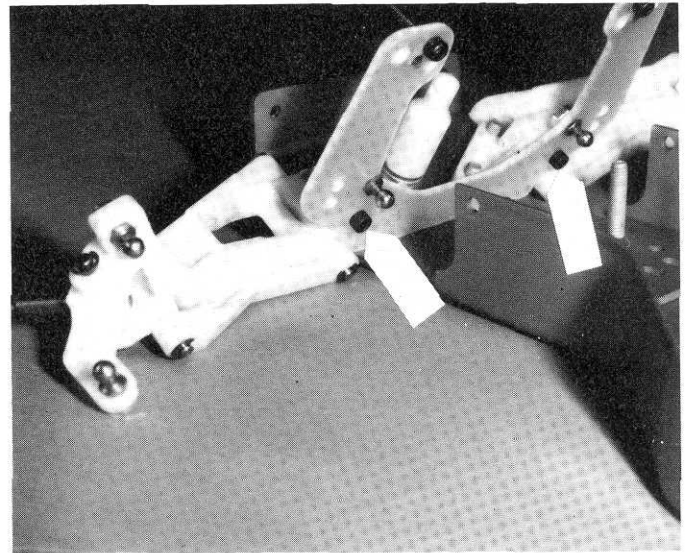
**Fig. 13a**

□ **Fig. 14** Take the #6231 front shock strut out of the same bag. In Bag #6-10 take out 2 of the 4/40 screws and install them in the shock strut in the locations shown.



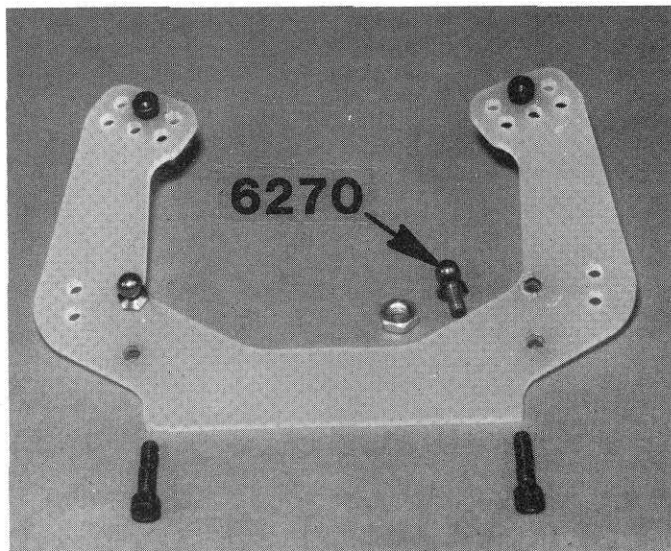
**Fig. 14**

□ **Fig. 15** From Bag 6-1 take the 2 short 4/40 screws and install the shock strut onto the 2 front suspension mounts. If the holes don't line up, loosen the aluminum screws in the chassis, align the parts and tighten all the screws.



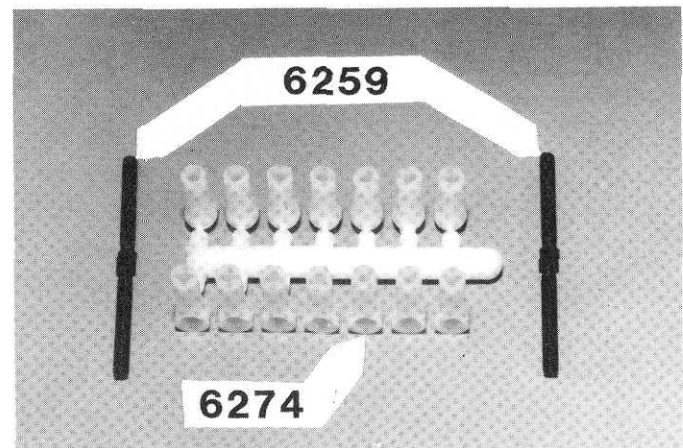
**Fig. 15**

□ **Fig. 14a** Take 2 of the short #6270 ball ends and install them in the shock strut in the locations shown. Then install the 2 nuts on the other side.



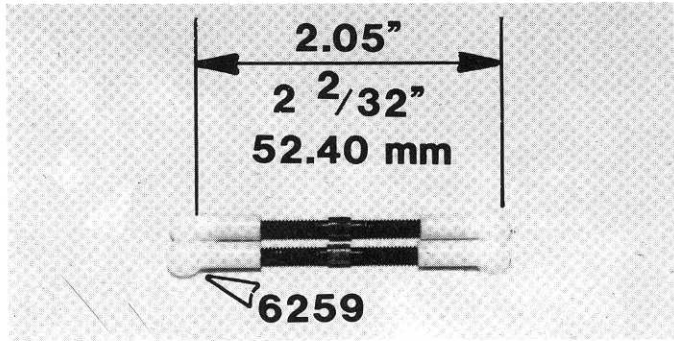
**Fig. 14a**

□ **Fig. 16** In Bag #6-1 take out the 2 #6259 threaded turnbuckles, and from bag #6-14 take out the #6374 plastic ball rod ends, as shown. Twist the rod ends and take 4 of them off.



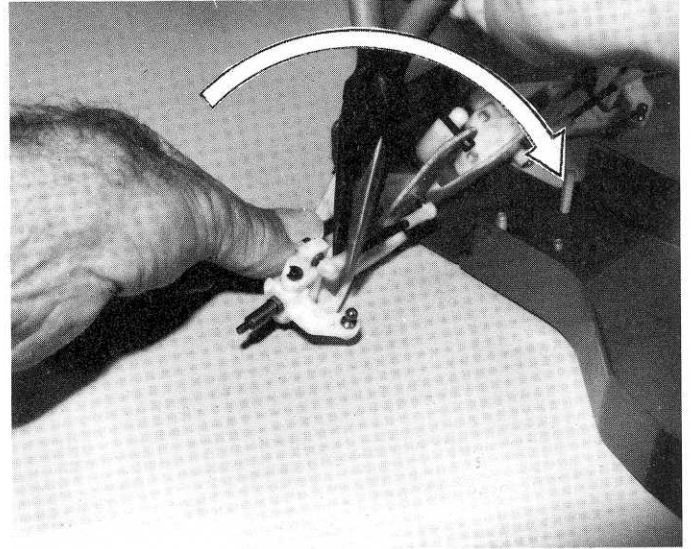
**Fig. 16**

**Fig. 17** Screw the plastic ball rod ends onto the rods, as shown. The rods have a LH thread on one end and a RH thread on the other end, so they will screw on in different directions. Screw them on evenly to the dimension shown, which is measured from the center of the ball cup.



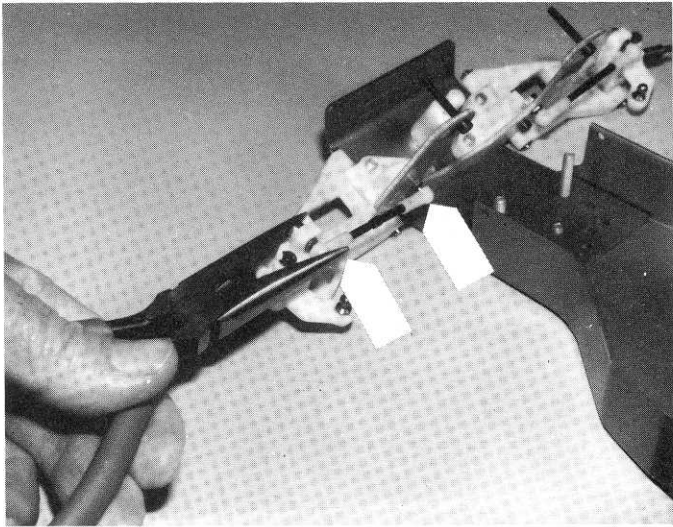
**Fig. 17**

**Fig. 18a** The rod ends can be removed quite easily from the balls by holding the rod end with a pliers, as shown, and twisting the rod end off the ball, as shown.



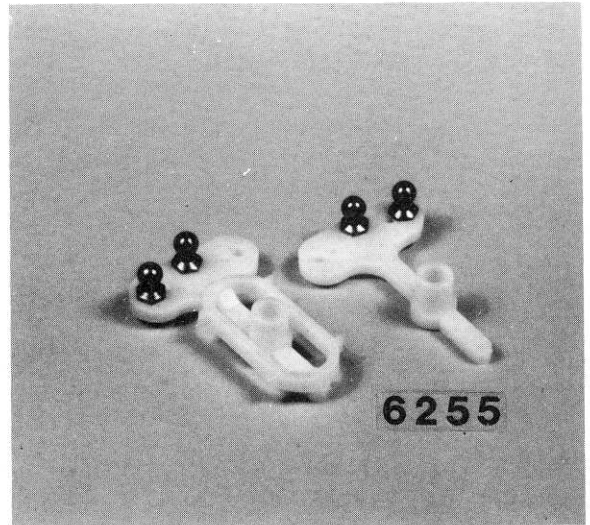
**Fig. 18a**

**Fig. 18** Snap the rods on the metal balls, as shown. You'll probably have to use pliers. Do the R.H. side.



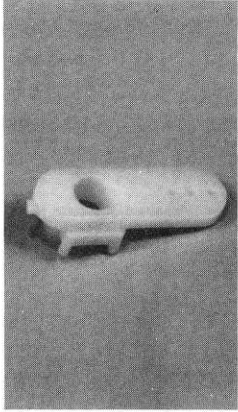
**Fig. 18**

**Fig. 19** In Bag #6-2, take the #6255 servo saver parts, and install the 4 short ball ends, as shown.

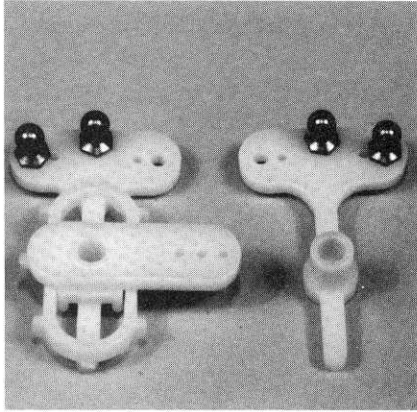


**Fig. 19**

- Fig. 20** Locate the servo saver arm...
- Fig. 21** and install it to the servo saver, as shown.

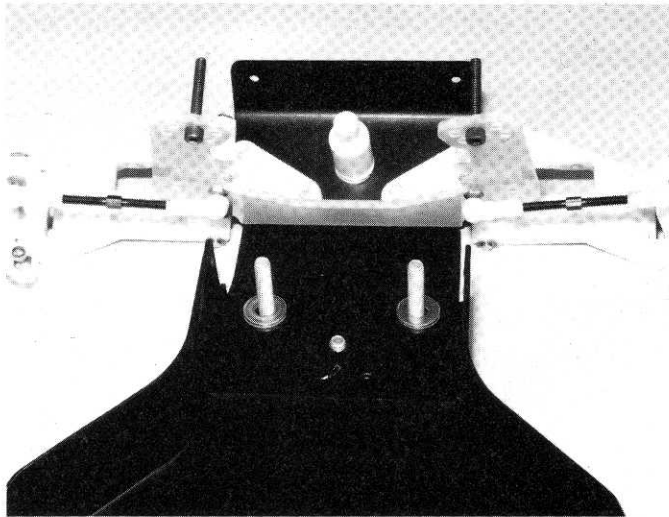


**Fig. 20**



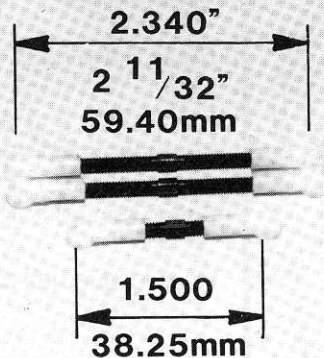
**Fig. 21**

- Fig. 22** Take the 2 thick washers out of the same bag, and put them on the 2 screws, as shown.



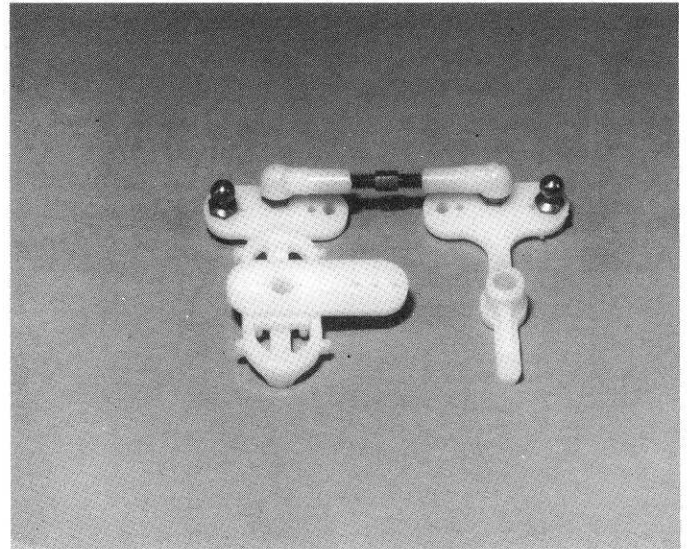
**Fig. 22**

- Fig. 23** Take the two long and one short turnbuckles and screw on the six plastic ball cups to the lengths shown.



**Fig. 23**

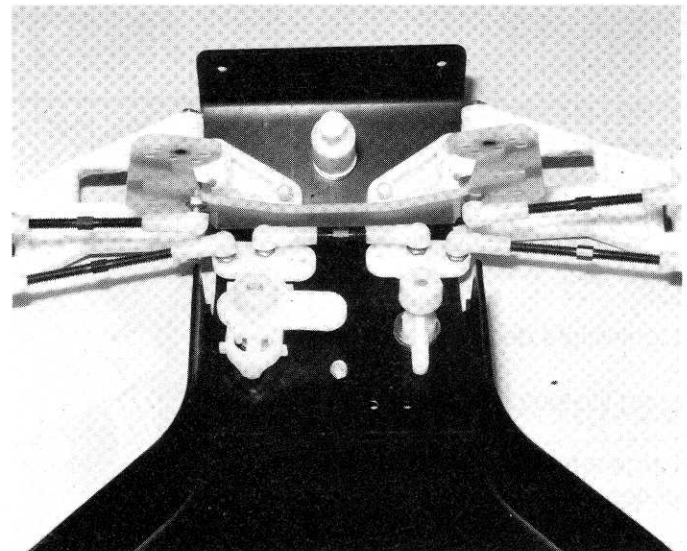
- Fig. 24** Take the short rod and pop it on the servo saver with a pliers, as shown.



**Fig. 24**

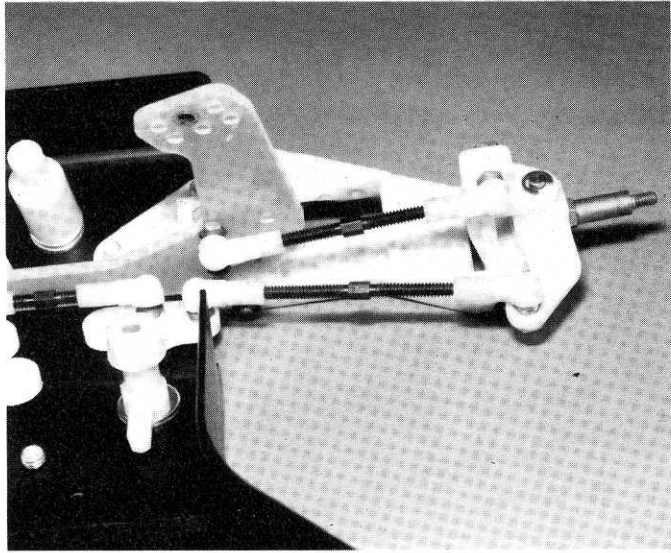
- Fig. 25** Place the servo saver onto the 2 screws, as shown. Take the 2 nylon nuts and screw them down until the servo saver starts to tighten, then back the nuts off about 1/2 turn until the servo saver arms pivot freely.

Note: Team drivers will put a couple of small tie-wraps around the flex arms on the servo saver to pick up additional steering. CAUTION: This will also increase the load on the servo gears and possibly strip gears.



**Fig. 25**

□ **Fig. 26** Snap the L.H. and R.H. tie rods on, as shown.



**Fig. 26**

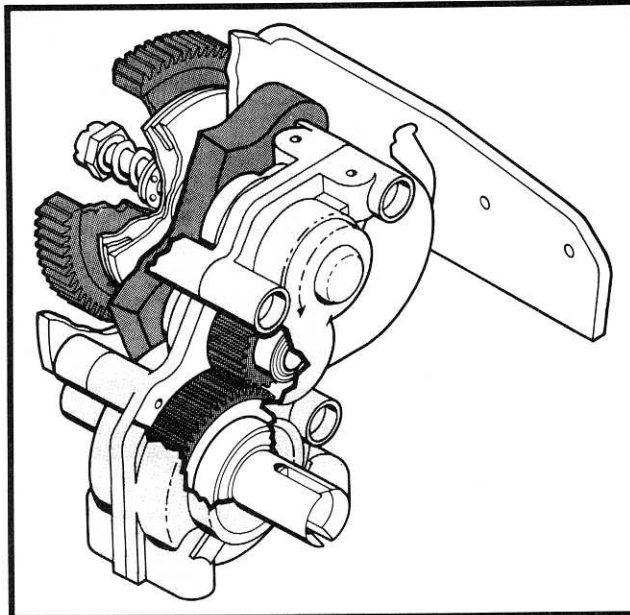
TEAM ASSOCIATED  
**STEALTH**  
A T C TRANSMISSION

*Transmission*  
for the **RC10**

## INSTRUCTIONS

### Featuring:

- Quick-change spur gear
- Case-to-motor plate dirt-proof seal
- Lightweight design
- Long-life clutch friction plate
- Large area/high torque clutch plates
- Low inertia drive train



- Precision-molded 48 pitch gears with extra low 2.25 final drive ratio
- Reversible motor mounting
- Gold anodized mounting plate
- Class 3 stainless steel ball bearings
- Tungsten carbide differential balls
- Teflon sealed ball bearings
- High torque ball differential

# STEALTH TRANSMISSION

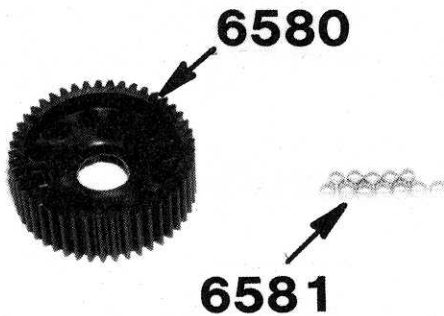
We feel this transmission is the best in the world. It has enabled Team Associated to finish 1st, 2nd and 3rd at the World Championships in Australia and 1st, 2nd and 3rd at the ROAR Nationals in Northern California with our RC10 car. With this transmission your RC10 will be much easier to drive, enabling you to cut your lap times by a considerable amount. But it all depends, of course, on how well you assemble and maintain your transmission. So take your time and do it to the best of your ability.

□ **Figs. 27 & 27a** We'll start with Bag A, the differential. Take out the #6580 diff gear and the bag with the 12 large #6581 carbide diff balls. These carbide diff balls are the best there is. They will outlast the diff washers at least 10 times. NEVER replace these balls with any other balls except our #6581 carbide diff balls.

Now take out the #6591 Stealth white silicone diff lube. Another word of caution. DO NOT substitute any other type of diff lube on the balls. It took us countless hours of testing to find the correct silicone diff lube to make the diff work correctly. Do yourself a favor: use what comes in this kit!

### Trim any excess flash off the inside of the gear.

Fill the holes in the gear with the silicone diff lube and then push the 12 carbide balls into the holes. Wipe the excess lube back into the ball holes with your finger.



**Fig. 27**



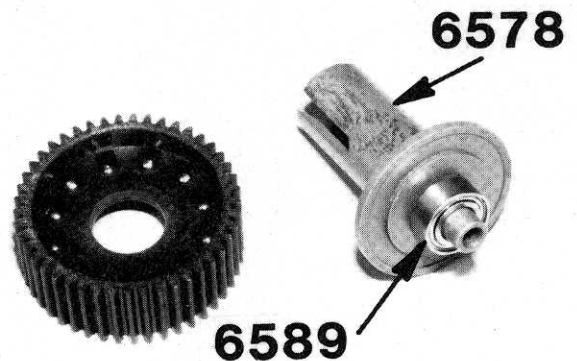
**Fig. 27a**

□ **Fig. 28** Your gear.



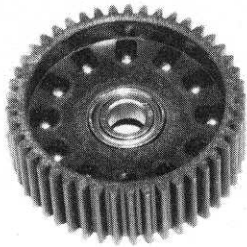
**Fig. 28**

□ **Fig. 29** Clean all the silicone grease off your hands and push one of the #6589 ball bearings into the center of the gear. **CAUTION:** there are three bearings that have the same diameter, but different hole sizes. Make sure you use the #6589 bearing that fits onto the left hand hub, as shown.



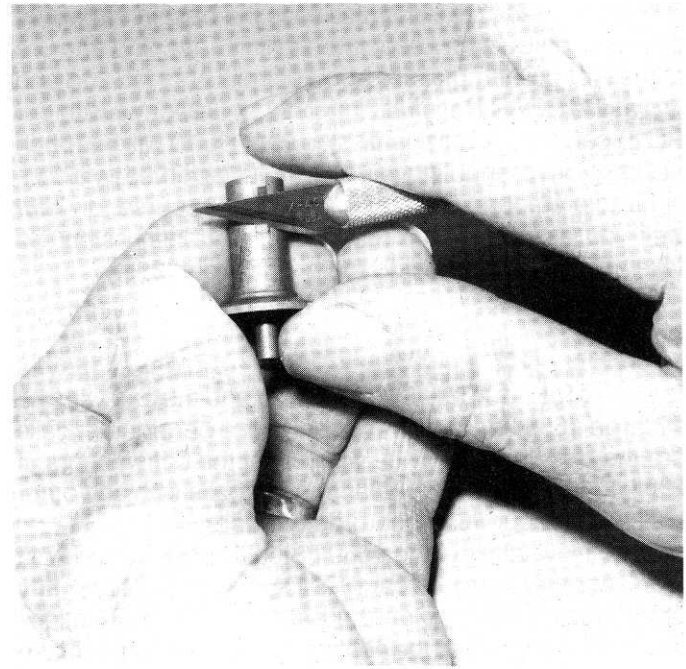
**Fig. 29**

**Fig. 30** Your completed gear.



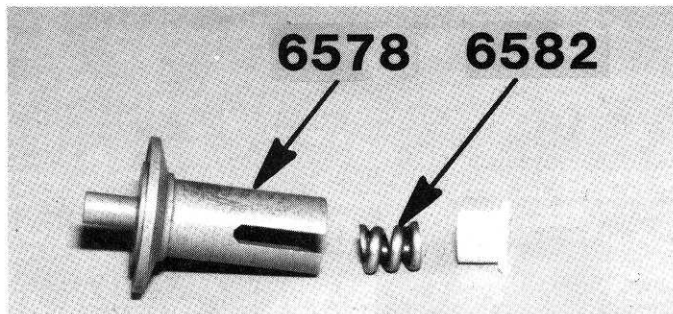
**Fig. 30**

**Fig. 33** Take an Exacto knife and trim off any of the plastic T-nut that extends outside of the slot, as shown.

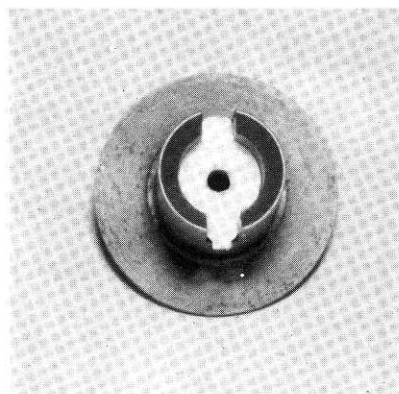


**Fig. 33**

**Figs. 31 & 32** Take out the #6578 left hand diff outrdrive hub and **make sure it's clean and free from all burrs**. Push the #6582 diff thrust spring into the hub and then align the plastic T-nut with the slots in the hub and push the T-nut all the way in against the spring.

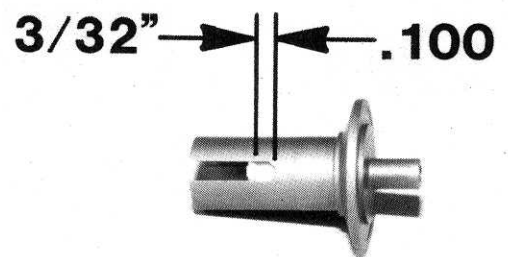


**Fig. 31**



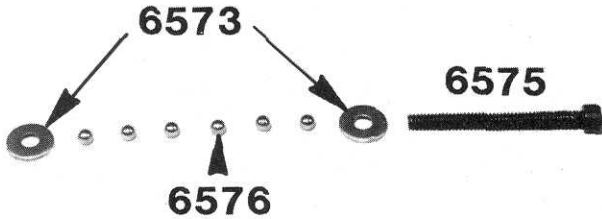
**Fig. 32**

**Fig. 34** There should now be approximately a  $3/32$ " or  $.100$ " gap where shown.



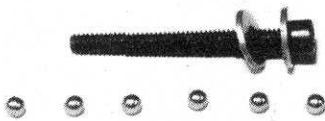
**Fig. 34**

□ **Fig. 35** Take out the #6575 diff thrust bolt, the two #6573 diff thrust washers and the #6576 carbide thrust balls.



**Fig. 35**

□ **Figs. 36 & 37** Slip the two washers on the bolt, as shown, and then fill the area between them with the #6588 black grease. DO NOT use the black grease on the diff balls in the gear.



**Fig. 36**



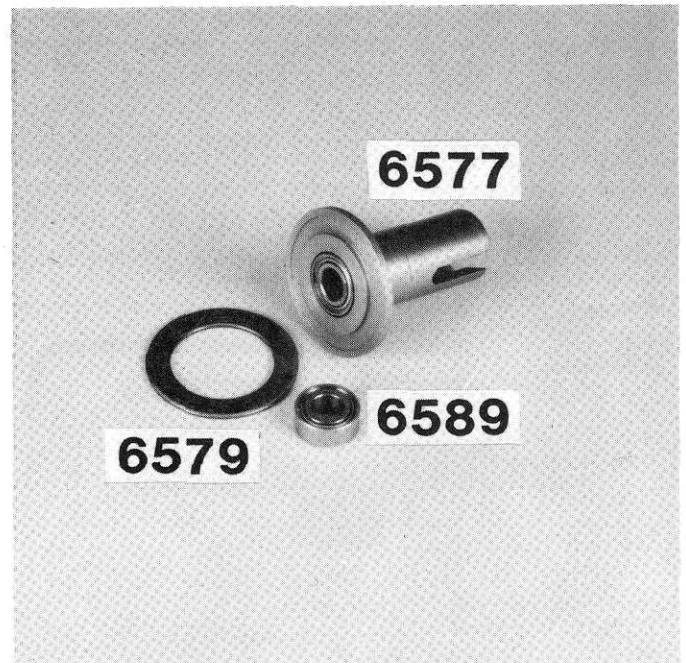
**Fig. 37**

□ **Fig. 38** Now take the balls and place them all around the bolt between the two washers. The grease will hold them in place.



**Fig. 38**

□ **Fig. 39** Take the #6577 right hand diff outdrive hub, **make sure it's clean and free of all burrs**, and put one of the #6589 ball bearings into the hub. Now place one of the #6579 diff drive rings onto the hub. The ball bearings must go in with a simple push of your finger. **NEVER drive them in!**



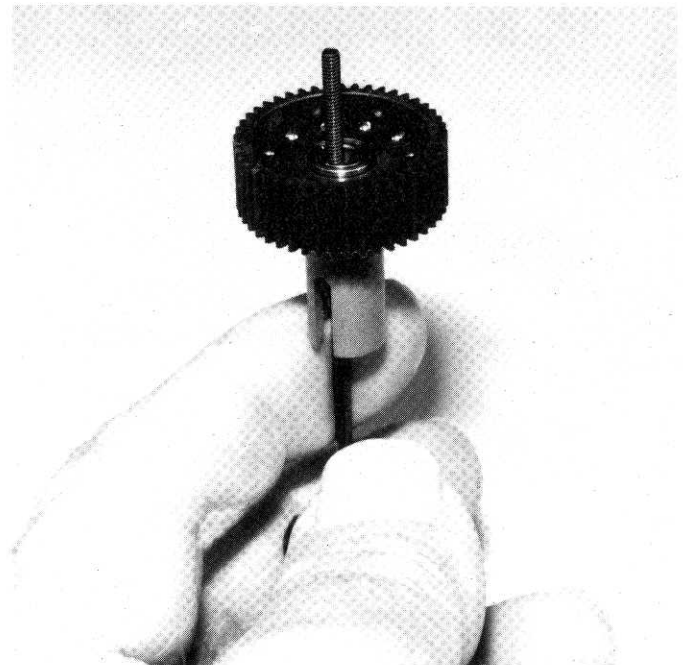
**Fig. 39**

**Fig. 40** Your hub should look like this. DO NOT try to pin the drive ring to the hub. The hub is designed to lock the drive ring without pinning. Leave AS IS.



**Fig. 40**

**Fig. 42** Turn the assembly upright. Make sure the drive ring is still ON and centered. Slip the diff gear onto the bolt as shown.



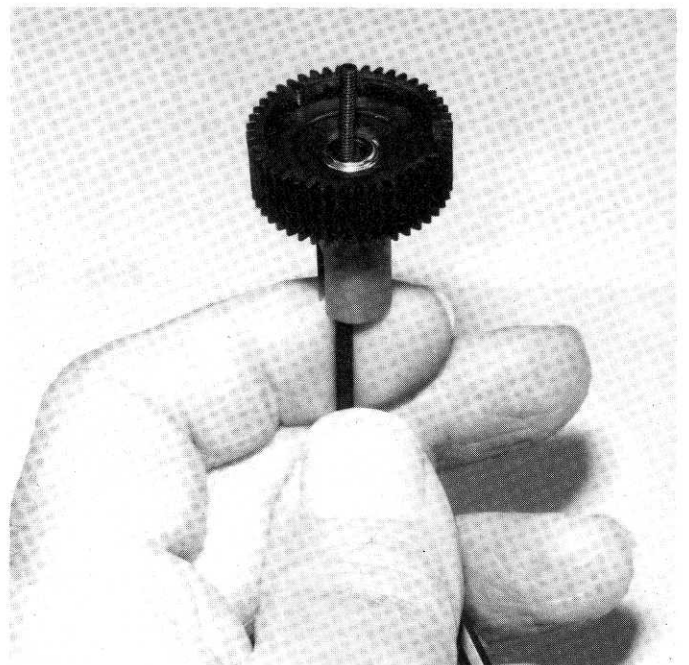
**Fig. 42**

**Fig. 41** Slip the Allen wrench into the bolt head and then slip the assembly into and through the right hand hub.



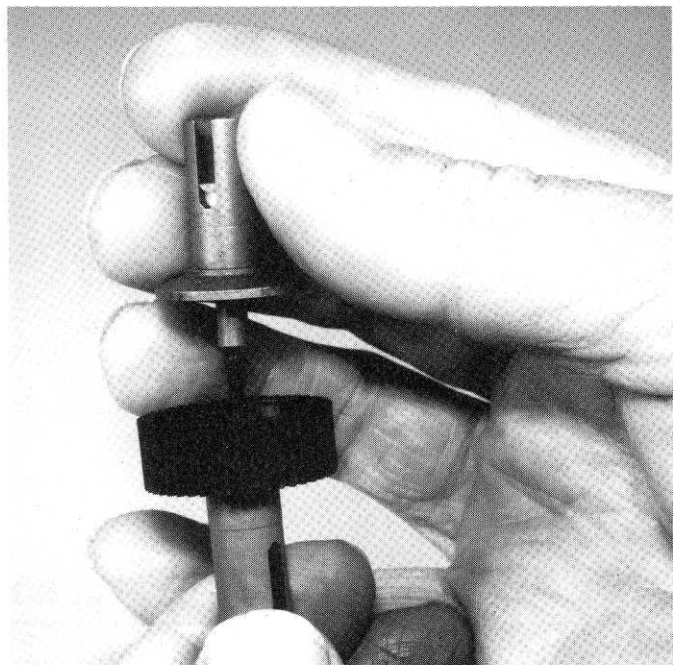
**Fig. 41**

**Fig. 43** Now place the other drive ring onto the diff balls and center it as close as possible to the gear.



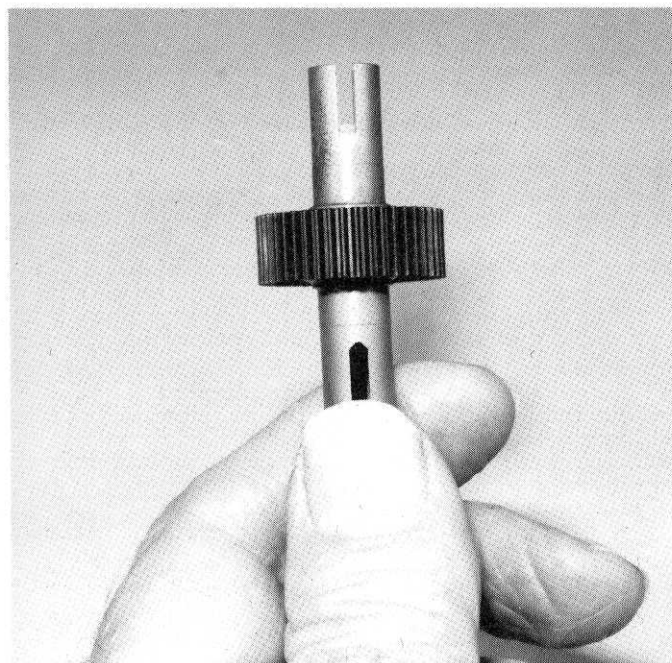
**Fig. 43**

□ **Figs. 44 & 45** Slip the left hand hub down onto the bolt, making sure the hub centers itself onto the drive rings. THIS IS IMPORTANT.



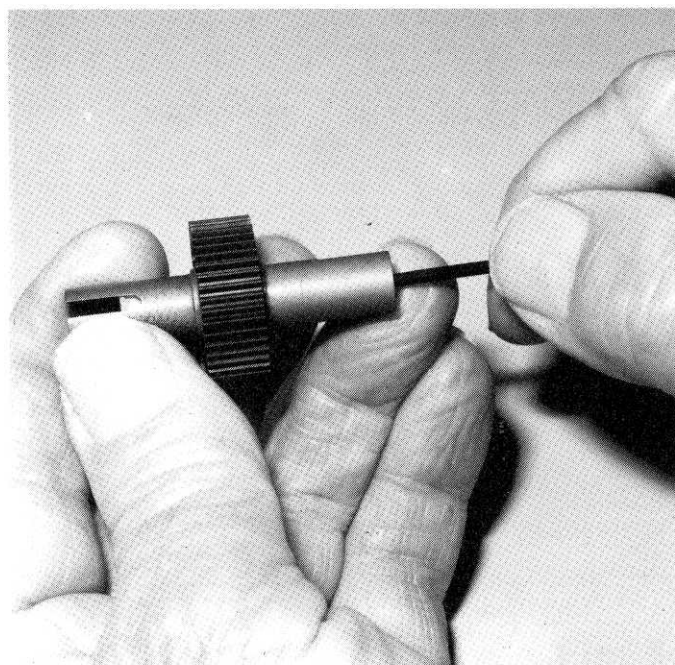
**Fig. 44**

□ **Fig. 45** Now start to tighten the bolt with the Allen wrench, making sure the hubs and drive rings stay centered. Do this very slowly. We want to make sure everything stays centered. We'll finish the tightening in the next step with figs. 46 & 47.



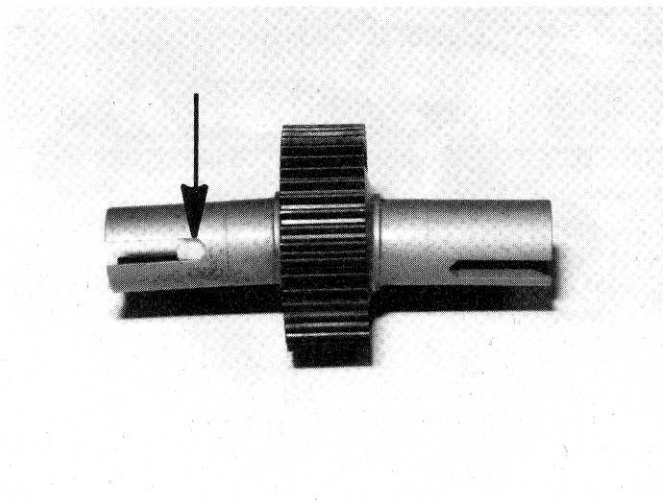
**Fig. 45**

□ **Figs. 46 & 47** Continue tightening slowly until the spring is just about completely collapsed. DON'T OVER-TIGHTEN! Correct adjustment is bottoming the spring and then backing off 1/8 to 1/4 turn.



**Fig. 46**

□ **Fig. 47** As you're tightening, you'll notice the ear on the T-nut, shown by the arrow, moving closer and closer to the bottom of the slot in the hub. The spring should bottom out about the same time as the ear is at the bottom of the slot. When you feel the spring bottom out, that's when you back off 1/8 to 1/4 turn and your diff is correctly adjusted. The diff should operate very smoothly when turning the hubs in opposite directions. Recheck the adjustment before driving the car. There is never a need to adjust the diff in any other manner.



**Fig. 47**