



Futaba[®]
DIGITAL PROPORTIONAL
RADIO CONTROL

MAGNUM

INSTRUCTION MANUAL

FP-3PG

PISTOL GRIP FOR GASOLINE ENGINE
AND ELECTRIC MOTOR CARS
AM 3 CHANNELS, 2 SERVOS



FUTABA CORPORATION OF AMERICA
FUTABA CORPORATION

*Thank you for purchasing a Futaba digital proportional radio control set.
Please read this manual carefully before using your set.*

CONTENTS

FEATURES	1
CONTENTS AND RATINGS	2
TRANSMITTER FP-T3PG	3
DESCRIPTION OF OPERATION	4 ~ 8
RECEIVER AND SERVOS	9
RECEIVER, SERVOS, AND SWITCH CONNECTIONS	9
EXAMPLES OF USING THE MAGNUM	10 ~ 11
SPLINED HORNS	12
FP-S131H AND FP-S132 EXPLODED VIEWS	13

● FEATURES

The **MAGNUM Series** is the highest quality pistol grip type AM 3 channel digital proportional R/C sets for experts. It is designed for use with gas engine or electric motor cars and boats. Optional NR-5PB 5 cell Nicd can be used with receiver/servos for maximum servo speed and torque.

TRANSMITTER FP-T3PG

- Newly designed cockpit type control panel.
- Human-engineered size and design are easy to use.
- Swivel grip system. The pistol grip section and wheel control section turn over a range of 300° Superior operating ease in any position, even for lefthanded operators.
- Wheel angle adjuster.
The turning angle of the steering wheel can be increased and decreased without changing the servo deflection angle. This allows the user to adjust the rotation of the steering wheel to the most comfortable setting.
- Neutral adjuster. The throttle throw/brake deflection angle (back throw) of the throttle trigger can be freely selected from among three positions to match the application.
- Ratchet steering dual rate. An arbitrary deflection angle is selected when steering dual rate is turned on.
- Ratchet knob rudder exponential. The rudder angle can be arbitrarily selected on an exponential curve.
- Ratchet knob rudder ATV (adjustable travel volume). The servo left and right operating angles can be independently adjusted.
- Ratchet knob throttle exponential. The throttle throw can be arbitrarily adjusted on an exponential curve.
- Servo reversing switches on all channels.
- Warm-up switch. The engine is warmed up by automatically revving the throttle the monitor lamp flashes to indicate the switch is ON.
- ATL (adjustable throttle limiter) on brake trimmer. Since the brake trimmer operates as a trimmer only at the low side, linkage hook-up is extremely easy, and the amount of brakes applied can be adjusted while running.
- Brake limit trimmer.
Sets maximum brake deflection angle (low throttle position).
- Throttle high side trim knob.
Throttle system linkage is extremely easy to

hook-up. Adjustment while running is also possible.

- RF module system.
- Replaceable crystal. Crystal can be changed from the outside. Except 72 and 75MHz.
- 3 channel AM transmitter. Channel 3 uses a click knob and is best used as an auxiliary channel.
- Separable battery unit. The transmitter Nicd battery is mounted at the bottom of the grip and can be removed with one touch. The Nicd battery can be carried in a pocket by using the optional curled cord. (FTA-2, FP-T3PG, battery extension cord)

RECEIVER FP-R104H

- High performance AM 4 channel receiver in which miniature size and light weight have been achieved by using the PC board space to the maximum.
- Short (50cm) antenna designed for miniature models is easy to mount.
- Narrow band design using a narrow band ceramic filter resists adjacent channel interference.
- Noise resistance achieved by using a pulse noise rejection circuit.
- New CMOS miniature IC used in the data coder increases reliability substantially.
- New type subminiature, highly reliable pins used at the crystal socket also increase reliability. The crystal can be changed from the outside.
- Thick film gold-plated connector pins eliminate poor contact and improve reliability against shock and vibration.

SERVO FP-S131SH/S132H

- The S131SH is a high torque, high speed watertight type servo using the highest quality coreless motor.
Output torque 44.5oz-in (3.2kg-cm)
Operating speed 0.16 sec/60°

- The S132H is a small high quality, high speed servo.
Output torque 25.02oz-in (1.8kg-cm)
Operating speed 0.13 sec/60°
- New indirect drive potentiometer improves vibration and shock resistance and increases neutral precision tremendously.
- Futaba low-power custom IC provides high starting torque, narrow dead band, and excellent trackability.
- Fiberglass-reinforced PBT (polybutylene terephthalate) injection molded servo case is mechanically strong and invulnerable against glow fuel.

- Strong polyacetal resin ultra-precision servo gear features smooth operation, positive neutral, and very little backlash.
- Fiberglass-reinforced epoxy resin PC board with thru-the-hole plating improves servo amp vibration and shock resistance.
- Thick film gold plated connector pins eliminate poor contact and improve reliability against shock and vibration. The housing has a reverse insertion prevention mechanism.
- Four special adjustable splined horns are available.

● CONTENTS AND RATINGS

Rating and specifications are subject to change without prior notice.

Model	FP-3PG
Transmitter	FP-T3PG x 1
Receiver	FP-R104H x 1
Servo	FP-S131SH x 2 or FP-S132H x 2
Switch	R4-SWKB (SWH-7)
Nicd battery/battery holder	R4-BHGS
Accessories	Charger, frequency flag, spare horn, small parts

TRANSMITTER FP-T3PG

Operating system	: Pistol grip type 3 channels
Frequency module	FP-TG-AM
Transmitting frequency	: 27MHz band, bands 1 - 6 72/75MHz band
Modulation	AM (amplitude modulation)
Power requirement	9.6V internal Nicd battery
Current drain	: 200mA

RECEIVER FP-R104H

Miniature 4 channel AM receiver	
Receiving frequency	: 27MHz band, bands 1 - 6, 72/75MHz band
Intermediate frequency	455kHz
Power requirement	4.8V or 6V
Current drain	: 10mA
Dimensions	1.26 x 2.05 x 0.77 in (32 x 52 x 19.4mm)
Weight	: 1.06oz (30g)
Receiving range	200m on the ground when used with the FP-T3P

SERVO FP-S131SH / FP-S132H

Control system	+ pulse width control, 1520μS.N	
Operating angle	One side 45° for FP-S131SH or greater 40° for FP-S132H (including trim)	
Power requirement	4.8V or 6V shared with receiver	
Current drain	: 8mA at 6V (at idle)	
Output torque	: 44.5oz-in (3.2kg-cm)	25.02oz-in (1.8kg-cm)
Operating speed	: 0.16 sec/60°	0.13 sec/60°
Dimensions	: 1.59 x 0.79 x 1.40 in (40.5 x 2 x 35.5mm)	1.46 x 0.71 x 1.20 in (37 x 18 x 30.5mm)
Weight	: 1.72oz (49g)	1.13oz (32g)

CHARGER FBC-2A

Input voltage	117VAC, 50/60Hz
Output	: TX side 9.6V, 45mA RX side 6.0V, 45mA

RECEIVER SERVO NICD BATTERY NR-5PB OPTIONAL

Voltage capacity	6.0, 5/450mA.H
Dimensions	: 1.26 x 3.35 x 0.69 in (32 x 85 x 17.5mm)
Weight	: 3.17oz (90g)

● TRANSMITTER FP-T3PG

The name of each part of the transmitter is shown in Fig. 1 and Fig. 2. Learn them before operating your set.

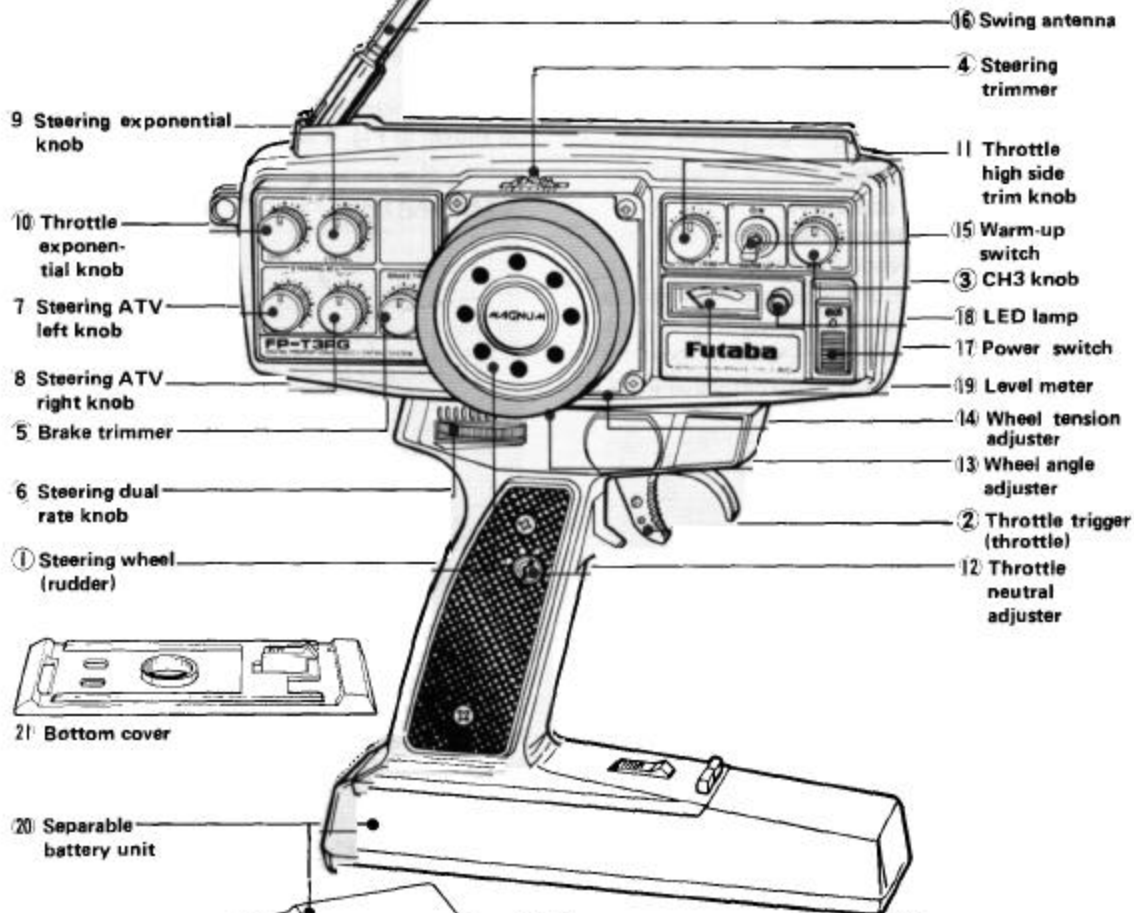

Fig. 1

The servo reversing switches are accessed by removing the RF module.
Top (NORM) Normal
Bottom (REV) Reverse

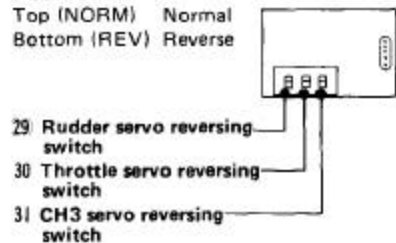

Fig. 2

DESCRIPTION OF OPERATION

The servo reversing switches are assumed to be in the normal position in the descriptions in this section. When the servo switches are in the reverse position, operation is the opposite of that described here.

① Steering wheel (rudder)

Steering (rudder) operation.

② Throttle trigger (throttle lever)

Engine control/motor control operation.

The throttle neutral position can be set to one of three positions by turning the ⑩ throttle neutral adjuster with a coin as shown in Fig. 3. Set it to match the application.

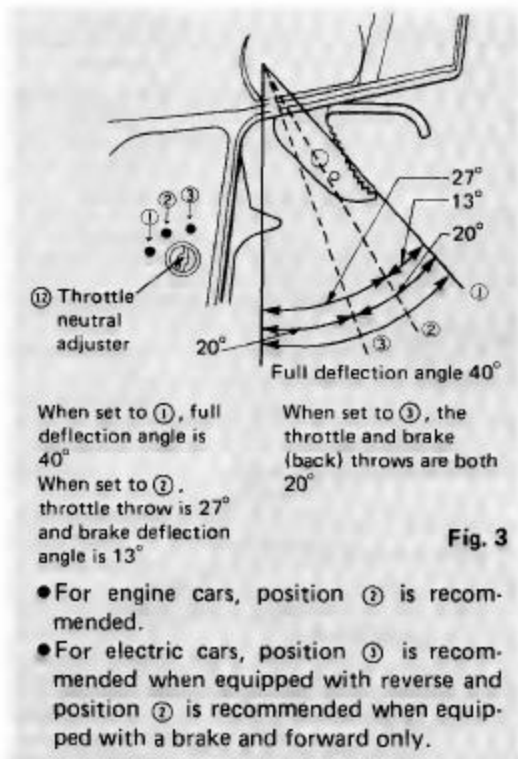

③ Channel 3 knob

Ratchet knob. This knob can be used for engine mixture control, etc.

④ Rudder trimmer

Steering (rudder) fine adjustment.

⑤ Brake trim

- ATL (Adjustable Throttle Limiter) type brake adjuster.

- This adjuster operates only when the ② throttle trigger is at the slow side as shown in Fig. 4.

- The adjustment range of this adjuster can be changed with the ⑤ brake limit trimmer on the back of the transmitter.

The slow side of the throttle servo is operated as shown in Fig. 4 with the brake adjuster.

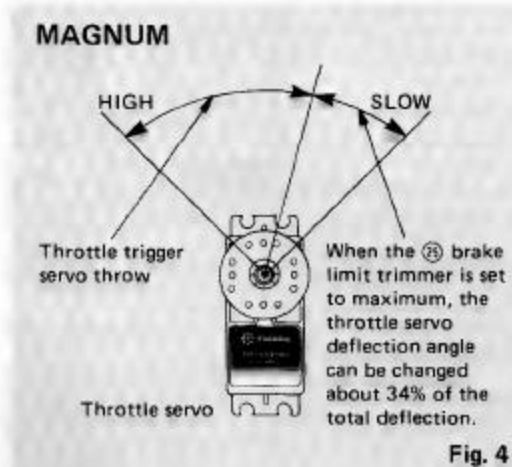

⑥ Steering dual rate knob

The steering servo deflection angle can be made smaller as shown in Fig. 5.

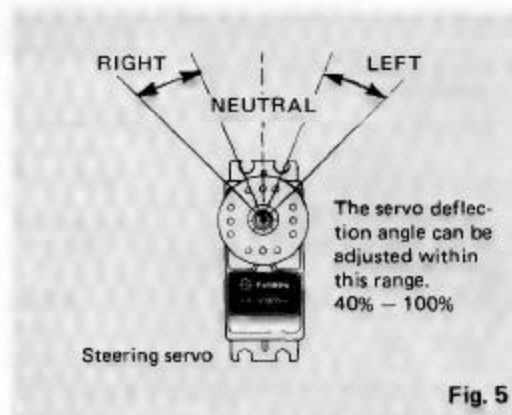

⑦ Steering ATV left knob

⑧ Steering ATV right knob

ATV is the abbreviation for adjustable travel limit volume. It is a device that allows independent adjustment of the servo left and right throw without affecting the neutral position. Because of the engine torque, precision of the model, and other reasons, the

radius of left and right turns is always different even if the left and right throws of the servo are perfectly matched. The ATV displays its advantage when left turns are good, but right turns are too sharp. In this case, left and right turns of the same radius can be performed and operation can be made easier by reducing the right servo throw slightly.

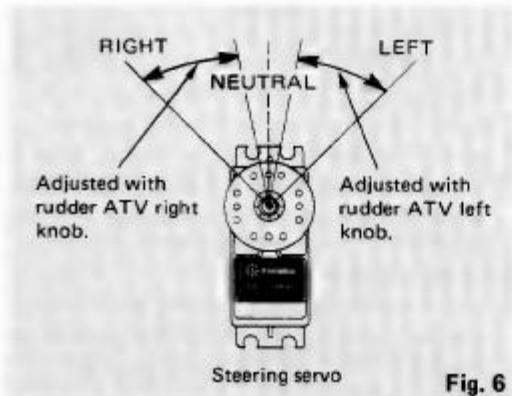

Fig. 6

9 Steering exponential knob

Steering exponential (called steering EXP hereafter) is a system in which the movement of the steering servo follows the movement of the steering wheel on an exponential curve as shown in Fig. 7. When steering EXP is appropriate, even if the steering wheel is turned slightly near the steering neutral point, a straight line can be easily maintained since the steering servo deflection angle is small. If the steering wheel is turned fully, the steering servo moves to its full deflection angle. The effect is shown.

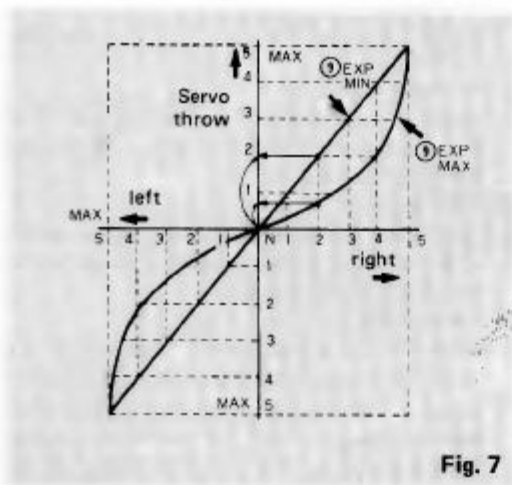

Fig. 7

10 Throttle exponential knob

Throttle exponential (called throttle EXP hereafter) is a system which causes the throttle servo to follow the movement of the throttle trigger on an exponential curve as shown in Fig. 8. When the throttle EXP is appropriate (especially for a round intake port with a drum type throttle), operation of the throttle trigger and the slow and high relationship of the engine are closely matched.

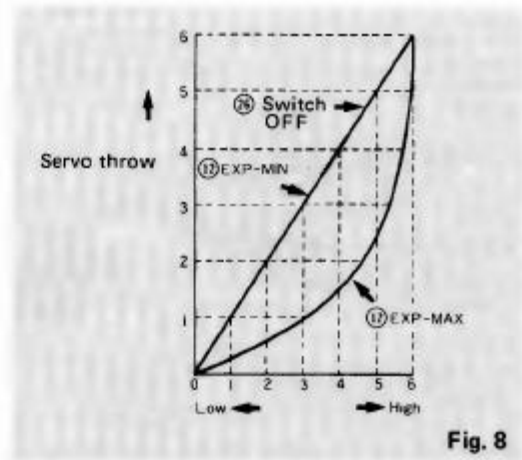

Fig. 8

11 Throttle HIGH side trim knob

This knob can be set only when the throttle trigger is at the HIGH side. Since the LOW side is unchanged even if the throttle HIGH side is adjusted with this knob, it is convenient when connecting the linkage.

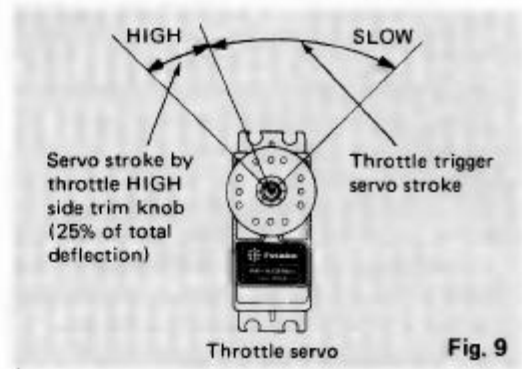

Fig. 9

12 Throttle neutral adjuster

This adjuster sets the neutral point of the throttle trigger as described in the 10 throttle trigger item. Using a screwdriver or coin, set it to the position at which it stops with a click.

13 Wheel angle adjuster

The operating angle of the ① steering wheel can be adjusted to the desired angle with this adjuster as shown in Fig. 10. The servo deflection angle remains unchanged no matter how the steering wheel angle is set.

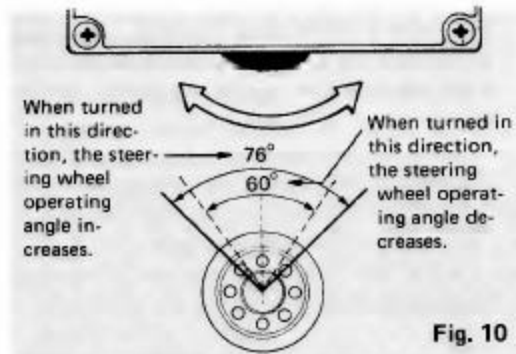

14 Wheel tension adjuster

This Phillips head screw adjust the steering force of the steering wheel.

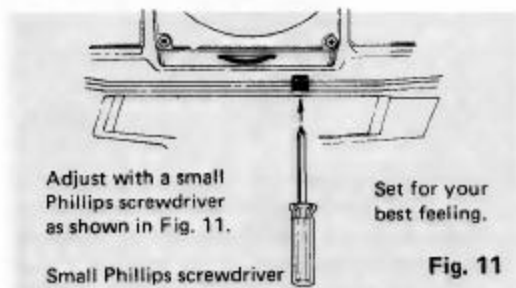

15 Warm-up switch

Throttle warm-up is a device which automatically cycles the throttle servo between SLOW – MEDIUM SLOW – (HIGH). When the warm-up switch (called SW hereafter) is turned on, the throttle servo is cycled between the operating positions set with warm-up throttle point trimmer ④ (called trimmer ④ hereafter) and warm-up trimmer ⑤ (called trimmer ⑤ hereafter) at the period set at the warm-up time trimmer (called time trimmer hereafter). At this time, the throttle trigger is disabled and the throttle servo is not operated with the throttle trigger. The ⑮ LED lamp flashes to indicate that warm-up is being performed. When the ⑮ warm-up switch is OFF, the throttle trigger is returned to normal operation.

Trimmer ④ and trimmer ⑤ set the total stroke of the throttle servo. When trimmers ④ and ⑤ are set to points ④ and ⑤, set-

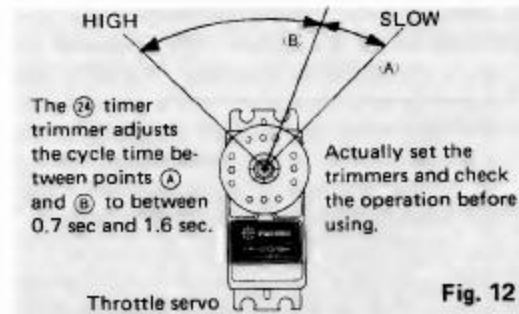

ting the ⑮ warm-up switch to on automatically cycles the throttle servo between ④ and ⑤. If points ④ and ⑤ overlap, even if the warm-up switch is set to on, the throttle servo will stop at that position and will not cycle.

16 Swing antenna

70cm loading antenna. It locks in the vertical position and at 30° from the vertical as shown in Fig. 13. Use it at the most convenient position.

Use the antenna as a pair with the RF module according to the frequency band.

When changing the RF module frequency band, also change the antenna to one for the same band.

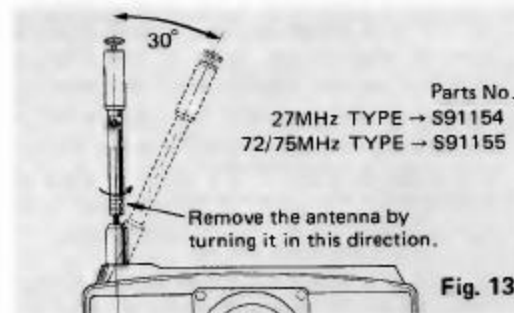

17 Power switch

When set in the direction of the ▲ mark (upper direction), the switch is turned on and the LED lamp lights.

18 LED lamp

This lamp lights when the ⑰ power switch is set to ON. It flashes when the ⑮ warm-up switch is set to ON.

19 Level meter

When the ⑰ power switch is set to ON, the level meter pointer should deflect to silver zone. If the pointer stops at the boundary between the silver and red zones, the internal Nicd battery is low and the range of the radiowaves will be short.

20 Separable battery unit (NT-8P)

21 Bottom cover

•The MAGNUM SERIES Nicd battery section and separable battery unit can be mounted and dismantled as shown in Fig. 14. The Nicd battery section and separable battery unit carried in your pocket by remove them from the transmitter, installing the 21 bottom cover, and connecting the optional curled (FTA-2) cord to the battery unit.

•To charge the battery, connect the FBC-2L 2L 21 DIN connector to the 20 separable battery unit, connect the 3P connector to the optional NR-5PB receiver servo Nicd

battery, and plug the FBC-2A charger into a 117VAC outlet. The Tx and Rx LEDs on the charger light to indicate that the battery is charging.

- Charge the battery for 12 to 15 hours.
- If the battery has not been used for some time, charge and discharge it 2 to 3 times, then charge it for the specified time before use.
- The transmitter and receiver Nicd batteries can be charged simultaneously or independently.
- The Nicd battery can be used about 10 times for 10 minutes each time.

Before installing the 20 separable battery unit to the transmitter, remove the 21 bottom cover and unit contacts shorting prevention plastic plate.

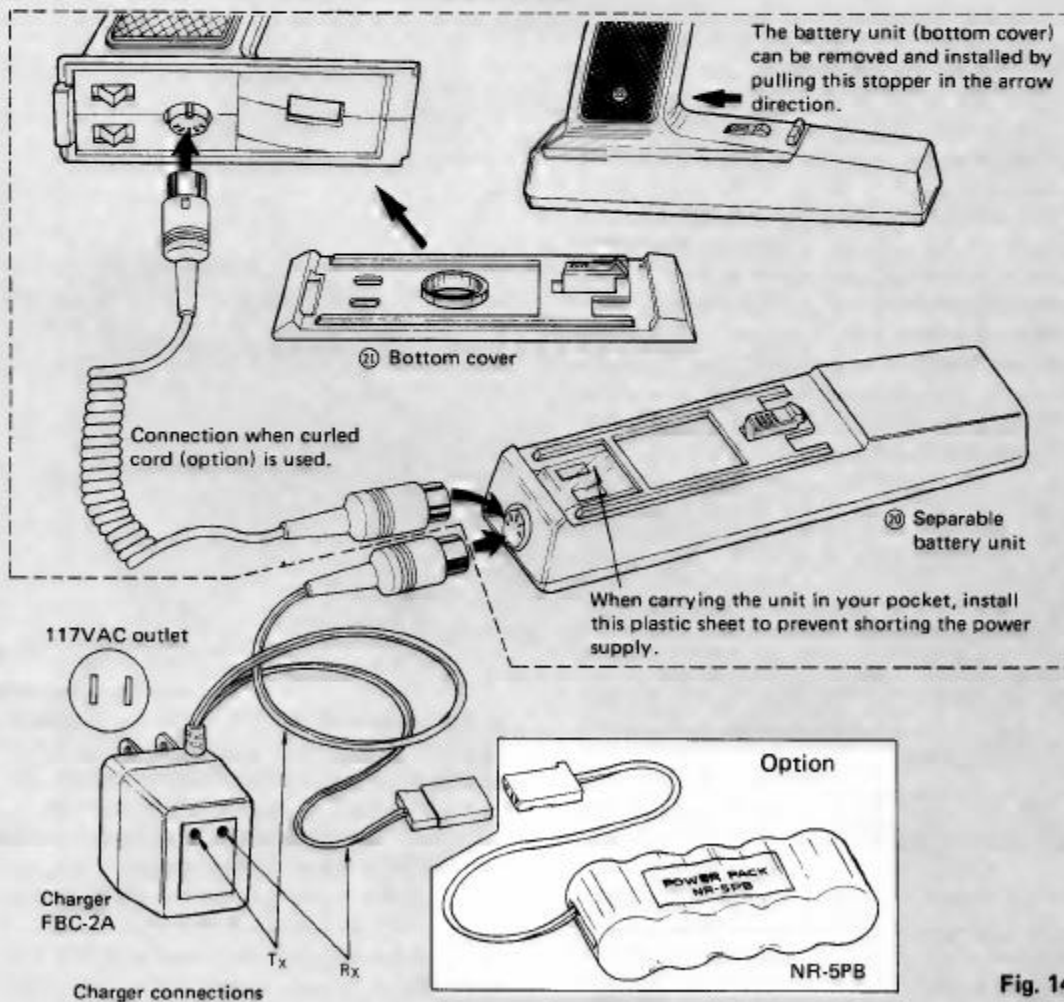

Fig. 14

- 22 Warm-up throttle point trimmer ④
- 23 Warm-up throttle point trimmer ⑥
- 24 Warm-up time trimmer

See ⑬
Warm-up switch.

25 Brake limit trimmer

- This trimmer sets the maximum stroke at the slow side of the throttle servo which can be varied with the ⑤ brake adjuster. (See ⑤ Brake trimmer.)
- Set this trimmer so that the ⑤ brake adjuster full stroke is easiest to use.

26 Switch grip set screw

- The swiveling grip system is a mechanism that swivels the grip part of the pistol grip and the control panel section mounting the steering wheel over a range of 300.
- To swivel the grip, loosen the ② switch grip set screw with a screwdriver. After positioning the grip, retighten the screw.
- The grip can also be positioned for left handed use.

27 Transmitter RF module FP-TG-AM

When changing from 27MHz to 72/75MHz and vice versa, replace this module. Change the antenna at the same time. When changing the frequency, use the AM crystal (transmit and receive 1 pair) sold by Futaba. The transmitter crystal is marked TX and the receiver crystal is marked RX. (Except 72/75MHz)

28 Hook

This is the hook for the hand strap sold separately.

29 Steering servo reversing switch

This switch reverses the direction of operation of the steering servo. The upper position is normal and the lower position is reverse.

30 Throttle servo reversing switch

This switch reverse the direction of operation of the throttle servo. The upper position is normal and the lower position is reverse.

31 CH3 servo reversing switch

This switch reverses the direction of operation of the CH3 servo. The upper position is normal and the lower position is reverse.

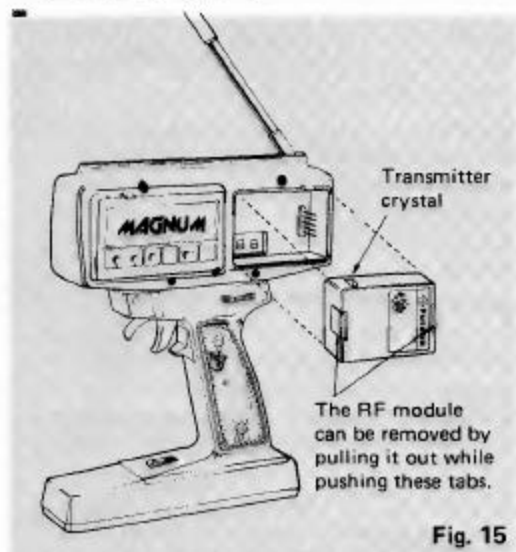

Fig. 15

● RECEIVER FP-R104H, SERVO FP-S131SH/S132H

- Connect the servos and switches firmly as shown in Fig. 16. Then extend the transmitter and receiver antennas fully.
- Set the transmitter power switch to ON, then set the receiver power switch to ON. The servos will stop near the neutral position. Operate the transmitter and check if the servos operate accordingly.
- Connect the pushrod to each servo horn, then check if the direction of travel of each servo matches the transmitter operation.
- Operate each servo to its full stroke and check if the pushrod binds or is loose. Unreasonable force applied to the servo horns is not only bad for the horns, but will also cause the battery to run down quickly. Always make the stroke of each control mechanism somewhat larger than the full stroke (including the trim component) of the servo horn. Adjust the servo horns so they move smoothly even when the trim lever/knob and wheel/trigger are operated simultaneously.

● RECEIVER, SERVOS, AND SWITCH CONNECTIONS

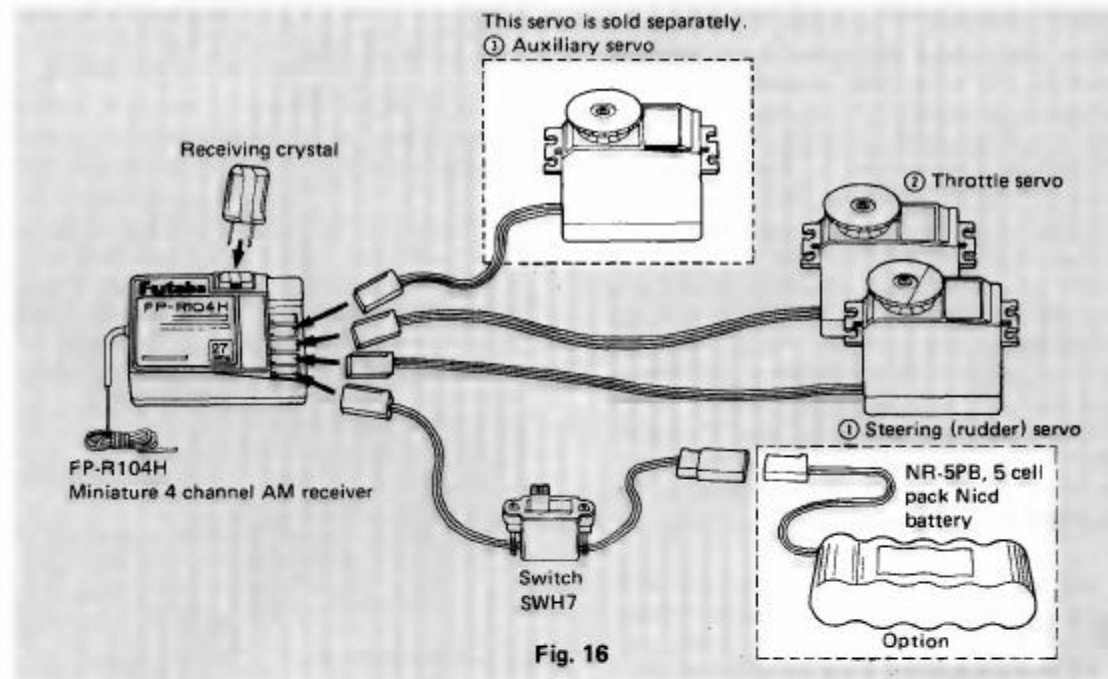

Fig. 16

- Be alert for noise. If engine vibration, etc. cause metal parts to touch each other, noise will be generated and the receiver and servos may operate incorrectly. We recommend the use of noiseless parts.
- When installing the switch harness, cut a rectangular hole somewhat larger than the full stroke of the switch and install the switch so it moves smoothly from ON to OFF. When the switch is operated from the outside with wire, install the switch mount as described above. Install the switch where it will not come into direct contact with engine oil, dust, etc.
- Although the receiving antenna wire is long, do not cut or bundle it.
- Mount the servos firmly. Refer to Fig. 17.
- A spare horn is supplied. Use is according to the application.
- Wrap the receiver in sponge rubber. Place the receiver in a plastic bag and wrap a rubber band around the open end of the bag to waterproof and dustproof the receiver. Do the same with the receiver/servo battery.

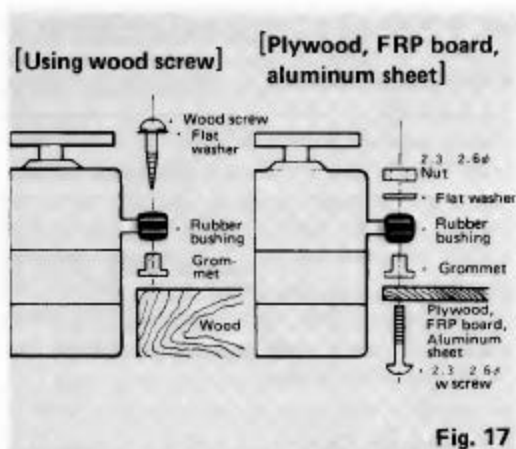

Fig. 17

- Use the rubber bands wrapped around the receiver to hold the servo and switch leads.
- After mounting is complete, recheck each part, then check the transmitting range by making the transmitter antenna as short as possible; extending the receiver antenna to its full length, and operating the transmitter from a distance of 20m to 30m from the receiver. The movement of each servo should follow the operation of the transmitter.
- After mounting and checking are complete, take your model to the shop where you bought the digital proportional set, or to an experienced R/C operator and ask them to inspect your set-up and to teach you how to use your R/C set properly.
- To get full enjoyment from your R/C model, follow the instructions of an experienced operator and be sure to observe all safety standards.

● MAGNUM GAS ENGINE USAGE EXAMPLE

The throttle (cap) and mechanical brake are perfectly matched.

- Example of use for general throttle & brake
- Match the engine control arm stroke and throttle (engine control) servo stroke. At this time, connect the linkage to the servo hole at which the servo stroke is somewhat larger than the full stroke of the throttle arm.
- Check if the ② throttle trigger is set to position ② (throttle stroke 27°, brake stroke 31°)

of Fig. 18, and set the ⑤ brake trimmer to the maximum slow side.

- Next, set the throttle slow position and the ③ brake trimmer optimum stroke with the ② brake limit trimmer.
- Install the throttle arm and rod making free neutral for brake stroke from slow.
- Next, set with the ⑩ throttle HIGH side trim knob as the engine throttle is opened fully when the ⑦ throttle trigger is squeeze fully.
- Set the ⑤ brake trimmer for the weakest braking force and set the ② brake limit trimmer so that the braking effect is best when the ② throttle trigger is pushed (braking position).
- The engine throttle stroke and servo stroke can be perfectly matched with this set up.

The ⑤ brake trimmer can be matched to the condition of the course and machine which change during a race while running. Use it to the fullest.

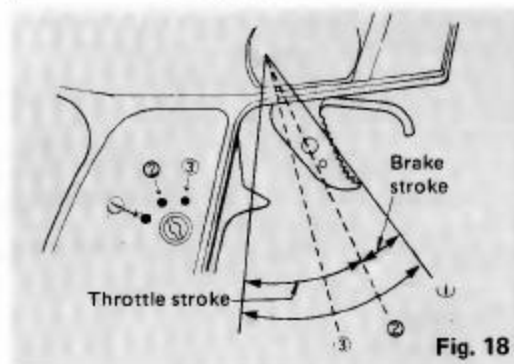
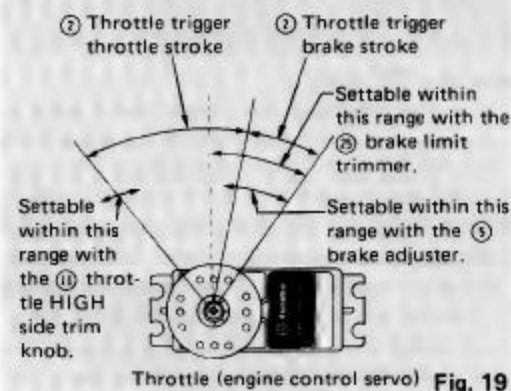

Fig. 18

The operation of the throttle (engine control) servo can be set as shown in Fig. 19 according to the function by operating the ① throttle trigger.



Throttle (engine control servo) Fig. 19

● MAGNUM ELECTRIC MOTOR USAGE EXAMPLE

Perfectly matched to the resistor type speed controller.

- Example of forward only resistor type speed controller
- Roughly match the speed controller and the throttle (engine control) servo strokes.
At this time, connect the linkage to the servo horn hole at which the servo stroke is somewhat larger than the controller stroke.
- When the brush is installed directly to the servo horn, adjust the distance between the controller and throttle servo so that the servo stroke is somewhat larger than the controller stroke. Also adjust the brush so that it is at the off point.
- Check that the ② throttle trigger is set to position ② (throttle stroke 27°, brake stroke 13°) in Fig. 20, then set the ③ brake adjuster to the maximum slow side.
- Next turn the ④ brake limit trimmer and set the brush to the controller maximum brake point.
- Turn the ⑤ throttle HIGH side ATV trimmer on the back of the transmitter and set the controller maximum high point brush.

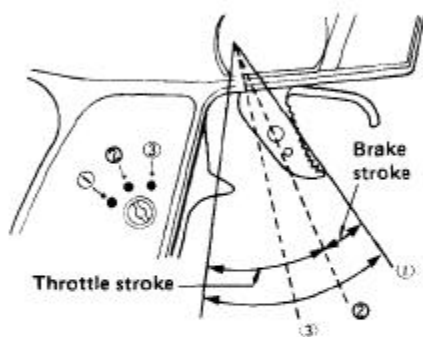
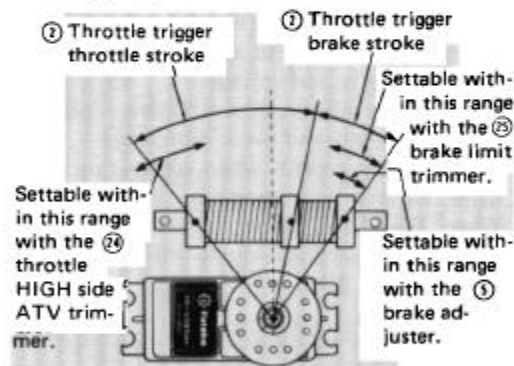

Fig. 20

Operation of the throttle (engine control) throttle can be set as shown in Fig. 21 according to the function by ① throttle trigger operation.



Throttle (engine control servo) Fig. 21

- See Fig. 22 for the motor, battery, and speed controller wiring.

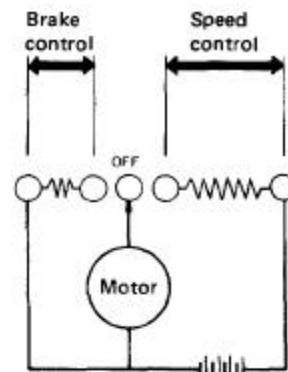

Motor and controller circuit diagram Fig. 22

The servo stroke can be perfectly matched to the resistor type speed controller with the set-up above.

The strength of the brake can be freely changed independently with the ③ brake trimmer, since the brake adjuster is inside the throttle trigger, it is extremely easy to use even during a race.

This throttle mechanism is not only for motor-drive cars, but also for engine-driven cars.

The cars performance can be utilized 100% by applying the steering function together with the adjustable rate and ATV functions to engine-driven cars also.

- When using a controller with reverse, set the ① throttle trigger to the center with the ② throttle neutral adjuster.
- When the drive battery is also used as the receiver servo power supply with a motor-driven car, pay careful attention to the power supply polarity and voltage. With Futaba proportional R/C power supplies, red represents ⊕ and black represents ⊖. Be especially careful when connecting to the drive battery by remodeling the R4-SWKB. When the drive battery is 7.2V, drop the voltage by inserting a diode into the circuit as shown in Fig. 23.

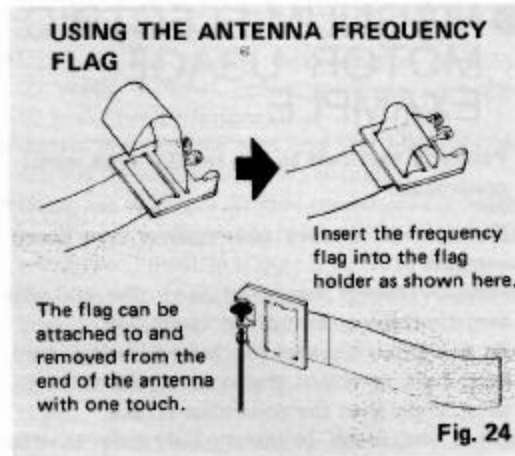
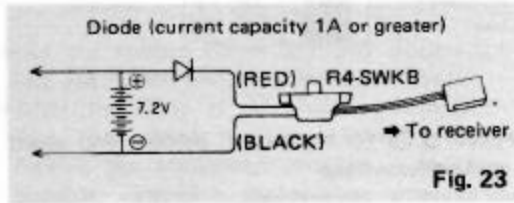

● SPLINED HORNS

This horn permits shifting of the servo neutral position at the servo horn. Setting and shifting the neutral position

a) Angle divisions

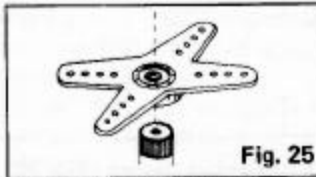

- 1) The splined horn has 25 segments. The amount of change per segment is; $360 \div 25 = 14.4^\circ$
- 2) The minimum adjustable angle is determined by the number of arms or number of the holes. For four arms, the minimum adjustable angle is:

$$360^\circ \div \frac{(25 \times 4)}{\text{Number of divisions}} = 3.6^\circ$$

b) Effect

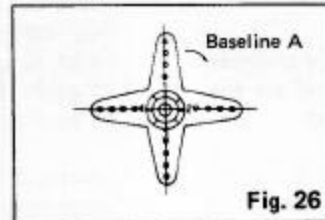

To shift the holes center line to the right (clockwise) relative to baseline A, shift arm 2 to the position of arm 1 and set it to the position closest to baseline A.

[Example] For a four arm horn, the angular shift per segment is 14.4° . The shift to the right is $90^\circ - (14.4 \times 6) = 3.6^\circ$

To shift by the same angle in the opposite direction, use the opposite arm number.

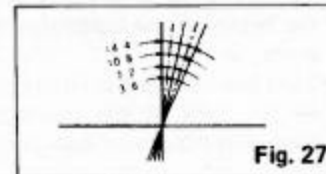

For a six arm horn, turn the arm counterclockwise and set arm 2 to the position of arm 1. The adjustable angle is $60^\circ - (14.4 \times 4) = 2.4^\circ$.

Arm 3 shift 4.8° to the right, arm 6 shifts 2.4° to the left, and arm 4 shifts 7.2° to the right and left.

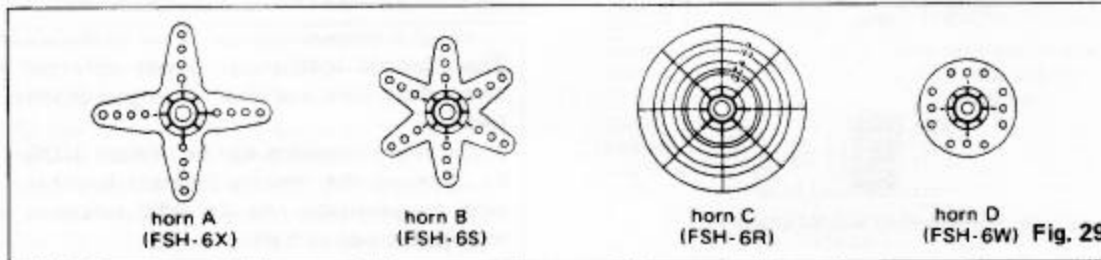

FP-S131SH EXPLODED VIEW

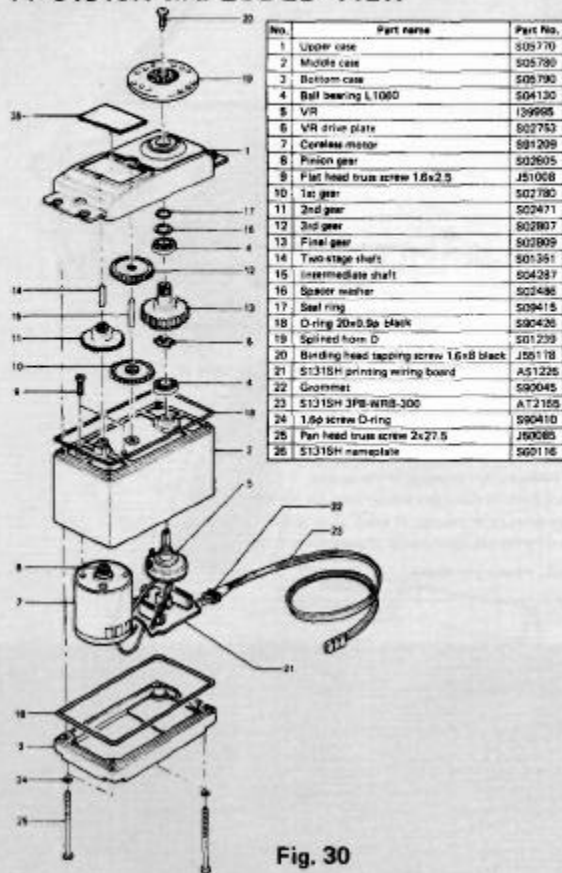

Fig. 30

FP-S132H EXPLODED VIEW

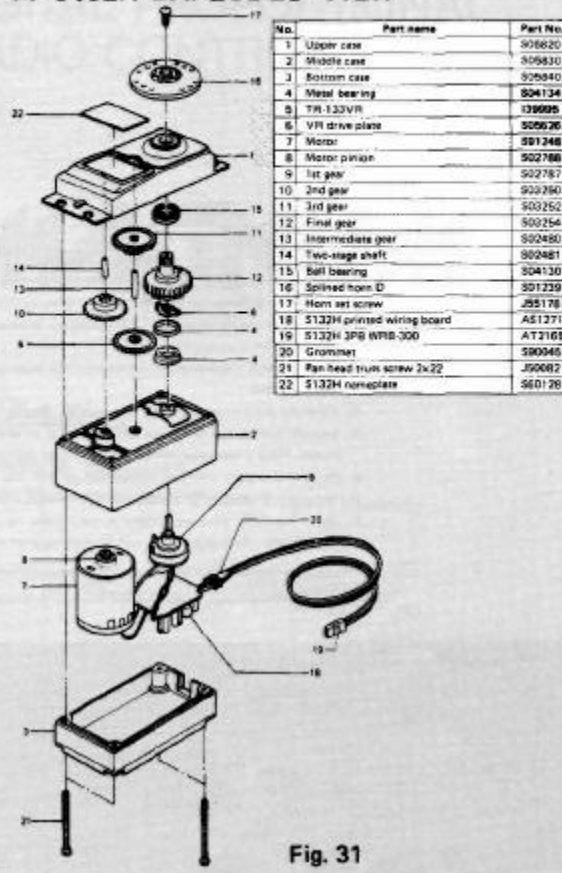

Fig. 31

Futaba Digital Proportional Frequencies (FOR U.S.A.)

- The frequency of Futaba digital proportional sets can be changed among bands (1)~(6) on the 27MHz band only.
- However, a 27MHz band set cannot be changed to 72MHz band, and vice versa.
- Therefore, always attach the correct frequency flag to the end of the transmitter antenna. Each frequency band has its own designated color, as stated above. The frequency flag is intended for identification purposes.
- Also change the frequency flag when frequency is changed.
- Futaba paired crystals are precisely matched. Always use a Futaba crystal set (transmitter, receiver) when changing the frequency.
- It is illegal to change crystals of transmitter on the 72-75MHz bands in the U.S.A.

Frequency Channel No. Flag Color	
26-27MHz - Aircraft/Car/Boat	
26.995	— Brown
27.045	— Red
27.095	— Orange
27.145	— Yellow
27.195	— Green
27.255	— Blue
72/75MHz - Aircraft only *Shared	
72.030	12 Brown-Red (Top Flag/Ribbon- Bottom Flag/Ribbon)
72.080	— White/Brown
72.160*	— White/Blue
72.240	— White/Red
72.320*	— White/Purple
72.400	— White/Orange
72.550	38 Orange-Grey
72.590	40 Yellow-Black
72.630	42 Yellow-Red
72.670	44 Yellow-Yellow
72.710	46 Yellow-Blue
72.750	48 Yellow-Grey
72.790	50 Green-Black
72.830	52 Green-Red
72.870	54 Green-Yellow
72.910	56 Green-Blue
72.960*	— White/Yellow
75.640	— White/Green
75MHz - Car & Boat only	
75.430	62 Blue-Red (Top Flag/Ribbon- Bottom Flag/Ribbon)
75.470	64 Blue-Yellow
75.510	66 Blue-Blue
75.550	68 Blue-Grey
75.590	70 Purple-Black
75.670	74 Purple-Yellow
75.710	76 Purple-Blue
75.750	78 Purple-Grey
75.790	80 Grey-Black
75.830	82 Grey-Red
75.870	84 Grey-Yellow
53MHz - Aircraft/Car/Boat - FCC Amateur License Required	
53.100	— Black/Brown
53.200	— Black/Red
53.300	— Black/Orange
53.400	— Black/Yellow
53.500	— Black/Green
53.600	— Black/Blue
53.700	— Black/Purple
53.800	— Black/Grey
	Not generally in use

FACTORY REPAIR SERVICE

To insure prompt service, please follow the instructions given below:

1. Charge the batteries for at least 18 hours prior to shipment.
2. Return the system only. Not your complete installation. Remove the servos from their mounts and remove the foam padding from the receiver.
3. Plugs or other modifications which interfere with factory test procedures will be returned to factory standard at your expense.
4. Carefully pack all components individually, using sufficient packing material to prevent damage during shipment.
5. Include a brief but thorough explanation of all problems and service required and tape it to the back of the transmitter. Place a label describing the function of the servo on each servo.
6. Be sure to include your full address and tel. No., zip code inside the box as well as on the outside.
7. Include a packing list of all items being returned, and double check to make sure that all items are packed.
8. Upon receipt of your equipment at the Futaba factory, an estimate of the cost of repair (over \$25.00 only) will be sent to you. Your equipment will then be repaired and returned to you upon receipt of payment or C.O.D. (cash).

This factory repair service applies only to the continental U.S.A., Hawaii, and Alaska.

WORLD SALES & SERVICE FACILITIES:

Australia: FUTABA SALES AUSTRALIA PTY. LTD.,
MELBOURNE TEL: 211-4788

Argentina: MODELISMO AERONAUTICO DEGA SRL,
BUENOS AIRES TEL: 393-2299

Canada: UDISCO LTD., MONTREAL TEL: 481-8109

Chile: HOBBY LANDIA, SANTIAGO TEL: 743957

Denmark: FUTABA IMPORT DENMARK, COPENHAGEN
TEL: 0291 01 01

England: RIPMAX LIMITED, LONDON TEL: 01-8048272

Finland: NORES OY, HELSINKI TEL: 90-620311

Greece: C. & G. MACRIYIANNIS CO., PIRAEUS
TEL: 021-4176191

Hong Kong: RADAR CO. LTD. TEL: 3-680607

Italy: R.C.S. RADIO CONTROL SYSTEM, CREMONA
TEL: 0372-20588

Lebanon: KHAIRALLAH MODEL CRAFT, BEIRUT
TEL: 326-681

New Zealand: AMALGAMATED WIRELESS (AUSTRALIA)
N.Z. LTD., WELLINGTON TEL: 58-979

Norway: MODEL HOBBY A/S, OSLO TEL: 442015

Singapore: SINGAPORE HOBBY SUPPLIES TEL: 430337

South Africa: REDIPAK (PTY.) LTD., JOHANNESBURG
TEL: 21-1511

Spain: HOBBY & TOY INTERNATIONAL, LAS PALMAS
TEL: 21-6930

Sweden: RADIO CONTROL CENTER, JONKOPING
TEL: 036-145360

U.S.A.: FUTABA CORPORATION OF AMERICA,
CALIFORNIA TEL: 213-637-9610

W. Germany: ROBBE MODELLSPORT GMBH, GREBENHAIN
TEL: 06644-7041



FUTABA CORPORATION OF AMERICA

555 West Victoria Street, Compton, Calif. 90220, U.S.A.

Phone: 213-537-9610 Telex: 23-0691227 Facsimile: 213-637-8529

FUTABA CORPORATION

Tokyo Office: Daido Bldg., 3-1-16, Sotokanda, Chiyoda-ku, Tokyo, Japan

Phone: (03) 255-5881 Telex: J26532