



SASS MATCH

(APR 29, 2017)

#85

2 BAYS

60=R

60=P

22+=S

STAGE 1

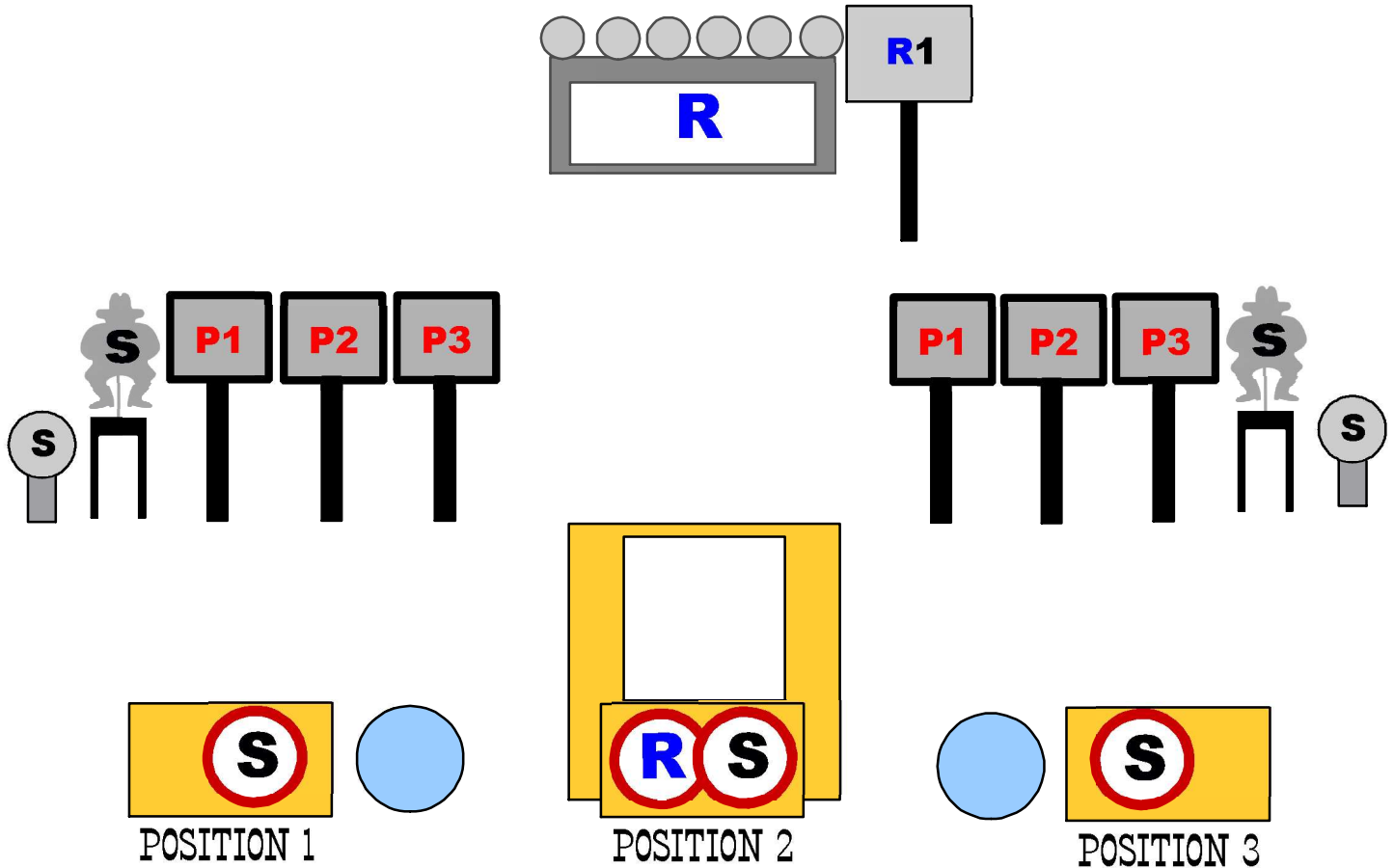

 10 RIFLE 10 PISTOL 2+ SHOTGUN 

START: STANDING @ POSITION 1 or 3. Hands at sides.

PISTOLS LOADED WITH 5 ROUNDS EACH AND HOLSTERED.

SHOTGUN OPEN AND EMPTY STAGED ON ANY TABLE.

RIFLE LOADED WITH 10, STAGED @ POSITION 2..

WHEN READY SAY:

" Just Shoot "

AT THE BEEP: (Stage may be shot L to R or R to L)

With pistols starting on either end double tap nevada sweep the pistol targets for 10 rounds.

Move to position 2 and with rifle engage the plate rack until down placing any remaining rounds on R1. Make rifle safe and move to final position.

With shotgun engage 2 knock-downs.

STAGE 2

**NOTE:
EACH PLATE IS A
NO-MISS,
1 SECOND BONUS.**

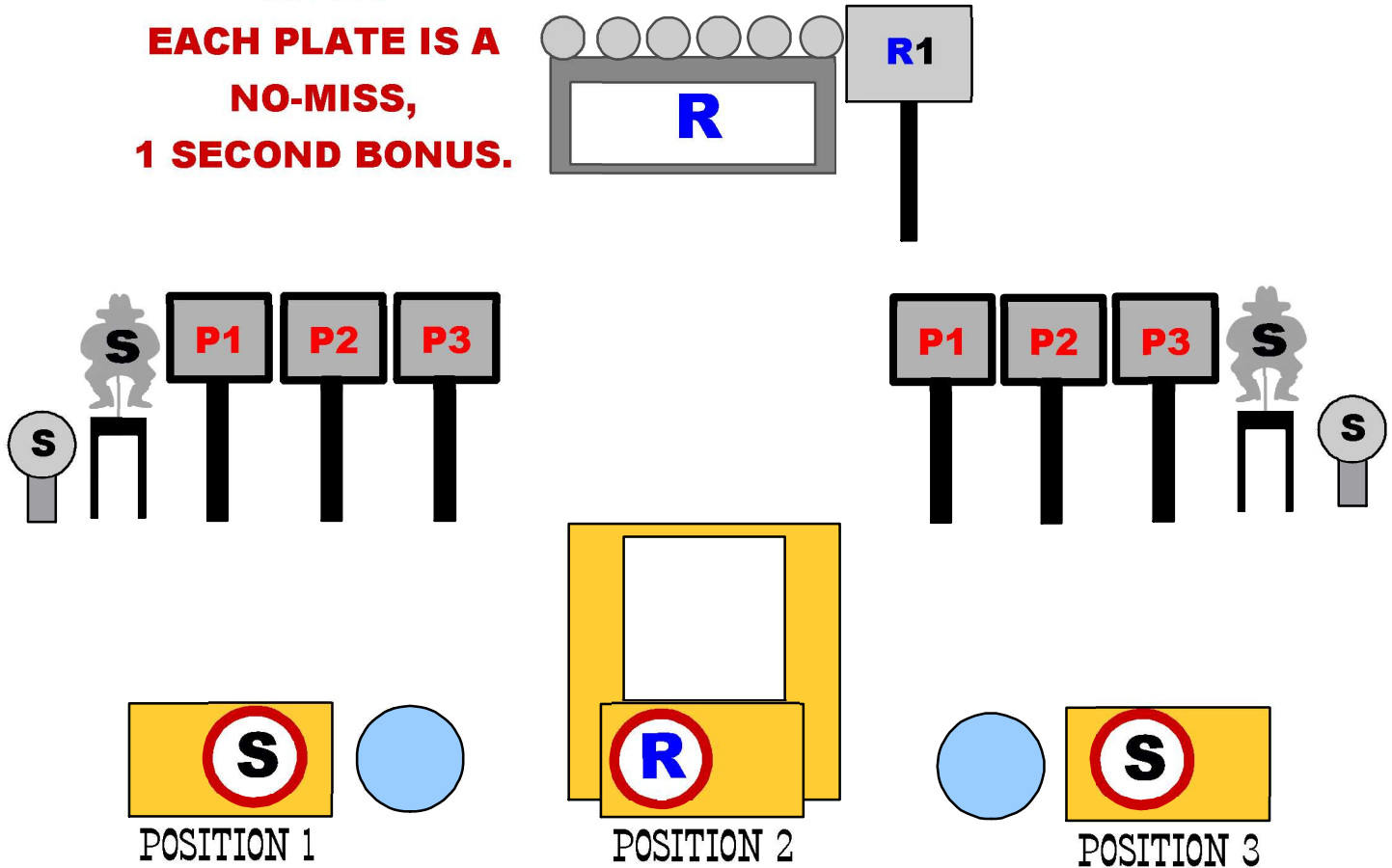

 10 RIFLE 10 PISTOL 2+ SHOTGUN 

START: STANDING @ POSITION 1 or 3. Shotgun open and empty held in hands.
PISTOLS LOADED WITH 5 ROUNDS EACH AND HOLSTERED.
RIFLE LOADED WITH 10, STAGED @ POSITION 2..

**WHEN READY SAY:
" I said, JUST SHOOT! "**

AT THE BEEP:

With shotgun engage 2 knock-downs. Make Shotgun safe and move to position 2.
With rifle starting on the plate rack alternate double tap on the rack and solid target for 10 rounds. (Each plate is a no-miss, 1 second bonus. Solid target is a miss).
Make rifle safe and move to position 1 or 3.
With pistols triple tap the middle target and place one on each end target, repeat.

STAGE 3

NOTE:
EACH PLATE IS A
NO-MISS,
1 SECOND BONUS.

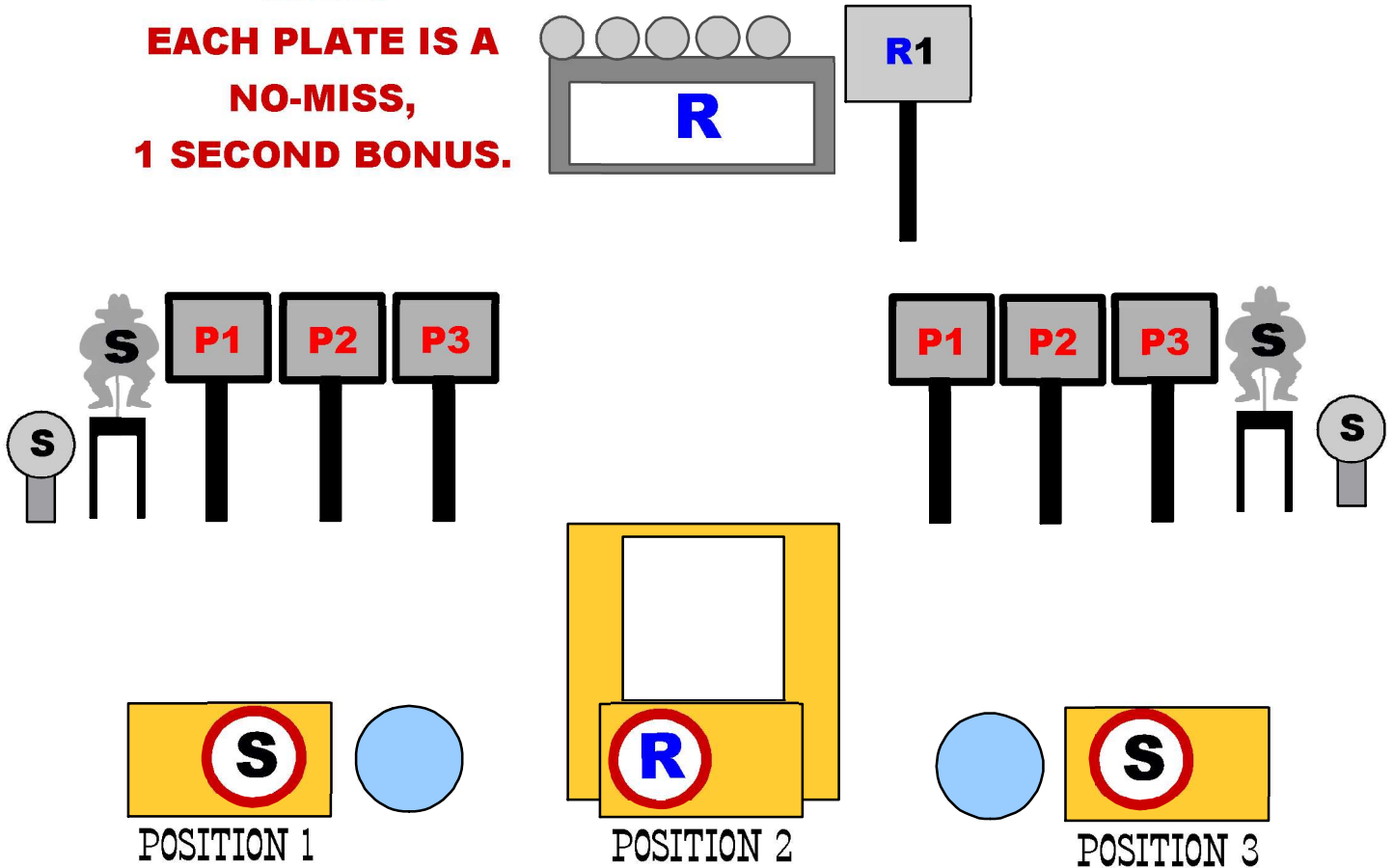

	10 RIFLE	10 PISTOL	4+ SHOTGUN	
---	----------	-----------	------------	---

START: STANDING @ POSITION 2. RIFLE LOADED WITH 10, Held in hands.

Shotgun open and empty staged @ position 1 or 3.

PISTOLS LOADED WITH 5 ROUNDS EACH AND HOLSTERED.

WHEN READY SAY:

" Ya missed me! "

AT THE BEEP: (guns may be shot in any order but rifle must be first.)

With rifle starting on R1 alternate between the solid target and the plate rack for 10 rounds..

(Each plate is a no-miss, 1 second bonus. Solid target is a miss.)

With shotgun engage 2 knock-downs from each position.

With pistols at either position 1 or 3 engage the pistol targets at least twice each.

STAGE 4

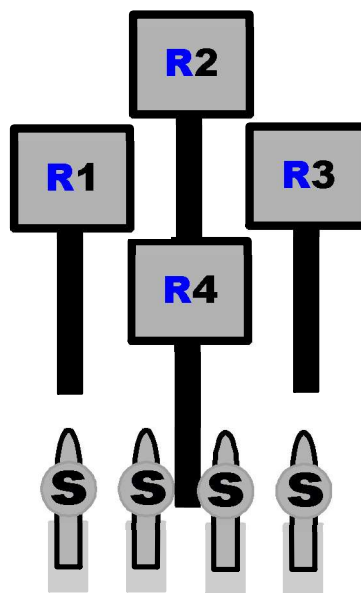
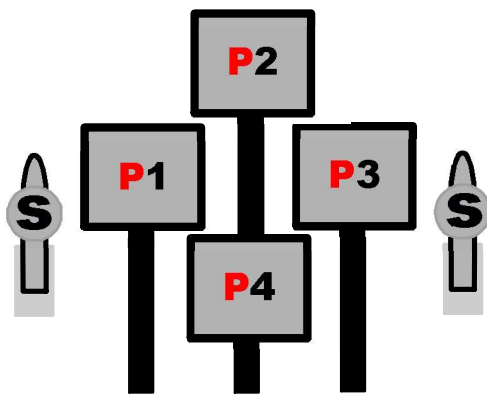
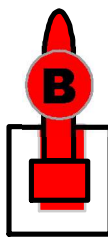

POSITION 1



POSITION 2

	10 RIFLE	10 PISTOL	6+ SHOTGUN	
---	----------	-----------	------------	---

START: STANDING @ POSITION 2. RIFLE LOADED w/10 HELD IN HANDS.

SHOTGUN OPEN AND EMPTY STAGED @ POSITION 2.

PISTOLS LOADED WITH 5 ROUNDS EACH AND HOLSTERED.

SAY THE LINE: " I'm still waitin'! "

AT THE BEEP: With Rifle: Engage rifle targets in a continuous clockwise circle starting on any target for 9 rounds. With 10th round engage the bonus target for a **no-miss 3 second bonus**.

With Shotgun: Engage the 4 knock-downs then move to Position 1 and engage the remaining 2 knock-downs. Make shotgun safe.

With Pistols: Engage pistol targets same instructions as pistols, including the bonus.

STAGE 5

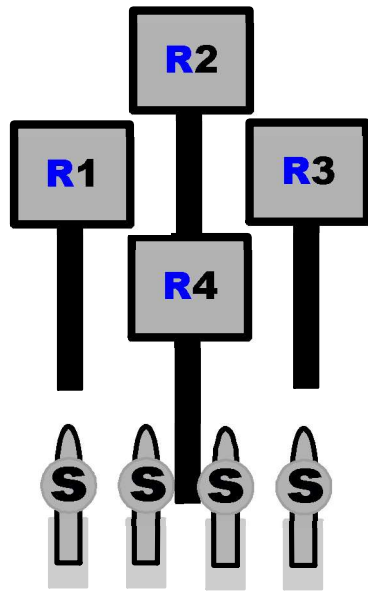
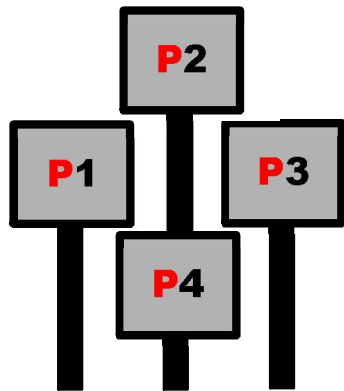

 10 RIFLE 10 PISTOL 4+ SHOTGUN
 

START: STANDING @ ANY POSITION. HANDS ON BELT.
 SHOTGUN OPEN AND EMPTY STAGED @ POSITION 1 or 2.
 RIFLE, LOADED WITH 9. STAGED @ POSITION 2.
 PISTOLS LOADED WITH 5 ROUNDS EACH AND HOLSTERED.

SAY THE LINE: " I'm dont wait'in. "

AT THE BEEP: (Guns may be shot in any order

With pistols @ position 1:

Engage the pistols targets in a clockwise IRS (Progressive) sweep starting on any target.

With rifle @ Position 2: Engage the rifle targets same instructions as pistols.

With shotgun @ Position 2: Engage the 4 knock-downs.

STAGE 6

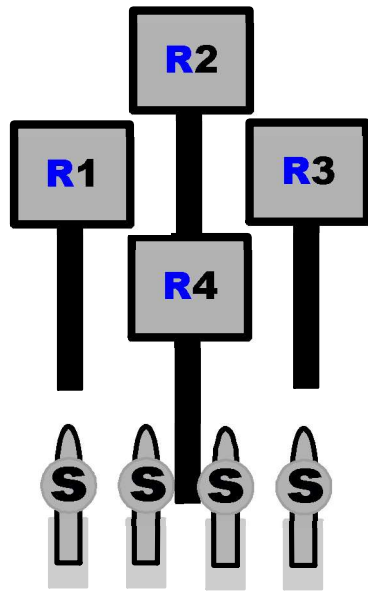
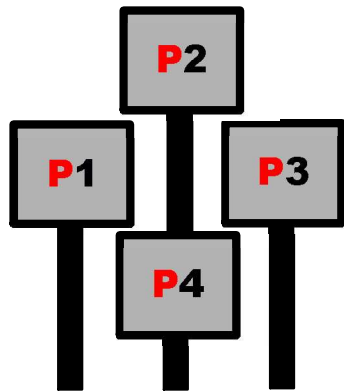

10 RIFLE 10 PISTOL 4+ SHOTGUN

START: STANDING @ ANY POSITION. HANDS ANYWHERE.
 SHOTGUN OPEN AND EMPTY STAGED @ POSITION 1 or 2.
 RIFLE, LOADED WITH 9. STAGED @ POSITION 2.
 PISTOLS LOADED WITH 5 ROUNDS EACH AND HOLSTERED.

SAY THE LINE: " Lets get this over with. "

AT THE BEEP: (Guns may be shot in any order

With pistols @ position 1:

Alternate between P1 and P3 for 5 rounds and alternate between P2 and P4 for 5 rounds.

(May start on either pair and either target)

With rifle @ Position 2: Engage the rifle targets same instructions as pistols.

With shotgun @ Position 2: Engage the 4 knock-downs.

