

Offene Chirurgie

// *Open Surgery*

Hauptkatalog
General Catalogue

Sold & Distributed by:
Capital Medical Resources LLC



CAPITAL MEDICAL RESOURCES LLC | 57 N SANDUSKY ST, SUITE 1 | DELAWARE, OH. 43015
614.589.1334 | INFO@CAPITALMEDICALRESOURCES.COM | WWW.CAPITALMEDICALRESOURCES.COM

best
for surgery



Offene Chirurgie

Open Surgery

Hauptkatalog
General Catalogue

best *medical* GmbH

Heudorfer Straße 32
D-78576 Liptingen

Telefon: +49 7465 91230

Telefax: +49 7465 91232

Mail: info@bestmedical.biz

www.bestmedical.biz

Sold & Distributed by:
Capital Medical Resources LLC



CAPITAL MEDICAL RESOURCES LLC | 57 N SANDUSKY ST, SUITE 1 | DELAWARE, OH. 43015
614.389.1334 | INFO@CAPITALMEDICALRESOURCES.COM | WWW.CAPITALMEDICALRESOURCES.COM

Der vorliegende Katalog bleibt unser Eigentum, der Katalog darf nur zum Vertrieb unserer Produkte eingesetzt werden.

Der Katalog bzw. alle darin enthaltene Informationen dürfen ohne unsere Erlaubnis nicht an Dritte weitergegeben, nachgedruckt oder kopiert werden.

Abweichungen von den im Katalog dargestellten und beschriebenen Produkten behalten wir uns vor, sei es aus Gründen von Fehlern oder Produktmodifikationen.

Für alle Instrumente in unserem Katalog bleiben Modelländerungen vorbehalten.

This catalogue remains our property, the catalogue only can be used to distribute and sell our products.

This catalogue may not be made accessible to third parties and may not be duplicated or copied.

Patterns/Illustrations of the products included in this catalogue are subjects to possible alterations, either on reasons of possible mistakes or product modifications.

For all products included in this catalogue: Patterns are subject to change.

Über uns

Chirurgische/Endoskopische Instrumente/Produkte sind das tägliche Handwerkszeug der Chirurgen weltweit. Deren oberstes Ziel ist die Gesundheit des Menschen.

Wir wollen – als verantwortungsvoller Partner - mit unseren Produkten, mit unserer langjährigen Erfahrung und unserem Wissen um diese Produkte, diese Zielsetzung unterstützen; mit ausgereiften, intelligenten und hochwertigen Produkten aus speziell definiertem Material, hergestellt von ausgebildeten Spezialisten.

Über 30 Jahre Erfahrung auf dem Gebiet der chirurgischen / endoskopischen Instrumente sind die Basis unserer Aktivitäten.

Gegründet im Jahre 1983 als „best instruments“ wurde die Firma im Jahr 2010 unter dem neuen Firmennamen best medical als GmbH neu organisiert.

Die Grundlage unserer Produktpalette liegt in der gesamten Fertigungsbreite im Raum Tuttlingen, dem Weltzentrum der Medizintechnik schlechthin.

In enger Zusammenarbeit mit unseren Partnern weltweit ist es unser Bestreben, mit Leidenschaft, Willen zur Perfektion und Liebe zu technischen Details, Produkte anzubieten, mit hoher anwendungsbezogener Funktionalität.

Dabei ist der von uns ausgewählte Firmenname nicht zufällig gewählt, dieser Name ist für uns Verpflichtung, nach bestmöglichen, individuellen, auf unsere Partner zugeschnittene Lösungen zu suchen.

In unserer Tätigkeit lassen wir uns von folgenden Richtlinien leiten:

Partnerschaft und kundenorientiertes Handeln:

Wir verstehen uns als Partner der Chirurgie.

Kommunikation und Austausch:

Wir pflegen eine intensive und enge Kommunikation mit unseren Kunden.

Sicherheit durch Qualität:

Es ist uns tägliches Bestreben, mit unseren Produkten Ihre Zufriedenheit zu erlangen.

Innovation und Dynamik:

Mit innovativen Produkten wollen wir dem chirurgischen Fortschritt dienen.

Erfahrung und Kontinuität:

Wir wollen Bewährtes bewahren, Positives aus Erfahrung umsetzen in neue Ziele, und mit unseren Partnern langfristig zusammenarbeiten.

Kompetenz, Leistung und Service:

Unsere Kompetenz und unser Wissen wollen wir umsetzen in flexiblen Service und kundenorientierte Leistung.

About us

Surgical/endoscopic instruments/products are the daily tools of surgeons around the world. Their highest priority is the health of people.

As a responsible partner, we want to support that goal with our products, our many years of experience, our knowledge about these products; with well-engineered, intelligent and high-quality products manufactured out of specially defined materials by trained specialists.

Our activities are based on over 30 years' experience in the field of surgical/endoscopic instruments.

Founded in the year 1983 as best instruments, the company has been newly reorganized 2010 as best medical GmbH.

The extensive manufacturing range of the Tuttlingen area – which is quite simply the world centre of medical technology – forms the foundation of our product spectrum. In close cooperation with our partners around the world, we put our passion, commitment to perfection and love of technical details into our work, in order to provide products with a high degree of application-oriented functionality.

Our name is not chosen by chance, it rather reflects the obligation we have made to find the best possible, individual, customized solutions for our partners.

In our activities, we are guided by the following principles:

Partnership and customer-oriented approach:

We see ourselves as partners for surgery.

Communication and dialogue:

We maintain intensive and close communication with our customers.

Safety through quality:

Your satisfaction with our products is our daily goal.

Innovation and dynamics:

With our innovative products we want to serve technical progress in surgery.

Experience and continuity:

We want to keep what has proven to be good while using our experience to pursue new goals and establish long-term cooperation with our partners.

Competence, performance and service:

We want to utilize our expertise and knowledge to provide flexible service and customer-oriented performance.



Unser Programm

- Offene Chirurgie
- Endoskopie
- Orthopädie, Traumatologie
- Ausgewählte Produkte für die Chirurgie

Our range of products

- *Open Surgery*
- *Endoscopy*
- *Orthopaedic, Traumatology*
- *Exclusive products for Surgery*



Inhalt Index

	Abschnitt <i>Section</i>	Seite <i>Site</i>
Diagnostik <i>Diagnostic</i>	A	A02 - A14
Diverse Instrumente <i>Various Instruments</i>	B	B02 - B41
Scheren <i>Scissors</i>	C	C02 - C49
Wundhaken <i>Retractors</i>	D	D02 - D31
Wundspreizer <i>Self Retraining Retractors</i>	E	F02 - F29
Pinzetten <i>Forceps</i>	F	F02 - F29
Klemmen, Zangen <i>Forceps</i>	G	G02 - G49
Naht, Gipsinstrumente <i>Suture, Plaster Instruments</i>	H	H02 - H44
Orthopädie <i>Orthopaedics</i>	K	K02 - K78
Implantate inkl. Zubehör <i>Implants and Instruments</i>	L	siehe Sonderkatalog <i>see special catalogue</i>
Neurochirurgie <i>Neuro-Spine Surgery</i>	M	siehe Sonderkatalog <i>see special catalogue</i>
Ophthalmologie <i>Ophthalmology</i>	N	siehe Sonderkatalog <i>see special catalogue</i>
HNO <i>ENT</i>	P, Q	siehe Sonderkatalog <i>see special catalogue</i>
Herz-, Thorax- Gefäßchirurgie <i>Cardiovascular- and Thoracic Surgery</i>	R	R02 - R42
Magen, Darm, Niere, Galle, Blase <i>Stomach, Intestinal, Kidney, Gall, Blader</i>	S	S02 - S30
Gynäkologie, Geburtshilfe <i>Gynecology, Obstetrics</i>	T	T02 - T45
HF-Chirurgie <i>HF-Surgery</i>	U	U02 - U29
Aufbewahrung, Sterilisation <i>Storage, Sterilisation</i>	W	W02 - W35

Diagnostik

// Diagnostic

Inhalt

Index

Abschnitt **A**
// Section

Perkussionshämmer <i>Percussion hammers</i>	A02
Stethoskope, Div. Messinstrumente <i>Stethoscopes, Measuring Instruments</i>	A03 - A05
Stirnspiegel, Stirnlampen <i>Head Mirrors, Head lights</i>	A06 - A08
Operations-Laryngoskope <i>Operation Laryngoscopes</i>	A09
Laryngoskope <i>Laryngoscopes</i>	A10 - A13
Nystagmusbrillen <i>Nystagmus-Spectacles</i>	A14

Perkussionshämmer
Percussion hammers



BUCK
18 cm // 7"
A100-18



TAYLOR
20 cm // 8"
A102-20

Für Kinder
for children

A102-16



BERLINER
20 cm // 8"
A104-20



mit Nadel
with pin

A105-20



ohne Nadel
without pin

A106-20



BABINSKY
24 cm // 9 1/2"

mit Nadel
with pin

A107-24

ohne Nadel
without pin

A108-24



TROEMNER
24 cm // 9 1/2"

A109-24

Sensibilitätsinstrumente
Sensibility Instruments



ALY
A110-00



WARTENBERG
19 cm // 7 1/2"
A112-00

Stethoskope, Div. Messinstrumente Stethoscopes, Measuring Instruments

Stethoskope Stethoscopes



PINARD
15 cm // 6"

Aluminium
aluminium

A114-15



PINARD
18 cm // 7"

Holz
wood

A115-18

Div. Messinstrumente Measuring Instruments

Dynamometer Dynamometer



COLLIN

für Kinder
for children

A150-01

für Erwachsene
for adults

A150-02



MÖLTGEN

Winkelmesser
Goniometer

A195-00



Für Orthopädie
for Orthopaedic

	grad. mm/inch grad. mm/inch
10 cm // 4"	A200-10
15 cm // 6"	A200-15
20 cm // 8"	A200-20
30 cm // 12"	A200-30
50 cm // 19 3/4"	A200-50



grad. mm/inch
grad. mm/inch

A205-00



röntgenfähig / 50 cm
x-ray / 50 cm

A201-50

Div. Messinstrumente
Measuring Instruments



Stahl of Steel	Wachstuch of oil cloth
1,5 m	1,5 m
A210-00	A212-01



JAMESON
A217-00



COTTLE
A218-00

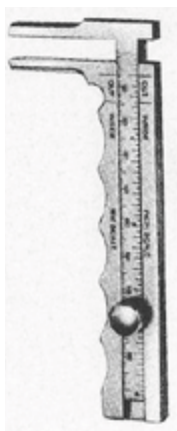

TOWNLEY
10 cm // 4"
A220-00

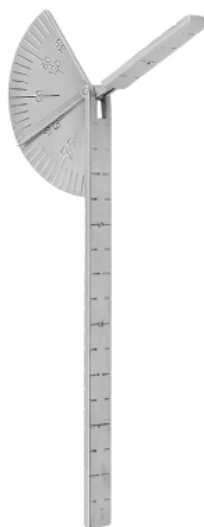

CAROLL
14 cm // 5 1/2"
A222-00



MARCHAC / THORPE
A224-00

Div. Messinstrumente
Measuring Instruments



CASPAR
A226-00



Knochenmeßzirkel
Bone Calipers

19 cm // 7 1/2"
A243-00



CASTROVIEJO
8 cm // 3 1/4"

	grad. mm/inch grad. mm/inch
0-15 mm	N700-15
0-20 mm	N700-20
0-40 mm	N700-40

Stirnspiegel, Stirnlampen
Head Mirrors, Head lights



Stirnspiegel Clar F
Headlight Clar F
55 mm, 2 m Kabel
55 mm, 2 m cable

A250-00



Stirnspiegel Clar
Headlight Clar
100 mm

A251-00



Steckernetzteil
Wall plug transformer

A250-51



Kabel-Zwischenschalter
Cord switch

A250-55



Stirnlampe Clar S
Headlight Clar S
55 mm, 2 m Kabel
55 mm, 2 m cable

A252-00

Ersatzspiegel
Spare mirror

A252-11



Stirnlampe Clar mit Fiberoptik
Headlight Clar with Fibre Optic

A255-00

Stirnlampen Head lights



JANSEN

Stirnlampe
Headlight

A258-00



Xenon Stirnlampe mit Batteriebox
Xenon Headlight with battery box

A260-00

Ersatzlampe mit Reflektor
Spare lamp with reflector

A260-11



Faseroptik Miniatur-Stirnleuchte
Fibreoptic Miniature Headlight

Faserbündel 2,6 mm
Fiber bundle 2,6 mm

A265-01

Stirnlampen
Head lights



Miniatur-Stirnlampe Fiberoptik
Miniature Headlight Fibre Optic

A266-01

Miniatur-Stirnlampe Fiberoptik mit 90 Grad Kabel
Miniature Headlight Fibre Optic with 90 degrees cable

A266-02



ZIEGLER

90 mm

A270-01

100 mm

A270-02

Stirnspiegel allein
Mirror only
90 mm

A270-11

Operations-Laryngoskope Operation Laryngoscopes



Fig. 1	135 mm	A350-01
Fig. 2	152 mm	A350-02
Fig. 3	182 mm	A350-03
Fig. 4	172 mm	A350-04
Fig. 5	172 mm	A350-05
Fig. 6	182 mm	A350-06
Fig. 7	222 mm	A350-07
	Extra Groß <i>especially large</i>	A350-08



Fiberglass-Lichtträger
Fiberglass light carriers

Fig. 1-2	A350-21
Fig. 3-6	A350-22
Fig. 7	A350-23



Rauchabsaugrohr
Suction tube

A350-38



Injektionskanüle
Injection cannula

A350-35



Bruststütze
Chest support

für Erwachsene
for adults

A352-01

für Kinder
for children

A352-02



Stützstange
Support rod

für Erwachsene
for adults

A352-11

für Kinder
for children

A352-12

Griffe für Laryngoskop-Spatel
Handles for Laryngoscope blades

Mit Trafoanschluss
With transformer connection



30 mm
A358-01



30 mm
A358-02



18 mm
A358-03



30 mm
A358-10

Akku, aufladbar
Accu, rechargeable
A358-41



Transformator 220V
Transformator 220V
A358-45

Transformator 110V
Transformator 110V
A358-45

Laryngoskope Laryngoscopes



MCINTOSH

Satz mit 3 Spatel, in Etui
Set with 3 blades, in case

A360-53

Satz mit 4 Spatel, in Etui
Set with 4 blades, in case

A360-54

Fig. 0	53x75 mm	A360-00
Fig. 1	68x90 mm	A360-01
Fig. 2	88x110 mm	A360-02
Fig. 3	108x130 mm	A360-03
Fig. 4	128x150 mm	A360-04
Fig. 5	148x170 mm	A360-05

Ersatzbirne für Spatel
Spare bulb for blades

Fig. 0-1 | **A360-95**

Fig. 2-5 | **A360-96**



MILLER

Satz mit 3 Spatel, in Etui
Set with 3 blades, in case

A362-53

Satz mit 4 Spatel, in Etui
Set with 4 blades, in case

A362-54

Fig. 0	53x75 mm	A362-00
Fig. 1	78x100 mm	A362-01
Fig. 2	133x155 mm	A362-02
Fig. 3	173x195 mm	A362-03
Fig. 4	183x205 mm	A362-04



FOREGGER

Satz mit 4 Spatel, in Etui
Set with 4 blades, in case

A364-54

Satz mit 5 Spatel, in Etui
Set with 5 blades, in case

A364-55

Fig. 0	A364-00
Fig. 1	A364-01
Fig. 2	A364-02
Fig. 3	A364-03
Fig. 4	A364-04

Kaltlichtlaryngoskope
Fiber Optic Laryngoscopes

Mit Trafoanschluss
With transformer connection



30 mm
A368-01



18 mm
A368-03



A368-10



MCINTOSH

Fig. 0	A370-00
Fig. 1	A370-01
Fig. 2	A370-02
Fig. 3	A370-03
Fig. 4	A370-04

Satz mit 3 Spatel, in Etui
Set with 3 blades, in case

A370-53

Satz mit 4 Spatel, in Etui
Set with 4 blades, in case

A370-54



Ersatzbirne
Spare bulb

A370-95

Kaltlichtlaryngoskope Fiber Optic Laryngoscopes



MILLER

Fig. 0	A372-00
Fig. 1	A372-01
Fig. 2	A372-02
Fig. 3	A372-03
Fig. 4	A372-04

Satz mit 3 Spatel, in Etui
Set with 3 blades, in case

A372-53

Satz mit 4 Spatel, in Etui
Set with 4 blades, in case

A372-54

Satz mit 5 Spatel, in Etui
Set with 5 blades, in case

A372-55



JACKSON

für Kinder
for children

A375-02

für Erwachsene
for adults

A375-03



HOLINGER

120 mm

A376-01

171 mm

A376-02

180 mm

A376-03

Nystagmusbrillen
Nystagmus-Spectacles



FRENZEL

Nystagmusbrille nach Prof. Frenzel mit festen Gläsern
Nystagmus-Spectacles by Prof. Frenzel with fixed lenses

A650-01



FRENZEL

Nystagmusbrille nach Prof. Frenzel mit klappbaren Gläsern
Nystagmus-Spectacles by Prof. Frenzel with hinged lenses

A650-03



FRENZEL

Nystagmusbrille nach Prof. Frenzel mit festen Gläsern
Nystagmus-Spectacles by Prof. Frenzel with fixed lenses

A650-05



Batteriegehäuse für Stromversorgung
Battery housing

A650-21



Ersatzlampe
Spare bulb

A650-91

Diverse Instrumente

// Various Instruments

Inhalt

Index

Abschnitt **B**
// Section

Skalpelle, Klagen, Messer <i>Scalpels, Blades, Knives</i>	B02 - B11
Amputationssägen <i>Amputation Saws</i>	B12
Sonden, Watteträger <i>Probes, Cotton Applicators</i>	B13 - B15
Venen-Instrumente <i>Vein Instruments</i>	B16 - B21
Fingerringsägen, Instrumente für Nagelpflege <i>Finger Ring Saws, Nail Instruments</i>	B22 - B23
Dermatologie <i>Dermatology</i>	B24
Führungsnadeln, Trokare <i>Guide Needles, Trocars</i>	B25 - B27
Saugrohre, Kanülen <i>Suction tubes, Needles</i>	B28 - B40
Spritzen <i>Syringes</i>	B41

Skalpellgriffe
Scalpel Handles

Skalpellgriffe für Klingen Nr. 10,11,12,13,15
Scalpel Handles for Blades No. 10,11,12,13,15



No. 3

B100-30



No. 3

B100-31



No. 5

B100-50



No. 5A

B100-51



No. 3

B100-32



No. 3

B100-32



No. 7

B100-70



No. 7K

B100-71



COLLIN
No. 8

B100-80



BARRON

B100-83

Skalpellgriffe für Klagen Nr. 18,19,20,21,22,23,24,25
Scalpel Handles for Blades No. 18,19,20,21,22,23,24,25



No. 3+4

B100-39



No. 4

B100-40



No. 4

B100-41



No. 4

B100-42



No. 4

B100-43



COLLIN
No. 9

B100-90

Skalpellklingen
Scalpel Blades

Skalpellklingen, steril, Packung 100 Stück
Scalpel Blades, sterile, packg. 100 pieces



Fig. 10

B105-10



Fig. 11

B105-11



Fig. 12

B105-12



Fig. 13

B105-13



Fig. 15

B105-15



Fig. 18

B105-18



Fig. 19

B105-19



Fig. 20

B105-20



Fig. 21

B105-21



Fig. 22

B105-22



Fig. 23

B105-23



Fig. 24

B105-24



Fig. 25

B105-25

Mini-Skalpelle Mini Scalpels

Mini-Skalpellklingen-System Mini-Blade-System



No. 3K	10 cm // 4"	B108-10
No. 3KL	13 cm // 5"	B108-13
No. 3KXL	15,5 cm // 6"	B108-15



13,5 cm // 6"	B109-13
15 cm // 6"	B109-15
18 cm // 7"	B109-18
20 cm // 8"	B109-20



21 cm // 8 1/4"	B109-21
25 cm // 10"	B109-25



Fig. 61
B110-61



Fig. 62
B110-62



Fig. 62S
B110-62S



Fig. 64
B110-64



Fig. 65
B110-65



Fig. 67
B110-67



Fig. 69
B110-69

Skalpelle
Scalpels



STANDARD



Fig. 1	B115-01
Fig. 2	B115-02
Fig. 3	B115-03
Fig. 4	B115-04
Fig. 5	B115-05



Fig. 1	B115-06
Fig. 2	B115-07
Fig. 3	B115-08
Fig. 4	B115-09
Fig. 5	B115-10



BERGMANN



Fig. 1

B118-01



Fig. 2

B118-02



SIMON

20 cm // 8"

B122-01

Klingenhalter Razor blade holder



Rasierklingen Pck/10 Klengen
Razor Blades Pck/10 Blades

B125-00



TROUTMAN
9 cm // 3 1/2"

B125-09



TROUTMAN
9 cm // 3 1/2"

B126-09



CASTROVIEJO
13 cm // 5"

B128-13

conkav / convex
concave / convex

B129-13

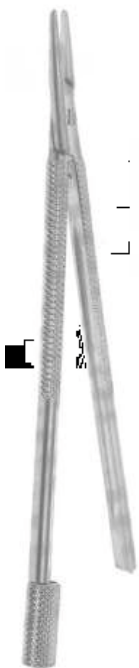

CASTROVIEJO
12 cm // 4 3/4"

B130-12



TROUTMAN
11 cm // 4 1/2"

B132-11



CASTROVIEJO
mit Schiebeperrre
with slide catch
12,5 cm // 5"

B134-12



18 cm // 7"

B135-18

Messer
Knives

Amputationsmesser
Amputation Knives



doppelschneidend
double cutting edge

Lappenmesser
Flap Knife



12 cm // 4 3/4"

B144-12

Phalangenmesser
Phalangeal knife



9,5 cm // 3 3/4"

B146-09

Blattlänge length of blade		LISTON	CATLIN
13 cm // 5"	B140-13	-	-
16 cm // 6 1/4"	B140-16	-	B142-16
17 cm // 6 3/4"	-	B141-17	-
19 cm // 7 1/2"	B140-19	-	B142-19
20 cm // 8"	-	B141-20	-
22 cm // 8 3/4"	B140-22	-	B142-22

Blattlänge 55 mm
length of blade 55 mm



LANGENBECK

B150-01



B150-02

Hirnmesser
Brain Knives



Blatlänge length of blade	
16 cm // 6 ¼"	B152-16
20 cm // 8"	B152-20
24 cm // 9 ½"	B152-24

Organmesser
Postmortem Knives



Blatlänge length of blade	
11 cm // 4 ½"	B153-11
14 cm // 5 ½"	B153-14
17 cm // 6 ¾"	B153-17



VIRCHOW
12 cm // 4 ¾"
B155-12



VIRCHOW
8,5 cm // 3 ½"
B157-08



VIRCHOW
8 cm // 3 ½"
B159-09

Dermatome
Dermatomes



SCHINK
0,1-3,0mm
10 cm

B180-00

Ersatz-Klinge allein
Spare blade only

B180-11



SILVER
0,1-4,0mm
4,3 cm

B181-00

Ersatz-Klinge allein
Spare blade only

B181-11



**WAT-
SON**
0,1-1,5mm
16 cm

B182-00

Ersatz-Klinge allein
Spare blade only

B182-11



HUMBY
0,1-1,5mm
16 cm

B184-00

Ersatz-Klinge allein
Spare blade only

B182-11



COBETT
0,1-1,5mm
16 cm

B186-00

Ersatz-Klinge allein
Spare blade only

B182-11



Hautspannplatte
Straighthing plate

B180-12

Diverse Messer Various Knives

Meniskotome Meniscotomy knives



SMILLIE
17 cm // 6 3/4"
B200-01



B200-02



B200-03



SALENIUS
22 cm // 8 3/4"
B202-01



SALENIUS
22 cm // 8 3/4"
B202-02



17,5 cm // 7"
B204-01



NEFF
21,5 cm // 8 1/2"



B205-01



B205-02



20 cm // 8"
B206-01



BIRCHER
20,5 cm // 8"
B208-20



TÖNNIS



13 cm // 5"
B215-13



18 cm // 7"
B215-18



OLIVECRONA
20,5 cm // 8"
B217-20

Amputationssägen
Amputation Saws



LANGENBECK
23 cm // 9"
B250-00



SATTERLEE
31 cm // 12 1/4"
B252-00

Ersatzsägeblatt
Spare saw blade
B252-51



CHARRIERE
27 cm // 10 1/2" | **B254-27**
30 cm // 12" | **B254-30**



Ersatzsägeblatt
Spare saw blade
12 mm | **B256-51**
15 mm | **B256-52**

CHARRIERE
kplt. mit 2 Blättern
cplt. with 2 blades
B256-00



Ersatzsägeblatt
Spare saw blade
3 mm | **B258-51**
5 mm | **B258-52**
7 mm | **B258-53**

BIER
kplt. mit 3 Blättern
cplt. with 3 blades
B258-00

Sonden Probes

Mit Ohr
With eyelet

Myrtenblattsonde
Myrtle-shaped

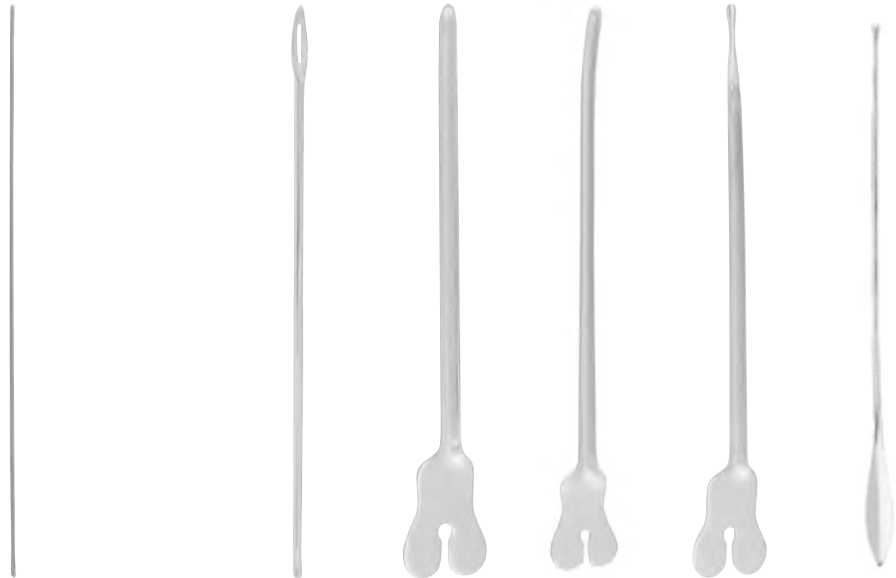

	1 mm	1,5 mm	2 mm			DOYEN		
11,5 cm // 4 1/2"	B300-11	B301-11	B302-11	B306-11	B310-11	-	-	-
13 cm // 5"	B300-13	B301-13	B302-13	B306-13	B310-13	-	B312-13	B316-13
14,5 cm // 5 3/4"	B300-14	B301-14	B302-14	B306-14	B310-14	B311-14	B312-14	B316-14
16 cm // 6 1/4"	B300-16	B301-16	B302-16	B306-16	B310-16	-	B312-16	B316-16
18 cm // 7"	B300-18	B301-18	B302-18	B306-18	B310-18	-	B312-18	-
20 cm // 8"	B300-20	B301-20	B302-20	B306-20	B310-20	-	-	B316-20
25 cm // 10"	B300-25	B301-25	B302-25	-	-	-	-	-



NELATON
16 cm // 6 1/4"
B313-16



BRODIE
18 cm // 7"
B314-18



STACKE
10,5 cm // 4 1/4"
B318-10



SEIFFERT
18 cm // 7"
B321-18

Sonden
Probes

Fistelsonden
Fistula probes



LOCKHART-MUMMARY



Fig. 1
B326-01



Fig. 2
B326-02



Fig. 3
B326-03



Fig. 4
B326-04



PRATT
21 cm // 8 1/4"



Fig. 1
B327-01



Fig. 2
B327-02



Fig. 3
B327-03



Pflasterspatel
Plaster spatulas

13 cm // 5" | B330-13
14,5 cm // 5 1/2" | B330-14

Watteträger Cotton Applicators



HARTMANN
22 cm // 8 1/2"
B340-22



PELTESON
23 cm // 9"
B342-23

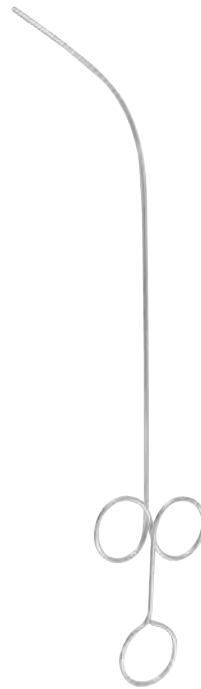

FEIN
28 cm // 11"
B343-28



BUCK
12 cm // 4 3/4"
B346-12



	1,2 mm	1,5 mm	1,7 mm
12,5 cm // 5"	B350-12	-	B352-12
16 cm // 6 1/4"	B350-16	-	B352-16
18 cm // 7"	-	B351-18	B352-18



FARELL

		rund round	dreikant triangular
14 cm // 5 1/2"	0,9 mm	B354-14	B355-14
16 cm // 6 1/4"	1,1 mm	B354-16	B355-16



JOBSON-HORNE
18 cm // 7"
B362-18



38 cm // 15"
B370-38



EDER
38 cm // 15"
B371-38

Krampfaderbesteck, Venenstripper
Varicose Vein Probe Set, Vein Strippers



NABATOFF
Komplett in Metalletui
Complete in Metal case
B400-00

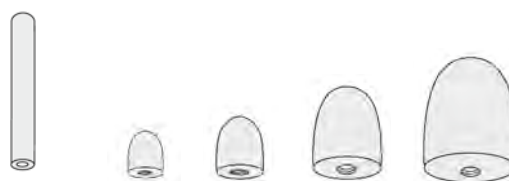
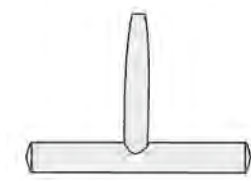

B400-10	Kunststoffspitze // Probe Tip
B400-11	Handgriff // Handle
B400-12	Zugseil // Cable
B400-23	Olive // Olive 3 mm
B400-26	Olive // Olive 6 mm
B400-29	Olive // Olive 9 mm
B400-32	Olive // Olive 12 mm
B400-35	Olive // Olive 15 mm

Venenstripper
Vein Strippers



MYERS

6 mm	B405-06
9 mm	B405-09
12 mm	B405-12
15 mm	B405-15

Endarterektomiestripper
Endarterectomy Strippers



Griff
Handle
B406-00



55 cm // 21 1/2"

2 mm	B406-02
3 mm	B406-03
4 mm	B406-04
6 mm	B406-06
7 mm	B406-07
8,5 mm	B406-08
10 mm	B406-10
12 mm	B406-12
14 mm	B406-14

Gefäß-Instrumente Vascular Instruments

Spülkanülen
Irrigating cannulas



SCHMID

3 mm	B410-03
4 mm	B410-04
5 mm	B410-05
6 mm	B410-06

Gefäß-Spatel
Vascular spatulas



SCHMID

14 cm // 5 1/2"	5 mm	B411-14
24 cm // 9 3/4"	7 mm	B411-24



VARADY



Fig. 1



Fig. 2



Fig. 3



Fig. 4



Fig. 5



Fig. 6

Fig. 1	B412-01	Phlebodissektor // <i>Phlebodissector</i>
Fig. 2	B412-02	Phlebextraktor Fig. 1 // <i>Phlebextractor Fig. 1</i>
Fig. 3	B412-03	Phlebextraktor Fig. 2 // <i>Phlebextractor Fig. 2</i>
Fig. 4	B412-04	Mikro-Doppelspatel // <i>Micro-Spatula</i>
Fig. 5	B412-05	Mikro-Phleboextraktor // <i>Micro-Phleboextractor</i>
Fig. 6	B412-06	Mini-Phleboextraktor // <i>Mini-Phleboextractor</i>

Gefäß-Instrumente
Vascular Instruments

Gefäß-Dilatoren
Vessel Dilators



DEBAKEY
19 cm // 7 1/2"

0,5 mm	B441-05
1,0 mm	B441-10
1,5 mm	B441-15
2,0 mm	B441-20
2,5 mm	B441-25
3,0 mm	B441-30
3,5 mm	B441-35
4,0 mm	B441-40
4,5 mm	B441-45
5,0 mm	B441-50
7,0 mm	B441-70
9,0 mm	B441-90



GARRETT

	14 cm // 5 1/2"	21 cm // 8 1/4"
1,0 mm	B444-10	B445-10
1,5 mm	B444-15	B445-15
2,0 mm	B444-20	B445-20
2,5 mm	B444-25	B445-25
3,0 mm	B444-30	B445-30
3,5 mm	B444-35	B445-35
4,0 mm	B444-40	B445-40
4,5 mm	B444-45	B445-45
5,0 mm	B444-50	B445-50



RITTER-HALLE
Dilator

2,0 mm	B470-01
2,5 mm	B470-02
3,0 mm	B470-03
4,0 mm	B470-04
5,0 mm	B470-05



Sehenschäler
Tendon strippers

2 mm	B480-02
3 mm	B480-03
4 mm	B480-04
6 mm	B480-05

BUNNELL
15 cm // 6"



4 mm	B490-01
4,5 mm	B490-02
5,5 mm	B490-03

BUNNELL
23 cm // 9"



BRAND



30 cm // 12"
3 mm

B481-30



50 cm // 20"
6 mm

B481-50

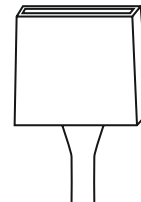

50 cm // 20"
6x14 mm

B482-50



Sehnenführer
Tendon passing instrument

BUNNELL
23 cm // 9"
B492-23

Gefäß-Instrumente
Vascular Instruments

Sehnenfasspinzetten, Sehnenfasszangen
Tendon Seizing Instruments



LARSEN
10 cm // 4"

2 mm	B500-02
3 mm	B500-03
4 mm	B500-04
5 mm	B500-05

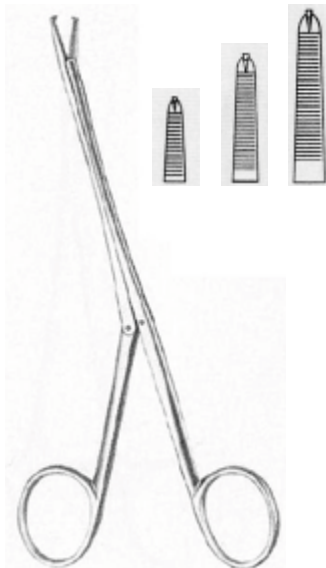

BRAND

	gerade straight	gebogen curved
15 cm // 6"	B502-15	B503-15
19 cm // 7 1/2"	B502-19	B503-19
24 cm // 9 1/2"	B502-24	B503-24



STEINMANN
16 cm // 6 1/4"
B505-16



KLEINERT-KUTZ
20 cm // 8"
B508-20



STEINMANN
16 cm // 6 1/4"
B511-15

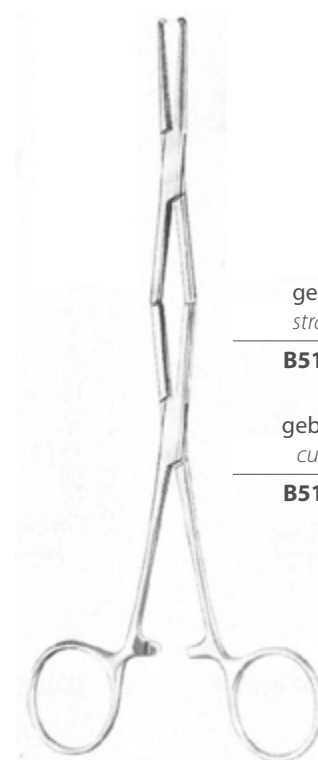

gerade
straight

B512-01

gebogen
curved

B512-02

20 cm // 8"



CAROLL
B514-11



gerade
straight

B516-01

gebogen
curved

B516-02

15 cm // 6"



Bleihand
Lead hands

Für Kinder
For children

B520-01

Für Erwachsene
For adults

B520-02

Fingerringsägen, Instrumente für Nagelpflege
Finger Ring Saws, Nail Instruments



Fingerringssäge
Fingerring saws

B524-17



Fingerringssäge
Fingerring saws

B525-17

Sägeblatt allein
Saw blade only

B524-51

Sägeblatt allein
Saw blade only

B525-51



Fingernagelbohrer komplett
Finger nail drill complete

B528-00



Fig. 1

B528-01



Fig. 2

B528-02



Fig. 3

B528-03

Bohrer allein
Drills only



ANVIL

Nagelspaltzange
Nail nipper
13 cm // 5"

B530-13



RADOLF

Nagelausreißzange
Forceps for tearing out nails
13,5 cm // 5 1/4"

B532-13

Nagelzangen Nail Nippers

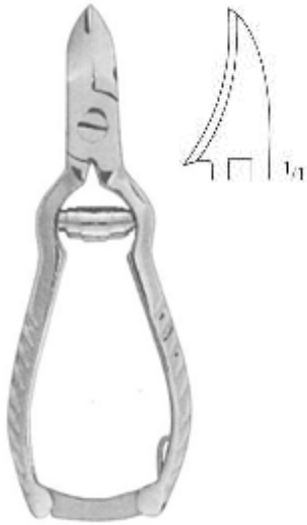

11 cm // 4 1/2" | **B535-11**
13 cm // 5" | **B535-13**



14 cm // 5 1/2" | **B536-14**



14 cm // 5 1/2"

B537-14

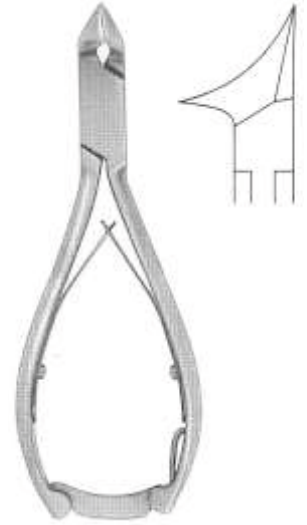

14 cm // 5 1/2" | **B538-14**



11 cm // 4 1/2" | **B540-11**
13 cm // 5" | **B540-13**
15 cm // 6" | **B540-15**

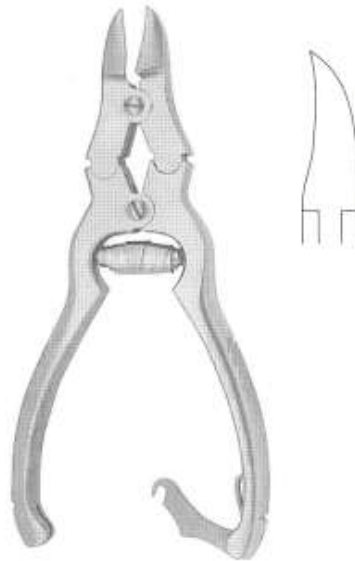

15 cm // 6" | **B547-15**

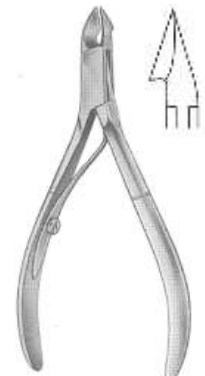

10 cm // 4" | **B550-10**

Nagelfeilen Nail files



B560-00



10 cm // 4" | **B561-10**



16 cm // 6 1/4" | **B562-16**

Dermatologie
Dermatology



SCHAMBERG
10 cm // 4"
B570-10



UNNA
14 cm // 5 1/2"

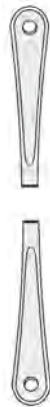

B571-01



B571-02



SAALFELD



10 cm // 4"
B572-01



14 cm // 5 1/2"
B572-02



VIDAL

Lupusschaber
Lupus scraper
14 cm // 5 1/2"

B574-14



PIFFARD
14 cm // 5 1/2"



Fig. 1

B577-01



Fig. 2

B577-02



Fig. 3

B577-03



FOX
14 cm // 5 1/2"



Fig. 1

B578-03



Fig. 2

B578-04



Fig. 3

B578-05



Fig. 4

B578-06



KEYES
10 cm // 4"

2 mm	B580-02
3 mm	B580-03
4 mm	B580-04
5 mm	B580-05
6 mm	B580-06
7 mm	B580-07
8 mm	B580-08



Satz, 2-7 mm
Set, 2-7 mm
B580-00



WOLF
14 cm // 5 1/2"

Fig. 1	B582-01
Fig. 2	B582-02
Fig. 3	B582-03
Fig. 4	B582-04
Fig. 5	B582-05
Fig. 6	B582-06

Führungsnadeln, Trokare Guide Needles, Trocars

Führungsnadeln Redon Guide Needles Redon



REDON



Charr. 8	B590-01
Charr. 10	B590-02
Charr. 12	B590-03
Charr. 14	B590-04
Charr. 16	B590-05
Charr. 18	B590-06



Charr. 8	B590-11
Charr. 10	B590-12
Charr. 12	B590-13
Charr. 14	B590-14
Charr. 16	B590-15
Charr. 18	B590-16



Charr. 8	B590-21
Charr. 10	B590-22
Charr. 12	B590-23
Charr. 14	B590-24
Charr. 16	B590-25
Charr. 18	B590-26

Trokare Trocars



NELSON
11 cm // 4 3/4"

3,0 mm	B600-30
3,5 mm	B600-35
4,0 mm	B600-40
4,5 mm	B600-45
5,0 mm	B600-50
5,5 mm	B600-55
6,0 mm	B600-60
6,5 mm	B600-65
8,3 mm	B600-83
10,0 mm	B600-90
11,7 mm	B600-91

Trokare
Trocars



Satz zu 3 Stück
Set of 3 pieces

B611-03

Satz zu 4 Stück
Set of 4 pieces

B611-04



OCHSNER
14 cm // 5 1/2"

4,0 mm | **B612-40**

4,6 mm | **B612-46**

5,5 mm | **B612-55**

6,5 mm | **B612-65**



KRAUSE
16 cm // 6 1/4"

B614-00



COAKLEY
14 cm // 5 1/2"

B615-00



PIERCE
16 cm // 6 1/4"

3 mm | **B617-03**

4 mm | **B617-04**

5 mm | **B617-05**



LANDAU
16 cm // 6 1/4"

B620-16



LANDAU
19 cm // 7 1/2"

B620-19



LICHTWITZ
19 cm // 7 1/2"

B622-19

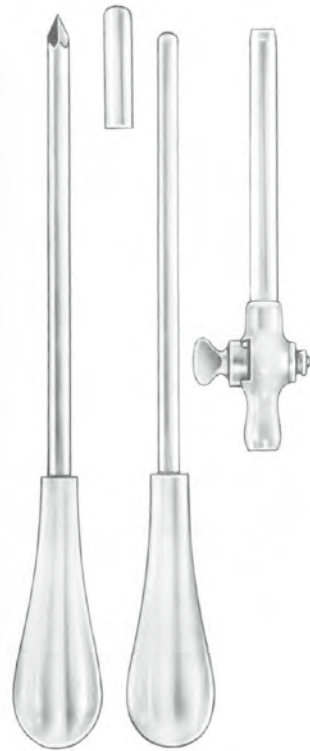

BUELAU
24 cm // 6 1/4"
B620-16



LICHTWITZ
1,2 mm | **B630-01**
1,6 mm | **B630-02**

Sinuskopietrokar
Sinuscopy Trocar



2,7 mm	B625-02	-
4,0 mm	B625-04	B625-14
5,0 mm	B625-05	B625-15

Saugrohre
Suction tubes



BABY-YANKAUER
21 cm // 8 1/4"

Schlauchverbindung alleine
Tubing connection only
B650-51



YANKAUER
27 cm // 10 1/2"

Mit großer Bohrung
With large hole
B650-02



YANKAUER
27 cm // 10 1/2"



ANDREW-PYNCHON
24 cm // 9 1/2"



DEBAKEY
27,5 cm // 10 1/2"

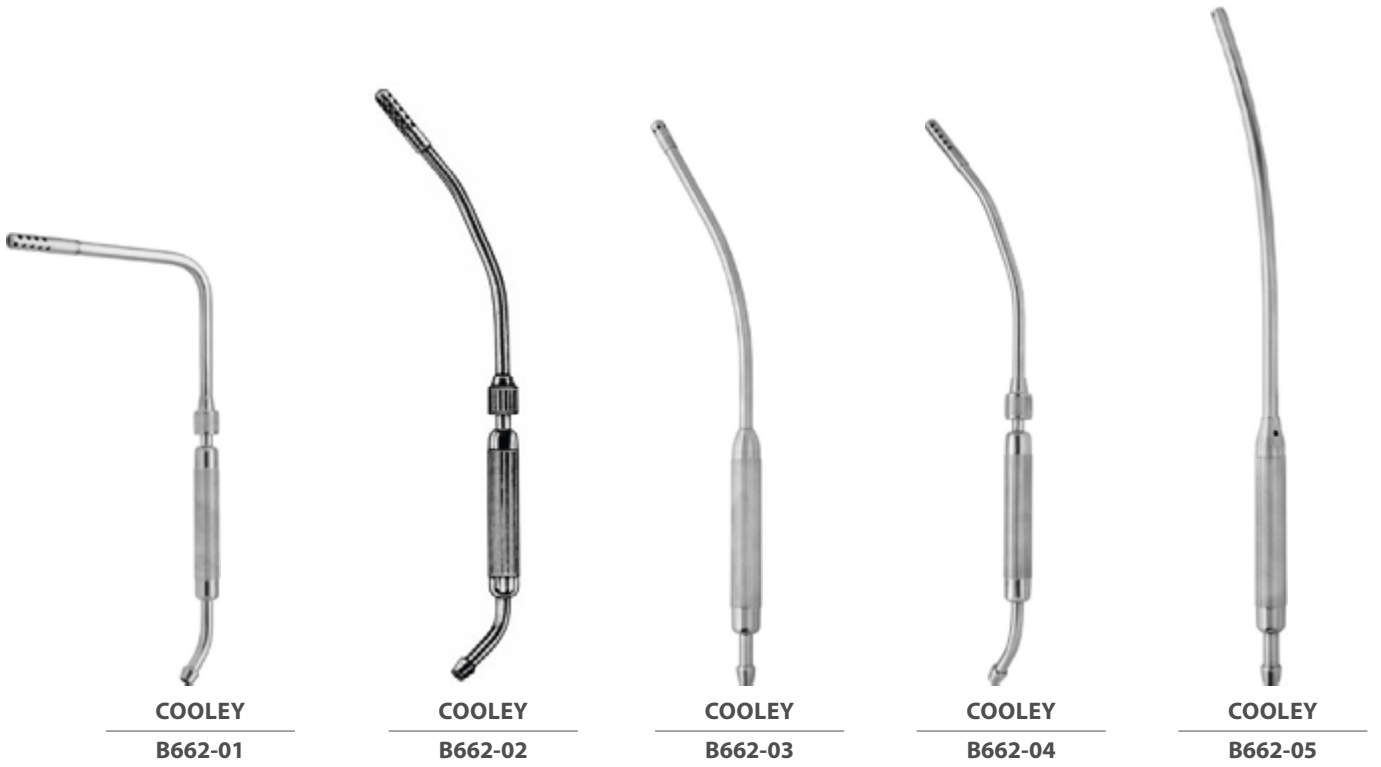

COOLEY
B662-01

COOLEY
B662-02

COOLEY
B662-03

COOLEY
B662-04

COOLEY
B662-05

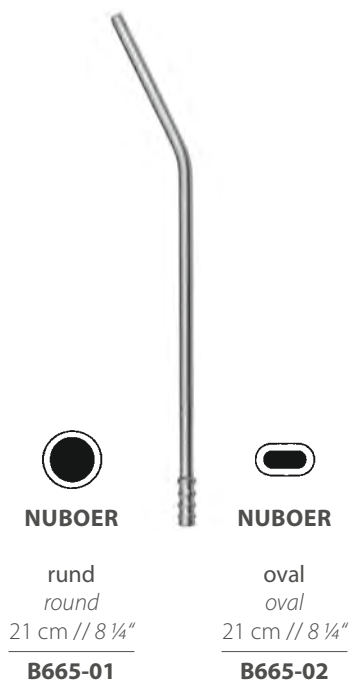

NUBOER

rund
round
21 cm // 8 1/4"

B665-01



NUBOER

oval
oval
21 cm // 8 1/4"

B665-02

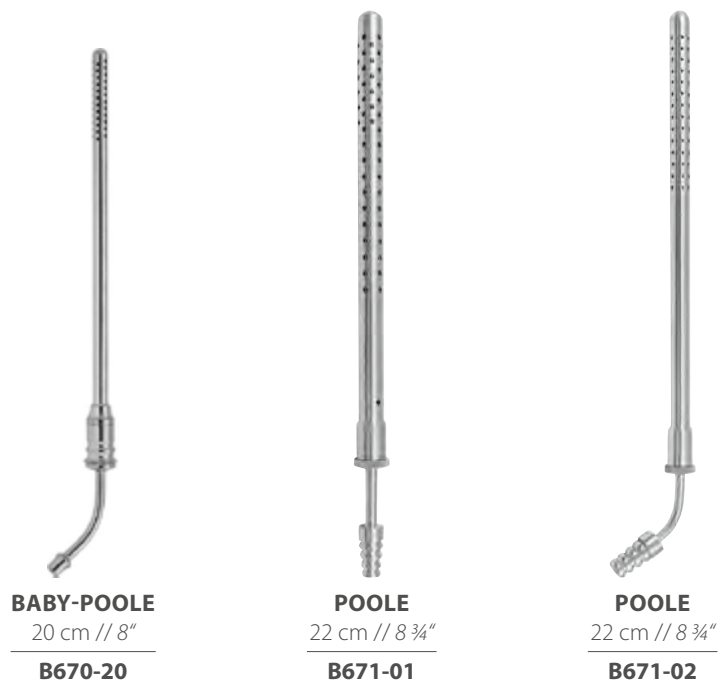

BABY-POOLE
20 cm // 8"

POOLE
22 cm // 8 3/4"

POOLE
22 cm // 8 3/4"

Saugrohre, Kanülen
Suction Tubes, Needles



ANTHONY

2 mm	B674-01
3 mm	B674-02



FRANKLIN-SILVERMAN

B700-00



Biopsiekanülen
Biopsy Needles

1,00 x 35 mm	B701-01
1,00 x 70 mm	B701-02
1,20 x 70 mm	B701-03
1,20 x 100 mm	B701-04
1,40 x 70 mm	B701-05
1,40 x 100 mm	B701-06
1,60 x 70 mm	B701-07
1,80 x 100 mm	B701-08
1,40 x 168 mm	B701-21
1,80 x 168 mm	B701-22

MENGHINI



BIER

1,0 x 80 mm	B703-01
1,2 x 80 mm	B703-02
1,5 x 80 mm	B703-03
1,8 x 80 mm	B703-04



KLIMA-ROSEGGER

B706-00



QUINKE

1,20 x 76 mm	B710-01
1,20 x 89 mm	B710-02
1,00 x 76 mm	B710-03
1,00 x 89 mm	B710-04
0,70 x 76 mm	B710-05
0,70 x 50 mm	B710-06
0,70 x 89 mm	B710-07

Kanülen Needles

Tonsillenkanülen Septum Needles



B724-01



B724-02



B724-03



B724-04



B724-05



B724-06



VAN ALYEA

Kurze Biegung
Short curve

B725-01



VAN ALYEA

Lange Biegung
Long

B725-02



Saug-Spülrohr, 5 mm
Suction tube, 5 mm

B727-00

Saugrohre
Suction tubes

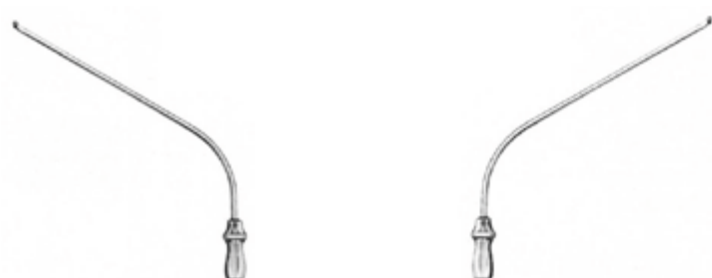

HARTMANN

B731-01	2,0 mm	B731-11
B731-02	2,5 mm	B731-12
B731-03	3,0 mm	B731-13



EICKEN

B734-11	2,5 mm	B734-01
B734-12	3,0 mm	B734-02
B734-13	3,5 mm	B734-03
B734-14	4,0 mm	B734-04



HAJEK
16,5 cm // 6 ½"
B736-00



KILLIAN
18 cm // 7 ½"
B730-18



2 mm	Charr. 6	B740-01
2,5 mm	Charr. 8	B740-02
3 mm	Charr. 9	B740-03

Saugrohre, Saughandgriffe, Saugkanülen
Suction tubes, Suction handles, Suction cannulas



HOUSE
 5,5 cm // 2 1/8"
B750-01



HOUSE
 5,5 cm // 2 1/8"
B750-02



10 cm // 4"
B750-05



10 cm // 4"
B750-06

Saugkanülen
Suction cannulas



ROSEN
 8 cm // 3 1/4"

0,5 mm	B751-05	B752-05
0,7 mm	B751-07	B752-07
0,8 mm	B751-08	B752-08
0,9 mm	B751-09	B752-09
1,0 mm	B751-10	B752-10
1,2 mm	B751-12	B752-12
1,4 mm	B751-14	B752-14
1,5 mm	B751-15	B752-15
1,8 mm	B751-18	B752-18
2,0 mm	B751-20	B752-20
2,5 mm	B751-25	B752-25
3,0 mm	B751-30	B752-30

Reinigungsdraht
Wire of cleaning

0,3 mm	B751-53
0,5 mm	B751-55
0,6 mm	B751-56
0,9 mm	B751-59

Saugrohre
Suction tubes

Verwendbar mit Mikroaufsätzen
Usable with Micro inserts



ZÖLLNER
15 cm // 6"
B754-00



WULLSTEIN
15 cm // 6"
B755-00



WULLSTEIN
Mikroaufsätze
Micro inserts

0,5 mm	B754-05
0,7 mm	B754-07
0,9 mm	B754-09
1,2 mm	B754-12



SCHUKNECHT
13 cm // 5"

0,5 mm	Gauge 24	B756-05
0,7 mm	Gauge 22	B756-07
0,9 mm	Gauge 20	B756-09



HOUSE
Arbeitslänge 90mm
Working length 90mm

Saugrohr Suction tube	Spülrohr Irrigation tube	
0,9 mm	0,7 mm	B757-03
1,2 mm	0,9 mm	B757-04
1,5 mm	1,2 mm	B757-06
1,8 mm	1,8 mm	B757-08
2,5 mm	2,0 mm	B757-10
3,0 mm	2,0 mm	B757-12
4,5 mm	2,0 mm	B757-15



BARON

		Arbeitslänge Working Length	Arbeitslänge Working Length
		7 cm	10 cm
1,0 mm	Charr. 3	B758-01	B758-11
1,5 mm	Charr. 5	B758-02	B758-12
2,3 mm	Charr. 7	B758-03	B758-13



WULLSTEIN

1,5 mm	Charr. 5	B760-15
2,0 mm	Charr. 6	B760-20



BARNES

1,5 mm	B767-01
1,7 mm	B767-02
2,0 mm	B767-03



	Arbeitslänge <i>Working Length</i>	Arbeitslänge <i>Working Length</i>
	9 cm	11 cm
1,0 mm	B770-01	-
1,5 mm	B770-02	-
2,0 mm	B770-03	-
2,5 mm	-	B770-14
3,0 mm	-	B770-15
4,0 mm	-	B770-17
5,0 mm	-	B770-19



	Arbeitslänge <i>Working Length</i>	Arbeitslänge <i>Working Length</i>
	11 cm	13 cm
1,0 mm	B770-25	-
1,5 mm	B770-26	-
2,0 mm	-	B770-38

Saugrohre
Suction tubes

Flache Saugöffnung
Flat Suction tip



Nasensaugrohr
Nasal Suction tube
16,5 cm // 6 1/2"
5 mm

B772-17



FISCH

Saugrohr Suction tube	Spülrohr Irrigation tube	
1,0 mm	1,0 mm	B785-01
1,5 mm	1,5 mm	B785-02
1,8 mm	1,8 mm	B785-03
2,5 mm	2,0 mm	B785-04
3,0 mm	2,0 mm	B785-05
4,5 mm	2,0 mm	B785-06



3 mm

B806-03



PLESTER

19,5 cm // 7 3/4"

1,5 mm	Charr. 5	B812-05
2 mm	Charr. 6	B812-06
2,5 mm	Charr. 8	B812-08
3 mm	Charr. 9	B812-09



ADSON

		Arbeitslänge Working Length	Arbeitslänge Working Length
		10 cm	15 cm
3,5 mm	Charr. 11	B813-01	-
4 mm	Charr. 12	-	B813-02
5 mm	Charr. 15	-	B813-03



YASARGIL

	Arbeitslänge <i>Working Length</i>			
	13 cm // 5"	15 cm // 6"	18 cm // 7"	22 cm // 8 ¾"
1,5 mm	B818-105	B818-205	B818-305	B818-405
2,0 mm	B818-106	B818-206	B818-306	B818-406
2,5 mm	B818-108	B818-208	B818-308	B818-408
3,5 mm	B818-111	B818-211	B818-311	B818-411
4,5 mm	-	-	B818-314	-



FRAZIER

	Arbeitslänge <i>Working Length</i>
	13 cm // 5"
Charr. 6	B820-306
Charr. 7	B820-307
Charr. 8	B820-308
Charr. 9	B820-309
Charr. 10	B820-310
Charr. 11	B820-311
Charr. 12	B820-312

Saugrohre
Suction tubes

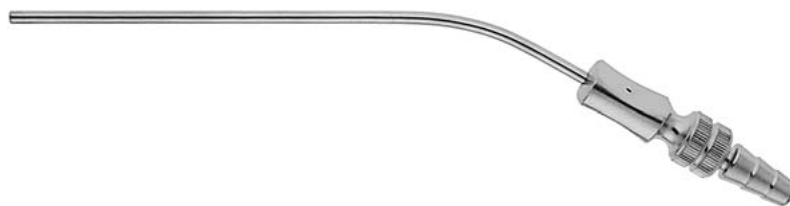
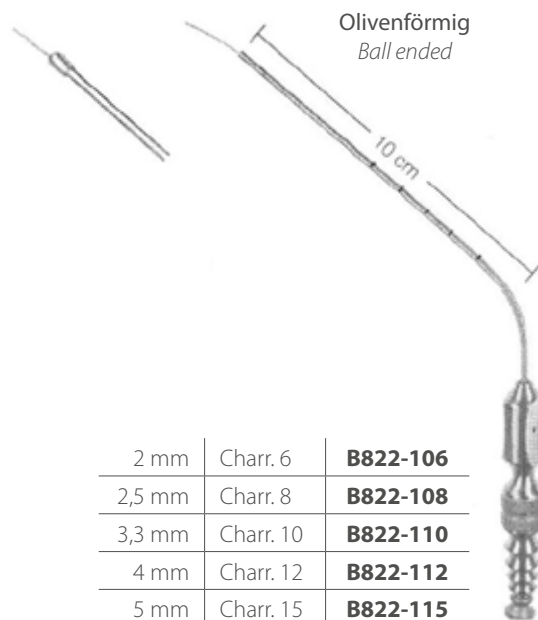

FRAZIER

		Arbeitslänge Working Length					
		9 cm // 3 1/2"	11 cm // 4 1/2"	13 cm // 5"	15 cm // 6"	19 cm // 7 1/2"	25 cm // 10"
1,5 mm	Charr. 5	B825-105	B825-205	B825-305	B825-405	B825-605	-
2 mm	Charr. 6	B825-106	B825-206	B825-306	B825-406	B825-606	B825-806
2,3 mm	Charr. 7	B825-107	B825-207	B825-307	B825-407	B825-607	B825-807
2,5 mm	Charr. 8	B825-108	B825-208	B825-308	B825-408	B825-608	B825-808
3 mm	Charr. 9	B825-109	B825-209	B825-309	B825-409	B825-609	B825-809
3,3 mm	Charr. 10	B825-110	B825-210	B825-310	B825-410	B825-610	B825-810
3,5 mm	Charr. 11	B825-111	B825-211	B825-311	B825-411	B825-611	B825-811
4 mm	Charr. 12	B825-112	B825-212	B825-312	B825-412	B825-612	B825-812
4,5 mm	Charr. 14	B825-113	B825-213	-	-	-	-
5 mm	Charr. 15	-	B825-215	B825-315	B825-415	B825-615	B825-815

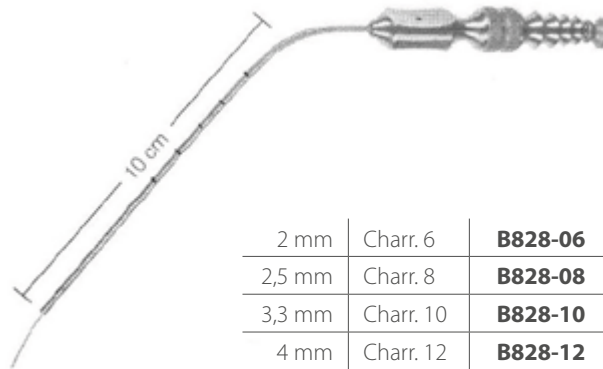

FRAZIER

Mit Markierung
With calibration

2 mm	Charr. 6	B828-06
2,5 mm	Charr. 8	B828-08
3,3 mm	Charr. 10	B828-10
4 mm	Charr. 12	B828-12
5 mm	Charr. 15	B828-15



90 Grad
90 degrees

FERGUSSON

Arbeitslänge, 7 cm
Working length, 7 cm

2 mm	Charr. 6	B835-106
2,3 mm	Charr. 7	B835-107
2,5 mm	Charr. 8	B835-108
3 mm	Charr. 9	B835-109
3,3 mm	Charr. 10	B835-110
3,5 mm	Charr. 11	B835-111
4 mm	Charr. 12	B835-112
5 mm	Charr. 15	B835-115



Schwarz
Black

Arbeitslänge, 10 cm
Working length, 10 cm

2 mm	Charr. 6	B839-06
3 mm	Charr. 9	B839-08
4 mm	Charr. 12	B839-12
5 mm	Charr. 15	B839-15

3 FR	4 FR	5 FR	6 FR	7 FR	8 FR	9 FR	10 FR	11 FR	12 FR	14 FR	15 FR
1,0 mm	1,3 mm	1,6 mm	2,0 mm	2,3 mm	2,6 mm	3,0 mm	3,3 mm	3,6 mm	4,0 mm	4,6 mm	5,0 mm

Saugrohre
Suction tubes



75 Grad
75 degrees

FRAZIER
Arbeitslänge, 10 cm
Working length, 10 cm

1 mm	Charr. 3	B840-03
1,3 mm	Charr. 4	B840-04
1,6 mm	Charr. 5	B840-05
2 mm	Charr. 6	B840-06
2,3 mm	Charr. 7	B840-07
2,6 mm	Charr. 8	B840-08
3 mm	Charr. 9	B840-09
3,3 mm	Charr. 10	B840-10
3,6 mm	Charr. 11	B840-11
4 mm	Charr. 12	B840-12
4,6 mm	Charr. 14	B840-14
5 mm	Charr. 15	B840-15

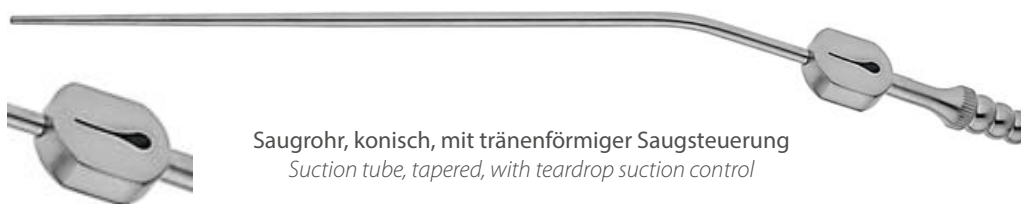

Saugrohr, konisch, mit tränenförmiger Saugsteuerung
Suction tube, tapered, with teardrop suction control

	100 mm	115 mm	140 mm	165 mm
Charr. 3	B841-103	B841-203	B841-303	B841-403
Charr. 4	B841-104	B841-204	B841-304	B841-404
Charr. 5	B841-105	B841-205	B841-305	B841-405
Charr. 6	B841-106	B841-206	B841-306	B841-406
Charr. 7	B841-107	B841-207	B841-307	B841-407
Charr. 8	B841-108	B841-208	B841-308	B841-408
Charr. 9	B841-109	B841-209	B841-309	B841-409
Charr. 10	B841-110	B841-210	B841-310	B841-410
Charr. 12	B841-112	B841-212	B841-312	B841-412

Spritzen Syringes



„Perfect“ Spritze mit Ringen
„Perfect“ Syringe with rings

	Spritze Syringe	Ersatzzylinder Spare barrel
2 ml	B880-02	B880-52
5 ml	B880-05	B880-55
10 ml	B880-10	B880-60
20 ml	B880-20	B880-70



Spritze Janet
Syringe Janet

	Spritze Syringe	Ersatzzylinder Spare barrel
50 ml	B885-05	B885-55
75 ml	B885-07	B885-57
100 ml	B885-10	B885-60
150 ml	B885-15	B885-65
200 ml	B885-20	B885-70

Scheren

// Scissors

Inhalt

Index

Abschnitt **C**
// Section

Chirurgische Scheren <i>Operating Scissors</i>	C02 - C06
Präparierscheren <i>Dissecting Scissors</i>	C07 - C12
Episiotomiescheren, Parametriumscheren <i>Episiotomy Scissors, Parametrium Scissors</i>	C13
Nabelschnurscheren, Darmscheren <i>Umbilical Scissors, Enterotomy Scissors</i>	C14
Gefäßscheren <i>Vascular Scissors</i>	C15 - C17
Feine Scheren <i>Fine Scissors</i>	C18 - C25, C28
Scheren für plastische Chirurgie <i>Scissors for plastic surgery</i>	C26 - C27
Tonsillenscheren, Nasenscheren <i>Tonsil Scissors, Nasal Scissors</i>	C29 - C30
Zahnfleischscheren <i>Gum Scissors</i>	C30 - C31
Ligaturscheren <i>Ligature Scissors</i>	C31 - C32
Drahtscheren <i>Wire cutting Scissors</i>	C32
Nagelscheren, Verbandscheren <i>Nail Scissors, Bandage Scissors</i>	C32 - C36
Mikroscheren <i>Micro Scissors</i>	C37 - C49

Chirurgische Scheren
Operating Scissors



gerade
straight

	stumpf / stumpf blunt / blunt	spitz / stumpf sharp / blunt	spitz / spitz sharp / sharp
10,5 cm // 4 1/4"	C100-10	C102-10	C104-10
11,5 cm // 4 1/2"	C100-11	C102-11	C104-11
13,0 cm // 5"	C100-13	C102-13	C104-13
14,5 cm // 5 3/4"	C100-14	C102-14	C104-14
14,5 cm // 5 3/4"	-	C102-14N	-
14,5 cm // 5 3/4"	-	C102-14S	-
14,5 cm // 5 3/4"	C100-14T	C102-14T	C104-14T
15,5 cm // 6"	C100-15	C102-15	C104-15
16,5 cm // 6 1/2"	C100-16	C102-16	C104-16
17,5 cm // 7"	C100-17	C102-17	C104-17
18,5 cm // 7 1/4"	C100-18	C102-18	C104-18
20,0 cm // 8"	C100-20	C102-20	C104-20



gebogen
curved

10,5 cm // 4 1/4"	C101-10	C103-10	C105-10
11,5 cm // 4 1/2"	C101-11	C103-11	C105-11
13,0 cm // 5"	C101-13	C103-13	C105-13
14,5 cm // 5 3/4"	C101-14	C103-14	C105-14
14,5 cm // 5 3/4"	-	C103-14S	-
14,5 cm // 5 3/4"	C101-14T	C103-14T	C105-14T
14,5 cm // 5 3/4"	C101-14TW	-	-
15,5 cm // 6"	C101-15	C103-15	C105-15
16,5 cm // 6 1/2"	C101-16	C103-16	C105-16
17,5 cm // 7"	C101-17	C103-17	C105-17
18,5 cm // 7 1/4"	C101-18	C103-18	C105-18
20,0 cm // 8"	C101-20	C103-20	C105-20

Chirurgische Scheren Operating Scissors



GRAZIL



	stumpf/stumpf <i>blunt/blunt</i>	spitz/stumpf <i>sharp/blunt</i>	spitz/spitz <i>sharp/sharp</i>
13,0 cm // 5"	C110-13	C112-13	C114-13
14,5 cm // 5 3/4"	C110-14	C112-14	C114-14
	gebogen <i>curved</i>	gebogen <i>curved</i>	gebogen <i>curved</i>
13,0 cm // 5"	C111-13	C113-13	C115-13
14,5 cm // 5 3/4"	C111-14	C113-14	C115-14

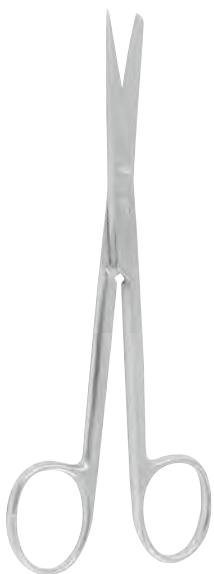

DEAVER
14,5 cm // 5 3/4"



gerade
straight
C120-14



gebogen
curved
C121-14



MIXTER
15 cm // 6"



gerade
straight
C122-15



gebogen
curved
C123-15

Chirurgische Scheren
Operating Scissors

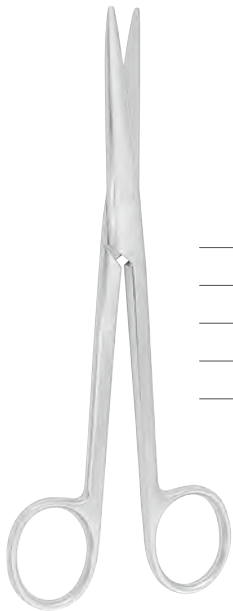

LEXER
16 cm // 6 1/4"

gerade straight	gebogen curved
C124-16	C125-16
C124-16S	C125-16S
C124-16T	C125-16T
C124-16TS	C125-16TS
-	C125-16TW

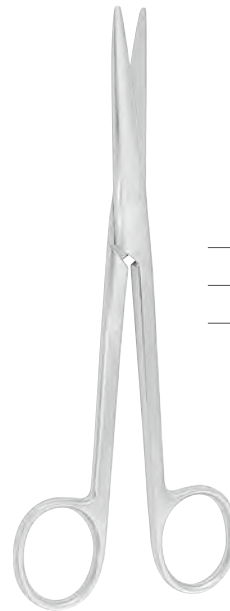

LEXER-FINO
16 cm // 6 1/4"

gerade straight	gebogen curved
C126-16	C127-16
C126-16T	C127-16T
-	C127-16TW

Inzisionsscheren
Incision Scissors

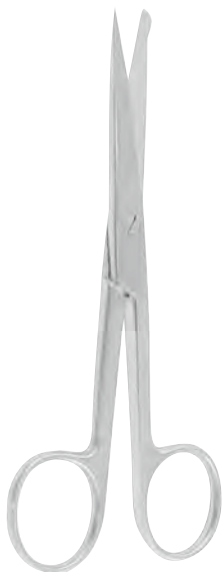

13,0 cm // 5"	C135-13
14,5 cm // 5 3/4"	C135-14
16,5 cm // 6 1/2"	C135-16



RICHTER
14,5 cm // 5 3/4"
C136-14



FERGUSSON
18 cm // 7"
C138-18

Chirurgische Scheren Operating Scissors

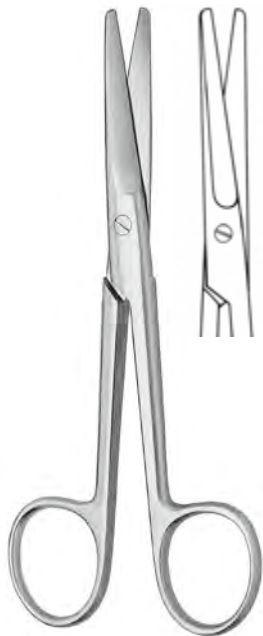

MAYO

	gerade straight	gebogen curved
14,5 cm // 5 3/4"	C150-14	C151-14
14,5 cm // 5 3/4"	C150-14S	C151-14S
14,5 cm // 5 3/4"	C150-14T	C151-14T
14,5 cm // 5 3/4"	C150-14TS	C151-14TS
14,5 cm // 5 3/4"	-	C151-14TW
15 cm // 6"	C150-15	C151-15
15 cm // 6"	C150-15N	C151-15N
17 cm // 6 3/4"	C150-17	C151-17
17 cm // 6 3/4"	C150-17N	C151-17N
17 cm // 6 3/4"	C150-17S	C151-17S
17 cm // 6 3/4"	C150-17T	C151-17T
17 cm // 6 3/4"	C150-17TS	C151-17TS
17 cm // 6 3/4"	-	C151-17TW
19 cm // 7 1/2"	C150-19	C151-19
23 cm // 9"	C150-23	C151-23
23 cm // 9"	C150-23S	C151-23S
23 cm // 9"	C150-23T	C151-23T
23 cm // 9"	C150-23TS	C151-23TS
23 cm // 9"	-	C151-23TW
28 cm // 11"	C150-28	C151-28
28 cm // 11"	C150-28S	C151-28S
30 cm // 12"	C150-30S	-

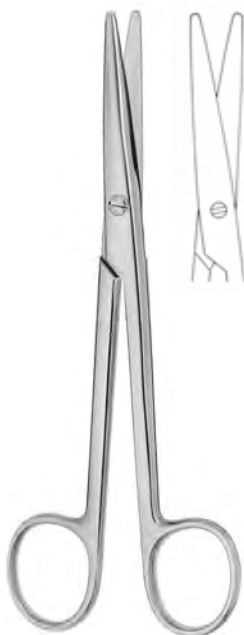

MAYO-STILLE

	gerade straight	gebogen curved
15 cm // 6"	C160-15	C161-15
15 cm // 6"	C160-15S	C161-15S
15 cm // 6"	C160-15T	C161-15T
15 cm // 6"	C160-15TS	C161-15TS
17 cm // 6 3/4"	C160-17	C161-17
17 cm // 6 3/4"	C160-17S	C161-17S
17 cm // 6 3/4"	C160-17T	C161-17T
17 cm // 6 3/4"	C160-17TS	C161-17TS
19 cm // 7 1/2"	C160-19	C161-19
21 cm // 8 1/4"	-	C161-21

Chirurgische Scheren
Operating Scissors



gerade
straight

C164-17

gebogen
curved

C165-17

MAYO-NOBLE
17 cm // 6 3/4"



DOYEN



gerade
straight

C172-16

gebogen
curved

C173-16

gerade
straight

C170-16

16 cm // 6 1/4"

18 cm // 7"

C172-18

C173-18

-



MARTIN-CARTILAGE
20 cm // 8"
C180-20



RESANO
25 cm // 10"
C182-25

Präparierscheren Dissecting Scissors



MCINDOE
19 cm // 7 1/2"
C186-19

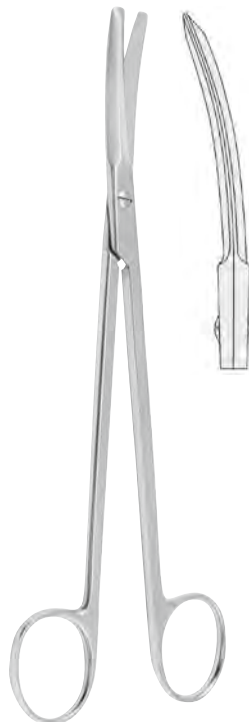

POTTS-SMITH
19 cm // 7 1/2"
C188-19

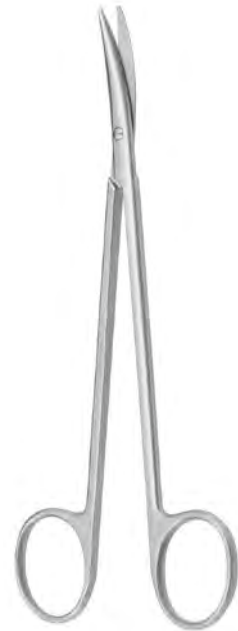

DEBAKEY
17,5 cm // 7"
C191-17

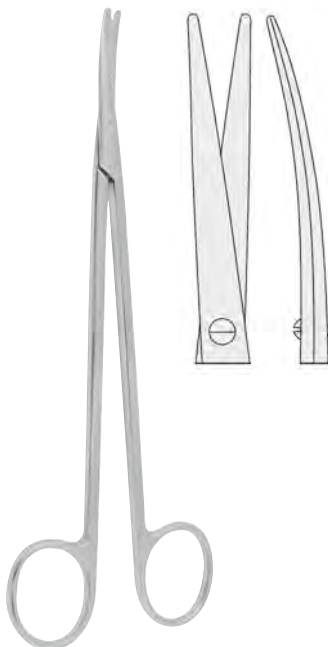

TÖNNIS-ADSON
17,5 cm // 6 3/4"

C193-17

C193-17S

C193-17T

C193-17TS

C193-17TW



TÖNNIS
18 cm // 7"

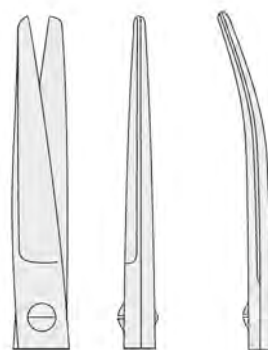

gerade
straight

C194-18

gebogen
curved

C195-18



TÖNNIS-FINE
18 cm // 7"

gerade
straight

C196-18

Präparierscheren
Dissecting Scissors

N	■ Titan
S	■ SuperCut
T	■ TC
TW	■ TC, WaveCut (serrated)
TS	■ TC, SuperCut
W	■ WaveCut (serrated)



METZENBAUM-STANDARD

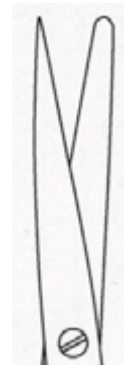

14,5 cm // 5 1/2"	C200-14	C202-14	C204-14
14,5 cm // 5 1/2"	C200-14S	-	-
14,5 cm // 5 1/2"	C200-14T	-	-
14,5 cm // 5 1/2"	C200-14TS	-	-
14,5 cm // 5 1/2"	C200-14N	-	-
14,5 cm // 5 1/2"	-	-	C204-14W

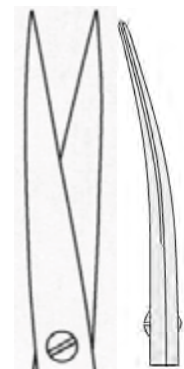
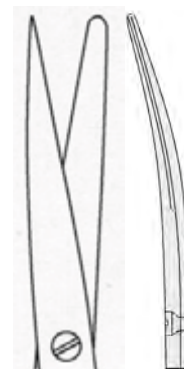
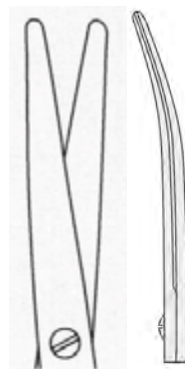

13 cm // 5"	C201-13	-	-
14,5 cm // 5 1/2"	C201-14	C203-14	C205-14
14,5 cm // 5 1/2"	C201-14S	-	-
14,5 cm // 5 1/2"	C201-14T	-	-
14,5 cm // 5 1/2"	C201-14TS	-	-
14,5 cm // 5 1/2"	C201-14TW	-	-
14,5 cm // 5 1/2"	C201-15N	-	-
14,5 cm // 5 1/2"	-	-	C205-14W

Präparierscheren Dissecting Scissors



METZENBAUM-STANDARD

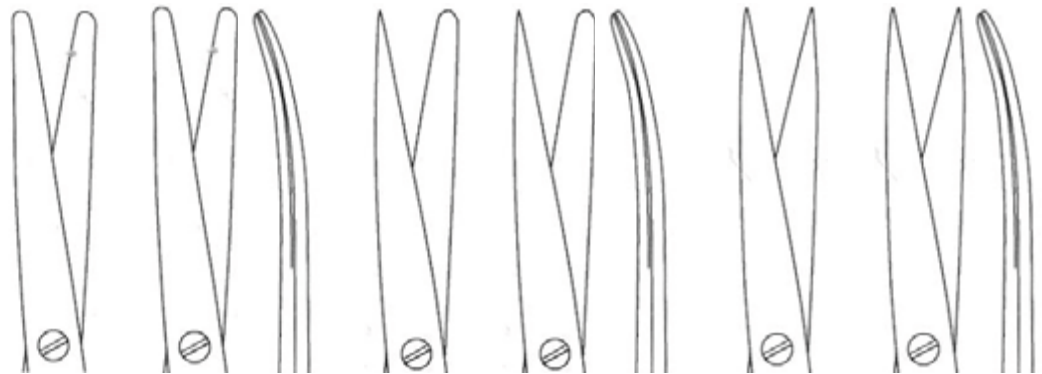

18 cm // 7"	C200-18	C201-18	C202-18	C203-18	C204-18	C205-18
18 cm // 7"	C200-18N	C201-18N	-	-	-	-
18 cm // 7"	C200-18S	C201-18S	-	-	-	-
18 cm // 7"	C200-18T	C201-18T	-	-	-	-
18 cm // 7"	C200-18TS	C201-18TS	-	-	-	-
18 cm // 7"	-	C201-18TW	-	-	-	-
20 cm // 8"	C200-20	C201-20	C202-20	C203-20	C204-20	C205-20
20 cm // 8"	C200-20S	C201-20S	-	-	-	-
20 cm // 8"	C200-20T	C201-20T	-	-	-	-
20 cm // 8"	-	C201-20TS	-	-	-	-
20 cm // 8"	-	C201-20TW	-	-	-	-
23 cm // 9"	C200-23	C201-23	C202-23	C203-23	C204-23	C205-23
23 cm // 9"	C200-23N	C201-23N	-	-	-	-
23 cm // 9"	C200-23S	C201-23S	-	-	-	-
23 cm // 9"	C200-23T	C201-23T	-	-	-	-
23 cm // 9"	C200-23TS	C201-23TS	-	-	-	-
23 cm // 9"	-	C201-23TW	-	-	-	-
25 cm // 10"	C200-25	C201-25	C202-25	C203-25	C204-25	C205-25
25 cm // 10"	-	C201-25S	-	-	-	-
25 cm // 10"	C200-25T	C201-25T	-	-	-	-
28 cm // 11"	C200-28	C201-28	-	-	-	-
28 cm // 11"	-	C201-28S	-	-	-	-
28 cm // 11"	C200-28T	C201-28T	-	-	-	-
30 cm // 12"	C200-30	C201-30	-	-	-	-
30 cm // 12"	-	C201-30S	-	-	-	-
30 cm // 12"	C200-30T	C201-30T	-	-	-	-
36 cm // 14"	-	C201-36S	-	-	-	-
36 cm // 14"	-	C201-36T	-	-	-	-

Präparierscheren
Dissecting Scissors

N	■	Titan
S	■	SuperCut
T	■	TC
TW	■	TC, WaveCut (serrated)
TS	■	TC, SuperCut
W	□	WaveCut (serrated)



METZENBAUM-FINO

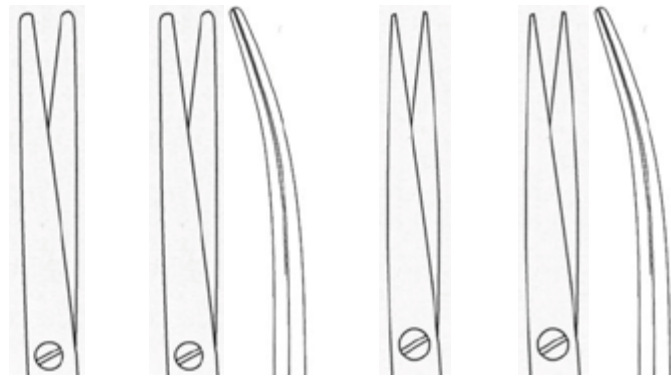

14,5 cm // 5 1/2"	C208-14	C209-14	C210-14	C211-14
14,5 cm // 5 1/2"	C208-14S	C209-14S	-	-
14,5 cm // 5 1/2"	C208-14T	C209-14T	C210-14T	C211-14T
18 cm // 7"	C208-18	C209-18	-	-
18 cm // 7"	-	C209-18N	-	-
18 cm // 7"	-	C209-18S	-	-
18 cm // 7"	C208-18T	C209-18T	C210-18T	C211-18T
20 cm // 8"	C208-20	C209-20	-	-
20 cm // 8"	C208-20T	C209-20T	C210-20T	-
23 cm // 9"	C208-23	C209-23	-	-
23 cm // 9"	-	C209-23S	-	-
23 cm // 9"	C208-23T	C209-23T	C210-23T	C211-23T
25 cm // 10"	C208-25	C209-25	-	-
25 cm // 10"	-	C209-25T	-	-
28 cm // 11"	-	C209-28	-	-
28 cm // 11"	-	C209-28T	-	-

Präparierscheren Dissecting Scissors



BABY-METZENBAUM
11,5 cm // 4 1/2"

gerade straight	gebogen curved
C214-11	C215-11
C214-11S	C215-11S
C214-11T	C215-11T



METZENBAUM-S

15 cm // 6"	C217-15T
18 cm // 7"	C217-18T
20 cm // 8"	C217-20T
23 cm // 9"	C217-23T
26 cm // 10"	C217-26T

Gynäkologische Scheren Gynecological Scissors

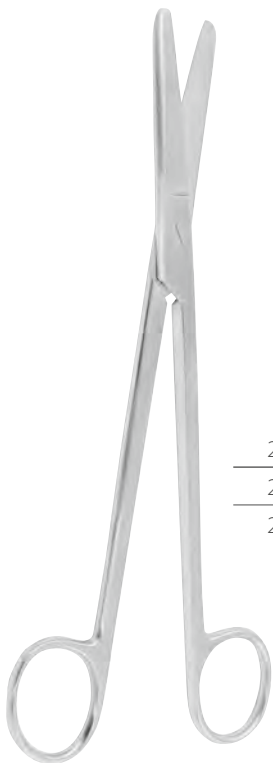

SIMS

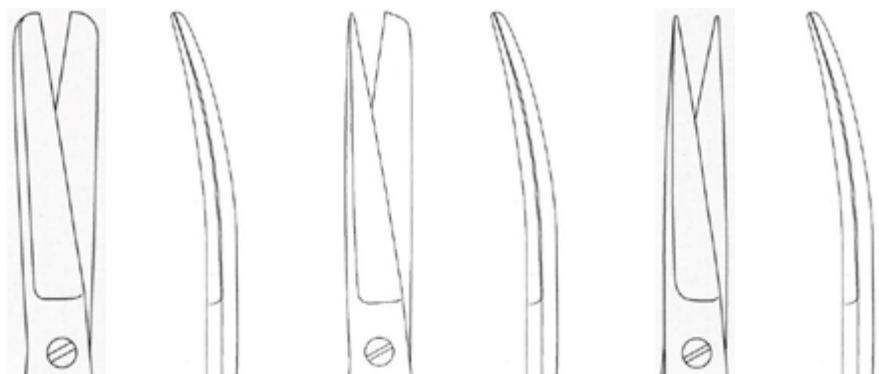

20 cm // 8"	C220-20	C221-20	C222-20	C223-20	C224-20	C225-20
23 cm // 9"	C220-23	C221-23	C222-23	C223-23	C224-23	C225-23
23 cm // 9"	-	C221-23T	-	-	-	-

Präparierscheren
Dissecting Scissors

N	■ Titan
S	■ SuperCut
T	■ TC
TW	■ TC, WaveCut (serrated)
TS	■ TC, SuperCut
W	■ WaveCut (serrated)

Kephalotom-Scheren
Cephalotomy Scissors



WERTHEIM

14,5 cm // 5 1/2"	C227-14
19 cm // 7 1/2"	C227-19
22 cm // 8 1/2"	C227-22



DUBOIS

27 cm // 10 1/2"

gerade straight	gebogen curved
C228-27	C229-27



JORGENSEN

22 cm // 8 1/2"

C231-22



SATINSKY

24,5 cm // 9 1/2"

C233-24



KLINGENBERG-LOTH

23 cm // 9"

C237-23



SIEBOLD

24 cm // 9 1/2"

C241-24

Episiotomiescheren Episiotomy Scissors



BRAUN-STADLER
14 cm // 5 1/2"

C250-14

C250-14S



BRAUN-STADLER
22 cm // 8 1/2"

C250-22

C250-22S



WALDMANN
18 cm // 7"

C252-18

C252-18W

Parametriumscheren Parametrium Scissors



19 cm // 7 1/2"

C256-19S

C256-19T

C256-19W



leicht gebogen
slightly curved

C258-231T

C258-261T



stark gebogen
strong curved

C258-234T

C258-264T

23 cm // 9"

26,5 cm // 10 1/2"

N	■ Titan
S	■ SuperCut
T	■ TC
TW	■ TC, WaveCut (serrated)
TS	■ TC, SuperCut
W	■ WaveCut (serrated)

Nabelschnurscheren
Umbilical Scissors



MOD. USA
10,5 cm // 4"
C266-10



BUSCH
16 cm // 6 1/4"
C267-16



SCHUMACHER
16 cm // 6 1/4"
C268-16

Darmscheren
Enterotomy Scissors



21 cm // 8 1/4"
C270-21



21 cm // 8 1/4"
C271-21



21 cm // 8 1/4"
C272-21

Lungenlappenscheren, Endarterektomiescheren Lobectomy Scissors, Endarterectomy Scissors

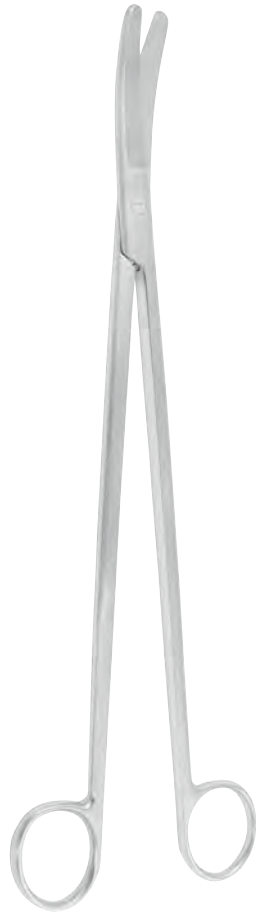

CRAFOORD
30 cm // 12"
C279-30

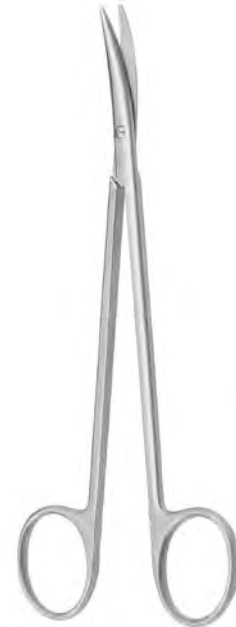

17 cm // 6 3/4"
C294-17S

Gefäßscheren Vascular Scissors



DEBAKEY
15,5 cm // 6"
C296-01



DEBAKEY
15,5 cm // 6"
C296-02

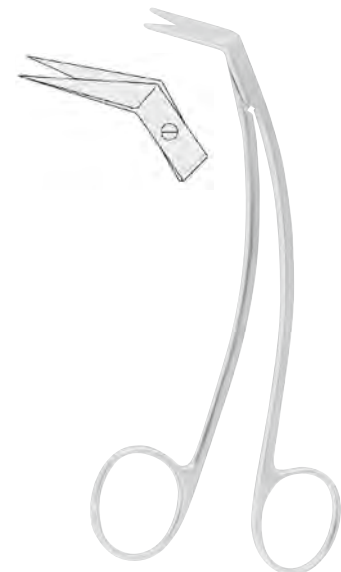

FAVALORO
15 cm // 6"
C297-15

Gefäßscheren
Vascular Scissors

N	■ Titan
S	■ SuperCut
T	■ TC
TW	■ TC, WaveCut (serrated)
TS	■ TC, SuperCut
W	□ WaveCut (serrated)



POTTS-SMITH
19 cm // 7 1/2"

	25°	45°	60°
	C300-19	C301-19	C302-19
	C300-19S	C301-19S	C302-19S
	C300-19T	C301-19T	C302-19T



DEBAKEY

	25°	45°	60°
17 cm // 6 3/4"	C305-16	C306-16	C307-16
23 cm // 9"	C305-23	C306-23	C307-23
28 cm // 11"	C305-28	-	C307-28

Gefäßscheren Vascular Scissors



HEGEMANN / DIETRICH



	25°	45°	60°	90°	125°
13 / 14 cm	C310-13	C311-13	C312-13	C313-13	-
17 / 18 cm	C310-19	C311-19	C312-19	C313-19	C314-19
17 / 18 cm	C310-19S	C311-19S	C312-19S	C313-19S	C314-19S



HEGEMANN / DIETRICH

C315-19
C315-19S

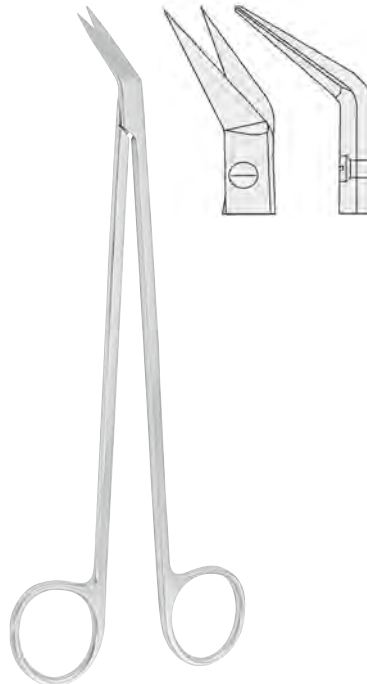

POTTS-SMITH
19,5 cm // 7 1/2"
C318-19



11,5 cm // 4 1/2"
C320-11

Feine Scheren
Fine Scissors

N	■ Titan
S	■ SuperCut
T	■ TC
TW	■ TC, WaveCut (serrated)
TS	■ TC, SuperCut
W	■ WaveCut (serrated)

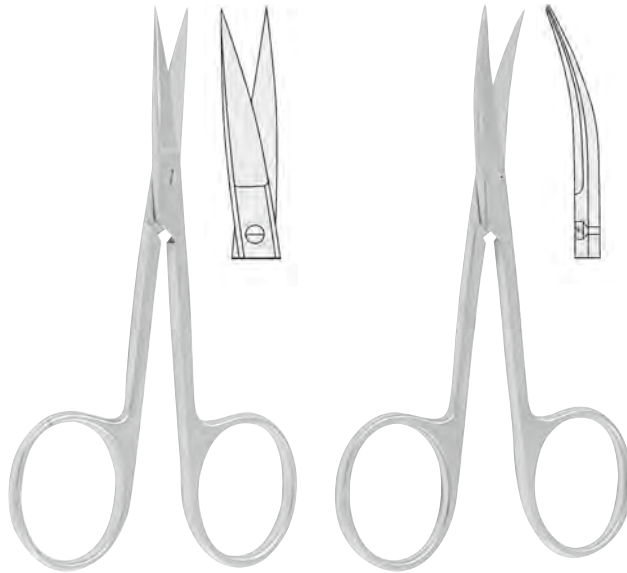

STANDARD

	gerade straight	gebogen curved
9 cm // 3 1/2"	C350-09	C351-09
9 cm // 3 1/2"	C350-09S	C351-09S
10,5 cm // 4 1/4"	C350-10	C351-10
11,5 cm // 4 1/2"	C350-11	C351-11
11,5 cm // 4 1/2"	C350-11S	C351-11S
11,5 cm // 4 1/2"	C350-11T	C351-11T



11,5 cm // 4 1/2"

C353-11



11,5 cm // 4 1/2"

C354-11



STANDARD
rund // round



	gerade straight	gebogen curved
9 cm // 3 1/2"	C360-09	C361-09
10,5 cm // 4 1/4"	C360-10	C361-10
11,5 cm // 4 1/2"	C360-11	C361-11
11,5 cm // 4 1/2"	C360-11T	C361-11T

Feine Scheren Fine Scissors



10 cm // 4"

gerade straight	gebogen curved
C364-10	C365-10



FINO

	gerade straight	gebogen curved
10,5 cm // 4 1/4"	C366-10	C367-10
11,5 cm // 4 1/2"	C366-11	C367-11



11,5 cm // 4 1/2"

gerade straight	gebogen curved
C370-11	C371-11



PLASTIC
12 cm // 4 3/4"



Fig. 1	Fig. 2	Fig. 3
gerade // straight		
C374-01	C374-02	C374-03
-	-	C374-03S
gebogen // curved		
C375-01	C375-02	C375-03
-	-	C375-03S



WAGNER
12 cm // 4 3/4"



Fig. 1	Fig. 2	Fig. 3
gerade // straight		
C384-01	C384-02	C384-03
-	-	C384-03S
-	-	C384-03W
gebogen // curved		
C385-01	C385-02	C385-03
-	-	C385-03S
-	-	C385-03W

Feine Scheren
Fine Scissors

N	■ Titan
S	■ SuperCut
T	■ TC
TW	■ TC, WaveCut (serrated)
TS	■ TC, SuperCut
W	■ WaveCut (serrated)



11,5 cm // 4 1/2"

gerade <i>straight</i>	gebogen <i>curved</i>
C380-11	C381-11
C380-11S	C381-11S
C380-11W	C381-11W

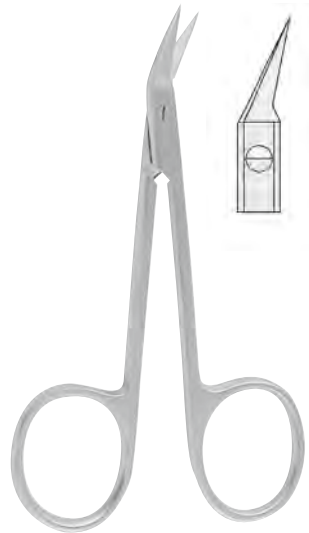

9 cm // 3 1/2"

C390-09



WALTON
10 cm // 4"

C393-10



SANVENERO
14,5 cm // 5 3/4"

gerade <i>straight</i>	gebogen <i>curved</i>
C396-14	C397-14



BABY-LEXER (KNAPP)
10 cm // 4"

gerade <i>straight</i>	gebogen <i>curved</i>
C400-10	C401-10

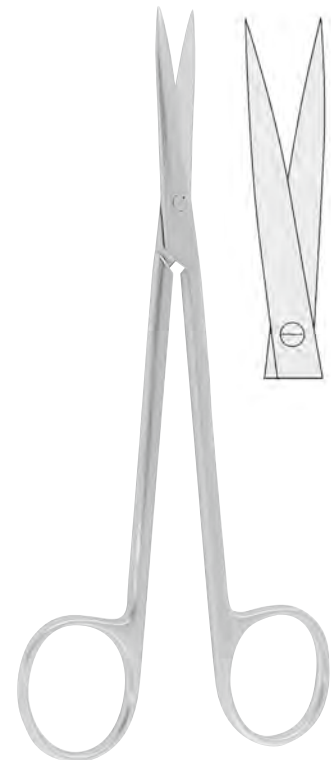

BROPHY (SULLIVAN)
14,5 cm // 5 3/4"

gerade <i>straight</i>	gebogen <i>curved</i>
C408-14	C409-14

Feine Scheren Fine Scissors



JOSEPH
14,5 cm // 5 3/4"

gerade straight	gebogen curved
C410-14	C411-14
C410-14S	C411-14S
C410-14TW	-



KELLY

	gerade straight	gebogen curved
16 cm // 6 1/4"	C412-16	C413-16
16 cm // 6 1/4"	C412-16S	C413-16S
16 cm // 6 1/4"	C412-16T	C413-16T
16 cm // 6 1/4"	C412-16W	C413-16W
18 cm // 7"	C412-18	C413-18

Nerv-Präparierschere Nerve dissecting Scissors



15 cm // 6"
C419-15



REYNOLDS

	gerade straight	gebogen curved
13 cm // 5"	-	C421-13S
15 cm // 6"	C420-15	C421-15
15 cm // 6"	C420-15S	C421-15S
18 cm // 7"	C420-18	C421-18
18 cm // 7"	-	C421-18S

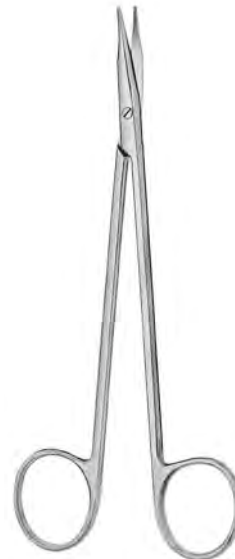

JAMESON

15 cm // 6"	C423-15
15 cm // 6"	C423-15S
18 cm // 7"	C423-18S
20 cm // 8"	C423-20
23 cm // 9"	C423-23



JAMESON-WERBER
13 cm // 5"
C425-13

Feine Scheren
Fine Scissors

N	■	Titan
S	■	SuperCut
T	■	TC
TW	■	TC, WaveCut (serrated)
TS	■	TC, SuperCut
W	□	WaveCut (serrated)



KNAPP
10,5 cm // 4"

gerade
straight



C430-01

gerade
straight



C430-02

gerade
straight



C430-03

gebogen
curved

C431-01

gebogen
curved

C431-02

gebogen
curved

C431-03



MOD. BONN
8 cm // 3"

gerade
straight

C440-08

gebogen
curved

C441-08



11,5 cm // 4 1/2"

gerade
straight

C450-11

C450-11T

gebogen
curved

C451-11

C451-11T



LAGRANGE
11,5 cm // 4 1/2"

C455-11

C455-11S

C455-11W

Feine Scheren Fine Scissors

Sehnenscheren Tenotomy Scissors



STEVENS

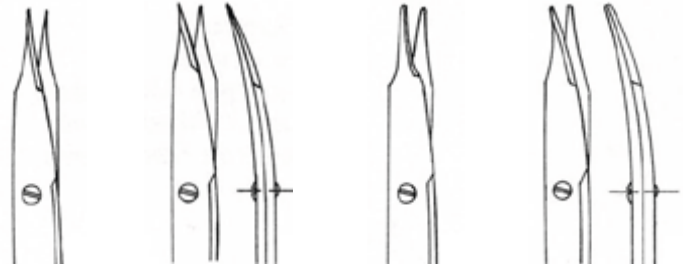

	spitz sharp	spitz sharp	stumpf blunt	stumpf blunt
10,5 cm // 4 1/4"	C460-10	C461-10	C462-10	C463-10
10,5 cm // 4 1/4"	-	-	C462-10S	C463-10S
11,5 cm // 4 1/2"	C460-11	C461-11	C462-11	C463-11
11,5 cm // 4 1/2"	-	-	C462-11N	C463-11N
11,5 cm // 4 1/2"	-	-	C462-11S	C463-11S

Enukleationsscheren Enucleation Scissors



LANDOLT
12 cm // 4 3/4"

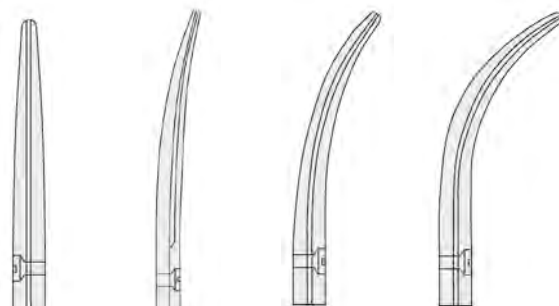

Fig. 1	Fig. 2	Fig. 3	Fig. 4
C466-01	C466-02	C466-03	C466-04

Feine Scheren
Fine Scissors

N	■ Titan
S	■ SuperCut
T	■ TC
TW	■ TC, WaveCut (serrated)
TS	■ TC, SuperCut
W	□ WaveCut (serrated)



WILMER
10 cm // 4"
C465-10

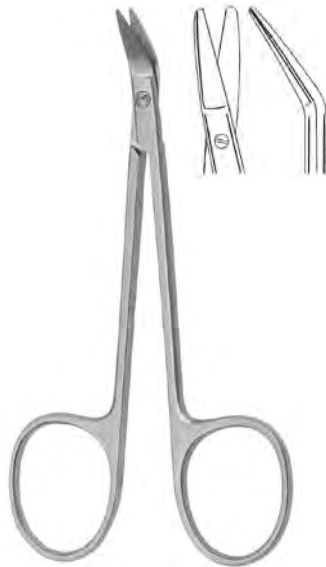

GRAEFE
10,5 cm // 4"
C467-10



	gerade straight	gebogen curved
11 cm // 4 1/4"	C468-11	C469-11
13 cm // 5"	C468-13	C469-13

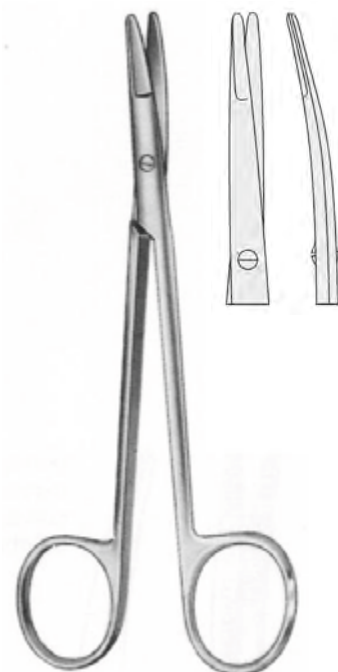

RAGNELL (KILNER)

12 cm // 4 3/4"	C501-12
12 cm // 4 3/4"	C501-12S
12 cm // 4 3/4"	C501-12T
13 cm // 5"	C501-13
15 cm // 6"	C501-15

Feine Scheren Ribbon type Fine Scissors Ribbon type









											
						9,5 cm // 3 3/4"	gerade straight	gebogen curved	10,5 cm // 4"	gerade straight	gebogen curved
						spitz sharp	C470-02	C470-03	spitz sharp	C470-06	C470-07
	C470-02S	C470-03S		C470-06S	C470-07S						
stumpf blunt	C470-04	C470-05	stumpf blunt	C470-08	C470-09						

Strabismusscheren Strabismus Scissors



STEVENS
9 cm // 3 1/2"

WALTON

						
gerade straight	gebogen curved	stark gebogen strong curved	gerade straight	gebogen curved	gerade straight	gebogen curved
C470-22	C470-23	C470-25	C470-32	C470-33	C470-42	C470-43
			C470-32S	C470-33S	C470-42S	C470-43S

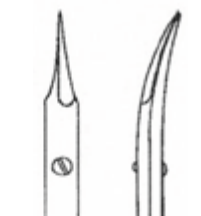

STITCH SCISSORS

9 cm // 3 1/2"	C470-47
11 cm // 4 1/4"	C470-49



RAGNELL
C470-61



KAYE

gerade straight	gebogen curved
C470-72	C470-73
C470-72S	C470-73S

N	■ Titan
S	■ SuperCut
T	■ TC
TW	■ TC, WaveCut (serrated)
TS	■ TC, SuperCut
W	□ WaveCut (serrated)

Scheren für plastische Chirurgie
Scissors for plastic surgery



PAR

	gerade straight	gebogen curved
11 cm // 4 1/4"	C504-11S	C505-11S
14,5 cm // 5 3/4"	-	C505-14S



FREEMAN-KAYE

18 cm // 7"

	gerade straight	gebogen curved
	C510-18S	C511-18S



FREEMAN-KAYE

19 cm // 7 1/2"

	gerade straight	gebogen curved
	C512-19S	C513-19S



KAYE

15 cm // 6"	C515-15
15 cm // 6"	C515-15S
19 cm // 7 1/2"	C515-19
19 cm // 7 1/2"	C515-19S

Scheren für plastische Chirurgie
Scissors for plastic surgery



CASTANARES
16 cm // 6 1/4"
C516-16S



FREEMAN
18 cm // 7"
C517-18S



GORNEY
19 cm // 7 1/2"

gerade
straight

C518-19S

gebogen
curved

C519-19S



GORNEY
23 cm // 9"

gerade
straight

C520-23S

gebogen
curved

C521-23S

Feine Scheren
Fine Scissors

N	■ Titan
S	■ SuperCut
T	■ TC
TW	■ TC, WaveCut (serrated)
TS	■ TC, SuperCut
W	■ WaveCut (serrated)



POTTS-DE-MARTEL
21 cm // 8 1/4"
C530-21



MILLS
21 cm // 8 1/4"
C531-21



SCHMIEDEN-TAYLOR
14,5 cm // 5 3/4" | **C532-14**
16,5 cm // 6 3/4" | **C532-17**

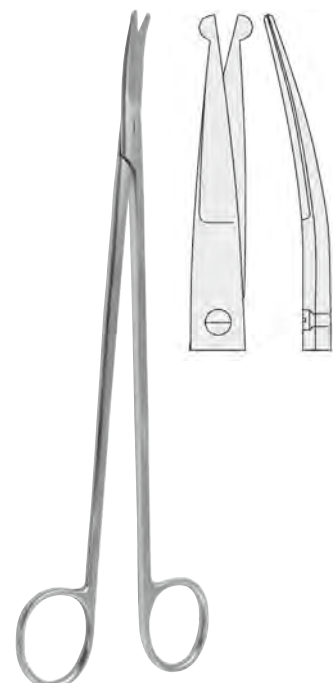

STRULLY
22 cm // 8 3/4"
C534-02



DANDY
17 cm // 6 3/4"
C536-17

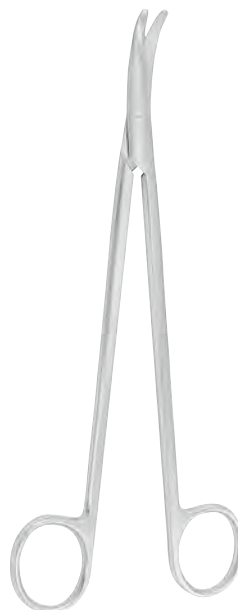

HALLE
19 cm // 7 1/2"
C549-19



BÖTTCHER
18 cm // 7"
C551-18

Tonsillenscheren, Nasenscheren Tonsil Scissors, Nasal Scissors

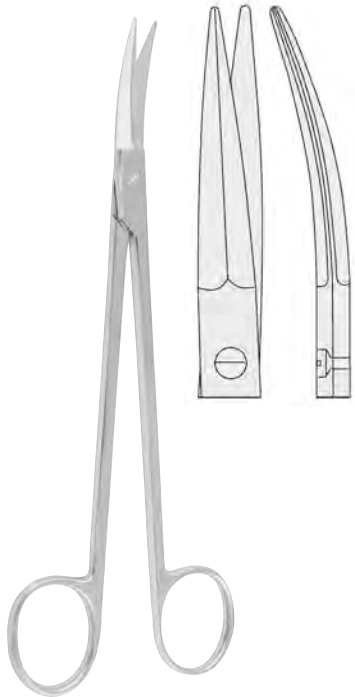

PRINCE
17,5 cm // 7"
C552-17

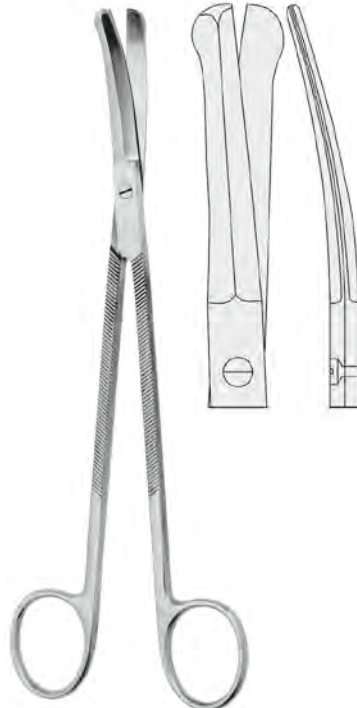

GOOD
19 cm // 7 1/2"
C553-19



HEYMANN
18 cm // 7"
C555-18
C555-18S



COTTLE-MASING
10,5 cm // 4"

spitz
sharp

stumpf
blunt

C559-01

C559-02



FOMON(SABER-BACK)
13 cm // 5"

C560-13
C560-13S



FOMON
13 cm // 5"

C565-13
C565-13S

C565-13T



FOMON
13 cm // 5"

C566-13
C566-13S

Nasenscheren
Nasal Scissors



FOMON
13 cm // 5"
C567-13
C567-13S



COTTLE
16 cm // 6 1/4"
C570-16
C570-16S
C570-16T



QUINBY
12 cm // 4 3/4"

gerade straight	gebogen curved
C576-12	C577-12

Zahnfleischscheren
Gum Scissors



BEEBEE

	gerade straight	gebogen curved
10,5 cm // 4 1/4"	C580-10	C581-10
12 cm // 4 3/4"	C580-12	C581-12

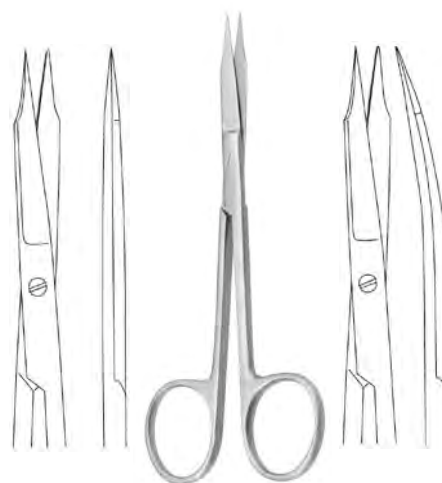

GOLDMAN-FOX
13 cm // 5"

gerade straight	gebogen curved
-	C583-13S
C582-13TW	C583-13TW
C582-13W	C583-13W



GOLDMANN-FOX-S
13 cm // 5"

C585-13S
C585-13W

Zahnfleischscheren Gum Scissors

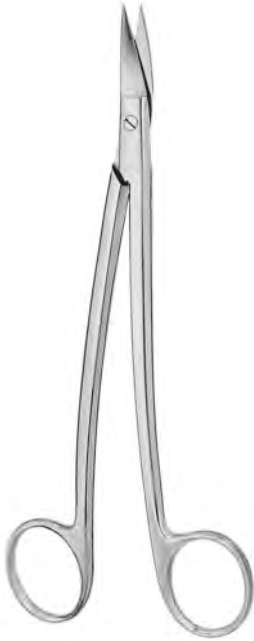

DEAN
17 cm // 6 ¾"
C587-17T
C587-17W



LOCKLIN
16,5 cm // 6 ½"
C588-16W

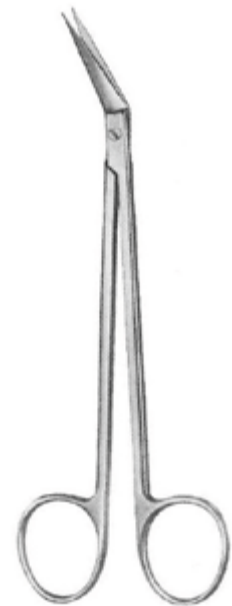

LOCKLIN
16,5 cm // 6 ½"
C589-16

Ligaturscheren Ligature Scissors



SPENCER / LITTAUER

9 cm // 3 ½"	C610-09
10,5 cm // 4 ¼"	C610-10
12 cm // 4 ¾"	C610-12
14 cm // 5 ½"	C610-14



SPENCER-FINO

11 cm // 4 ½"	C611-11
16 cm // 6 ¼"	C611-14



SHORTBENT / NORTHBENT

9 cm // 3 ½"	C613-09
12,5 cm // 5"	C613-12

N	■ Titan
S	■ SuperCut
T	■ TC
TW	■ TC, WaveCut (serrated)
TS	■ TC, SuperCut
W	■ WaveCut (serrated)

Ligaturscheren
Ligature Scissors



11,5 cm // 4 1/2"

C614-11



LITTLER

11,5 cm // 4 1/2"

C617-11



EISELSBERG

11 cm // 4 1/2"

C621-11

Drahtscheren
Wire cutting Scissors

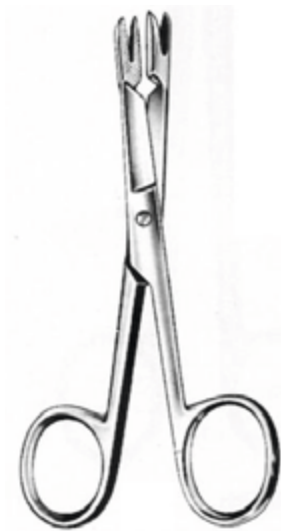

SCHOEMAKER-LOTH

12,5 cm // 5"

C623-12



UNIVERSAL

12 cm // 4 3/4"

C630-12

C630-12T

Nagelspaltscheren, Nagelscheren Nail Splitting Scissors, Nail Scissors



Nagelspaltschere
Nail splitting Scissors

13 cm // 5"	C632-13
15 cm // 6"	C632-15



SMITH
17,5 cm // 7"
C633-17

Nagelscheren Nail Scissors



	gerade <i>straight</i>	gebogen <i>curved</i>	gerade <i>straight</i>	gebogen <i>curved</i>
9 cm // 3 1/2"	C634-09	C635-09	C636-09	C637-09
10,5 cm // 4 1/4"	C634-10	C635-10	C636-10	C637-10

Verbandscheren
Bandage Scissors

N	■ Titan
S	■ SuperCut
T	■ TC
TW	■ TC, WaveCut (serrated)
TS	■ TC, SuperCut
W	■ WaveCut (serrated)



14,5 cm // 5 3/4"
C640-14



18 cm // 7"
C640-18



LISTER

9 cm // 3 1/2"	C650-09
11 cm // 4 1/2"	C650-11
14 cm // 5 1/2"	C650-14
14 cm // 5 1/2"	C650-14S
15,5 cm // 6"	C650-15
18 cm // 7"	C650-18
18 cm // 7"	C650-18S
18 cm // 7"	C650-18T
18 cm // 7"	C650-18TS
20 cm // 8"	C650-20
20 cm // 8"	C650-20S



LISTER
21 cm // 8 1/4"
C652-21

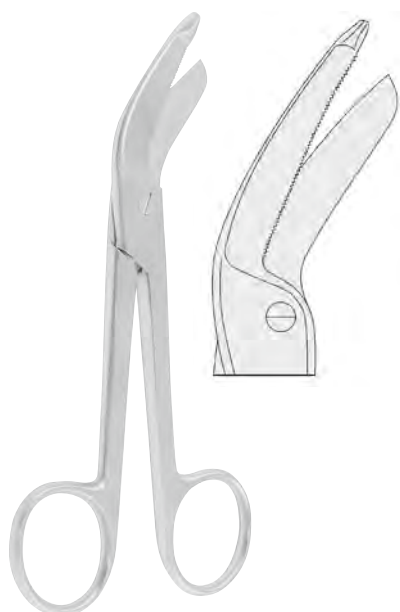

LISTER-EXCENTRIC

16 cm // 6 1/4"	C655-16
19 cm // 7 1/2"	C655-19



KNOWLES
14 cm // 5 1/2"
C664-14



KNOWLES
14 cm // 5 1/2"
C665-14

Verbandscheren, Kleiderscheren
Bandage Scissors, Clothing Scissors

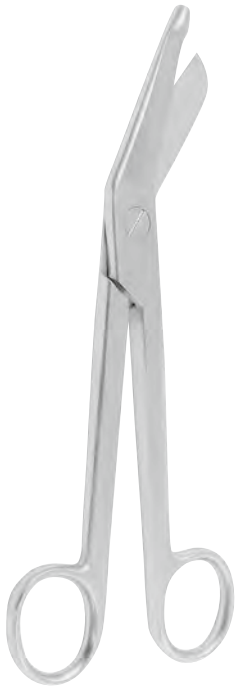

ESMARCH

20 cm // 8"

C668-20

22 cm // 8 3/4"

C668-22



BERGMANN

23 cm // 9"

C670-23



LORENZ

23 cm // 9"

C671-23

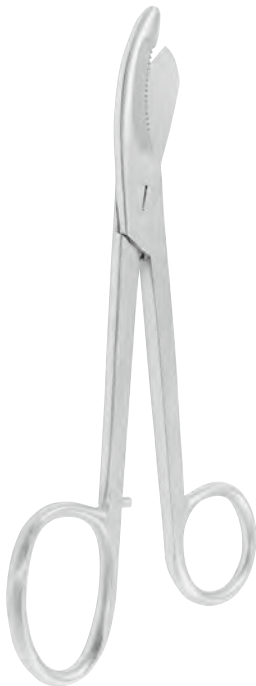

BRUNS

24 cm // 9 1/2"

C675-24

C675-24T

C675-24W



SMITH (USA)

18 cm // 7"

C678-18



20 cm // 8"

C680-20

Verbandscheren, Knochenscheren, Gippscheren
Bandage Scissors, Bone Scissors, Plaster-of-Paris Scissors



SEUTIN
23 cm // 9"
C681-23



23 cm // 9"
C682-23



COLLIN
22 cm // 8 3/4"
C684-22



GLUCK
22 cm // 8 3/4"
C685-22



STILLE
24 cm // 9 1/2"
C688-24



STILLE
23 cm // 9" | **C689-23**
26 cm // 10 1/4" | **C689-26**
37 cm // 14 1/2" | **C689-37**

Mikroscheren Micro Scissors



VANNAS
8 cm // 3 1/4"

VANNAS			
gerade <i>straight</i>	gebogen <i>curved</i>	kniegebogen <i>angular</i>	aufgewinkelt <i>angled up</i>
C700-01	C700-02	C700-03	C700-04
VANNAS-TÜBINGEN			
gerade <i>straight</i>	gebogen <i>curved</i>	kniegebogen <i>angular</i>	aufgewinkelt <i>angled up</i>
C701-01	C701-02	C701-03	C701-04



VANNAS-TÜBINGEN
8,5 cm // 3 1/2"



9 cm // 3 3/4"

C705-01	C705-21
C705-03	C705-22
C705-13	



10 cm // 4"

gerade <i>straight</i>	gebogen <i>curved</i>
C715-01	C715-02

Mikroscheren
Micro Scissors



gerade straight	gebogen curved
C720-01	C720-02

WESTCOTT
10 cm // 4"



spitz sharp	stumpf blunt
C727-01	C727-02

CASTROVIEJO
10 cm // 4"



KATZIN
10 cm // 4"
links
left
C734-01



KATZIN
10 cm // 4"
rechts
right
C734-03



CASTROVIEJO
10 cm // 4"



links
left
C736-01



rechts
right
C736-02

Mikroscheren
Micro Scissors



WESTCOTT
11 cm // 4 1/2"

spitz <i>sharp</i>	stumpf <i>blunt</i>
C740-01	C740-02



WESTCOTT
11 cm // 4 1/2"
links
left
C740-11



NOYES
12 cm // 4 3/4"



C750-01

C750-02

C750-03



C751-01

C751-02

C751-03

Mikroscheren mit feinsten Schneiden
Micro Scissors with finest blades

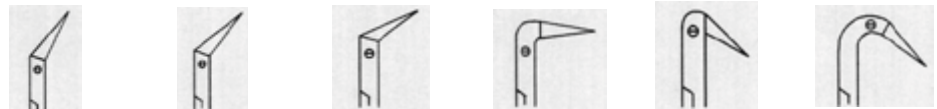

		25°	45°	60°	90°	125° V 125° V	125° Rund 125° Round
Schneidelänge <i>blades</i>							
Micro = 10 mm	11 cm // 4 1/2"	C799-11/25	C799-11/45	C799-11/60	C799-11/90	C799-11/99	C799-11/99R
Nano = 7 mm	16 cm // 6 1/4"	C798-16/25	C798-16/45	C798-16/60	C798-16/90	C798-16/99	-
Micro = 10 mm	16 cm // 6 1/4"	C799-16/25	C799-16/25	C799-16/60	C799-16/90	C799-16/99	-

Mikroscheren Micro Scissors



Mikroscheren flach
Micro Scissors flat

Schneidelänge 15 mm
Length of blades 15 mm



	25°	45°	60°	90°	125°
14 cm // 5 1/2"	C800-15/25	C800-15/45	C800-15/60	C800-15/90	C800-15/99
18 cm // 7"	C800-18/25	C800-18/45	C800-18/60	C800-18/90	C800-18/99
18 cm // 7"	C800-18/25N	C800-18/45N	C800-18/60N	C800-18/90N	C800-18/99N
23 cm // 9"	C800-23/25	C800-23/45	C800-23/60	C800-23/90	C800-23/99

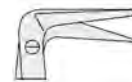

	25°	45°	60°	90°	125°
17 cm // 6 3/4"	C801-18/25	C801-18/45	C801-18/60	C801-18/90	C801-18/99



A= Vannas Type

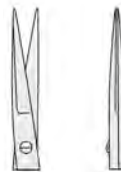

	gerade straight	gebogen curved	gewinkelt angled
15 cm // 6"	C806-15	C807-15	-
15 cm // 6"	C806-15A	C807-15A	-
15 cm // 6"	C806-16N	C807-16N	-
15 cm // 6"	C806-16W	C807-16W	-
18 cm // 7"	C806-18	C807-18	C808-18
18 cm // 7"	C806-18A	C807-18A	-
18 cm // 7"	C806-18N	C807-18N	-
20 cm // 8"	C806-20	C807-20	-
20 cm // 8"	C806-20A	C807-20A	-
20 cm // 8"	C806-21N	C807-21N	-
23 cm // 9"	C806-23	C807-23	-
23 cm // 9"	C806-23A	C807-23A	-

Mikroscheren
Micro Scissors

Mikroscheren flach
Micro Scissors flat



A= Vannas Type

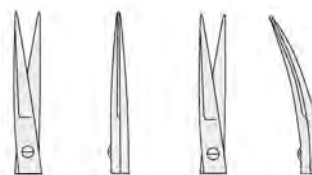

	Schneidelänge cutting edge	gerade straight	gebogen curved
11 cm // 4 3/4"	19 mm	C810-11	C811-11
15 cm // 6"	15 mm	C810-15A	C811-15A
15 cm // 6"	19 mm	C810-15W	C811-15W
15 cm // 6"	19 mm	C810-15	C811-15
18 cm // 7"	20 mm	C810-18A	C811-18A
18 cm // 7"	20 mm	C810-18W	C811-18W



15 cm // 6"	C812-15
18 cm // 7"	C812-18

Mikroscheren flach
Micro Scissors flat

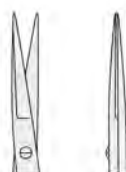

	gerade straight	gebogen curved	gewinkelt angled	gewinkelt angled
16 cm // 6 1/4"	C814-16	C815-16	-	-
16 cm // 6 1/4"	C814-16A	C815-16A	-	-
18,5 cm // 7 1/4"	C814-18	C815-18	C815-28	C815-38
18,5 cm // 7 1/4"	C814-18A	C815-18A	-	-

Mikroscheren Micro Scissors





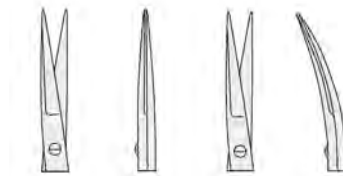





Mikroscheren flach
Micro Scissors flat



	gerade straight	gebogen curved
21 cm // 8 1/4"	C816-22	C817-22

Mikroscheren flach, gedrehter Schluss
Micro Scissors flat, streamlined

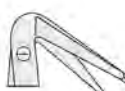

				
25°	45°	60°	90°	125°
C820-18/25	C820-18/45	C820-18/60	C820-18/90	C820-18/99
C820-18/25N	C820-18/45N	C820-18/60N	C820-18/90N	C820-18/99N
				
25°	45°	60°	90°	125°
C821-18/25	C821-18/45	C821-18/60	C821-18/90	C821-18/99
C821-18/25N	C821-18/45N	C821-18/60N	C821-18/90N	C821-18/99N

Mikroscheren
Micro Scissors



Mikroscheren flach, gedrehter Schluss
Micro Scissors flat, streamlined handle

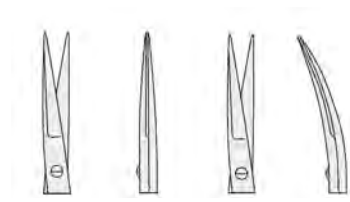

	gerade straight	gebogen curved
15 cm // 6"	C824-15	C825-15
15 cm // 6"	C824-15N	C825-15N
18 cm // 7"	C824-18	C825-18
18 cm // 7"	C824-18N	C825-18N
21 cm // 8 1/4"	C824-21	C825-21
21 cm // 8 1/4"	C824-21N	C825-21N
23 cm // 9"	C824-23	C825-23



A= Vannas Type



Mikroscheren flach
Micro Scissors flat

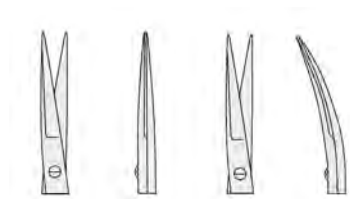

	gerade straight	gebogen curved
12 cm // 4 3/4"	C830-12	C831-12
12 cm // 4 3/4"	C830-12A	C831-12A
16 cm // 6 1/4"	C830-16	C831-16
16 cm // 6 1/4"	C830-16A	C831-16A
16 cm // 6 1/4"	C830-16W	C831-16W
18 cm // 7"	C830-18	C831-18

Mikroscheren Micro Scissors

Mikroscheren flach Micro Scissors flat



	gerade straight	gebogen curved	gerade straight	gebogen curved	abwärts gebogen curved down
16 cm // 6 1/4"	C834-16	C835-16	C836-16	-	-
16 cm // 6 1/4"	C834-16N	C835-16N	C836-16N	-	-
18 cm // 7"	-	-	C836-18	-	-
18 cm // 7"	-	-	C836-18N	-	-
20 cm // 8"	C834-20	C835-20	C836-20	C837-20	C839-20
20 cm // 8"	C834-20N	C835-20N	C836-20N	C837-20N	-
22,5 cm // 9"	C834-22	C835-22	C836-22	C837-22	C839-22
22,5 cm // 9"	C834-22A	C835-22A	-	-	-
22,5 cm // 9"	C834-22AN	C835-22AN	-	-	-
22,5 cm // 9"	C834-22N	C835-22N	C836-22N	C837-22N	-
22,5 cm // 9"	C834-22NW	-	-	-	-
22,5 cm // 9"	C834-22W	-	-	-	-
24 cm // 9 1/2"	C834-24	C834-24	-	-	-



45°

20 cm // 8"

C839-51



45°

20 cm // 8"

C839-52



125°

19 cm // 7 1/2"

C839-53

Mikroscheren
Micro Scissors

Mikroscheren flach, gedrehter Schluss
Micro Scissors flat, streamlined handle



	gerade straight	gebogen curved	gerade straight	gebogen curved
20 cm // 8"	C840-20	C841-20	C844-20	C845-20
20 cm // 8"	C840-20A	C841-20A	-	-
20 cm // 8"	C840-20N	C841-20N	C844-20N	C845-20N
20 cm // 8"	C840-20AN	C841-20AN	-	-
20 cm // 8"	C840-20NW	C841-20NW	-	-
20 cm // 8"	C840-20W	C841-20W	-	-
22 cm // 8 1/2"	C840-22	C841-22	C844-22	C845-22
22 cm // 8 1/2"	C840-22A	C841-22A	-	-
22 cm // 8 1/2"	C840-22N	C841-22N	C840-22N	C845-22N
22 cm // 8 1/2"	C840-22AN	C841-22AN	-	-
22 cm // 8 1/2"	C840-22NW	C841-22NW	-	-
22 cm // 8 1/2"	C840-22W	C841-22W	-	-

Präparierscheren
Dissecting Scissors

Mikroscheren rund
Micro Scissors round

Schneidelänge 14 mm
Length of blades 14 mm



	25°	45°	60°	90°	125°
14 cm // 5 1/2"	C850-14/25	C850-14/45	C850-14/60	C850-14/90	C850-14/99
17 cm // 6 3/4"	C850-17/25	C850-17/45	C850-17/60	C850-17/90	C850-17/99
20,5 cm // 8"	C850-21/25	C850-21/45	C850-21/60	C850-21/90	C850-21/99
22,5 cm // 8 3/4"	C850-23/25	C850-23/45	C850-23/60	C850-23/90	C850-23/99



	25°	45°	60°	90°	125°
18 cm // 7"	C852-18/25	C852-18/45	C852-18/60	C852-18/90	C852-18/99

Mikroscheren mit feinsten Schneiden Micro Scissors with finest blades

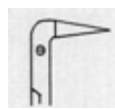

						125° V 125° V	125° Rund 125° Round
Schneidelänge blades		25°	45°	60°	90°	125°	125°
Micro = 10 mm	11 cm // 4 1/2"	C849-11/25	C849-11/45	C849-11/60	C849-11/90	C849-11/99	C849-11/99R
Fine = 15 mm	11,5 cm // 4 1/2"	C850-11/25	C850-11/45	C850-11/60	C850-11/90	-	C850-11/99R
Nano = 7 mm	17 cm // 6 3/4"	C848-17/25	C848-17/45	C848-17/60	C848-17/90	C848-17/99	-
Micro = 10 mm	17 cm // 6 3/4"	C849-17/25	C849-17/45	C849-17/60	C849-17/90	C849-17/99	C849-17/99R
Micro = 10 mm	20 cm // 8"	-	-	-	-	C849-20/99	-

Mikroscheren
Micro Scissors



A= Vannas Type

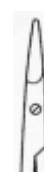

B= stumpf // blunt



Mikroscheren rund
Micro Scissors round

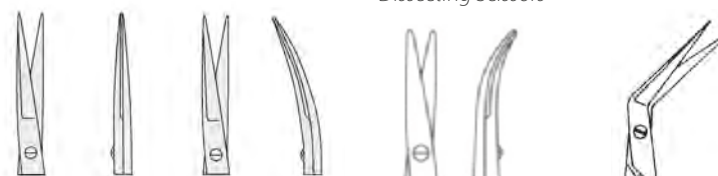

Präparierscheren
Dissecting Scissors

	gerade straight	gebogen curved	gerade straight	gewinkelt angled
11 cm // 4 3/4"	C860-11	C861-11	-	-
11 cm // 4 3/4"	C860-11A	C861-11A	-	-
14 cm // 5 1/2"	C860-14	C861-14	C863-14	-
14 cm // 5 1/2"	C860-14B	C861-14B	-	-
14 cm // 5 1/2"	-	C861-14N	C863-14N	-
14 cm // 5 1/2"	C860-14W	C861-14W	-	-
14 cm // 5 1/2"	C860-15N	C861-16N	-	-
14 cm // 5 1/2"	C860-15NW	-	-	-
18 cm // 7"	C860-18	C861-18	C863-18	C865-18
18 cm // 7"	C860-18B	C861-18B	-	-
18 cm // 7"	C860-18N	C861-18N	C863-18N	-
18 cm // 7"	C860-18W	C861-18W	-	-
21 cm // 8 1/4"	C860-21	C861-21	-	-
21 cm // 8 1/4"	C860-21N	C861-21N	-	-
23 cm // 9"	C860-23	C861-23	-	-
23 cm // 9"	C860-23N	C861-23N	-	-

Mikroscheren Micro Scissors



Mikroscheren rund, gedrehter Schluss
Micro Scissors round, streamlined handle



	gerade straight	gebogen curved
15 cm // 6"	C886-15	C887-15
15 cm // 6"	C886-15N	C887-15N
18 cm // 7"	C886-18	C887-18
18 cm // 7"	C886-18N	C887-18N
21 cm // 8 ¼"	C886-21	C887-21
21 cm // 8 ¼"	C886-21N	C887-21N
23 cm // 9"	C886-23	C887-23



Mikroscheren, rund, bayonettförmig
Micro Scissors, round, Bayonet-Style

	gerade straight	gebogen curved
21 cm // 8 ¼"	C870-21	C871-21
23 cm // 9"	C870-23	C871-23

Wundhaken

// Retractors

Inhalt

Index

Abschnitt **D**
// Section

Feine Wund-, und Hauthäkchen <i>Fine Wound-, and Skin hooks</i>	D02 - D04
Feine Wundhaken <i>Fine Retractors</i>	D05 - D10
Wundhaken <i>Retractors</i>	D11 - D29
Spatel <i>Spatulas</i>	D29 - D31

Feine Wund-, und Hauthaken
Fine Wound-, and Skin hooks



16 cm // 6 1/4"



GRAEFE

scharf
sharp

D100-01



GRAEFE

stumpf
blunt

D100-02



Fig. 1

D110-01



Fig. 2

D110-02



Fig. 3

D110-03



Fig. 4

D110-04



GUTHRIE

scharf
sharp

D108-01



GUTHRIE

stumpf
blunt

D108-02



O'CONNER

D110-26



LAHEY

13 cm // 5"

D102-13



FRAZIER



scharf
sharp

D104-131

stumpf
blunt

D104-132

13 cm // 5"

D104-181

D104-182



COTTLE

16 cm // 6 1/4"

D106-16



GUTHRIE

13 cm // 5"



Fig. 1

D107-01



Fig. 2

D107-02

Feine Wund-, und Hauthäkchen Fine Wound-, and Skin hooks



MILLER
13,5 cm // 5 1/4"



scharf
sharp

D111-01



stumpf
blunt

D111-02



13 cm // 5"
D112-13



14,5 cm // 5 1/2"



Fig. 1
D114-01



Fig. 2
D114-02



Fig. 3
D114-03



KNAPP
13,5 cm // 5 1/4"
D116-13



BARSKY
15 cm // 6"
D118-15



KLEINERT-KUTZ



13 cm // 5"
3 mm
D120-01



13 cm // 5"
5 mm
D120-02



13 cm // 5"
7 mm
D120-03

15 cm // 6 1/4"
2,5 mm
D120-11

15 cm // 6 1/4"
4,2 mm
D120-12

15 cm // 6 1/4"
4,8 mm
D120-13



13 cm // 5"
D124-13

Feine Wund-, und Hauthäkchen
Fine Wound-, and Skin hooks



JACKSON
13 cm // 5"
D126-13



ITERSON
16 cm // 6 1/4"



scharf
sharp

D130-01

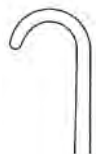

stumpf
blunt

D130-02



KILNER
15 cm // 6"
D138-15



GILLIES
18 cm // 7"



Fig. 1

D140-01

D140-01N



Fig. 2

D140-02

D140-02N



BERGMANN
14 cm // 5 1/2"
D142-14



CRILE
20 cm // 8"
D144-20



scharf
sharp

D147-02

scharf
sharp

D147-03

scharf
sharp

D147-04



stumpf
blunt

D147-12



stumpf
blunt

D147-13



stumpf
blunt

D147-14



scharf
sharp

D148-01



stumpf
blunt

D148-02

Feine Wundhaken Fine Retractors



scharf <i>sharp</i>	stumpf <i>blunt</i>
D149-01	D149-11



scharf <i>sharp</i>	stumpf <i>blunt</i>
D152-01	D152-11



scharf <i>sharp</i>	stumpf <i>blunt</i>
D149-02	D149-12



scharf <i>sharp</i>	stumpf <i>blunt</i>
D152-02	D152-12

scharf <i>sharp</i>	stumpf <i>blunt</i>
D149-03	D149-13



scharf <i>sharp</i>	stumpf <i>blunt</i>
D152-03	D152-13

scharf <i>sharp</i>	stumpf <i>blunt</i>
D149-04	D149-14



scharf <i>sharp</i>	stumpf <i>blunt</i>
D152-04	D152-14

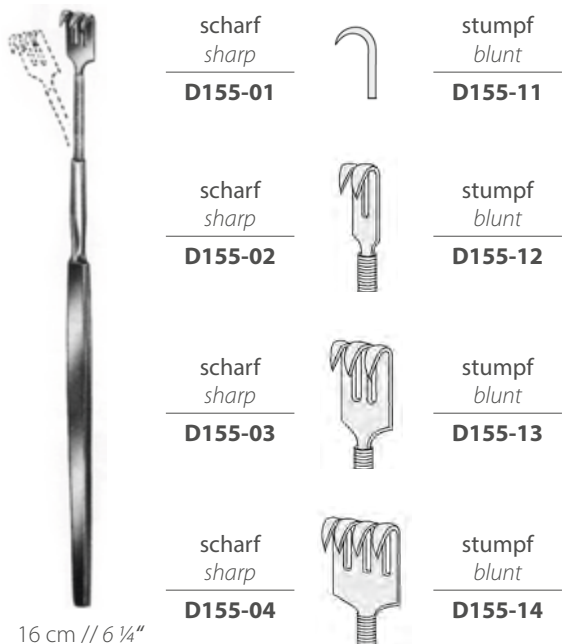
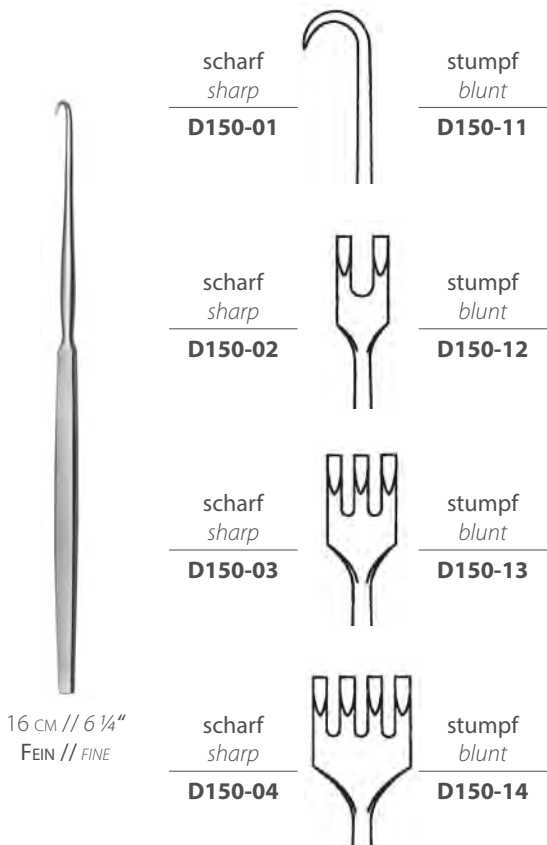

Feine Wundhaken
Fine Retractors



DAVIS
14 cm // 5 1/2"
5x16 mm / 8x21 mm
D174-14



KILNER
16 cm // 6 1/4"
D175-16



RAGNELL-DAVIS
15 cm // 6"
D178-14
D178-14N



SENN-MILLER
16 cm // 6 1/4"



scharf
sharp

D180-01
D180-01N



stumpf
blunt

D180-02
D180-02N



BABY-SENN-MILLER
16 cm // 6 1/4"



scharf
sharp

D181-01



stumpf
blunt

D181-02



MATHIEU
16 cm // 6 1/4"



scharf
sharp

D183-01



stumpf
blunt

D183-02

Feine Wundhaken Fine Retractors



LANGENBECK-GREEN
16 cm // 6 1/4"



D185-01



D185-02



D185-04



D185-11



16 x 6 mm

D185-16

25 x 6 mm

D185-25



JACKSON
17 cm // 6 3/4"
D190-17



LUKENS
17 cm // 6 3/4"
D191-17



D195-01



D195-04



8 x 12,5 mm

D195-06

10 x 21,5 mm

D195-08



15 x 6 mm

D195-43

20 x 6 mm

D195-44

25 x 6 mm

D195-45

30 x 8 mm

D195-46



MANNERFELDT
15,5 cm // 6"

scharf
sharp

D195-21



stumpf
blunt

D195-26

scharf
sharp

D195-22



stumpf
blunt

D195-27

scharf
sharp

D195-23



stumpf
blunt

D195-28



12 x 12 mm

D195-48

12 x 14 mm

D195-49

14 x 16 mm

D195-51



D195-58

Feine Wundhaken
Fine Retractors



MEYERDING
18 cm // 7"



18 x 7 mm

D200-01



16 x 5 mm

D200-02



7 x 4 mm

D200-03



10 x 3 mm

D200-04



7 x 4 mm

D200-05



D200-06



SENN-GREEN
15 cm // 6"



10 x 6 mm

D202-01



20 x 6 mm

D202-02



16 cm // 6 1/4"
14 x 9 mm

D204-16



MINI-LANGENBECK
16 cm // 6 1/4"



10 x 6 mm

D206-10

17 x 5 mm

D206-17

20 x 6 mm

D206-20

22 x 8 mm

D206-22



STRANDELL-STILLE
19 cm // 7 1/2"



glatt
smooth

D210-01



gezahnt
toothed

D210-02



CRILE
11 cm // 4 1/2"
D214-11



LUER
11 cm // 4 1/2"
D215-11

Feine Wundhaken
Fine Retractors



ROSE
13 cm // 5"
D216-13



KÖNIG
17 cm // 6 3/4"
13 mm | **D218-13**
16 mm | **D218-16**



DESMARRES
13 cm // 5"

10 mm	D220-10
11 mm	D220-11
12 mm	D220-12
12 mm	D220-12N
13 mm	D220-13
14 mm	D220-14
14 mm	D220-14N
15 mm	D220-15
16 mm	D220-16
16 mm	D220-16N
18 mm	D220-18



DESMARRES
13 cm // 5"

8 mm	D222-08
10 mm	D222-10
12 mm	D222-12
14 mm	D222-14
16 mm	D222-16
18 mm	D222-18



CUSHING

	20 cm // 8"	24 cm // 9 1/4"
8 mm	D230-08	D231-08
10 mm	D230-10	D231-10
12 mm	D230-12	D231-12
14 mm	D230-14	D231-14
16 mm	D230-16	D231-16
18 mm	D230-18	D231-18

Feine Wundhaken
Fine Retractors



23 cm	D233-23
28 cm	D233-28
35 cm	D233-35

CUSHING
11 mm



14 mm	D234-14
18 mm	D234-18
22 mm	D234-22

CUSHING
25 cm // 10"



10 mm	D235-10
15 mm	D235-15
20 mm	D235-20
30 mm	D235-30
40 mm	D235-40
50 mm	D235-50

LOVE (MORSE)
25 cm // 10"



8 mm	D236-08
11 mm	D236-11
13 mm	D236-13
15 mm	D236-15
17 mm	D236-17
20 mm	D236-20
23 mm	D236-23

GIL-VERNET
24 cm // 9 1/2"



CUSHING-KOCHER
17,5 cm // 6 3/4"
D240-17



LITTLE
20 cm // 8"
D241-20



CUSHING

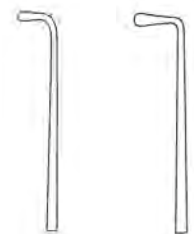

	Fig. 1	Fig. 2
19 cm // 7 1/2"	D245-01	D245-02
28 cm // 11"	D245-11	D245-12

Wundhaken Retractors



CUSHING
20 cm // 8"
D258-20



KLAPP
17,5 cm // 6 3/4"



D255-02



D255-03



D255-04

scharf
sharp
D250-02



stumpf
blunt
D250-12

scharf
sharp
D250-03



stumpf
blunt
D250-13

scharf
sharp
D250-04

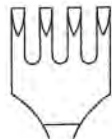

stumpf
blunt
D250-14

scharf
sharp
D250-06

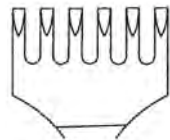

stumpf
blunt
D250-16



VOLKMANN
11,5 cm // 4 1/2"



VOLKMANN
23 cm // 9"



scharf sharp	D260-01	D260-02	D260-03	D260-04	D260-06	D260-08
stumpf blunt	D260-11	D260-12	D260-13	D260-14	D260-16	D260-18
halbscharf semi-sharp	D260-21	D260-22	D260-23	D260-24	D260-26	D260-28

Wundhaken
Retractors



VOLKMANN
23 cm // 9"



scharf <i>sharp</i>	D262-01	D262-02	D262-03	D262-04	D262-06
stumpf <i>blunt</i>	D262-11	D262-12	D262-13	D262-14	D262-16
halbscharf <i>semi-sharp</i>	D262-21	D262-22	D262-23	D262-24	D262-26



VOLKMANN
US-MODELL
22 cm // 8 1/2"



scharf <i>sharp</i>	D263-02	D263-03	D263-04	D263-06
stumpf <i>blunt</i>	D263-12	D263-13	D263-14	D263-16

Wundhaken Retractors



KOCHER
22 cm // 8 1/2"

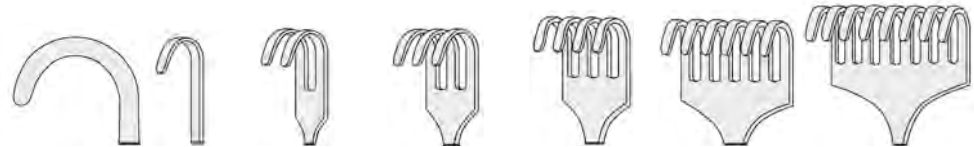

scharf <i>sharp</i>	D264-01	D264-02	D264-03	D264-04	D264-06	D264-08
stumpf <i>blunt</i>	D264-11	D264-12	D264-13	D264-14	D264-16	D264-18
halbscharf <i>semi-sharp</i>	-	D264-22	D264-23	D264-24	D264-26	D264-28



KOCHER
22 cm // 8 1/2"



scharf
sharp

D265-01



stumpf
blunt

D265-02



scharf
sharp

D266-01



stumpf
blunt

D266-02



23 cm // 9"

9,5 mm	D268-01
19 mm	D268-02
25 mm	D268-03

Wundhaken
Retractors



24,5 cm // 9 3/4"

scharf
sharp

D268-24



17 cm // 6 3/4"

D270-17



OLLIER

22,5 cm // 9"

D272-03



D272-04



WASSMUND

20 cm // 8"

D275-20

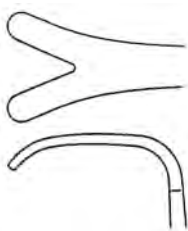

MURPHY

19,5 cm // 7 3/4"

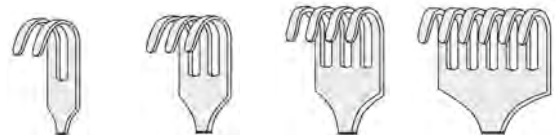

scharf
sharp

D280-02

D280-03

D280-04

D280-06

stumpf
blunt

D280-12

D280-13

D280-14

D280-16

Wundhaken Retractors



scharf
sharp
D282-01

KÖRTE
24 cm // 9 1/2"



stumpf
blunt
D282-02



Griff vertikal
vertical handle

KÖRTE
23 cm // 9"
46 x 55 mm
D284-23



25 cm // 10"
D285-25



KÖRTE-WAGNER
28 cm // 11"
D286-28



ISRAEL
25 cm // 10"



Fig. 1	Fig. 2	Fig. 3	Fig. 4
4 Zähne 4 teeth	5 Zähne 5 teeth	6 Zähne 6 teeth	6 Zähne 6 teeth
40 x 40 mm	45 x 50 mm	50 x 60 mm	70 x 70 mm
D290-01	D290-02	D290-03	D290-04

Wundhaken
Retractors



ROUX

Satz // Set	D300-00
Fig. 1	D300-01
Fig. 2	D300-02
Fig. 3	D300-03



BABY-ROUX
13 cm // 5"
D300-13



MINI-ROUX
14 cm // 5 1/2"
D301-14



ROUX-MAGNUS

14 cm // 5 1/2"	D302-01
15 cm // 6"	D302-02
17 cm // 6 3/4"	D302-03



PARKER
13,5 cm // 5 1/4"
Satz // Set
D308-13



PARKER
18 cm // 7"
Satz // Set
D308-18



FARABEUF
12 cm // 4 3/4"
Satz // Set
D310-12



FARABEUF
15 cm // 6"
Satz // Set
D310-15

Wundhaken Retractors



MATHIEU
19 cm // 7 1/2"
Satz // Set
D316-19

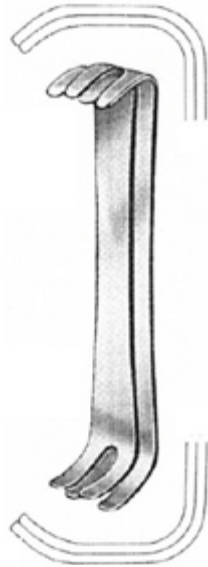

MAYO-COLLIN
15 cm // 6"
Satz // Set
D317-15



GOELET
19 cm // 7 1/2"
D318-19

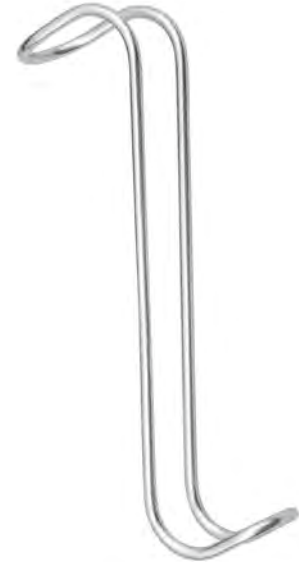

COLLIN-HARTMANN

Satz // Set		D320-00
Fig. 1	14 cm // 5 1/2"	D320-01
Fig. 2	16 cm // 6"	D320-02



PARKER-LANGENBECK
21 cm // 8 1/4"
Satz // Set
D321-21
D321-21N

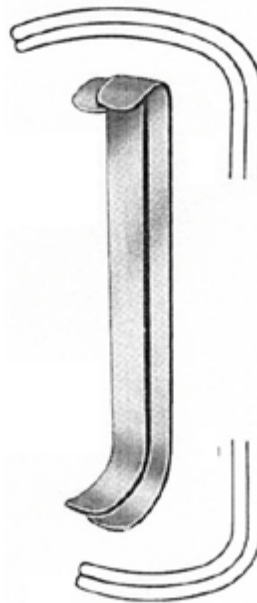

COLLIN
16,5 cm // 6 1/2"
Satz // Set
D322-16



PARKER-MOTT
16 cm // 6 1/4"
D324-16

Wundhaken
Retractors



LAHEY
19 cm // 7 1/2"
D329-19



LANGENBECK
21 cm // 8 1/4"

D330-01	30 x 11 mm	D330-11
D330-02	30 x 14 mm	D330-12
D330-03	33 x 14 mm	D330-13
D330-04	30 x 16 mm	D330-14
D330-05	40 x 11 mm	D330-15
D330-06	42 x 13 mm	D330-16
D330-07	50 x 11 mm	D330-17



LANGENBECK
22 cm // 8 3/4"



Griff vertikal
vertical handle
85x15mm

LANGENBECK
21,5 cm // 8 1/2"
D332-21



LANGENBECK
21 cm // 8 1/4"

55 x 20 mm	D333-01
60 x 20 mm	D333-02
63 x 20 mm	D333-03



LANGENBECK
21 cm // 8 1/4"

35 x 7 mm	D334-01
35 x 10 mm	D334-02
35 x 15 mm	D334-03
60 x 20 mm	D334-04

Wundhaken Retractors



25 x 6 mm	D335-01
25 x 8 mm	D335-02
35 x 8 mm	D335-03
35 x 11 mm	D335-04
35 x 15 mm	D335-05
40 x 11 mm	D335-06
55 x 11 mm	D335-07
70 x 14 mm	D335-08
80 x 12 mm	D335-09
80 x 26 mm	D335-10

KOCHER-LANGENBECK
21,5 cm // 8 1/2"

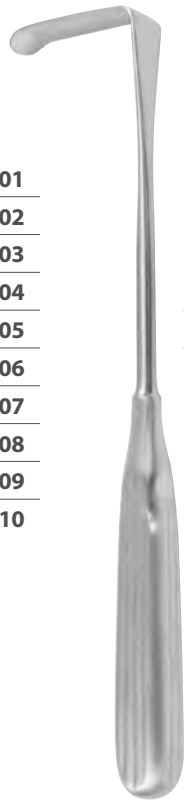

45 x 15 mm	D344-01
55 x 23 mm	D344-02
72 x 20 mm	D344-03

SAUERBRUCH
21,5 cm // 8 1/2"



BRÜNINGS-BRUNK
19 cm // 7 1/2"
D345-19



19 x 12 mm	D348-01
21 x 15 mm	D348-02

KOCHER
19 cm // 7 1/2"



40 x 10 mm	D349-01
40 x 15 mm	D349-02
40 x 20 mm	D349-03

KOCHER
22 cm // 8 1/2"



40 x 18 mm	D350-01
60 x 20 mm	D350-02
60 x 25 mm	D350-03
75 x 30 mm	D350-04
75 x 40 mm	D350-05

KOCHER
23 cm // 9"



22 x 15 mm	D351-01
38 x 20 mm	D351-02
67 x 25 mm	D351-03
100 x 35 mm	D351-04

KOCHER-WAGNER
28 cm // 11"

Wundhaken
Retractors



70 x 40 mm	D355-01
70 x 50 mm	D355-02
70 x 65 mm	D355-03

MORRIS
21 cm // 8 1/4"

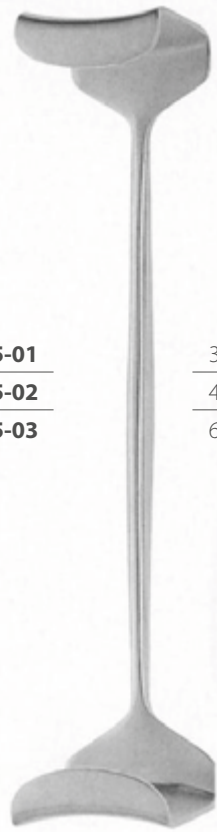

MORRIS
24 cm // 9 1/2"

32 x 50 mm	38 x 50 mm	D356-01
45 x 50 mm	50 x 50 mm	D356-02
65 x 50 mm	38 x 50 mm	D356-03

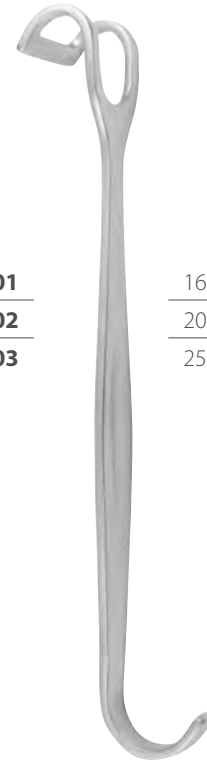

CANNY-RYALL
20 cm // 8"

16 mm	D358-16
20 mm	D358-20
25 mm	D358-25



MIDDELDORPF

D360-01	21,5 cm // 8 1/2"	D360-11
	14 x 17 mm	



D360-02	22 cm // 8 3/4"	D360-12
	20 x 22 mm	



D360-03	23,5 cm // 9"	D360-13
	26 x 30 mm	



MIDDELDORPF



MIDDELDORPF
25,5 cm // 10"

45 x 45 mm	D361-01
45 x 50 mm	D361-02
55 x 70 mm	D361-03

Wundhaken Retractors



GREEN
22 cm // 8 3/4"
D361-22



Mit Schlaufengriff
With Sloop handle

RICHARDSON
26 cm // 10 1/4"

28 x 20 mm	D365-01
30 x 28 mm	D365-02
38 x 38 mm	D365-03
52 x 22 mm	D365-04



Mit Komfort-Griff
With Comfort handle

RICHARDSON
26 cm // 10 1/4"

28 x 20 mm	D365-11
30 x 28 mm	D365-12
38 x 38 mm	D365-13
52 x 22 mm	D365-14
24 cm // 9 1/2"	64 x 41 mm D365-31



RICHARDSON-EASTMAN
Satz // Set
26 cm // 10 1/4"
28 cm // 11"

Satz // Set	D370-00
Fig. 1	D370-01
Fig. 2	D370-02

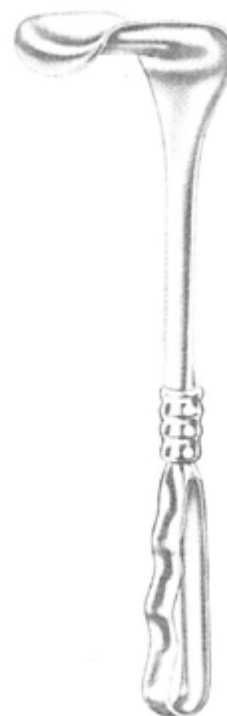

KELLY
26 cm // 10 1/4"

40 x 50 mm	D374-01
50 x 65 mm	D374-02
65 x 75 mm	D374-03
75 x 90 mm	D374-04

Wundhaken
Retractors

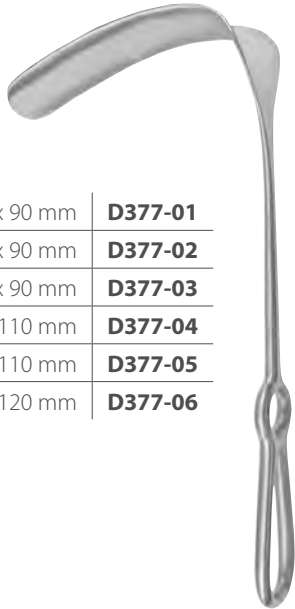

15 x 90 mm	D377-01
20 x 90 mm	D377-02
30 x 90 mm	D377-03
35 x 110 mm	D377-04
40 x 110 mm	D377-05
55 x 120 mm	D377-06

DOYEN-STILLE
24 cm // 9 1/2"



KOCHER
22,5 cm // 9"
D379-22



TUFFIER
23 cm // 9"
64 x 60 mm
D381-23

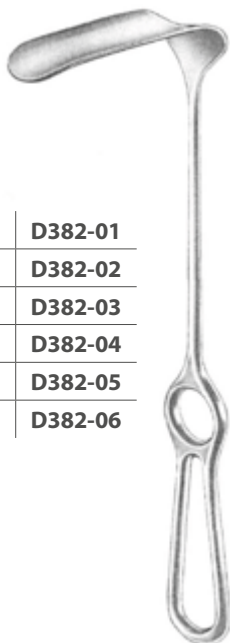

60 x 20 mm	D382-01
80 x 30 mm	D382-02
100 x 30 mm	D382-03
120 x 30 mm	D382-04
140 x 30 mm	D382-05
140 x 40 mm	D382-06

HÖSEL
25 cm // 10"



CASPAR
21,5 cm // 8 1/2"
D383-00

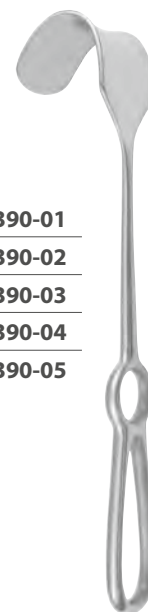

32 x 40 mm	D390-01
40 x 50 mm	D390-02
40 x 60 mm	D390-03
45 x 75 mm	D390-04
65 x 85 mm	D390-05

FRITSCH
24 cm // 9 1/2"



DOYEN
25 cm // 10"
50 x 85 mm
D392-25

Wundhaken Retractors



80 x 42 mm	D394-01
80 x 50 mm	D394-02
80 x 60 mm	D394-03

KOCHER
25 cm // 10"



MOD. TÜBINGEN
28 cm // 11"
D396-28

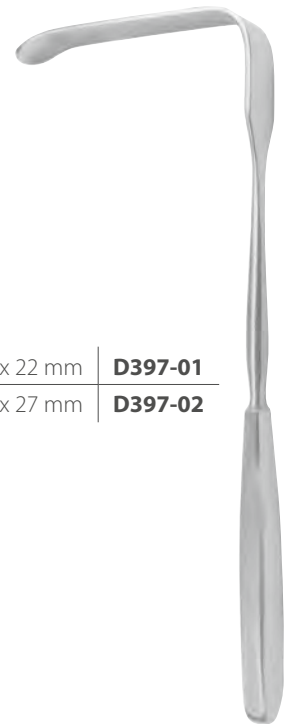

115 x 22 mm	D397-01
115 x 27 mm	D397-02

SIMON
28 cm // 11"



MARTIN
26 cm // 10 1/4"
D398-26

80 x 20 mm	D400-01
100 x 25 mm	D400-02
120 x 25 mm	D400-03
130 x 30 mm	D400-04
140 x 30 mm	D400-05
160 x 30 mm	D400-06
180 x 30 mm	D400-07



BRUNNER
25 cm // 10"

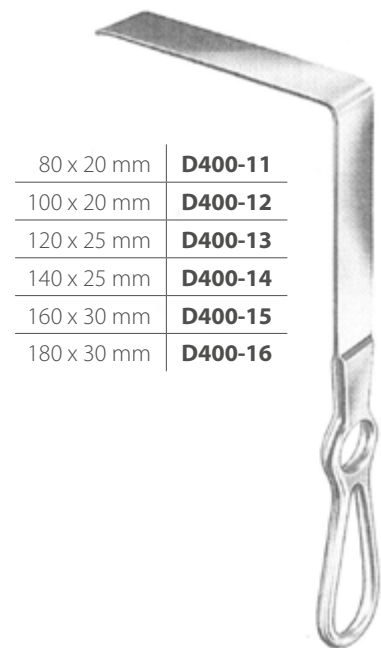

80 x 20 mm	D400-11
100 x 20 mm	D400-12
120 x 25 mm	D400-13
140 x 25 mm	D400-14
160 x 30 mm	D400-15
180 x 30 mm	D400-16

BRUNNER
25 cm // 10"

Wundhaken
Retractors



MIKULICZ
26 cm // 10 1/4"
90 x 50 mm
D401-01

80 x 35 mm	D401-12
120 x 50 mm	D401-13
155 x 50 mm	D401-14

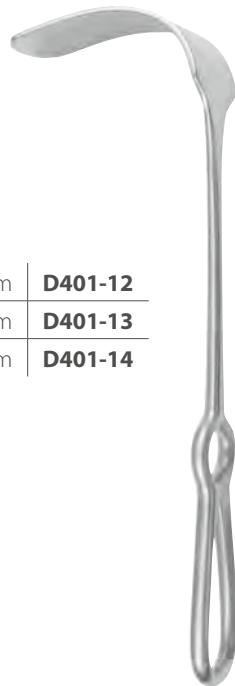

MIKULICZ
26 cm // 10 1/4"

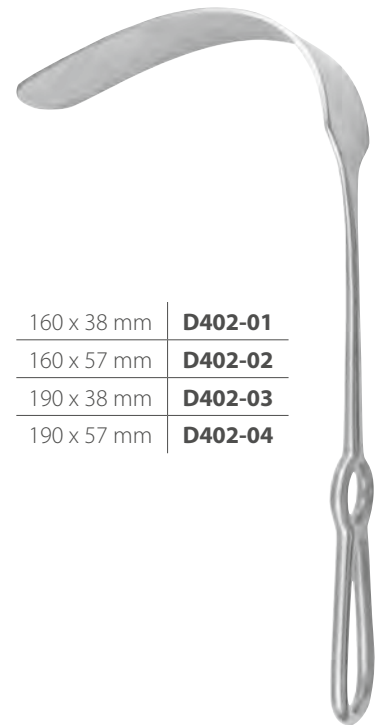

160 x 38 mm	D402-01
160 x 57 mm	D402-02
190 x 38 mm	D402-03
190 x 57 mm	D402-04

KELLY
27 cm // 10 1/2"



KÜMMEL
33 cm // 13"
46 mm
D410-33



KÖRTE
28 cm // 11"
100 x 45 mm
D411-28

Wundhaken Retractors

82 x 20 mm	D412-01
115 x 38 mm	D412-02
115 x 65 mm	D412-03

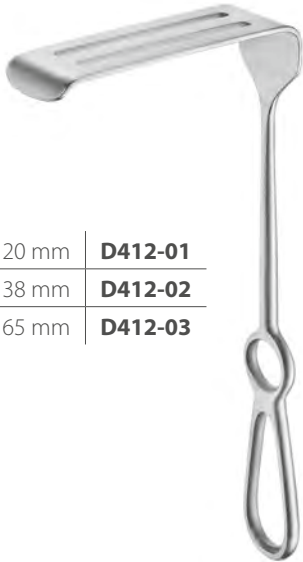

CORYLLOS
22,5 cm // 9"



SAUERBRUCH
25 cm // 10"
130 x 38 mm
D413-25



ST. MARKS
29 cm // 11 1/2"
130 x 60 mm
D415-01



ST. MARKS
32,5 cm // 12 3/4"
180 x 60 mm
D415-02



ST. MARKS
33 cm // 13"
180 x 60 mm
D415-03

Wundhaken
Retractors



ZENKER

25-29 cm // 10-11 1/2"

35 x 8 mm	D422-01
60 x 12 mm	D422-02
75 x 12 mm	D422-03
120 x 12 mm	D422-04



KADER

27 cm // 10 3/4"

20 mm	D424-01
30 mm	D424-02
40 mm	D424-03



TAYLOR

20 cm // 8"

30 x 75 mm	D428-01
30 x 100 mm	D428-02



BLOUNT

17,5 cm // 7"

D432-17



21 cm // 8 1/4"

38 x 9 mm

D432-21



SMILLIE

14 cm // 5 1/2"

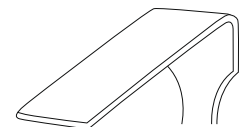

32 x 19 mm	D433-01
48 x 19 mm	D433-02
57 x 19 mm	D433-03



52 x 13 mm

D433-04

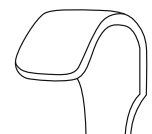

12 x 13 mm

D433-05

Wundhaken Retractors



BRISTOW-BANKART
21 mm
D435-01



BRISTOW-BANKART
25 x 102 mm
D435-02

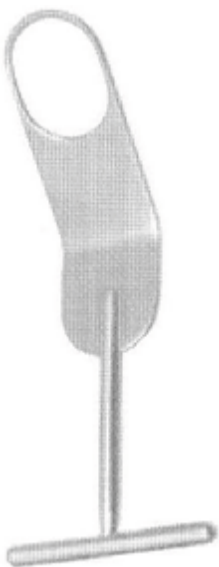

FUKUDA
32 mm | **D438-01**
38 mm | **D438-02**



POLLOSON
27 cm // 10 ½"
D440-01



POLLOSON
27 cm // 10 ½"
D440-02

Wundhaken
Retractors



DAVIDSON

72 x 50 mm	D441-01
75 x 90 mm	D441-02



HEANEY

	27 cm // 10 1/2"	17 cm // 6 3/4"
45 x 28 mm	D442-101	D442-201
73 x 28 mm	D442-102	D442-202
82 x 28 mm	D442-103	D442-203

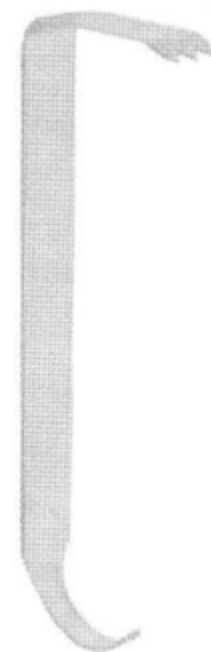

HIBBS

24 cm // 9 1/2"

Satz // Set	D445-00
75 x 25 mm	D445-01
80 x 25 mm	D445-02
100 x 25 mm	D445-03



BOROWSKI
27 cm // 10 1/2"

17 x 21 mm	D446-01
16 x 23 mm	D446-02
20 x 25 mm	D446-03
24 x 27 mm	D446-04
28 x 20 mm	D446-05
28 x 29 mm	D446-06

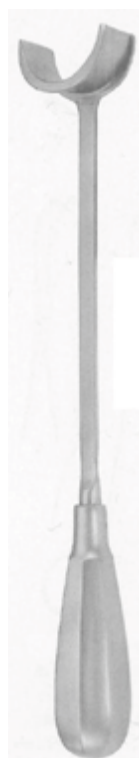

ROSS
27 cm // 10 1/2"

15 x 16 mm	D447-01
13 x 23 mm	D447-02
17 x 23 mm	D447-03
13 x 27 mm	D447-04
29 x 29 mm	D447-05
40 x 21 mm	D447-06

Wundhaken Retractors



COOLEY
21,5 cm // 8 ½"

glatt
smooth

D448-01



COOLEY
21,5 cm // 8 ½"

gezahnt
serrated

D448-02



COOLEY
21,5 cm // 8 ½"

glatt
smooth

D448-03



COOLEY
21,5 cm // 8 ½"

gezahnt
serrated

D448-04



DEAVER
17 cm // 6 ¾"

Satz // Set	D450-00
8 mm	D450-01
10 mm	D450-02
12 mm	D450-03



DEAVER
18 cm // 7"

D450-11



DEAVER
21,5 cm // 8 ½"

D450-12

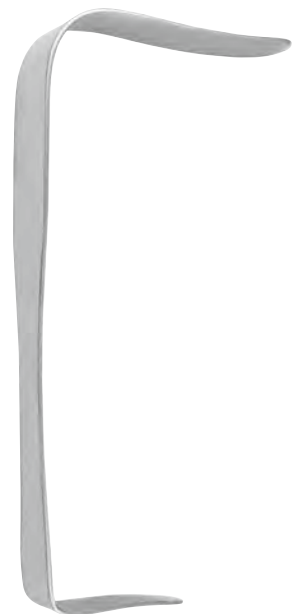

DEAVER
23 cm // 9"

D450-21

Wundhaken
Retractors



27 cm // 10 1/2"	D450-31
30 cm // 12"	D450-32
33 cm // 13"	D450-33
36 cm // 14"	D450-34

DEAVER
25 mm

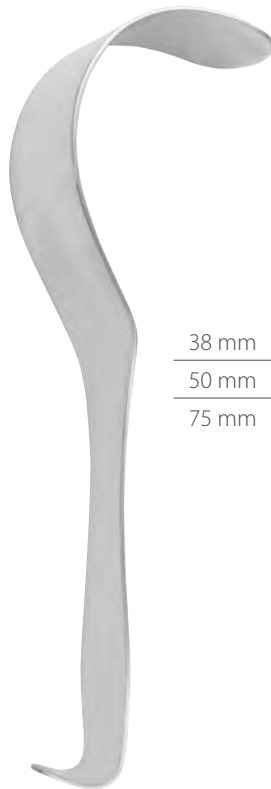

38 mm	D450-41
50 mm	D450-42
75 mm	D450-43

DEAVER
30 cm // 12"



25 mm	D451-32
38 mm	D451-41
50 mm	D451-42
75 mm	D451-43

DEAVER
30 cm // 12"

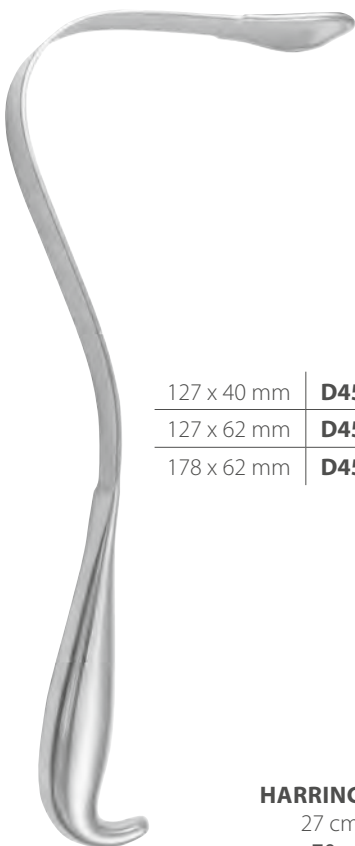

127 x 40 mm	D455-01
127 x 62 mm	D455-02
178 x 62 mm	D455-03

HARRINGTON
32 cm // 12 1/2"

HARRINGTON-BABY
27 cm // 10 1/2"
70 x 24 mm
D456-27



20 cm // 8"	50 x 16 mm	D458-01
22,5 cm // 9"	75 x 25 mm	D458-02
24 cm // 9 1/2"	90 x 50 mm	D458-03

MEYERDING

Spatel Spatulas



15 cm // 6"	6 mm	D480-106
15 cm // 6"	13 mm	D480-113
15 cm // 6"	19 mm	D480-119
17 cm // 6 3/4"	16 mm	D480-216
20 cm // 8"	6 mm	D480-306
20 cm // 8"	8 mm	D480-308
20 cm // 8"	10 mm	D480-310
20 cm // 8"	12 mm	D480-312
20 cm // 8"	17 mm	D480-317
20 cm // 8"	20 mm	D480-320
20 cm // 8"	25 mm	D480-325
25 cm // 10"	25 mm	D480-425



33 cm // 13"

20 mm	D480-520
25 mm	D480-525
39 mm	D480-530
32 mm	D480-532
35 mm	D480-535
38 mm	D480-538
40 mm	D480-540
45 mm	D480-545
50 mm	D480-550
64 mm	D480-564
76 mm	D480-576
102 mm	D480-602



HABERER

280 x 25/30 mm	D462-01
300 x 37/45 mm	D462-02
300 x 40/50 mm	D462-03



TUFFIER
20 cm // 8"
17 x 25 mm
D482-20



LERICHE

31 cm // 12 1/2"	45 mm	D486-01
33 cm // 13"	60 mm	D486-02



REVERDIN
28 cm // 11"
D488-28

Wundspreizer

// Retractors

Inhalt

Index

Abschnitt **D**
// Section

Wundspreizer <i>Retractors</i>	D34 - D45
Bauchdeckenhalter <i>Abdominal Retractors</i>	D46 - D54
Ring-Sperrer-System <i>Ring-Retractor-System</i>	D55 - D60

Wundspreizer
Retractors



FINSEN

	scharf sharp	stumpf blunt
5 cm // 2"	D700-051	D700-052
7 cm // 2 3/4"	D700-071	D700-072



FINSEN

7 cm // 2 3/4"

scharf sharp	stumpf blunt
D702-071	D702-072



8,5 cm // 3 1/2"	D705-08
11,5 cm // 4 1/2"	D705-11



HEISS
10 cm // 4"



scharf
sharp

D706-101



stumpf
blunt

D706-102



PARSONNET

25 mm	D708-25
31 mm	D708-31
38 mm	D708-38
50 mm	D708-50



ALM

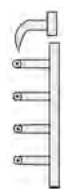

scharf
sharp

D712-071



stumpf
blunt

D712-072



halbscharf
semi-sharp

D712-103

7 cm // 2 3/4"

10 cm // 4"



JANSEN
10 cm // 4"

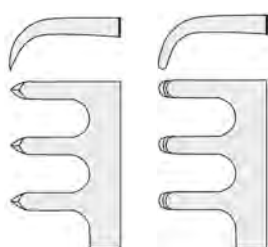

scharf
sharp

D715-101

stumpf
blunt

D715-102



Volles Blatt links
Full blade left

D717-01



Volles Blatt rechts
Full blade right

D717-02

PERKINS
13 cm // 5"

Wundspreizer Retractors



PLESTER
10 cm // 4"
D719-01



PLESTER
10 cm // 4"
D719-02

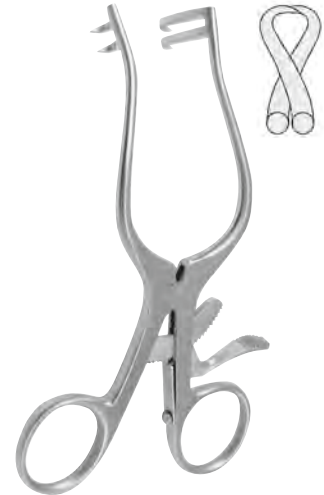

	scharf sharp	stumpf blunt
10 cm // 4"	D720-101	D720-102
13 cm // 5"	D720-131	D720-132



WEITLANER
10 cm // 4"

scharf sharp	stumpf blunt	halbscharf semi-sharp
D730-101	D730-102	D730-103
-	D730-102N	-

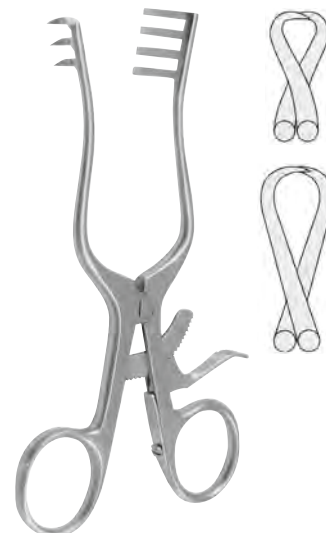

WEITLANER

	scharf sharp	stumpf blunt	halbscharf semi-sharp
13 cm // 5"	D730-131	D730-132	D730-133
16,5 cm // 6 1/2"	D730-161	D730-162	D730-163

Wundspreizer
Retractors



WEITLANER

	scharf <i>sharp</i>	stumpf <i>blunt</i>
20 cm // 8"	D730-201	D730-202
25 cm // 10"	D730-251	D730-252



CONTOUR
14 cm // 5 1/2"

scharf <i>sharp</i>	stumpf <i>blunt</i>
D738-141	D738-142
D738-141N	-

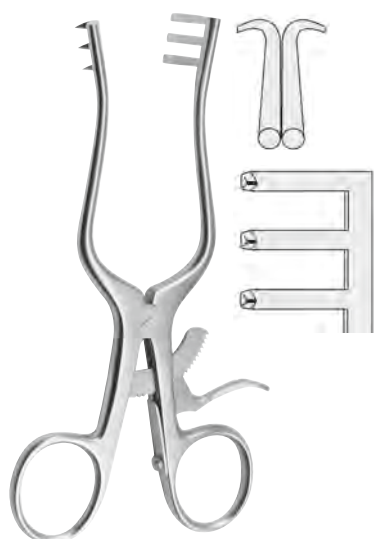

MILLIGAN
13 cm // 5"

scharf <i>sharp</i>	stumpf <i>blunt</i>
D740-131	D740-132



WEITLANER-WULLSTEIN

	scharf <i>sharp</i>	stumpf <i>blunt</i>
13 cm // 5"	D745-131	D745-132
16,5 cm // 6 1/2"	D745-161	D745-162

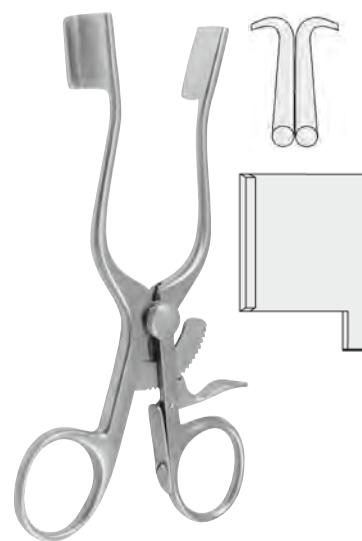

WEITLANER-BABY
13 cm // 5"
D748-13

Wundspreizer Retractors



SCHUKNECHT
12 cm // 5"

scharf sharp	stumpf blunt
D750-121	D750-122



MOLLISON
15 cm // 6"

scharf sharp	stumpf blunt
D752-151	D752-152

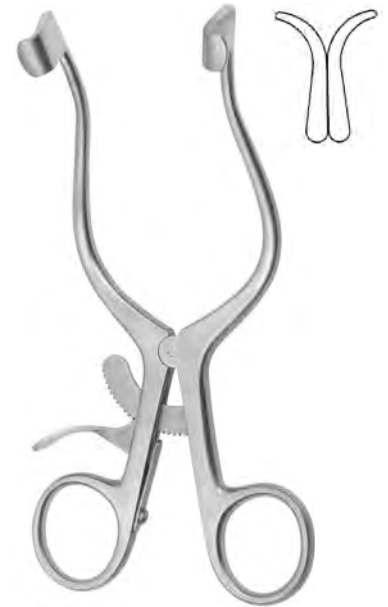

MOD. TÜBINGEN
16 cm // 6 1/4"
D754-16



TRAVERS
21 cm // 8 1/4"
D760-21



HENLEY
16,5 cm // 6 1/2"

	scharf sharp	stumpf blunt
Komplett Complete	D762-01	D762-02
Sperrer allein Retractor only	D762-11	D762-12

Mittelvalven allein
Central blades only

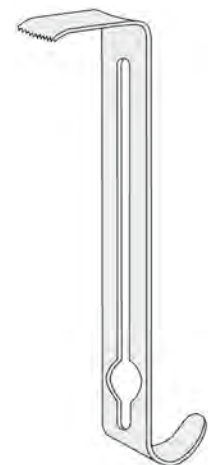

18 x 15 mm	D762-31
25 x 15 mm	D762-32
31 x 14 mm	D762-33

Wundspreizer
Retractors



ANDERSON-ADSON
20 cm // 8"



scharf sharp	stumpf blunt
D771-201	D771-202



ADSON
20 cm // 8"

scharf sharp	stumpf blunt
-----------------	-----------------

D772-201	D772-202
-----------------	-----------------



ADSON
26,5 cm // 10 1/2"

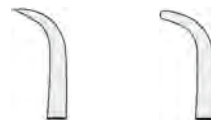

scharf sharp	stumpf blunt
-----------------	-----------------

D773-271	D773-272
-----------------	-----------------

5 x 6 Zähne
5 x 6 teeth

scharf sharp	stumpf blunt
-----------------	-----------------

D774-271	D774-272
-----------------	-----------------



CONE

13 cm // 5"
16,5 cm // 6 1/2"

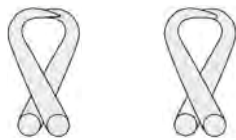

scharf sharp	stumpf blunt
-----------------	-----------------

D780-131	D780-132
D780-161	D780-162



CONE



scharf sharp	stumpf blunt
-----------------	-----------------

20 cm // 8"	D780-201	D780-202
25 cm // 10"	D780-251	D780-252

Wundspreizer Retractors

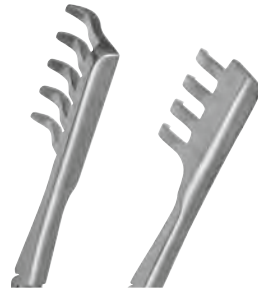

4 x 5 Zähne
4 x 5 teeth

scharf <i>sharp</i>	stumpf <i>blunt</i>
D784-331	D784-332



BECKMANN
31 cm // 12 1/4"



BECKMANN-ADSON
31 cm // 12 1/4"

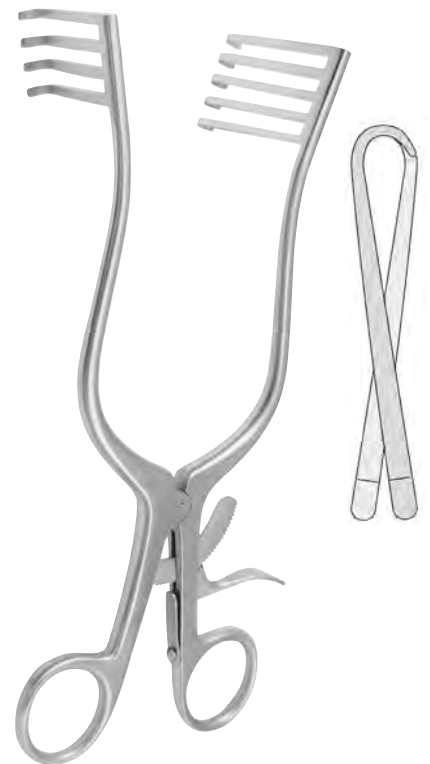

NORFOLK-NORWICH
22 cm // 8 1/2"

	scharf <i>sharp</i>	stumpf <i>blunt</i>	halbscharf <i>semi-sharp</i>	scharf <i>sharp</i>	stumpf <i>blunt</i>	halbscharf <i>semi-sharp</i>
25 mm	D782-311	D782-312	-	D788-311	D788-312	D788-313
44 mm	D783-311	D783-312	D783-313			

Wundspreizer
Retractors

Hemilaminectomiesperrer
Hemilaminectomy retractors

Horizontalspreizer
Horizontal Spreader



MISKIMOM
22 cm // 8 ½"

scharf
sharp

stumpf
blunt

D792-221

D792-222



ADSON
27 cm // 10 ½"

Rechts Zähne kurz
Right short teeth

D794-01

Links Zähne kurz
Left short teeth

D794-02



BECKMANN-EATON
33 cm // 13"

scharf
sharp

stumpf
blunt

D795-331

D795-332



SEXTON
33 cm // 13"

D796-33

Wundspreizer Retractors



Sperrer allein
Retractor only

D800-10

BABY-COLLIN

Komplett mit 2 Paar Valven
Complete with 2 pairs of blades

D800-00



Paar Valven allein
Pairs of blades only

18 x 42 mm

D800-11

28 x 42 mm

D800-12



COLLIN

Komplett <i>Complete</i>	D801-01
Sperrer allein <i>Retractor only</i>	D801-11
Paar Valven allein <i>Pairs of blades only</i>	D801-21



COLLIN

Komplett <i>Complete</i>	D801-02	D801-03	D801-04
Sperrer allein <i>Retractor only</i>	D801-12	D801-13	D801-14
	38 x 62 mm	38 x 80 mm	38 x 100 mm
Paar Valven allein <i>Pairs of blades only</i>	D801-21	D801-22	D801-23
	55 x 55 mm	55 x 65 mm	55 x 75 mm
Mittelblatt allein <i>Central valve only</i>	D801-31	D801-32	D801-33

Wundspreizer
Retractors



COLLIN

Komplett <i>Complete</i>	D802-00
Sperrer allein <i>Retractor only</i>	D802-10
	60 x 80 mm
Paar Valven allein <i>Pairs of blades only</i>	D802-21
	62 x 70 mm
Mittelblatt allein <i>Central valve only</i>	D802-31



HOLZBACH

Komplett <i>Complete</i>	D810-00
Sperrer allein <i>Retractor only</i>	D810-10
	80 x 80 mm
Mittelblatt allein <i>Central valve only</i>	D810-20



RICARD

Komplett <i>Complete</i>	D812-01	D812-02
Sperrer allein <i>Retractor only</i>	D812-10	D812-10
	60 x 80 mm	72 x 85 mm
Paar Valven allein <i>Pairs of blades only</i>	D812-21	D812-22
	53 x 70 mm	80 x 90 mm
Mittelblatt allein <i>Central valve only</i>	D812-20	D812-21

Wundspreizer Retractors

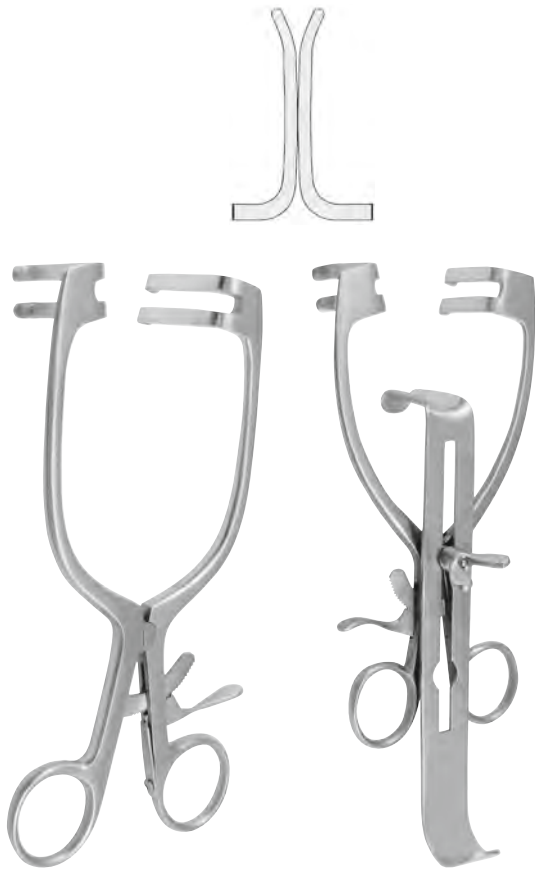

MAYO-ADAMS
17 cm // 6 3/4"
D815-17

MAYO-ADAMS
17 cm // 6 3/4"
D816-17

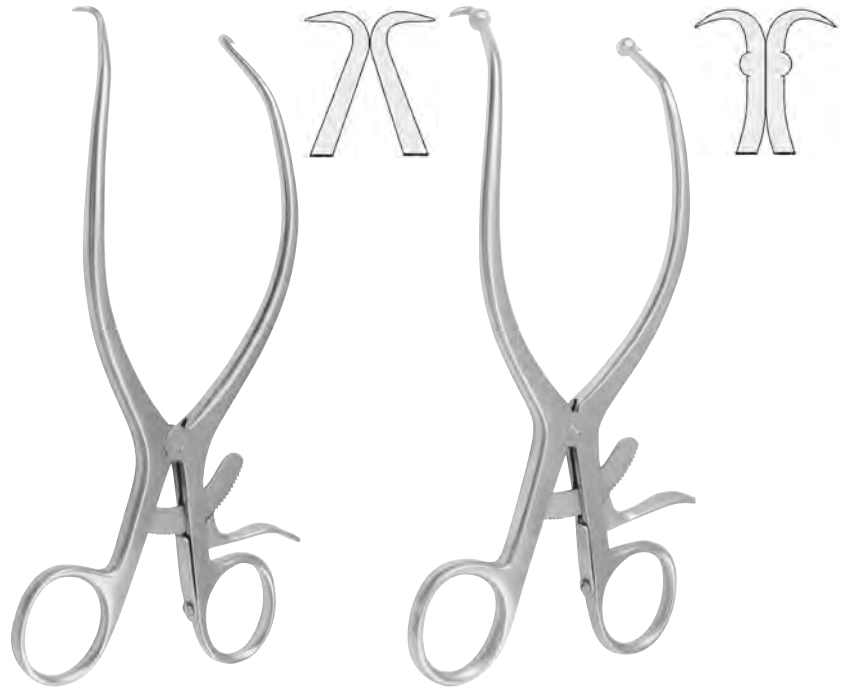

9 cm // 3 1/2"	D820-09
11 cm // 4 1/2"	D820-11
14 cm // 5 1/2"	D820-13
19 cm // 7 1/2"	D820-19

GELPI
19 cm // 7 1/2"
D821-19



GELPI-SELETZ

16,5 cm // 6 1/2"	D822-16
18 cm // 7"	D822-18



DEBAKEY

10 cm // 4"	D824-10
14,5 cm // 5 1/2"	D824-14

Wundspreizer
Retractors



WILLIAM
17,5 cm // 6 3/4"

	Blatt rechts <i>Blade right</i>
50 x 10 mm	D826-01
60 x 10 mm	D826-02
70 x 10 mm	D826-03
50 x 20 mm	D826-04
60 x 20 mm	D826-05
70 x 20 mm	D826-06



WILLIAM
17,5 cm // 6 3/4"

	Blatt links <i>Blade left</i>
50 x 10 mm	D826-11
60 x 10 mm	D826-12
70 x 10 mm	D826-13
50 x 20 mm	D826-14
60 x 20 mm	D826-15
70 x 20 mm	D826-16



MEYERDING
19 cm // 7 1/2"

32 x 25 mm	D827-01
54 x 25 mm	D827-02
60 x 19 mm	D827-03
60 x 25 mm	D827-04

Blatt links
Blade left
D828-01



MARKHAM-MEYERDING
18 cm // 7"

Blatt rechts
Blade right
D828-02



RIGBY
19 cm // 7 1/2"
60 x 20 mm
D829-19

Wundspreizer Retractors

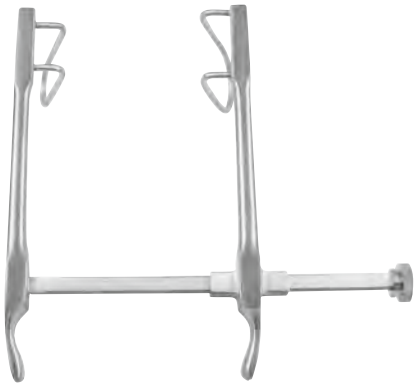

GOSSET
10 cm // 4"
D840-00

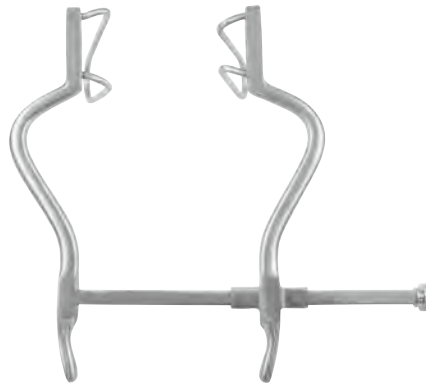

GOSSET

10 cm // 4"	D841-10
14 cm // 5 1/2"	D841-14

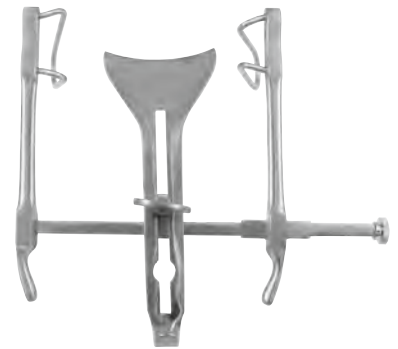

GOSSET

Komplett <i>Complete</i>	D842-00
Sperrer allein <i>Retractor only</i>	D842-10
Mittelvalve allein <i>Central valve only</i>	D842-21

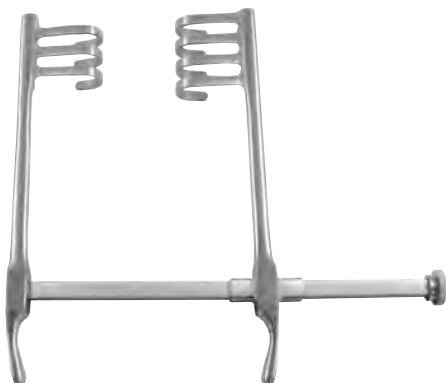

FRAZIER
D844-00

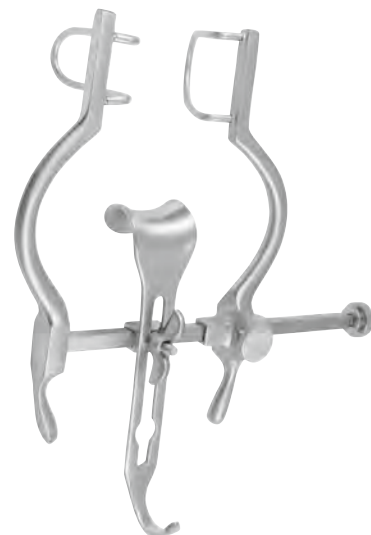

BABY-BALFOUR

Komplett <i>Complete</i>	D846-00
Sperrer allein <i>Retractor only</i>	D846-10
Mittelvalve allein <i>Central valve only</i>	D846-21

Bauchdeckenhalter
Abdominal Retractors



BALFOUR

	18 cm // 7"	18 cm // 7"
Seitenvalven Side blades	50 mm	63 mm
Mittelvalve Central blade	75 x 50 mm	75 x 50 mm
	D847-00	D847-01

Mittelblatt allein
Central blade only



75 x 50 mm	D848-21
85 x 70 mm	D848-23
93 x 44 mm	D848-24

Mittelblatt allein
Central blade only



60 x 10 mm	D848-31
70 x 10 mm	D848-32

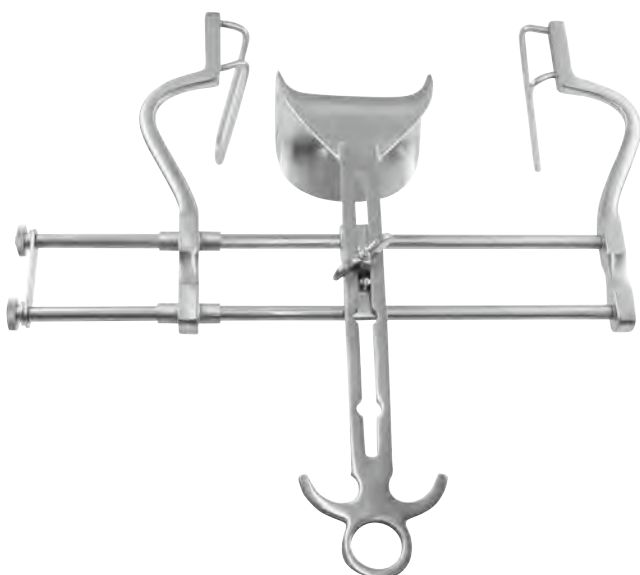

BALFOUR

	25 cm // 10"	25 cm // 10"
Seitenvalven Side blades	50 mm	100 mm
Mittelvalve Central blade	85 x 50 mm	85 x 70 mm
	D849-00	D849-01



BALFOUR
20 cm // 8"
D851-00

Seitenvalven 100 mm
Side blades 100 mm
Mittelvalve 100 x 70 mm
Central blade 100 x 70 mm

Bauchdeckenhalter Abdominal Retractors

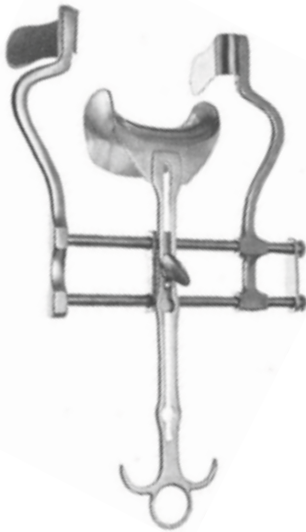

BALFOUR

	18 cm // 7"	18 cm // 7"
Seitenvalven <i>Side blades</i>	50 mm	70 mm
Mittelvalve <i>Central blade</i>	75 x 50 mm	75 x 50 mm
	D855-00	D855-01

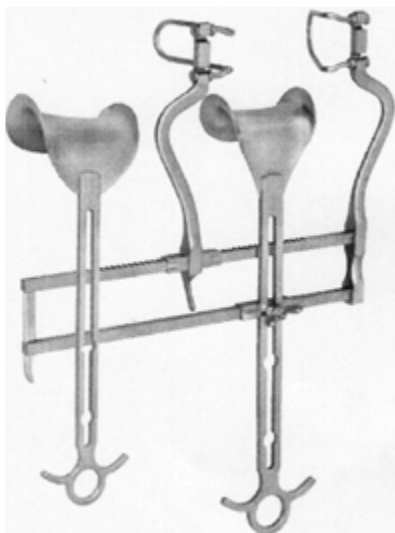

BALFOUR

		18 cm // 7"
Komplett <i>Complete</i>		D857-00
Paar Seitenvalven <i>Pair lateral blades</i>	57 mm	D857-31
Paar Seitenvalven <i>Pair lateral blades</i>	90 mm	D857-32
Mittelvalve <i>Center blade</i>	68 x 40 mm	D857-21
Mittelvalve <i>Center blade</i>	85 x 70 mm	D857-22

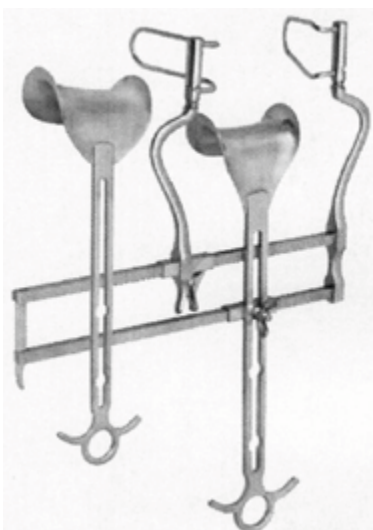

BALFOUR US-TYP

Rahmen, Spreizweite <i>Spreading width</i>	18 cm // 7"	25 cm // 10"
Mittelvalve <i>Central blade</i>	68 x 40 mm	75 x 50 mm
Mittelvalve <i>Central blade</i>	85 x 70 mm	60 x 100 mm
Paar Seitenvalven <i>Pair lateral blades</i>	50 mm	50 mm
Paar Seitenvalven <i>Pair lateral blades</i>	75 mm	100 mm
	D858-00	D858-01

Paar Seitenvalven <i>Pair lateral blades</i>	50 mm	75 mm	100 mm
	D858-21	D858-22	D858-23

Bauchdeckenhalter
Abdominal Retractors

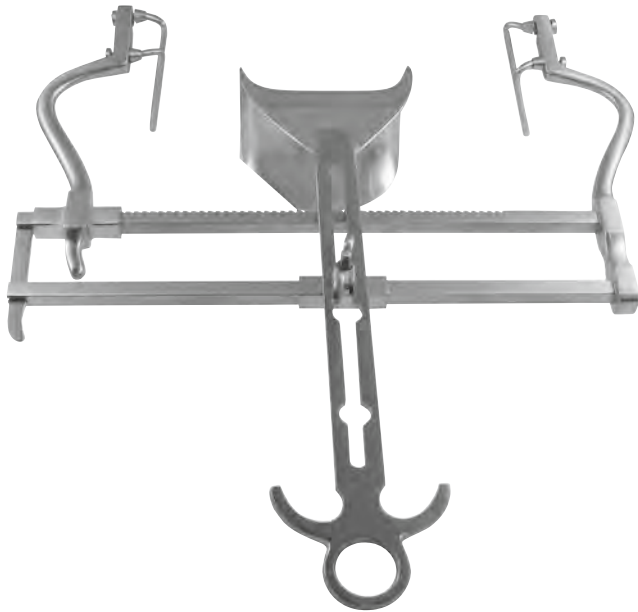

BALFOUR US-PATTERN

	21,5 cm // 8 ½"	26,5 cm // 10 ½"
Paar Seitenvallen <i>Pair lateral blades</i>	64 mm	64 mm
Paar Seitenvallen <i>Pair lateral blades</i>	89 mm	89 mm
Mittelvalve <i>Central blade</i>	64 x 64 mm	85 x 70 mm
	D860-00	D860-01

Mittelvalve
Center blade



64 x 64 mm	D860-32
85 x 70 mm	D860-35
93 x 44 mm	D860-38

Paar Seitenvallen
Pair lateral valves

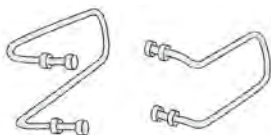

64 mm	D860-21
89 mm	D860-22
100 mm	D860-23



Mittelvalve
Center blade
195 x 51mm
D860-41



Seitenarm links
Side-arm left

D860-51

Seitenarm rechts
Side-arm right

D860-52

Bauchdeckenhalter Abdominal Retractors

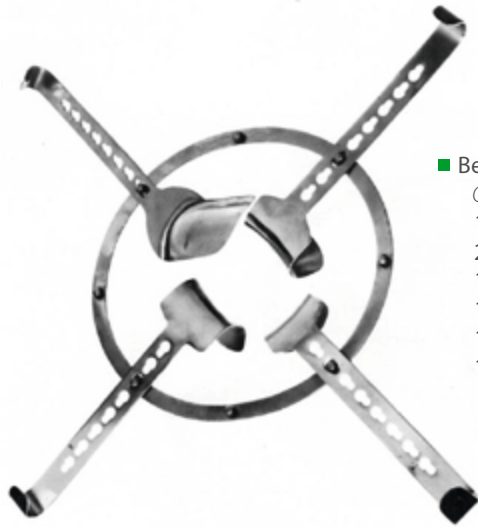

- Bestehend aus
Consisting of
- 1x D862-10
- 2x D862-21
- 1x D862-22
- 1x D862-23
- 1x D862-24
- 1x D862-25

SEMME

■ Komplett Complete	D862-00
Rahmen allein Frame only	D862-10

Wundhaken allein Retractors only



65 x 47 mm	D862-21
54 x 50 mm	D862-22
98 x 76 mm	D862-23
52 x 98 mm	D862-24
35 x 105 mm	D862-25



DENIS-BROWN

■ Komplett Complete		D864-00
Rahmen allein Frame only	180 x 150 mm	D864-10
Rahmen allein Frame only	225 x 180 mm	D864-11

Wundhaken allein Retractors only

20 x 40 mm	D864-21
20 x 30 mm	D864-22

- Bestehend aus
Consisting of
- 1x D864-10
- 2x D864-21
- 2x D864-22



O-SULLIVAN-O'CONNOR

■ Komplett Complete		D865-00
Rahmen allein Frame only	180 x 150 mm	D865-10

- Bestehend aus
Consisting of
- 1x D865-10
- 2x D865-31
- 1x D865-32

Wundhaken allein Retractors only



90 x 45 mm	D865-31
100 x 70 mm	D865-32

Bauchdeckenhalter
Abdominal Retractors

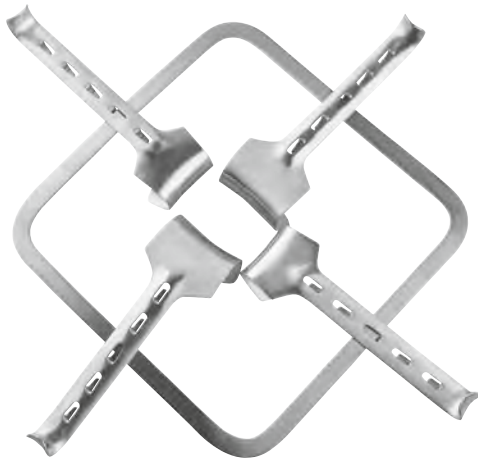

KIRSCHNER

■ Bestehend aus
Consisting of
1x D868-10
2x D868-21
2x D868-22

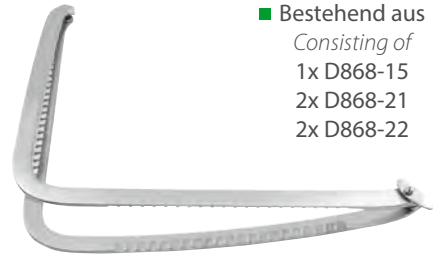

■ Bestehend aus
Consisting of
1x D868-15
2x D868-21
2x D868-22

Rahmen zusammenlegbar
Foldable Frame

■ **Komplett**
Complete

D868-02

Rahmen allein
Frame only

D868-15

		Rahmen fest Solid Frame
■ Komplett Complete		D868-01
Rahmen allein Frame only	240 x 240 mm	D868-10
Rahmen allein Frame only	295 x 275 mm	D868-11
Rahmen allein Frame only	300 x 380 mm	D868-12

Wundhaken allein
Retractors only



40 x 55 mm	D868-21
50 x 65 mm	D868-22
65 x 80 mm	D868-23
90 x 65 mm	D868-24
90 x 90 mm	D868-25
80 x 80 mm	D868-26

Rahmen allein
Frame only

D870-10

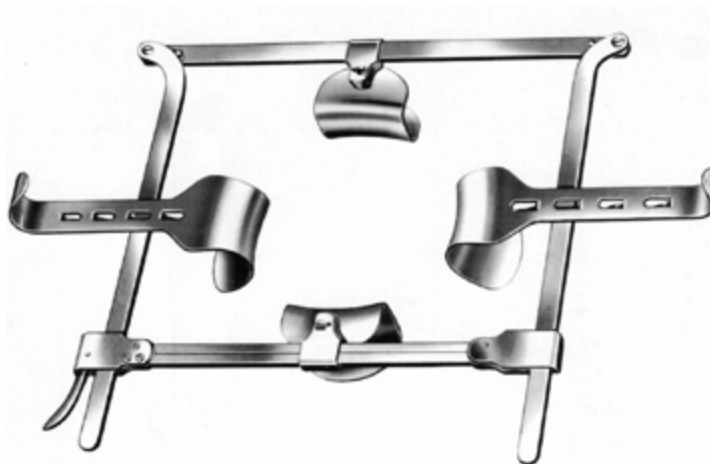

FRANZ

Wundhaken allein
Retractors only

40 x 60 mm	D870-21
40 x 80 mm	D870-22
48 x 56 mm	D870-23
50 x 85 mm	D870-24

Komplett mit 4 Valven
Complete with 4 blades

D870-00

Komplett mit 8 Valven
Complete with 8 blades

D870-01

Bauchdeckenhalter Abdominal Retractors



Befestigungsgestell einfach
Mounting Frame single

D874-10



Befestigungsgestell doppelt
Mounting Frame double

D874-11



ROCHARD

50 x 95 mm	D874-01
50 x 105 mm	D874-02
60 x 120 mm	D874-03
60 x 135 mm	D874-04
60 x 155 mm	D874-05



Fixiervorrichtung
Fixation device

D874-21

Bauchdeckenhalter
Abdominal Retractors



50 x 90 mm	D875-01
50 x 105 mm	D875-02
50 x 120 mm	D875-03
50 x 135 mm	D875-04

DOYEN

Komplett mit D876-10, D876-09,
D876-12, D876-22
Complete with D876-10, D876-09,
D876-12, D876-22

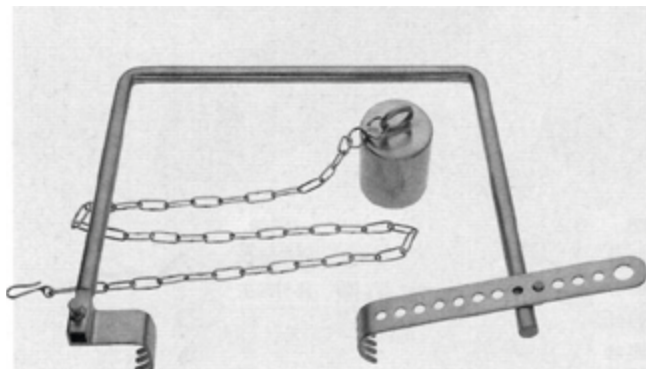

CHARNLEY

Rahmen allein
Frame only

D876-10



Gewicht mit Kette
Weight with chain

D876-09

	Kurzes Blatt Short Retractor		Langes Blatt Long Retractor
25 x 25 mm	D876-11	25 x 25 mm	D876-21
25 x 38 mm	D876-12	25 x 44 mm	D876-22
25 x 50 mm	D876-13	25 x 50 mm	D876-23
25 x 57 mm	D876-14	25 x 57 mm	D876-24
25 x 63 mm	D876-15	25 x 63 mm	D876-25
25 x 75 mm	D876-16	25 x 75 mm	D876-26
25 x 101 mm	D876-17	25 x 101 mm	D876-27
25 x 114 mm	D876-18	25 x 114 mm	D876-28
25 x 127 mm	D876-19		

Bauchdeckenhalter Abdominal Retractors

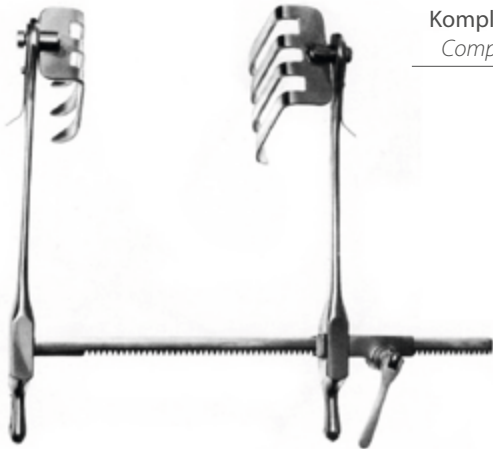

SCOVILLE-RICHTER

Komplett mit 1 Paar Valven D880-21
Complete with 1 Pair blades D880-21

D880-00

Sperrer allein
Retractor only

D880-10



Paar Valven
Pair blades
60 mm / 50 mm

D880-21

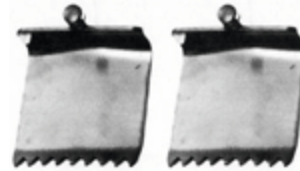

Paar Valven
Pair blades
50 mm

D880-22



Paar Valven
Pair blades
28 x 40 mm

D880-23

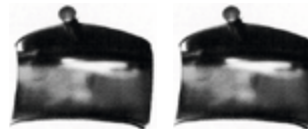

Paar Valven
Pair blades
28 x 40 mm

D880-24

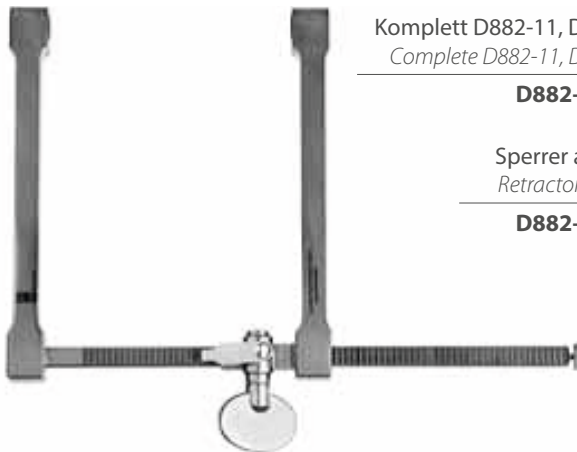

SCOVILLE

Komplett D882-11, D882-33, D882-51
Complete D882-11, D882-33, D882-51

D882-01

Sperrer allein
Retractor only

D882-11

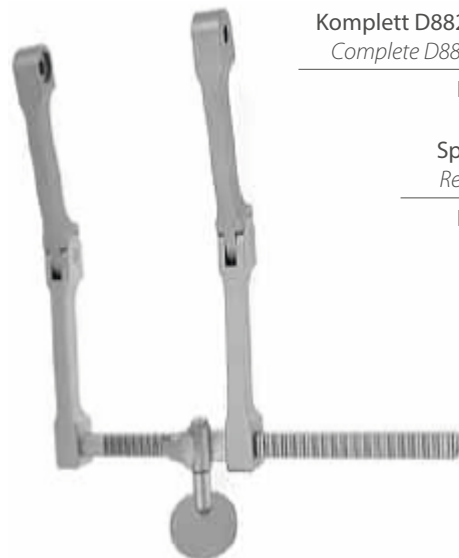

SCOVILLE-HAVERFIELD

Komplett D882-12, D882-31, D882-51
Complete D882-12, D882-31, D882-51

D882-02

Sperrer allein
Retractor only

D882-12

Bauchdeckenhalter
Abdominal Retractors

Blätter allein
Blades only



SCOVILLE
Mit Querstab
With crossbar

48 mm	D882-21
58 mm	D882-22
78 mm	D882-23



SCOVILLE
stumpf
blunt

57 mm	D882-31
77 mm	D882-32



SCOVILLE
spitz
pointed

57 mm	D882-33
77 mm	D882-34



SCOVILLE
Mit Zähnen
With Teeth

	3 Zähne 3 Teeth	4 Zähne 4 Teeth
25 x 25 mm	D882-41	-
25 x 38 mm	D882-42	-
25 x 50 mm	-	D882-43
25 x 57 mm	-	D882-44
25 x 63 mm	-	D882-45
25 x 75 mm	-	D882-46



SCOVILLE

64 x 25 mm	D882-51
67 x 29 mm	D882-52
78 x 51 mm	D882-53
91 x 26 mm	D882-54



HIBBS

48 x 19 mm	D882-61
51 x 26 mm	D882-62
58 x 51 mm	D882-63
60 x 38 mm	D882-64
65 x 26 mm	D882-65
74 x 38 mm	D882-66
74 x 64 mm	D882-67
78 x 50 mm	D882-68
80 x 26 mm	D882-69
89 x 26 mm	D882-70
92 x 39 mm	D882-71
104 x 15 mm	D882-72
105 x 26 mm	D882-73



MEYERDING

48 x 25 mm	D882-81
62 x 25 mm	D882-82
70 x 25 mm	D882-83
78 x 25 mm	D882-84
81 x 25 mm	D882-85
92 x 25 mm	D882-86



EPSTEIN

gefenstert
fenestrated
D882-90



TAYLOR

57 x 31 mm	D882-91
105 x 42 mm	D882-92

RING-RETRACTOR
SYSTEM

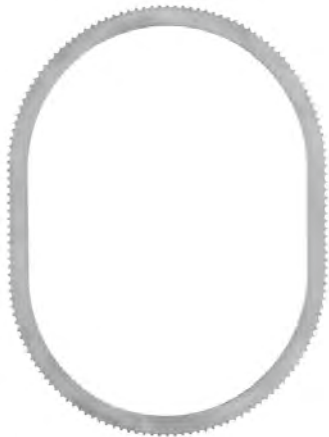
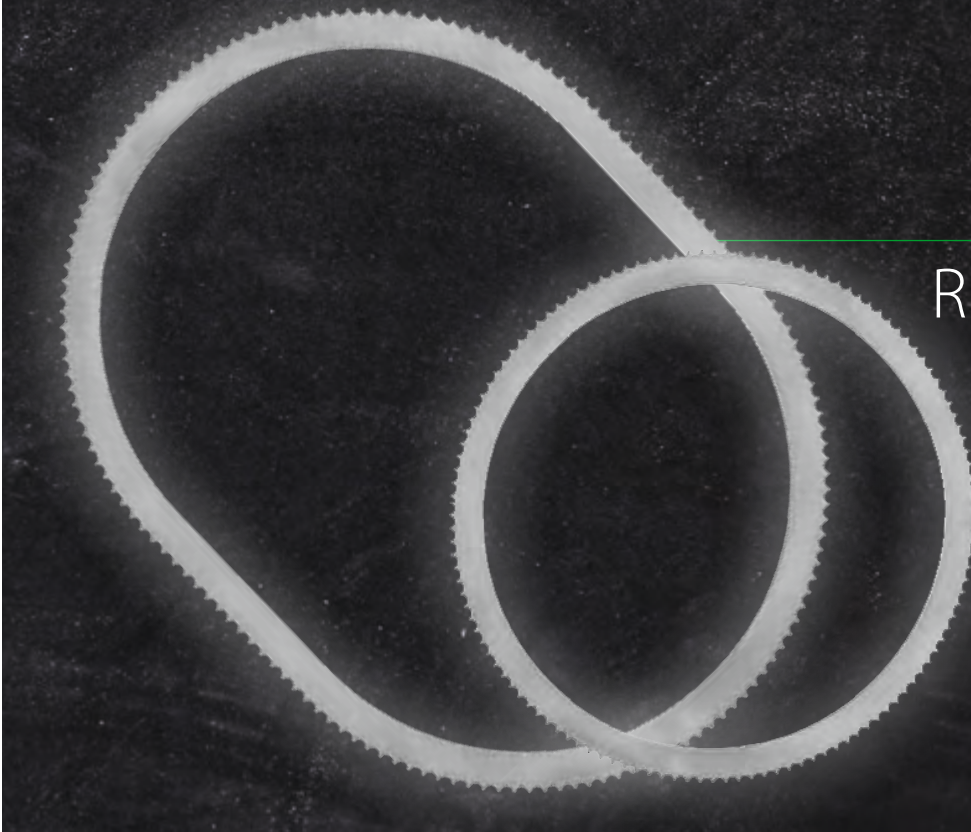

Ovale Ringe
Ovale Rings

203 x 311 mm // 8 ½" x 12"	D900-100
267 x 368 mm // 10 ½" x 15"	D900-104
267 x 470 mm // 10 ½" x 18 ½"	D900-108



Ovale Ringe, verlängert
Ovale Segmented Rings

215 x 356 mm // 8 ½" x 14"	D900-150
267 x 495 mm // 10 ½" x 19 ½"	D900-152
495 x 317 mm // 19 ½" x 8 ½"	D900-154

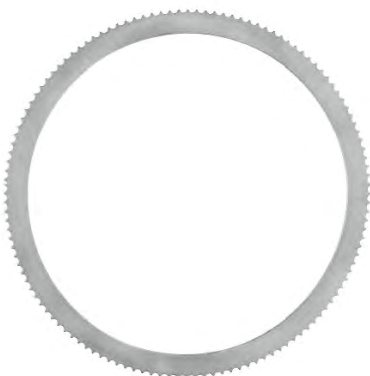

Runde Ringe
Round Rings

216 mm // 8 ½"	D900-110
266 mm // 10 ½"	D900-114
317 mm // 12 ½"	D900-118



Runde Ringeteile
Round Segmented Rings

216 mm // 8 ½"	D900-160
266 mm // 10 ½"	D900-162



Vaginal Ring
Vaginal Ring

203 x 266 mm // 8" x 10 ½"	D900-130
----------------------------	-----------------

Ring-Retractor System



Verlängerung
Segment piece

101 mm	D900-186
152 mm	D900-187
203 mm	D900-188



Befestigungselement
Standard ratchet mechanism

D900-201



Befestigungselement
Tilt ratchet mechanism

D900-203

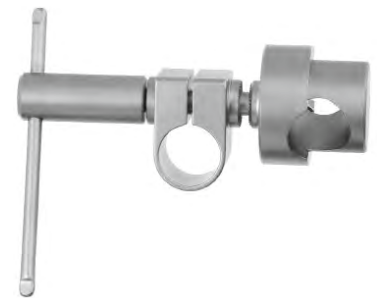

Spangelenk
Post coupling

D900-215



Tisch-Stativ
Table clamping device

D900-210

Verlängerung
Extension Bar

D900-220



Haltearm, flexibel
Flexible Bar

D900-230

Haltearm, starr
Fixed Bar

D900-235



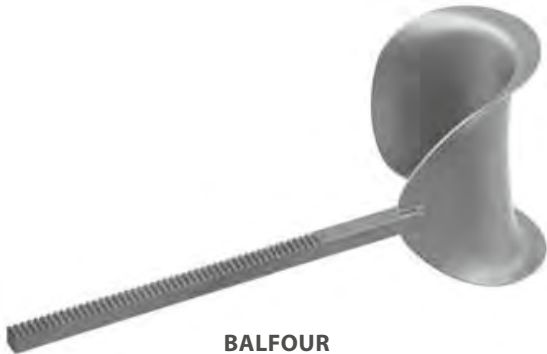

BALFOUR

75 x 63 mm // 3"x2 1/2"	D900-302
75 x 85 mm // 3"x3 1/4"	D900-304



DEAVER

25 x 89 mm // 1"x3 1/2"	D900-312
25 x 127 mm // 1"x5"	D900-314



GELPI
D900-320



HARRINGTON

63 x 143 mm // 2 1/2"x5 5/8"	D900-330
------------------------------	-----------------



MEYERDING

60 x 17 mm // 2 1/3"x2/3"	D900-400
85 x 25 mm // 3 1/3"x1"	D900-402
95 x 50 mm // 3 3/4"x2"	D900-403

Ring-Retractor System



KELLY

38 x 51 mm // 1½" x 2"	D900-380
40 x 25 mm // 2½" x 2"	D900-380
65 x 25 mm // 3" x 2½"	D900-380
51 x 51 mm // 2" x 2"	D900-380
63 x 51 mm // 2½" x 2"	D900-381
76 x 65 mm // 3" x 2½"	D900-383
102 x 51 mm // 4" x 2"	D900-384
127 x 51 mm // 5" x 2"	D900-386
154 x 51 mm // 6" x 2"	D900-388
190 x 50 mm // 4¾" x 2"	D900-390



RAKE

3 prongs	D900-410
4 prongs	D900-412
5 prongs	D900-414



RECTAL

22 x 73 mm // 7/8" x 2 7/8"	D900-420
22 x 78 mm // 7/8" x 3 7/8"	D900-422



BLADE

38 x 152 mm // 1½" x 6"	D900-430
51 x 152 mm // 2" x 6"	D900-432
76 x 152 mm // 3" x 6"	D900-434



KOCHER

25 x 25 mm // 1" x 1"	D900-450
51 x 25 mm // 2" x 1"	D900-452
102 x 25 mm // 4" x 1"	D900-454



RICHARDSON

19 x 25 mm // 3/4" x 1"	D900-462
19 x 51 mm // 3/4" x 2"	D900-464
25 x 32 mm // 1" x 1 1/4"	D900-466
Satz // Set	D900-460



SCOVILLE

50 mm	D900-470
83 mm	D900-472



VAGINAL LATERAL

25 x 86 mm
D900-484



VAGINAL POSTERIOR

25 x 114 mm
D900-486



KELLY VEIN

76 x 21 mm // 3" x 3/4"	D900-490
102 x 51 mm // 4" x 3/4"	D900-491
127 x 21 mm // 5" x 3/4"	D900-492
152 x 21 mm // 6" x 3/4"	D900-493
178 x 21 mm // 7" x 3/4"	D900-494
204 x 21 mm // 8" x 3/4"	D900-495

Art.-Nr. <i>Item No.</i>	Set small D900-901 Qty	Standard-Set D900-903 Qty	Spinal-Set D900-905 Qty	Rectal-Set D900-907 Qty	Vaginal-Set D900-909 Qty
D900-108					
D900-110	1			1	
D900-130					1
D900-152		1			
D900-160			1		
D900-186			1		
D900-187			1		
D900-188			1		
D900-201		2	6		
D900-203		6	4		4
D900-210		1	1		1
D900-215		1	1		1
D900-230		1	1		1
D900-235		1			
D900-302					
D900-304					
D900-312					1
D900-314					1
D900-320	1	1			
D900-330		1			
D900-372	1				
D900-374	1				
D900-383		2			
D900-384		1			
D900-386		1			
D900-388		1			
D900-400			2		
D900-402			2		
D900-404			2		
D900-410			2		
D900-412			2		
D900-414					
D900-420				2	
D900-422				2	
D900-430		1			
D900-432		2			
D900-434		1			
D900-470			2		
D900-484			2		2
D900-486					1

Pinzetten

// Forceps

Inhalt

Index

Abschnitt **F**
// Section

Anat. Pinzetten <i>Dressing Forceps</i>	F2 - F7
Chirurgische Pinzetten <i>Tissue Forceps</i>	F8 - F13
Diverse Pinzetten <i>Various Forceps</i>	F14 - F15
Splitterpinzetten, Splitterzangen <i>Splinter forceps</i>	F16
Feine Pinzetten <i>Fine Forceps</i>	F17
Ohr-, und Nasenpinzetten <i>Ear- and Nasal forceps</i>	F18
Mikropinzetten <i>Micro forceps</i>	F19 - F26
Atraumatische Pinzetten <i>Atraumatic forceps</i>	F27 - F29

Anat.Pinzetten Dressing Forceps

- D** Diamantiert // *Diamond Jaw*
- N** Titan // *Titanium*
- ND** Titan - Diamantiert // *Titanium - Diamond Jaw*
- NT** Titan TC // *Titanium TC*
- T** TC
- U** Debakey Zahnung // *Debakey Jaws*
- X** Kreuzgerieft // *Cross serrated*



	Standard	gebogen <i>curved</i>	schmal <i>narrow</i>	gebogen <i>curved</i>	fein <i>fine</i>	Stille
10,5 cm // 4 1/4"	F100-10	F101-10	F106-10	F107-10	-	F109-10
11,5 cm // 4 1/2"	F100-11	F101-11	F106-11	F107-11	F108-11	F109-11
13 cm // 5"	F100-13	F101-13	F106-13	F107-13	F108-13	F109-13
13 cm // 5"	F100-13T	-	-	-	-	-
13 cm // 5"	F100-13X	-	-	-	-	-
14,5 cm // 5 3/4"	F100-14	F101-14	F106-14	F107-14	F108-14	-
14,5 cm // 5 3/4"	F100-14T	-	-	-	-	-
14,5 cm // 5 3/4"	F100-14X	-	-	-	-	-
15 cm // 6"	F100-15	F101-15	F106-15	F107-15	F108-15	F109-15
15 cm // 6"	F100-15N	-	-	-	-	-
16 cm // 6 1/4"	F100-16	F101-16	F106-16	F107-16	F108-16	-
16 cm // 6 1/4"	F100-16T	-	-	-	-	-
16 cm // 6 1/4"	F100-16X	-	-	-	-	-
17 cm // 6 3/4"	F100-17N	-	-	-	-	F109-17
18 cm // 7"	F100-18	F101-18	F106-18	F107-18	F108-18	-
18 cm // 7"	F100-18T	-	-	-	-	-
20 cm // 8"	F100-20	F101-20	F106-20	F107-20	F108-20	F109-20
20 cm // 8"	F100-20N	-	-	-	-	-
20 cm // 8"	F100-20T	-	-	-	-	-
23 cm // 9"	F100-23	-	-	-	-	-
23 cm // 9"	F100-23T	-	-	-	-	-
25 cm // 10"	F100-25	F101-25	F106-25	F107-25	F108-25	F109-25
25 cm // 10"	F100-25T	-	-	-	-	-
30 cm // 12"	F100-30	F101-30	F106-30	F107-30	F108-30	F109-30
30 cm // 12"	F100-30T	-	-	-	-	-

Anat. Pinzetten Dressing Forceps



	MOD. USA	MOD. USA	ENGL. MODELL
		schmal narrow	
12 cm // 4 3/4"	F110-12	F112-12	-
13 cm // 5"	F110-13	F112-13	F114-13
14,5 cm // 5 1/2"	F110-14	F112-14	-
15 cm // 6"	F110-15	F112-15	F114-15
18 cm // 7"	F110-18	-	-
21 cm // 8 1/4"	F110-21	-	-
25 cm // 10"	F110-25	-	-
30 cm // 12"	F110-30	-	-

OCHSNER
14,5 cm // 5 1/2"
F117-14



X = kreuzgerieft
X = cross serrated



U = Adson-DeBakey
U = Adson-DeBakey

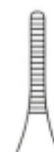

	Standard	gewinkelt angled			
	ADSON	ADSON	ADSON- EWALD	MICRO- ADSON	JACOBSEN- ADSON
12 cm // 4 3/4"	F120-12	F121-12	F122-12	F124-12	F128-12
12 cm // 4 3/4"	F120-12D	-	-	-	-
12 cm // 4 3/4"	F120-12N	-	-	-	-
12 cm // 4 3/4"	F120-12NT	-	-	-	-
12 cm // 4 3/4"	F120-12T	-	-	F124-12T	-
12 cm // 4 3/4"	F120-12U	-	-	-	-
12 cm // 4 3/4"	F120-12X	-	-	-	-
glatt smooth	F120-52T	-	-	-	-
12 cm // 4 3/4"					
15 cm // 6"	F120-15	-	-	F124-15	F128-15
15 cm // 6"	F120-15T	-	-	F124-15T	-
15 cm // 6"	F120-15U	-	-	-	-

Pinzetten // Forceps

- D** Diamantiert // *Diamond Jaw*
- N** Titan // *Titanium*
- ND** Titan - Diamantiert // *Titanium - Diamond Jaw*
- NT** Titan TC // *Titanium TC*
- T** TC
- U** Debaquey Zahnung // *Debaquey Jaws*
- X** Kreuzgerieft // *Cross serrated*

Anat.Pinzetten *Dressing Forceps*

Fadenpinzetten *Ligature forceps*



ADSON-LIGHT
12 cm // 4 3/4"
F120-12A



ADSON
12 cm // 4 3/4"
1 mm | **F130-12**
2 mm | **F130-52**



MCINDOE
15 cm // 6"
F136-15
F136-15D
F136-15N
F136-15ND
F136-15T



GILLIES
15 cm // 6"
F138-15



SEMKEN

12 cm // 4 3/4"	F140-12	F141-12
15 cm // 6"	F140-15	F141-15
15 cm // 6"	F140-15T	-



MIKRO (TURNER)
15,5 cm // 6"



0,6 mm	F143-06
0,8 mm	F143-08
1,0 mm	F143-10

Anat.Pinzetten Dressing Forceps



gerade
straight
10,5 cm // 4 1/4"

F144-10



leicht gebogen
slightly curved

F144-10A



stark gebogen
strong curved

F144-10B



TAYLOR
17,5 cm // 7"

F150-17 | **F151-17**



TAYLOR

17,5 cm // 7"	F152-17
17,5 cm // 7"	F152-17T
20 cm // 8"	F152-20T



TAYLOR

17,5 cm // 7"	F154-17
17,5 cm // 7"	F154-17U
20 cm // 8"	F154-20
20 cm // 8"	F154-20U



WAUGH

15,5 cm // 6"	F156-15
18 cm // 7"	F156-18
20 cm // 8"	F156-20



glatt
smooth



gewinkelt
angled
20 cm // 8"

F159-20

18 cm // 7"	F158-18
20 cm // 8"	F158-20

Pinzetten // Forceps

Anat.Pinzetten Dressing Forceps

- D** Diamantiert // *Diamond Jaw*
- N** Titan // *Titanium*
- ND** Titan - Diamantiert // *Titanium - Diamond Jaw*
- NT** Titan TC // *Titanium TC*
- T** TC
- U** Debakey Zahnung // *Debakey Jaws*
- X** Kreuzgerieft // *Cross serrated*



BROPHY
20 cm // 8"



F160-20



F161-20



DUEHRSEN
20 cm // 8"
F162-20



GERALD



gerade
straight

F168-68D

gebogen
curved

F168-68D



X = kreuzgerieft
X = *cross serrated*

18 cm // 7"	F168-18	F169-18
18 cm // 7"	F168-18D	F169-18D
18 cm // 7"	F168-18N	-
18 cm // 7"	F168-18ND	-
18 cm // 7"	F168-18NU	-
18 cm // 7"	F168-18T	-
18 cm // 7"	F168-18U	-
18 cm // 7"	F168-18X	-
20 cm // 8"	F168-20D	-
20 cm // 8"	F168-20NU	-
20 cm // 8"	F168-20U	-
21 cm // 8 1/4"	F168-21N	-
23 cm // 9"	F168-23	-
23 cm // 9"	F168-23D	-
25 cm // 10"	F168-25X	-



GERALD
Titan

Mit Fadenbank
With Platform

18 cm // 7"	F170-18N
18 cm // 7"	F170-18ND
21 cm // 8 1/4"	F170-21N
21 cm // 8 1/4"	F170-21ND



POTTS-SMITH

15 cm // 6"	F180-15T	-
18 cm // 7"	F180-18	F181-18
18 cm // 7"	F180-18N	-
18 cm // 7"	F180-18T	-
20 cm // 8"	F180-20N	-
20 cm // 8"	F180-20T	-
21 cm // 8 1/4"	F180-21	F181-21
23 cm // 9"	F180-23T	-
25 cm // 10"	F180-25	F181-25
25 cm // 10"	F180-25T	-
30 cm // 12"	F180-30	-



CUSHING
18 cm // 7"

F184-18	F185-18
F184-18N	-
F184-18T	-

Anat.Pinzetten
Dressing Forceps



CUSHING
18 cm // 7"
F187-18T



CUSHING-TAYLOR
18 cm // 7"
F188-18T



GRÜNWALD
18 cm // 7"
F189-18T



WANGENSTEIN

15 cm // 6"	F190-15T
23 cm // 9"	F190-23T
25 cm // 10"	F190-25T



BONNEY
18 cm // 7"
F192-18
F192-18T

Pinzetten // Forceps

Chirurgische Pinzetten Tissue Forceps

- D** Diamantiert // *Diamond Jaw*
- N** Titan // *Titanium*
- ND** Titan - Diamantiert // *Titanium - Diamond Jaw*
- NT** Titan TC // *Titanium TC*
- T** TC
- U** Debakey Zahnung // *Debakey Jaws*
- X** Kreuzgerieft // *Cross serrated*

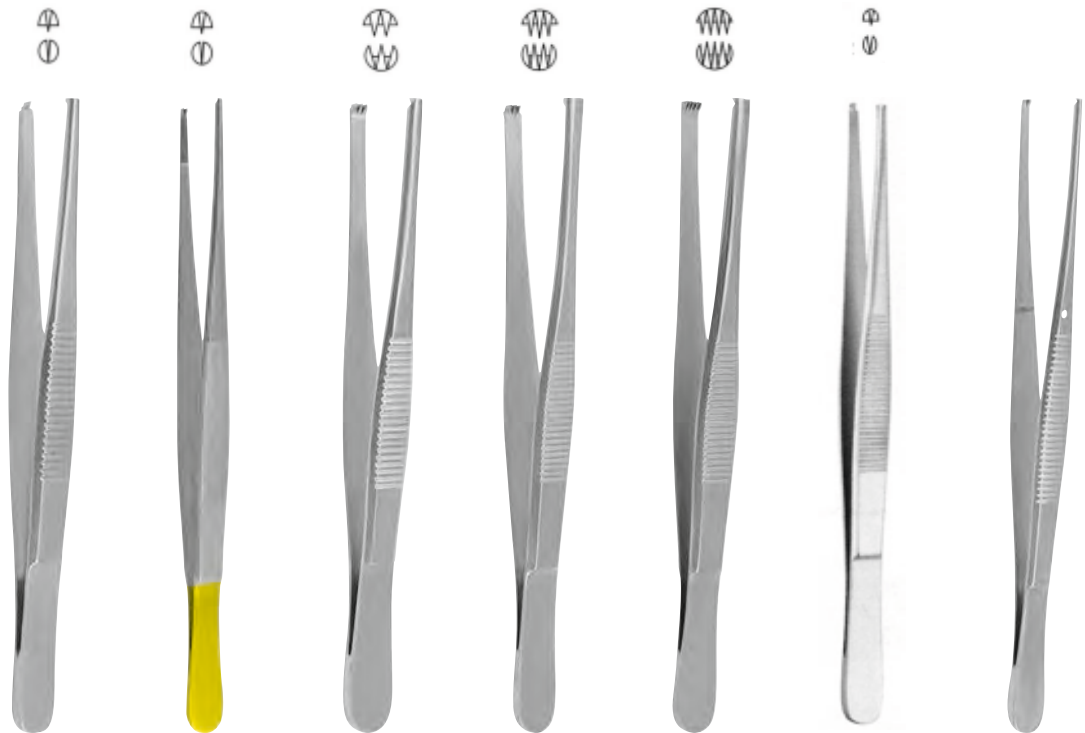

	Standard	Oehler / TC	2 x 3 Zähne 2 x 3 teeth	3 x 4 Zähne 3 x 4 teeth	4 x 5 Zähne 4 x 5 teeth	schmal <i>narrow</i>	fein <i>fine</i>
10,5 cm // 4 1/4"	F300-10	-	-	-	-	F306-10	-
11,5 cm // 4 1/2"	F300-11	-	F302-11	-	-	F306-11	F308-11
13 cm // 5"	F300-13	-	F302-13	F303-13	-	F306-13	F308-13
14,5 cm // 5 3/4"	F300-14	F300-14T	F302-14	F303-14	F304-14	F306-14	F308-14
15 cm // 6"	F300-15	-	-	F303-15	F304-15	-	-
15 cm // 6"	F300-15N	-	-	-	-	-	-
16 cm // 6 1/4"	F300-16	F300-16T	F302-16	-	-	F306-16	F308-16
17 cm // 6 3/4"	F300-17N	-	-	-	-	-	-
18 cm // 7"	F300-18	F300-18T	F302-18	F303-18	-	F306-18	F308-18
20 cm // 8"	F300-20	F300-20T	F302-20	F303-20	F304-20	F306-20	F308-20
23 cm // 9"	F300-23	-	-	-	-	-	-
25 cm // 10"	F300-25	F300-25T	F302-25	F303-25	-	F306-25	-
30 cm // 12"	F300-30	F300-30T	F302-30	F303-30	-	F306-30	-

Chirurgische Pinzetten Tissue Forceps



	MOD. USA	2 x 3 Zähne 2 x 3 teeth	3 x 4 Zähne 3 x 4 teeth	schmal narrow
12 cm // 4 3/4"	F310-12	F312-12	-	F316-12
13 cm // 5"	F310-13	F312-13	-	F316-13
14,5 cm // 5 3/4"	F310-14	F312-14	F314-14	F316-14
15 cm // 6"	F310-15	-	-	F316-15
18 cm // 7"	F310-18	F312-18	-	-
21 cm // 8 1/4"	F310-21	F312-21	-	-
25 cm // 10"	F310-25	F312-25	-	-
31 cm // 12 1/4"	-	F312-31	-	-



X = kreuzgerieft
X = cross serrated



ADSON



	1 x 2 Zähne 1 x 2 teeth		2 x 3 Zähne 2 x 3 teeth	ADSON- EWALD	MICRO- ADSON
12 cm // 4 3/4"	F320-12	F321-12	F322-12	F324-12	F326-12
12 cm // 4 3/4"	F320-12A	-	-	-	-
12 cm // 4 3/4"	F320-12N	-	-	-	F326-12N
12 cm // 4 3/4"	F320-12ND	-	-	-	-
12 cm // 4 3/4"	F320-12T	-	-	-	F326-12T
12 cm // 4 3/4"	F320-12TN	-	-	-	-
12 cm // 4 3/4"	F320-12X	-	-	-	-
15 cm // 6"	F320-15	-	F322-15	-	F326-15
15 cm // 6"	F320-15T	-	-	-	F326-15T

D	<input type="checkbox"/>	Diamantiert // <i>Diamond Jaw</i>
N	<input type="checkbox"/>	Titan // <i>Titanium</i>
ND	<input type="checkbox"/>	Titan - Diamantiert // <i>Titanium - Diamond Jaw</i>
NT	<input type="checkbox"/>	Titan TC // <i>Titanium TC</i>
T	<input type="checkbox"/>	TC
U	<input type="checkbox"/>	Debaquey Zahnung // <i>Debaquey Jaws</i>
X	<input type="checkbox"/>	Kreuzgerieft // <i>Cross serrated</i>

Chirurgische Pinzetten

Tissue Forceps

Mit Fadenbank
With Platform



ADSON-LIGHT
12 cm // 4 3/4"
F320-12A

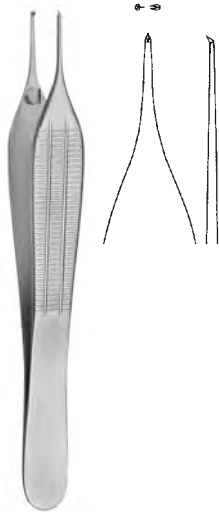

MICRO-ADSON-BEAMER
12 cm // 4 3/4"
F326-12A



ADSON
F328-12



ADSON-BROWN

12 cm // 4 3/4"	F330-12	F331-12
12 cm // 4 3/4"	F330-12N	-
12 cm // 4 3/4"	F330-12T	-
15 cm // 6"	F330-15	-
15 cm // 6"	F330-15T	-



MCINDOE
15 cm // 6"
F336-15



GILLIES
15 cm // 6"
F338-15
F338-15N
F338-15T



SEMKEN

MICRO-SEMKEN



SEMKEN



	SEMKEN	MICRO-SEMKEN	SEMKEN	
	Standard		Standard	2 x 3 Zähne <i>2 x 3 teeth</i>
12 cm // 4 3/4"	F340-12	F340-52	F341-12	F342-12
15 cm // 6"	F340-15	F340-55	F341-15	F342-15
15 cm // 6"	F340-15T	-	-	-

Chirurgische Pinzetten Tissue Forceps

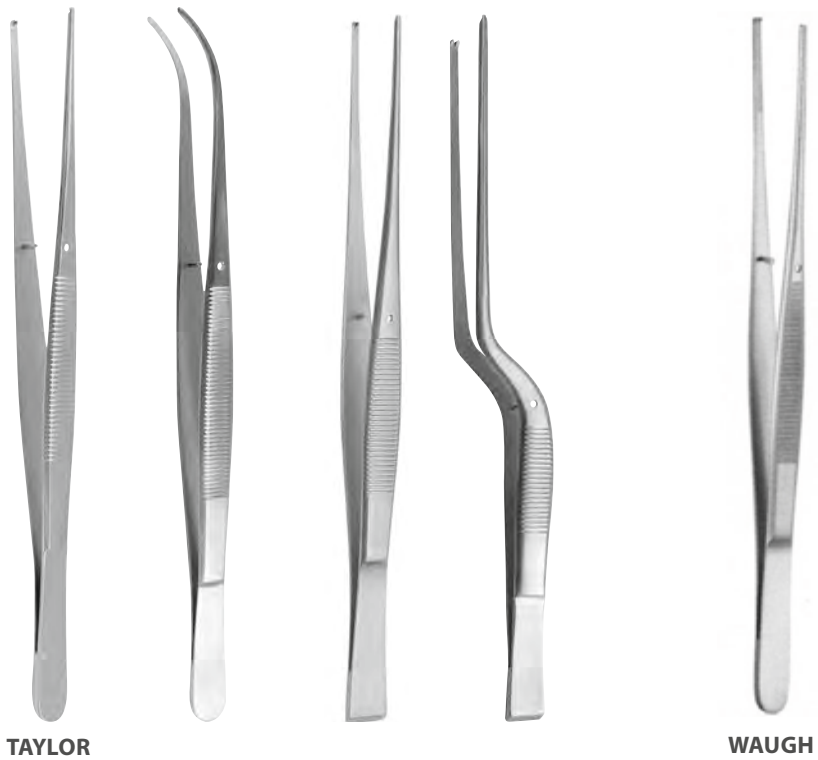
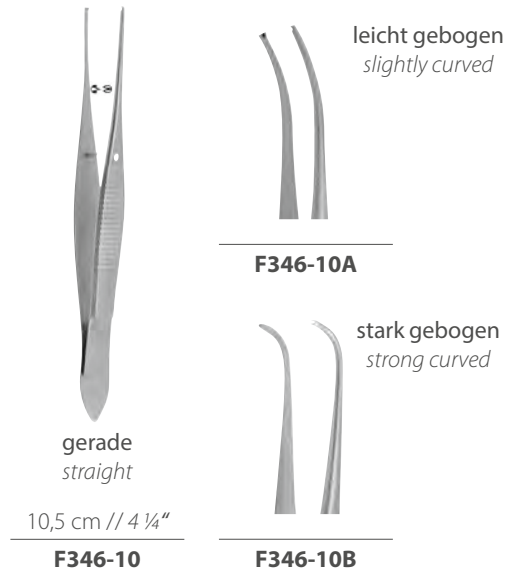
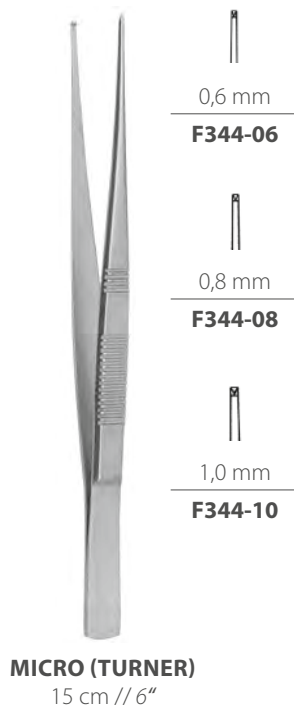

15 cm // 6"	F356-15
18 cm // 7"	F356-18
20 cm // 8"	F356-20
25 cm // 10"	F356-25
30 cm // 12"	F356-30

17,5 cm // 7"	F350-17	F351-17	F352-17	F354-17
20 cm // 8"	-	-	-	F354-20

Chirurgische Pinzetten
Tissue Forceps



BROPHY
20 cm // 8"



F360-20



F361-20



GERALD



18 cm // 7"	F368-18	F369-18	F365-18
18 cm // 7"	F368-18N	F369-18T	-
18 cm // 7"	F368-18T	-	-
23 cm // 9"	F368-23	-	-



POTTS-SMITH

18 cm // 7"	F380-18	F381-18
18 cm // 7"	F380-18N	-
20 cm // 8"	F380-20N	-
21 cm // 8 1/4"	F380-21	F381-21
25 cm // 10"	F380-25	F381-25
30 cm // 12"	F380-30	-



F385-18



CUSHING
18 cm // 7"
F384-18
F384-18T

Chirurgische Pinzetten Tissue Forceps



LANE



	1 x 2 Zähne 1 x 2 teeth	2 x 3 Zähne 2 x 3 teeth
14 cm // 5 1/2"	F400-14	F402-14
20 cm // 8"	F400-20	F402-20



FERRIS-SMITH
18 cm // 7"



1 x 2 Zähne
1 x 2 teeth

F404-18

F404-18T



2 x 3 Zähne
2 x 3 teeth

F405-18

F405-18T



BONNEY
18 cm // 7"



1 x 2 Zähne
1 x 2 teeth

F406-18

F406-18T



2 x 3 Zähne
2 x 3 teeth

F407-18

-



STONE
15 cm // 6"
F408-15



LERCHE
15 cm // 6"
F409-15



TREVES
13 cm // 5" **F412-14**
15 cm // 6" **F412-20**



STILLE-BARRAYA
18 cm // 7" **F414-18**
20 cm // 8" **F414-20**
20 cm // 8" **F414-20N**
25 cm // 10" **F414-25**



ADLERKREUTZ
15 cm // 6" **F416-15**
20 cm // 8" **F416-20**
25 cm // 10" **F416-25**
2 x 3 Zähne
2 x 3 teeth **F418-15**
3 x 4 Zähne
3 x 4 teeth **F418-20**
F418-25

Diverse Pinzetten
Various Forceps



BROWN

15 cm // 6"	F420-15
20 cm // 8"	F420-20
25 cm // 10"	F420-25



DURANTE

14,5 cm // 5 1/2"	F423-14
15 cm // 6 1/4"	F423-16
20 cm // 8"	F423-20



RUSS. MODELL

15 cm // 6"	F424-15
20 cm // 8"	F424-20
25 cm // 10"	F424-25



MAYO
23 cm // 9"
F426-23

RESANO
23 cm // 9"
F427-23
F427-23N



MARSCHIK
22 cm // 8 3/4"
F428-22



NELSON

15 cm // 6"	F430-15
18 cm // 7"	F430-18
23 cm // 9"	F430-23



SINGLEY-TUTTLE

18 cm // 7"	F432-18
23 cm // 9"	F432-23



SELMAN

15 cm // 6"	F435-15
20 cm // 8"	F435-20
25 cm // 10"	F435-25

Diverse Pinzetten Various Forceps



DUVAL
14,5 cm // 5 1/2"
F438-14



COLLIN-DUVAL
20 cm // 8"
F439-20



ZIEGLER
8,5 cm // 3 1/4"
F442-08



BARRAQUER
10,5 cm // 4"
F443-08



BEER
8 cm // 3" | **F446-08**
9 cm // 3 1/2" | **F446-09**



DOUGLAS
9 cm // 3 1/2"
F447-09



9 cm // 3 1/2"
F449-09



SHAAF
9 cm // 3 1/2"
F450-09



GRADLE
9 cm // 3 1/2"
F451-09



KUEHNE
10,5 cm // 4 1/4"

gerade
straight
F456-10

gebogen
curved
F457-10



HENRY
12 cm // 4 3/4"
F458-12



BEAUPRE
12 cm // 4 3/4"
F459-12

Splitterpinzetten, Splitterzangen
Splinter forceps



	gerieft <i>serrated</i>	glatt <i>smooth</i>	gerieft <i>serrated</i>	glatt <i>smooth</i>
8 cm // 3"	F460-08	F460-08X	F461-08	F461-08X
9 cm // 3 1/2"	F460-09	F460-09X	F461-09	F461-09X
10 cm // 4"	F460-10	F460-10X	F461-10	F461-10X
11 cm // 4 1/4"	F460-11	F460-11X	F461-11	F461-11X
10 cm // 4 1/4"	F460-11	F460-12X	F461-12	F461-12X



FEILCHENFELD

7,5 cm // 3"	F465-07
9 cm // 3 1/2"	F465-09
11,5 cm // 4 1/2"	F465-11



HUNTER

10,5 cm // 4 1/4"	F466-10	F467-10
-------------------	----------------	----------------



WALTER-CARMALT
10,5 cm // 4 1/4"

F468-10 | **F469-10**

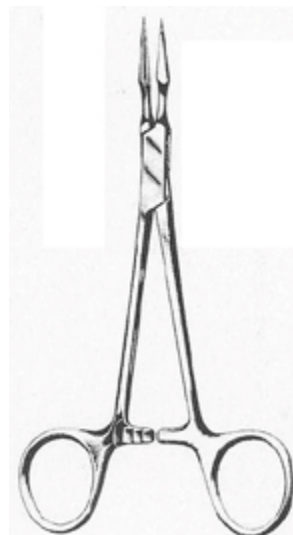

STIEGLITZ
13,5 cm // 5 1/4"

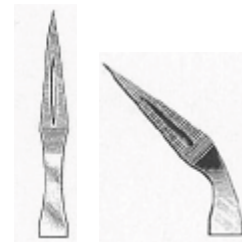

mit Sperre
with ratchet

F472-13

mit Sperre
with ratchet

F473-13

ohne Sperre
without ratchet

F472-13X

ohne Sperre
without ratchet

F473-13X



RALK
15 cm // 6"

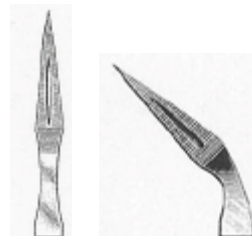

F474-15

F475-15

gewinkelt
angled



PEET
11 cm // 4 1/2"
F476-11

Feine Pinzetten Fine Forceps

Uhrmacherpinzetten
Watchmaker's forceps

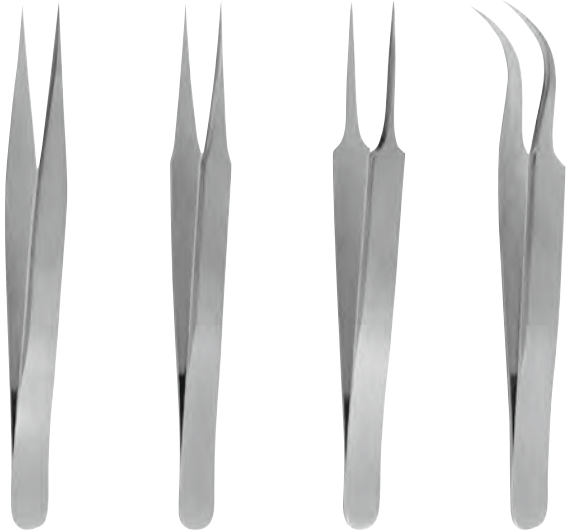

No. 3	No. 4	No. 5	No. 7
F480-03	F480-04	F480-05	F480-07

Feine Pinzetten
Fine Forceps

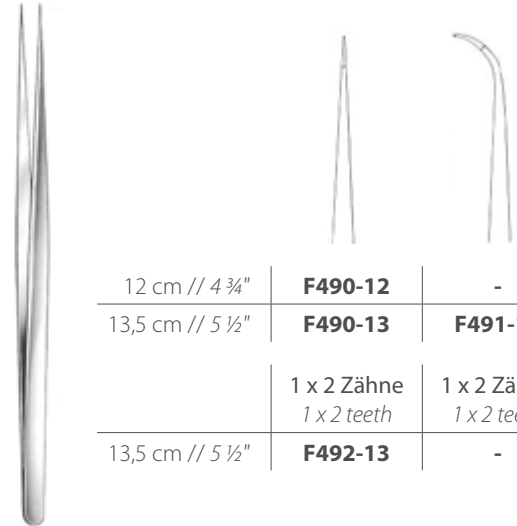

12 cm // 4 3/4"	F490-12	-
13,5 cm // 5 1/2"	F490-13	F491-13
	1 x 2 Zähne 1 x 2 teeth	1 x 2 Zähne 1 x 2 teeth
13,5 cm // 5 1/2"	F492-13	-

VISE

Gefäßdilatoren
Vessel Dilators

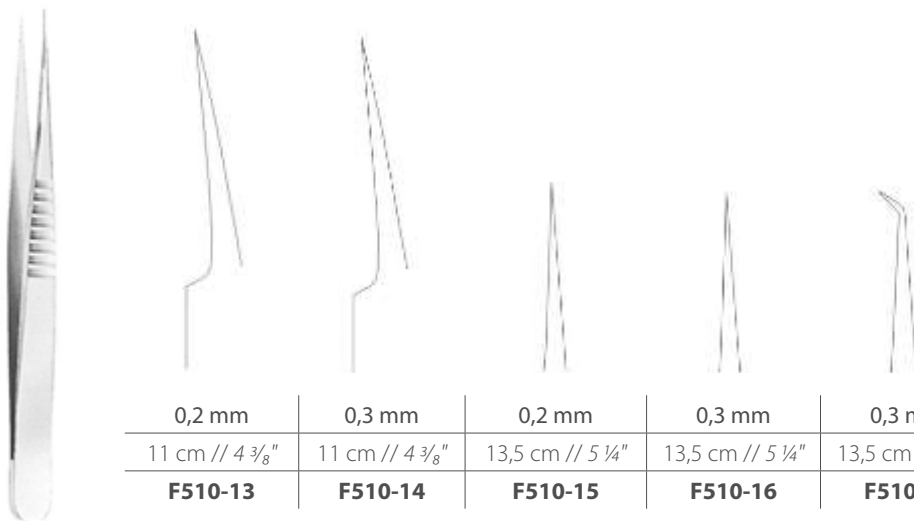

0,2 mm	0,3 mm	0,2 mm	0,3 mm	0,3 mm
11 cm // 4 3/8"	11 cm // 4 3/8"	13,5 cm // 5 1/4"	13,5 cm // 5 1/4"	13,5 cm // 5 1/4"
F510-13	F510-14	F510-15	F510-16	F510-17

- D** Diamantiert // *Diamond Jaw*
- N** Titan // *Titanium*
- ND** Titan - Diamantiert // *Titanium - Diamond Jaw*
- NT** Titan TC // *Titanium TC*
- T** TC
- U** Debakey Zahnung // *Debakey Jaws*
- X** Kreuzgerieft // *Cross serrated*

Ohr-, und Nasenpinzetten *Ear- and Nasal forceps*



11 cm // 4 1/2"	F515-11
12 cm // 4 3/4"	F515-13
15 cm // 6"	F515-15
18 cm // 7"	F515-17

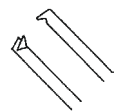

1 x 2 Zähne
1 x 2 teeth

12 cm // 4 3/4"	F519-12
-----------------	----------------

TRÖLTZSCH (WILDE)



TRÖLTZSCH
12 cm // 4 3/4"
F517-13



1 mm
F522-24



1 x 2 Zähne
1 x 2 teeth

F523-14

LUCAE
14 cm // 5 1/2"
F522-14



	JANSEN STANDARD	1 mm	1 x 2 Zähne <i>1 x 2 teeth</i>
16 cm // 6 1/4"	F526-16	F526-26	F527-16
18 cm // 7"	F526-18	F526-28	-
20 cm // 8"	F526-20	F526-30	F527-19



COTTLE
15 cm // 6"
F530-15

Columella-Pinzette
Columella forceps



COTTLE
10 cm // 4"
F535-11

Mikropinzetten, Flachgriff Micro forceps, Flat Handle



	glatt <i>smooth</i>	DEBAKEY
	0,7 mm	1,2 mm
15 cm // 6"	F550-15	F550-15U
18 cm // 7"	F550-18	F550-18U
21 cm // 8 ¼"	F550-21	F550-21U



LAZAR

	0,5 mm	0,8 mm
15,5 cm // 6"	F554-01	F554-02
18,5 cm // 7 ¼"	F554-03	-



AUSTIN

14 cm // 5 ½"	F556-14
18 cm // 7"	F556-18

- D** Diamantiert // *Diamond Jaw*
- N** Titan // *Titanium*
- ND** Titan - Diamantiert // *Titanium - Diamond Jaw*
- NT** Titan TC // *Titanium TC*
- T** TC
- U** Debaquey Zahnung // *Debaquey Jaws*
- X** Kreuzgerieft // *Cross serrated*

Mikropinzetten, Rundgriff Micro Forceps, Round handle

Mit Fadenplatte
With platform



Spitze <i>tip</i>	Länge <i>length</i>	gerade <i>straight</i>	gebogen <i>curved</i>	gerade <i>straight</i>	gebogen <i>curved</i>
0,3 mm	12 cm // 4 3/4"	F620-12	F621-12	-	-
0,3 mm	12 cm // 4 3/4"	F620-12D	F621-12D	-	-
0,3 mm	12 cm // 4 3/4"	F620-12ND	F621-12ND	-	-
0,4 mm	15 cm // 6"	F620-15	F621-15	F626-15	F627-15
0,4 mm	15 cm // 6"	F620-15D	F621-15D	F626-15D	F627-15D
0,4 mm	15 cm // 6"	F620-15N	F621-15N	F626-15N	F627-15N
0,4 mm	15 cm // 6"	F620-15ND	F621-15ND	F626-15ND	F627-15ND
0,4 mm	18 cm // 7"	F620-18	F621-18	F626-18	F627-18
0,4 mm	18 cm // 7"	F620-18D	F621-18D	F626-18D	F627-18D
0,4 mm	18 cm // 7"	F620-18N	F621-18N	F626-18N	F627-18N
0,4 mm	18 cm // 7"	F620-18ND	F621-18ND	F626-18ND	F627-18ND
0,8 mm	18 cm // 7"	F622-18	F623-18	F628-18	F629-18
0,8 mm	18 cm // 7"	F622-18D	F623-18D	F628-18D	F629-18D
0,8 mm	18 cm // 7"	F622-18N	F623-18N	F628-18N	F629-18N
0,8 mm	18 cm // 7"	F622-18ND	F623-18ND	F628-18ND	F629-18ND
0,8 mm	21 cm // 8 1/4"	F622-21	F623-21	F628-21	F629-21
0,8 mm	21 cm // 8 1/4"	F622-21D	F623-21D	F628-21D	F629-21D
0,8 mm	21 cm // 8 1/4"	F622-21N	F623-21N	F628-21N	F629-21N
0,8 mm	21 cm // 8 1/4"	F622-21ND	F623-21ND	F628-21ND	F629-21ND
0,8 mm	23 cm // 9"	F622-23	F623-23	F628-23	F629-23
0,8 mm	23 cm // 9"	F622-23D	F623-23D	F628-23D	F629-23D
0,8 mm	23 cm // 9"	F622-23N	F623-23N	F628-23N	F629-23N
0,8 mm	23 cm // 9"	F622-23ND	F623-23ND	F628-23ND	F629-23ND

Mikropinzetten Micro Forceps

Mit Fadenplatte
With platform



RHOTON-TITAN



		gerade straight	gebogen curved
0,4 mm	18 cm // 7"	F650-01N	F651-01N
0,8 mm	18 cm // 7"	F650-02N	F651-02N

Gewichtspinzetten Balanced forceps

Mit Fadenplatte
With platform



	gerade straight	gebogen curved
15 cm // 6"	F660-15D	F661-15D
15 cm // 6"	F660-15ND	F661-15ND
18 cm // 7"	F660-18D	F661-18D
18 cm // 7"	F660-18ND	F661-18ND
21 cm // 8 ¼"	F660-21D	F661-21D
21 cm // 8 ¼"	F660-21ND	F661-21ND
23 cm // 9"	F660-23D	F661-23D
23 cm // 9"	F660-23ND	F661-23ND
25 cm // 10"	F660-25D	F661-25D
25 cm // 10"	F660-25ND	F661-25ND

Pinzetten // Forceps

- D** Diamantiert // *Diamond Jaw*
- N** Titan // *Titanium*
- ND** Titan - Diamantiert // *Titanium - Diamond Jaw*
- NT** Titan TC // *Titanium TC*
- T** TC
- U** Debakey Zahnung // *Debakey Jaws*
- X** Kreuzgerieft // *Cross serrated*

Mikropinzetten Micro Forceps

Mikropinzetten
Micro Forceps



YASARGIL
22,5 cm // 9"

	löffelförmig <i>spoon-shaped</i>	flach gezahnt <i>flat serrated</i>	kürettenförmig <i>urette toothed</i>
3 mm	F667-01	F667-03	F667-05
5 mm	F667-02	F667-04	F667-06

Ringpinzetten
Ring Forceps



	1,0 x 0,5 mm	2,0 x 1,0 mm	1,0 x 0,5 mm
15 cm // 6"	F670-15D	-	-
18 cm // 7"	F670-18D	F671-18D	F671-68D
21 cm // 8 1/4"	F670-21D	-	F671-71D
23 cm // 9"	F670-23D	-	F671-73D
25 cm // 10"	F670-25D	-	-

Gewichtspinzetten
Balanced forceps



18,5 cm // 7 1/4"

F672-01	F672-02	F672-03



16 cm // 6 1/4"

glatt <i>smooth</i>	1 x 2 Zähne <i>1 x 2 teeth</i>
F673-01	F673-02

Mikropinzetten Micro Forceps



JACOBSEN

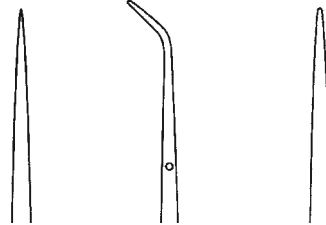

	gerade <i>straight</i>	gewinkelt <i>angled</i>	gerade <i>straight</i>	gewinkelt <i>angled</i>
	spitz <i>sharp</i>	spitz <i>sharp</i>	stumpf <i>blunt</i>	stumpf <i>blunt</i>
16 cm // 6 ¼"	F674-16	-	-	-
18 cm // 7"	F674-18	F675-18	F676-18	F677-18
18 cm // 7"	F674-18D	F675-18D	F676-18D	F677-18D



YASARGIL
22 cm // 8 ¾"

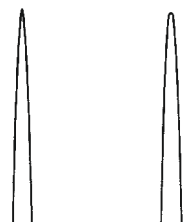

stumpf <i>blunt</i>	spitz <i>sharp</i>
F678-22	F678-32
F678-22D	F678-32D



		1,0 x 0,5 mm
21 cm // 8 ¼"	F679-21D	-
23 cm // 9"	F679-23D	F679-33D

- D** Diamantiert // *Diamond Jaw*
- N** Titan // *Titanium*
- ND** Titan - Diamantiert // *Titanium - Diamond Jaw*
- NT** Titan TC // *Titanium TC*
- T** TC
- U** Debakey Zahnung // *Debakey Jaws*
- X** Kreuzgerieft // *Cross serrated*

Ringpinzetten Ring Forceps



	gerade <i>straight</i>	gerade <i>straight</i>	gebogen <i>curved</i>	gebogen <i>curved</i>
	1,0 x 0,5 mm	2,0 x 1,0 mm	1,0 x 0,5 mm	2,0 x 1,0 mm
15 cm // 4 3/4"	F680-15A	F681-15A	-	-
15 cm // 4 3/4"	F680-15B	F681-15B	-	-
15 cm // 6"	F680-15D	F681-15D	F683-15D	F684-15D
15 cm // 6"	F680-15ND	F681-15ND	-	-
18 cm // 7"	F680-18A	F681-18A	-	-
18 cm // 7"	F680-18B	F681-18B	F683-18D	F684-18D
18 cm // 7"	F680-18D	F681-18D	-	-
18 cm // 7"	F680-18DP	-	-	-
18 cm // 7"	F680-18ND	F681-18ND	-	-
21 cm // 8 1/4"	F680-21A	F681-21A	-	-
21 cm // 8 1/4"	F680-21B	F681-21B	-	-
21 cm // 8 1/4"	F680-21D	F681-21D	F683-21D	F684-21D
21 cm // 8 1/4"	F680-21DP	-	-	-
21 cm // 8 1/4"	F680-21ND	F681-21ND	-	-
23 cm // 9"	F680-23A	F681-23A	-	-
23 cm // 9"	F680-23B	F681-23B	-	-
23 cm // 9"	F680-23D	F681-23D	F683-23D	F684-23D
23 cm // 9"	F680-23ND	F681-23ND	-	-
25 cm // 9"	F680-25D	F681-25D	F683-25D	F684-25D

DP = Fadenplatte / Ring
DP = Plattform / Ring

A = gerieft // *Serrated*

B = glatt // *smooth*

Ringpinzetten
Ring Forceps



21 cm // 8 1/4" | **F686-21D**
23 cm // 9" | **F686-23D**

Hypophysenpinzetten
Hypophyseal forceps



F695-02



F695-03

ADSON
23 cm // 9"
F695-01

Mikropinzetten Micro Forceps



	0,6 mm	0,9 mm	1 x 2 Zähne 1 x 2 teeth
16 cm // 6 1/4"	F700-16	F701-16	-
16 cm // 6 1/4"	F700-16N	F701-16N	-
18 cm // 7"	F700-18	F701-18	F702-18
18 cm // 7"	F700-18N	F701-18N	-
20 cm // 8"	F700-20	F701-20	-
20 cm // 8"	F700-20N	F701-20N	-
22 cm // 8 3/4"	F700-22	F701-22	-
22 cm // 8 3/4"	F700-22N	F701-22N	-
25 cm // 9"	F700-24	F701-24	-



		löffelförmig spoon-shaped
3 mm	22 cm // 8 3/4"	F704-223
5 mm	22 cm // 8 3/4"	F704-225
7 mm	22 cm // 8 3/4"	F704-227
3 mm	24 cm // 9 1/2"	F704-243
5 mm	24 cm // 9 1/2"	F704-245
7 mm	24 cm // 9 1/2"	F704-247



		flach gezahnt flat serrated
3 mm	16,5 cm // 6 1/2"	F705-163
5 mm	16,5 cm // 6 1/2"	F705-165
3 mm	20 cm // 8"	F705-203
5 mm	20 cm // 8"	F705-205
3 mm	22 cm // 8 3/4"	F705-223
5 mm	22 cm // 8 3/4"	F705-225
3 mm	24 cm // 9 1/2"	F705-243
5 mm	24 cm // 9 1/2"	F705-245



		kürettenförmig curette toothed
3 mm	22 cm // 8 3/4"	F706-223
5 mm	22 cm // 8 3/4"	F706-225
3 mm	24 cm // 9 1/2"	F706-243
5 mm	24 cm // 9 1/2"	F706-245

- D** Diamantiert // *Diamond Jaw*
- N** Titan // *Titanium*
- ND** Titan - Diamantiert // *Titanium - Diamond Jaw*
- NT** Titan TC // *Titanium TC*
- T** TC
- U** Debaquey Zahnung // *Debaquey Jaws*
- X** Kreuzgerieft // *Cross serrated*

Mikropinzetten
Micro Forceps



23 cm // 9"



	löffelförmig <i>spoon-shaped</i>	löffelförmig <i>spoon-shaped</i>
3 mm	F708-190	F708-195
4 mm	F708-191	F708-196
5 mm	F708-192	F708-197



3 mm	3 mm
F708-218	F708-219



3 mm	F707-01
5 mm	F707-02

HUNT
20 cm // 8"



3 mm	F709-234
5 mm	F709-236

YASARGIL
22 cm // 8 3/4"

Atraumatische Pinzetten Atraumatic forceps



DEBAKEY



	1,5 mm	2 mm	2,5 mm	2,7 mm	3,5 mm	1,5 mm	2 mm
16 cm // 6 ¼"	F712-15N	F714-16	F716-15N	F717-16	F719-15N	F721-16	F722-16
16 cm // 6 ¼"	F712-16	-	F716-16	-	F719-16	-	-
20 cm // 8"	F712-19N	F714-20	F716-19N	F717-20	F719-19N	F721-20	F722-20
20 cm // 8"	F712-20	-	F716-20	-	F719-20	-	-
24 cm // 9 ½"	F712-24	F714-24	F716-24	F717-24	F719-24	F721-24	F722-24
24 cm // 9 ½"	F712-24N	-	F716-24N	-	F719-24N	-	-
30 cm // 12"	F712-30	F714-30	F716-30	F717-30	F719-30	F721-30	F722-30



DEBAKEY
Titan

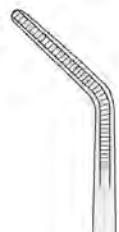

	2,5 mm
15 cm // 6"	F723-15N
19 cm // 7 ½"	F723-19N
24 cm // 9 ½"	F723-14N



DEBAKEY-DIETRICH



	1,5 mm
16 cm // 6 ¼"	F730-16
20 cm // 8"	F730-20
24 cm // 9 ½"	F730-24

- D** Diamantiert // *Diamond Jaw*
- N** Titan // *Titanium*
- ND** Titan - Diamantiert // *Titanium - Diamond Jaw*
- NT** Titan TC // *Titanium TC*
- T** TC
- U** Debakey Zahnung // *Debakey Jaws*
- X** Kreuzgerieft // *Cross serrated*

Atraumatische Pinzetten *Atraumatic forceps*



DEBAKEY TC

	1,5 mm	2,0 mm	2,7 mm	3,5 mm
16 cm // 6 ¼"	F742-16T	F743-16T	F744-16T	F745-16T
19 cm // 7 ½"	F742-19T	F743-19T	F744-19T	F745-19T
24 cm // 9 ½"	F742-24T	F743-24T	F744-24T	F745-24T

	1,2 mm	2,0 mm
18 cm // 7"	F746-18T	F746-68T
21 cm // 8 ¼"	F746-21T	F746-71T
23 cm // 9"	F746-23T	F746-73T



Mit Rundgriff
With round handle

	gerade <i>straight</i>	gerade <i>straight</i>	gewinkelt <i>angled</i>	gewinkelt <i>angled</i>
	1,2 mm	1,8 mm	1,2 mm	1,8 mm
15 cm // 6"	F750-15	F752-15	F751-15	F753-15
15 cm // 6"	F750-15N	F752-15N	F751-15N	F753-15N
18 cm // 7"	F750-18	F752-18	F751-18	F753-18
18 cm // 7"	F750-18N	F752-18N	F751-18N	F753-18N
21 cm // 8 ¼"	F750-21	F752-21	F751-21	F753-21
21 cm // 8 ¼"	F750-21N	F752-21N	F751-21N	F753-21N
23 cm // 9"	F750-23	F752-23	F751-23	F753-23
23 cm // 9"	F750-23N	F752-23N	F751-23N	F753-23N

Atraumatische Pinzetten Atraumatic forceps

Gewichtspinzetten
Balanced handle



	gerade straight	gewinkelt angled
	1,2 mm	1,2 mm
15 cm // 6"	F755-15	-
15 cm // 6"	F755-15N	F756-15N
18 cm // 7"	F755-18	-
18 cm // 7"	F755-18N	F756-18N
21 cm // 8 1/4"	F755-21	-
21 cm // 8 1/4"	F755-21N	F756-21N

DEBAKEY (DENNIS)



16 cm // 6 1/4"	F760-16
20 cm // 8"	F760-20
24 cm // 9 1/2"	F760-24

COOLEY

Klemmen

// Forceps

Inhalt

Index

Abschnitt **G**
// Section

Arterienklemmen <i>Artery Forceps</i>	G02 - G24
Hysterektomieklemmen <i>Hysterectomy Forceps</i>	G25 - G32
Tuchklemmen <i>Towel Forceps</i>	G32 - G34
Katheter-Einführungszangen <i>Catheter Forceps</i>	G34
Schwammzangen, Korn- und Tupferzangen <i>Sponge Holding Forceps, Sponge and Dressing Forceps</i>	G35 - G38
Schlauchklemmen <i>Tubing Forceps</i>	G39
Bulldogklemmen <i>Bulldog Clamps</i>	G40 - G44
Gefäßclips, Approximatoren <i>Vessel Clips, Approximators</i>	G45 - G49

Arterienklemmen
Artery Forceps



längsgerieft
longitudinal serrations

Mit DeBaKey-Zahnung
With DeBaKey-serration

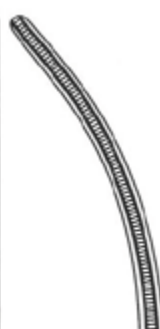
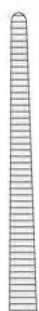

PEAN

	gerade straight	gebogen curved	gerade straight	gebogen curved	gerade straight	gebogen curved
13 cm // 5"	G100-13	G101-13	-	-	-	-
14 cm // 5 1/2"	G100-14	G101-14	-	-	G100-14U	G101-14U
16 cm // 6 1/4"	G100-16	G101-16	-	-	G100-16U	G101-16U
18 cm // 7"	G100-18	G101-18	-	-	G100-18U	G101-18U
20 cm // 8"	G100-20	G101-20	G100-520	G101-520	G100-20U	G101-20U
20 cm // 8"	-	G101-20N	-	-	-	-
22 cm // 8 3/4"	G100-22	G101-22	G100-523	G101-523	-	-
24 cm // 9 1/2"	G100-24	G101-24	G100-525	G101-525	-	-
26 cm // 10 1/4"	G100-26	G101-26	-	-	G100-26U	G101-26U
28 cm // 11"	G100-28	G101-28	-	-	G100-28U	G101-28U
30 cm // 12"	G100-30	G101-30	-	-	-	-
36 cm // 14"	-	G101-36	-	-	-	-
40 cm // 16"	-	G101-40	-	-	-	-
46 cm // 18"	-	G101-46	-	-	-	-



PEAN FINE



	gerade straight	gebogen curved
13 cm // 5"	G102-13	G103-13
14 cm // 5 1/2"	G102-14	G103-14
16 cm // 6 1/4"	G102-16	G103-16

Arterienklemmen Artery Forceps



OCHSNER-KOCHER

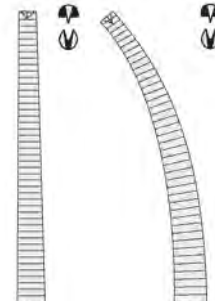

	gerade <i>straight</i>	gebogen <i>curved</i>
13 cm // 5"	G104-13	G105-13
14 cm // 5 ½"	G104-14	G105-14
16 cm // 6 ¼"	G104-16	G105-16
18 cm // 7"	G104-18	G105-18
18 cm // 7"	G104-18N	-
20 cm // 8"	G104-20	G105-20
20 cm // 8"	G104-20N	-
22 cm // 8 ¾"	G104-22	G105-22
24 cm // 9 ½"	G104-24	G105-24
26 cm // 10 ¼"	G104-26	G105-26
30 cm // 12"	G104-30	G105-30



KOCHER FINE

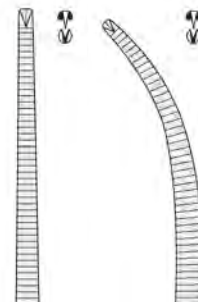

	gerade <i>straight</i>	gebogen <i>curved</i>
13 cm // 5"	G106-13	G107-13
14 cm // 5 ½"	G106-14	G107-14
16 cm // 6 ¼"	G106-16	G107-16

Arterienklemmen
Artery Forceps



KELLY
KELLY-RANKIN
KELLY-ATRAUMA

Mit DeBakey-Zahnung
With DeBakey-serration



	gerade straight	gebogen curved	gerade straight	gebogen curved
14 cm // 5 1/2"	G110-14	G111-14	-	-
16 cm // 6 1/4"	G110-16	G111-16	G110-16U	G111-16U



BABY-CRILE
14 cm // 5 1/2"



gerade
straight

gebogen
curved

G112-14

G113-14



gerade
straight

gebogen
curved

G116-14

G117-14



gerade
straight

gebogen
curved

14 cm // 5 1/2"	G114-14	G115-14
14 cm // 5 1/2"	G114-14N	G115-14N
16 cm // 6 1/4"	G114-16	G115-16
16 cm // 6 1/4"	G114-16N	G115-16N



CRILE
CRILE-RANKIN



gerade
straight

gebogen
curved

14 cm // 5 1/2"	G118-14	G119-14
14 cm // 5 1/2"	G118-14N	G119-14N
16 cm // 6 1/4"	G118-16	G119-16
16 cm // 6 1/4"	G118-16N	G119-16N

Arterienklemmen Artery Forceps



COLLER-CRILE

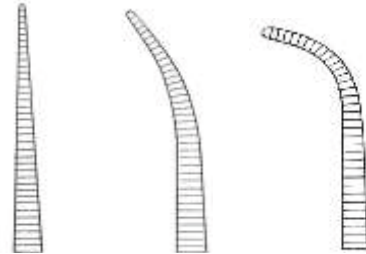

	gerade <i>straight</i>	gebogen <i>curved</i>	stark gebogen <i>strongly curved</i>
14 cm // 5 1/2"	G120-14	G121-14	-
16 cm // 6 1/4"	G120-16	G121-16	G121-26
18 cm // 7"	G120-18	G121-18	-



LERICHE
15 cm // 6"

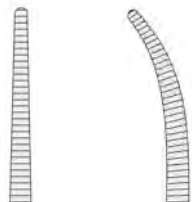

gerade <i>straight</i>	gebogen <i>curved</i>
G122-15	G123-15
G122-15N	G123-15N

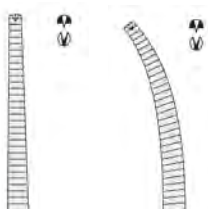

gerade <i>straight</i>	gebogen <i>curved</i>
G124-15	G125-15
G124-15N	G125-15N



PROVIDENCE
14 cm // 5 1/2"

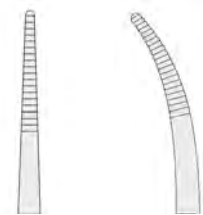

gerade <i>straight</i>	gebogen <i>curved</i>
G126-14	G127-14

Arterienklemmen
Artery Forceps

Mit DeBakey-Zahnung
With DeBakey-serration



HALSTED-MOSQUITO

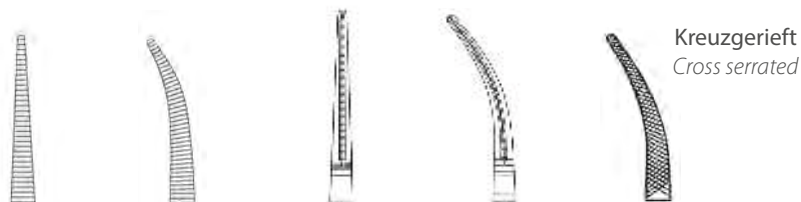

Kreuzgerieft
Cross serrated

	gerade straight	gebogen curved	gerade straight	gebogen curved	gebogen curved
12 cm // 4 3/4"	G130-12	G131-12	G130-12U	G131-12U	G131-22
12 cm // 4 3/4"	G130-12N	G131-12N	-	-	-
14 cm // 5 1/2"	G130-14	G131-14	-	-	-

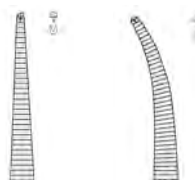

	gerade straight	gebogen curved
12 cm // 4 3/4"	G132-12	G133-12
12 cm // 4 3/4"	G132-12N	G133-12N
14 cm // 5 1/2"	G132-14	G133-14



HALSTED-MOSQUITO

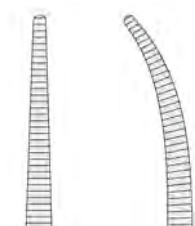

	gerade straight	gebogen curved
18 cm // 7"	G130-18	G131-18
21 cm // 8 1/4"	G130-21	G131-21

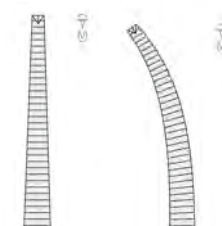

	gerade straight	gebogen curved
18 cm // 7"	G132-18	G133-18
21 cm // 8 1/4"	G132-21	G133-21

Arterienklemmen Artery Forceps



MICRO-MOSQUITO

	gerade straight	gebogen curved
10 cm // 4"	G134-10	G135-10
12 cm // 4 3/4"	G134-12	G135-12
12 cm // 4 3/4"	-	G135-12N

	gerade straight	gebogen curved
10 cm // 4"	G136-10	G137-10
12 cm // 4 3/4"	G136-12	G137-12
12 cm // 4 3/4"	-	G137-12N



HARTMANN
10 cm // 4"

	gerade straight	gebogen curved
	G140-10	G141-10
	G140-10N	G141-10N

	gerade straight	gebogen curved
	G142-10	G143-10



JACOBSEN
13 cm // 5"

	gerade straight	gebogen curved
	G146-13	G147-13

Ligaturklemme glatt
Ligature forceps, smooth



glatt
smooth
9,5 cm // 3 3/4"
G150-09



CARELL
10 cm // 4"
G151-10



TERRIER
10 cm // 4"
G152-10

Arterienklemmen
Artery Forceps



KRÖNLEIN
13 cm // 5"
G153-13



CHAPUT
13 cm // 5"
G154-13



TUFFIER
13 cm // 5"
G155-13

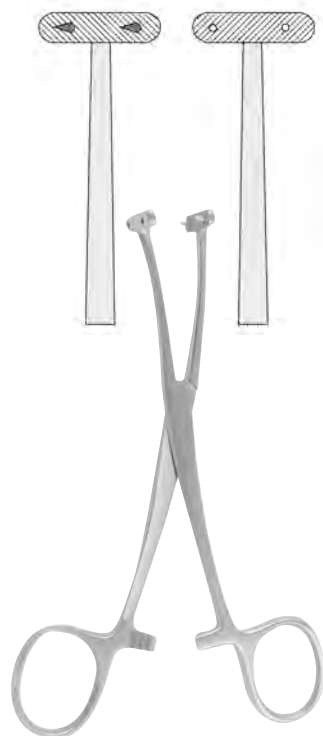

DEMARTEL
14 cm // 5"
G157-14



DEMARTEL
19 cm // 7 1/2"
G158-19



PENNINGTON
15 cm // 6" | **G160-15**
20 cm // 8" | **G160-20**

Arterienklemmen Artery Forceps



PRATT
15 cm // 6"
G162-15

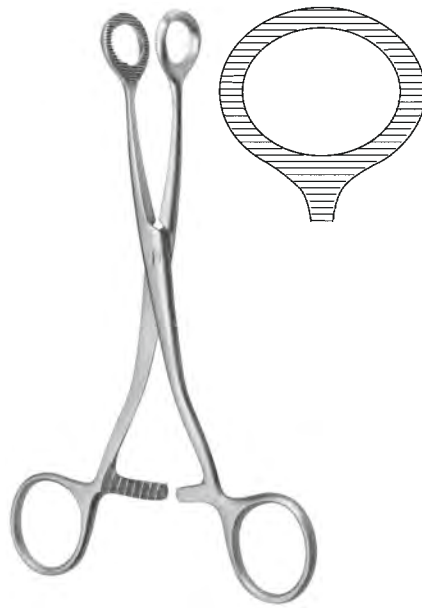

COLLIN
16 cm // 6 1/4"
G166-16



Gummipolster extra
Rubber inserts
G167-51

YOUNG
17 cm // 6 3/4"
G167-17



COLLIN
14 cm // 5 1/2"
G169-14



DUNHILL
13 cm // 5"
gerade | gebogen
straight | curved
G170-13 | **G171-13**

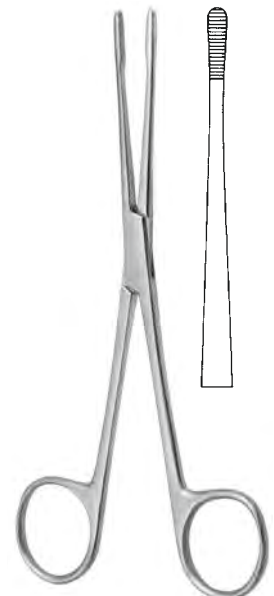

LISTER
12,5 cm // 5" | **G174-12**
16 cm // 6 1/4" | **G174-16**
18 cm // 7" | **G174-18**

Arterienklemmen
Artery Forceps

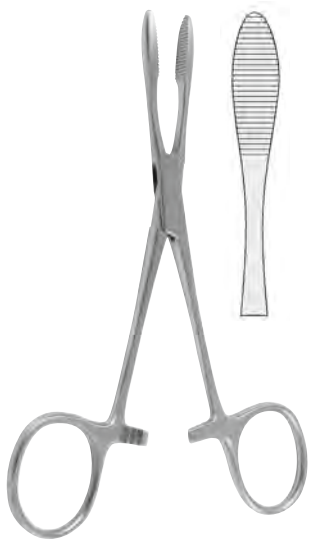

PEAN

14 cm // 5 1/2"	G177-14
16 cm // 6 1/4"	G177-16



ROCHESTER-CARMALT

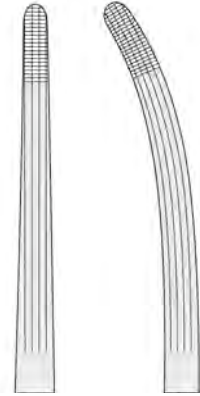

	gerade straight	gebogen curved
16 cm // 6 1/4"	G180-16	G181-16
20 cm // 8"	G180-20	G181-20



BAINBRIDGE
DEBAKEY-BAINBRIDGE

Mit DeBakey-Zahnung
With DeBakey-serration

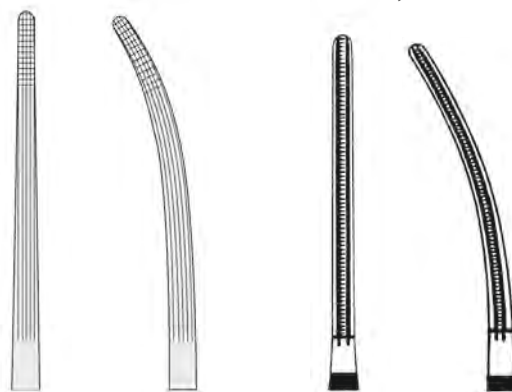

	gerade straight	gebogen curved	gerade straight	gebogen curved
15 cm // 6"	G182-15	G183-15	G182-15U	G183-15U
18 cm // 7"	G182-18	G183-18	G182-18U	G183-18U

Arterienklemmen Artery Forceps



DIXON-LOVELACE
16 cm // 6 1/4"

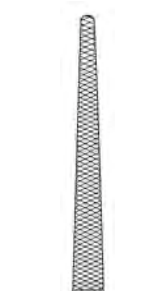

G184-16

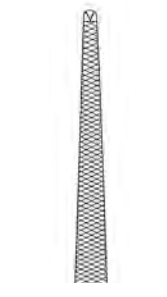

G185-16



SPENCER-WELLS

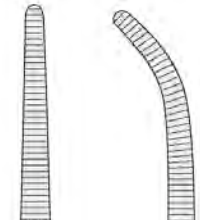

gerade
straight

gebogen
curved

13 cm // 5"	G188-13	G189-13
14 cm // 5 1/2"	G188-14	G189-14
15 cm // 6"	G188-15	G189-15
18 cm // 7"	G188-18	G189-18
20 cm // 8"	G188-20	G189-20



MOSQUITO-DANDY
12 cm // 4 3/4"

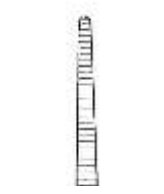

G193-12



G193-22

Kreuzgerieft
Cross serrated



DANDY



14 cm // 5 1/2" | **G193-14**

16 cm // 6 1/4" | **G193-16N**

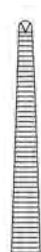

14 cm // 5 1/2"

G195-14



BABY-ADSON



14 cm // 5 1/2"

G198-14



18 cm // 7"

G198-18

Arterienklemmen
Artery Forceps

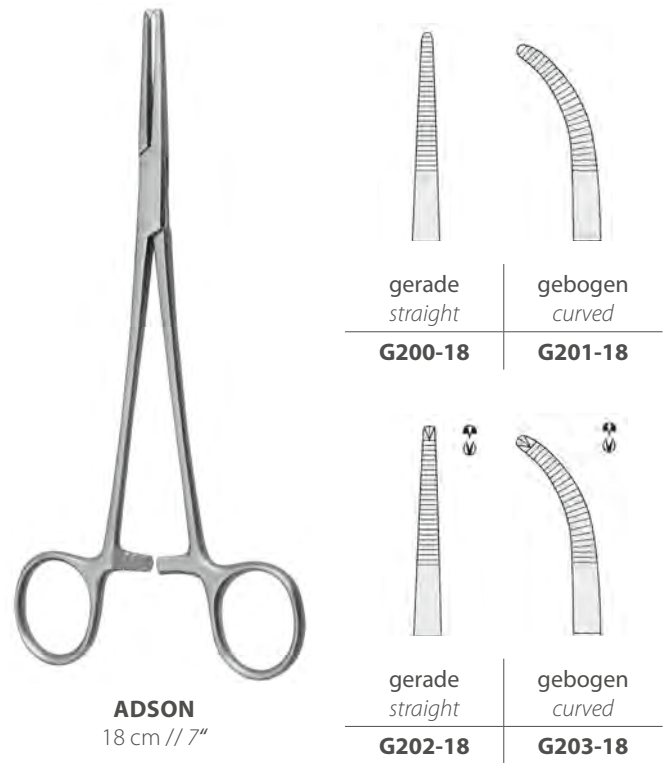
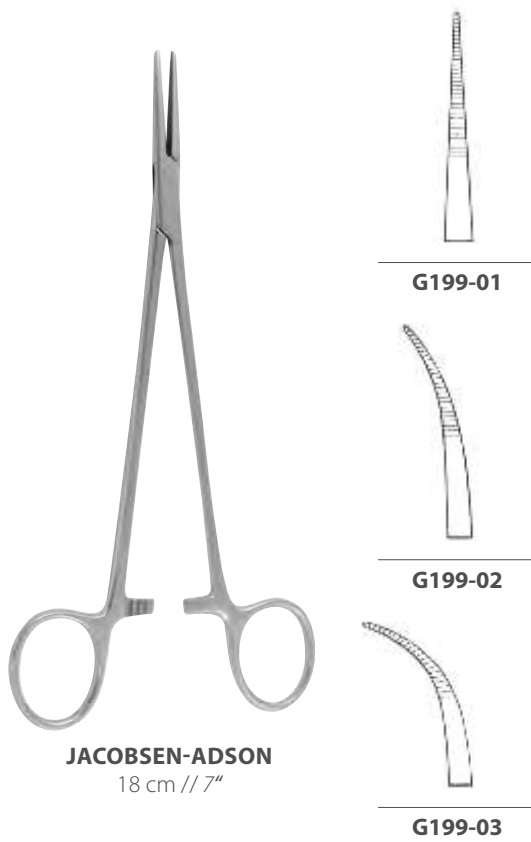

Arterienklemmen Artery Forceps



BIRKETT
19 cm // 7 1/2"



gerade
straight

G210-19



gebogen
curved

G211-19



NEGUS
19 cm // 7 1/2"

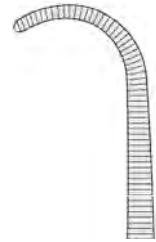

G215-01

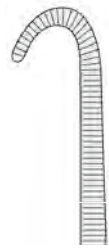

G215-02



KELLY

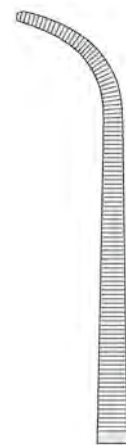
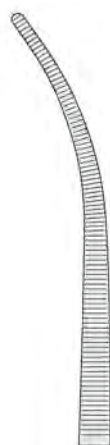

19 cm // 7 1/2"

G225-191

G225-192

G225-193

22 cm // 8 3/4"

G225-221

G225-222

G225-223

24 cm // 9 1/2"

G225-241

G225-242

G225-243

Arterienklemmen
Artery Forceps



CRAFOORD

18 cm // 7"	G230-18
24 cm // 9 1/2"	G230-24
24 cm // 9 1/2"	G230-24N

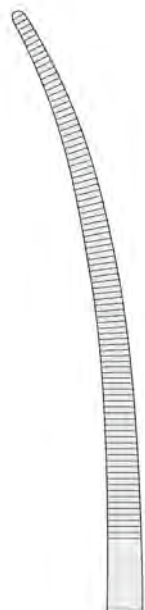

SAROT
24 cm // 9 1/2"

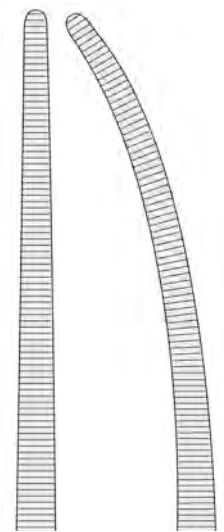

gerade straight	gebogen curved
G232-24	G233-24



HEISS
20 cm // 8"

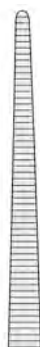

G240-01



G240-02



G240-03



G240-11



G240-12



ROBERTS
22 cm // 8 3/4"

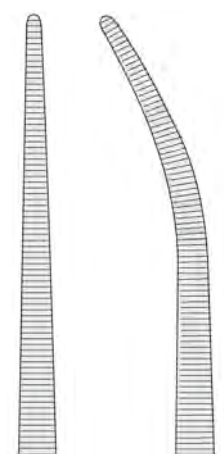

gerade straight	gebogen curved
G246-22	G247-22

Arterienklemmen Artery Forceps



RUMEL
23 cm // 9"



G245-01



G245-02

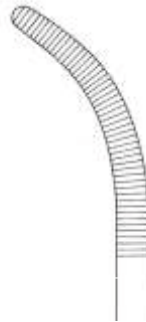

G245-03

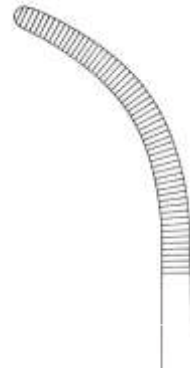

G245-04

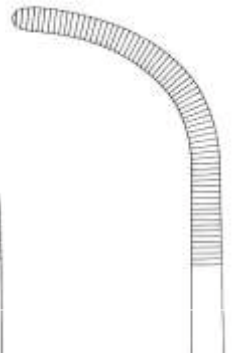

G245-05



BENGOLEA



	gerade straight	gebogen curved	gerade straight	gebogen curved
18 cm // 7"	G250-18N	G251-18N	G252-18N	G253-18N
20 cm // 8"	G250-20	G251-20	G252-20	G253-20
22 cm // 8 3/4"	G250-22	G251-22	G252-22	G253-22
23 cm // 9"	G250-23N	G251-23N	-	G253-23N
24 cm // 9 1/2"	G250-24	G251-24	G252-24	G253-24
26 cm // 10 1/4"	G250-26	G251-26	G252-26	G253-26

Arterienklemmen
Artery Forceps



CRAFOORD-SELLORS

22 cm // 8 1/2"
24 cm // 9 1/2"



G255-01

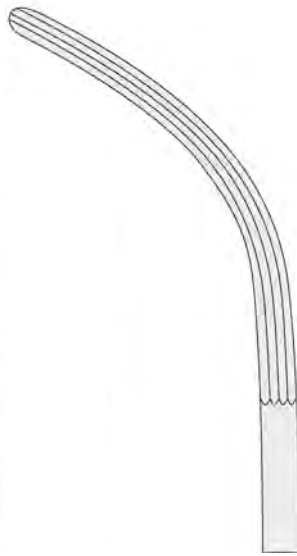

G255-02

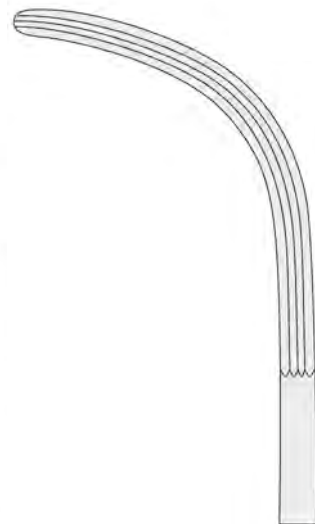

G255-03



BRIDGE

	gerade straight	gebogen curved
19 cm // 7 1/2"	G260-19	G261-19
27 cm // 10 1/2"	G260-27	G261-27



ZENKER

29,5 cm // 11 1/2"

G264-01



G264-02

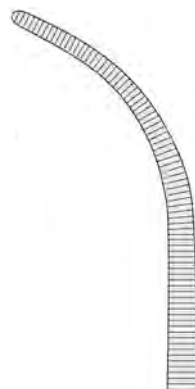

G264-03



BABY-OVERHOLT

13,5 cm // 5 1/4"

G266-14

Arterienklemmen Artery Forceps



OVERHOLT-GEISSENDÖRFER

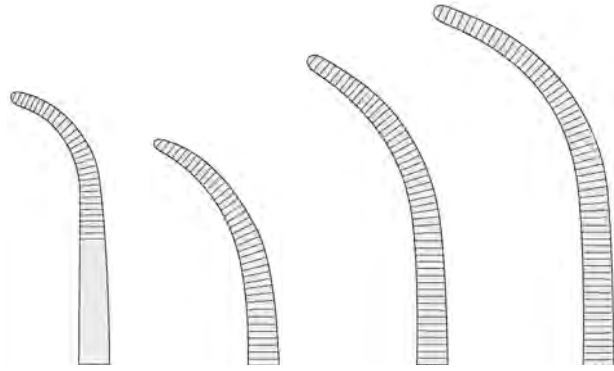

	Fig. 1	Fig. 2	Fig. 3	Fig. 4
21 cm // 8 1/4"	G270-211	G270-212	G270-213	G270-214
27 cm // 10 1/2"	G270-271	G270-272	G270-273	G270-274

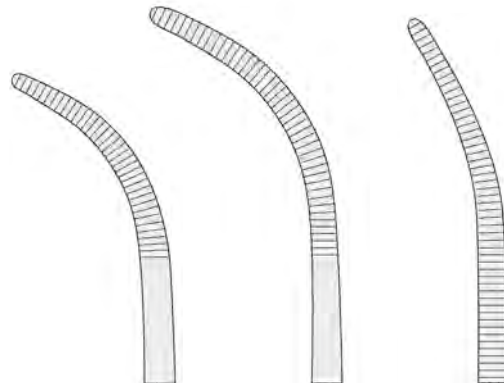

	Fig. 5	Fig. 6	Fig. 7
21 cm // 8 1/4"	G270-215	G270-216	G270-217
27 cm // 10 1/2"	G270-275	G270-276	G270-277



OVERHOLT-S



OVERHOLT-SLIM-S

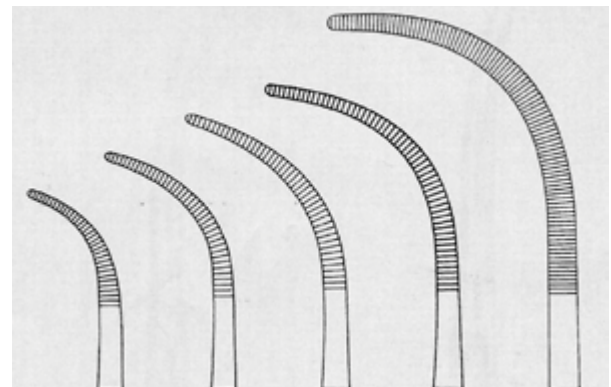

		OVERHOLT-S	OVERHOLT-SLIM-S
Fig. 1	18,5 cm // 7 1/4"	G271-01	G272-01
Fig. 2	20,5 cm // 8"	G271-02	G272-02
Fig. 3	21 cm // 8 1/4"	G271-03	G272-03
Fig. 4	21,5 cm // 8 1/2"	G271-04	G272-04
Fig. 5	24 cm // 9 1/2"	G271-05	-

Arterienklemmen
Artery Forceps



OVERHOLT-MIXTER
21 cm // 8 ¼"
G275-21

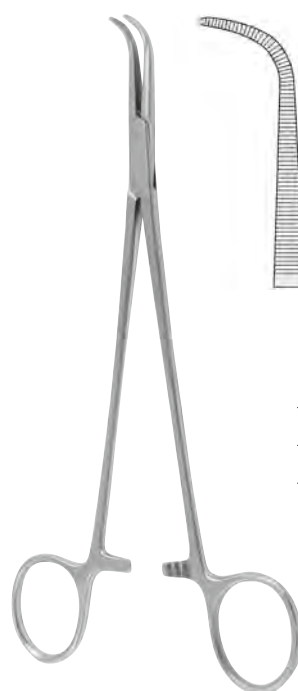

MINI-GEMINI

18 cm // 7"	G278-18
22 cm // 8 ½"	G278-22
25 cm // 10"	G278-25
28 cm // 11"	G278-28



GEMINI

13 cm // 5"	G281-13
16 cm // 6 ¼"	G281-16
18 cm // 7"	G281-18
20 cm // 8"	G281-20
23 cm // 9"	G281-23
25 cm // 10"	G281-25
28 cm // 11"	G281-28

Arterienklemmen Artery Forceps



BABY-MIXTER
14,5 cm // 5 1/2"



G297-14



G298-14



18 cm

G298-18



MCQUIGG-MIXTER
22 cm // 8 1/2"

G300-22

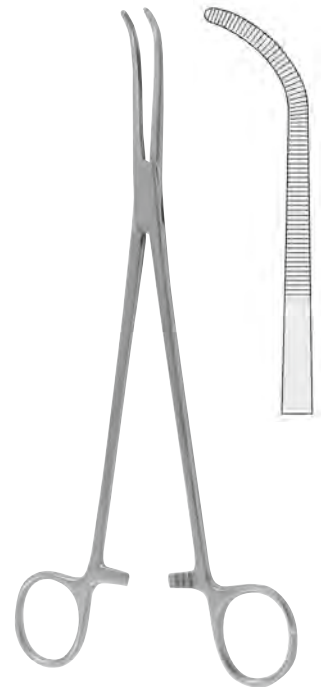

MIXTER-SLIM

18 cm // 7"

G301-18

23 cm // 9"

G301-23



MIXTER

15 cm // 6"

G305-15

19 cm // 7 1/2"

G305-19



MIXTER

22 cm // 8 1/2"

G306-22



JOHNS-HOPKINS

20 cm // 8"

G307-20

Arterienklemmen
Artery Forceps



MIXTER O'SHAUGHNESSY

15 cm // 6"	G308-15
19 cm // 7½"	G308-19



SCHNIDT-SAWTELL

19 cm // 7½"



G311-01



G311-02



SCHNIDT-SAWTELL

19 cm // 7½"



G311-11



G311-12



WICKSTRÖM

20 cm // 8"

G312-20



KANTROWITZ

16 cm // 6¼"	G314-16
19 cm // 7½"	G314-19
24 cm // 9½"	G314-24
26,5 cm // 10½"	G314-26
30 cm // 12"	G314-30
36 cm // 14"	G314-36

Arterienklemmen Artery Forceps



LAWRENCE

18,5 cm // 7 1/4"	G315-18
27,5 cm // 10 3/4"	G315-27

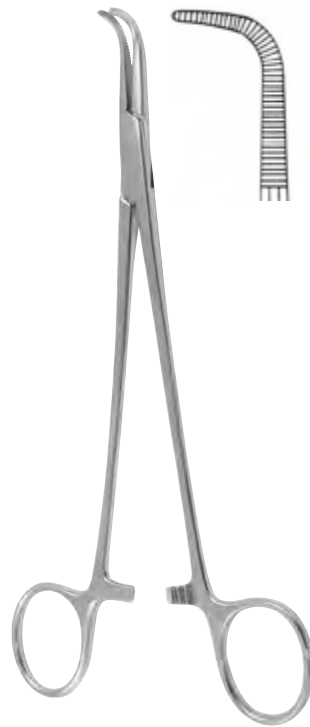

MEEKER

18 cm // 7"	G316-18
28 cm // 11"	G316-27



LOWER

18 cm // 7"
G318-18



TÖNNIS

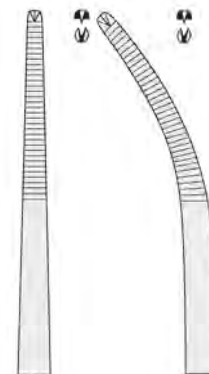
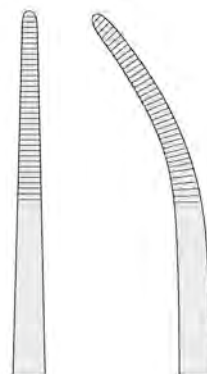

	gerade straight	gebogen curved	gerade straight	gebogen curved
21 cm // 8 1/4"	G320-21	G321-21	G322-21	G323-21
26 cm // 10 1/4"	G320-26	G321-26	G322-26	G323-26

Arterienklemmen
Artery Forceps



MIXTER

22 cm // 8 1/2"	G325-22
25 cm // 10"	G325-25
28 cm // 11"	G325-28



FINOCHIETTO

24 cm // 9 1/2"

G329-24



LAHEY

19 cm // 7 1/2"	G330-19
23 cm // 9"	G330-23



SEMB

24 cm // 9 1/2"

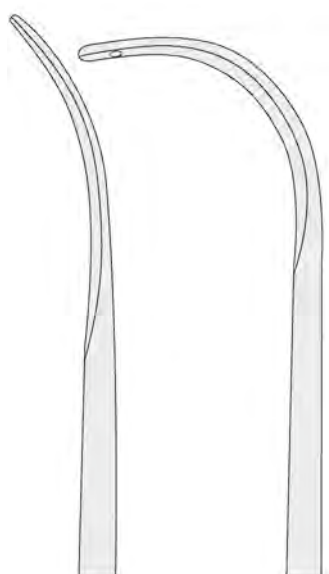

G335-01

G335-02

Arterienklemmen Artery Forceps



PRICE-THOMAS
22 cm // 8 1/2"
G336-22



Zähne links
Teeth left

G336-01



PRICE-THOMAS
22 cm // 8 1/2"

Zähne rechts
Teeth right

G336-02



LOVELACE
20 cm // 8"
G338-01

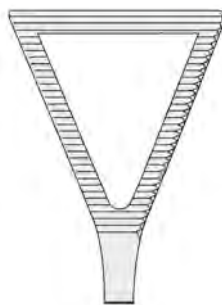

LOVELACE
20 cm // 8"
G338-02

Arterienklemmen
Artery Forceps



BABY-SATINSKY
15 cm // 6"
G340-15



SATINSKY
26,5 cm // 10 1/2"

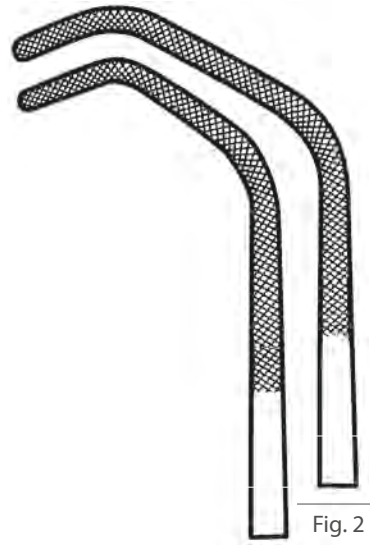

Fig. 1

Fig. 2

G340-21	Fig. 1	G340-31
G340-22	Fig. 2	G340-32



SATINSKY
26,5 cm // 10 1/2"



HARKEN
24 cm // 9 1/2"



Fig. 1

G342-01



Fig. 2

G342-02



Fig. 3

G342-03



Fig. 4

G342-04

Hysterektomieklemmen Hysterectomy Forceps



22,5 cm // 9"	22 cm // 8 3/4"	21,5 cm // 8 1/2"	21,5 cm // 8 1/2"
G350-221	G350-222	G350-223	G350-224
25 cm // 10"	24,5 cm // 9 1/4"	24 cm // 9 1/2"	24 cm // 9 1/2"
G350-251	G350-252	G350-253	G350-254

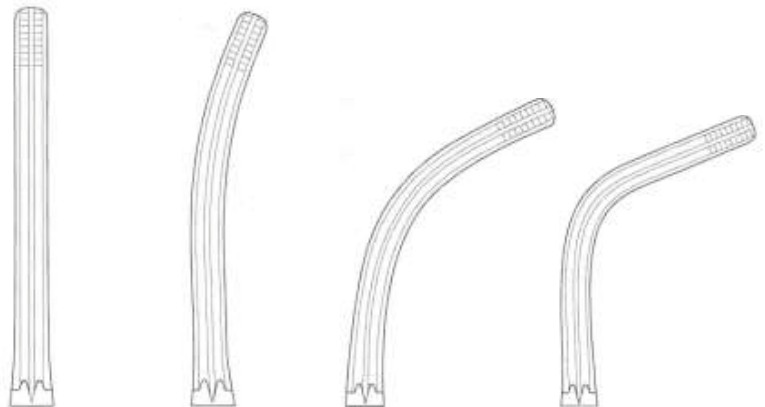

21 cm // 8 1/4"	G351-211	G351-212	G351-213	G351-214
24 cm // 9 1/2"	G351-241	G351-242	G351-243	G351-244
30 cm // 12"	G351-301	G351-302	G351-303	G351-304
35 cm // 13 3/4"	G351-351	G351-352	G351-353	G351-354
40 cm // 15 3/4"	G351-401	G351-402	G351-403	G351-404



Griff gewinkelt
Offset handle

	Fig. 1	Fig. 2	Fig. 3	Fig. 4
24 cm // 9 1/2"	G352-241	G352-242	G352-243	G352-244
30 cm // 12"	G352-301	G352-302	G352-303	G352-304
35 cm // 13 3/4"	G352-351	G352-352	G352-353	G352-354

Hysterektomieklemmen
Hysterectomy Forceps



HEANEY

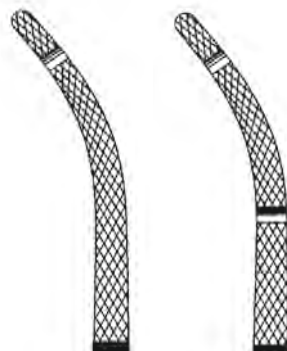

19,5 cm // 7 1/2"	G361-19	G362-19
21 cm // 8 1/4"	G361-21	G362-21
23 cm // 9"	G361-23	G362-23



HEANEY-SLIM

21 cm // 8 1/4"

G363-21



HEANEY-BALLENTINE

21 cm // 8 1/4"

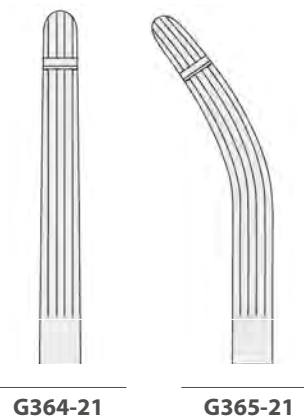

G364-21

G365-21

Hysterektomieklemmen Hysterectomy Forceps

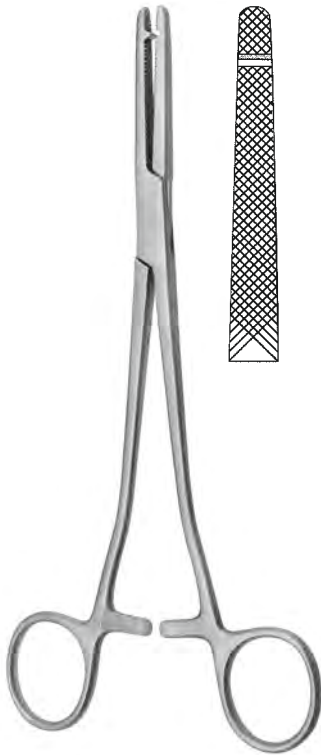

HEANEY-REZEK
21 cm // 8 1/4"
G367-21



FERGUSSON
16 cm // 6 1/4"

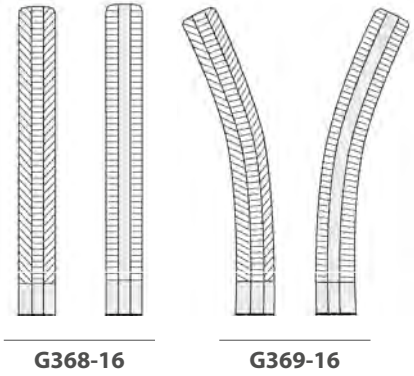

HEANEY-KANTER
21 cm // 8 1/4"
G366-21



LONG
19 cm // 7 1/2"
G371-19

Hysterektomieklemmen
Hysterectomy Forceps

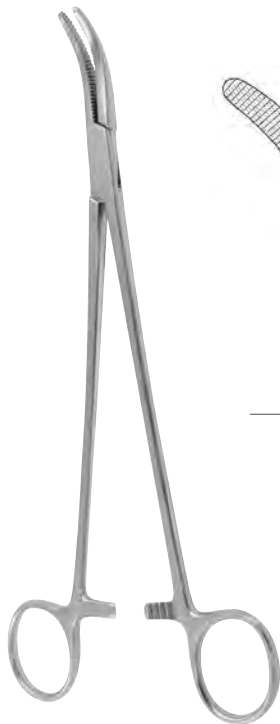

MOYNIHAN

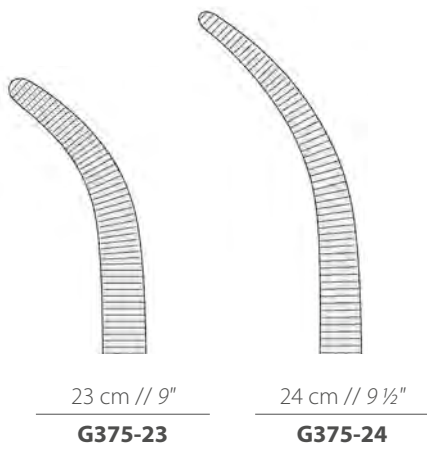

23 cm // 9"

G375-23

24 cm // 9 1/2"

G375-24



PHANEUF

21,5 cm // 8 1/2"

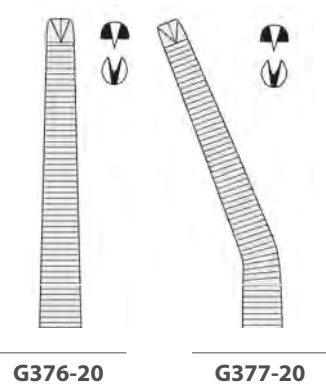

G376-20

G377-20



HOLZBACH
23,5 cm // 9 1/4"

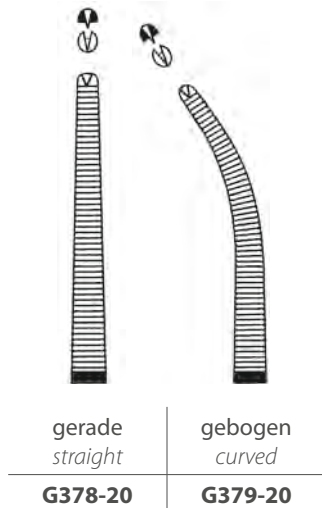

gerade
straight

G378-20

gebogen
curved

G379-20



WERTHEIM
25 cm // 10"
G380-25

Hysterektomieklemmen Hysterectomy Forceps



WERTHEIM
extra stark
extra strong
24 cm // 9 1/2"

G383-24

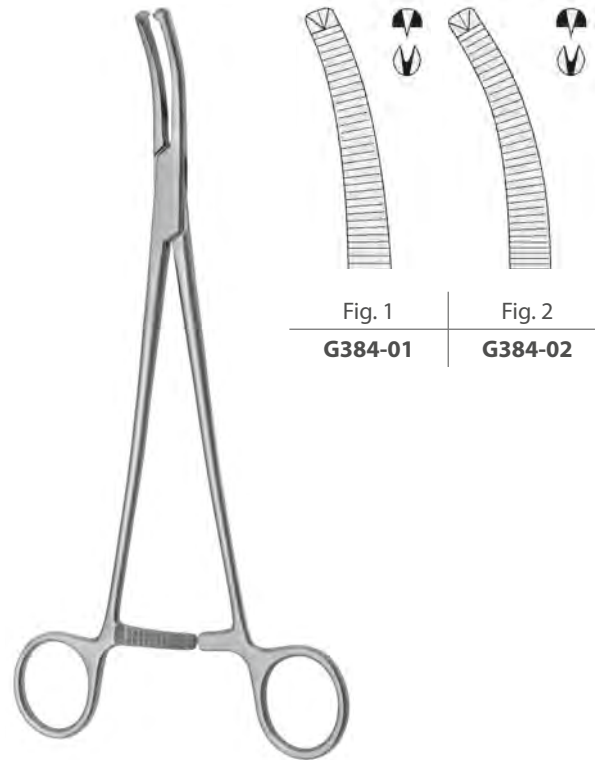

Fig. 1
G384-01

Fig. 2
G384-02

WERTHEIM
22 cm // 8 3/4"



FAURE
25 cm // 10"

G385-25

Hysterektomieklemmen
Hysterectomy Forceps



23 cm // 9"

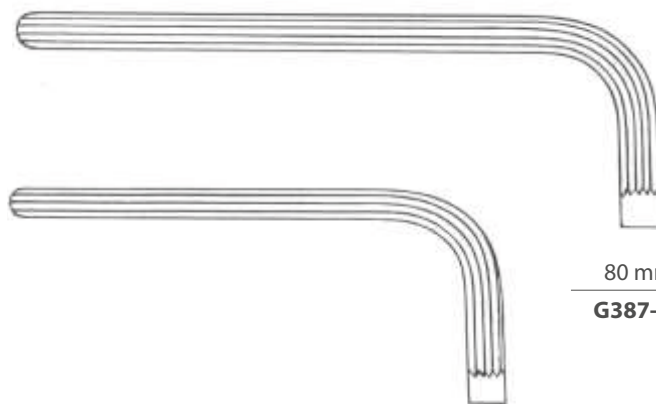

80 mm
G387-01

60 mm
G387-02



WERTHEIM-CULLEN
21,5 cm // 8½"
G390-21

Hysterektomieklemmen Hysterectomy Forceps



BABY-MIKULICZ
14 cm // 5 1/2"
G400-14

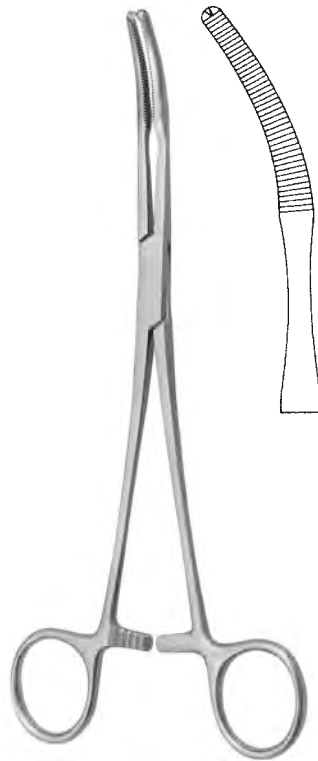

MIKULICZ
18 cm // 7" | **G400-18**
20 cm // 8" | **G400-20**



MIKULICZ
20 cm // 8"
G402-20



MIKULICZ
18,5 cm // 7"
G403-18

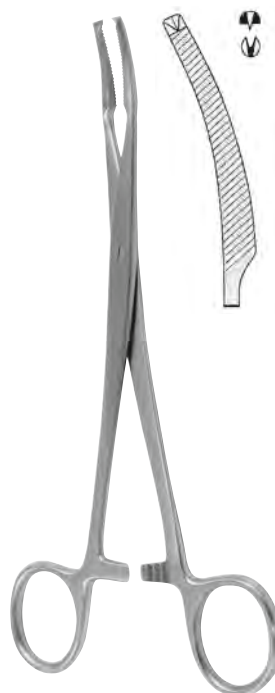

MIKULICZ
18,5 cm // 7"
G410-18



MIKULICZ
20 cm // 8"



Fig. 1
G412-01



Fig. 2
G412-02

Hysterektomieklemmen
Hysterectomy Forceps



FAURE
20 cm // 8"



Fig. 1
G415-01



Fig. 2
G415-02

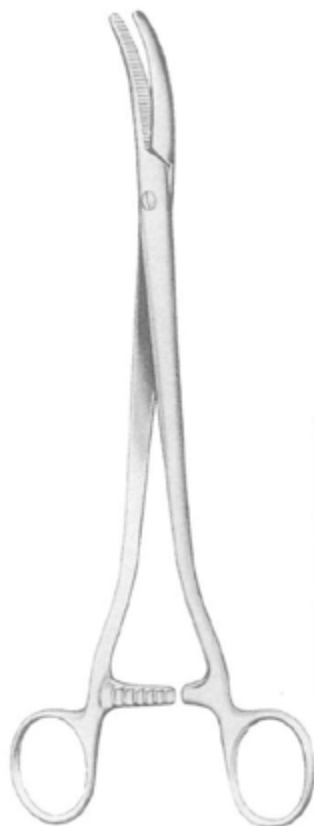

SEGOND-LANDAU
24 cm // 9 1/2"
G416-24



SEGOND
24 cm // 9 1/2"
G417-24

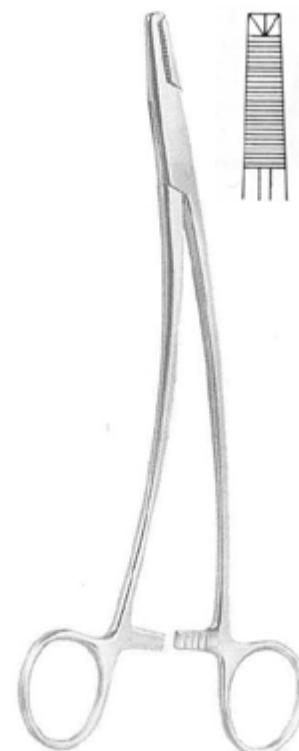

SCHINDLER
20 cm // 8"
G418-20

Tuchklemmen
Towel Forceps



SCHÄDEL
9 cm // 3 1/2"
G451-09



ENGL. MODELL
9 cm // 3 1/2"
G452-09



JONES
5 cm // 2" | **G454-05**
9 cm // 3 1/2" | **G454-09**



BACKHAUS
9 cm // 3 1/2" | **G460-09**
11 cm // 4 1/2" | **G460-11**
11 cm // 4 1/2" | **G460-11N**
13 cm // 5" | **G460-13**
15 cm // 6" | **G460-15**

Tuchklemmen Towel Forceps



BACKHAUS

11 cm // 4 1/2"	G462-11
13 cm // 5"	G462-13



RÖDER

13 cm // 5"	G464-13
15 cm // 6"	G464-15



TOHOKU

10 cm // 4"	G465-10
13 cm // 5"	G465-13



BALL/SOCKET

11 cm // 4 1/2"	G467-11
13 cm // 5"	G467-13



LORNA

10 cm // 4"	G468-10
13 cm // 5"	G468-13



PEERS-BERTRAM

14,5 cm // 5 1/2"	G470-14
-------------------	----------------

Tuchklemmen
Towel Forceps



BERNHARD
16,5 cm // 6 ½"
G471-16



LANE

13 cm // 5"	G472-13
15,5 cm // 6"	G472-15
18 cm // 7"	G472-18
20 cm // 8"	G472-20



DOYEN
18 cm // 7"
G474-18

Katheter-Einführungszangen
Catheter Forceps



MAGILL



15 cm // 6"
G490-15



20 cm // 8"
G490-20



25 cm // 10"
G490-25

Schwammzangen Sponge Holding Forceps



FÖRSTER
(FÖRSTER-BALLENGER)

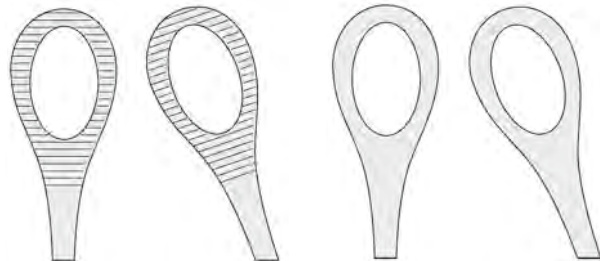

	gerade straight	gebogen curved	gerade straight	gebogen curved
18 cm // 6"	G500-18	G501-18	G502-18	G503-18
25 cm // 10"	G500-25	G501-25	G502-25	G503-25
35 cm // 14"	G500-35	G501-35	-	-
41 cm // 16"	G500-41	G501-41	-	-
46 cm // 18"	G500-46	-	-	-



RAMPLEY

18 cm // 7"	G505-18
25 cm // 10"	G505-25

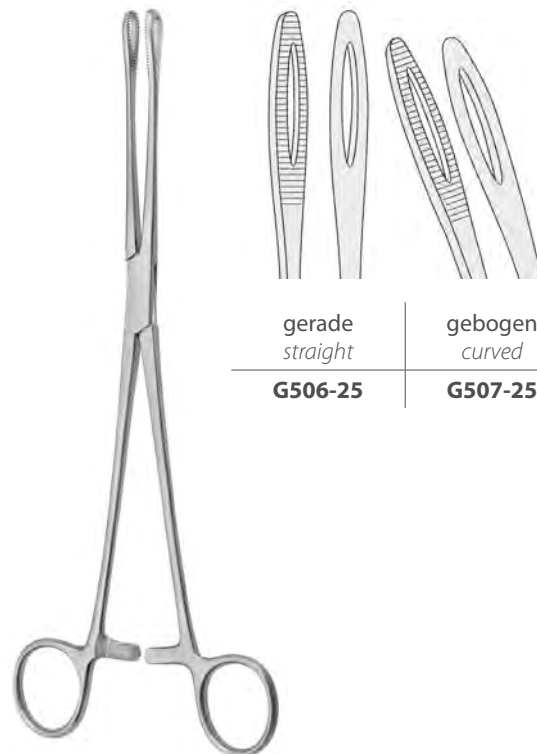

FÖRSTER
25 cm // 10"

gerade straight	gebogen curved
G506-25	G507-25

Korn- und Tupferzangen
Sponge and Dressing Forceps



BOZEMANN
26 cm // 10 1/4"
G510-26



BOZEMANN
26 cm // 10 1/4"
G511-26



BOZEMANN
26 cm // 10 1/4"
G513-26



BOZEMANN-DOUGLAS
26 cm // 10 1/4"
G514-26



GROSS-MAIER



gerade
straight



gebogen
curved

20 cm // 8"	G520-20	G521-20
25 cm // 10"	G520-25	G521-25

Ohne Sperre
Without ratchet

20 cm // 8"	G522-20	G523-20
25 cm // 10"	G522-25	G523-25

Korn- und Tupferzangen Sponge and Dressing Forceps



DUPLAY
20 cm // 8"



gerade straight	gebogen curved
G524-20	G525-20



ULRICH

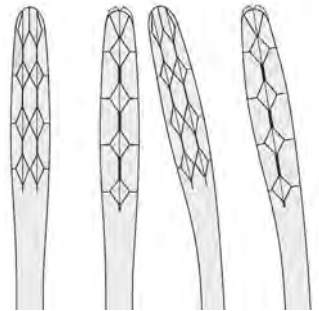

	gerade straight	gebogen curved
22 cm // 8 3/4"	G526-22	G527-22
25 cm // 10"	G526-25	G527-25
27 cm // 10 1/2"	G526-27	G527-27



SIMS-MAIER
28 cm // 11"



gerade straight	gebogen curved
G530-28	G531-28



PELKMANN
25 cm // 10"

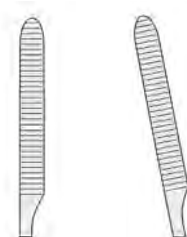

gerade straight	gebogen curved
G532-25	G533-25

Korn- und Tupferzangen
Sponge and Dressing Forceps



COLLIN
25 cm // 10"
G535-25

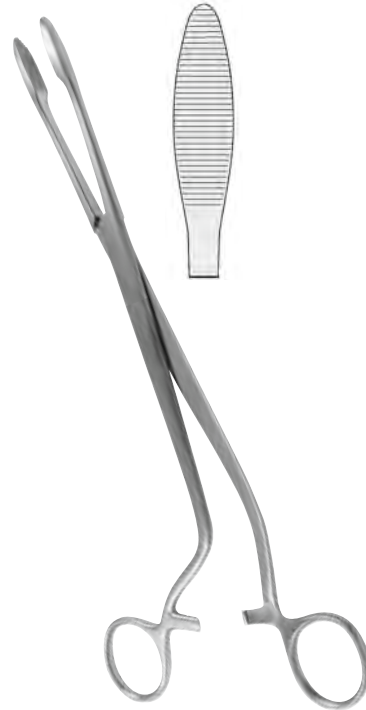

CHERON
25 cm // 10"
G536-25

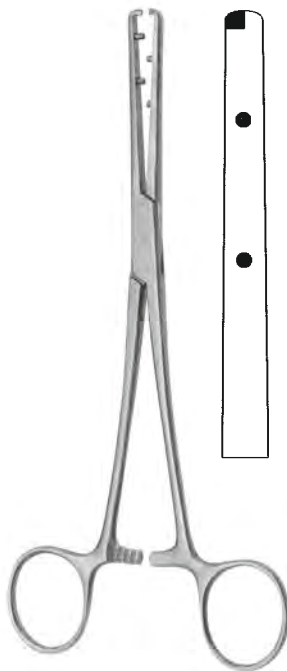

EMMET
21 cm // 8 1/4"
G538-21



BRYANT
13 cm // 5"
G539-13

Schlauchklemmen Tubing Forceps



15 cm // 6"	G550-15
18 cm // 7"	G550-18
20 cm // 8"	G550-20

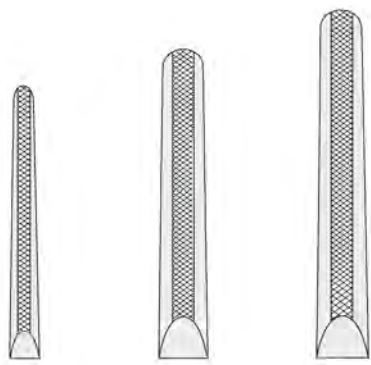

15 cm // 6"	G551-15
18 cm // 7"	G551-18
20 cm // 8"	G551-20



KLINIKUM BERLIN
14,5 cm // 5 1/2"
G554-14



PRESBYTERIAN
16,5 cm // 6 1/2" | **G556-16**
18 cm // 7" | **G556-18**

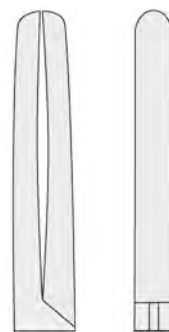

Bulldogklemmen
Bulldog Clamps



DIEFFENBACH

	gerade <i>straight</i>	gebogen <i>curved</i>
3,5 cm // 1 1/2"	G600-03	G601-03
5 cm // 2"	G600-05	G601-05
6 cm // 2 1/3"	G600-06	G601-06



JOHN-HOPKINS

	gerade <i>straight</i>	gebogen <i>curved</i>
38 mm	G602-01	G603-01
51 mm	G602-02	G603-02
57 mm	G602-03	G603-03
63 mm	G602-04	G603-04
70 mm	G602-05	G603-05
75 mm	G602-06	G603-06
90 mm	G602-07	G603-07

Anlegezange
Applying forceps



JOHN-HOPKINS
23 cm // 9"
G610-00



WELDON
3,5 cm // 1 1/4"

gerade <i>straight</i>	gebogen <i>curved</i>
G670-02	G670-03



JACOBSON
4,5 cm // 1 3/4"

gerade <i>straight</i>	gebogen <i>curved</i>
G680-04	G681-04

Bulldogklemmen Bulldog Clamps



**DIETRICH
DEBAKEY-DIETRICH**



Maul Jaw	gerade straight	gewinkelt angled	gerade straight	gewinkelt angled
9 mm	G706-08	G707-08	G706-28	G707-28
12 mm	G706-12	G707-12	G706-32	G707-32
16 mm	G706-16	G707-16	-	-
20 mm	G706-20	G707-20	G706-40	G707-40



DEBAKEY

Maul Jaw	gerade straight	gewinkelt angled	gebogen curved
10 mm	G706-60	G707-60	G708-60
14 mm	G706-64	G707-64	G708-64
20 mm	G706-70	G707-70	G708-70



**DEBAKEY
COOLEY**



DEBAKEY- TITANIUM	gerade straight	gebogen curved
8 cm // 3"	G710-08N	G711-08N
9 cm // 3 1/2"	G710-09N	G711-09N
10 cm // 4"	G710-10N	G711-10N
12 cm // 4"	G710-12N	G711-12N



DEBAKEY	gerade straight	gebogen curved
8 cm // 3"	G710-08	G711-08
9 cm // 3 1/2"	G710-09	G711-09
10,5 cm // 4"	G710-10	G711-10
13 cm // 5"	G710-13	G711-13



COOLEY	gerade straight	gebogen curved
8 cm // 3"	G712-08	G713-08
9 cm // 3 1/2"	G712-09	G713-09
10 cm // 4"	G712-10	G713-10
12 cm // 4"	G712-12	G713-12

Bulldogklemmen
Bulldog Clamps



9 cm // 3 1/2"	G714-09
10,5 cm // 4"	G714-10



9 cm // 3 1/2"	G715-09
12 cm // 4 3/4"	G715-12
12 cm // 4 3/4"	G715-12N

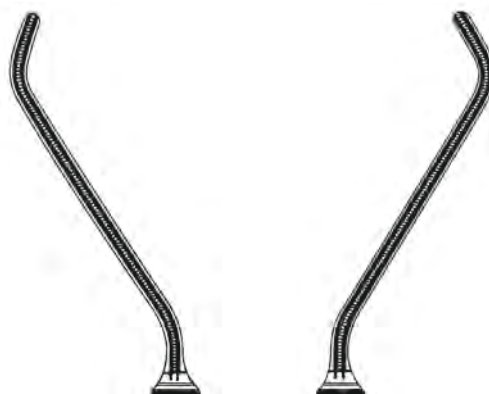

links left	rechts right
12 cm // 4 3/4"	12 cm // 4 3/4"
G715-21	G715-22



DEBAKEY-HESS

4,5 cm // 1 3/4"	G716-04
5,5 cm // 2"	G716-05



SANTULLI

7 cm // 2 3/4"
G717-07
G717-07N

Bulldogklemmen Bulldog Clamps



VENA	gerade <i>straight</i>	gebogen <i>curved</i>	stark gebogen <i>strong curved</i>
3 cm // 1 ¼"	G720-030V	G720-130V	G720-230V
3 cm // 1 ¼"	G720-030VN	G720-130VN	G720-230VN
3,5 cm // 1 ½"	G720-035V	G720-135V	G720-235V
3,5 cm // 1 ½"	G720-035VN	G720-135VN	G720-235VN
4 cm // 1 ½"	G720-040V	G720-140V	G720-240V
4 cm // 1 ½"	G720-040VN	G720-140VN	G720-240VN
5 cm // 2"	G720-050V	G720-150V	G720-250V
5 cm // 2"	G720-050VN	G720-150VN	G720-250VN

ARTERIA	gerade <i>straight</i>	gebogen <i>curved</i>	stark gebogen <i>strong curved</i>
3 cm // 1 ¼"	G720-030A	G720-130A	G720-230A
3 cm // 1 ¼"	G720-030AN	G720-130AN	G720-230AN
3,5 cm // 1 ½"	G720-035A	G720-135A	G720-235A
3,5 cm // 1 ½"	G720-035AN	G720-135AN	G720-235AN
4 cm // 1 ½"	G720-040A	G720-140A	G720-240A
4 cm // 1 ½"	G720-040AN	G720-140AN	G720-240AN
5 cm // 2"	G720-050A	G720-150A	G720-250A
5 cm // 2"	G720-050AN	G720-150AN	G720-250AN



WELDON	gerade <i>straight</i>	gebogen <i>curved</i>
3,5 cm // 1 ½"	G722-35	G723-35
4,5 cm // 1 ¾"	G722-45	G723-45

GLOVER	gerade <i>straight</i>	gebogen <i>curved</i>	gewinkelt <i>angled</i>
5 cm // 2"	G724-05	G725-05	G726-05
6 cm // 2 ¼"	G724-06	G725-06	-
7 cm // 2 ¾"	G724-07	G725-07	-
9 cm // 3 ½"	G724-09	G725-09	-
12 cm // 4 ½"	G724-12	G725-12	-

Bulldogklemmen
Bulldog Clamps



DEBAKEY-SATINSKY

5,5 cm // 2"	G727-05
7 cm // 2 ¾"	G727-07
9 cm // 3 ½"	G727-09
10 cm // 4"	G727-10



DEBAKEY
7,5 cm // 3"
G727-21



COOLEY-GLOVER	gerade <i>straight</i>	gebogen <i>curved</i>
6 cm // 2 ⅓"	G728-06	G729-06
7,5 cm // 3"	G728-07	G729-07
9 cm // 3 ½"	G728-09	G729-09
11 cm // 4 ½"	G728-11	G729-11



SCHWARTZ
19 cm // 7 ½"
G730-00



G730-01

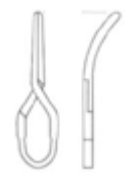

G730-02



G730-03

Gefäßclips Vessel Clips



18 cm // 7" | **G732-002**
22 cm // 8 ¾" | **G732-003**



14 cm // 5 ½" | **G732-001**



Maullänge Length of jaw	Maulbreite Width of jaw	Schließdruck Occlusion pressure	gerade straight	leicht gebogen slightly curved	stark gebogen strong curved	abgewinkelt angled
4 mm	0,75 mm	125 g	G732-104	-	-	-
6 mm	1 mm	100 g	G732-106	-	-	-
8 mm	2 mm	85 g	G732-108	-	-	-
10 mm	2 mm	60 g	G732-110	-	-	-
4 mm	0,75 mm	150 g	G732-114	-	-	-
6 mm	1 mm	150 g	G732-116	G732-216	G732-316	G732-416
8 mm	2 mm	150 g	G732-118	-	-	-
10 mm	2 mm	150 g	G732-120	-	-	-
4 mm	0,75 mm	70 g	G732-124	-	-	-
6 mm	0,8 mm	70 g	G732-126	-	-	-
6 mm	1 mm	70 g	G732-127	G732-226	G732-326	G732-426
8 mm	1 mm	70 g	G732-128	-	-	-
10 mm	1,5 mm	70 g	G732-130	-	-	-

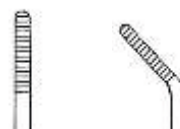

	gerade straight	gebogen curved
30 mm	G734-01	G734-11
34 mm	G734-02	G734-12
38 mm	G734-03	G734-13

Gefäßclips
Vessel Clips



ACLAND

Mit Sperre
With ratchet

G740-01

Ohne Sperre
Without ratchet

G740-02

A = Für Arterien
A = For arteries

V = Für Venen
V = For veins

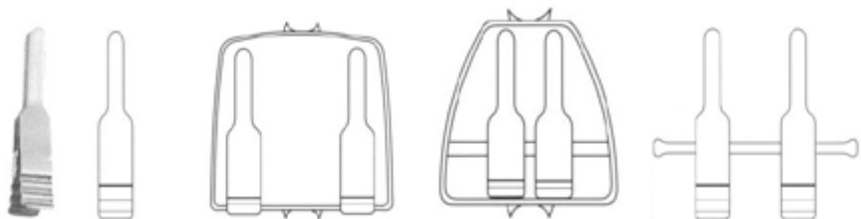

Länge Length	Gefäßgröße Vessel size	Einzelklemme Single Clamp	Doppelklemme Double Clamp	Approximator Approximator	Approximator Approximator
8 mm	0,4 - 1 mm	G742-08A	G743-08A	G744-08A	G745-08A
8 mm	0,4 - 1 mm	G742-08V	G743-08V	G744-08V	G745-08V
11 mm	0,6 - 1,5 mm	G742-11A	G743-11A	G744-11A	G745-11A
11 mm	0,6 - 1,5 mm	G742-11V	G743-11V	G744-11V	G745-11V
14 mm	1 - 2 mm	G742-14A	G743-14A	G744-14A	G745-14A
14 mm	1 - 2 mm	G742-14V	G743-14V	G744-14V	G745-14V
17 mm	1 - 2,25 mm	G742-17A	G743-17A	G744-17A	G745-17A
17 mm	1 - 2,25 mm	G742-17V	G743-17V	G744-17V	G745-17V
25 mm	1,5 - 3,5 mm	G742-25A	G743-25A	G744-25A	G745-25A
25 mm	1,5 - 3,5 mm	G742-25V	G743-25V	G744-25V	G745-25V
36 mm	2 - 5 mm	G742-36A	G743-36A	G744-36A	G745-36A
36 mm	2 - 5 mm	G742-36V	G743-36V	G744-36V	G745-36V

Alle diese Gefäßclips sind auch in Schwarz lieferbar.
All these Vessel Clips are also available in black finish.

Gefäßclips, Approximatoren Vessel Clips, Approximators



Maullänge <i>Length of jaw</i>	6 mm	9 mm	9 mm
Maulöffnung <i>Jaw opening</i>	4 mm	5 mm	9 mm
Schließdruck <i>Occlusion pressure</i>	30/40 g	30/40 g	25/25 g
	G750-01	G750-02	G750-03

Anlegepinzette
Applying forceps



14,5 cm // 5 1/2"

Ohne Schloss
Without lock
G750-21

Mit Schloss
With lock
G750-22



Approximator
Approximator
G750-70



Approximator mit Schlüssel, Druck einstellbar
Approximator with key pressure justable
G750-75

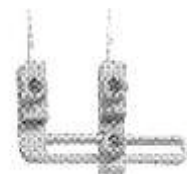

Nerv-Approximator mit Schlüssel
Approximator for nerves with key
G750-80



Schlüssel für Approximatoren
Key for approximators
G750-96

Gefäßclips, Approximatoren
Vessel Clips, Approximators



BIEMER-MÜLLER

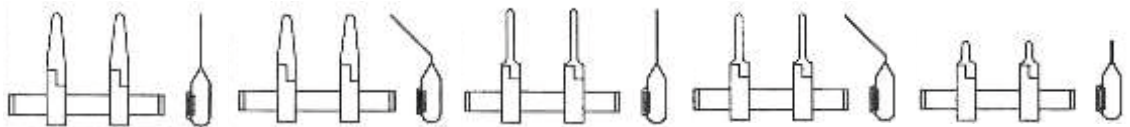

Mauillänge Length of jaw	9 mm	9 mm	9 mm	9 mm	4,5 mm
	G755-01	G755-02	G755-03	G755-04	G755-05



MÜLLER

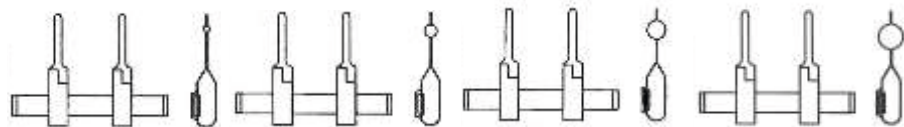

Mauillänge Length of jaw	9 mm	9 mm	9 mm	9 mm
Durchmesser Diameter	1 mm	2 mm	3 mm	4 mm
	G756-01	G756-02	G756-03	G756-04



Anlegepinzette für Approximatoren
Applying forceps for approximators

G755-21

Gefäßclips Vessel Clips



MÜLLER



Schließdruck Occlusion pressure	50g	50g	50g	50g	50g	
	G760-10	G760-11	G760-12	G760-13	G760-14	
Schließdruck Occlusion pressure	80g	80g	80g	80g	80g	Fadenklemme Ligature Forceps
	G760-20	G760-21	G760-22	G760-30	G760-40	G760-51

Nadelhalter

// Needle Holder

Inhalt

Index

Abschnitt **H**
// Section

Nadelhalter <i>Needle Holders</i>	H02 - H17
Mikro-Nadelhalter <i>Micro Needle Holders</i>	H18 - H31
Unterbindungsnadeln <i>Ligature Needles</i>	H32 - H36
Nahtinstrumente <i>Suture Instruments</i>	H37 - H40
Wundklammerbesteck, Wundklammerpinzetten <i>Suture Set, Clip Applying forceps</i>	H40 - H41
Gips-Instrumente <i>Plaster Instruments</i>	H42 - H44

best medical bietet ein umfangreiches Programm an diversen Nadelhaltern in vielen Ausführungen
best medical offers a comprehensive range of Needle Holder in various types

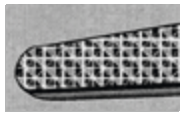

TC 0,5 mm

Für Nadeln & Nahtmaterial
bis Stärke 4-0
*For needles and sutures
up to size 4-0*

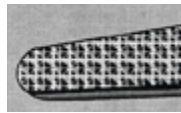

TC 0,4 mm

Für Nadeln & Nahtmaterial
Stärke 5-0 und 6-0
*For needles and sutures
sizes 5-0 and 6-0*

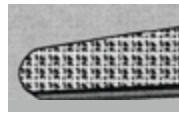

TC 0,3 mm

Für Mikro-Nadeln & Nahtmaterial
Stärke 7-0 bis 10-0
*For Micro-Needles and sutures
sizes 7-0 to 10-0*

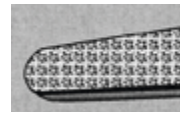

TC 0,2 mm

Für feine Nadeln & Nahtmaterial
Stärke 7-0 bis 12-0
*For delicate needles and sutures
sizes 7-0 to 12-0*

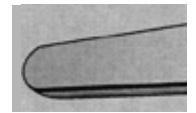

TC Glatt // *smooth*

Für feine Nadeln & Nahtmaterial
Stärke 7-0 bis 12-0
*For delicate needles and sutures
sizes 7-0 to 12-0*

Bei der „bestDiamond“ Beschichtung handelt es sich um eine Mikro-Kristallbeschichtung (= Diamantierung) mit herausragender Oberflächenhärte. Durch ein spezielles technisches Verfahren werden Mikro-Kristalle in die Oberfläche des Produktes implantiert und damit mit dem Grundwerkstoff verschmolzen, so dass ein unlösbarer Verbundwerkstoff entsteht.



Die Vorteile dieser Beschichtung gegenüber einer „reinen Diamantierung“ liegen in der Verschmelzung mit dem Grundwerkstoff, was ein Ausbrechen der Diamantkristalle ausschließt.

Die Vorteile für den Chirurgen sind vielfältig:

- Besonders geeignet für feines Nahtmaterial und feine Nadeln
- Extreme Erhöhung der Oberflächenhärte
- Eindeutige Verbesserung der Verschleißfestigkeit und damit längere Lebensdauer
- Erhöhte Korrosionsfestigkeit
- Die kristallisierte Maulfläche garantiert einen festen Halt der Nadel bzw. des Nahtmaterials
- Keine Beschädigung der Nadel, und damit auch keine klinisch riskante Traumatisierung

The bestDiamond coating is a micro-crystal coating with an outstanding surface hardness. In a special unique technical process micro-crystals are implemented on to the surface of the instrument and melted with the stainless material.

The advantage of the process is –comparing the regular crystal coating- the melting with the original material, which avoids a breaking-off of the crystals.

For Surgeons this means several advantages:

- Especially applicable for delicate Suture and Needles
- Extreme increase of the hardness
- Clear Improvement for wear and tear and longer lifetime
- Higher Corrosion Resistance
- Guarantees a solid grip of the needles and suture
- Avoids damaging of the needles, though extremely atraumatic

Standard-Nadelhalter, hergestellt aus hochwertigem deutschem Stahl
Standard Needle Holder, made of high graded German Stainless Steel

D Nadelhalter mit diamantbeschichtetem Maul „bestDiamond“
Needle Holder with diamant coated jaws „bestDiamond“

N Nadelhalter aus Titan, extrem leicht
Needle Holder made from Titanium, extremely light

ND Nadelhalter aus Titan, mit diamantbeschichtetem Maul
Needle Holder made from Titanium, with diamant-coated Jaws

NT Nadelhalter aus Titan, mit TC-Einlagen
Needle Holder made from Titanium, with defined TC-Inserts

T Nadelhalter mit definierten TC-Einlagen
Needle Holder with defined TC-inserts

Nadelhalter Needle Holders

- D** Diamantiert // *Diamond coated*
- N** Titan // *Titanium*
- ND** Titan - Diamantiert // *Titanium - Diamond coated*
- NT** Titan - Hartmetall // *Titanium - TC*
- T** Hartmetall // *TC*



COLLIER
12,5 cm // 5"
H106-12



BROWN
13 cm // 5" | **H108-13**
18 cm // 7" | **H108-18**



HALSEY
13 cm // 5"
gezahnt / *serrated* | glatt / *smooth*
H110-13 | **H110-63**
H110-13T | **H110-63T**



PAR
11 cm // 4 1/4" | **H112-11T**
13 cm // 5" | **H112-13T**

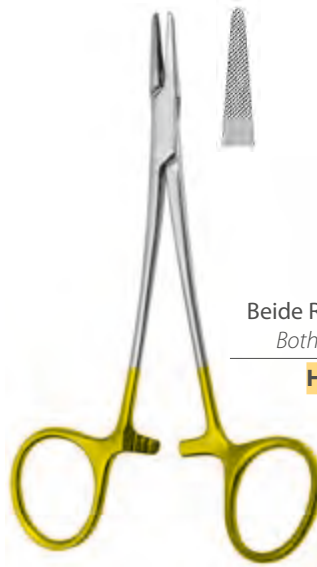

Beide Ringe gewinkelt
Both Rings angled

H115-13T

NEIVERT
13 cm // 5"
H114-13T



CONVERSE
12 cm // 4 3/4"
gezahnt / *serrated* | glatt / *smooth*
H116-12T | **H116-62T**

D	<input type="checkbox"/>	Diamantiert // Diamond coated
N	<input type="checkbox"/>	Titan // Titanium
ND	<input type="checkbox"/>	Titan - Diamantiert // Titanium - Diamond coated
NT	<input type="checkbox"/>	Titan - Hartmetall // Titanium - TC
T	<input type="checkbox"/>	Hartmetall // TC

Nadelhalter
Needle Holders



DERF
12 cm // 4 3/4"

H117-12T

H117-12ND

H117-12NT



DERF
12 cm // 4 3/4"

H118-12



DERF
12 cm // 4 3/4"

H119-12



BABY-WEBSTER
12 cm // 4 3/4"

gezahnt
serrated

H120-12T

glatt
smooth

H120-62T



WEBSTER
13 cm // 5"

gezahnt
serrated

H120-13T

glatt
smooth

H120-63T



KILNER

13 cm // 5"

H128-13

13 cm // 5"

H128-13T

15 cm // 6"

H128-15

15 cm // 6"

H128-15T



BABY-CRILE-WOOD
15 cm // 6"

H130-15T

Nadelhalter Needle Holders



CRILE-WOOD



		TC gezahnt <i>TC serrated</i>	TC glatt <i>TC smooth</i>
15 cm // 6"	H132-15	H132-15T	H132-65T
18 cm // 7"	H132-18	H132-18T	H132-68T
20 cm // 8"	H132-20	H132-20T	H132-70T
23 cm // 9"	-	H132-23T	H132-73T
26 cm // 10 1/4"	-	H132-26T	H132-76T
31 cm // 12 1/4"	-	H132-31T	H132-81T



CRILE-WOOD

18 cm // 7"	H133-18T
20 cm // 8"	H133-20T
23 cm // 9"	H133-23T



CRILE-MURRAY
15 cm // 6"
H134-15



MAYO-HEGAR-SEELEY
20 cm // 8"
H138-20T



HEGAR-BAUMGARTNER
14 cm // 5 1/2"
H145-14
H145-14T

Nadelhalter
Needle Holders



MAYO-HEGAR

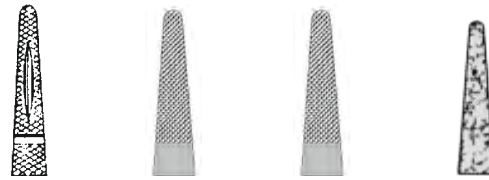

		TC	Titanium TC	Titanium Diamond
14 cm // 5 1/2"	H150-14	-	-	-
16 cm // 6 1/2"	H150-16	H150-16T	H150-16NT	H150-16ND
18 cm // 7"	H150-18	H150-18T	H150-18NT	H150-18ND
20 cm // 8"	H150-20	H150-20T	H150-20NT	H150-20ND
22 cm // 8 3/4"	-	H150-22T	H150-22NT	H150-22ND
24 cm // 9 1/2"	H150-24	H150-24T	H150-24NT	-
26 cm // 10 1/4"	H150-26	H150-26T	-	H150-26ND
30 cm // 11 3/4"	H150-30	H150-30T	-	-
35 cm // 13 3/4"	-	H150-35T	-	-



MAYO-HEGAR



16 cm // 6 1/2"	H151-16	H151-16T
18 cm // 7"	-	H151-18T
20 cm // 8"	H151-20	H151-20T
24 cm // 9 1/2"	-	H151-24T
26 cm // 10 1/4"	-	H151-26T
30 cm // 11 3/4"	-	H151-30T

Nadelhalter Needle Holders



MAYO-HEGAR
schlank
slender

14 cm // 5 1/2"	-	H152-14T
16 cm // 6 1/2"	H152-16	H152-16T
18 cm // 7"	H152-18	H152-18T
20 cm // 8"	H152-20	-



MAYO-HEGAR
kräftig
strong

16 cm // 6 1/2"	H154-16	-	-
18 cm // 7"	H154-18	-	-
20 cm // 8"	H154-20	H154-20T	H155-20
24 cm // 9 1/2"	-	H154-24T	-

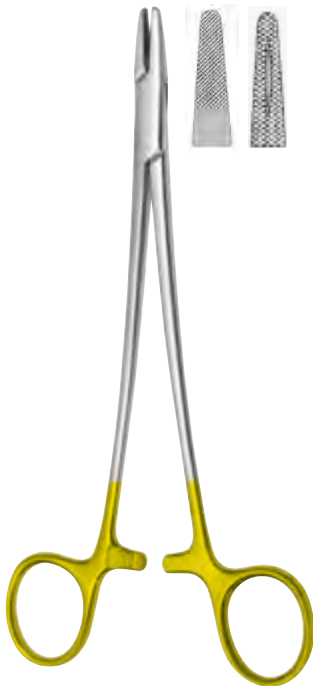

NEW ORLEANS
18 cm // 7"
H156-18
H156-18T



ADSON
18 cm // 7"
H157-18



BOZEMANN

20 cm // 8"	H160-20T
24 cm // 9 1/2"	H160-24T
26 cm // 10 1/4"	H160-26T



D	<input type="checkbox"/>	Diamantiert // Diamond coated
N	<input type="checkbox"/>	Titan // Titanium
ND	<input type="checkbox"/>	Titan - Diamantiert // Titanium - Diamond coated
NT	<input type="checkbox"/>	Titan - Hartmetall // Titanium - TC
T	<input type="checkbox"/>	Hartmetall // TC

Nadelhalter
Needle Holders



DEBAKEY

16 cm // 6 1/2"	-	H162-16NT	H162-16ND	
18 cm // 7"	H162-18T	H162-18NT	H162-18ND	
20 cm // 8"	H162-20T	H162-20NT	H162-20ND	
22 cm // 8 3/4"	-	H162-22NT		
23 cm // 9"	H162-23T		H162-23ND	
26 cm // 10 1/4"	H162-26T	H162-26NT	H162-26ND	
30 cm // 11 3/4"	H162-30T			
37 cm // 14 1/2"	H162-37T			



DEBAKEY FINE

16 cm // 6 1/2"	H164-16T
18 cm // 7"	H164-18T
20 cm // 8"	H164-20T
23 cm // 9"	H164-23T
24,5 cm // 9 1/2"	H164-24T
26 cm // 10 1/4"	H164-26T
31 cm // 12 1/4"	H164-31T



BEST-SELECT

12,5 cm // 5"	H165-12D
14,5 cm // 5 1/2"	H165-14D
16,5 cm // 6 1/2"	H165-16D
18 cm // 7"	H165-18D
20 cm // 8"	H165-20D
23 cm // 9"	H165-23D
26 cm // 10 1/4"	H165-16D

Nadelhalter Needle Holders



JAMESON
23,5 cm // 9 1/4"
H166-23
H166-23T

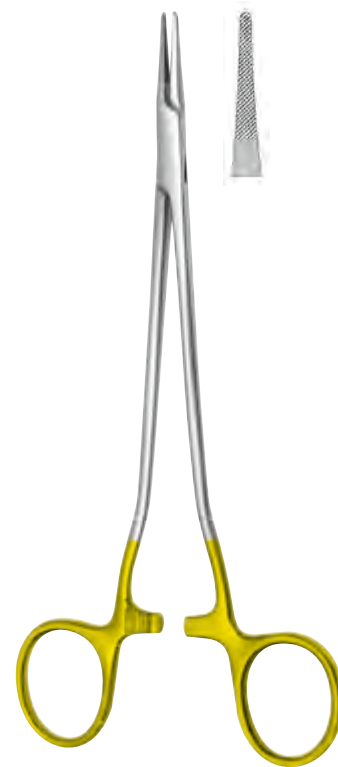

HEGAR-VASCULAR

15 cm // 6"	H175-15T
18 cm // 7"	H175-18T
20 cm // 8"	H175-20T
23 cm // 9"	H175-23T

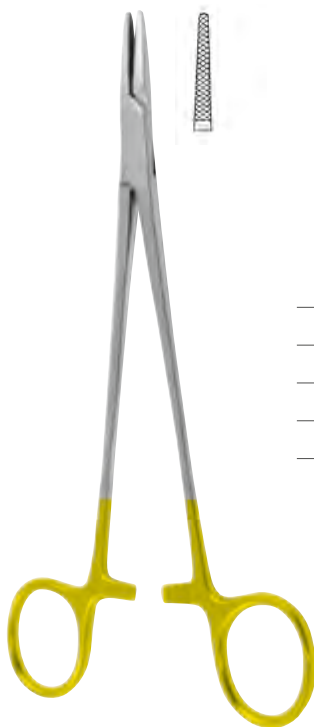

MICRO-VASCULAR

14 cm // 5 1/2"	H176-14T	-	-
16 cm // 6 1/2"	H176-16T	H176-16NT	H176-16ND
18 cm // 7"	H176-18T	H176-18NT	H176-18ND
20 cm // 8"	H176-20T	H176-20NT	H176-20ND
22 cm // 8 3/4"	H176-22T	H176-22NT	H176-22ND
25 cm // 10"	H176-25T	H176-25NT	H176-25ND

D Diamantiert // Diamond coated
N Titan // Titanium
ND Titan - Diamantiert // Titanium - Diamond coated
NT Titan - Hartmetall // Titanium - TC
T Hartmetall // TC

Nadelhalter

Needle Holders

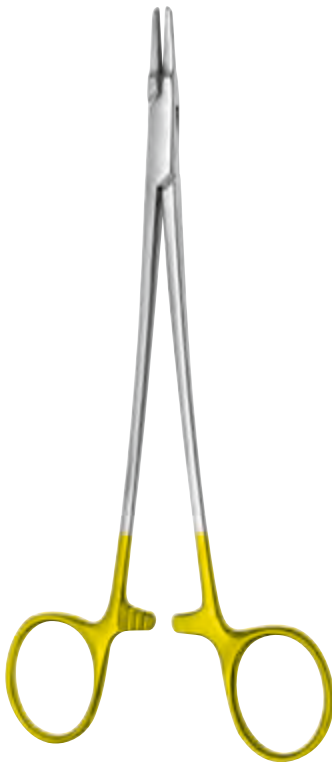

RYDER

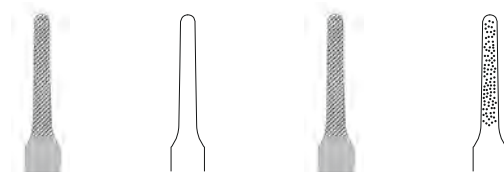

	gezahnt <i>serrated</i>	glatt <i>smooth</i>	Titanium TC	Titanium Diamond
13 cm // 5"	H178-13T	-	-	-
15 cm // 6"	H178-15T	H178-65T	-	-
16 cm // 6 1/4"	-	-	H178-16NT	H178-16ND
18 cm // 7"	H178-18T	H178-68T	H178-18NT	H178-18ND
20 cm // 8"	H178-20T	-	H178-20NT	H178-20ND
23 cm // 9"	H178-22T	H178-73T	H178-23NT	H178-23ND
25 cm // 10"	H178-25T	-	H178-25NT	H178-25ND



MICRO-RYDER

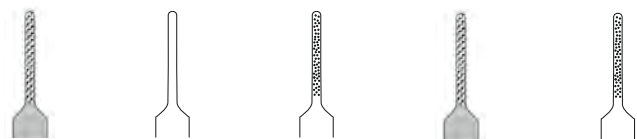

	gezahnt <i>serrated</i>	glatt <i>smooth</i>		Titanium TC	Titanium Diamond
12,5 cm // 5"	H180-12T	H180-62T	-	-	-
15 cm // 6"	H180-15T	H180-65T	H180-15D	H180-15NT	H180-15ND
18 cm // 7"	H180-18T	H180-68T	H180-18D	H180-18NT	H180-18ND
20 cm // 8"	H180-20T	H180-70T	H180-20D	H180-20NT	H180-20ND
23 cm // 9"	H180-23T	H180-73T	H180-23D	-	-
26 cm // 10 1/4"	H180-26T	H180-76T	H180-26D	-	-

Nadelhalter Needle Holders



SENNING

15 cm // 6"	H182-15T
17 cm // 6 3/4"	H182-17T
20 cm // 8"	H182-20T



SAROT

18 cm // 7"	H186-18	H186-18T
20 cm // 8"	-	H186-20T
26 cm // 10 1/4"	H186-26	H186-26T

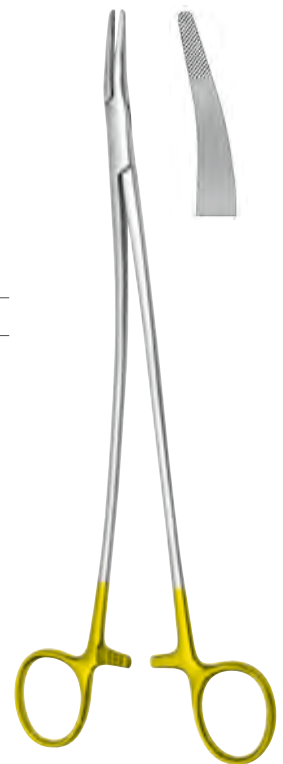

STRATTE

20 cm // 8"	H189-20T
23 cm // 9"	H189-23T

Nadelhalter
Needle Holders

- D** Diamantiert // *Diamond coated*
- N** Titan // *Titanium*
- ND** Titan - Diamantiert // *Titanium - Diamond coated*
- NT** Titan - Hartmetall // *Titanium - TC*
- T** Hartmetall // *TC*



MASSON
27 cm // 10 1/2"
H192-27
H192-27T



WANGENSTEEN
27,5 cm // 10 3/4"
H194-27
H194-27T

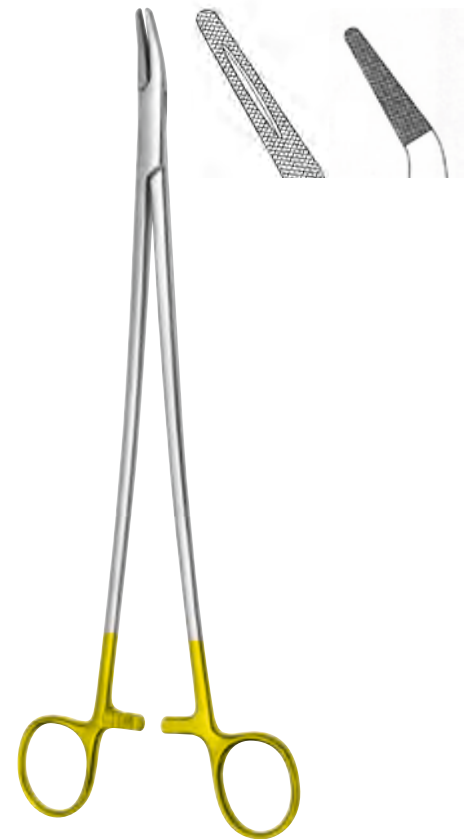

FINOCHIETTO

20 cm // 8"	-	H195-20T
27 cm // 10 1/2"	H195-27	H195-27T
30 cm // 12"	-	H195-30T

Nadelhalter Needle Holders



BOYNTON
12 cm // 4 3/4"

H210-12

H210-12T



ARRUGA
16 cm // 6 1/4"



gerade
straight

gebogen
curved

H212-16

H213-16

H212-16T

H213-16T



CRILE
15 cm // 6"

H218-15



MATHIEU



14 cm // 5 1/2"

H220-14

H220-14T

H221-14

17 cm // 6 3/4"

H220-17

H220-17T

H221-17

20 cm // 8"

H220-20

H220-20T

H221-20

24 cm // 9 1/2"

-

H220-24T

-

Nadelhalter
Needle Holders

D	<input type="checkbox"/>	Diamantiert // Diamond coated
N	<input type="checkbox"/>	Titan // Titanium
ND	<input type="checkbox"/>	Titan - Diamantiert // Titanium - Diamond coated
NT	<input type="checkbox"/>	Titan - Hartmetall // Titanium - TC
T	<input type="checkbox"/>	Hartmetall // TC



MATHIEU

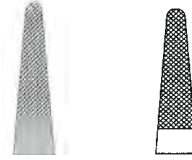

14 cm // 5 1/2"	H222-14	-
17 cm // 6 3/4"	H222-17	H222-17T
20 cm // 8"	H222-20	H222-20T
24 cm // 9 1/2"	-	H222-24T



MATHIEU-METZENBAUM

17 cm // 6 3/4"	H223-17T
20 cm // 8"	H223-20T



MATHIEU-RYDER

14 cm // 5 1/2"	H224-14T
17 cm // 6 3/4"	H224-17T
20 cm // 8"	H224-20T

Nadelhalter Needle Holders



MATHIEU-KOCHER

14 cm // 5 1/2"	H226-14T
17 cm // 6 3/4"	H226-17T
20 cm // 8"	H226-20T



MATHIEU
Starkes Modell
Strong pattern

17 cm // 6 3/4"	H228-17T
20 cm // 8"	H228-20T
24 cm // 9 1/2"	H228-24T



LANGENBECK

16 cm // 6 1/4"	H230-16T
18 cm // 7"	H230-18T
20 cm // 8"	H230-20T



LANGENBECK-RYDER
20 cm // 8"
H231-20T

D	<input type="checkbox"/>	Diamantiert // Diamond coated
N	<input type="checkbox"/>	Titan // Titanium
ND	<input type="checkbox"/>	Titan - Diamantiert // Titanium - Diamond coated
NT	<input type="checkbox"/>	Titan - Hartmetall // Titanium - TC
T	<input type="checkbox"/>	Hartmetall // TC

Nadelhalter
Needle Holders



TÖNNIS
18 cm // 7"
H232-18
H232-18T



20 cm // 8" | **H233-20T**
25 cm // 10" | **H233-25T**



LICHTENBERG
20 cm // 8"
H234-20
H234-20T



HÖSEL
20 cm // 8" | **H235-20T**
25 cm // 10" | **H235-25T**





ZWEIFEL
20 cm // 8" | **H236-20T**
23 cm // 9" | **H236-23T**

Nadelhalter Needle Holders



BABY-OLSEN-HEGAR
11,5 cm // 4 1/2"

	
H240-11	H240-61
H240-11T	H240-61T



OLSEN-HEGAR

14 cm // 5 1/2"	H240-14	H240-14T
17 cm // 6 3/4"	H240-17	H240-17T
18 cm // 7"	H240-18	H240-18T



MINI-GILLIES
15 cm // 6"

Standard Standard	für Linkshänder lefthanded
H244-15	H244-15L
H244-15T	H244-15TL



GILLIES
16 cm // 6 1/4"

Standard Standard	für Linkshänder lefthanded
H245-16	H245-16L
H245-16T	H245-16TL

D	<input type="checkbox"/>	Diamantiert // Diamond coated
N	<input type="checkbox"/>	Titan // Titanium
ND	<input type="checkbox"/>	Titan - Diamantiert // Titanium - Diamond coated
NT	<input type="checkbox"/>	Titan - Hartmetall // Titanium - TC
T	<input type="checkbox"/>	Hartmetall // TC

Mikro-Nadelhalter
Micro Needle Holders



16 cm // 6 ¼"	H300-16T
18 cm // 7"	H300-18T
18 cm // 7"	H300-18D
20 cm // 8"	H300-20T
23 cm // 9"	H300-23T
23 cm // 9"	H300-23D
25 cm // 10"	H300-25T

DIETRICH



CASTROVIEJO

Mit Sperre With ratchet	gerade straight	gebogen curved
9 cm // 3 ½"	H310-09	H311-09
9 cm // 3 ½"	H310-09D	H311-09D
14 cm // 5 ½"	H310-14	H311-14



CASTROVIEJO

Ohne Sperre Without ratchet	gerade straight	gebogen curved
9 cm // 3 ½"	H312-09	H313-09
9 cm // 3 ½"	H312-09D	H313-09D
14 cm // 5 ½"	H312-14	H313-14

Mikro-Nadelhalter Micro Needle Holders



CASTROVIEJO
Mit Sperre
With ratchet



	Standard Standard	TC / gezahnt TC / serrated	TC / glatt TC / smooth	Diamant Diamond	Titan Titanium	Titanium Diamond	Titanium TC
14 cm // 5 1/2"	H330-14	H330-14T	H330-64T	H330-14D	H330-15N	H330-15ND	-
17 cm // 6 3/4"	-	-	-	H330-17 D	-	-	-
18 cm // 7"	H330-18	H330-18T	H330-68T	H330-18D	H330-18N	H330-18ND	H330-18NT
21 cm // 8 1/4"	H330-21	H330-21T	H330-71T	H330-21D	H330-21N	H330-21ND	H330-21NT
23 cm // 9"	H330-23	H330-23T	H330-73T	H330-23D	H330-23N	H330-23ND	H330-23NT



	Standard Standard	TC / gezahnt TC / serrated	TC / glatt TC / smooth	Diamant Diamond	Titan Titanium	Titanium Diamond
14 cm // 5 1/2"	H331-14	H331-14T	H331-64T	H331-14D	H331-15N	H331-15ND
18 cm // 7"	H331-18	H331-18T	H331-68T	H331-18D	H331-18N	H331-18ND
21 cm // 8 1/4"	H331-21	H331-21T	H331-71T	H331-21D	H331-21N	H331-21ND
23 cm // 9"	H331-23	H331-23T	H331-73T	H331-23D	H331-23N	H331-23ND

Mikro-Nadelhalter Micro Needle Holders

D	 Diamantiert // Diamond coated
N	 Titan // Titanium
ND	 Titan - Diamantiert // Titanium - Diamond coated
NT	 Titan - Hartmetall // Titanium - TC
T	 Hartmetall // TC



CASTROVIEJO
Ohne Sperre
Without ratchet



	Standard Standard	TC / gezahnt TC / serrated	TC / glatt TC / smooth	Diamant Diamond	Titan Titanium	Titanium Diamond	Titanium TC
14 cm // 5 1/2"	H332-14	H332-14T	H332-64T	H332-14D	H332-15N	H332-15ND	-
17 cm // 6 3/4"	-	-	-	H332-17D	-	-	-
18 cm // 7"	H332-18	H332-18T	H332-68T	H332-18D	H332-18N	H332-18ND	H332-18NT
21 cm // 8 1/4"	H332-21	H332-21T	H332-71T	H332-21D	H332-21N	H332-21ND	H332-21NT
23 cm // 9"	H332-23	H332-23T	H332-73T	H332-23D	H332-23N	H332-23ND	H332-23NT



	Standard Standard	TC / gezahnt TC / serrated	TC / glatt TC / smooth	Diamant Diamond	Titan Titanium	Titanium Diamond
14 cm // 5 1/2"	H333-14	H333-14T	H333-64T	H333-14D	H333-15N	H333-15ND
18 cm // 7"	H333-18	H333-18T	H333-68T	H333-18D	H333-18N	H333-18ND
21 cm // 8 1/4"	H333-21	H333-21T	H333-71T	H333-21D	H333-21N	H333-21ND
23 cm // 9"	H333-23	H333-23T	H333-73T	H333-23D	H333-23N	H333-23ND

Mikro-Nadelhalter Micro Needle Holders





18 cm // 7"	H336-18T
20 cm // 8"	H336-20T
23 cm // 9"	H336-23T

JACOBSON



YASARGIL

		
Mit Sperre <i>With ratchet</i>	gerade <i>straight</i>	gebogen <i>curved</i>
18 cm // 7"	H340-18	H341-18
18 cm // 7"	H340-18D	H341-18D
20 cm // 8"	H340-20	H341-20
20 cm // 8"	H340-20D	H341-20D
Ohne Sperre <i>Without ratchet</i>	gerade <i>straight</i>	gebogen <i>curved</i>
18 cm // 7"	H342-18	H343-18
18 cm // 7"	H342-18D	H343-18D
20 cm // 8"	H342-20	H343-20
20 cm // 8"	H342-20D	H343-20D

















Mikro-Nadelhalter

Micro Needle Holders

D	<input type="checkbox"/>	Diamantiert // Diamond coated
N	<input type="checkbox"/>	Titan // Titanium
ND	<input type="checkbox"/>	Titan - Diamantiert // Titanium - Diamond coated
NT	<input type="checkbox"/>	Titan - Hartmetall // Titanium - TC
T	<input type="checkbox"/>	Hartmetall // TC



YASARGIL

				
Mit Sperre With ratchet	Standard Standard	TC / gezahnt TC / serrated	TC / glatt TC / smooth	Diamant Diamond
21 cm // 8 1/4"	H344-21	H344-21T	H344-71T	H344-21D
22,5 cm // 8 3/4"	H344-22	H344-22T	H344-72T	H344-22D
				
Mit Sperre With ratchet	Standard Standard	TC / gezahnt TC / serrated	TC / glatt TC / smooth	Diamant Diamond
21 cm // 8 1/4"	H345-21	H345-21T	H345-71T	H345-21D
22,5 cm // 8 3/4"	H345-22	H345-22T	H345-72T	H345-22D
				
Ohne Sperre Without ratchet	Standard Standard	TC / gezahnt TC / serrated	TC / glatt TC / smooth	Diamant Diamond
21 cm // 8 1/4"	H346-21	H346-21T	H346-71T	H346-21D
22,5 cm // 8 3/4"	H346-22	H346-22T	H346-72T	H346-22D
				
Ohne Sperre Without ratchet	Standard Standard	TC / gezahnt TC / serrated	TC / glatt TC / smooth	Diamant Diamond
21 cm // 8 1/4"	H347-21	H347-21T	H347-71T	H347-21D
22,5 cm // 8 3/4"	H347-22	H347-22T	H347-72T	H347-22D

Mikro-Nadelhalter Micro Needle Holders



JACOBSEN



Mit Sperre With ratchet	Standard Standard	Diamant Diamond
16 cm // 6 1/4"	H360-16	H360-16D
18 cm // 7"	H360-18	H360-18D



Ohne Sperre Without ratchet	Standard Standard	Diamant Diamond
16 cm // 6 1/4"	H362-16	H362-16D
18 cm // 7"	H362-18	H362-18D



Mit Sperre With ratchet	Standard Standard	Diamant Diamond
16 cm // 6 1/4"	H361-16	H361-16D
18 cm // 7"	H361-18	H361-18D



Ohne Sperre Without ratchet	Standard Standard	Diamant Diamond
16 cm // 6 1/4"	H363-16	H363-16D
18 cm // 7"	H363-18	H363-18D



	gerade straight	gebogen curved
16 cm // 6 1/4"	H370-16	H371-16
18 cm // 7"	H370-18	H371-18

D	<input type="checkbox"/>	Diamantiert // Diamond coated
N	<input checked="" type="checkbox"/>	Titan // Titanium
ND	<input checked="" type="checkbox"/>	Titan - Diamantiert // Titanium - Diamond coated
NT	<input checked="" type="checkbox"/>	Titan - Hartmetall // Titanium - TC
T	<input type="checkbox"/>	Hartmetall // TC

Mikro-Nadelhalter

Micro Needle Holders



	Standard Standard	Titan Titanium	Standard Standard	Titan Titanium
	gerade straight	gerade straight	gebogen curved	gebogen curved
16 cm // 6 1/4"	-	-	H381-16	H381-16N
20 cm // 8"	H380-20	H380-20N	H381-20	H381-20N
22 cm // 8 3/4"	H380-22	H380-22N	H381-22	H381-22N
24 cm // 9 1/2"	-	-	H381-24	-

Streamline
Box Lock



	Diamant Diamond	Titanium Titanium	Diamant Diamond	Titanium Titanium
	gerade straight	gerade straight	gebogen curved	gebogen curved
20 cm // 8"	H386-20D	H386-20ND	H387-20D	H387-20ND
22,5 cm // 8 3/4"	H386-22D	H386-22ND	H387-22D	H387-22ND
24 cm // 9 1/2"	H386-24D	H386-24ND	H387-24D	H387-24ND

Mikro-Nadelhalter Micro Needle Holders



BARRAQUER-TROUTMAN



gerade
straight



gebogen
curved



abgewinkelt
angled

	gerade straight	gebogen curved	abgewinkelt angled
Mit Sperre With ratchet	H406-10	H407-10	-
Ohne Sperre Without ratchet	H408-10	H409-10	H404-10

BARRAQUER



		Standard Standard	Fein Fine	TC / gezahnt TC / serrated	TC / glatt TC / smooth	Diamant Diamond	Titanium Diamond	Titanium Diamond
Mit Sperre With ratchet	11 cm // 4 1/4"	H400-11	H400-21	-	-	H400-11D	-	H400-11ND
	12 cm // 4 3/4"	-	-	-	-	H400-12D	-	-
	13 cm // 5"	H400-13	H400-23	H400-13T	H400-63T	H400-13D	-	H400-13ND
	14 cm // 5 1/2"	H400-14	H400-24	H400-14T	H400-64T	H400-14D	H400-14N	H400-14ND
Ohne Sperre Without ratchet	11 cm // 4 1/4"	H402-11	H402-21	-	-	-	-	-
	12 cm // 4 3/4"	-	-	-	-	H402-12D	-	-
	13 cm // 5"	H402-13	H402-23	H402-13T	H402-63T	H402-13D	-	-
	14 cm // 5 1/2"	H402-14	H402-24	H402-14T	H402-64T	H402-14D	H402-14N	-



		Standard Standard	Fein Fine	TC / gezahnt TC / serrated	TC / glatt TC / smooth	Diamant Diamond	Titanium Diamond
Mit Sperre With ratchet	11 cm // 4 1/4"	H401-11	H401-21	-	-	-	-
	12 cm // 4 3/4"	-	-	-	-	H401-12D	-
	13 cm // 5"	H401-13	H401-23	H401-13T	H401-63T	H401-13D	-
	14 cm // 5 1/2"	H401-14	H401-24	H401-14T	H401-64T	H401-14D	H401-14N
Ohne Sperre Without ratchet	11 cm // 4 1/4"	H403-11	H403-21	-	-	-	-
	12 cm // 4 3/4"	-	-	-	-	H403-12D	-
	13 cm // 5"	H403-13	H403-23	H403-13T	H403-63T	H403-13D	-
	14 cm // 5 1/2"	H403-14	H403-24	H403-14T	H403-64T	H403-14D	H403-14N

Mikronadelhalter rund

Micro Needle Holders round

D	<input type="checkbox"/>	Diamantiert // Diamond coated
N	<input type="checkbox"/>	Titan // Titanium
ND	<input type="checkbox"/>	Titan - Diamantiert // Titanium - Diamond coated
NT	<input type="checkbox"/>	Titan - Hartmetall // Titanium - TC
T	<input type="checkbox"/>	Hartmetall // TC



Mit Sperre
With ratchet



	Standard Standard	TC / gezahnt TC / serrated	TC / glatt TC / smooth	Diamant Diamond	Titan Titanium	Titanium Diamond
16 cm // 6 1/4"	-	-	-	H420-16D	-	-
18 cm // 7"	H420-18	H420-18T	H420-68T	H420-18D	H420-18N	H420-18ND
21 cm // 8 1/4"	H420-21	H420-21T	H420-71T	H420-21D	H420-21N	H420-21ND
23 cm // 9"	H420-23	H420-23T	H420-73T	H420-23D	H420-23N	H420-23ND
25 cm // 10"	H420-25	H420-25T	H420-75T	H420-25D	-	-



	Standard Standard	TC / gezahnt TC / serrated	TC / glatt TC / smooth	Diamant Diamond	Titan Titanium	Titanium Diamond
16 cm // 6 1/4"	-	-	-	H421-16D	-	-
18 cm // 7"	H421-18	H421-18T	H421-68T	H421-18D	H421-18N	H421-18ND
21 cm // 8 1/4"	H421-21	H421-21T	H421-71T	H421-21D	H421-21N	H421-21ND
23 cm // 9"	H421-23	H421-23T	H421-73T	H421-23D	H421-23N	H421-23ND
25 cm // 10"	H421-25	H421-25T	H421-75T	H421-25D	-	-

Mikronadelhalter rund Micro Needle Holders round



Ohne Sperre
Without ratchet



	Standard Standard	TC / gezahnt TC / serrated	TC / glatt TC / smooth	Diamant Diamond	Titan Titanium	Titanium Diamond
16 cm // 6 1/4"	-	-	-	H422-16D	-	
18 cm // 7"	H422-18	H422-18T	H422-68T	H422-18D	H422-18N	H422-18ND
21 cm // 8 1/4"	H422-21	H422-21T	H422-71T	H422-21D	H422-21N	H422-21ND
23 cm // 9"	H422-23	H422-23T	H422-73T	H422-23D	H422-23N	H422-23ND
25 cm // 10"	H422-25	H422-25T	H422-75T	H422-25D	-	-



	Standard Standard	TC / gezahnt TC / serrated	TC / glatt TC / smooth	Diamant Diamond
16 cm // 6 1/4"	-	-	-	H423-16D
18 cm // 7"	H423-18	H423-18T	H423-68T	H423-18D
21 cm // 8 1/4"	H423-21	H423-21T	H423-71T	H423-21D
23 cm // 9"	H423-23	H423-23T	H423-73T	H423-23D
25 cm // 10"	H423-25	H423-25T	H423-75T	H423-25D

D	<input type="checkbox"/>	Diamantiert // Diamond coated
N	<input type="checkbox"/>	Titan // Titanium
ND	<input type="checkbox"/>	Titan - Diamantiert // Titanium - Diamond coated
NT	<input type="checkbox"/>	Titan - Hartmetall // Titanium - TC
T	<input type="checkbox"/>	Hartmetall // TC

Mikronadelhalter rund

Micro Needle Holders round



JACOBSON
Kurzer Griff
Short Knurling
23 cm // 9"

	gerade straight	gebogen curved
Mit Sperre With ratchet	H424-23D	H425-23D
Ohne Sperre Without ratchet	H424-73D	-



RYDER
18 cm // 7"

	gerade straight	gebogen curved
Mit Sperre With ratchet	H426-18T	H427-18T
Ohne Sperre Without ratchet	H428-18T	H429-18T



REILL
15 cm // 6"

	gerade straight	gebogen curved
Mit Sperre With ratchet	H430-15	H431-15
	H430-15D	H431-15D
Ohne Sperre Without ratchet	H432-15	H433-15
	H432-15D	H433-15D

Mikronadelhalter rund Micro Needle Holders round



Ohne Sperre Without ratchet	Standard Standard	Diamant Diamond	Titan Titanium	Titanium Diamond
15 cm // 6"	H440-15	H440-15D	H440-15N	H440-15ND
18 cm // 7"	H440-18	H440-18D	H440-18N	H440-18ND
21 cm // 8 1/4"	H440-21	H440-21D	H440-21N	H440-21ND
23 cm // 9"	H440-23	H440-23D	-	-

Streamline
Box Lock



Ohne Sperre Without ratchet	Standard Standard	Diamant Diamond	Titan Titanium	Titanium Diamond
15 cm // 6"	H441-15	H441-15D	H441-15N	H441-15ND
18 cm // 7"	H441-18	H441-18D	H441-18N	H441-18ND
21 cm // 8 1/4"	H441-21	H441-21D	H441-21N	H441-21ND
23 cm // 9"	H441-23	H441-23D	-	-



Mit Sperre With ratchet	Standard Standard	Diamant Diamond	Titan Titanium	Titanium Diamond
15 cm // 6"	H442-15	H442-15D	H442-15N	H442-15ND
18 cm // 7"	H442-18	H442-18D	H442-18N	H442-18ND
21 cm // 8 1/4"	H442-21	H442-21D	H442-21N	H442-21ND
23 cm // 9"	H442-23	H442-23D	-	-



Mit Sperre With ratchet	Standard Standard	Diamant Diamond	Titan Titanium	Titanium Diamond
15 cm // 6"	H443-15	H443-15D	H443-15N	H443-15ND
18 cm // 7"	H443-18	H443-18D	H443-18N	H443-18ND
21 cm // 8 1/4"	H443-21	H443-21D	H443-21N	H443-21ND
23 cm // 9"	H443-23	H443-23D	-	-

D	<input type="checkbox"/>	Diamantiert // Diamond coated
N	<input type="checkbox"/>	Titan // Titanium
ND	<input type="checkbox"/>	Titan - Diamantiert // Titanium - Diamond coated
NT	<input type="checkbox"/>	Titan - Hartmetall // Titanium - TC
T	<input type="checkbox"/>	Hartmetall // TC

Mikronadelhalter rund

Micro Needle Holders round



23 cm // 9"

	gerade straight	gebogen curved
Mit Sperre With ratchet	H464-23D	H465-23D
Ohne Sperre Without ratchet	H464-73D	H465-73D



Starkes Modell
Strong pattern

Heavy Streamline Box Lock



Mit Sperre With ratchet	gerade straight	gebogen curved
19 cm // 7 1/2"	H460-19D	H461-19D
23 cm // 9"	H460-23D	H461-23D
25 cm // 10"	H460-25D	H461-25D



Ohne Sperre Without ratchet	gerade straight	gebogen curved
19 cm // 7 1/2"	H462-19D	H463-19D
23 cm // 9"	H462-23D	H463-23D
25 cm // 10"	H462-25D	H463-25D



CASTROVIEJO



Mit Sperre With ratchet	gerade straight	gebogen curved
12 cm // 4 3/4"	H470-62	H471-62
12 cm // 4 3/4"	H470-62T	H471-62T
13 cm // 5"	H470-63	H471-63
13 cm // 5"	H470-63T	H471-63T



Ohne Sperre Without ratchet	gerade straight	gebogen curved
12 cm // 4 3/4"	H472-62	H473-62
12 cm // 4 3/4"	H472-62T	H473-62T
13 cm // 5"	H472-63	H473-63
13 cm // 5"	H472-63T	H473-63T

Mikronadelhalter rund Micro Needle Holders round

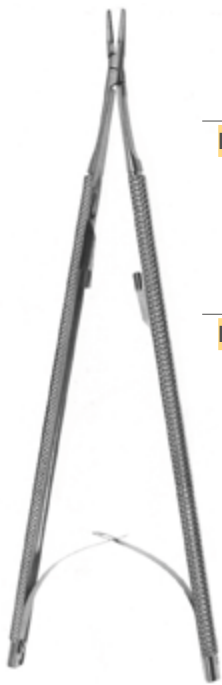

HEPP-SCHEIDEL
18 cm // 7"



H476-18T



H476-68T



KALT
14 cm // 5 1/2"



Standard
Standard

H480-14



TC gerieft
TC serrated

H480-14T



TC glatt
TC smooth

H480-64T

gerade
straight



Standard
Standard

H481-14



TC gerieft
TC serrated

H481-14T

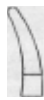

TC glatt
TC smooth

H481-64T

gebogen
curved



CASTROVIEJO-KALT
14 cm // 5 1/2"

H482-14

H482-14T



ARRUGA
14 cm // 5 1/2"

gerade
straight

H484-14

H484-64T

gebogen
curved

H485-14

H485-64T

Unterbindungsnadeln
Ligature Needles



KRONECKER
13 cm // 5"

links, für rechte Hand
left, for right hand

H500-01

rechts, für linke Hand
right, for left hand

H500-02

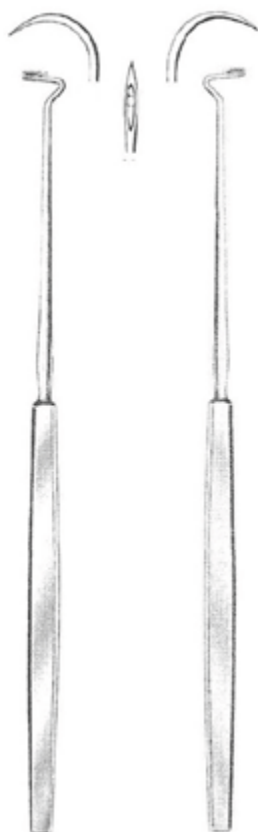

DUPUY-WEISS
22 cm // 8 3/4"

H501-01

H501-02

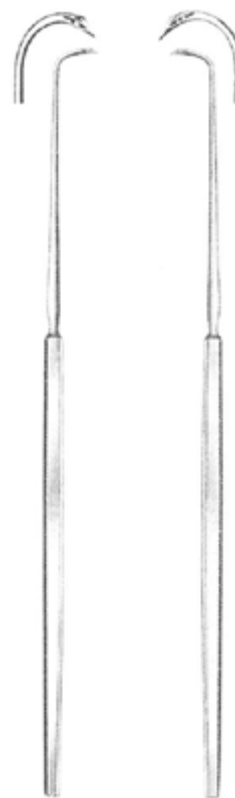

DURHAM
21 cm // 8 1/4"

H505-01

H505-02



HESSBERG
15 cm // 6"
H507-14



JACOBY
14 cm // 5 1/2"
H508-14



WOODRUFF
13 cm // 5"
H509-01 | **H509-02**

Unterbindungsnadeln Ligature Needles

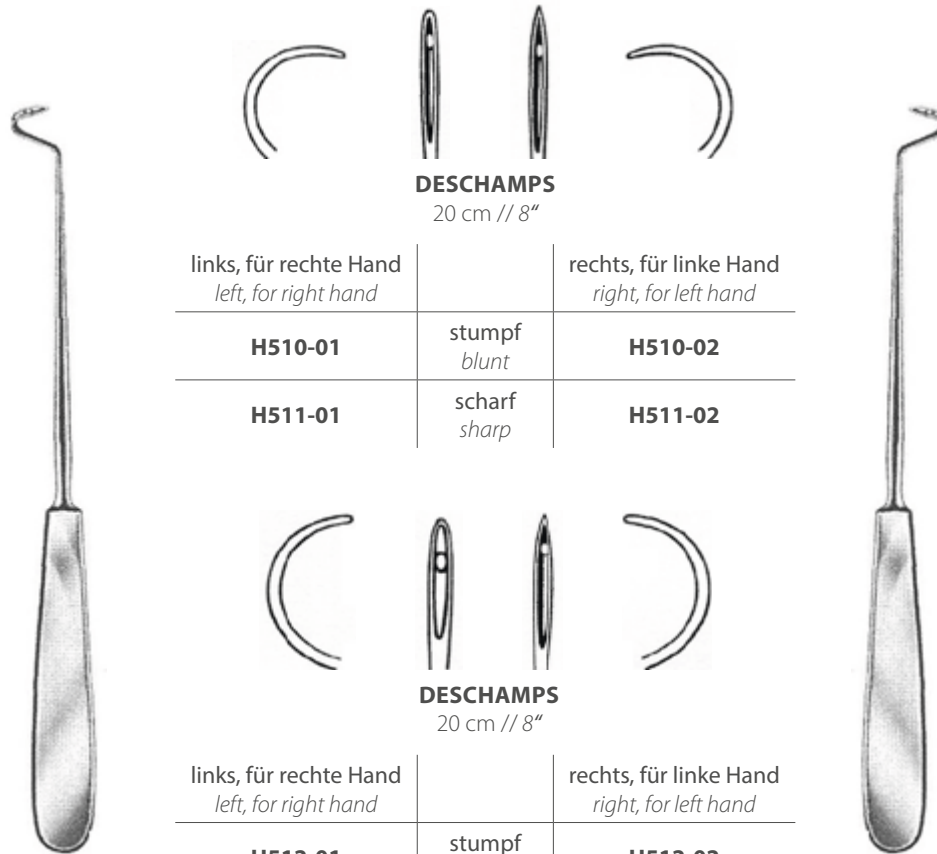

DESCHAMPS
20 cm // 8"

links, für rechte Hand <i>left, for right hand</i>		rechts, für linke Hand <i>right, for left hand</i>
H510-01	stumpf <i>blunt</i>	H510-02
H511-01	scharf <i>sharp</i>	H511-02



DESCHAMPS
20 cm // 8"

links, für rechte Hand <i>left, for right hand</i>		rechts, für linke Hand <i>right, for left hand</i>
H512-01	stumpf <i>blunt</i>	H512-02
H513-01	scharf <i>sharp</i>	H513-02

Steile Biegung
Steep turn



DESCHAMPS
22,5 cm // 8 3/4"

links, für rechte Hand <i>left, for right hand</i>		rechts, für linke Hand <i>right, for left hand</i>
H514-01	stumpf <i>blunt</i>	H514-02

Steile Biegung
Steep turn

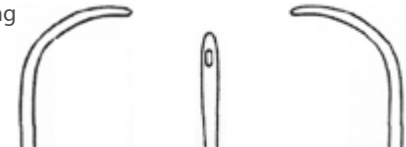

DESCHAMPS
22,5 cm // 8 3/4"

links, für rechte Hand <i>left, for right hand</i>		rechts, für linke Hand <i>right, for left hand</i>
H514-11	stumpf <i>blunt</i>	H514-12

Unterbindungsnadeln
Ligature Needles

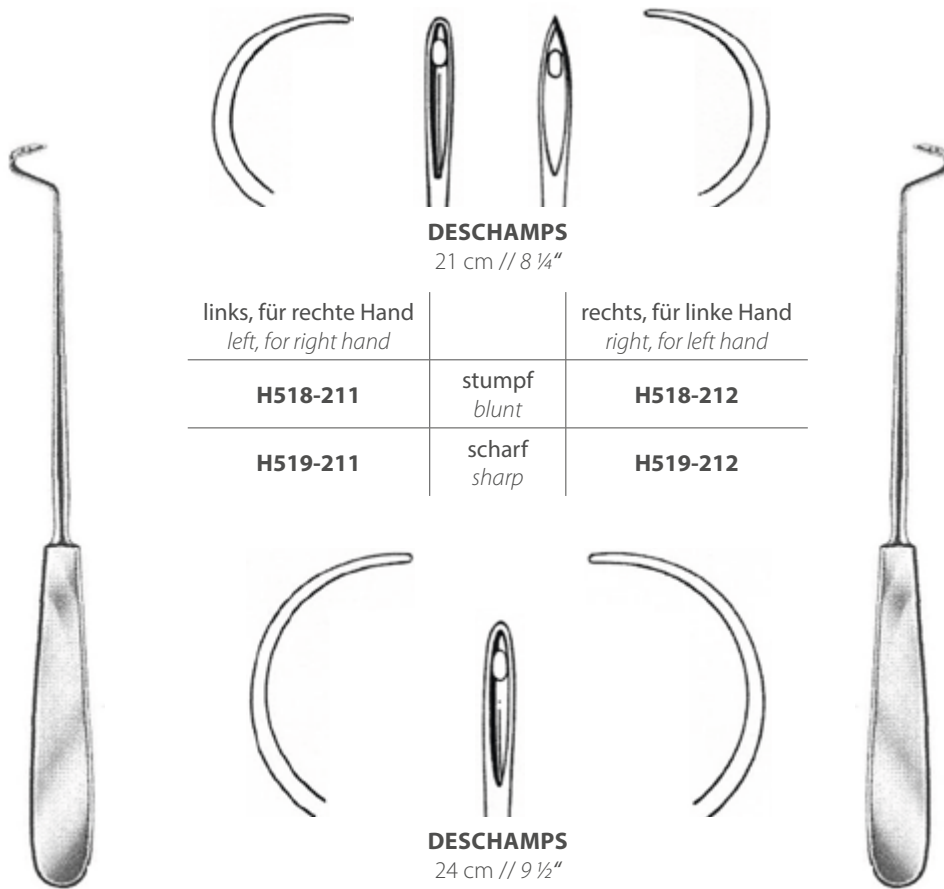

DESCHAMPS
21 cm // 8 ¼"

links, für rechte Hand <i>left, for right hand</i>		rechts, für linke Hand <i>right, for left hand</i>
H518-211	stumpf <i>blunt</i>	H518-212
H519-211	scharf <i>sharp</i>	H519-212

links, für rechte Hand <i>left, for right hand</i>		rechts, für linke Hand <i>right, for left hand</i>
H518-241	stumpf <i>blunt</i>	H518-242

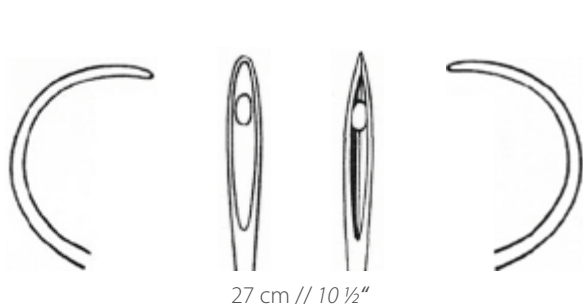

27 cm // 10 ½"

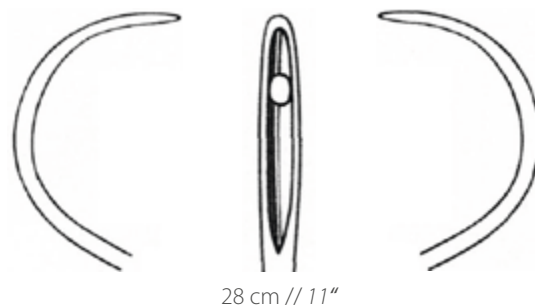

28 cm // 11"

links, für rechte Hand <i>left, for right hand</i>		rechts, für linke Hand <i>right, for left hand</i>
H518-271	stumpf <i>blunt</i>	H518-272
H519-271	scharf <i>sharp</i>	H519-272

links, für rechte Hand <i>left, for right hand</i>		rechts, für linke Hand <i>right, for left hand</i>
H518-281	stumpf <i>blunt</i>	H518-282

Unterbindungsnadeln Ligature Needles



KOCHER
19 cm // 7 ½"



Fig. 1
H530-01



Fig. 2
H530-02



Fig. 3
H530-03

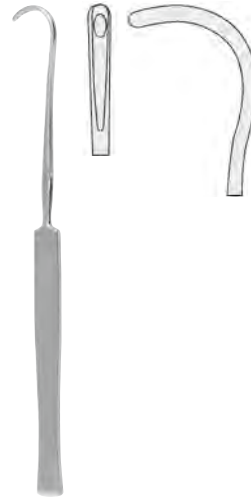

COOPER
19 cm // 7 ½"
H534-19



23 cm // 9"
H536-23



SCHMIEDEN
21 cm // 8 ¼"
H537-21

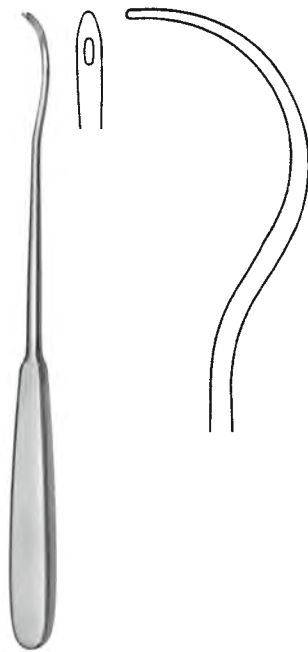

BRUNNER
25 cm // 10"
H539-25

Unterbindungsnadeln
Ligature Needles



REVERDIN

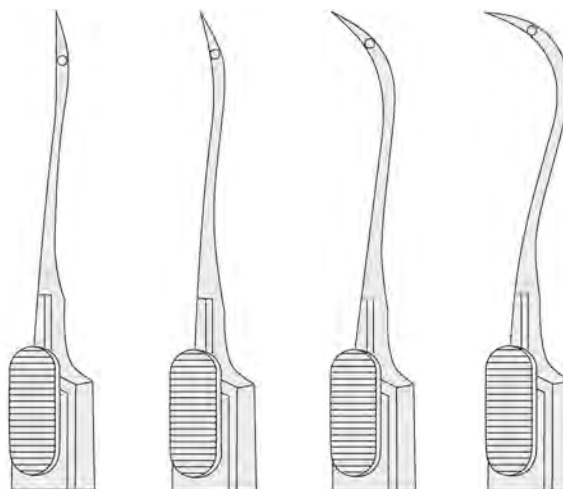

	Fig. 1	Fig. 2	Fig. 3	Fig. 4
14 cm // 5 1/2"	H545-141	H545-142	H545-143	H545-144
	Fig. 1	Fig. 2	Fig. 3	Fig. 4
19,5 cm // 7 3/4"	H545-191	H545-192	H545-193	H545-194
22,5 cm // 8 3/4"	H545-221	H545-222	H545-223	H545-224

Nadel allein
Needle only



YOUNG
Kplt. mit Nadel No. 2
Cplt. with Needle No. 2
H546-00



Fig. 1
H546-01



Fig. 2
H546-02



Fig. 3
H546-03

Nahtinstrumente Suture Instruments



SCHMIEDEN-PAYR
19 cm // 7 1/2"
H551-19



SCHMIEDEN
19 cm // 7 1/2"
H552-19



KÖNIG



19 cm // 7 1/2"
3 mm
H557-01



19 cm // 7 1/2"
5 mm
H557-02

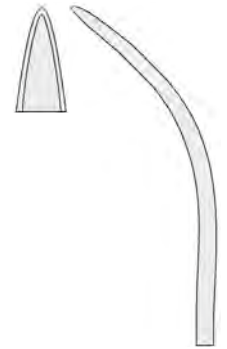

20 cm // 8"
7 mm
H557-03



FERROZELL

18 cm // 7" | **H555-18**
27 cm // 10 1/2" | **H555-27**



PAYR

22 cm // 8 3/4"
H564-22



PAYR

19,5 cm // 7 1/2" | **H565-19**
22 cm // 8 3/4" | **H565-22**

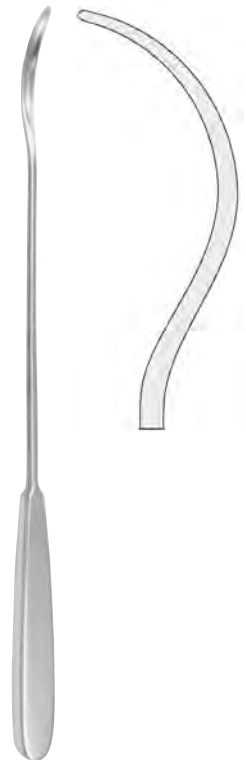

BRUNNER

25 cm // 10"
H567-24

Nahtinstrumente
Suture Instruments

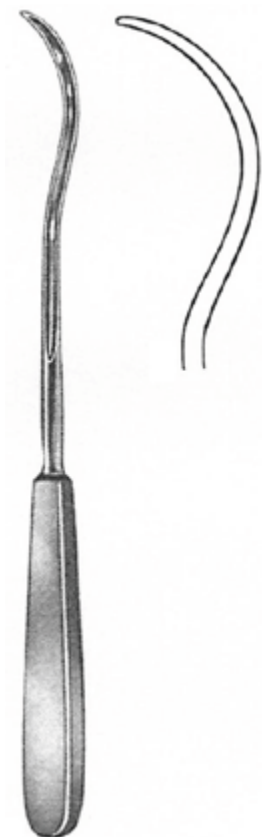

KIRSCHNER
25,5 cm // 10"
H568-25



28 cm // 11"
H570-28

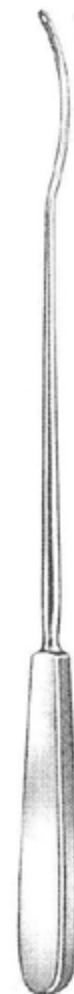

BRUNNER
30 cm // 12"



H575-01

H575-02

Nahtinstrumente
Suture Instruments

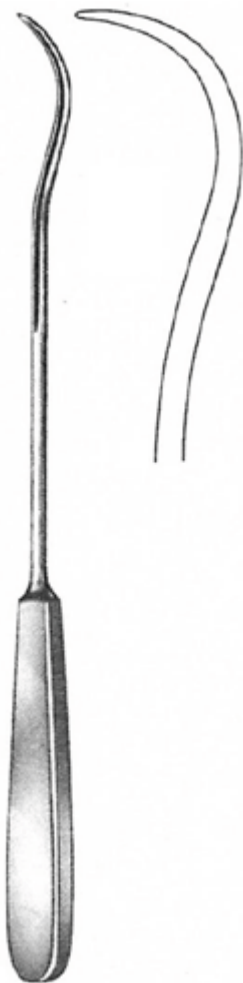

BRUNNER
30 cm // 12"

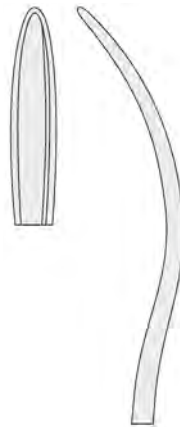

H576-01

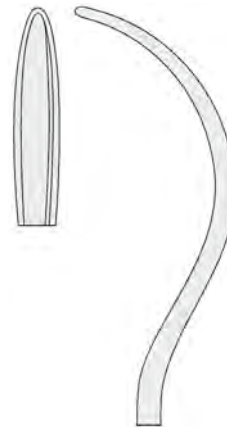

H576-02



H576-03



H576-04

Nahtinstrumente
Suture Instruments

Fadenfänger
Suture Catcher



MOD. WIEN
23,5 cm // 9 1/4"
H580-23

Fadengabel
Ligature Fork



23 cm // 9"
H582-23



Wundklammern
Suture Clips

7,5 x 1,75 mm	H600-07
11 x 2 mm	H600-11
12 x 3 mm	H600-12
14 x 3 mm	H600-14
16 x 3 mm	H600-16
18 x 3 mm	H600-18
20 x 3 mm	H600-20
22 x 3 mm	H600-22

MICHEL
Pck. / 1000 Stück
Pck. / 1000 pcs.



MICHEL
12 cm // 4 3/4"
H602-12



MICHEL MOD.
12 cm // 4 3/4"
H604-12

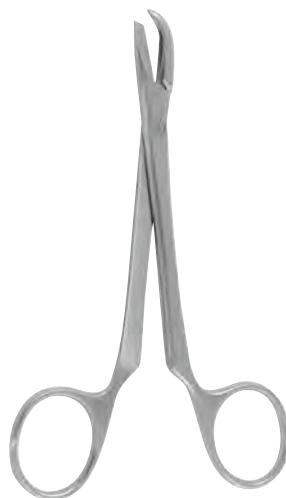

COLLIN
13 cm // 5"
H606-13



RICHTER-HEATH
14 cm // 5 1/2"
H608-14

Wundklammerbesteck, Wundklammerpinzetten Suture Set, Clip Applying forceps

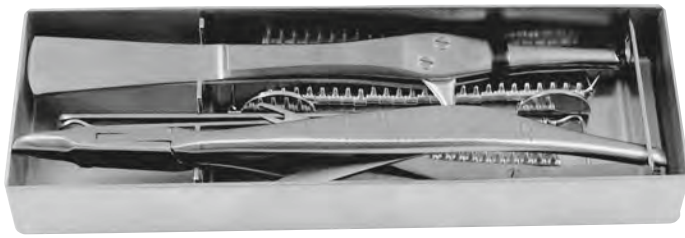

Wundklammerbesteck bestehend aus
H602-12, H625-03, 50 Michel Clips
*Suture set, consisting of
H602-12, H625-03, 50 Michel Clips*

MICHEL
H610-00



MICHEL
12 cm // 4 3/4"
H616-12



WACHENFELDT
12 cm // 4 3/4"
H618-12



WACHENFELDT
12,5 cm // 5"
H620-12



HEGENBARTH
12,5 cm // 5"
H622-12



CHILD
17 cm // 6 3/4"
H625-01



CHILD
17 cm // 6 3/4"
H625-02

Gips-Instrumente
Plaster Instruments



ESMARCH
 18 cm // 7"
H652-18



HOPKINS
 20 cm // 8"
H654-20



ENGEL
H656-00



HENNING
 28 cm // 11"
H680-28

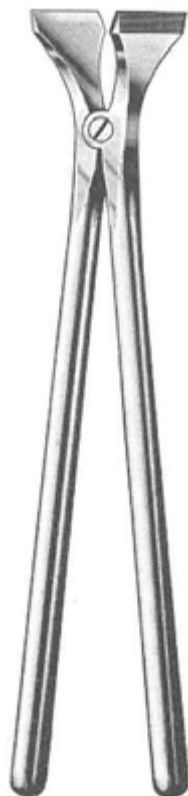

BEESON
 30 cm // 12"
H682-30

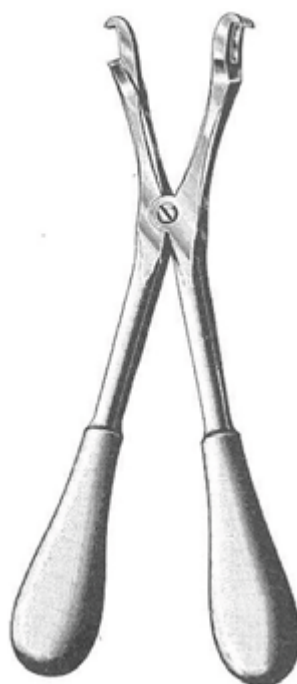

HAGLUND-STILLE
 28 cm // 11"
H684-28



WALTON
 23 cm // 9"
H690-23



WOLFF
 18 cm // 7" | **H695-18**
 24 cm // 9½" | **H695-24**

Oscillierende Gipssägen Oscillating Plaster Saws



Lieferung incl. 1xH705-11, 1xH705-21,
2 Schlüssel und Gebrauchsanweisung
*Delivery incl. 1xH705-11, 1H705-21,
2 keys and instruction manual*

Elektronik Power
H700-00

500 Watt Leistung	<i>500 Watt Power</i>
6500 - 24000 Schwingungen, stufenlos regelbar	<i>6500 - 24000 oscillations</i>
Sehr ruhiger Lauf, 52-77 db(A)	<i>Very silent motor, 52-77db(A)</i>
Modernste Motorelektronik	<i>Latest electronic system</i>
Robuste Konstruktion für höchste Belastbarkeit	<i>Robust construction for continuous operation</i>
Gewicht 1,5 kg	<i>Weight 1,5 kg</i>
Vibrations-, und wartungsarm	<i>Vibrations- and maintenance free</i>
1 Jahr Garantie	<i>1 year guarantee</i>
Mit 5 Meter Eurflachsteckerkabel	<i>With 5 meter cable with EU-connection</i>
Doppelschutzisoliert, Bild-, und Tonfukentstört	<i>Double protection isolation, Radio/TV suppressed</i>
CE-Konform, gepr. EN/IEC 60601-1, EN60601-1-2	<i>CE-Conformity, acc. EN/IEC60601-1, EN60601-1-2</i>



Blue Power
H701-00

210 Watt Leistung	<i>210 Watt Power</i>
10000 - 19000 Schwingungen stufenlos regelbar	<i>10000 - 19000 oscillations</i>
Sehr ruhiger Lauf, 50-72db (A)	<i>Very silent motor, 50-72db(A)</i>
Modernste Motorelektronik	<i>Latest electronic system</i>
Robuste Konstruktion für höchste Belastbarkeit	<i>Robust construction for continuous operation</i>
Gewicht 1,1 kg	<i>Weight 1,1 kg</i>
Vibrations-, und wartungsarm	<i>Vibrations- and maintenance free</i>
1 Jahr Garantie	<i>1 year guarantee</i>
Mit 3 Meter Eurflachsteckerkabel	<i>With 3 meter cable with EU-connection</i>
Doppelschutzisoliert, Bild-, und Tonfukentstört	<i>Double protection isolation, Radio/TV suppressed</i>
CE-Konform, gepr. EN/IEC 60601-1, EN60601-1-2	<i>CE-Conformity, acc. EN/IEC60601-1, EN60601-1-2</i>

Oscillierende Gipssägen
Oscillating Plaster Saws



Absaugung für Gipssäge (ohne Gipssäge)
Vacuum for Plaster Saw (without Plaster Saw)

H702-00

Sägeblätter für oszillierende Gipssägen
Saw blades for Plaster Saws



	45 mm	50 mm	65 mm
Für Naturgipsverbände <i>For normal plaster</i>	H705-01	H705-11	H705-21
Für synthetische Hartverbände <i>For synthetic casts</i>	H705-02	H705-12	H705-22
PTFE-Antihaftbeschichtung <i>PTFE non-sticking coating</i>	-	H705-13	H705-23
HSC-Hartstoffbeschichtung <i>HSC hard-coating</i>	-	H705-14	H705-24
			65 mm
Für Naturgipsverbände <i>For normal plaster</i>		H705-31	
Für synthetische Hartverbände <i>For synthetic casts</i>		H705-32	
			65 mm
Für Naturgipsverbände <i>For normal plaster</i>		H705-41	
Für synthetische Hartverbände <i>For synthetic casts</i>		H705-42	
			8 mm
Für Naturgipsverbände <i>For normal plaster</i>		H705-51	
Für synthetische Hartverbände <i>For synthetic casts</i>		H705-52	
			20 mm
Für Naturgipsverbände <i>For normal plaster</i>		H705-61	
Für synthetische Hartverbände <i>For synthetic casts</i>		H705-62	

Orthopädie

// Orthopaedics

Inhalt

Index

Abschnitt **K**
// Section

Meißel, Osteotome <i>Chisels, Osteotomes</i>	K02 - K10
Stößel <i>Pestle</i>	K11
Hämmer <i>Mallets</i>	K12 - K17
Scharfe Löffel, Knochenfeilen und -raspeln <i>Bone Curettes, Bone Files and Rasps</i>	K18 - K25
Raspatorien, Elevatorien <i>Raspatories, Elevators</i>	K26 - K37
Knochenhebel <i>Bone Levers</i>	K38 - K42
Knochenhalte­zangen <i>Bone Holding Forceps</i>	K43 - K51
Hohlmeißelzangen, Knochensplitterzangen <i>Bone Rongeur Forceps, Bone Cutting Forceps</i>	K52 - K64
Handbohrapparate <i>Hand Drills</i>	K65 - K68
Extensionsbügel <i>Extension Bows</i>	K69
Drahtinstrumente <i>Wire Instruments</i>	K70 - K78

Meißel, Osteotome
Chisels, Osteotomes



PARTSCH
Flachmeißel
Chisel

	11,5 cm // 4 1/2"	13,5 cm // 5 1/4"
2 mm	K100-112	K100-132
3 mm	K100-113	K100-133
4 mm	K100-114	K100-134
5 mm	K100-115	K100-135
6 mm	K100-116	K100-136
7 mm	K100-117	K100-137
8 mm	K100-118	K100-138



PARTSCH
Hohlmeißel
Gouge

	11,5 cm // 4 1/2"	13,5 cm // 5 1/4"
2 mm	K101-112	K101-132
3 mm	K101-113	K101-133
4 mm	K101-114	K101-134
5 mm	K101-115	K101-135
6 mm	K101-116	K101-136
7 mm	K101-117	K101-137
8 mm	K101-118	K101-138



13,5 cm // 5 1/4"

	Osteotom <i>Osteotom</i>	Meißel <i>Chisel</i>	Hohlmeißel <i>Gouge</i>
4 mm	K106-04	K107-04	K108-04
6 mm	K106-06	K107-06	K108-06
8 mm	K106-08	K107-08	K108-08
10 mm	K106-10	K107-10	K108-10
12 mm	K106-12	K107-12	K108-12
14 mm	K106-14	K107-14	K108-14
16 mm	K106-16	K107-16	K108-16



LUCAS
16 cm // 6 1/4"

	Flachmeißel <i>Chisel</i>	Hohlmeißel <i>Gouge</i>
4 mm	K110-04	K111-04
6 mm	K110-06	K111-06

Flachmeißel, Hohlmeißel, Osteotome Chisels, Gouges, Osteotomes



MOD. USA
16 cm // 6 1/4"



	Flachmeißel <i>Chisel</i>	Osteotom <i>Osteotom</i>	Hohlmeißel <i>Gouge</i>
6 mm	K113-06	K114-06	K115-06
12 mm	K113-12	K114-12	K115-12
18 mm	K113-18	K114-18	K115-14



WEST
19 cm // 7 1/2"

	Osteotom <i>Osteotom</i>	Hohlmeißel <i>Gouge</i>
6 mm	K116-01	K116-02



MINI-LAMBOTTE
12,5 cm // 5"

	Osteotom <i>Osteotom</i>	
	gerade <i>straight</i>	gebogen <i>curved</i>
2 mm	K118-102	K118-202
3 mm	K118-103	-
4 mm	K118-104	K118-204
6 mm	K118-106	K118-206
8 mm	K118-108	K118-208
10 mm	K118-110	K118-210
12 mm	K118-112	K118-212
14 mm	K118-114	K118-214
15 mm	K118-115	-
18 mm	K118-118	-
19 mm	K118-119	-
20 mm	K118-120	-



MINI-LAMBOTTE
17 cm // 6 3/4"

	Osteotom <i>Osteotom</i>
	gerade <i>straight</i>
2 mm	K118-502
3 mm	K118-503
4 mm	K118-504
6 mm	K118-506
8 mm	K118-508
10 mm	K118-510
12 mm	K118-512
15 mm	K118-515



MINI-LAMBOTTE
17 cm // 6 3/4"

	Osteotom <i>Osteotom</i>
	gerade mit Kalibrierung <i>straight, with calibration</i>
4 mm	K119-104
5 mm	K119-105
6 mm	K119-106
8 mm	K119-108
10 mm	K119-110
12 mm	K119-112
16 mm	K119-116
19 mm	K119-119
22 mm	K119-122
25 mm	K119-125

Flachmeißel, Hohlmeißel, Osteotome
Chisels, Gouges, Osteotomes



LAMBOTTE
24 cm // 9"

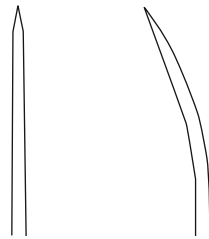

	Osteotom Osteotom	
	gerade straight	gebogen curved
4 mm	K122-104	K122-204
6 mm	K122-106	K122-206
8 mm	K122-108	K122-208
10 mm	K122-110	K122-210
13 mm	K122-113	K122-213
16 mm	K122-116	K122-216
18 mm	K122-118	K122-218
19 mm	K122-119	K122-219
20 mm	K122-120	K122-220
25 mm	K122-125	K122-225
30 mm	K122-130	K122-230
32 mm	K122-132	K122-232
38 mm	K122-138	K122-238
44 mm	K122-144	K122-244
50 mm	K122-150	K122-250



HOKE
14 cm // 5 1/2"

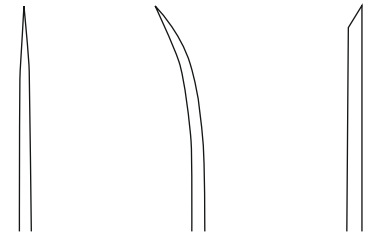

	Osteotom Osteotom		Meißel Chisel
	gerade straight	gebogen curved	gerade straight
2 mm	K126-102	K126-202	-
3 mm	K126-103	K126-203	-
4 mm	K126-104	K126-204	K126-504
5 mm	K126-105	K126-205	-
6 mm	K126-106	K126-206	K126-506
7 mm	K126-107	K126-207	-
8 mm	K126-108	K126-208	-
9 mm	K126-109	K126-209	-
10 mm	K126-110	K126-210	K126-510
12 mm	K126-112	K126-212	-
13 mm	K126-113	K126-213	K126-513
15 mm	K126-115	K126-215	-
16 mm	K126-116	K126-216	K126-516
19 mm	K126-119	-	-



ALEXANDER
18 cm // 7"

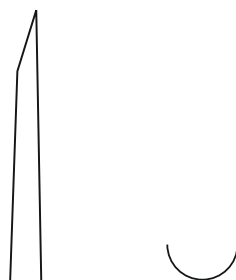

	Flachmeißel Chisels	Hohlmeißel Gouges
4 mm	K130-04	K131-04
6 mm	K130-06	K131-06
8 mm	K130-08	K131-08
10 mm	K130-10	K131-10
12 mm	K130-12	K131-12
14 mm	K130-14	K131-14



MINI-LEXER
18 cm // 7"

	Osteotom Osteotom	Hohlmeißel Gouge
4 mm	K134-104	K135-104
6 mm	K134-106	K135-106
8 mm	K134-108	K135-108
10 mm	K134-110	K135-110
12 mm	K134-112	K135-112

LEXER
22 cm // 8 3/4"

	Osteotom Osteotom	Hohlmeißel Gouge
5 mm	K136-105	K137-105
7 mm	K136-107	K137-107
10 mm	K136-110	K137-110
15 mm	K136-115	K137-115
20 mm	K136-120	K137-120
25 mm	K136-125	K137-125
30 mm	K136-130	K137-130

Flachmeißel, Hohlmeißel, Osteotome Chisels, Gouges, Osteotomes



Hohlmeißel
Gouge

ZIELKE
23 cm // 9"

5,5 mm	K138-05
9 mm	K138-09



SMITH-PETERSEN
20,5 cm // 8"



	Osteotom <i>Osteotom</i>		Hohlmeißel <i>Gouge</i>	
	gerade <i>straight</i>	gebogen <i>curved</i>	gerade <i>straight</i>	gebogen <i>curved</i>
6 mm	K140-106	K140-206	K141-106	K141-206
9 mm	K140-109	K140-209	K141-109	K141-209
13 mm	K140-113	K140-213	K141-113	K141-213
16 mm	K140-116	K140-216	K141-116	K141-216
19 mm	K140-119	K140-219	K141-119	K141-219
25 mm	K140-125	K140-225	K141-125	K141-225
32 mm	K140-132	K140-232	K141-132	K141-232



COBB
27,5 cm // 11"

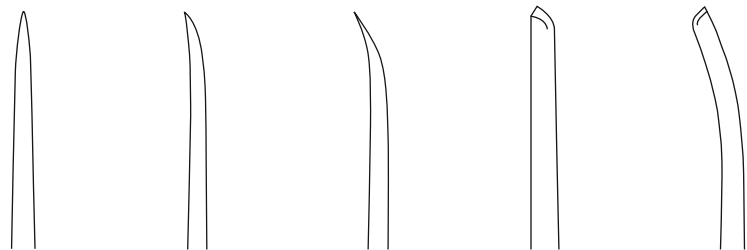

		Osteotom <i>Osteotom</i>			Hohlmeißel <i>Gouge</i>	
		gerade <i>straight</i>	gebogen <i>curved</i>	stark gebogen <i>strong curved</i>	gerade <i>straight</i>	gebogen <i>curved</i>
19 cm // 7 1/2"	6 mm	K145-01	K145-11	-	-	-
	6 mm	K145-02	K145-12	K145-22	-	-
24 cm // 9 1/2"	8 mm	K145-03	K145-13	-	-	-
	10 mm	K145-04	-	-	-	-
27,5 cm // 11"	6 mm	K146-106	K146-206	-	K147-106	K147-206
	10 mm	K146-110	K146-210	-	K147-110	K147-210
	13 mm	K146-113	K146-213	-	K147-113	K147-213
	16 mm	K146-116	K146-216	-	K147-116	K147-216
	19 mm	K146-119	K146-219	-	K147-119	K147-219
	25 mm	K146-125	K146-225	-	K147-125	K147-225
32 mm	K146-132	K146-232	-	K147-132	K147-232	

Flachmeißel, Hohlmeißel, Osteotome
Chisels, Gouges, Osteotomes



STILLE
20 cm // 8"

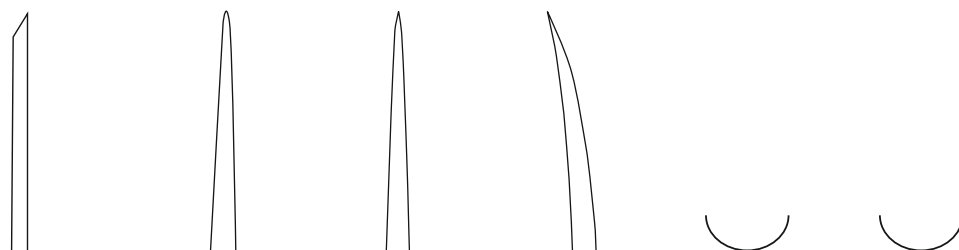

	Flachmeißel <i>Chisel</i>	Osteotom <i>Osteotom</i>			Hohlmeißel <i>Gouge</i>	
	gerade <i>straight</i>	gerade <i>straight</i>	fein, gerade <i>fine, straight</i>	gebogen <i>curved</i>	gerade <i>straight</i>	gebogen <i>curved</i>
6 mm	K150-106	K151-106	-	K151-506	K152-106	K152-506
8 mm	K150-108	K151-108	-	K151-508	K152-108	K152-508
10 mm	K150-110	K151-110	K151-210	K151-510	K152-110	K152-510
12 mm	K150-112	K151-112	K151-212	K151-512	K152-112	K152-512
14 mm	K150-114	K151-114	-	-	K152-114	-
15 mm	K150-115	K151-115	K151-215	K151-515	K152-115	K152-515
18 mm	K150-118	K151-118	-	-	K152-118	-
20 mm	K150-120	K151-120	K151-220	K151-520	K152-120	K152-520
22 mm	K150-122	K151-122	-	-	K152-122	-
25 mm	K150-125	K151-125	K151-225	K151-525	K152-125	K152-525
30 mm	K150-130	K151-130	-	K151-530	K152-130	-



HIBBS
24 cm // 9 1/2"

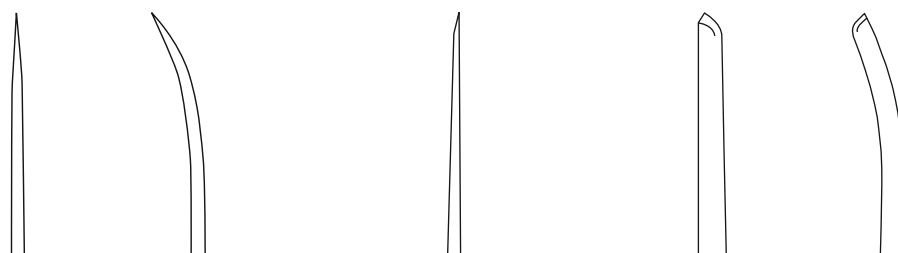

	Osteotom <i>Osteotom</i>		Flachmeißel <i>Chisel</i>		Hohlmeißel <i>Gouge</i>	
	gerade <i>straight</i>	gebogen <i>curved</i>	gerade <i>straight</i>	gebogen <i>curved</i>	gerade <i>straight</i>	gebogen <i>curved</i>
6 mm	K156-106	K156-206	K157-106	K157-206	K158-106	K158-206
9 mm	K156-109	K156-209	K157-109	K157-209	K158-109	K158-209
13 mm	K156-113	K156-213	K157-113	K157-213	K158-113	K158-213
16 mm	K156-116	K156-216	K157-116	K157-216	K158-116	K158-216
19 mm	K156-119	K156-219	K157-119	K157-219	K158-119	K158-219
22 mm	K156-122	K156-222	K157-122	K157-222	K158-122	K158-222
25 mm	K156-125	K156-225	K157-125	K157-225	K158-125	K158-225
28 mm	K156-128	K156-228	K157-128	K157-228	K158-128	K158-228
32 mm	K156-132	K156-232	K157-132	K157-232	K158-132	K158-232
38 mm	K156-138	K156-238	K157-138	K157-238	K158-138	K158-238

Flachmeißel, Hohlmeißel, Osteotome Chisels, Gouges, Osteotomes

Hohlmeißel „Schwanenhals“
Swan Neck Gouge



23 cm // 9"

K161-23

Schultermeißel
Shoulder Gouge



22 cm // 8 1/2"

K162-22

Hohlmeißel
Gouge



LEXER
25 cm // 10"



	gerade straight	gebogen curved
5 mm	K164-105	K164-305
10 mm	K164-110	K164-310
15 mm	K164-115	K164-315

Hohlmeißel
Gouge



COBB

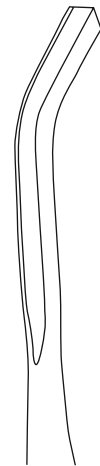
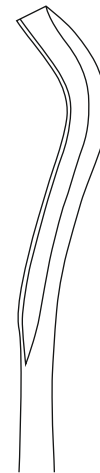

	gerade straight	gebogen curved	stark gebogen strong curved	rückwärts gebogen curved backwards
24 cm / 8 mm 9 1/2" / 8 mm 6-Kant Metallgriff Hexagonal Metal handle	K166-01	K166-02	K166-03	K166-04
28 cm / 8 mm 11" / 8 mm Ferrozellgriff Ferrozell-Handle	K166-11	K166-12	K166-13	K166-14
Rundgriff Metall Knurled Metal handle	K166-61	K166-62	K166-63	K166-64

Meißel, Hohlmeißel
Chisels, Gouges



Hohlmeißel
Gouge

LEXER
28 cm // 11"
10 mm

K168-19



Flachmeißel
Chisel

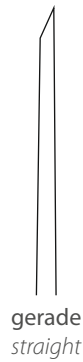

gerade
straight

24,5 cm // 9 3/4"
20 mm

K170-01



Flachmeißel
Chisel

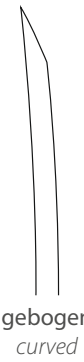

gebogen
curved

26,5 cm // 10 1/2"
16 mm

K170-11



Hohlmeißel
Gouge

22 cm // 8 3/4"
9 mm

K169-22



LEXER
27,5 cm // 10 3/4"



Osteotom
Osteotom

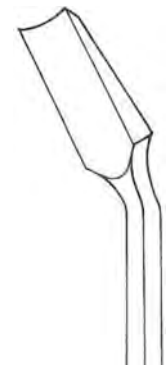

Hohlmeißel
Gouge

abgewinkelt // angled

10 mm	K171-110	K172-110
15 mm	K171-115	K172-115

Osteotome, Hohlmeißel Osteotomes, Gouges



DAHMEN
30 cm // 11 3/4"

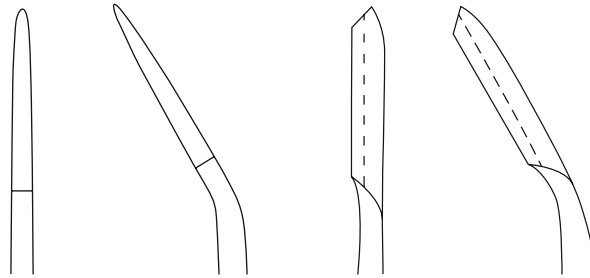

	Osteotom <i>Osteotom</i>		Hohlmeißel <i>Gouge</i>	
	gerade <i>straight</i>	gebogen <i>curved</i>	gerade <i>straight</i>	gebogen <i>curved</i>
4 mm	K174-104	K174-204	K175-104	K175-204
5 mm	K174-105	K174-205	K175-105	K175-205
6 mm	K174-106	K174-206	K175-106	K175-206
8 mm	K174-108	K174-208	K175-108	K175-208
10 mm	K174-110	K174-210	K175-110	K175-210
12 mm	K174-112	K174-212	K175-112	K175-212
15 mm	K174-115	K174-215	K175-115	K175-215
20 mm	K174-120	K174-220	K175-120	K175-220
22 mm	K174-122	K174-222	K175-122	K175-222
25 mm	K174-125	K174-225	K175-125	K175-225



WAGNER
34 cm // 13 1/2"

Hohlmeißel
Gouge

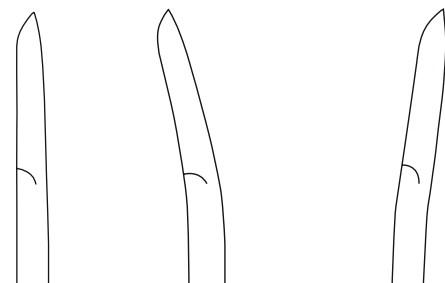

	gerade <i>straight</i>	aufgebogen <i>curved forward</i>	rückwärts gebogen <i>curved backwards</i>
9 mm	K179-01	K179-02	K179-03
15 mm	K179-11	K179-12	K179-13

Meißel mit auswechselbaren Aufsätzen
Chisel with exchangeable tips



Griff allein
Handle only

K185-01



Schlüssel
Key

K185-98

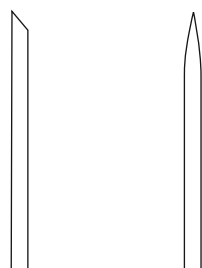
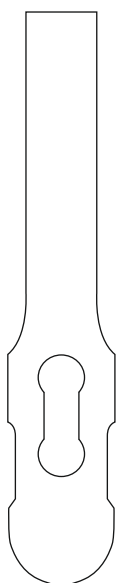

	Flachmeißel <i>Chisel</i>	Osteotom <i>Osteotom</i>
5 mm	K185-05	K185-55
10 mm	K185-10	K185-60
16 mm	K185-16	K185-66
25 mm	K185-25	K185-75

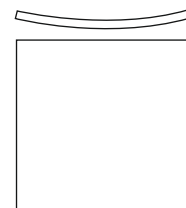

	Hohlmeißel <i>Gouge</i>
	25 mm
R = 50 mm	K185-85
R = 60 mm	K185-86
R = 70 mm	K185-87

Stößel Pestle



16 cm // 6 1/4"

2 mm	K190-02
3 mm	K190-03
4 mm	K190-04
5 mm	K190-05
6 mm	K190-06
8 mm	K190-08
10 mm	K190-10
20 mm	K190-20



PASSOW
12 cm // 4 3/4"

2,5 mm	K191-02
3,5 mm	K191-03



20 cm // 8"

3 mm	K192-03
5 mm	K192-05
8 mm	K192-08
12 mm	K192-12
14 mm	K192-14
16 mm	K192-16



SYPERT
29cm // 11 1/2"

3 x 8 mm	K195-08
4 x 10 mm	K195-10
5 x 15 mm	K195-15
6 x 20 mm	K195-20

Hämmer
Mallets

Gewichtsangaben beziehen sich auf den Kopf des Hammers
Weights mentioned refer to the head of the mallets



Mit auswechselbaren Ferrozellbacken
With exchangeable Ferrozell Jaws



ø 20 mm

bleigefüllt 80 g
leaf filled 80 g

K200-01

Stahl massiv 100 g
Solid Steel 100 g

K200-02

16,5 cm // 6 1/2"



ø 26 mm
180 g

Ersatzbackenpaar
Pair of spare Jaws

K201-51

MEAD

17 cm // 6 3/4"

K201-17



Stahl massiv 160 g
Solid Steel 160 g

GARDNER

14 cm // 5 1/2"

K203-14

Mit auswechselbaren Backen
With exchangeable Jaws



ø 20 mm
Stahl massiv 70 g
Solid Steel 70 g

18 cm // 7"

K205-18



ø 25 mm
140 g



Ersatzbackenpaar
Pair of spare Jaws

K206-51

18 cm // 7"

K206-18



ø 20 mm
ø 8 mm

20 cm // 8"

K208-20

Hämmer Mallets

Mit 1 auswechselbarer Kunststoffbacke
With 1 exchangeable Nylon Cap

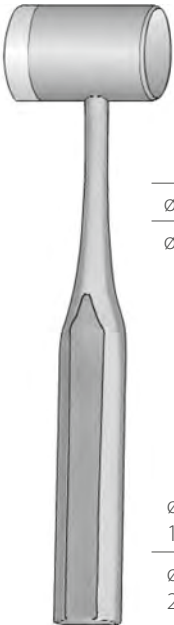

	Kunststoffbacke Nylon Cap
ø 26 mm	K209-91
ø 30 mm	K209-92

ø 26 mm 150 g	K209-01
ø 30 mm 240 g	K209-02

18 cm // 7"



6 x 20 mm

HEERMANN
19,5 cm // 7 3/4"
K210-19

Mit Kupferfüllung
With Copperfilled head



	18,5 cm // 7 1/4"
ø 40 mm 660 g	K211-18
	20 cm // 8"
ø 45 mm 725 g	K211-20

HEATH



ø 22 mm
200 g

PARTSCH
18 cm // 7"
K212-18



ø 19 mm	K213-01
ø 26 mm	K213-02

1 Seite glatt, 1 aufgerauht
1 part smooth, 1 part rough

ø 26 mm	K213-11
---------	----------------

LUCAE
19 cm // 7 1/2"



ø 22 mm
160 g

19 cm // 7 1/2"
K215-19

Hämmer
Mallets

Gewichtsangaben beziehen sich auf den Kopf des Hammers
Weights mentioned refer to the head of the mallets



ø 25 mm
260 g

GERZOG
19 cm // 7 1/2"
K217-19



ø 30 mm
240 g
flach / convex
flat / convex

COTTLE
19 cm // 7 1/2"
K218-19



ø 40 mm
680 g

KIRK
21 cm // 8 1/4"
K220-19



ø 38 mm
360 g

HIBBS
20 cm // 8"
K221-20



ø 27 mm
160 g

HAJEK
21 cm // 8 1/4"
K222-23



ø 26 mm
160 g
bleigefüllt
lead filled

WILLIGER
23 cm // 9"
K224-23

Hämmer Mallets



22 cm // 8 1/2"

ø 30 mm 180 g	K227-30
ø 35 mm 300 g	K227-35
ø 40 mm 380 g	K227-40
ø 45 mm 540 g	K227-45
ø 50 mm 750 g	K227-50

Mit auswechselbaren Kunststoffbacken
With exchangeable plastic Jaws



24 cm // 9 3/4"

K228-24

ø 30 mm
230 g

Ersatzbackenpaar
Pair of spare Jaws

K228-51



ø 30 mm
240 g

COLLIN
20 cm // 8"

K230-23



CLOWARD

20 cm // 8"	ø 19 mm 220 g	K232-20
22 cm // 8 1/2"	ø 25 mm 340 g	K232-22



US-MODELL
18 cm // 7"

ø 35 mm 540 g	K233-01
ø 40 mm 749 g	K233-02



ø 30 mm
300 g

BERGMANN
23cm // 9"
K230-23

Hämmer
Mallets

Gewichtsangaben beziehen sich auf den Kopf des Hammers
Weights mentioned refer to the head of the mallets



ø 45 mm
380 g

BERGMANN
24 cm // 9 1/2"

K235-02



ø 30 mm
ø 42 mm
400 g

BERGMANN
24 cm // 9 1/2"

K235-03



ø 40 mm
560 g

OMBREDANNE
24 cm // 9 1/2"

K236-24

Kopf aus Implantatwerkstoff
Head made of implants material



ø 24 mm
ø 14 mm
230 g

23 cm // 9"

K237-23



24 cm // 9 1/2"	ø 35 mm 540 g	K238-01
28 cm // 11"	ø 50 mm 1400 g	K238-02

US-MODELL

Hämmer Mallets

Mit auswechselbaren Backen
With exchangeable Jaws



ø 45 mm

23,5 mm // 9 3/4"

K242-23

Metallbackenpaar
Pair of Metal Jaws

K242-51



Kunststoffbackenpaar
Pair of plastic Jaws

K242-52



Schlüssel
Wrench

K242-53



ø 30 mm
380 g

24 cm // 9 1/2"

K245-24



ø 35 mm
100 g

K246-35

ø 43 mm
170 g

K246-43

ø 50 mm
220 g

K246-50

26 cm // 10 1/4"



ø 35 mm
560 g

K247-01

ø 50 mm
1500 g

K247-02

26 cm // 10 1/4"



QUISLING
18 cm // 7"

K248-17

Scharfe Löffel
Bone Currettes



VOLKMANN
17 cm // 6 3/4"

	Hohlgriff <i>Hollow handle</i>	Ferrozell-Griff <i>Ferrozell-Handle</i>
Fig. 0000	K250-40	K250-90
Fig. 000	K250-30	K250-80
Fig. 00	K250-20	K250-70
Fig. 0	K250-10	K250-60
Fig. 1	K250-01	K250-51
Fig. 2	K250-02	K250-52
Fig. 3	K250-03	K250-53
Fig. 4	K250-04	K250-54
Fig. 5	K250-05	K250-55
Fig. 6	K250-06	K250-56



BRUNS
17 cm // 6 3/4"

	Hohlgriff <i>Hollow handle</i>
Fig. 000	K252-30
Fig. 00	K252-20
Fig. 0	K252-10
Fig. 1	K252-01
Fig. 2	K252-02
Fig. 3	K252-03
Fig. 4	K252-04
Fig. 5	K252-05
Fig. 6	K252-06



SCHEDE
17 cm // 6 3/4"

	Hohlgriff <i>Hollow handle</i>
Fig. 000	K254-30
Fig. 00	K254-20
Fig. 0	K254-10
Fig. 1	K254-01
Fig. 2	K254-02
Fig. 3	K254-03
Fig. 4	K254-04

Scharfe Löffel Bone Curettes



SPRATT
17 cm // 6 3/4"

	gerade <i>straight</i>
Fig. 00000	K256-50
Fig. 0000	K256-40
Fig. 000	K256-30
Fig. 00	K256-20
Fig. 0	K256-10
Fig. 1	K256-01
Fig. 2	K256-02
Fig. 3	K256-03
Fig. 4	K256-04
Fig. 5	K256-05
Fig. 6	K256-06



SPRATT
20 cm // 8"

	gerade <i>straight</i>	abgewinkelt <i>angled</i>	rückwärts gewinkelt <i>angled backwards</i>
Fig. 000	K257-030	K257-130	K257-330
Fig. 00	K257-020	K257-120	K257-220
Fig. 0	K257-010	K257-110	K257-210
Fig. 1	K257-001	K257-101	K257-201
Fig. 2	K257-002	K257-102	K257-202
Fig. 3	K257-003	K257-103	K257-203
Fig. 4	K257-004	K257-104	K257-204
Fig. 5	K257-005	K257-105	K257-205
Fig. 6	K257-006	K257-106	K257-206



SPRATT
23 cm // 9"

	gerade <i>straight</i>	abgewinkelt <i>angled</i>	rückwärts gewinkelt <i>angled backwards</i>
Fig. 000	K258-130	K258-230	K258-330
Fig. 00	K258-120	K258-220	K258-320
Fig. 0	K258-110	K258-210	K258-310
Fig. 1	K258-101	K258-201	K258-301
Fig. 2	K258-102	K258-202	K258-302
Fig. 3	K258-103	K258-203	K258-303
Fig. 4	K258-104	K258-204	K258-304
Fig. 5	K258-105	K258-205	K258-305
Fig. 6	K258-106	K258-206	K258-306

Scharfe Löffel
Bone Curettes



	rund // round	oval // oval
2 mm	K259-02	K260-02
3 mm	K259-03	K260-03
4 mm	K259-04	K260-04
5 mm	K259-05	K260-05
6 mm	K259-06	K260-06
7 mm	K259-07	K260-07
8 mm	K259-08	K260-08
10 mm	K259-10	K260-10
12 mm	K259-12	K260-12
14 mm	K259-14	K260-14

SCHWEDISCHES MODELL
SWEDISH PATTERN
17-22 cm // 6 3/4"-8 3/4"



	rund // round	oval // oval
Fig. 00	K262-20	K263-20
Fig. 0	K262-10	K263-10
Fig. 1	K262-01	K263-01
Fig. 2	K262-02	K263-02

WILLIGER
17,5 cm // 7"



links // left	K266-01
rechts // right	K266-02

UFFENORDE
17 cm // 6 3/4"



Fig. 00	K268-20
Fig. 0	K268-10
Fig. 1	K268-01
Fig. 2	K268-02

DAUBENSPECK
20 cm // 8"



		
gerade straight	abgewinkelt angled	rückw. gewinkelt angled backwards
K269-01	K269-02	K269-03

SCOVILLE
25 cm // 10"

Scharfe Löffel Bone Curettes



1,6 mm	K270-01
2,0 mm	K270-02
2,3 mm	K270-03
2,8 mm	K270-04
3,4 mm	K270-05
3,8 mm	K270-06
4,3 mm	K270-07

LEMPERT
20 cm // 8"



Fig. 000	K271-30
Fig. 00	K271-20
Fig. 0	K271-10

EPSTEIN
20cm // 8"



	biegsam <i>malleable</i>
Fig. 1	K272-01
Fig. 2	K272-02
Fig. 3	K272-03

HALLE
21 cm // 8 1/4"



Fig. 0000	K274-40
Fig. 000	K274-30
Fig. 00	K274-20
Fig. 0	K274-10

SIMON
24 cm // 9 1/2"



3 mm	K290-03
4 mm	K290-04
5 mm	K290-05

BUSHE
25 cm // 10"



	gerade <i>straight</i>	gewinkelt <i>angled</i>
Fig. 000	K292-01	K292-11
Fig. 00	K292-02	K292-12
Fig. 0	K292-03	K292-13
Fig. 1	K292-04	K292-14

25 cm // 10"

Scharfe Löffel
Bone Curettes



	gerade <i>straight</i>	gewinkelt <i>angled</i>
3,6 mm	K294-01	K294-11
4,4 mm	K294-02	K294-12
5,2 mm	K294-03	K294-13

22 cm // 8 3/4"



Fig. 0	K295-01
Fig. 1	K295-02
Fig. 2	K295-03
Fig. 3	K295-10

27 cm // 10 1/2"



	gerade // <i>straight</i>		gewinkelt // <i>angled</i>	
	Griff Aluminium <i>Aluminium handle</i>	Griff Rostfrei <i>Handle Stainless</i>	Griff Aluminium <i>Aluminium handle</i>	Griff Rostfrei <i>Handle Stainless</i>
Fig. 000	K296-30	K296-80	K297-30	K297-80
Fig. 00	K296-20	K296-70	K297-20	K297-70
Fig. 0	K296-10	K296-60	K297-10	K297-60
Fig. 1	K296-01	K296-51	K297-01	K297-51
Fig. 2	K296-02	K296-52	K297-02	K297-52
Fig. 3	K296-03	K296-53	K297-03	K297-53
Fig. 4	K296-04	K296-54	K297-04	K297-54
Fig. 5	K296-05	K296-55	K297-05	K297-55
Fig. 6	K296-06	K296-56	K297-06	K297-56

COBB

28 cm // 11"

Scharfe Löffel Bone Currettes



BRUNS
23 cm // 9"



gerade
straight



gewinkelt
angled

	gerade <i>straight</i>	gewinkelt <i>angled</i>
Fig. 000	K300-30	K301-30
Fig. 00	K300-20	K301-20
Fig. 0	K300-10	K301-10
Fig. 1	K300-01	K301-01
Fig. 2	K300-02	K301-02
Fig. 3	K300-03	K301-03
Fig. 4	K300-04	K301-04
Fig. 5	K300-05	K301-05
Fig. 6	K300-06	K301-06



CONE
23 cm // 9"

Ringkurren
Bone Currettes



gerade
straight



gewinkelt
angled

	gerade <i>straight</i>	gewinkelt <i>angled</i>
3 mm	K306-03	K306-13
6 mm	K306-06	K306-16
8 mm	K306-08	K306-18

Scharfe Löffel
Bone Curettes



MARTINI
13,5 cm // 5 1/4"
3,1 / 2,6 mm | **K310-00**
4,2 / 3,1 mm | **K310-01**
4,8 / 4,2 mm | **K310-02**



WILLIGER
13,5 cm // 5 1/4"
3,0 / 2,5 mm | **K311-01**
3,5 / 3,0 mm | **K311-02**
4,2 / 3,5 mm | **K311-03**



JACOBSEN
13 cm // 5"
K312-13



VOLKMANN
13 cm // 5" | **K313-13**
14 cm // 5 1/2" | **K313-14**
17 cm // 6 3/4" | **K313-17**
20 cm // 8" | **K313-20**



VOLKMANN
13 cm // 5" | **K314-13**
16 cm // 6 3/4" | **K314-16**
20 cm // 8" | **K314-20**



JANZEN
15 cm // 6"
K316-15



JANZEN
16 cm // 6 3/4"
K317-16



21 cm // 8 1/4"
K325-21

Knochenfeilen und -raspeln Bone Files and Rasps



22 cm // 8 3/4"

K340-22



24 cm // 9 1/2"

K341-24



25 cm // 10"

K343-25



PUTTI
27 cm // 10 1/2"

K345-27



PUTTI
30 cm // 12"

K346-30

Raspatorien
Raspatories

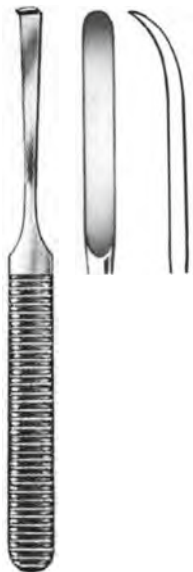

MCKENTY
15 cm // 6"
4 mm

K349-05



WILLIGER
13 cm // 5"
5 mm

K350-13



WILLIGER
16 cm // 6 1/4"

5 mm	K351-05
6,5 mm	K351-06
8 mm	K351-08

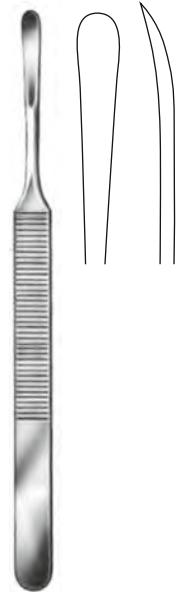

KÖNIG
15,5 cm // 6"
5 mm

K352-15



WATSON-CHEYNE

14 cm // 5 1/2"	K353-13
18 cm // 7"	K353-18

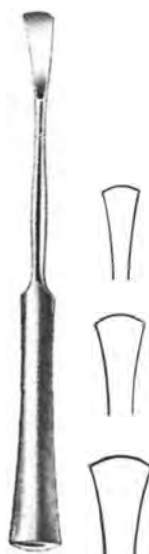

HYLIN

14,5 cm // 5 3/4"

5 mm	K355-05
7 mm	K355-07
9 mm	K355-09

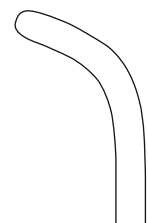

links // left

K359-01



rechts // right

K359-02

14 cm // 5 1/2"

Raspatorien Raspatories



PARTSCH
15 cm // 6"
3,2 mm
K362-03



ADSON
17 cm // 6 3/4"



8 mm
K366-01



7 mm
K366-03



7 mm
K366-02



7 mm
K366-04



17 cm // 6 3/4"

6 mm | **K368-06**

8 mm | **K368-08**



FARABEUF
15 cm // 6"



gerade
straight

K374-01



gebogen
curved

K374-02



FARABEUF-COLLIN
15,5 cm // 6"

gerade
straight

K375-01



gebogen
curved

K375-02



FARABEUF
19 cm // 7 1/2"

K376-19

Raspatorien
Raspatories



MOLT
19 cm // 7 1/2"
K378-18



JANSEN
16,5 cm // 6 1/2"
15 mm
K380-16



SCHNEIDER
17,5 cm // 7"
13 mm
K382-17



SEDILLOT
18,5 cm // 7"
18 mm
K384-18



SEDILLOT
21,5 cm // 8 1/2"
15 mm
K385-21



CUSHING
18 cm // 7"

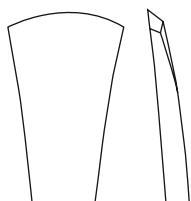

rund // round
K388-01

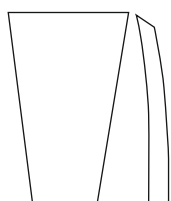

eckig // square
K388-02

15 mm



LANGENBECK



19 cm // 7 1/2"
16 mm
K392-01

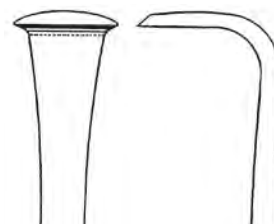

18,5 cm // 7 1/4"
14 mm
K392-02

Raspatorien Raspatories



SELDIN
19 cm // 7 1/2"
K397-19



LAMBOTTE
21,5 cm // 8 1/2"

5 mm	K400-05
10 mm	K400-10
15 mm	K400-15
20 mm	K400-20
25 mm	K400-25



SCHNEIDER-SAUERBRUCH
19 cm // 7 1/2"
13 mm
K404-19



ALEXANDER
21 cm // 8 1/4"
K405-21

Raspatorien
Raspatories

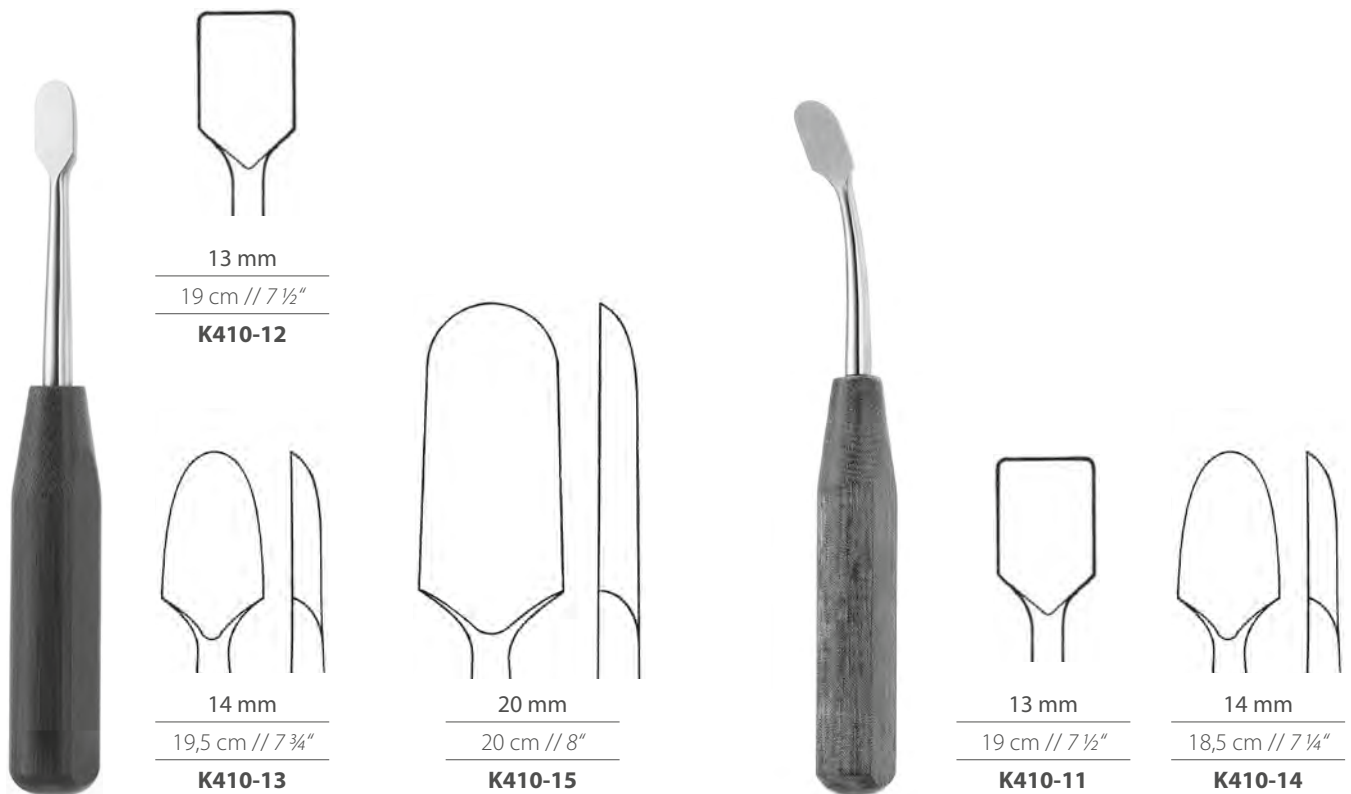
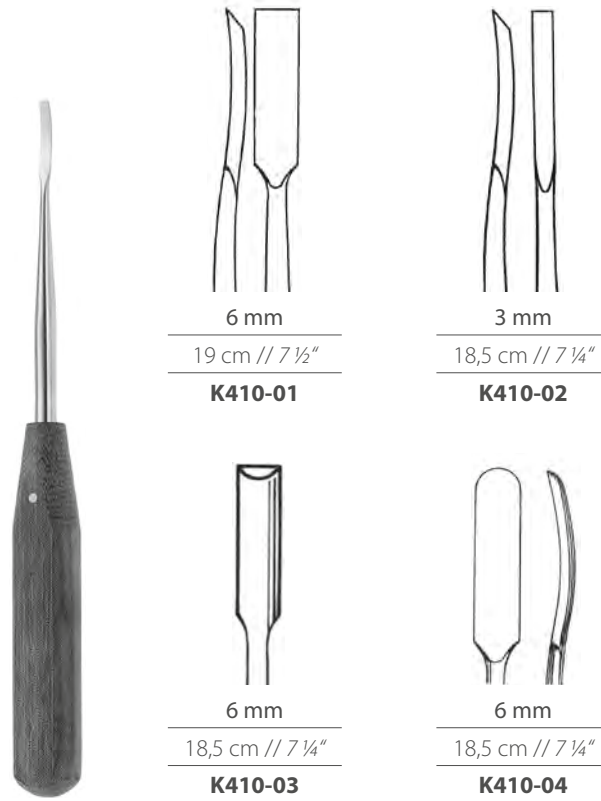

Raspatorien Raspatories



9 mm
K412-09



14 mm
K412-14

JANSEN
19,5 cm // 7 3/4"



SEMB



19,5 cm // 7 1/2"
K415-01



21 cm // 8 1/4"
K415-02



19,5 cm // 7 1/2"
K415-03



22 cm // 8 3/4"
K415-04



21,5 cm // 8 1/2"
K415-05



22 cm // 8 1/2"
K415-06



MATSON
22 cm // 8 1/2"
K417-22



DAVIDSON-ALEXANDER
29 cm // 11 1/2"
K419-29



DOYEN



17 cm // 6 3/4"

K425-01

K425-11



17 cm // 6 3/4"

K425-02

K425-12

24 cm // 9 1/2"

K425-21

K425-22

Raspatorien
Raspatories



COBB

	Metallgriff <i>Metal Handle</i>	Ferrozellgriff <i>Ferrozell Handle</i>
	24 cm // 9 1/2"	25 cm // 10"
4 mm	K430-04	-
6 mm	K430-06	-
8 mm	K430-08	-
10 mm	K430-10	K430-60
13 mm	K430-13	K430-63
19 mm	K430-19	K430-69
25 mm	K430-25	K430-75
32 mm	K430-32	-



COBB
28 cm // 11"

	Stahlgriff rund <i>Metal Handle round</i>	Aluminiumgriff <i>Aluminium Handle</i>
10 mm	K431-09	K431-59
13 mm	K431-13	K431-63
19 mm	K431-19	K431-69
25 mm	K431-25	K431-75
32 mm	K431-32	K431-82

Raspatorien
Raspatories



27,5 cm // 10 3/4"
20 mm
K433-27



WAGNER
33 cm // 13"
8 mm | **K434-08**
17 mm | **K434-17**

Elevatoren
Elevators



MASS. GEN. HOSP.
15 cm // 6"
K440-15



KÖNIG
15 cm // 6"



4,5 mm
K441-01



4,5 mm
K441-02



WILLIGER
16 cm // 6 1/4" | **K443-16**
17 cm // 6 3/4" | **K443-17**



16 cm // 6 1/4"
K444-16



SEBILEAU
17 cm // 6 3/4"
K445-17



YANKAUER
18 cm // 7"
K446-18

Elevatoren Elevators



CUSHING
20 cm // 8"

5,0 mm	K453-05
6,4 mm	K453-06
8,0 mm	K453-08

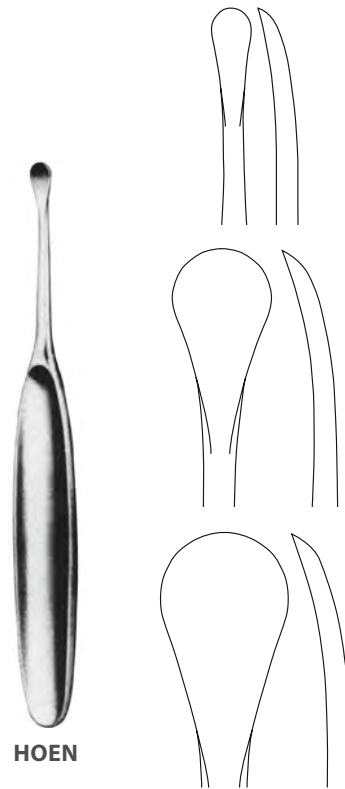

HOEN

16 cm // 6 1/4"	7 mm	K457-07
18,5 cm // 7 1/4"	15 mm	K457-15
19 cm // 7 1/2"	20 mm	K457-29

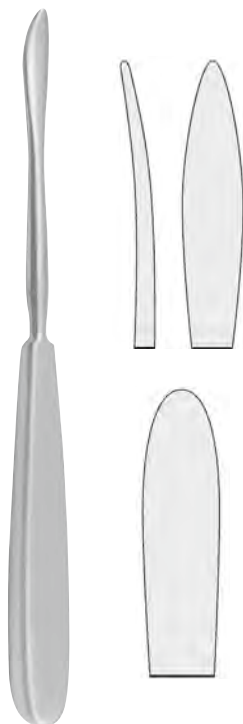

LANGENBECK
20 cm // 8"

8 mm	K458-01
10 mm	K458-02



QUERVAIN
20 cm // 8"

K460-20



LANGENBECK
21 cm // 8 1/4"

6,5 mm
K463-06

Elevatoren
Elevators



LANGENBECK
23 cm // 9"
K469-23



KEY
19 cm // 7 1/2"

3 mm	K472-03	
6 mm	K472-06	
6 mm	K472-06N	Titan
10 mm	K472-10	
13 mm	K472-13	
16 mm	K472-16	
19 mm	K472-19	
26 mm	K472-25	



WATSON-CHEYNE
17,5 cm // 7"
K475-17

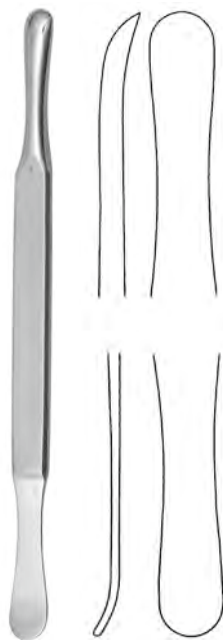

SELDIN
19,5 cm // 7 3/4"
K477-19



MCDONALD
19 cm // 7 1/2"
K479-19



ALDERDYCE
21 cm // 8 1/4"
K481-21

Elevatoren Elevators



MCGLAMRY
16,5 cm // 6 1/2"

9 mm	K484-09
11 mm	K484-11
13 mm	K484-13
15 mm	K484-14
17 mm	K484-15



CRECO
20 cm // 8"

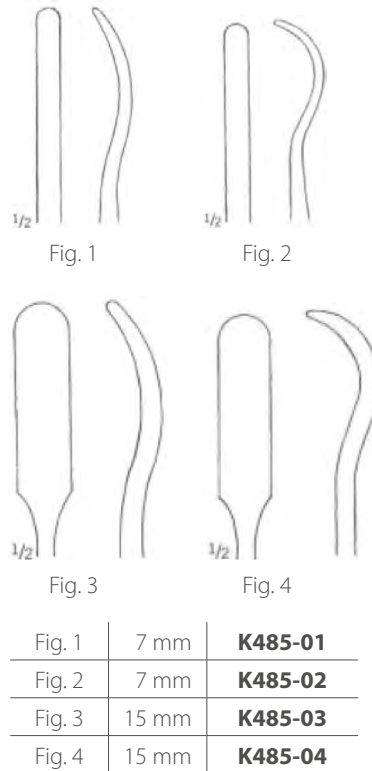

Fig. 1	7 mm	K485-01
Fig. 2	7 mm	K485-02
Fig. 3	15 mm	K485-03
Fig. 4	15 mm	K485-04



DARRACH
25 cm // 10"

9,5 mm	K486-09
12 mm	K486-12
19 mm	K486-19
25 mm	K486-20



CHANDLER

18 cm // 7"	13 mm	K492-13
20 cm // 8"	19 mm	K492-19
23 cm // 9"	25 mm	K492-25
25 cm // 10"	30 mm	K492-30



MURPHY-LANE
32 cm // 12 1/2"
K494-32

Knochenheber
Bone Levers



BLOUNT
26 cm // 10 1/4"
K495-01



BLOUNT
26 cm // 10 1/4"
K495-02



BRISTOW
23 cm // 9"
K496-23



25,5 cm // 10"
K497-25



LANE-TRETHOWAN
21 cm // 8 1/4"
K498-21



12 cm // 4 3/4" | **K500-12**
15 cm // 6" | **K500-14**



14 cm // 5 1/2"
2,8 mm
K502-14



15 cm // 6"
5 mm | **K505-05**
7 mm | **K505-07**



BUCK-GRAMCKO
15 cm // 6"
K507-15

Knochenhebel Bone Levers



15 cm // 6"

K508-15



HAYES

13 cm // 5"

K509-01

16 cm // 6 1/4"

K509-02



MINI-HOHMANN

16 cm // 6 1/4"

6 mm

K510-06

8 mm

K510-08

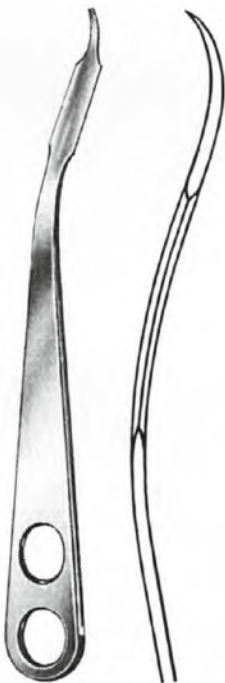

HOHMANN

22 cm // 8 1/2"

8 mm

K512-01

24 cm // 9 1/2"

8 mm

K512-06

24 cm // 9 1/2"

10 mm

K512-07

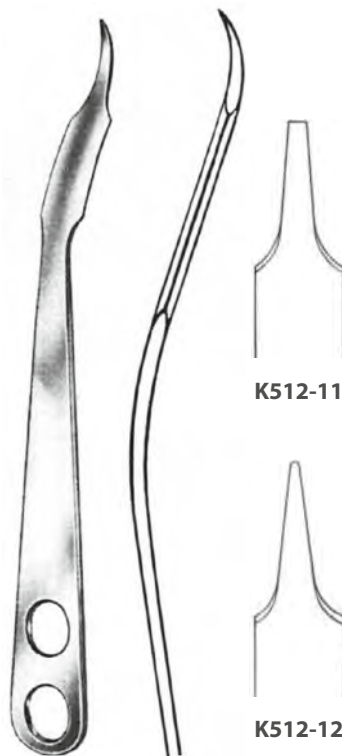

HOHMANN

24 cm // 9 1/2"

17 mm

K512-11

24 cm // 9 1/2"

17 mm

K512-12

25 cm // 10"

25 mm

K512-15

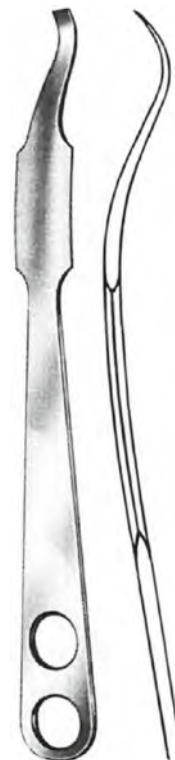

HOHMANN

26 cm // 10 1/4"

22 mm

K512-19

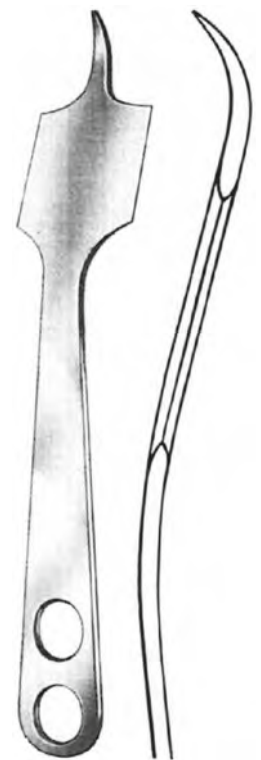

HOHMANN

25 cm // 10"

43 mm

K512-22

Knochenheber
Bone Levers

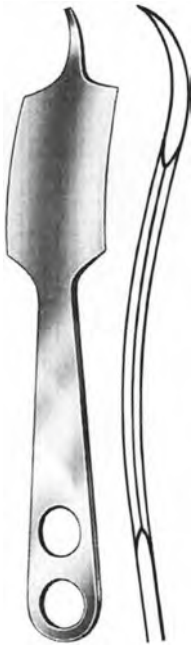

HOHMANN
28 cm // 11"
43 mm
K512-23



HOHMANN
33 cm // 13"
40 mm
K512-30



HOHMANN
28,5 cm // 11 1/4"
34 mm
K512-35



HOHMANN
25,5 cm // 10"
25,5 mm
K512-46



26 cm // 10 1/4"
25 mm
K514-27



HOHMANN
40 cm // 15 3/4"
22 mm
K515-40



VERBRUGGE-MÜLLER

24 cm // 9 1/2"	42 mm	K518-42
25,5 cm // 10"	65 mm	K518-65

Knochenhebel Bone Levers



LANGE-HOHMANN
25 cm // 9 3/4"
24 mm
K519-25



LANGE-HOHMANN mod.
26,5 cm // 10 1/2" | 30 mm | **K520-01**
29 cm // 11 1/2" | 33 mm | **K520-02**



HOHMANN-ALDINGER
27 cm // 10 1/2"
24 mm
K521-27



BENNETT
24 cm // 9 1/2"
45 mm | **K522-01**
64 mm | **K522-02**



COBRA
26 cm // 10 1/4"
Fig. 1 | **K523-01**
Fig. 2 | **K523-02**
Fig. 3 | **K523-03**
Fig. 4 | **K523-04**

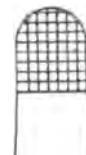

Fig. 1



Fig. 2



Fig. 3



Fig. 4



WAGNER
22 cm // 8 3/4"
17 mm
K525-22

Knochenheber
Bone Levers



SCHUMACHER
34,5 cm // 13 1/2"
K526-01



SCHUMACHER
29 cm // 11 1/2"
K527-01



27 cm // 10 1/2"
24 mm
K530-27



TAYLOR
17 cm // 6 3/4"
75 x 30 mm | **K535-01**
100 x 30 mm | **K535-02**



BLOUNT
17,5 cm // 6 3/4"
K536-17

Knochenhaltezangen Bone Holding Forceps

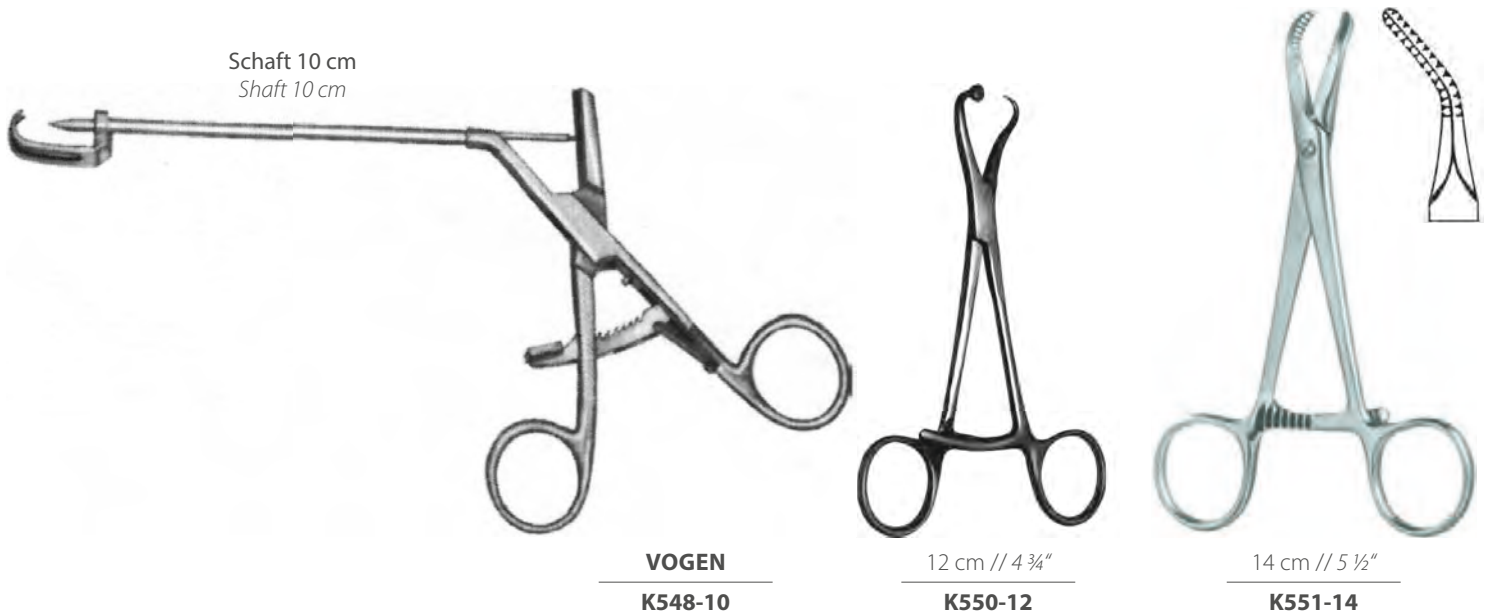

Mit Bohrbuchse,
für Drähte bis ø 0,9 mm
With drill guide,
for wires up to ø 0.9 mm

Mit Bohrbuchse,
für Drähte bis ø 1,6 mm
With drill guide,
for wires up to ø 1.6 mm

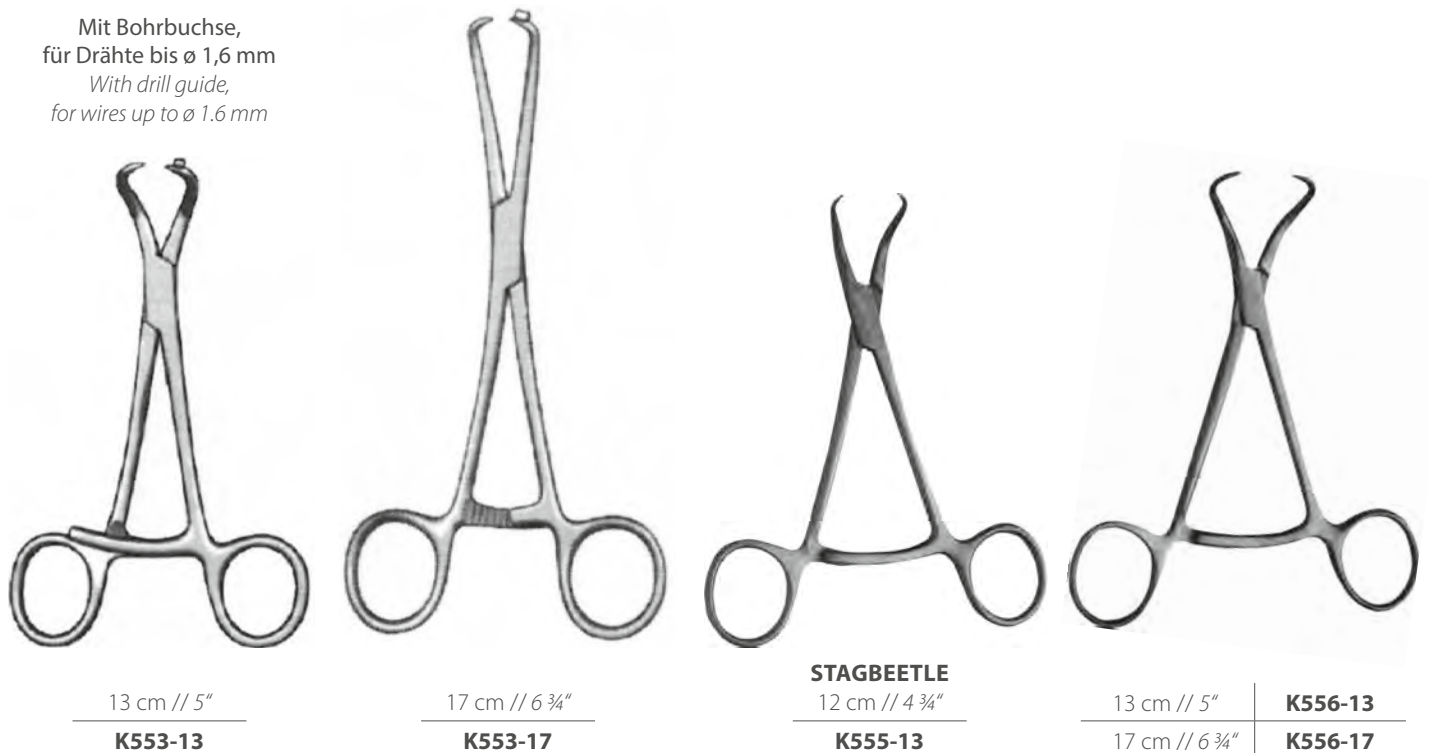

Knochenhalte­zangen
Bone Holding Forceps



9 cm // 3 1/2" | **K558-09**
13 cm // 5" | **K558-13**



REIL
17 cm // 6 3/4"
K558-17



17,5 cm // 6 3/4"
K559-17



LEWIN
17,5 cm // 6 3/4"
K560-17



gezahnt
serrated

13 cm // 5" | **K561-01**
14 cm // 5 1/2" | **K561-02**



LOCKE
15 cm // 6"
K562-15



16,5 cm // 6 1/2"
K563-16



21 cm // 8 1/4"
K564-20

Knochenhaltezangen Bone Holding Forceps



20 cm // 8"

K565-20



20 cm // 8"

K569-20



MARTIN
20 cm // 8"

K571-20



DINGMANN
19 cm // 7½"



K573-01



K573-02



BIRCHER-GANSKE
20 cm // 8"

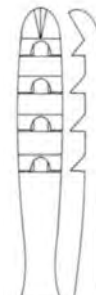

K574-01



K574-02



BIRCHER-GANSKE
20 cm // 8"

K574-03

Knochenhaltezangen
Bone Holding Forceps



VANBUREN
23 cm // 9"
K576-23



20 cm // 8"

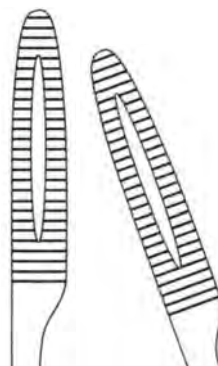

gerade
straight

K578-20

gebogen
curved

K579-20



LANGENBECK
21 cm // 8 1/4"
K580-21



FERGUSSON
21 cm // 8 1/4"
K581-21

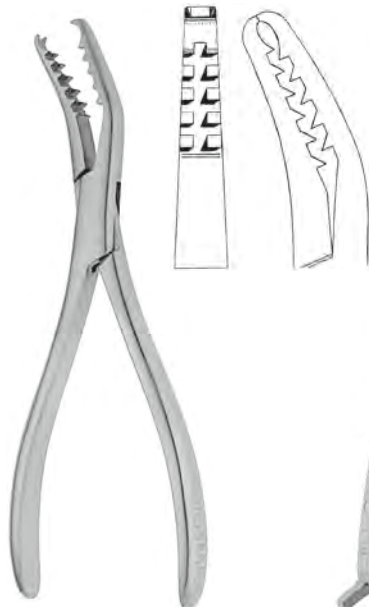

SEMB
19 cm // 7 1/2"
K582-01



SEMB
19 cm // 7 1/2"
K582-02



16 cm // 6 1/4" **K584-16**
24 cm // 9 1/2" **K584-24**

Knochenhalte­zangen Bone Holding Forceps



15 cm // 6"	K585-15
19 cm // 7 1/2"	K585-19
24 cm // 9 1/2"	K585-24
26 cm // 10 1/4"	K585-26
28 cm // 11"	K585-28



ULRICH

	gerade straight	gewinkelt angled
18 cm // 7"	K586-18	K587-18
23 cm // 9"	K586-23	-
25 cm // 10"	K586-25	-
28 cm // 11"	K586-28	K587-28



HEY-GROVES

21 cm // 8 1/4"	K589-21
27 cm // 10 1/2"	K589-27
30,5 cm // 12"	K589-30



KERN (LANE)

	ohne Sperre w/o ratchet	mit Sperre w/ ratchet
14 cm // 5 1/2"	K590-14	K591-14
17 cm // 6 3/4"	K590-17	K591-17
21 cm // 8 1/4"	K590-21	K591-21
33 cm // 13"	K590-33	K591-33
45 cm // 18 3/4"	K590-45	K591-45



Schweres Mod.
heavy pattern

33 cm // 13"

ohne Sperre w/o ratchet	mit Sperre w/ ratchet
K590-83	K591-83

Knochenhalte­zangen
Bone Holding Forceps

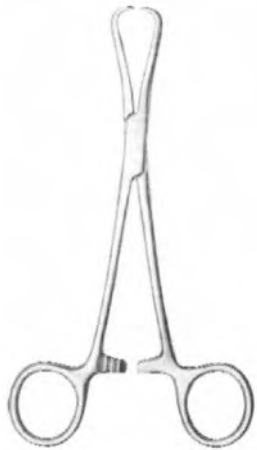

GLENOID
17 cm // 6 3/4"

Leicht gebogen
slightly curved

K593-01

Stark gebogen
strongly curved

K593-02



34 cm // 13 1/2"

K595-34



25 cm // 10"

K596-01



41 cm // 16"

K596-02



40 cm // 15 3/4"

K596-12



41 cm // 16"

K596-22

Knochenhaltezangen Bone Holding Forceps

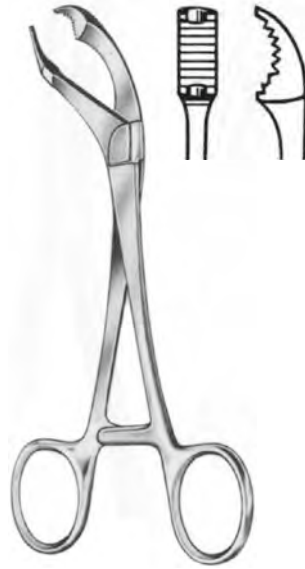

VERBRUGGE
17 cm // 6 ¾"
K600-17



VERBRUGGE

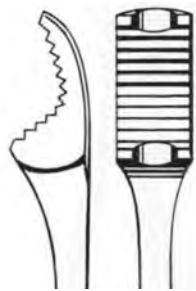

25 cm // 10"

K600-25

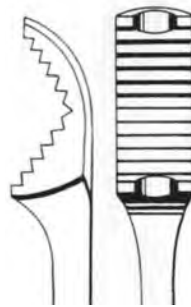

26 cm // 10 ¼"

K600-26

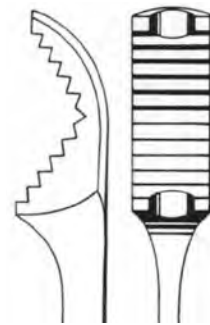

27 cm // 10 ½"

K600-27

Knochenhaltezangen
Bone Holding Forceps



21,5 cm // 8"

K602-23



LAMBOTTE

22 cm // 8 3/4" **K603-22**

27 cm // 10 1/2" **K603-27**

32 cm // 12 1/2" **K603-32**



FARABEUF

23 cm // 9" **K604-23**

26 cm // 10 1/4" **K604-26**

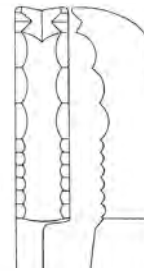

FARABEUF-LAMBOTTE

26 cm // 10 1/4"

K606-26



LOWMAN

12 cm // 4 3/4" **K610-12** **K611-12**

18 cm // 7" **K610-18** **K611-18**

20 cm // 8" **K610-20** **K611-20**

22 cm // 8 3/4" **K610-22** -



LOWMAN-HOGLUND

18,5 cm // 7 1/4" **K612-18**

20 cm // 8" **K612-20**

Amputations-Retraktoren
Amputation Retractor

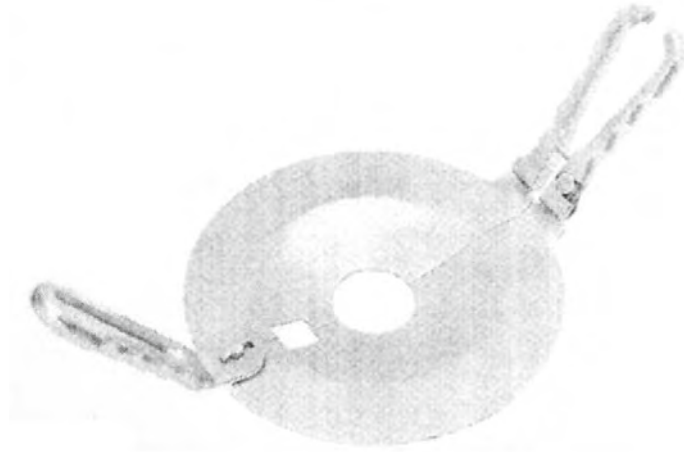

PERCY

K615-00



SWEET

K616-00

Hohlmeißelzangen
Bone Rongeur Forceps



BOYNTON
12,5 cm // 5"
K630-12



FRIEDMANN-FINO
15 cm // 6"



K631-01



K631-02



FRIEDMANN
12 cm // 4 3/4" | **K632-12**
14 cm // 5 1/2" | **K632-14**



K632-12



K632-14



K635-01



K635-02



K635-03



LUER
15 cm // 6"



CLEVELAND
14 cm // 5 1/2" | **K636-14**
17 cm // 6 3/4" | **K636-17**



K636-14

K636-17



K638-01



K638-02



K638-03



BLUMENTHAL
15 cm // 6"

Hohlmeißelzangen Bone Rongeur Forceps



STELLBRINK
17 cm // 6 3/4"



K640-01



K640-02



LEMPERT



gerade
straight



gebogen
curved

16 cm // 6 1/4"

K644-16

K645-16

19 cm // 7 1/2"

K644-19

K645-19



MEAD
16,5 cm // 6 1/2"



K642-01



K642-02



HAKANSSON
16 cm // 6 1/4"
K646-15

Hohlmeißelzangen
Bone Rongeur Forceps



JANSEN
17,5 cm // 7"



gerade
straight

K650-17



gebogen
curved

K651-17



LUER
17 cm // 6 3/4"



gerade
straight

K654-17

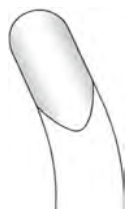

gebogen
curved

K655-17



LUER

Schweres Mod.
heavy pattern

17 cm // 6 3/4"

gerade
straight

K654-67

gebogen
curved

K655-67



BANE-HARTMANN

17,5 cm // 6 3/4"

K658-17



HARTMANN

18,5 cm // 7 1/4"

K660-18



NORTHFIELD

20,5 cm // 8"

K661-20

Hohlmeißelzangen Bone Rongeur Forceps



PENNYBACKER
20,5 cm // 8"
K662-20



BEYER
18 cm // 7"
K664-18

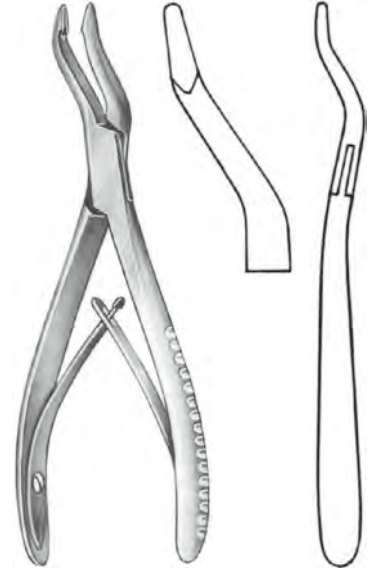

JANSEN
18 cm // 7"
K666-19



OLIVECRONA
20 cm // 8"
K670-20



ADSON
20 cm // 8"

	gerade straight	gebogen curved
7 mm	K674-07	K675-07
8 mm	K674-08	K675-08

Mit Zähnen // with teeth

K674-70



BACON
20 cm // 8"
K680-20

Hohlmeißelzangen
Bone Rongeur Forceps



KLEINERT-KUTZ
15 cm // 6"



gerade
straight



gebogen
curved



stark gebogen
strong curved



seitl. gebogen
curved sidew.

	gerade <i>straight</i>	gebogen <i>curved</i>	stark gebogen <i>strong curved</i>	seitl. gebogen <i>curved sidew.</i>
2 mm	K700-02	K701-02	-	K701-22
3 mm	-	K701-03	K701-13	-



BÖHLER
15 cm // 6"



gerade
straight



gebogen
curved

	gerade <i>straight</i>	gebogen <i>curved</i>
2 mm	K702-02	K703-02
3 mm	K702-03	K703-03
4 mm	K702-04	K703-04
5 mm	K702-05	K703-05

Hohlmeißelzangen Bone Rongeur Forceps



ZAUFAL-JANSEN
18 cm // 7"
K704-18



BEYER
18 cm // 7"
K705-18



MAYFIELD
17 cm // 6 3/4"
K706-17



RUSKIN
18 cm // 7"
K707-18



RUSKIN
18 cm // 7"

	gerade straight	gebogen curved
4 mm	K710-184	K711-184
5 mm	K710-185	K711-185
6 mm	K710-186	K711-186
7 mm	K710-187	K711-187



RUSKIN
23 cm // 9"

5 mm	K711-235
6 mm	K711-236
7 mm	K711-237



MARQUARDT
20 cm // 8"

K715-20

Hohlmeißelzangen
Bone Rongeur Forceps



RÖTTGEN-RUSKIN
24 cm // 9½"

K718-24



SMITH-PETERSEN
24 cm // 9½"

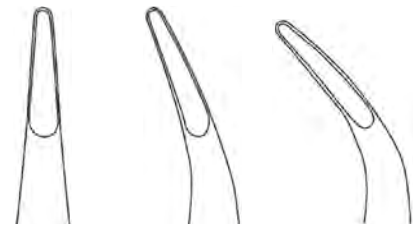

	gerade <i>straight</i>	leicht geb. <i>slightly curved</i>	stark gebogen <i>strong curved</i>
3 mm	K720-01	K720-02	K720-03
4 mm	-	K720-12	K720-13
5 mm	-	K720-22	K720-23



STILLE-LUER

22 cm // 8½"
26 cm // 10¼"

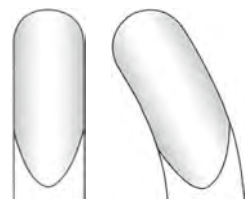

gerade
straight gebogen
curved

K730-22	K731-22
K730-26	K731-26



STILLE-LUER

22 cm // 8½"
27 cm // 10½"

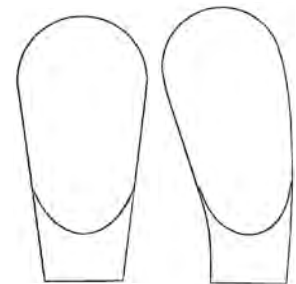

gerade
straight gebogen
curved

K732-22	K733-22
K732-26	K733-26

Hohlmeißelzangen Bone Rongeur Forceps

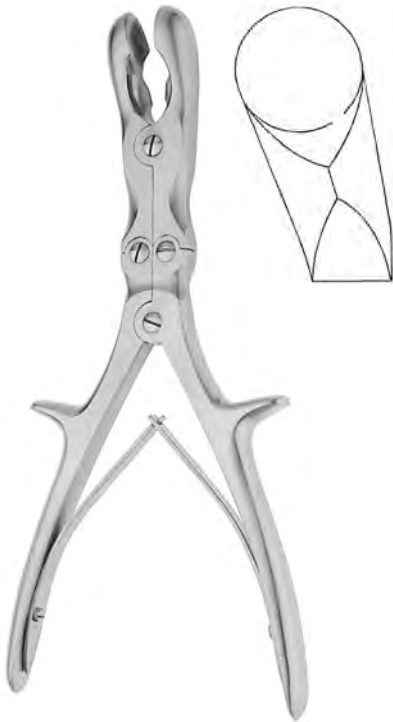

SEMB
23 cm // 9"
K734-23



ECHLIN
23 cm // 9"

	gerade straight
2 mm	K738-02
3 mm	K738-03
4 mm	K738-04



LEKSELL
24 cm // 9 1/4"

3 mm	K739-03
4 mm	K739-04
5 mm	K739-05
6 mm	K739-06
7 mm	K739-07
8 mm	K739-08



LEKSELL
24 cm // 9 1/4"

3 mm	K739-13
4 mm	K739-14
5 mm	K739-15
6 mm	K739-16
7 mm	K739-17
8 mm	K739-18

Hohlmeißelzangen
Bone Rongeur Forceps



STILLE-LUER-ECHLIN
23 cm // 9"
K741-04



STILLE
23 cm // 9"

5 mm	K742-05
6 mm	K742-06



FRYKHOLM
24 cm // 9½"
K743-24



SAUERBRUCH
31 cm // 12¼"



K744-01

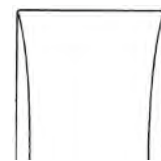

K744-02

Hohlmeißelzangen
Bone Rongeur Forceps



DALE
 34 cm // 13 1/4"
K747-23



SYPERT
 36 cm // 14"

4 mm	K749-04
5 mm	K749-05
8 mm	K749-08
12 mm	K749-12

Knochensplitterzangen
Bone Cutting Forceps



LITTAUER
15 cm // 6"
K750-15



COTTLE-KAZANIJAN
19 cm // 7 1/2"
K751-19



LISTON

	gerade <i>straight</i>	gebogen <i>curved</i>
14 cm // 5 1/2"	K752-14	K753-14
17 cm // 6 3/4"	K752-17	K753-17
19 cm // 7 1/2"	K752-19	K753-19
22 cm // 8 1/2"	K752-22	K753-22



CLEVELAND

13 cm // 5"	K754-13
15 cm // 6"	K754-15
17 cm // 6 3/4"	K754-17

Knochensplitterzangen Bone Cutting Forceps



BÖHLER
15 cm // 6"

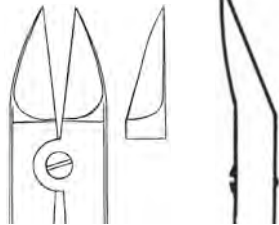

gerade
straight

K760-15

gebogen
curved

K761-15



KLEINERT-KUTZ
15 cm // 6"

gerade
straight

K762-15

gebogen
curved

K763-15



MCINDOE
17 cm // 6 3/4"
K765-17

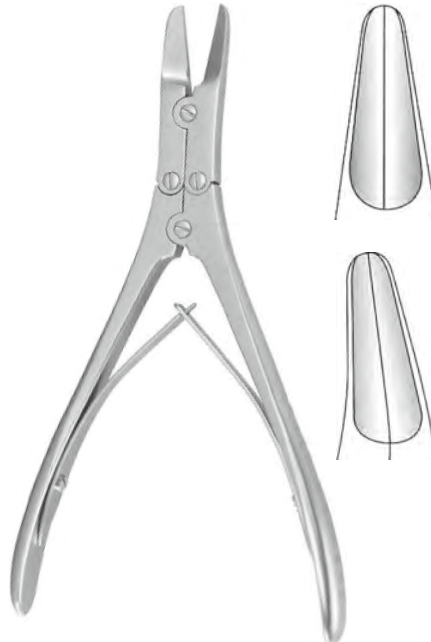

RUSKIN-ROWLAND
17 cm // 6 3/4"

gerade
straight

K768-11

gebogen
curved

K769-11

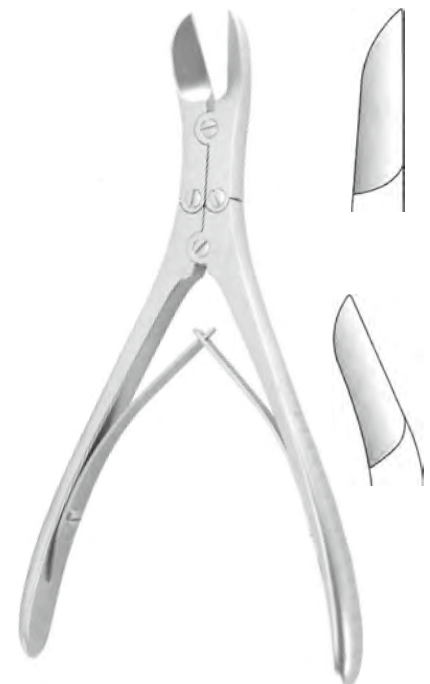

RUSKIN-LISTON
18 cm // 7"

gerade
straight

K770-18

gebogen
curved

K771-18

fein, gerade
fine, straight

K770-68

Knochensplitterzangen
Bone Cutting Forceps



STILLE-LISTON



gerade
straight



gebogen
curved

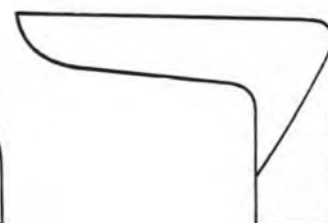

gewinkelt
angled

23 cm // 9"	K774-23	K775-23	-
27 cm // 10 ½"	K774-27	K775-27	K776-26

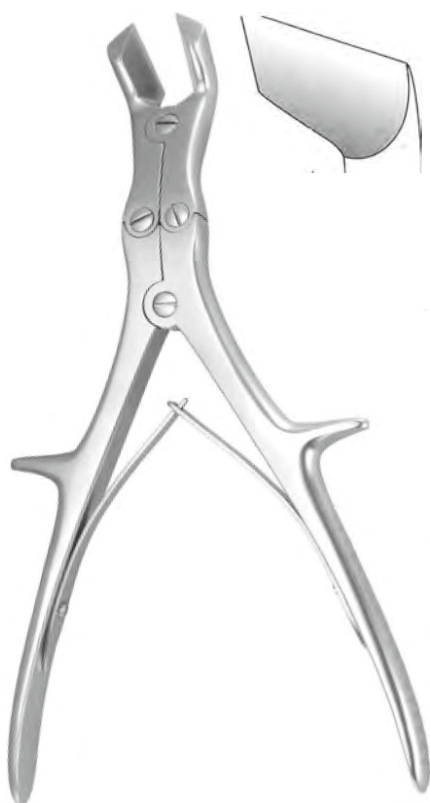

LISTON-KEY
27 cm // 10 ½"
K777-27



SEMB
25 cm // 10"
K779-25

Handbohrapparate Hand Drills

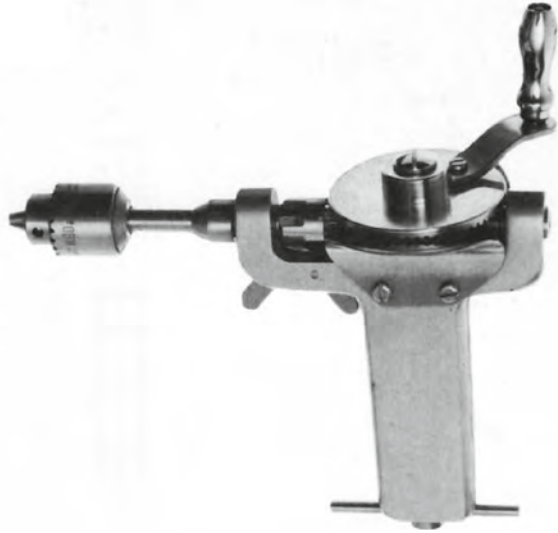

BUNNEL

Mit Jacobs-Futter und Schlüssel
With Jacobs-Chuck and Key

K800-00

Schlüssel allein
Key only

K800-11



RALK

Mit Jacobs-Futter und Schlüssel
With Jacobs-Chuck and Key

K801-00

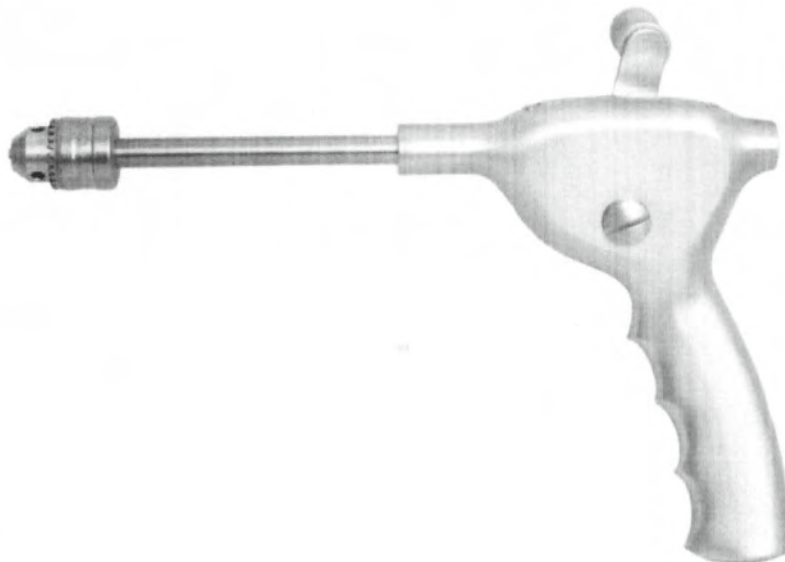

RALK

langes Modell // *Long pattern*

Mit Jacobs-Futter und Schlüssel
With Jacobs-Chuck and Key

K802-00

Handbohrapparate
Hand Drills



HUDSON



Flachbohrer
Flat drill
K804-05



9,0 mm	K804-01
14,0 mm	K804-02
16,0 mm	K804-03
22,0 mm	K804-04



Verbindungsstück
Extension piece
K804-09



2 mm	K804-06
13 mm	K804-07
16 mm	K804-08

Komplett mit K804-01 bis K804-04 und K804-09
Complete with drills K804-01 to K804-04 and K804-09

K804-00

Bohrapparat allein
Drill only

K804-10



STILLE

Komplett
Complete

K805-00

Bohrapparat allein
Drill only

K805-10



Bohrer
Drill bits

2,5 mm	K805-01
3,0 mm	K805-02
3,5 mm	K805-03
4,0 mm	K805-04



Trephine 10 mm
Trephine 10 mm

K805-05



Bohrer
Drill bits

5 mm	K805-06
8 mm	K805-07
12 mm	K805-08
16 mm	K805-09

Handbohrapparate Hand Drills



Handbohrapparat mit umstellbarem Handgriff,
Jacobs-Spannfutter und Schlüssel
*Hand drill with adjustable handle,
Jacobs-chucks and key*

K806-00

Handbohrfutter Drilling Chucks



Handbohrfutter mit T-Griff
längsdurchbohrt, bis 4 mm, mit
Schlüssel
*Drilling chuck with T-handle
cannulated, up to 4 mm, with key*

K808-10

Schlüssel allein
Key only

K808-11



Handbohrfutter mit T-Griff
längsdurchbohrt, bis 7 mm, mit
Schlüssel
*Drilling chuck with T-handle
cannulated, up to 7 mm, with key*

K808-20

Schlüssel allein
Key only

K808-21



Universalbohrfutter mit T-Griff
längsdurchbohrt, 1-6 mm
*Drilling chuck with T-handle
cannulated, 1-6 mm*

K808-30

Knochenbohrer, Ahlen
Bone Drills, Awles



14,5 cm // 5 1/2"

Reibahle
Reamer (Awl)

K814-14



14 cm // 5 1/2"

Reibahle
Reamer (Awl)

K815-14



PERTHES

21 cm // 8 1/4"

Reibahle
Reamer (Awl)

K816-21



22 cm // 8 1/2"

Schulterahle
Shoulder Awl

klein // <i>small</i>	K820-01
Mittel // <i>medium</i>	K820-02
Groß // <i>large</i>	K820-03



23,5 cm // 9 1/4"

K820-11

Drahtumführungsnadeln
Bone Wire Guides



DEMEL
28 cm // 11"

Fig. 1 | **K825-01**

Fig. 2 | **K825-02**

Fig. 3 | **K825-03**



ø 45 mm	18 cm // 7"	K827-01
ø 70 mm	24 cm // 9 1/4"	K827-02

Extensionsbügel Extension Bows



BÖHLER

16 x 9 cm	K829-01
21 x 11 cm	K829-02



KIRSCHNER

9,5 x 7 cm	K830-01
10 x 5 x 10,5 cm	K830-02
12 x 12 cm	K830-03
15 x 5 x 15,5 cm	K830-04
20 x 15,5 cm	K830-05



KIRSCHNER

18 x 10 cm	K832-01
27 x 16 cm	K832-02



KIRSCHNER US-MODELL

	max. Öffnung max. Opening	
14,5 cm // 5 ¾"	12,5 cm	K834-01
19 cm // 7 ½"	21,5 cm	K834-02
24 cm // 9 ½"	25 cm	K834-03



Spannschlüssel
Wrench

K834-51



K834-61

Drahtzangen
Wire Pliers



14 cm // 5 1/2"

K850-14

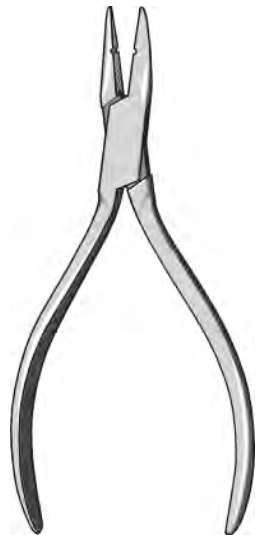

14 cm // 5 1/2"

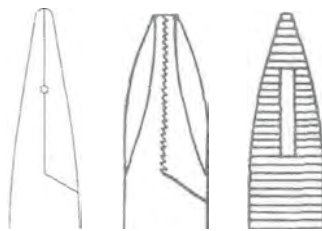

K851-01

K851-02

K851-03



RUBIO
13 cm // 5"

K852-13T

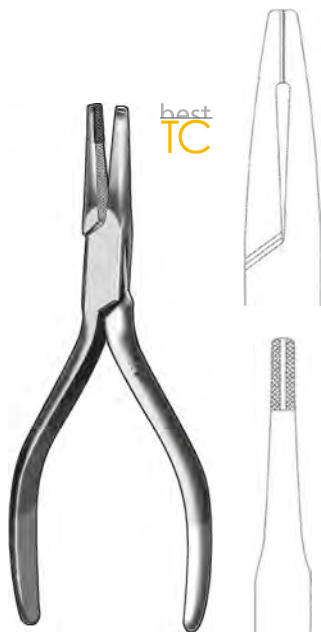

14 cm // 5 1/2"

K854-15T



15 cm // 6"
2 mm

K855-15



16 cm // 6 1/4"

K857-16

Drahtzangen
Wire Pliers



17 cm // 6 3/4"



K858-01

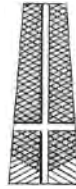

K858-02



19 cm // 7 1/2"

K861-19



13 cm // 5"

K865-13

18 cm // 7"

K865-18



20 cm // 8"
10 mm

K866-20



18 cm // 7"
2 mm

K867-18

Drahtzangen
Wire Pliers



best
TC



15 cm // 6"

K875-15T

20 cm // 8"

K875-20T



13 cm // 5"

K875-63T

15 cm // 6"

K875-65T

18 cm // 7"

K875-68T

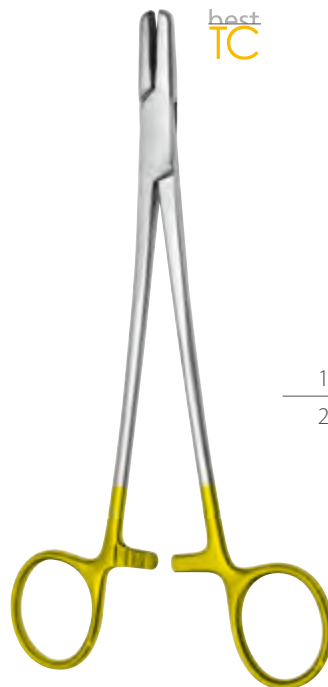

best
TC



18 cm // 7"

K876-18T

20 cm // 8"

K876-20T



best
TC

17 cm // 6 3/4"

K879-17T



K880-05



K880-07



K880-11

18 cm // 7"



best
TC

15,5 cm // 6"

K881-15T

Drahtzangen
Wire Pliers



18 cm // 7"
K882-18



14,5 cm // 5 ½"
K883-14

Mit Seitenschneider
With Side Cutter



LINEMANN
21,5 cm // 8 ½"
K884-21



18 cm // 7"

best
TC



K886-00T



K886-02T



K886-03T



K886-06T

Drahtzangen
Wire Pliers



18,5 cm // 7 1/2"

K889-17



18,5 cm // 7 1/2"

K889-51

Mit Seitenschneider, max. 1,6 mm
With Side Cutter, max 1.6 mm



Feststellzange
Locking Pliers

18 cm // 7"

K890-18

20 cm // 8"

K890-20

24 cm // 9 1/2"

K890-24



Schmale Feststellzange
Needle Nose Locking Pliers

22 cm // 8 1/2"

K890-72

25 cm // 10"

K890-75

30 cm // 12"

K890-80

Drahtinstrumente Wire Instruments



12 cm // 4 3/4"

K892-12



23 cm // 9"

K892-23



LOUTE

K893-00

Universal Draht Instrument, 0,8 - 1,6 mm
Universal Wire Instrument, 0.8 - 1.6 mm



Draht eindrehen, herausziehen, biegen
Wire to drive, pull, bend

VICKERS

K895-18

Drahtkneifzangen
Wire Cutting Pliers



best
TC

Schneidet Drähte bis \varnothing 0,6 mm
Cutting Wires up to \varnothing 0.6 mm

12 cm // 4 3/4"

K900-12T

14 cm // 5 1/2"

K900-14T



18 cm // 7"

Kabelschneidzange bis 2 mm Kabel
Cable Cutter, max. 2 mm Cable

K904-00



best
TC

Schneidet Drähte bis \varnothing 1,0mm
Cutting Wires up to \varnothing 1.0 mm

15 cm // 6"

K905-15T



Schneidet Drähte bis \varnothing 1,6 mm
Cutting Wires up to \varnothing 1.6 mm

16 cm // 6 1/4"

K906-16

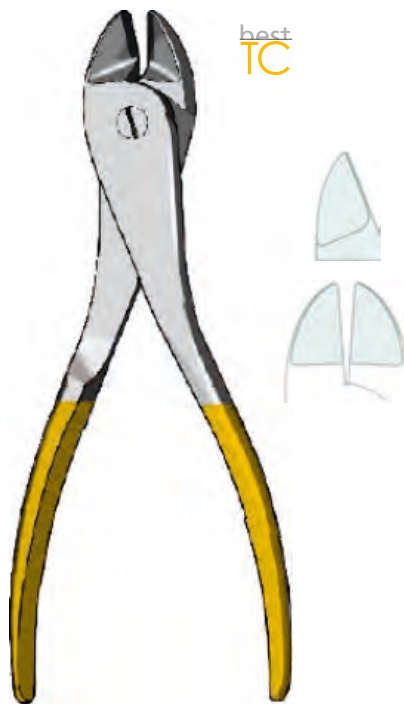

best
TC

Schneidet Drähte bis \varnothing 1,5 mm
Cutting Wires up to \varnothing 1.5 mm

18 cm // 9"

K907-18T

Drahtschneider
durchbohrt
Cannulated
Wire cutter



Schneidet Drähte bis \varnothing 1,6 mm
Cutting Wires up to \varnothing 1.6 mm

18 cm // 9"

K908-18

Drahtkneifzangen Wire Cutting Pliers



Platten und Drahtschneider
Plate and Wire cutting plier

Drähte bis \varnothing 3,5mm / Platten bis 2,0 mm
Wires up to \varnothing 3.5 mm / Plates up to 2.0 mm

24 cm // 9 1/2"

K909-22



Schneidet Drähte bis \varnothing 1,7 mm
Cutting Wires up to \varnothing 1.7 mm

18 cm // 7"

K910-18T



Schneidet Drähte bis \varnothing 2,0 mm
Cutting Wires up to \varnothing 2.0 mm

18 cm // 7"

K914-18T



Schneidet Drähte bis \varnothing 2,5 mm
Cutting Wires up to \varnothing 2.5 mm

22 cm // 8 1/2"

K914-22T

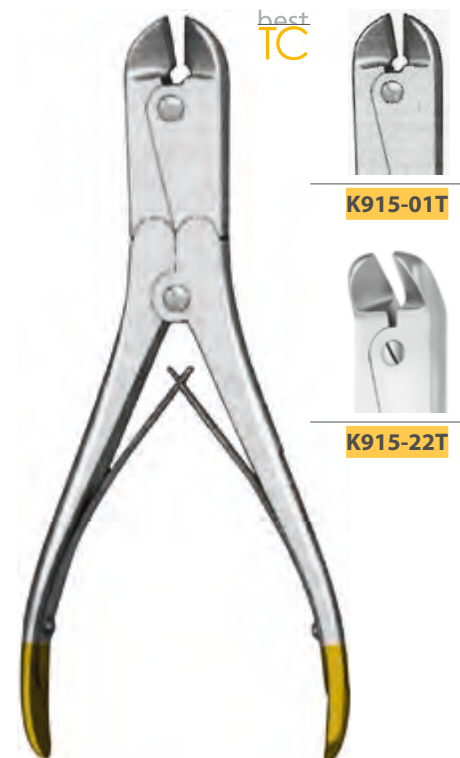

Schneidet Drähte bis \varnothing 2,5 mm
Cutting Wires up to \varnothing 2.5 mm

23,5 cm // 9 1/4"

K915-01T

K915-22T

Drahtkneifzangen
Wire Cutting Pliers

Schneidet Drähte bis ø 6,5 mm
Cutting Wires up to ø 6.5 mm



Schneidet Drähte bis ø 2,5 mm
Cutting Wires up to ø 2.5 mm

22 cm // 8 3/4"

K921-22T



Mit auswechselbaren Schneiden
With exchangeable Inserts

	für Rechtshänder right-handed	für Linkshänder left-handed	Ersatzteilsatz Spare Part Sets
18 cm // 7"	K922-18	K922-18L	K922-68
23 cm // 9"	K922-23	-	K922-73
28 cm // 11"	K922-28	-	K922-78



57 cm // 22 1/2"

Mit abnehmbaren Griffen
With removable Handles

K924-57



Schneidet Drähte bis ø 6,5 mm
Cutting Wires up to ø 6.5 mm

47 cm // 18 1/2"

K925-47

54 cm // 22 1/2"

K925-54



Schneidet Drähte bis ø 4,5 mm
Cutting Wires up to ø 4.5 mm

38 cm // 15"

K926-38T

Kopfschneider
Pin Cutter



		Bis max. max.
26 cm // 10"	K927-26	ø 3,2 mm
38 cm // 15"	K927-38	ø 4,7 mm

Herz-Thorax-Gefäßchirurgie

// Cardiovascular and Thoracic Surgery

Inhalt

Index

Abschnitt **R**
// Section

Rippensperrer <i>Rib Spreader</i>	R02 - R08
Rippenkonraktoren, Rippenscheren <i>Rib Contrators, Rib Shears</i>	R09 - R10
Sternummeißel, Torniquets <i>Sternum Chisel, Torniquets</i>	R11
Atrauma-Klemmen <i>Atrauma Forceps</i>	R12 - R42

Rippensperrer
 Rib Spreader

Abmessungs-Schema für Rippensperrer
 Dimensional Diagram for Rib Spreaders

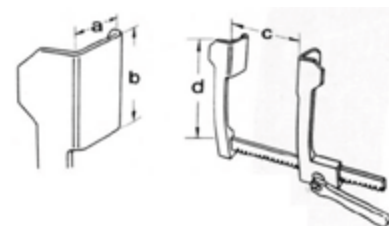

Mit 2 auswechselbaren Valven
 With two pairs interchangeable blades

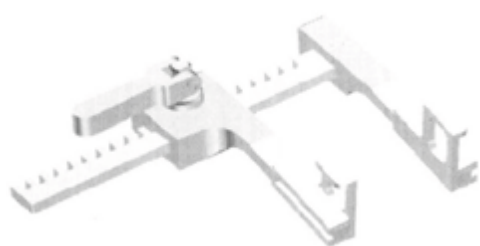

Neonatal-Sperrer Titan
 Neonatal-Spreader Titanium

R102-00N



HAIGHT

	a	b	c	d
R106-01	30 mm	30 mm	115 mm	65 mm
R106-02	30 mm	30 mm	115 mm	90 mm



TUFFIER

		a	b
Mit gekerbten Valven With roughened valves	R107-01	48 mm	44 mm
Mit gerieften Valven With grooved valves	R107-02	48 mm	44 mm



RIENHOFF-FINOCHIETTO

	a	b	c
R109-00	20 mm	25 mm	150 mm

Rippensperrer Rib Spreader

Abmessungs-Schema für Rippensperrer
Dimensional Diagram for Rib Spreaders



FINOCHIETTO-MINI
FINOCHIETTO-BABY

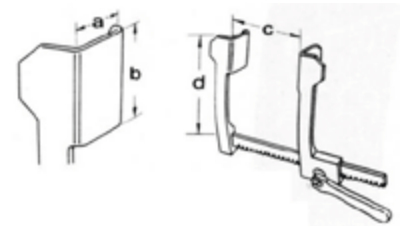

	a	b	c
R110-01	6 mm	7 mm	36 mm
R110-02	14 mm	15 mm	-
R110-03	18 mm	20 mm	80 mm
R110-04	28 mm	32 mm	120 mm



FINOCHIETTO

	a	b	c
R110-05N	20 mm	20 mm	80 mm
R110-11	38 mm	44 mm	140 mm
R110-21	51 mm	65 mm	200 mm
R110-22	51 mm	65 mm	250 mm
R110-23	51 mm	65 mm	300 mm
R110-24	65 mm	65 mm	200 mm
R110-25	65 mm	65 mm	250 mm



COOLEY

	a	b	c
R112-01	15 mm	30 mm	100 mm
R112-02	20 mm	45 mm	145 mm
R112-03	30 mm	50 mm	185 mm
R112-04	32 mm	104 mm	185 mm

Rippensperrer
Rib Spreader

Abmessungs-Schema für Rippensperrer
Dimensional Diagram for Rib Spreaders

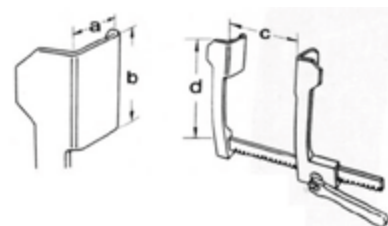

MORSE

	a	b	c
R114-01	12 mm	20 mm	155 mm
R114-02	40 mm	20 mm	155 mm
R114-03	17 mm	22 mm	155 mm
R114-04	27 mm	29 mm	200 mm
R114-05	42 mm	29 mm	200 mm

Kplt. bestehend aus R116-10, R116-24, R116-25
Cplt. consisting of R116-10, R116-24, R116-25

R116-00

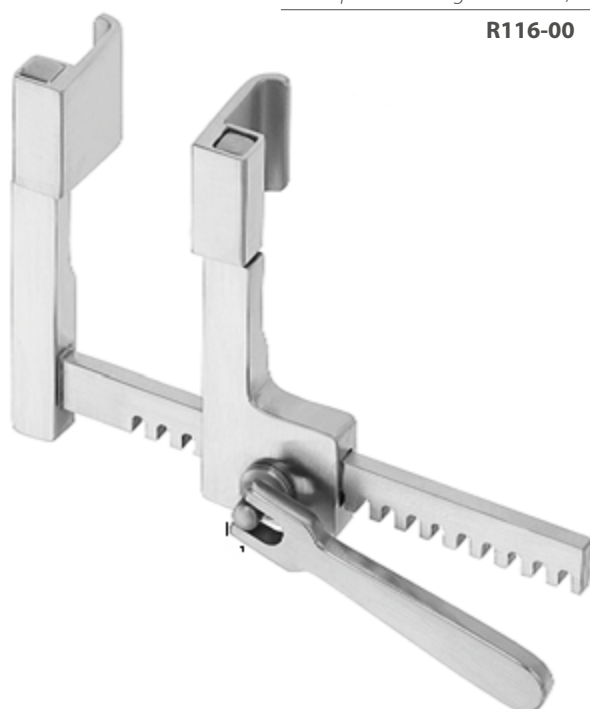

STRUCK



Blätter allein (Paar) Blades only (Pair)	a	b
R116-21	10 mm	10 mm
R116-22	10 mm	15 mm
R116-23	10 mm	20 mm
R116-24	15 mm	20 mm
R116-25	20 mm	20 mm

Sperrer allein
Spreader only

R116-10

Rippensperrer Rib Spreader

Kplt. bestehend aus R118-10, R118-21, R118-22, R118-23
Cplt. consisting of R118-10, R118-21, R118-22, R118-23

R118-00



Sperrer allein C=150 mm
Spreader only C=150 mm

R118-10

DEBAKEY

Abmessungs-Schema für Rippensperrer
Dimensional Diagram for Rib Spreaders

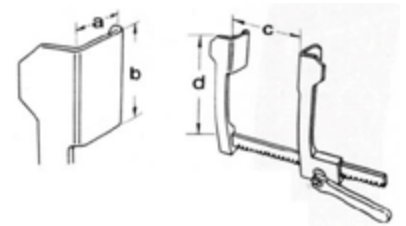

Blätter allein (Paar)
Blades only (Pair)

	a	b
R118-21	30 mm	30 mm
R118-22	40 mm	40 mm
R118-23	50 mm	50 mm

Kplt. bestehend aus R119-10, R119-21, R119-22, R119-23
Cplt. consisting of R119-10, R119-21, R119-22, R119-23

R119-00



Sperrer allein C=200 mm
Spreader only C=200 mm

R119-10

DEBAKEY



Blätter allein (Paar)
Blades only (Pair)

	a	b
R119-21	60 mm	60 mm
R119-22	50 mm	80 mm
R119-23	40 mm	100 mm
R119-24	80 mm	60 mm
R119-25	50 mm	66 mm

Rippensperrer
 Rib Spreader

Abmessungs-Schema für Rippensperrer
 Dimensional Diagram for Rib Spreaders

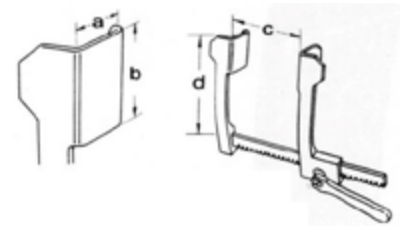

Mit 2 Paar Valven
 With 2 pairs of blades

Spreizweite Total spread	
200 mm	R120-05
250 mm	R120-06
300 mm	R120-07

Blätter allein
 Blades only

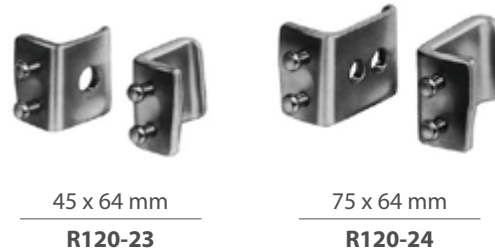

45 x 64 mm

R120-23

75 x 64 mm

R120-24

FINOCHIETTO-BURFORD



MERCEDES

Komplett
 Complete

R124-00

Sperrer allein
 Spreader only

R124-10

Blätter allein (Paar)
 Blades only (Pair)

48 x 65 mm **R124-21**

75 x 85 mm **R124-22**

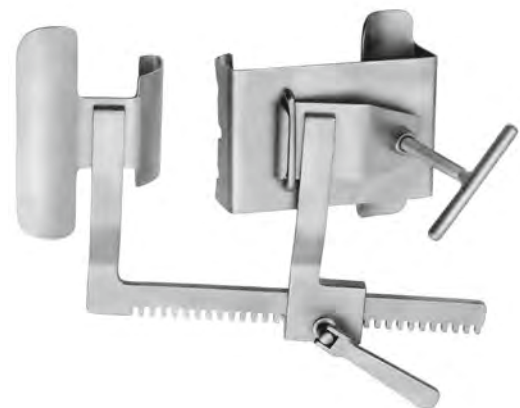

IMA-RETRACTOR

R127-00

Rippensperrer Aluminium Rib Spreaders Aluminium

Abmessungs-Schema für Rippensperrer
Dimensional Diagram for Rib Spreaders

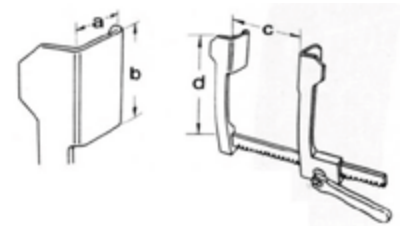

HAIGHT

	a	b	c
R130-00	30 mm	30 mm	100 mm



COOLEY

	a	b	c
R132-02	12 mm	16 mm	70 mm
R132-03	14 mm	16 mm	70 mm
R132-11	16 mm	30 mm	90 mm



Für Kleinkinder mit Dornen
Infant size with prongs

COOLEY

	a	b	c
R133-00	17 mm	20 mm	90 mm



MORSE

	a	b	c
R134-01	12 mm	20 mm	155 mm
R134-02	20 mm	20 mm	155 mm
R134-03	40 mm	20 mm	155 mm
R134-11	20 mm	28 mm	210 mm

Rippensperrer Aluminium
 Rib Spreaders Aluminium

Abmessungs-Schema für Rippensperrer
 Dimensional Diagram for Rib Spreaders

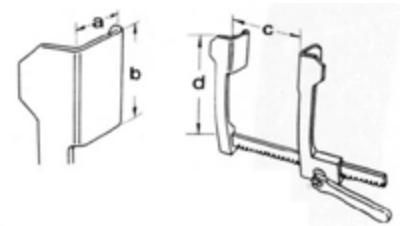

CASTANEDA

	a	b	c
R136-01	10 mm	32 mm	70 mm
R136-02	12 mm	45 mm	75 mm
R136-03	15 mm	60 mm	100 mm



FINOCHIETTO

	a	b	c
R138-01	12 mm	15 mm	70 mm
R138-02	27 mm	30 mm	70 mm
R138-03	30 mm	45 mm	140 mm
R138-04	42 mm	62 mm	170 mm
R138-05	73 mm	65 mm	170 mm



Mit 2 Paar Valven
 With 2 pair blades

BURFORD



	a/b - a/b	c
R140-01	48/42 - 34/42 mm	145 mm
R140-11	65/62 - 47/62 mm	200 mm
R140-12	65/62 - 47/62 mm	260 mm
R140-13	65/62 - 47/62 mm	300 mm

Rippenkontraktoren Rib Contractors



BAILEY-BABY
16 cm // 6 1/4"
R150-16



BAILEY
18 cm // 7"
R150-18



BAILEY-GIBBON
18 cm // 7"
R151-18



SELLORS
19 cm // 7 1/2"
R153-19



LEMMON
18 cm // 7"
R155-18

Rippenscheren Rib Shears



SAUERBRUCH
23 cm // 9" | **R160-23**
26 cm // 10 1/4" | **R160-26**



GIERTZ-STILLE
27 cm // 10 1/2"
R162-27



BETHUNE
34 cm // 13 1/2"
R164-34

Rippenscheren
 Rib Shears



Für rechte Hand
 For right hand

R166-01

Für linke Hand
 For left hand

R166-02

BRUNNER
 32 cm // 12 1/2"



COOLEY FIRST
 34 cm // 13 1/4"

R167-34



CORYLLOS
 36 cm // 14"

rechts geschützt
 protected right

R168-01

links geschützt
 protected left

R168-02



BETHUNE
 35 cm // 13 3/4"

rechts geschützt
 protected right

R170-01

links geschützt
 protected left

R170-02

Sternummeißel Sternum Chisel



LEBSCHKE
24,5 cm // 9 ½"
R175-24

Lungenspatel Lung spatulas



ALLISON
25,5 cm // 10" | **R180-01**
30 cm // 12" | **R180-02**

Lungenspatel Lung spatulas



ALLISON
30 cm // 12"
R180-11

Torniquets Torniquets



RUMEL-BELMONT
3,2 mm | **R220-03**
6,4 mm | **R220-06**

Fadenfänger allein Suture hook only



2 mm | **R220-20**
2,5 mm | **R220-30**
3,0 mm | **R220-40**

Atrauma-Klemmen
 Atrauma Forceps



DEBAKEY



GLOVER (POTTS)

Anastomosenklemmen
 Anastomosis Clamps



21 cm // 8 1/4"

R330-21

R330-21N



21 cm // 8 1/4"

R331-21

R331-21N



23,5 cm // 9 1/4"

R331-23

-



DERRA-DEBAKEY

17 cm // 6 3/4"



Fig. 1

R334-01

R334-01N



Fig. 2

R334-02

R334-02N

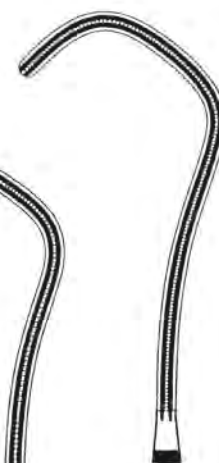

Fig. 3

R334-03

R334-03N

Atrauma-Klemmen *Atrauma Forceps*

Anastomosenklemmen
Anastomosis Clamps



DEBAKEY



GLOVER

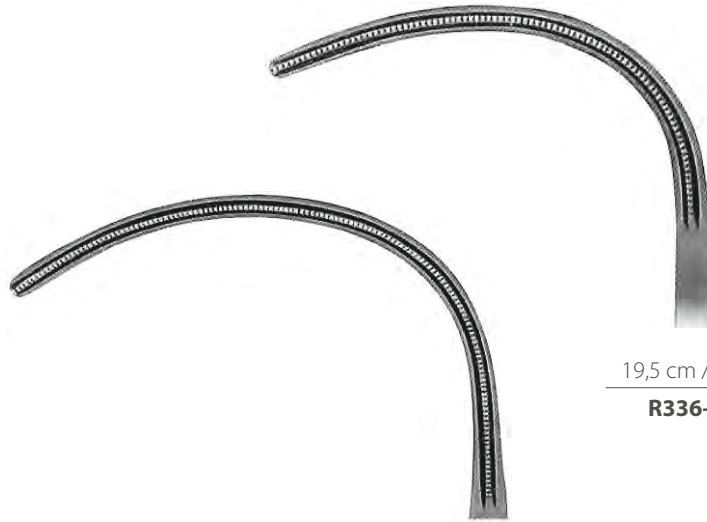

21 cm // 8 1/4"

R336-21

19,5 cm // 7 3/4"

R336-19

Aortaklemmen *Aorta Clamps*



WEBER
26 cm // 10 1/4"

R340-01



WEBER
26 cm // 10 1/4"

R340-02

Atrauma-Klemmen
Atrauma Forceps

Aortaklemmen
Aorta Clamps



DEBAKEY



OCHSNER
23,5 cm // 9 1/4"
R341-23



DIETRICH
21 cm // 8 1/4"
R346-21



DEBAKEY
27 cm // 10 1/2"
R347-27

Atrauma-Klemmen Atrauma Forceps

Aortaklemmen
Aorta Clamps



DEBAKEY



LAMBERT-KAY
21 cm // 8 1/2"

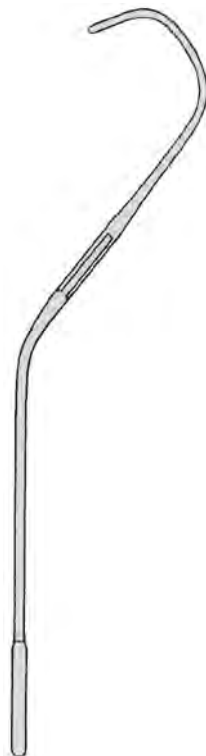

R350-01
R350-01N



R350-02
R350-02N

Atrauma-Klemmen
Atrauma Forceps

Aorta-Aneurysma-Klemmen
Aorta-Aneurysm Clamps



DEBAKEY



MORRIS-DEBAKEY

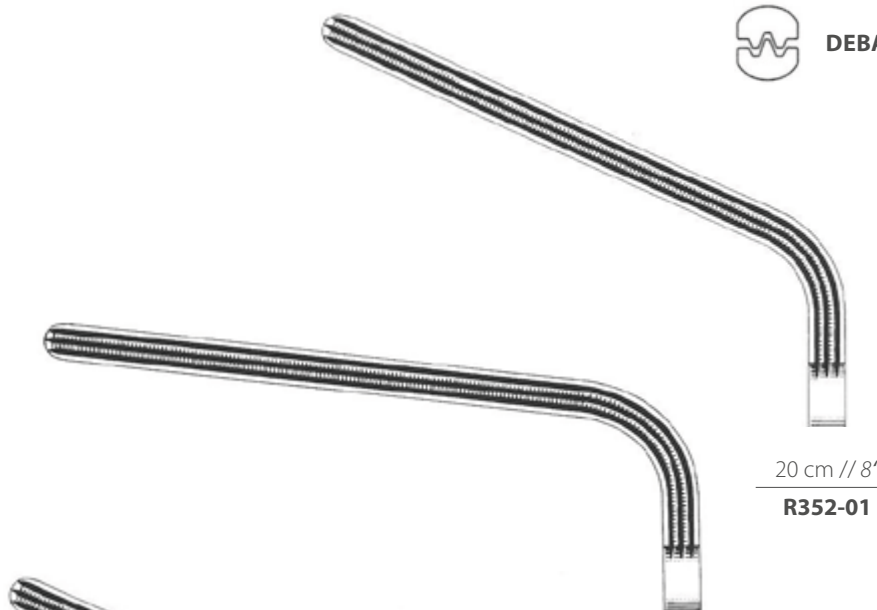

20 cm // 8"
R352-01

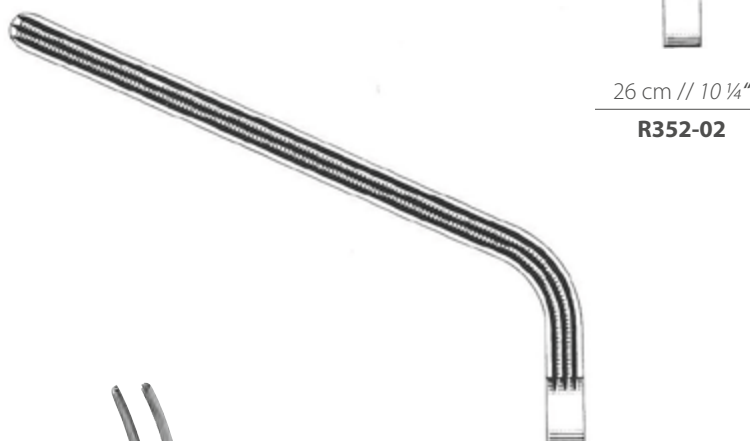

26 cm // 10 1/4"
R352-02



GLOVER
24,5 cm // 9 3/4"
R353-24



26,5 cm // 10 1/2"
R352-03

Atrauma-Klemmen
Atrauma Forceps

Aorta-Aneurysma-Klemmen
Aorta-Aneurysm Clamps



DEBAKEY



DEBAKEY

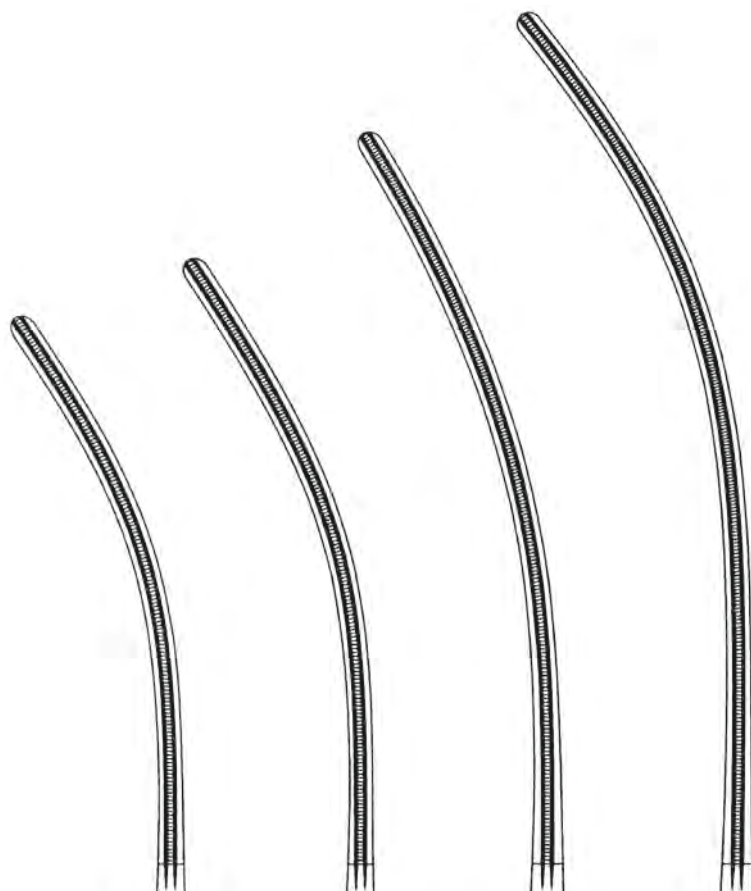

25 cm // 10"	27 cm // 10 ½"	31 cm // 12 ¼"	33 cm // 13"
R360-25	R360-27	R360-31	R360-33
-	R360-28N	R360-32N	R360-34N

Atrauma-Klemmen
Atrauma Forceps

Aorta-Aneurysma-Klemmen
Aorta-Aneurysm Clamps



DEBAKEY
28 cm // 11"
R366-28

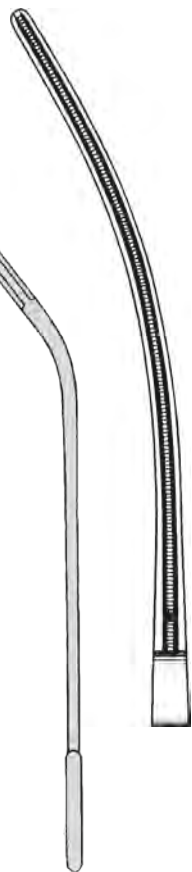

DEBAKEY
31 cm // 12 1/4"
R368-30



WYLIE
24 cm // 9 1/2"
R362-24



Atrauma-Klemmen Atrauma Forceps

Aurikelklemmen
Auricle Clamps



DEBAKEY



HARKEN



25 cm // 10"
R370-01

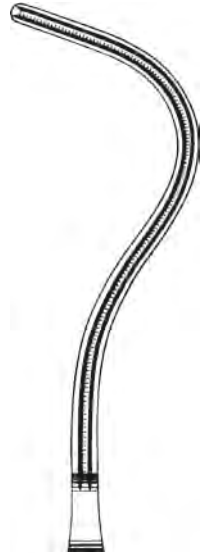

24 cm // 9 1/2"
R370-02

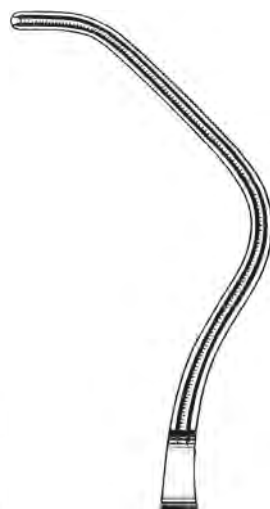

24 cm // 9 1/2"
R370-03

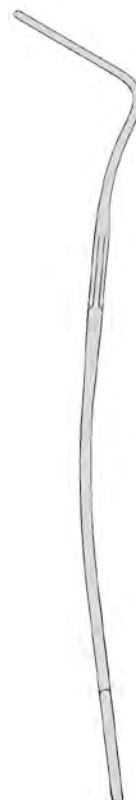

24 cm // 9 1/2"
R370-04

Atrauma-Klemmen
Atrauma Forceps

Aorta-Aneurysma-Klemmen
Aorta-Aneurysm Clamps



DEBAKEY



DEBAKEY-BAHNSON

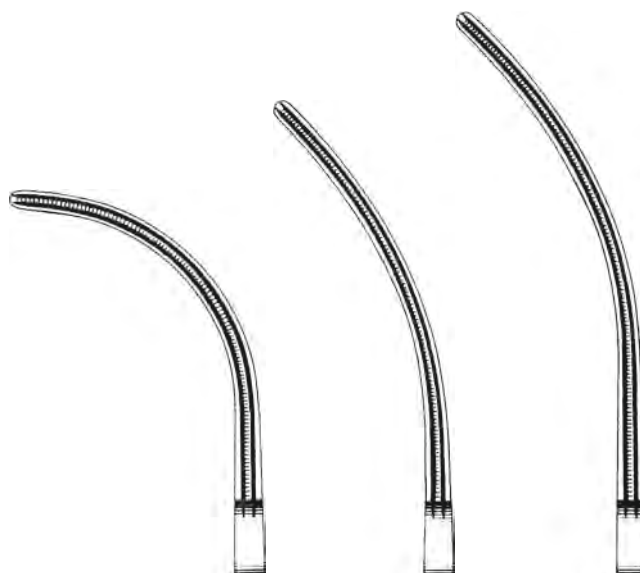

26 cm // 10 1/4"

R375-01

26,5 cm // 10 1/2"

R375-02

28,5 cm // 11 1/4"

R375-03

Bronchusklemmen
Bronchus Forceps



LEES

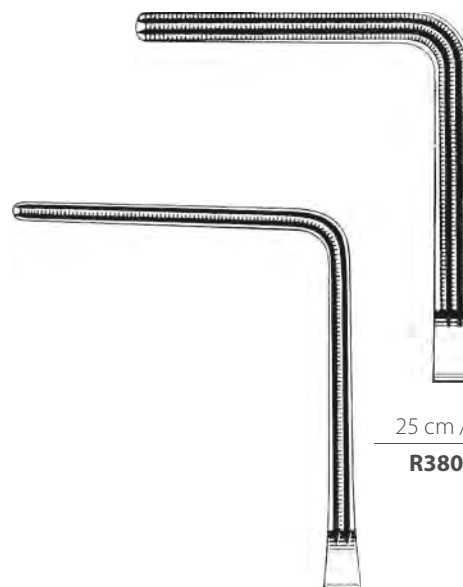

25 cm // 10"

R380-25

LEES

22,5 cm // 9"

R382-22

R382-22N

Atrauma-Klemmen Atrauma Forceps

Bronchusklemmen
Bronchus Forceps



DEBAKEY

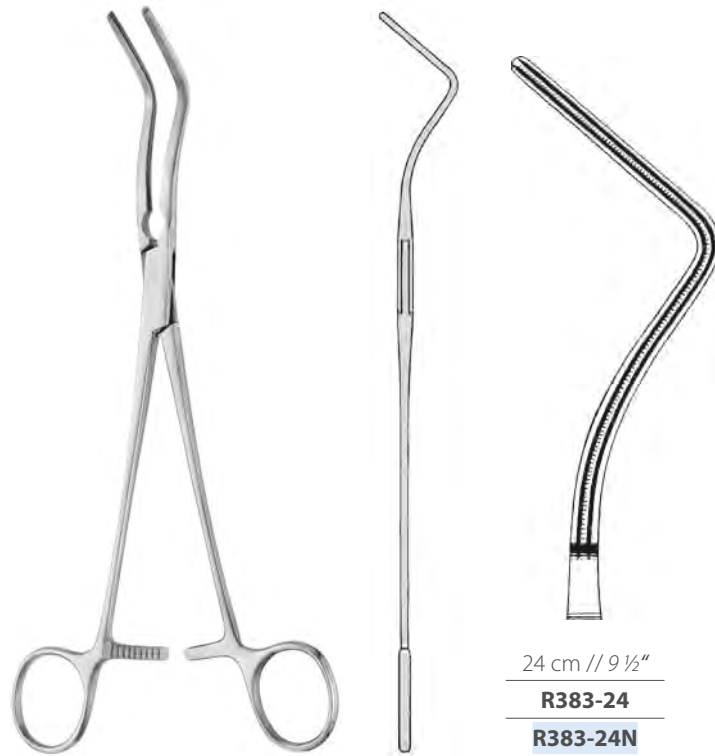

24 cm // 9 1/2"

R383-24

R383-24N

Coarctationsklemmen Coarctation Clamps

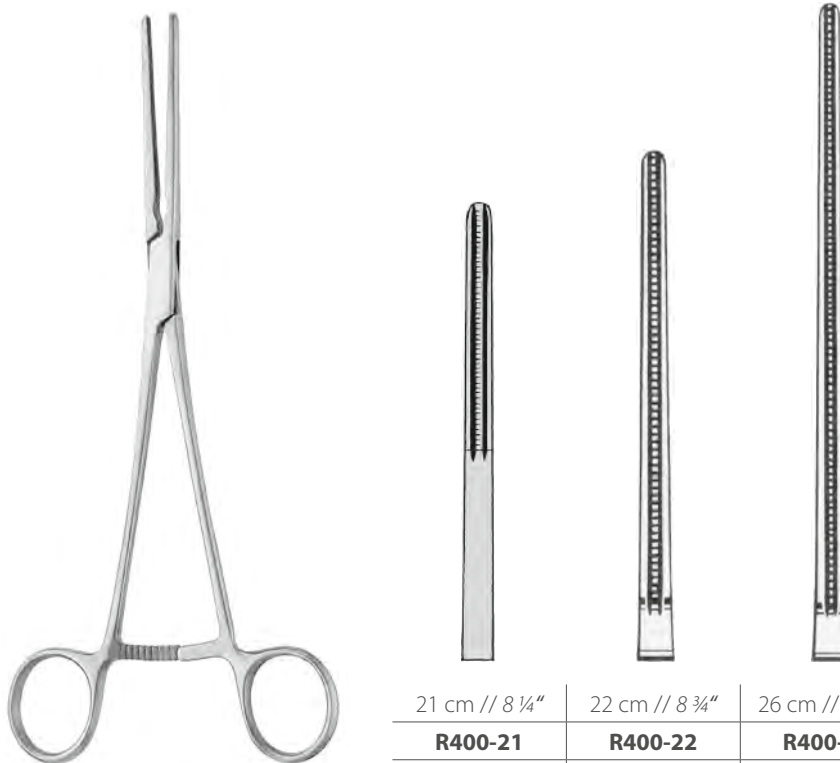

POTTS (GLOVER)

21 cm // 8 1/4"

R400-21

22 cm // 8 3/4"

R400-22

R400-22N

26 cm // 10 1/4"

R400-26

Atrauma-Klemmen
 Atrauma Forceps

Coarctationsklemmen
 Coarctation Clamps



DEBAKEY



POTTS (GLOVER)

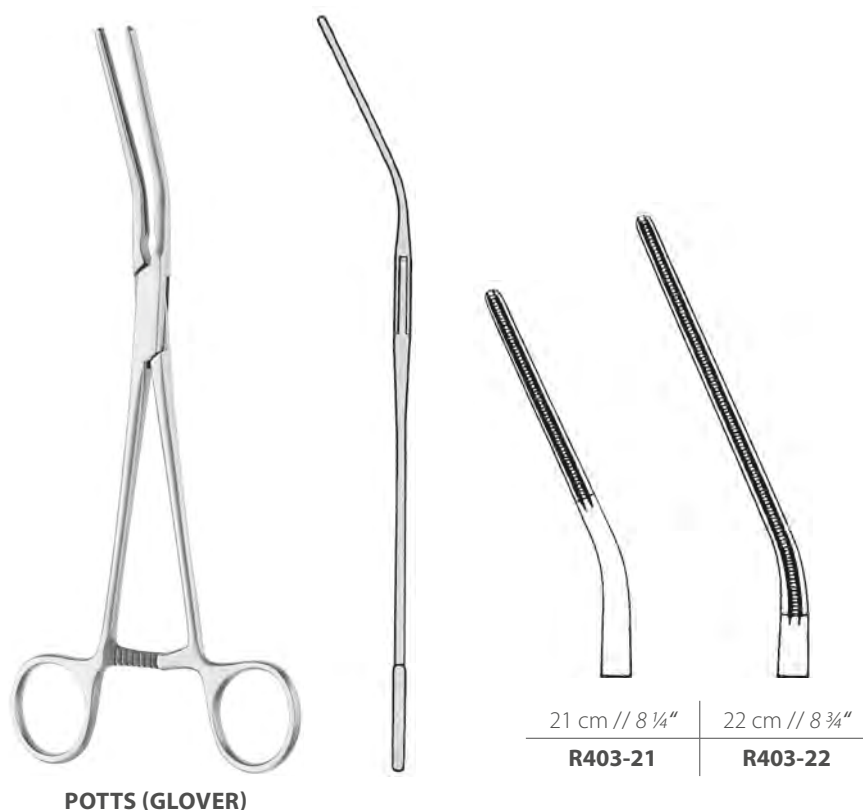

POTTS (GLOVER)

Atrauma-Klemmen Atrauma Forceps

Coarctationsklemmen
Coarctation Clamps



DEBAKEY



DEBAKEY



20 cm // 8"

R410-20



23 cm // 9"

R410-23



26 cm // 10 1/4"

R410-26



31,5 cm // 12 1/2"

R410-31



DEBAKEY



20 cm // 8"

R411-20



23 cm // 9"

R411-23



26 cm // 10 1/4"

R411-26



31,5 cm // 12 1/2"

R411-31

Atrauma-Klemmen
Atrauma Forceps

Coarctationsklemmen
Coarctation Clamps



DEBAKEY



DEBAKEY

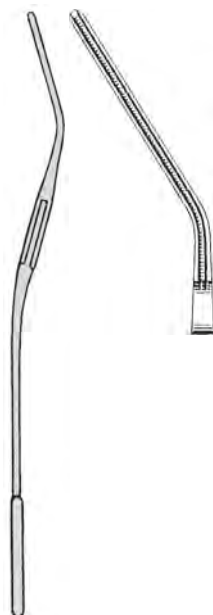

16 cm // 6 1/4"

R425-01

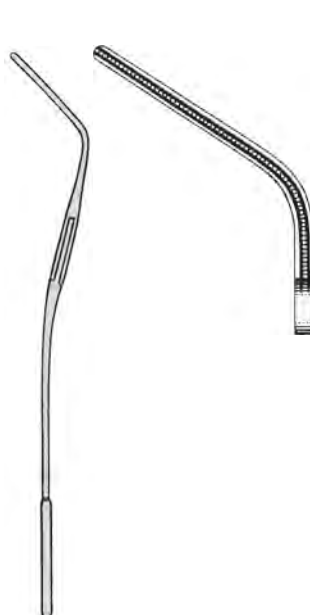

15,5 cm // 6"

R425-02

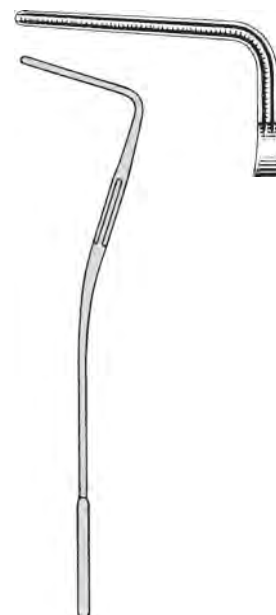

14,5 cm // 5 3/4"

R425-03



DEBAKEY
 17 cm // 6 3/4"

R428-01



R428-02

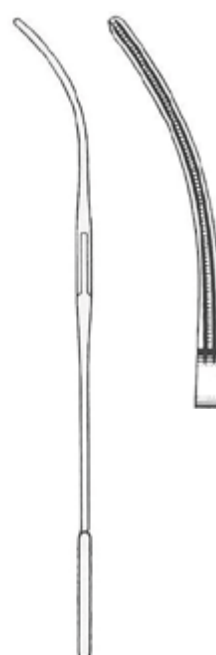

R428-03



R428-04

Atrauma-Klemmen Atrauma Forceps

Mehrzweckklemmen
Multi-Purpose Clamps



DEBAKEY



LELAND-JOHNES



Fig. 1

19,5 cm // 7 1/2"

R432-01

R432-01N



Fig. 2

19,5 cm // 7 1/2"

R432-02

R432-02N



Fig. 3

18 cm // 7"

R432-03

R432-03N



LELAND-JONES

18 cm // 7"

R433-18

R433-18N



DEBAKEY

20 cm // 8"

R440-23

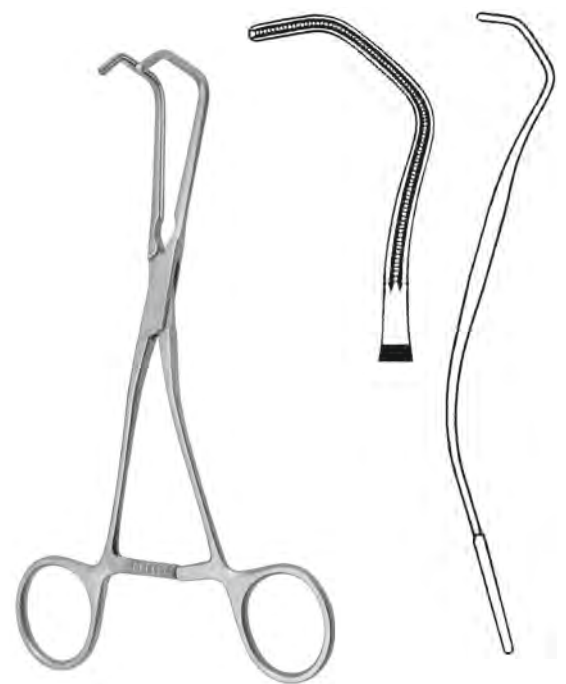

DEBAKEY

17 cm // 6 3/4"

R442-17

Atrauma-Klemmen
Atrauma Forceps

Mehrzweckklemmen
Multi-Purpose Clamps



BECK
 16 cm // 6 1/4"
R444-16
R444-16N



DEBAKEY
 16 cm // 6 1/4"
R446-16
R446-16N



DEBAKEY-BECK



20,5 cm // 8"
R448-01



21 cm // 8 1/4"
R448-02

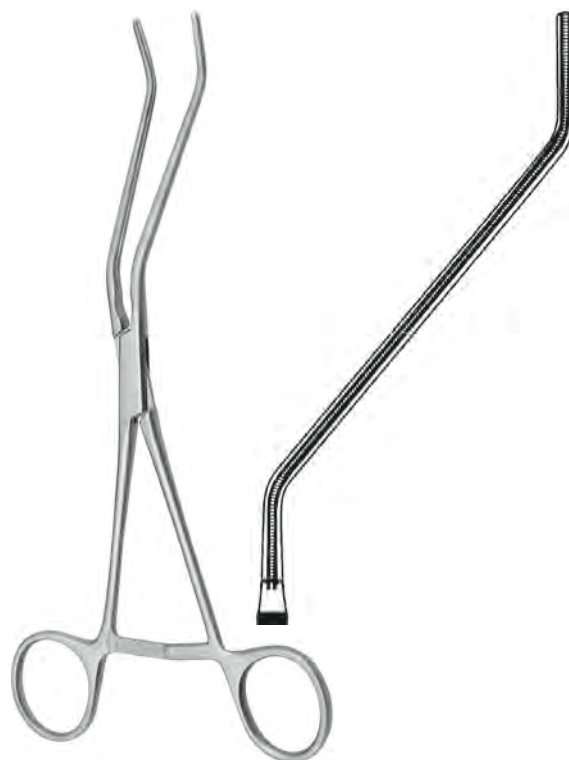

HENLY
 20 cm // 8"
R451-20

Atrauma-Klemmen Atrauma Forceps

Peripheal-Gefäßklemmen
Peripheal Vascular Clamps



DEBAKEY



DALE
17 cm // 6 3/4"

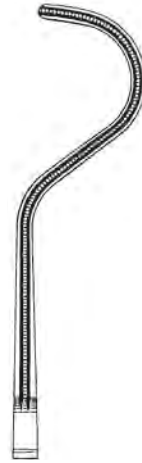

R455-01

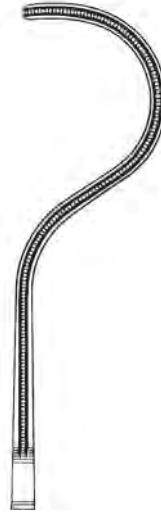

R455-02

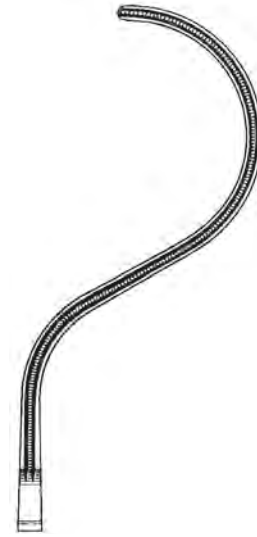

R455-03

Profunda-Klemmen Profunda Clamps



GREGORY

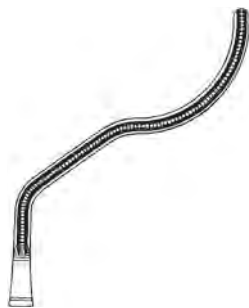

14,5 cm // 5 1/2"
R460-14

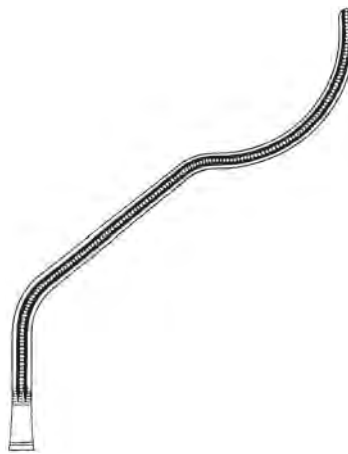

19,5 cm // 7 3/4"
R460-19

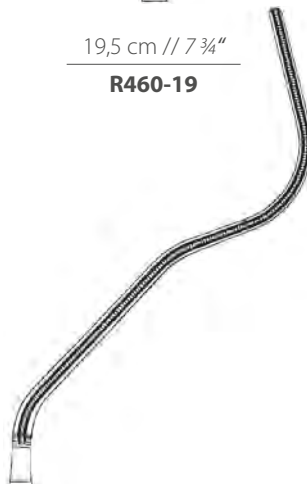

18,5 cm // 7 1/4"
R460-18

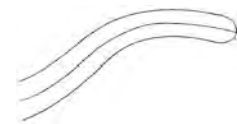

SUBRAMANIAN-MINIATURE
15 cm // 6"
R462-15
R462-15N

Atrauma-Klemmen
Atrauma Forceps

Präparier- und Ligaturklemmen
Dissecting and Ligature Clamps



DEBAKEY



DEBAKEY
24 cm // 9 1/2"

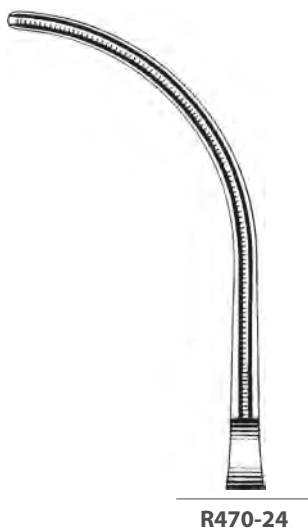

R470-24

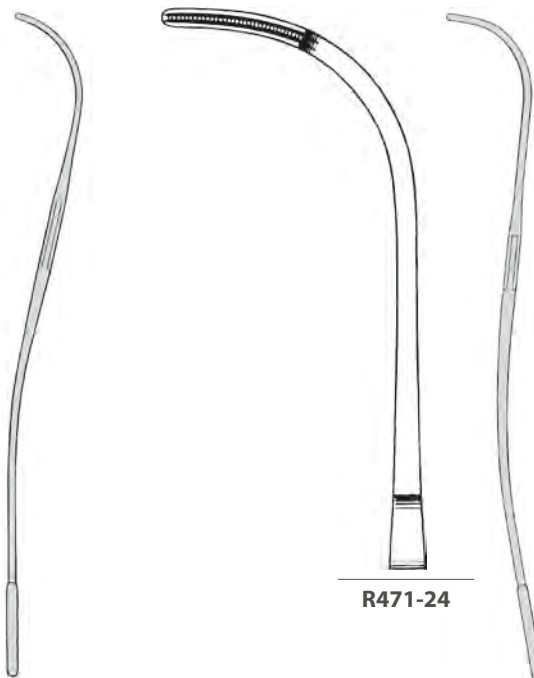

R471-24

Aorta-Aneurysm-Klemmen
Aorta-Aneurysm Clamps



DEBAKEY
27 cm // 10 1/2"



R473-27

R472-27
R472-27N

Atrauma-Klemmen Atrauma Forceps

Anastomosenklemmen Anastomosis Clamps



Ligaturklemmen Ligature Clamps

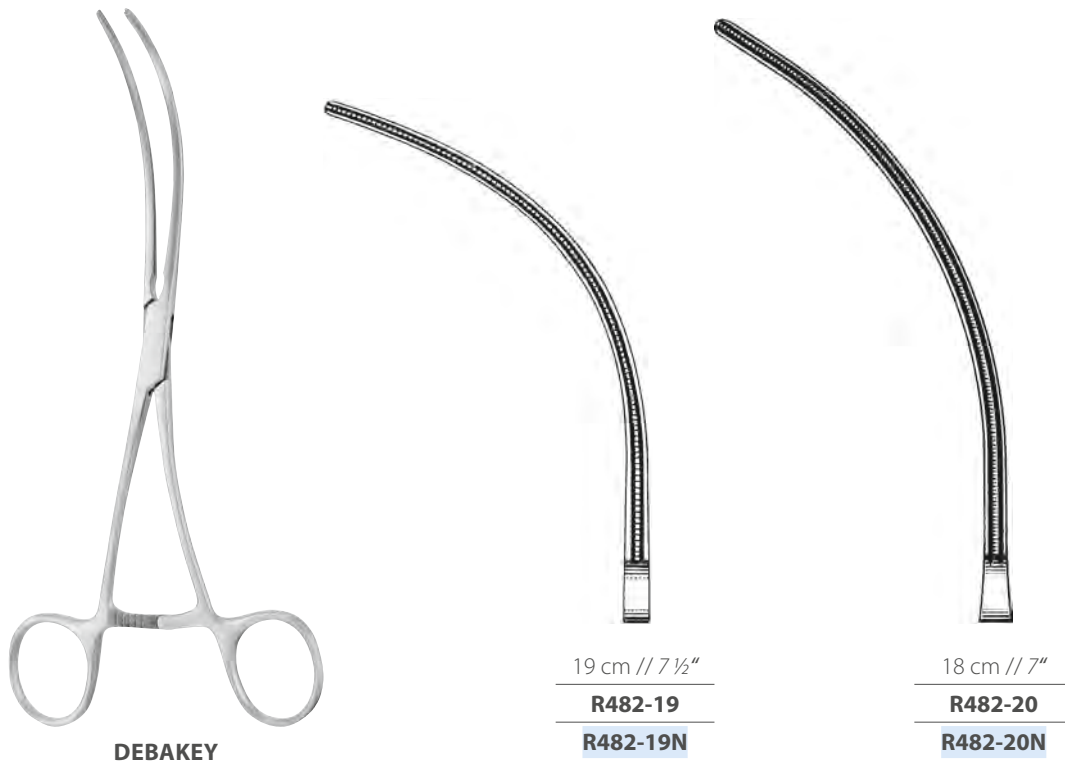

Atrauma-Klemmen
 Atrauma Forceps

Mehrzweckklemmen
 Multi-Purpose Clamps



DEBAKEY



24 cm // 9 1/2"

R491-24

R491-24N

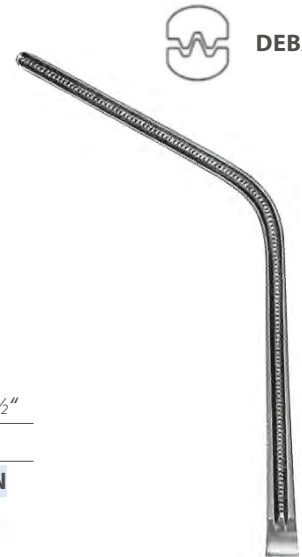

DEBAKEY

25 cm // 10"

R491-25

R491-25N

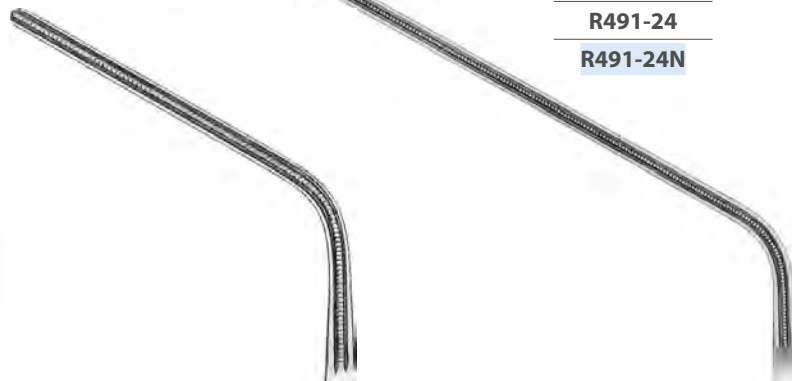

20 cm // 8"

R491-20

R491-20N

30 cm // 12"

R491-30

R491-30N

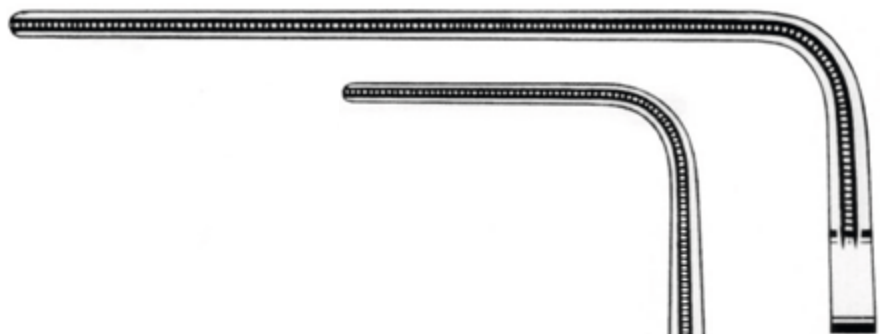

27 cm // 10 1/2"

R493-27

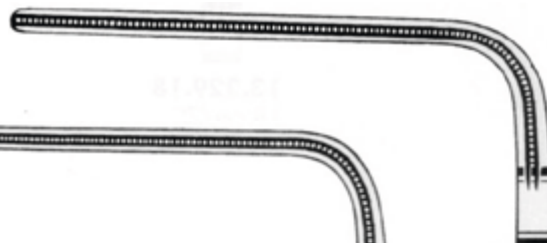

22,5 cm // 9"

R493-23



21,5 cm // 8"

R493-21

18 cm // 7"

R493-18

Atrauma-Klemmen Atrauma Forceps

Tangentialklemmen
Tangential Occlusion Clamps



DEBAKEY



SATINSKY-DEBAKEY



20 cm // 8"

R500-01

R500-01N



25 cm // 10"

R500-02

R500-02N



26 cm // 10 1/4"

R500-03

R500-03N



27 cm // 10 1/2"

R500-04

R500-04N



28 cm // 11"

R500-05

R500-05N

Atrauma-Klemmen
 Atrauma Forceps

Mehrzweckklemmen
 Multi-Purpose Clamps



DARDIK

13 cm // 5"

17 cm // 6 3/4"

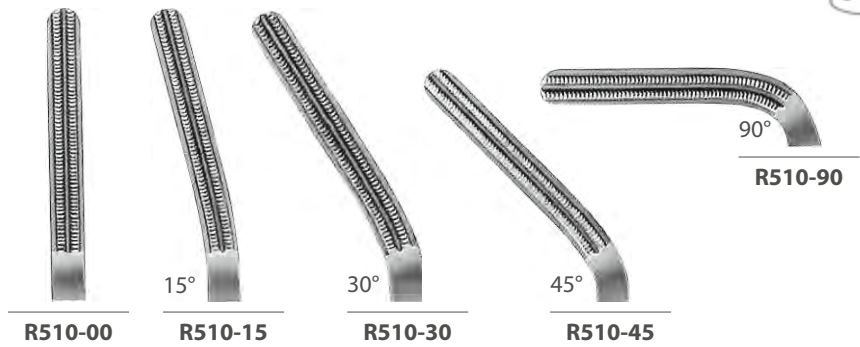

R510-00

15°

R510-15

30°

R510-30

45°

R510-45

90°

R510-90

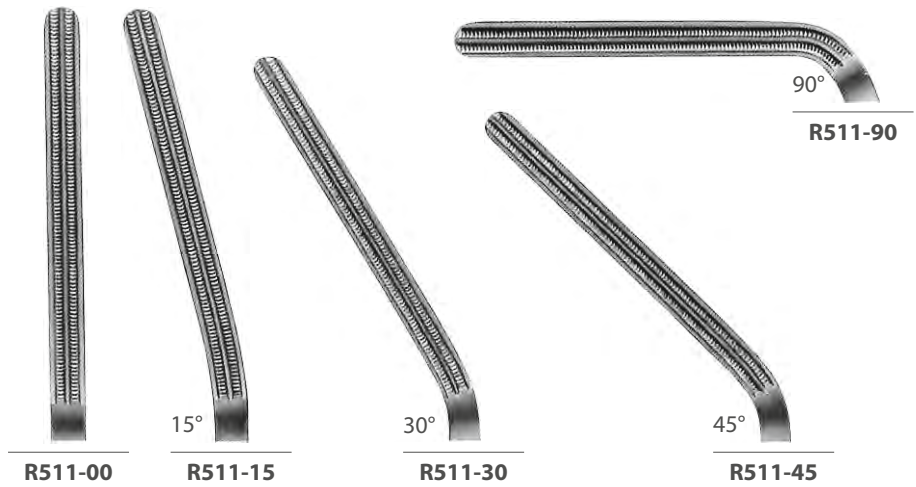

R511-00

15°

R511-15

30°

R511-30

45°

R511-45

90°

R511-90



DEBAKEY
 12,5 cm // 5"

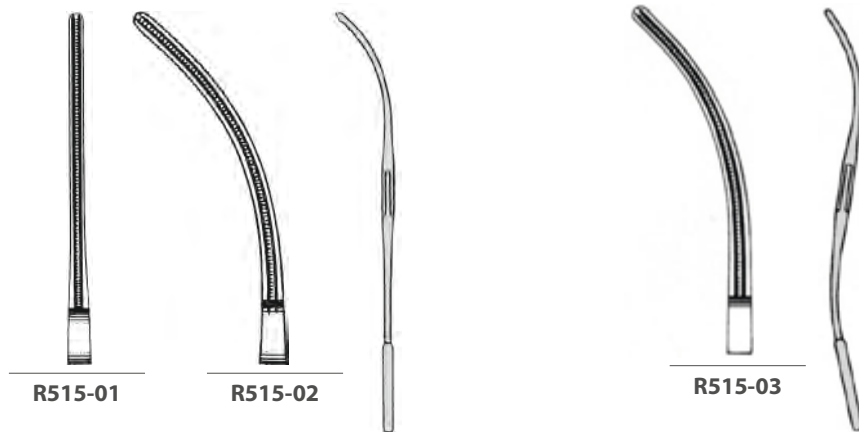

R515-01

R515-02

R515-03

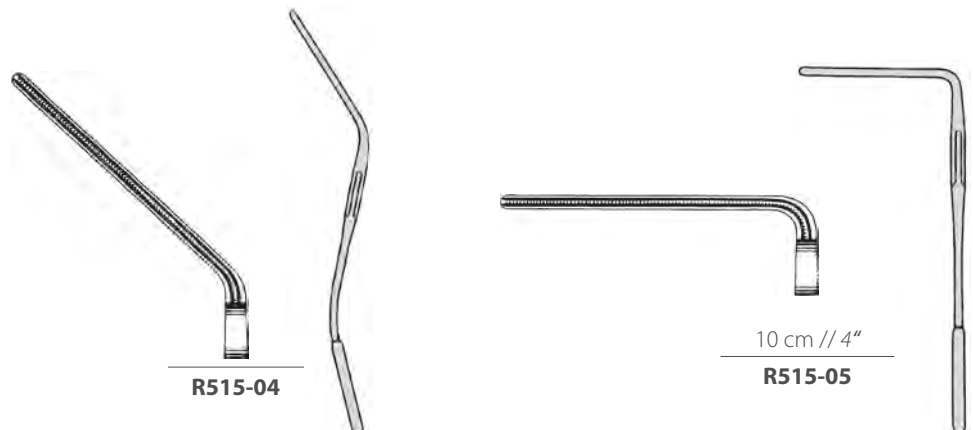

R515-04

10 cm // 4"

R515-05

Atrauma-Klemmen *Atrauma Forceps*

Feine Klemmen
Fine Forceps



DEBAKEY-CASTANEDA
12 cm // 4 3/4"

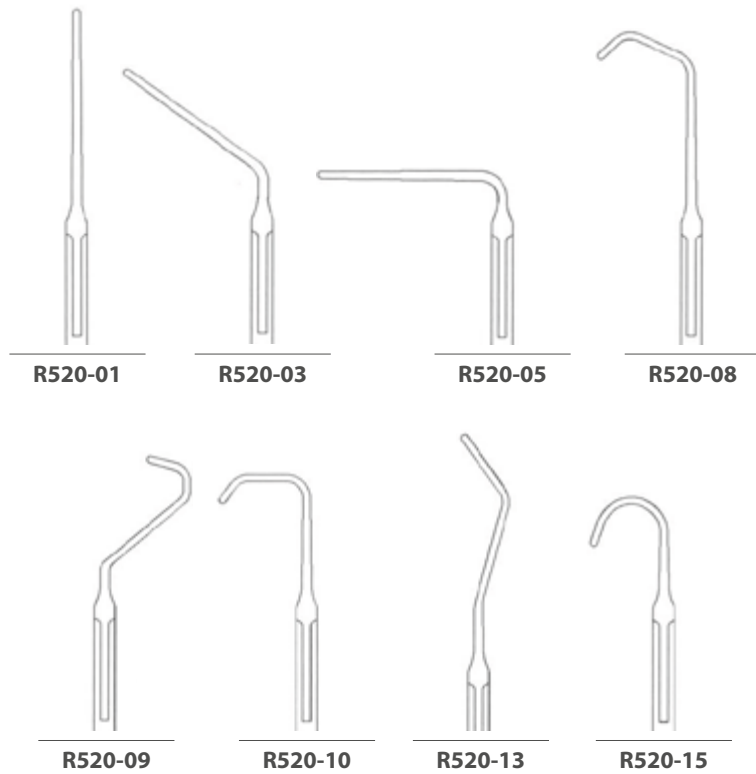

Atrauma-Klemmen
Atrauma Forceps

Carotis-Shuntklemmen
Carotid Shunt Clamps



JAVID
 15,5 cm // 6"
R530-15



JAVID
 18 cm // 7"
R530-18



COOLEY

	Charr. French	
16 cm // 6 ¼"	24	R550-24
16 cm // 6 ¼"	26	R550-26
19 cm // 7 ½"	28	R550-28
19 cm // 7 ½"	30	R550-30
19 cm // 7 ½"	32	R550-32
19 cm // 7 ½"	34	R550-34
19 cm // 7 ½"	36	R550-36

Atrauma-Klemmen Atrauma Forceps

Mehrzweckklemmen
Multi-Purpose Clamps



COOLEY
16 cm // 6 1/4"
R561-16



COOLEY
17 cm // 6 3/4"



R564-01
R564-01N



R564-02
R564-02N



R564-03
R564-03N



R564-04
R564-04N

Atrauma-Klemmen
Atrauma Forceps



Iliaca-Klemmen
Iliac Clamps



COOLEY

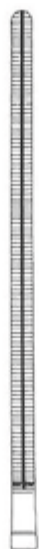

21,5 cm // 8 1/2"

R570-21

25 cm // 10"

R570-25



BECK

17 cm // 6 3/4"

R579-17

Anastomosenklemmen
Anastomosis Clamps



COOLEY-DERRA



16 cm // 6 1/4"

R580-01



17 cm // 6 3/4"

R580-02

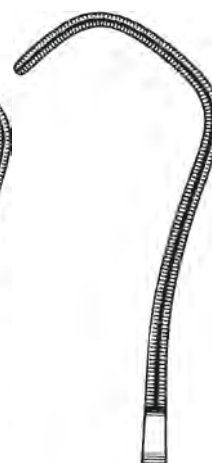

18 cm // 7"

R580-03

Atrauma-Klemmen Atrauma Forceps



18 cm // 7"	20 cm // 8"	27 cm // 10 1/2"
R610-18	R610-20	R610-27
-	R610-20N	R610-27N

Tangentialklemmen Tangential Clamps



COOLEY



20 cm // 8"
R612-01



20,5 cm // 8"
R612-02



22 cm // 8 3/4"
R612-03



23,5 cm // 9 1/4"
R612-04

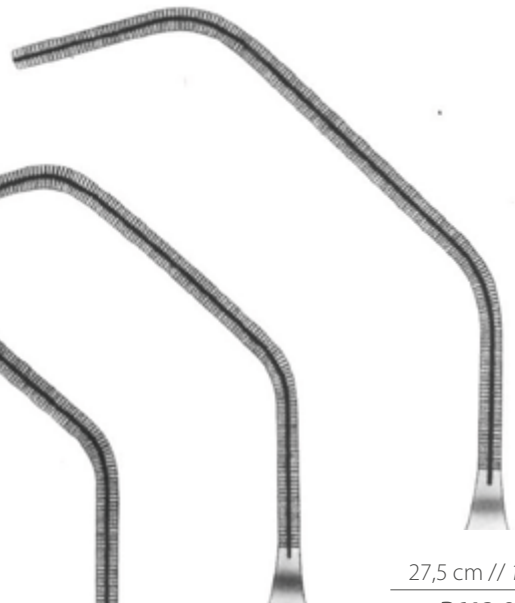

27,5 cm // 10 3/4"
R612-05

Atrauma-Klemmen
Atrauma Forceps

Mehrzweckklemmen
Multi Purpose Clamps



COOLEY
 16 cm // 6 1/4"
R615-16

Anastomosenklemmen
Anastomosis Clamps



COOLEY
 16 cm // 6 1/4"
R616-16
R616-16N



COOLEY
 17 cm // 6 3/4"
R616-17
R616-17N

Feine Klemmen
Fine Forceps



COOLEY
 12,5 cm // 5"

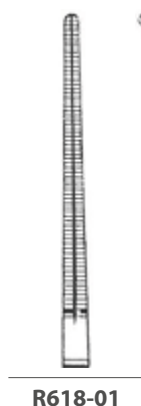

R618-01

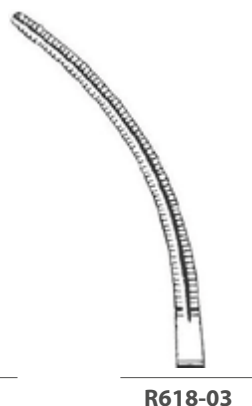

R618-03

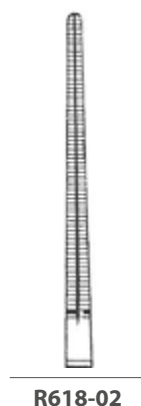

R618-02

Atrauma-Klemmen Atrauma Forceps



COOLEY
12,5 cm // 5"



R618-04



R618-05



R618-06



COOLEY
14 cm // 5 1/2"



R620-01



R620-02



R620-03



Atrauma-Klemmen
 Atrauma Forceps



R620-04

COOLEY
 14 cm // 5 1/2"

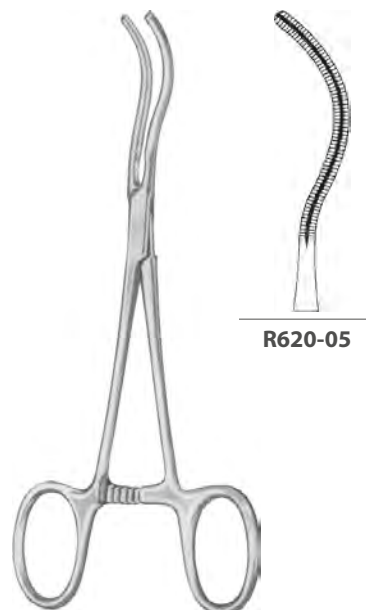

R620-05



COOLEY

16,5 cm // 6 1/2"

R624-16
R624-16N

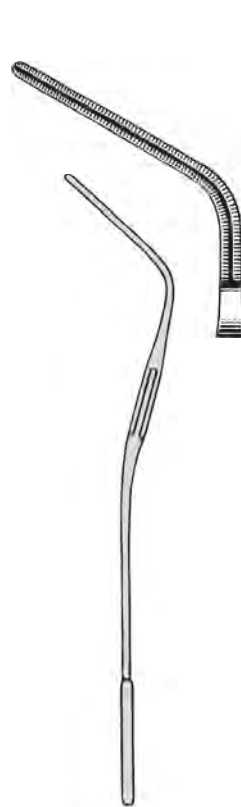

15,5 cm // 6"

R624-15
R624-15N

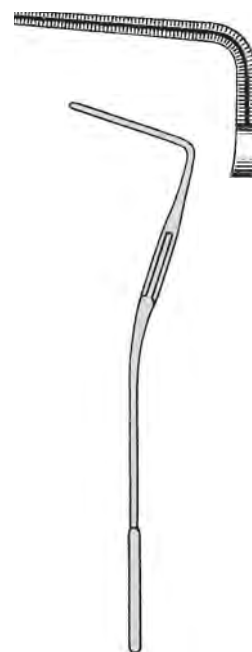

13,5 cm // 5 1/4"

R624-13
R624-13N

Atrauma-Klemmen Atrauma Forceps



COOLEY
15 cm // 6"



Fig. 1

Fig. 2

Fig. 3

Fig. 4

Fig. 5

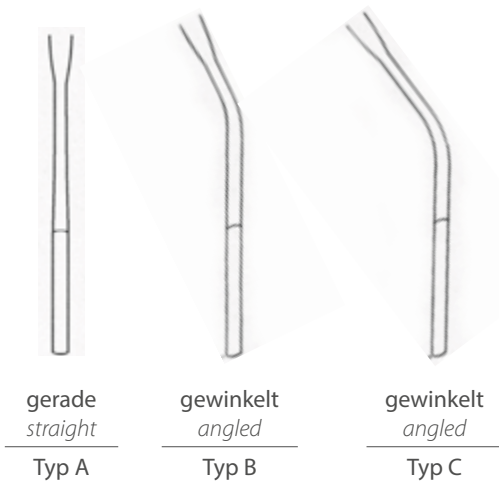

Fig. 6

Fig. 7

Fig. 8

Fig. 9



	Typ A	Typ B	Typ C
Fig. 1	R630-01	R631-01	R632-01
Fig. 2	R630-02	R631-02	R632-02
Fig. 3	R630-03	R631-03	R632-03
Fig. 4	R630-04	R631-04	R632-04
Fig. 5	R630-05	R631-05	R632-05
Fig. 6	R630-06	R631-06	R632-06
Fig. 7	R630-07	R631-07	R632-07
Fig. 8	R630-08	R631-08	R632-08
Fig. 9	R630-09	R631-09	R632-09

Atrauma-Klemmen
Atrauma Forceps

Neonatal- und Pädiatrie-Klemmen
Neonatal and Pediatric Clamps



CASTANEDA
11-14 cm



R640-03



R640-04



R640-06

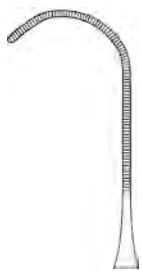

R640-08



R640-09



R640-10



R640-11

Magen / Darm / Niere / Galle / Blase

// Stomach / Intestinal / Kidney / Gall / Bladder

Inhalt Index

Abschnitt // Section **S**

Darmfazzangen, Darmklemmen <i>Intestinal Tissue forceps, Intestinal Tissue Forceps</i>	S02 - S04
Magenklemmen <i>Stomach Clamp Forceps</i>	S05 - S10
Rektalinstrumente <i>Rectal Instruments</i>	S11 - S19
Nierenstielklemmen <i>Kidney Clamp forceps</i>	S20 - S21
Gallensteinzangen, Gallensteinlöffel <i>Gall Stone Forceps, Gall Stone Scoops</i>	S22
Prostatahaken, Kapsel-fazzangen <i>Prostatic Retractors, Capsula forceps</i>	S23
Blasenwundspreizer <i>Bladder Retractors</i>	S24 - S25
Dilatationsbougies, Katheter <i>Dilating Bougies, Catheter</i>	S26 - S28
Diverse Urologieinstrumente <i>Various Urology Instruments</i>	S29 - S30

Darmfazzangen
Intestinal Tissue forceps



ALLIS

	4 x 5 Zähne 4 x 5 teeth	5 x 6 Zähne 5 x 6 teeth
15 cm // 6"	S100-15	S101-15
16 cm // 6 ¼"	-	S101-15N
19 cm // 7 ½"	-	S101-19
23 cm // 9"	-	S101-23
25 cm // 10"	-	S101-25
29 cm // 11 ½"	-	S101-29
36 cm // 14"	-	S101-36
40 cm // 16"	-	S101-40
46 cm // 18"	-	S101-46



ALLIS-ATRAUMA

16 cm // 6 ¼"	S101-16U
19 cm // 7 ½"	S101-19U
22 cm // 8 ½"	S101-22U
25 cm // 10"	S101-25U
30 cm // 12"	S101-30U



BABY-ALLIS

12 cm // 4 ¾"	S102-12
14 cm // 5 ½"	S102-14



ALLIS-ADAIR

15 cm // 6"

S106-15



BOYS-ALLIS

15 cm // 6"

S107-15



THOMS-ALLIS

20 cm // 8"

S108-20



JUDD-ALLIS

15 cm // 6"

S109-15

16 cm // 6 ¼"

S109-19

Darmfazzangen Intestinal Tissue forceps



LOCKWOOD-ALLIS

16 cm // 6 1/4" | **S110-16**
20 cm // 8" | **S110-20**



LITTLEWOOD

18,5 cm // 7 1/4"
S112-18



WILLIAMS

16 cm // 6 1/4"
S114-16



LOCKWOOD

24 cm // 9 1/2"
S118-24



BABCOCK

16 cm // 6 1/4" | **S120-16**

18 cm // 7" | **S120-18**

18 cm // 7" | **S120-18N**

20 cm // 8" | **S120-20**

24 cm // 9 1/2" | **S120-24**

30 cm // 12" | **S120-30**

36 cm // 14" | **S120-36**

40 cm // 16" | **S120-40**



BABCOCK TC

S120-16T

-

-

S120-20T

-

-

-

-



BABCOCK-ATRAUMA

S120-16U

-

-

S120-20U

-

-

-

-



BABY-BABCOCK

S121-16

-

-

-

-

-

-

-

	BABCOCK	BABCOCK TC	BABCOCK-ATRAUMA	BABY-BABCOCK
16 cm // 6 1/4"	S120-16	S120-16T	S120-16U	S121-16
18 cm // 7"	S120-18	-	-	-
18 cm // 7"	S120-18N	-	-	-
20 cm // 8"	S120-20	S120-20T	S120-20U	-
24 cm // 9 1/2"	S120-24	-	-	-
30 cm // 12"	S120-30	-	-	-
36 cm // 14"	S120-36	-	-	-
40 cm // 16"	S120-40	-	-	-

Gewebe- Organfasszangen
Tissue-, Organ holding forceps



DUVAL



20 cm // 8"	S122-20	-
20 cm // 8"	S122-20N	-
20 cm // 8"	S122-20T	S122-50
23 cm // 9"	S122-23	S122-53



18 cm // 7"	S126-18
20 cm // 8"	S126-20
23 cm // 9"	S126-23



25 cm // 10"	S127-25
26 cm // 10 1/4"	S127-26

Darmklemmen Intestinal Tissue Forceps

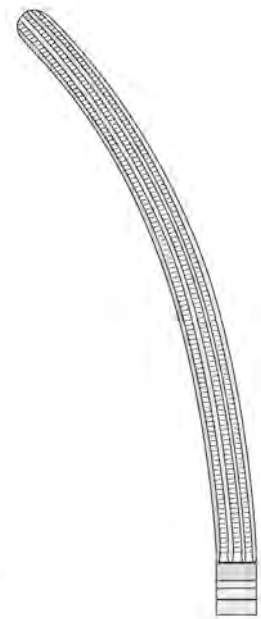
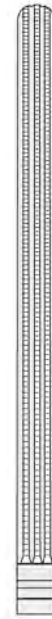
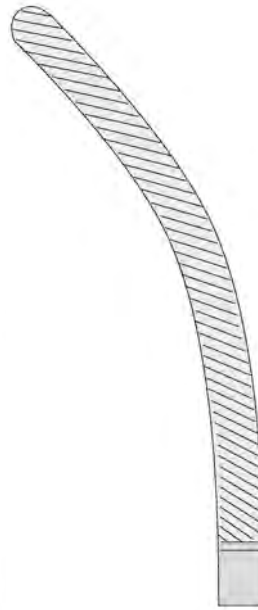

DOYEN

DOYEN-ATRAUMA

	gerade straight	gebogen curved	gerade straight	gebogen curved
16 cm // 6 1/4"	S130-16	S131-16	S130-16U	S131-16U
18 cm // 7"	S130-18	S131-18	S130-18U	S131-18U
21 cm // 8 1/4"	S130-21	S131-21	S130-21U	S131-21U
23 cm // 9"	S130-23	S131-23	S130-23U	S131-23U

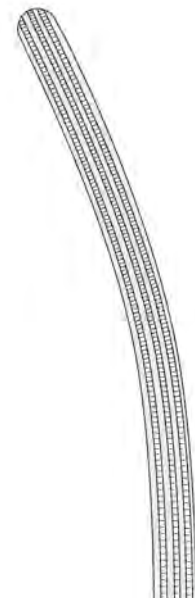

MAYO-ROBSEN

MAYO-ROBSEN-ATRAUMA

	gerade straight	gebogen curved	gerade straight	gebogen curved
21 cm // 8 1/4"	S134-21	S135-21	-	-
23 cm // 9"	S134-23	S135-23	-	-
25 cm // 10"	S134-25	S135-25	S134-25U	S135-25U
25 cm // 10"	S134-25N	S135-25N	-	-

Darmklemmen
Intestinal Tissue Forceps



ALLEN

15 cm // 6"

S136-15

20 cm // 8"

S136-20



BRUNNER

24 cm // 9 1/2"

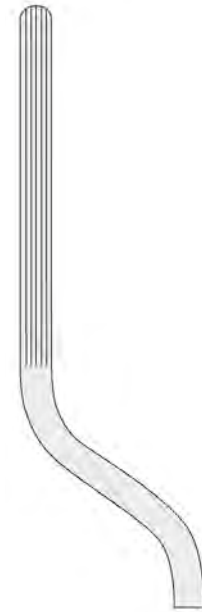

BRUNNER
S139-24

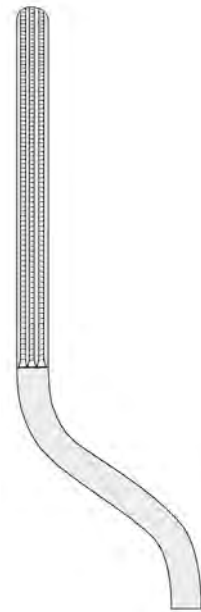

BRUNNER-ATRAUMA
S139-24U

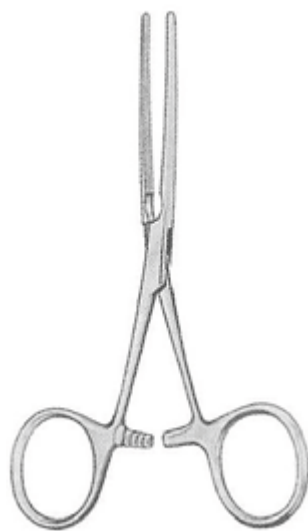

BABY-KOCHER

13 cm // 5"



gerade
straight

S140-13



gebogen
curved

S141-13

Darmklemmen Intestinal Tissue Forceps

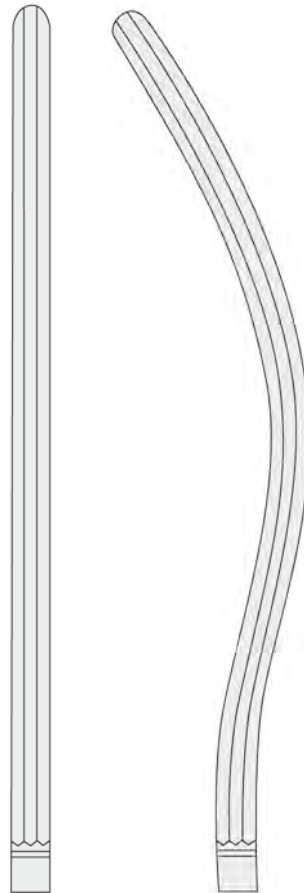

KOCHER

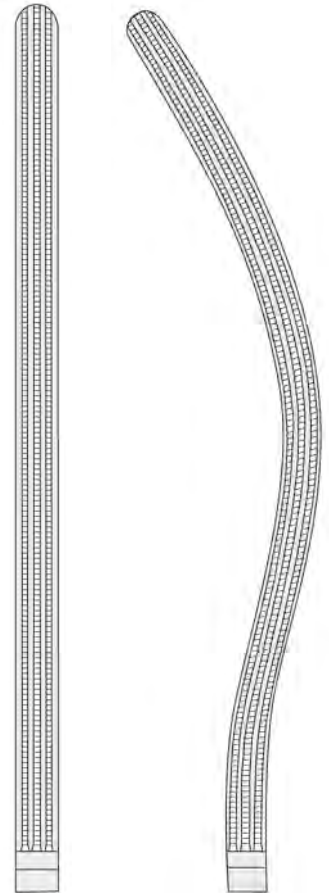

KOCHER-ATRAUMA

	gerade <i>straight</i>	gebogen <i>curved</i>	gerade <i>straight</i>	gebogen <i>curved</i>
22 cm // 8 1/2"	S140-22	S141-22	S140-22U	S141-22U
25 cm // 10"	S140-25	S141-25	S140-25U	S141-25U
28 cm // 11"	S140-28	S141-28	S140-28U	S141-28U

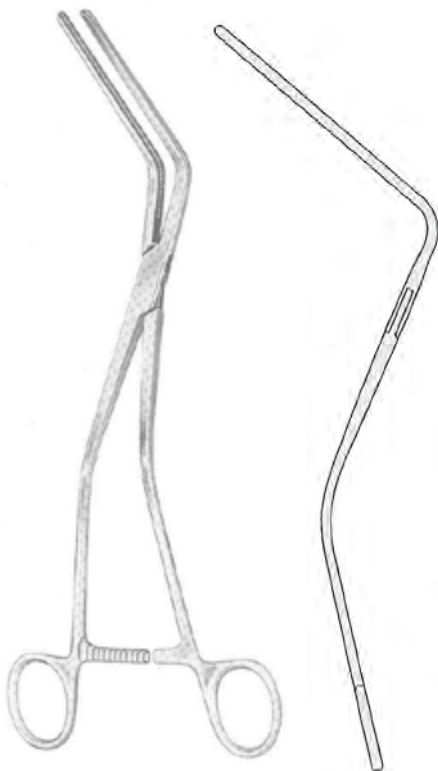

HAYES

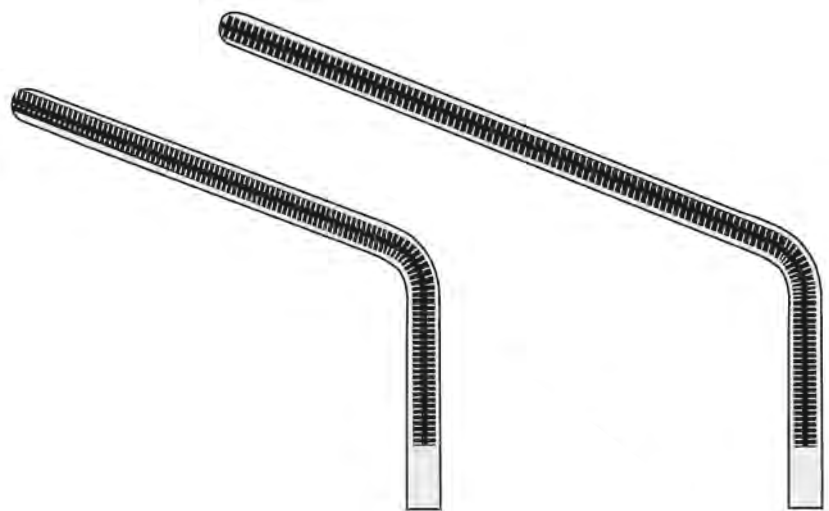

28 cm // 11"

S146-28

26 cm // 10 1/4"

S146-26

Darmklemmen
Intestinal Tissue Forceps

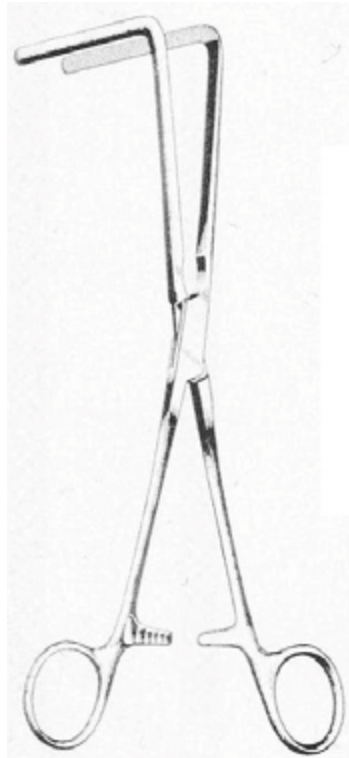

FEHLAND
25 cm // 10"
S147-25

FEHLAND-ATRAUMA
25 cm // 10"
S147-25U

Rektum-Anastomosenklemmen
Sigmoid Anastomosis Forceps



RESANO
30 cm // 12"
S149-30

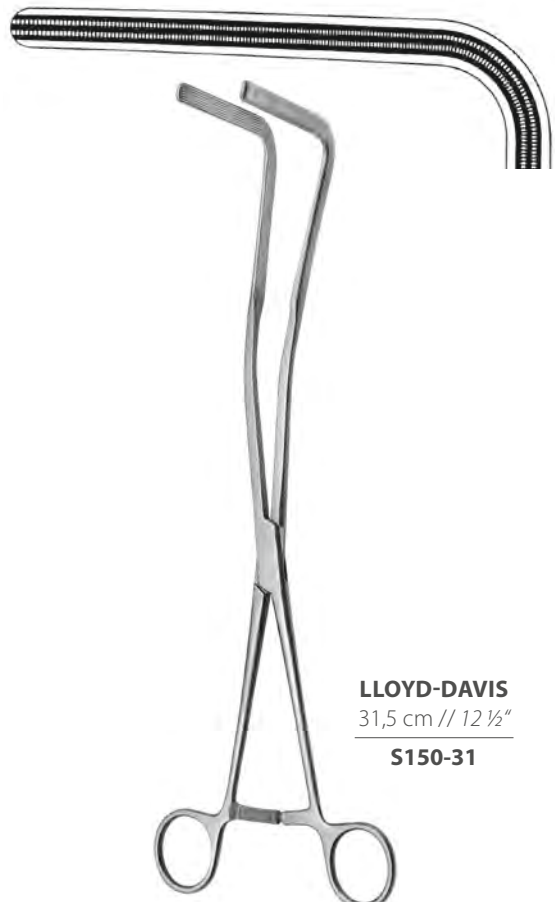

LLOYD-DAVIS
31,5 cm // 12 1/2"
S150-31

Magenklemmen Stomach Clamp Forceps

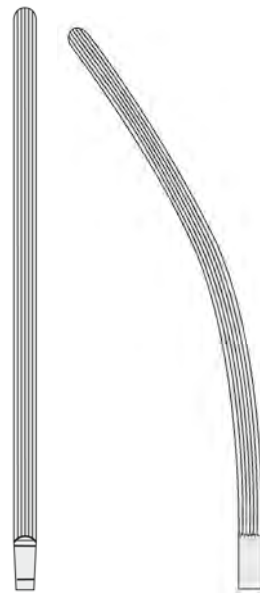

SCUDDER
30 cm // 12"

gerade
straight

S160-30

gebogen
curved

S161-30



SCUDDER-ATRAUMA
30 cm // 12"

gerade
straight

S160-30U

gebogen
curved

S161-30U



DE-MARTEL-WOLFSON
S170-26



Satz zu 3 Klemmen
Set of 3 Clamps

5 cm // 2"

S170-05

7 cm // 2 3/4"

S170-07

10 cm // 4"

S170-10



S170-11

Magenklemmen
Stomach Clamp Forceps

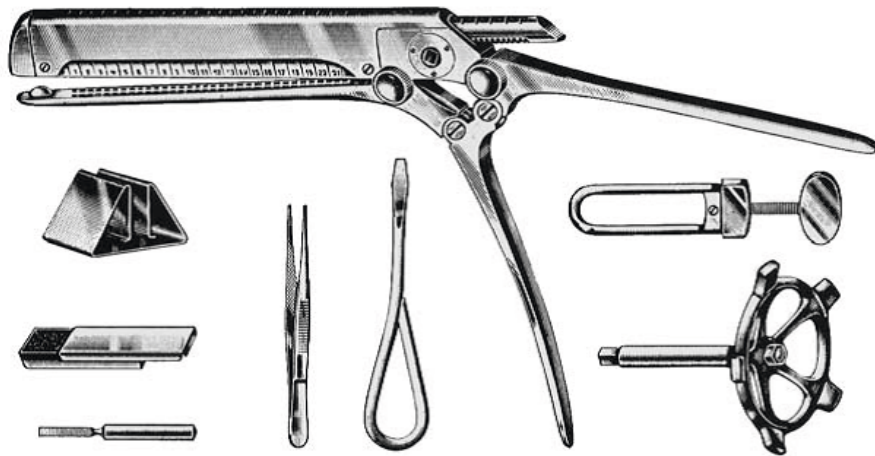

Magen- und Darm Nähapparat Petz kplt.
Stomach and Intestinal Suturing Apparatus Petz cplt.

S180-00

Magenklemmen
Stomach Clamp forceps



LANE

30 cm // 12"

gerade
straight

S182-30

gebogen
curved

S183-30

Darm- und Magenquetschklemmen
Intestinal and Stomach Clamps

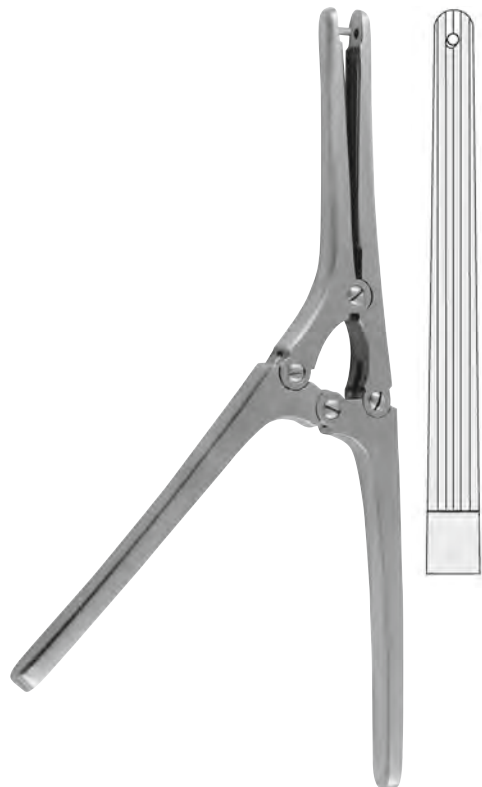

PAYR

15 cm // 6"

S185-15

21 cm // 8 1/4"

S185-21

29 cm // 11 1/2"

S185-29

35 cm // 13 3/4"

S185-35

Mastdarmspekula Rectal Specula



PRATT
20 cm // 8"
S193-20



SIMS
15 cm // 6"
S195-00



SIMS (BODENHAMMER)
15 cm // 6"
S195-10



CZERNY
22 cm // 8 3/4"
S196-22



SIMS
22 cm // 8 3/4"

Valvenlänge Length of Blades	
50 mm	S198-06
80 mm	S198-08
125 mm	S198-12
150 mm	S198-15



MATHIEU
19,5 cm // 7 3/4"
S199-19



BARR
17 cm // 6 3/4"
S201-17

Anal spreizer
Anal Retractors

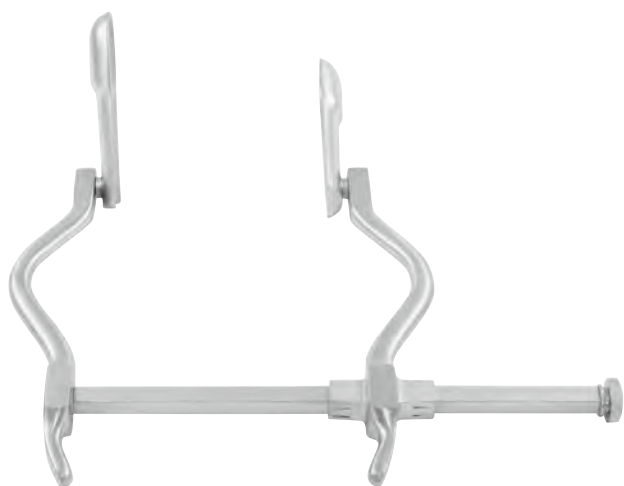

SMITH-BUIE
15 cm // 6"
S203-00



PARK

Komplett <i>Complete</i>	S205-00
Sperrer allein <i>Retractor only</i>	S205-10
Mittelblatt allein <i>Center blade only</i>	S205-21
Blätter allein, 75 mm <i>Blades only, 75 mm</i>	S205-22
Blätter allein, 95 mm <i>Blades only, 95 mm</i>	S205-23



BENSAUDE

21 x 50 mm	S207-01
27 x 50 mm	S207-02



IVES-FANSLER
22 mm
S210-00



IVES-FANSLER
Mit Fiberoptik
With Fiberoptic
S210-00F

Proktoskope Proctoscopes



HIRSCHMANN

16 x 65 mm	S211-01
19 x 65 mm	S211-02
22 x 65 mm	S211-03
25 x 65 mm	S211-04



KELLY

22 x 50 mm	S212-01
22 x 100 mm	S212-02
22 x 149 mm	S212-03
22 x 200 mm	S212-04

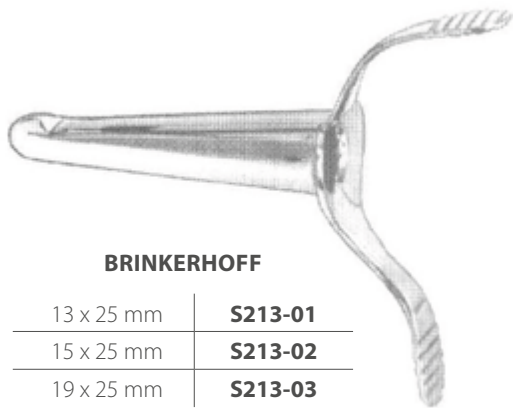

BRINKERHOFF

13 x 25 mm	S213-01
15 x 25 mm	S213-02
19 x 25 mm	S213-03

Mit Lichtstabaufnahme
With sleeve for FO



MORGAN

	Durchmesser Diameter	Länge Length
S214-01	10 mm	65 mm
S214-02	17 mm	65 mm
S214-03	17 mm	80 mm
S214-04	20 mm	65 mm
S214-01	20 mm	80 mm
S214-02	20 mm	150 mm
S214-03	24 mm	65 mm
S214-04	24 mm	80 mm
S214-04	30 mm	80 mm



Lichtstab für Morgan Proktoskope

S214-90

Proktoskope
Proctoscopes



KELLY

20 x 25 mm	S215-01
25 x 30 mm	S215-02

Operations-Proktoskop
Surgery Proctoscope



CHELSEA-EATON

22 mm	S216-01
30 mm	S216-02

Operations-Proktoskop mit Lichtstabaufnahme
Surgery Proctoscope with sleeve for F/O handle



FANSLER

Lichtstab allein
Sleeve only

S217-90

25 mm	S217-25
29 mm	S217-29
35 mm	S217-35
38 mm	S217-38

Rektoskope Rectoscopes

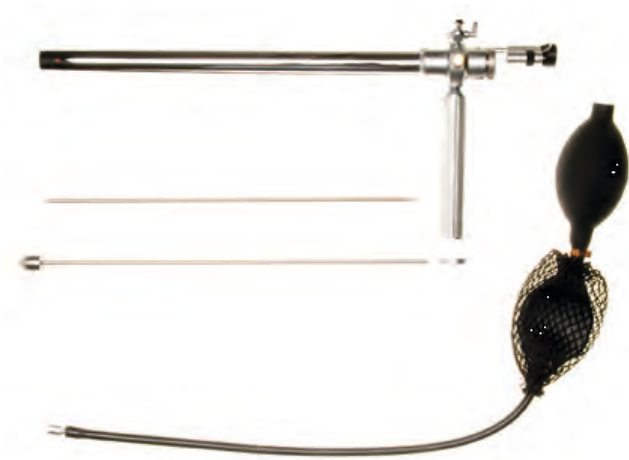

Kaltlicht-Rektoskop: Rektoskopkopf mit Zweiwegehahn, Anschluss Wolf, Verschlussdeckel und Teleskop-Optik; Griff; Tubus 20 x 300 mm, mit Mandrin und F/O-Lichtträger; Doppelgebläse.

Fibre optic Rectoscope: Rectoscope head with two-way stop cock, cover and telescope; handle; tube 20 x 300 mm, with obturator and f/o-light pipe; Double blower.

S218-01

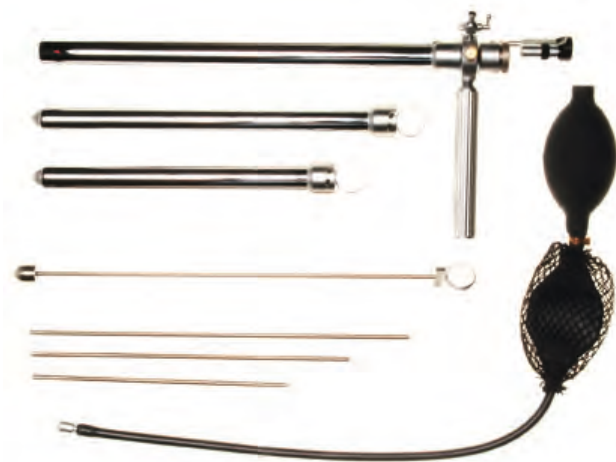

Kaltlicht-Rektoskop nach Strauß: Rektoskopkopf mit Zweiwegehahn, Anschluss Wolf, Verschlussdeckel und Teleskop-Optik; Griff; je ein Rektoskop-Tubus in 200 mm, 250 mm und 300 mm, ø 20 mm, mit Mandrin und F/O-Lichtträger; Doppelgebläse.

F/O-Rectoscope by Strauß: Rectoscope-head with two-way stop cock, connection type Wolf, cover and telescope; handle; 3 Rectoscope tubes, ø 20 mm, each with obturator and f/o-light pipe; Double blower.

S218-11

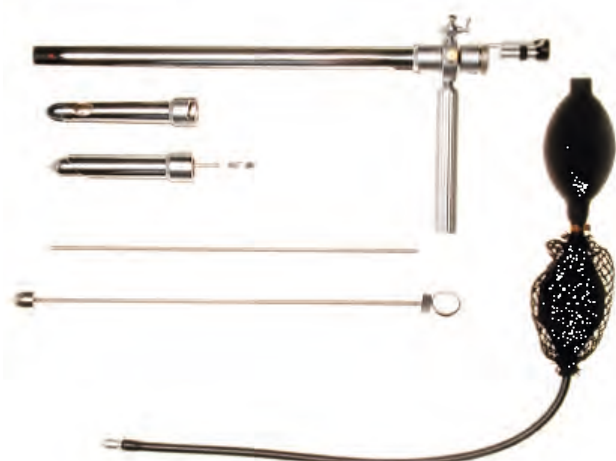

Kaltlicht-Rekto-Proktoskopset: Rektoskopkopf mit Zweiwegehahn, Anschluss Wolf, Verschlussdeckel und Schwenklupe; Griff; Rektoskoptubus 20 x 250 mm, mit Mandrin und F/O-Lichtträger; Anuskoptubus, 80 mm, mit Mandrin; Proktoskoptubus mit Seitenfenster; kurzer F/O-Lichtträger; Doppelgebläse.

Recto-Proctoscope with F/O-Illumination, F/O-Rectoscope-head with two-way stop cock, connection type Wolf, cover and swivel lens; handle; Rectoscope tube 20x250 mm, with obturator; f/o-light pipe; Anoscope, 80 mm, with obturator; Proctoscope tube with lateral fenestra; short f/o light pipe; Double blower.

S218-21

Mastdarm-Biopsiezangen
Rectal Biopsy Forceps



YEOMAN

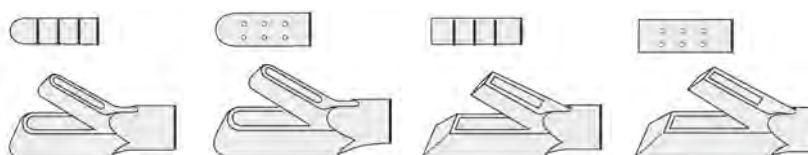

	Fig. 1	Fig. 2	Fig. 3	Fig. 4
28 cm // 11"	S220-128	S220-228	S220-328	S220-428
35 cm // 13 3/4"	S220-135	S220-235	S220-335	S220-435
42 cm // 16 1/2"	S220-142	S220-242	S220-342	S220-442



Griff allein
Handle only

S222-51

YEOMAN

	Länge Schaft Length of shaft	Zange komplett Complete	Aufsatz allein Tips only
	33 cm // 13"	S222-01	S222-51
	40 cm // 16"	S222-11	S222-61
	33 cm // 13"	S222-02	S222-52
	40 cm // 16"	S222-12	S222-62
	33 cm // 13"	S222-03	S222-53
	40 cm // 16"	S222-13	S222-63
	33 cm // 13"	S222-04	S222-54
	40 cm // 16"	S222-14	S222-64

Rektalinstrumente Rectal Instruments

Rektalschnürer
Rectal snare

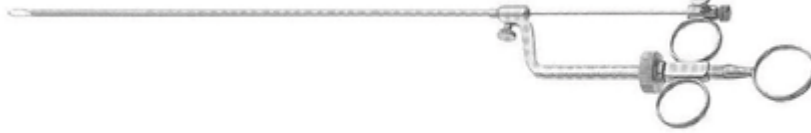

NORWOOD
30 cm // 12"
S230-30

Absaugrohr
Suction tube



BUIE
40 cm // 15 3/4"
S234-40

Diverse Sonden Various Probes



LARRY
15 cm // 6"
S236-15



BARR
14 cm // 5 1/2"
S237-14



STEWART
22 cm // 8 1/2"
S238-22



PRATT
19,5 cm // 7 1/2"
S240-19

Haemorrhoidalzangen
Haemorrhoidal Forceps

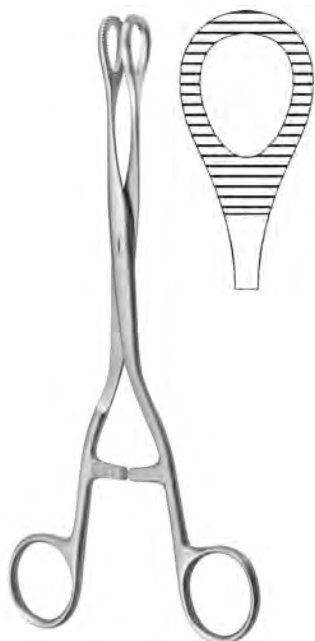

HEYWOOD-SMITH
25 cm // 10"
S249-25



HEYWOOD-SMITH
21 cm // 8 1/4"
S250-21



HEYWOOD-SMITH
21 cm // 8 1/4"
S251-21

Haemorrhoidal-Ligatoren
Haemorrhoidal Ligators



Konus allein
Cone only
S255-51

MCGIVNEY

Kplt. mit Konus
Cplt. with Cone

S255-00

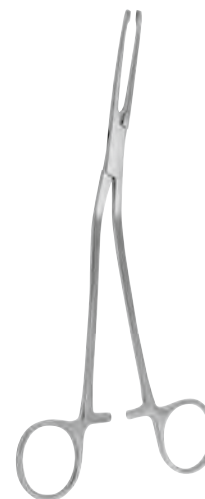

MCGIVNEY
19 cm // 7 1/2"
S255-19

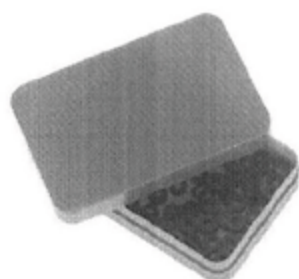

Ligator-Gummiringe 100 St.
Ligatur Rings 100 pcs.

S255-09

Haemorrhoidal-Ligatoren Haemorrhoidal Ligators

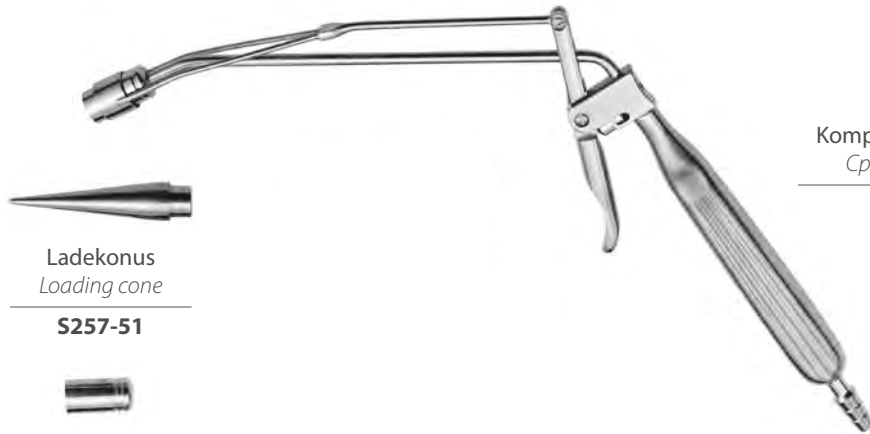

Komplett mit S257-51, S57-11, S257-16
Cplt. with S257-11, S257-11, S257-16

S257-00

MCGIVNEY



Ladekonus
Loading cone

S257-51



Saugkopf allein
Suction head only

11 x 10 mm | **S257-11**

16 x 10 mm | **S257-16**



Kplt. mit Konus
Cplt. with Cone

S258-00

FORD-DIXON



Kplt. mit Konus
Cplt. with Cone

S259-00

RUDD



Aufsatz allein
Cone only
12 mm

S259-51

Nierenstielklemmen
Kidney Clamp forceps



GUYON

20 cm // 8"
22 cm // 8 3/4"
24 cm // 9 1/2"

GUYON GUYON-ATRAUMA

S400-20	-
S400-22	S400-22U
S400-24	S400-24U

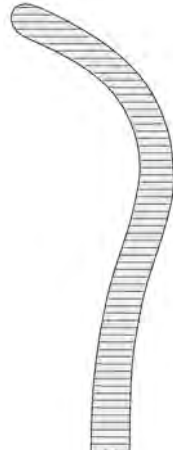

GUYON
23 cm // 9"

S402-23



HERRICK
23 cm // 9"
S403-23



MAYO-GUYON
23 cm // 9"
S405-23



STILLE
23 cm // 9"
S407-23

Nierenstielklemmen
Kidney Clamp forceps



RANDALL



Fig. 1

S415-01

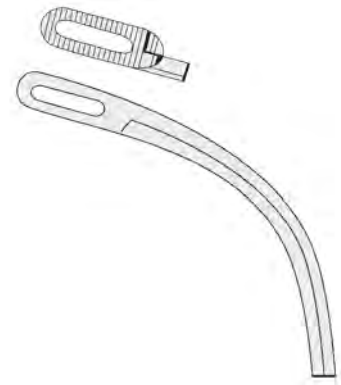

Fig. 2

S415-02

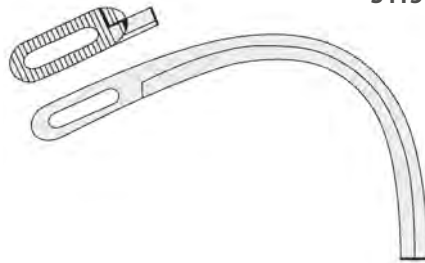

Fig. 3

S415-03

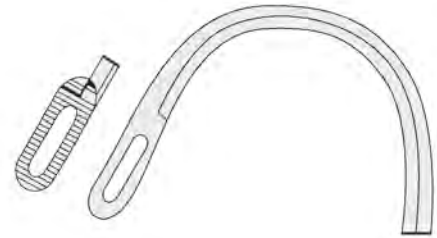

Fig. 4

S415-04



DESJARDINS

21 cm // 8 ¼"

S424-21



GRAY

22 cm // 8 ¾"

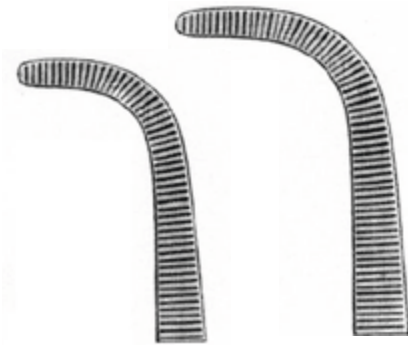

Fig. 1

S427-01

Fig. 2

S427-02

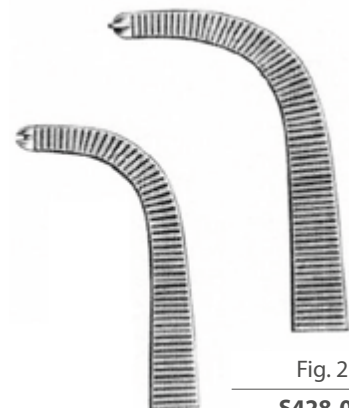

Fig. 2

S428-02

Fig. 1

S428-01

Gallensteinzangen
Gall Stone Forceps

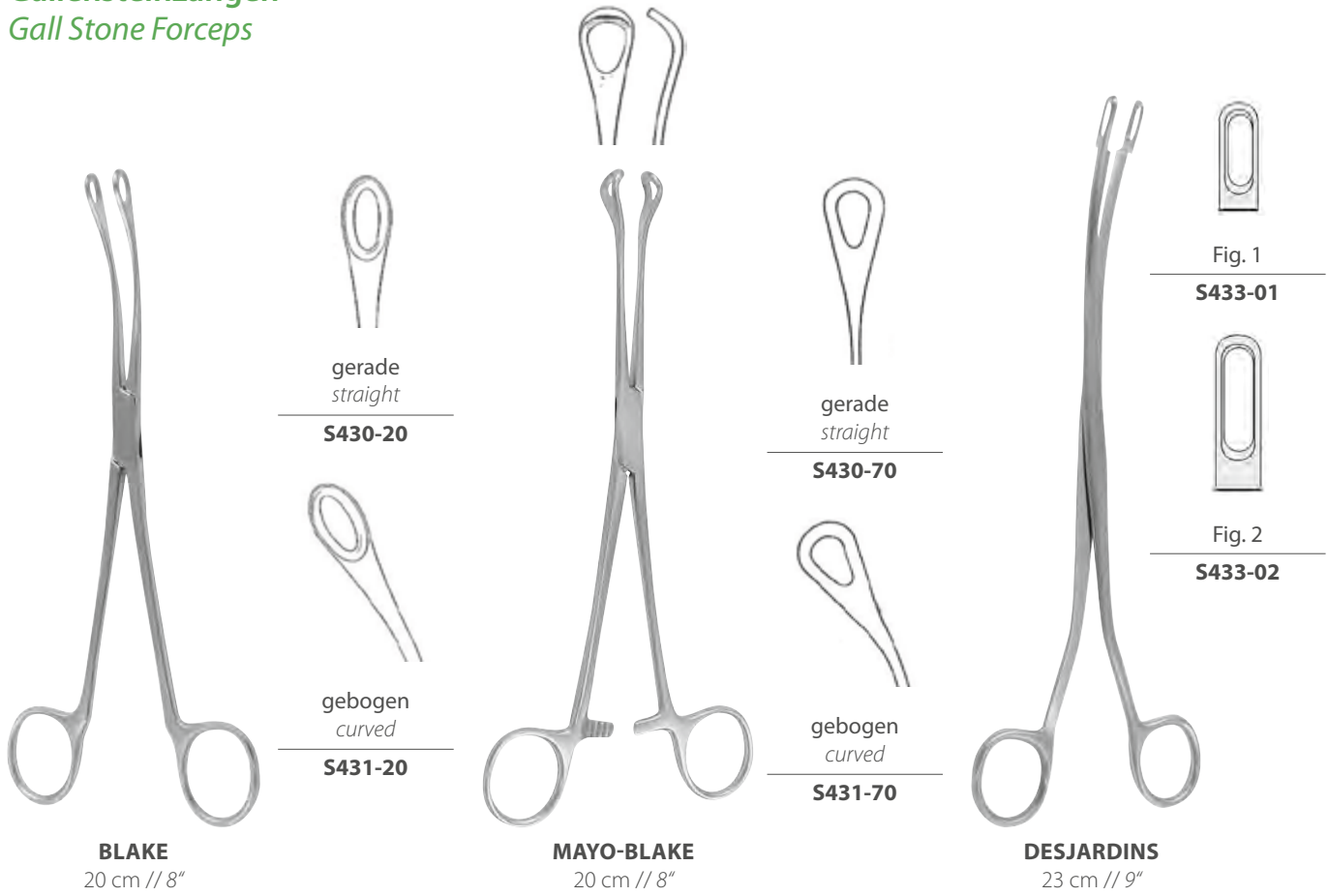

BLAKE
20 cm // 8"

MAYO-BLAKE
20 cm // 8"

DESJARDINS
23 cm // 9"



CZERNY
24,5 cm // 9 3/4"
S438-24



BAKES

Gallengangdilatoren
Bile duct dilators

1 mm	S440-01
2 mm	S440-02
3 mm	S440-03
4 mm	S440-04
5 mm	S440-05
6 mm	S440-06
7 mm	S440-07
8 mm	S440-08
9 mm	S440-09
10 mm	S440-10
11 mm	S440-11
12 mm	S440-12
13 mm	S440-13

Satz S440-03 - S440-11
Set S440-03 - S440-11

S440-30

Satz in Leinentuchtasche
S440-03 - S440-11
Set in Canvas pocket
S440-03 - S440-11

S440-90

Gallensteinlöffel Gall Stone Scoops



2,5 mm	S444-02
3,2 mm	S444-03
4,2 mm	S444-04
5,5 mm	S444-05
6,7 mm	S444-06
8,0 mm	S444-08
11,0 mm	S444-11
15,0 mm	S444-15

LUER-KÖRTE
32 cm // 12 ½"



Fig. 1
S446-01



Fig. 2
S446-02



Fig. 3
S446-03



Fig. 4
S446-04

DESJARDINS
30 cm // 12"



Fig. 1	S449-01
Fig. 2	S449-02
Fig. 3	S449-03

FERGUSSON
24 cm // 9 ½"



MOORE
28 cm // 11"
S455-28

Prostatahaken
Prostatic Retractors



Kapselzangen
Capsula forceps

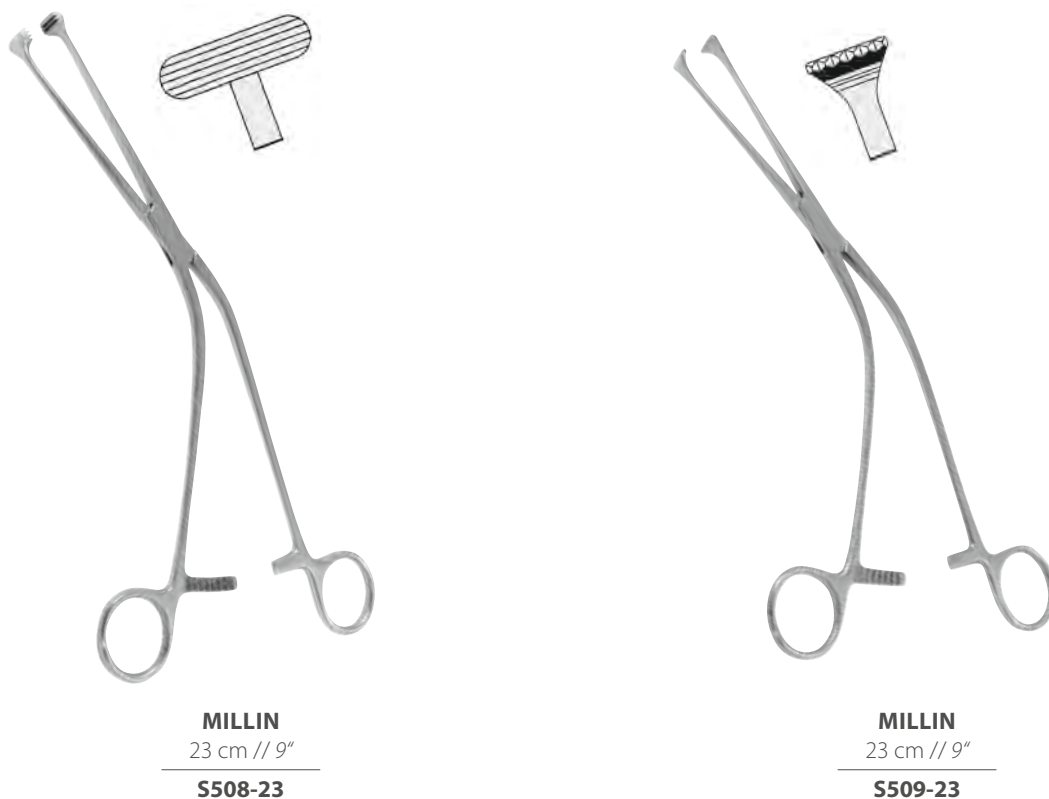

Blasenwundspreizer Bladder Retractors



MILLIN
28,5 cm // 11 1/4"
S510-00



MILLIN
Mit 2. Paar Valven
With 2 pairs valves
S512-00



LEGUEU
S514-00

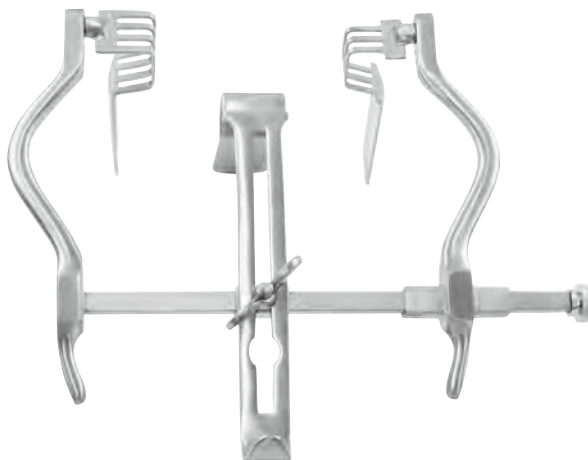

JUDD-MASSON
S518-00



JUDD-MASSON
Ohne Mittelvalve
Without Center blade
S516-00



LEGUEU
27 cm // 10 1/2"
S520-00

Dilatationsbougies
Dilating Bougies

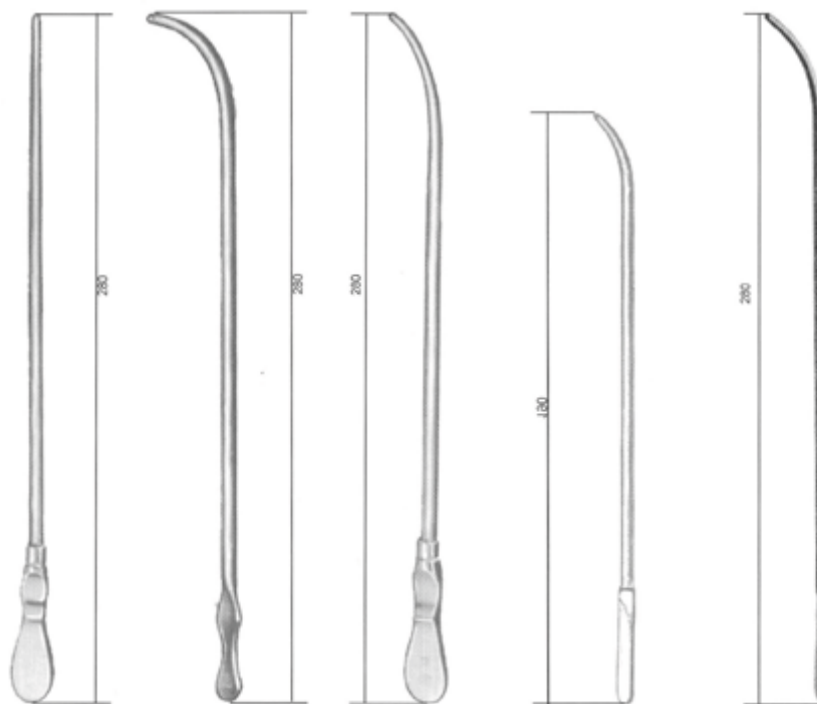

Charr.	DITTEL	VAN BUREN	DITTEL	MCCREA	OTIS
	28 cm // 11"	28 cm // 11"	28 cm // 11"	24 cm // 9 1/2"	28 cm // 11"
6	S530-06	S532-06	S534-06	S536-06	-
8	S530-08	S532-08	S534-08	S536-08	-
10	S530-10	S532-10	S534-10	S536-10	-
12	S530-12	S532-12	S534-12	S536-12	S538-12
14	S530-14	S532-14	S534-14	S536-14	S538-14
16	S530-16	S532-16	S534-16	S536-16	S538-16
18	S530-18	S532-18	S534-18	S536-18	S538-18
20	S530-20	S532-20	S534-20	S536-20	S538-20
22	S530-22	S532-22	S534-22	S536-22	S538-22
24	S530-24	S532-24	S534-24	S536-24	S538-24
26	S530-26	S532-26	S534-26	S536-26	S538-26
28	S530-28	S532-28	S534-28	S536-28	S538-28
30	S530-30	S532-30	S534-30	S536-30	-
32	-	S532-32	S534-32	S536-32	-
34	-	S532-34	S534-34	S536-34	-
36	-	S532-36	S534-36	S536-36	-
38	-	S532-38	-	-	-
40	-	S532-40	-	-	-

Dilationsbougies Dilating Bougies



Charr.	WALTHER	CAMPBELL	WALTHER
	28 cm // 11"	28 cm // 11"	
6	-	S542-06	-
8	-	S542-08	-
10	-	S542-10	-
12	-	S542-12	S550-12
14	-	S542-14	S550-14
16	S540-16	S542-16	S550-16
18	S540-18	S542-18	S550-18
20	S540-20	S542-20	S550-20
22	S540-22	S542-22	S550-22
24	S540-24	-	S550-24
26	S540-26	-	S550-26
28	S540-28	-	S550-28
30	S540-30	-	S550-30
32	S540-32	-	S550-32
34	S540-34	-	S550-34
36	S540-36	-	S550-36
38	-	-	S550-38

Charr.	GUYON
	27 cm // 10 1/2"
12	S544-12
13	S544-13
14	S544-14
15	S544-15
16	S544-16
17	S544-17
18	S544-18
19	S544-19
20	S544-20
21	S544-21
22	S544-22
23	S544-23
24	S544-24
25	S544-25
26	S544-26
27	S544-27
28	S544-28
29	S544-29
30	S544-30

Katheter
Catheters

Metallkatheter
Metal Catheters

Katheter-Einführungsinstrumente
Catheter introducing instruments

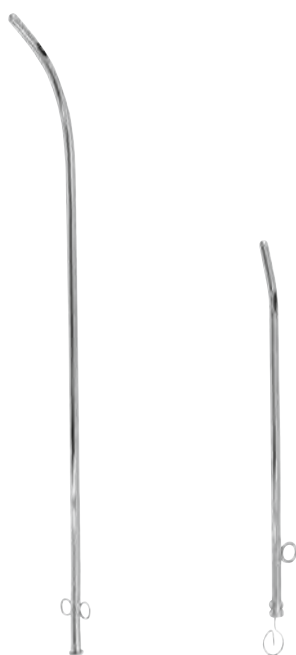

	Für Männer <i>For men</i>	Für Frauen <i>For woman</i>
Charr.	25 cm // 10"	15,5 cm // 6"
	-	S562-06
8	S561-08	S562-08
10	S561-10	S562-10
12	S561-12	S562-12
14	S561-14	S562-14
	-	S562-16
	-	S562-18
	-	S562-20



39 cm // 15 1/2"
S570-39



35 cm // 13 3/4"
S571-35

Vasektomieklammen
Vasectomy Forceps



14,5 cm // 5 1/2"

S574-01



14,5 cm // 5 1/2"

S574-02

Circumcisionsgeräte
Circumcision instruments



8 mm	S575-08
11 mm	S575-11
13 mm	S575-13
16 mm	S575-16
21 mm	S575-21
26 mm	S575-26
32 mm	S575-32

Fremdkörperzange
Foreign body forceps



MATHIEU

S578-00

Penisklemmen
Penis clamps



STOCKMANN
S580-00



STRAUSS
S582-00

Urethrotom
Urethrotome



OTIS
Komplett in Holzetui
Complete in wooden case
S585-00



Ersatzmesser
Spare knife
S585-11

Gynäkologie

// Gynecology

Inhalt

Index

Abschnitt **T**
// Section

Scheidenspekula <i>Vaginal Specula</i>	T02 - T14
Uterusdilatoren, Uterussonden <i>Uterine Dilators, Uterine Probes</i>	T15 - T20
Hakenzangen, Uterusfazzangen <i>Tenaculum Forceps, Uterine Forceps</i>	T21 - T25
Fistelhaken <i>Hooks</i>	T26
Biopsieküretten, Biopsiezangen <i>Biopsy Curettes, Biopsy Forceps</i>	T27 - T31
Uteruslöffel, Uterusküretten <i>Uterine Curettes, Uterine Curettes</i>	T33 - T37
Salpinograph, Aminoskopie <i>Salpinograph, Aminoscopy</i>	T38
Uterusmanipulatoren <i>Uterus Manipulators</i>	T39
Beckenzirkel <i>Pelvimeters</i>	T40
Abortuszangen <i>Ovum Forceps</i>	T41
Geburtshilfe <i>Obstetrics</i>	T42 - T45

Scheidenspekula
Vaginal Specula

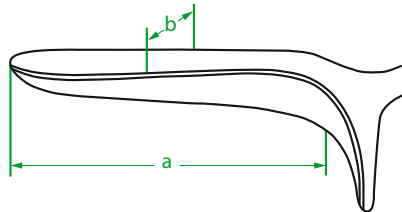

Für Jungfrauen
For virgins

CUSCO

a	b	
75 mm	17 mm	T100-00



CUSCO
Standard // Standard

a	b		
75 mm	32 mm	Fig. 1	T100-01
85 mm	35 mm	Fig. 2	T100-02
100 mm	37 mm	Fig. 3	T100-03

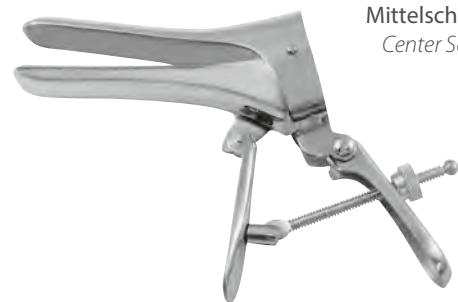

Mittelschraube
Center Screw

CUSCO

a	b		
75 mm	17 mm	Fig. 0	T101-00
75 mm	32 mm	Fig. 1	T101-01
85 mm	35 mm	Fig. 2	T101-02
100 mm	37 mm	Fig. 3	T101-03



Schweizer Modell
Swiss Pattern

CUSCO

a	b		
90 mm	23-25 mm	Fig. 1	T102-01
100 mm	25-27 mm	Fig. 2	T102-02
110 mm	27-30 mm	Fig. 3	T102-03



Flache Entenschnabelform
Flat Duck Beak

CUSCO

Fig. 1	T104-01
Fig. 2	T104-02
Fig. 3	T104-03

Scheidenspekula Vaginal Specula



GRAVE
Standard // Standard

a	b		
75 mm	20 mm	Fig. 1	T108-01
95 mm	30 mm	Fig. 2	T108-02
115 mm	35 mm	Fig. 3	T108-03
125 mm	35 mm	Fig. 5	T108-05



GRAVE-LASER

		schwarz isoliert <i>black insulated</i>	blau isoliert <i>blue insulated</i>
Fig. 1	75x20 mm	T109-01	T109-11
Fig. 2	95x30 mm	T109-02	T109-12
Fig. 3	115x35 mm	T109-03	T109-13

Abgewinkelt, rechts offen
Angled, right side open



HUFFMANN-GRAVE

a	b	
101 mm	19 mm	T110-09



KAHN-GRAVE

a	b	
101 mm	35 mm	T110-21



GRAVE

T110-23

Scheidenspekula
Vaginal Specula



PEDERSON
Standard // Standard

a	b		
		Fig. 0	T115-00
75 mm	13 mm	Fig. 1	T115-01
100 mm	22 mm	Fig. 2	T115-02
120 mm	25 mm	Fig. 3	T115-03



PEDERSON-LASER

		schwarz isoliert <i>black insulated</i>	blau isoliert <i>blue insulated</i>
Fig. 1	75 x 13 mm	T116-01	T116-11
Fig. 2	100 x 22 mm	T116-02	T116-12
Fig. 3	120 x 25 mm	T116-03	T116-13

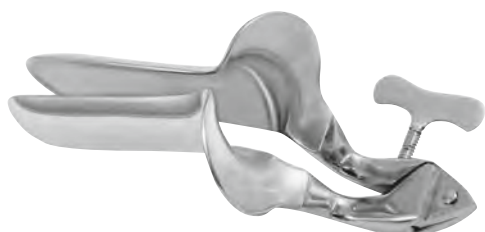

COLLIN

a	b		
60 mm	20 mm	Fig. 0	T118-00
85 mm	30 mm	Fig. 1	T118-01
100 mm	35 mm	Fig. 2	T118-02
110 mm	40 mm	Fig. 3	T118-03

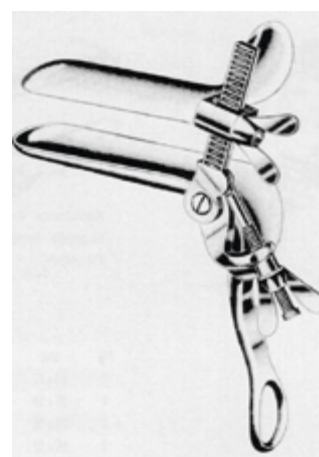

TRELAT

a	b		
85 mm	33 mm	Fig. 1	T123-01
95 mm	35 mm	Fig. 2	T123-02
115 mm	43 mm	Fig. 3	T123-03



DEVILBISS

a	b	
101 mm	32 mm	T121-02

Scheidenspekula Vaginal Specula



SEMM

a	b		
90 mm	14/18 mm	Fig. 1	T125-01
100 mm	17/20 mm	Fig. 2	T125-02
100 mm	25/30 mm	Fig. 3	T125-03



SEYFFERT

a	b	
100 mm	17 mm	T126-01
110 mm	33 mm	T126-02

Lateral Spekula Lateral Specula



	Standard <i>Standard</i>	schwarz <i>black</i>	blau isoliert <i>blue insulated</i>
60 x 22 mm	T128-01	T128-11	T128-21
72 x 22 mm	T128-02	T128-12	T128-22

	Standard <i>Standard</i>	schwarz <i>black</i>	blau isoliert <i>blue insulated</i>
60 x 22 mm	T129-01	T129-11	T129-21
72 x 22 mm	T129-02	T129-12	T129-22

Scheidenspekula
Vaginal Specula



SIMS

a	b		
		Satz // Set	T130-00
60 mm	25 + 30 mm	Fig. 1	T130-01
70 mm	30 + 35 mm	Fig. 2	T130-02
80 mm	35 + 40 mm	Fig. 3	T130-03



SIMS (US-MODELL)

76 x 25 mm, 64 x 22 mm	Fig. 1	T130-31
76 x 32 mm, 64 x 25 mm	Fig. 2	T130-32
83 x 32 mm, 76 x 25 mm	Fig. 3	T130-33
83 x 38 mm, 76 x 32 mm	Fig. 4	T130-34
102 x 38 mm, 83 x 32 mm	Fig. 5	T130-35
102 x 44 mm, 83 x 38 mm	Fig. 6	T130-36



SIMS



SIMS



SIMS-KELLY



SIMS

a	b		SIMS	SIMS	SIMS-KELLY
57 mm	25 mm	Fig. 1	T131-01	T131-11	T131-21
70 mm	32 mm	Fig. 2	T131-02	T131-12	T131-22
89 mm	38 mm	Fig. 3	T131-03	T131-13	T131-23

a	b		
63 mm	32 mm	Fig. 1	T132-01
76 mm	32 mm	Fig. 2	T132-02
89 mm	38 mm	Fig. 3	T132-03

Scheidenspekula Vaginal Specula

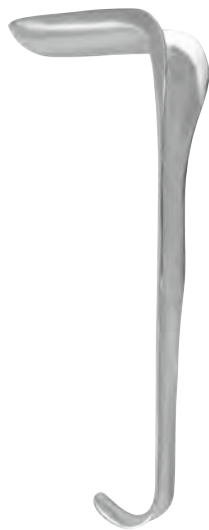

JACKSON

a	b=35 mm	b=38 mm
75 mm	T134-01	T134-11
89 mm	T134-02	T134-12
101 mm	T134-03	T134-13



EASTMAN

a	b		
76 mm	38 mm	Fig. 1	T135-01
89 mm	38 mm	Fig. 2	T135-02
101 mm	38 mm	Fig. 3	T135-03



SEIDL

a	b		
80 mm	8 mm	Fig. 1	T136-01
80 mm	10 mm	Fig. 2	T136-02
90 mm	14 mm	Fig. 3	T136-03



KRISTELLER

a	b		Satz Set	Spekula allein Specula only	Halter allein Retractor only
70 mm	15 mm	Fig. 0	T140-00	T140-10	T140-20
70 mm	27 mm	Fig. 1	T140-01	T140-11	T140-21
75 mm	30 mm	Fig. 2	T140-02	T140-12	T140-22
90 mm	36 mm	Fig. 3	T140-03	T140-13	T140-23



Scheidenspekula
Vaginal Specula

Konisch für Jungfrauen
Conical blades for virgins

a	b		Satz Set	Spekula allein Specula only	Halter allein Retractor only
110 mm	18 mm	Fig. 00	T142-01	T142-11	T142-21
110 mm	21 mm	Fig. 00	T142-02	T142-12	T142-22



KRISTELLER



KRISTELLER

a	b		Satz Set	Spekula allein Specula only	Halter allein Retractor only
110 mm	27 mm	Fig. 1	T144-01	T144-11	T144-21
110 mm	30 mm	Fig. 2	T144-02	T144-12	T144-22
110 mm	36 mm	Fig. 3	T144-03	T144-13	T144-23

Flach
Flat hollow



a	b		Satz Set	Spekula allein Specula only	Halter allein Retractor only
110 mm	27 mm	Fig. 1	T146-01	T146-11	T146-21
110 mm	30 mm	Fig. 2	T146-02	T146-12	T146-22
110 mm	36 mm	Fig. 3	T146-03	T146-13	T146-23



KRISTELLER

Scheidenspekula Vaginal Specula



WIENER MODELL

	Satz Set	Spekula allein Specula only	Halter allein Retractor only
Fig. 1	T147-01	T147-11	T147-21
Fig. 2	T147-02	T147-12	T147-22
Fig. 3	T144-03	T147-13	T147-23



KALLMORGEN

a	b		Satz Set	Spekula allein Specula only	Halter allein Retractor only
70 mm	40 mm	Fig. 1	T152-01	T152-11	T152-21
90 mm	40 mm	Fig. 2	T152-02	T152-12	T152-22

Scheidenspekula
Vaginal Specula



MATZENAUER

a	b	
100 mm	20 mm	T153-01
100 mm	25 mm	T153-02
100 mm	30 mm	T153-03
100 mm	35 mm	T153-04
100 mm	40 mm	T153-05
130 mm	20 mm	T153-11
130 mm	25 mm	T153-12
130 mm	30 mm	T153-13
130 mm	35 mm	T153-14
130 mm	40 mm	T153-15



BRAUN
56x13 mm
T155-01



BRAUN
60x10 mm
T155-02

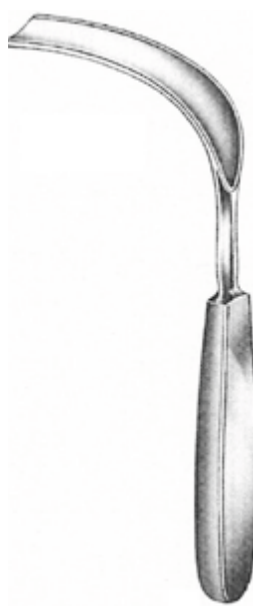

ULRICH
80x20 mm
T155-11



ULRICH
85x17 mm
T155-12

Scheidenspekula Vaginal Specula

	Satz Set	Spekula allein Specula only	Halter allein Retractor only
Fig. 1	T160-01	T160-11	T160-21
Fig. 2	T160-02	T160-12	T160-22





MATHIEU



DOYEN

a	b		
60 mm	45 mm	Fig. 1	T169-01
90 mm	45 mm	Fig. 2	T169-02
112 mm	45 mm	Fig. 3	T169-03

a	b		 	
			leicht hohl <i>slightly concave</i>	halb hohl <i>medium concave</i>
			24 cm // 9 1/2"	24 cm // 9 1/2"
60 mm	35 mm	Fig. 1	T170-01	T171-01
90 mm	35 mm	Fig. 2	T170-02	T171-02
120 mm	35 mm	Fig. 3	T170-03	T171-03
60 mm	45 mm	Fig. 1	T170-11	T171-11
90 mm	45 mm	Fig. 2	T170-12	T171-12
120 mm	45 mm	Fig. 3	T170-13	T171-13
160 mm	45 mm	Fig. 4	T170-14	-
180 mm	45 mm	Fig. 5	T170-15	-
60 mm	60 mm	Fig. 1	T170-21	T171-21
90 mm	60 mm	Fig. 2	T170-22	T171-22
120 mm	60 mm	Fig. 3	T170-23	T171-23
160 mm	60 mm	Fig. 4	T170-24	-
180 mm	60 mm	Fig. 5	T170-25	-



DOYEN

Scheidenspekula
Vaginal Specula



DOYEN
25 cm // 10"

a	b		
60 mm	30 mm	Fig. 1	T174-01
70 mm	30 mm	Fig. 2	T174-02
80 mm	30 mm	Fig. 3	T174-03



Mit abnehmbarem Gewicht
With removable weight

AUVARD

a	b		
80 mm	38 mm	Fig. 1	T181-01
105 mm	42 mm	Fig. 2	T181-02



Mit festem Gewicht
With fixed weight

AUVARD

a	b		
70 mm	38 mm	Fig. 1	T182-01
83 mm	42 mm	Fig. 2	T182-02
102 mm	45 mm	Fig. 3	T182-03



DELEE
23,5 cm // 9"
T183-01

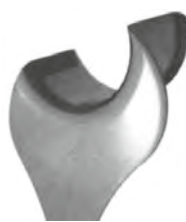

links
left

T183-02



rechts
right

T183-03



STEINER-AUVARD
23 cm // 9"
T184-00

Scheidenspekula Vaginal Specula



BREISKY

a	b	
70 x 22 mm	76 x 25 mm	T184-01
76 x 25 mm	82 x 30 mm	T184-02
82 x 30 mm	95 x 38 mm	T184-03
95 x 38 mm	102 x 44 mm	T184-04



BREISKY

a	b		a	b	
90 mm	20 mm	T185-01	130 mm	20 mm	T185-41
90 mm	25 mm	T185-02	130 mm	25 mm	T185-42
90 mm	30 mm	T185-03	130 mm	30 mm	T185-43
90 mm	35 mm	T185-04	130 mm	35 mm	T185-44
90 mm	40 mm	T185-05	130 mm	40 mm	T185-45
100 mm	20 mm	T185-11	160 mm	20 mm	T185-51
100 mm	25 mm	T185-12	160 mm	25 mm	T185-52
100 mm	30 mm	T185-13	160 mm	30 mm	T185-53
100 mm	35 mm	T185-14	160 mm	35 mm	T185-54
100 mm	40 mm	T185-15	160 mm	40 mm	T185-55
110 mm	20 mm	T185-21	180 mm	20 mm	T185-61
110 mm	25 mm	T185-22	180 mm	25 mm	T185-62
110 mm	30 mm	T185-23	180 mm	30 mm	T185-63
110 mm	35 mm	T185-24	180 mm	35 mm	T185-64
110 mm	40 mm	T185-25	180 mm	40 mm	T185-65
120 mm	20 mm	T185-31	220 mm	20 mm	T185-71
120 mm	25 mm	T185-32	220 mm	25 mm	T185-72
120 mm	30 mm	T185-33	220 mm	30 mm	T185-73
120 mm	35 mm	T185-34			
120 mm	40 mm	T185-35			



LANDAU

a	b	
100 mm	28 mm	T187-01
100 mm	38 mm	T187-02



SCHERBAK

Griff allein
Handle only

T190-10

	Gewicht Weight
400 g	T190-11
800 g	T190-12

Komplett
Complete

T190-00



80 x 30 mm

T190-01



85 x 35 mm

T190-02



90 x 40 mm

T190-03



55 x 40/60 mm

T190-04



70 x 45/70 mm

T190-05

Scheidenspekula
Vaginal Specula

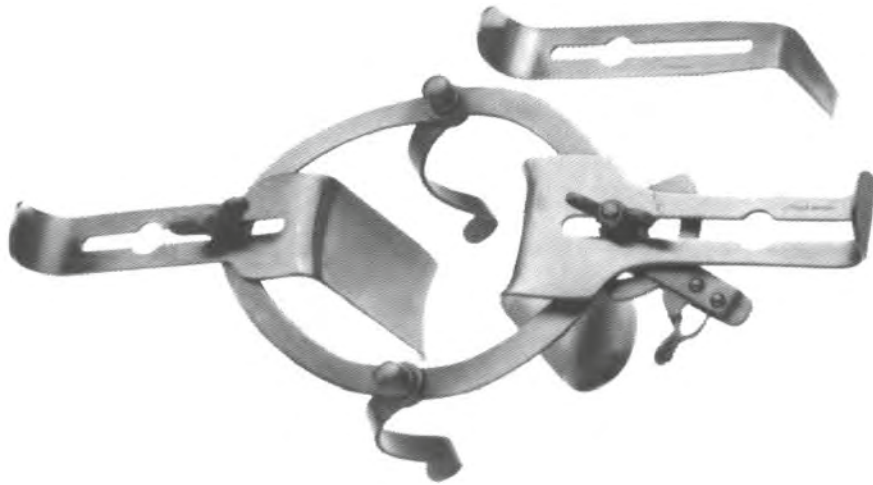

O'SULLIVAN-O'CONNER

	Komplett <i>Complete</i>	Valve <i>Valve</i>	Rahmen allein <i>Frame only</i>
	T192-00	-	-
44 x 15 mm	-	T192-01	-
85 x 39 mm	-	T192-02	-
86 x 45 mm	-	T192-03	-
			T192-10



SMITH

	Komplett <i>Complete</i>	Valve <i>Valve</i>
	T195-00	-
45x100 mm	-	T195-10

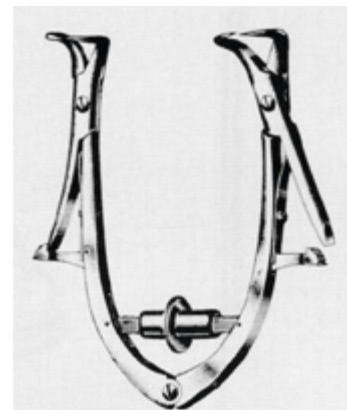

FRIEDMANN

T197-10

Uterusdilatoren Uterine Dilators



HEGAR

Satz mit 14 Dilatoren
Set with 14 Dilators
4-17 mm

T200-51

Satz mit 26 Dilatoren
Set with 26 Dilators
1-26 mm

T200-52

1 mm	T200-01
2 mm	T200-02
3 mm	T200-03
4 mm	T200-04
5 mm	T200-05
6 mm	T200-06
7 mm	T200-07
8 mm	T200-08
9 mm	T200-09
10 mm	T200-10
11 mm	T200-11
12 mm	T200-12
13 mm	T200-13
14 mm	T200-14
15 mm	T200-15
16 mm	T200-16
17 mm	T200-17
18 mm	T200-18
19 mm	T200-19

20 mm	T200-20
21 mm	T200-21
22 mm	T200-22
23 mm	T200-23
24 mm	T200-24
25 mm	T200-25
26 mm	T200-26
27 mm	T200-27
28 mm	T200-28
29 mm	T200-29
30 mm	T200-30

1,5 mm	T201-01
2,5 mm	T201-02
3,5 mm	T201-03
4,5 mm	T201-04
5,5 mm	T201-05
6,5 mm	T201-06
7,5 mm	T201-07
8,5 mm	T201-08
9,5 mm	T201-09
10,5 mm	T201-10
11,5 mm	T201-11
12,5 mm	T201-12
13,5 mm	T201-13
14,5 mm	T201-14
15,5 mm	T201-15
16,5 mm	T201-16
17,5 mm	T201-17
18,5 mm	T201-18
19,5 mm	T201-19



Satz mit 14 Dilatoren, in Metalletui
Set with 14 Dilators, in metal case
4-17 mm

T200-61

Satz mit 26 Dilatoren, in Metalletui
Set with 26 Dilators, in metal case
1-26 mm

T200-71

Uterusdilatoren
Uterine Dilators



HEGAR

1,0/2,0 mm	T202-02
3,0/4,0 mm	T202-04
5,0/6,0 mm	T202-06
7,0/8,0 mm	T202-08
9,0/10,0 mm	T202-10
11,0/12,0 mm	T202-12
13,0/14,0 mm	T202-14
15,0/16,0 mm	T202-16
17,0/18,0 mm	T202-18
19,0/20,0 mm	T202-20
21,0/22,0 mm	T202-22
23,0/24,0 mm	T202-24
25,0/26,0 mm	T202-26

Satz mit 8 Dilatoren
Set with 8 Dilators
3 / 4 mm - 17 / 18 mm

T202-51

Satz mit 13 Dilatoren
Set with 13 Dilators
1 / 2 mm - 25 & 26 mm

T202-52

Satz mit 8 Dilatoren, in Stoff-Rolltasche
Set with 8 Dilators, in canvas roll
3 / 4 mm - 17 / 18 mm

T202-61



Satz mit 8 Dilatoren, in Metalletui
Set with 8 Dilators, in metal case
3 / 4 mm - 17 / 18 mm

T202-71



Satz mit 13 Dilatoren, in Metalletui
Set with 13 Dilators, in metal case
1 / 2 mm - 25 / 26 mm

T202-72

Uterusdilatoren Uterine Dilators



HANK

7 x 8 Charr.	T205-08
9 x 10 Charr.	T205-10
11 x 12 Charr.	T205-12
13 x 14 Charr.	T205-14
15 x 16 Charr.	T205-16
17 x 18 Charr.	T205-18
19 x 20 Charr.	T205-20
21 x 22 Charr.	T205-22
23 x 24 Charr.	T205-24
25 x 26 Charr.	T205-26
27 x 28 Charr.	T205-28
29 x 30 Charr.	T205-30

Satz mit 6 Dilatoren
Set with 6 Dilators
9x10 Charr. - 19/20 Charr.

T205-51

Satz mit 6 Dilatoren, in Stoff-Rolltasche
Set with 6 Dilators, in canvas roll
9x10 Charr. - 19/20 Charr.

T205-61



HANK / US-SCALE

9 x 10 Charr.	T206-10
11 x 12 Charr.	T206-12
13 x 14 Charr.	T206-14
15 x 16 Charr.	T206-16
17 x 18 Charr.	T206-18
19 x 20 Charr.	T206-20

Satz mit 6 Dilatoren
Set with 6 Dilators

T206-51

Satz mit 6 Dilatoren, in Stoff-Rolltasche
Set with 6 Dilators, in canvas roll

T206-61



PRATT

13 x 15 Charr.	T208-15
17 x 19 Charr.	T208-19
21 x 23 Charr.	T208-23
25 x 27 Charr.	T208-27
29 x 31 Charr.	T208-31
33 x 35 Charr.	T208-35
37 x 39 Charr.	T208-39
41 x 43 Charr.	T208-43

Satz mit 8 Dilatoren
Set with 8 Dilators

T208-51



Satz mit 8 Dilatoren, in Stoff-Rolltasche
Set with 8 Dilators, in canvas roll

T208-61

Uterusdilatoren, Endo-Spekula
Uterine Dilators, Endocervical Specula



GOODELL
34 cm // 13 1/2"
T210-33



KOGAN
24 cm // 9 1/2"
T214-01



KOGAN
24 cm // 9 1/2"
T214-02



KOGAN
28 cm // 11"

	Mit Sperre <i>With ratchet</i>
3 mm	T211-03
4 mm	T211-04
5 mm	T211-06



KOGAN
28 cm // 11"

	KOGAN
	28 cm // 11"
3 mm	T212-03
4 mm	T212-04
5 mm	T212-06



KOGAN
28 cm // 11"

	Mit Schraube <i>With screw</i>
3 mm	T213-03
4 mm	T213-04
5 mm	T213-06

Uterussonden Uterine Probes



SIMS

rostfrei <i>stainless steel</i>	T219-01
biegsam <i>malleable</i>	T219-02
	gerade <i>straight</i>
grad in cm <i>grad in cm</i>	T218-01
grad in inch <i>grad in inch</i>	T218-02



**MARTIN
(SIMPSON)**

rostfrei <i>stainless steel</i>	T221-01
biegsam <i>malleable</i>	T221-02
	gerade, biegsam <i>straight, malleable</i>
	T220-01

grad in cm



VALLEIX
29,5 cm // 12"
T223-29

Uterus-Depressoren
Uterine Depressors



BRAUN
28 cm // 11"
T226-28



SIMS
26 cm // 10¼"
T227-26

Uterusmanipulator
Uterine Manipulators

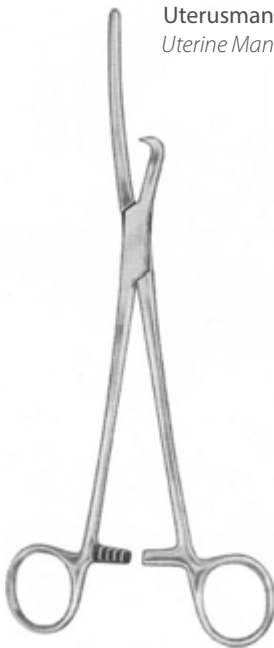

SCHACKE
23 cm // 9"
T230-23



Flex.IUD-Zange
Flex.IUD forceps
T250-00

Hakenzangen Tenaculum Forceps



STAUDE-MOORE
17 cm // 6 ¾"
T300-17



BARRETT
18 cm // 7"
T302-18



JARCHO
20 cm // 8"
T304-20



SCHRÖDER
25 cm // 10"
T310-24



BRAUN
25 cm // 10"
T311-24
T311-24N

Hakenzangen
Tenaculum Forceps



POZZI
25 cm // 10"
T312-25



DUPLAY
25 cm // 10"
T316-25



SKENE
24 cm // 9 1/2"
T317-24



BEACHAM
26 cm // 10 1/4"
T319-26



BRAUN
15,5 cm // 6"
T320-15



CZERNY
20,5 cm // 8"
T322-20



JACOBS
21 cm // 8 1/4"
gerade | **T324-21**
straight
gebogen | **T325-21**
curved

Hakenzangen Tenaculum Forceps



SCHRÖDER

	gerade <i>straight</i>	gebogen <i>curved</i>	seitw. gebogen <i>curved sideways</i>
20 cm // 8"	T326-20	T327-20	T328-20
24 cm // 9"	T326-24	T327-24	T328-24



TEALE

23 cm // 9"

T329-23

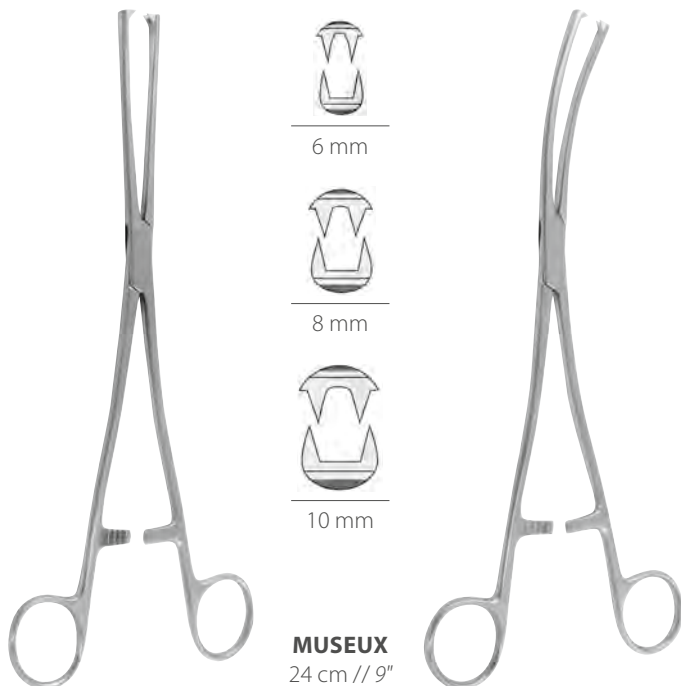

MUSEUX
24 cm // 9"

	gerade <i>straight</i>	seitw. gebogen <i>curved sideways</i>
6 mm	T330-06	T330-16
8 mm	T330-08	T330-18
10 mm	T330-10	-



MUSEUX

24 cm // 9"

	gerade <i>straight</i>	seitw. gebogen <i>curved sideways</i>
6 mm	T332-06	T332-16
8 mm	T332-08	T332-18
10 mm	T332-10	-

Hakenzangen
Tenaculum Forceps



PRATT
26 cm // 10 1/4"
T334-26



IOWA
26 cm // 10 1/4"
T336-26

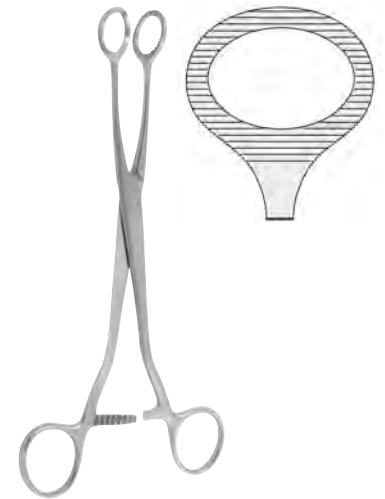

DOYEN
18 cm // 7" | T344-18
20 cm // 8" | T344-20



HEYWOOD-SMITH
25 cm // 10"
T348-25

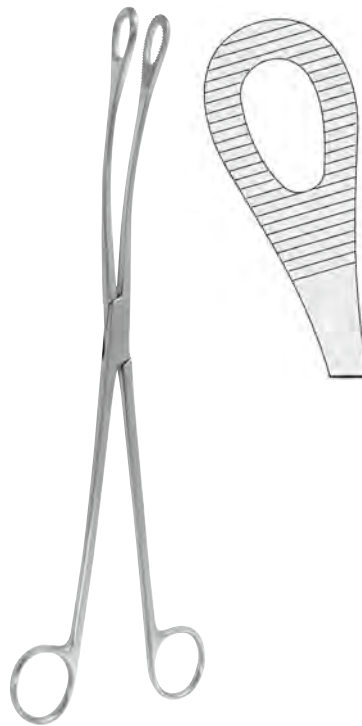

KELLY
32 cm // 12 1/2"
T350-32

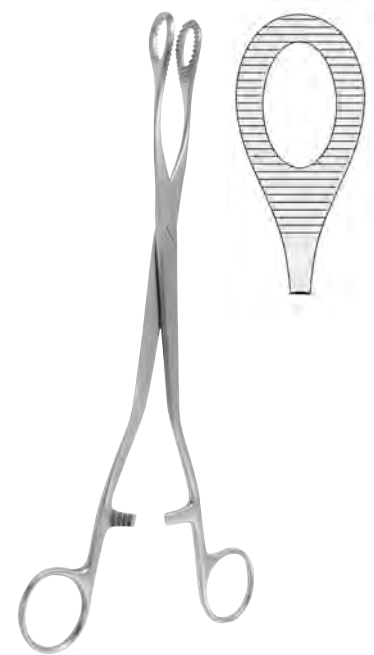

NOTO
27 cm // 10 1/2"
T354-27

Uterusfazzangen
Uterine Forceps



DARTIGUES
27 cm // 10 ½"
T356-27



SOMER
23 cm // 9"
T358-23



COLLIN
25 cm // 10"
T360-25

Fistelhaken
Hooks



SIMON
22 cm // 8 3/4"
T382-01



SIMON
22 cm // 8 3/4"
T382-02



EMMET
22 cm // 8 3/4"



Fig. 1 Fig. 2 Fig. 3 Fig. 4 Fig. 5

	schwarz <i>black</i>	blau isoliert <i>blue coated</i>
Fig. 1	T384-01	T384-11
Fig. 2	T384-02	T384-12
Fig. 3	T384-03	T384-13
Fig. 4	T384-04	T384-14
Fig. 5	T384-05	T384-15



EMMET
22 cm // 8 3/4"



Fig. 1 Fig. 2 Fig. 3



Fig. 4 Fig. 5

Fig. 1	T386-01
Fig. 2	T386-02
Fig. 3	T386-03
Fig. 4	T386-04
Fig. 5	T386-05

Myomheber
Myoma Screw



DOYEN
17 cm // 6 3/4"
T390-00



DOYEN
17 cm // 6 3/4"
T391-00

Biopsieküretten Biopsy Curettes



NOVAK

1 mm	T400-01
2 mm	T400-02
3 mm	T400-03
4 mm	T400-04



RANDALL

3 mm	T402-03
4 mm	T402-04



ROKRETTA

30 cm // 12"

T410-00



KEVORKIAN
30 cm // 12"



fest
rigid

T406-01

biegsam
malleable

T406-11



fest
rigid

T406-02

biegsam
malleable

T406-12



fest
rigid

T406-03



fest
rigid

T409-01

DUNCAN

30 cm // 12"



fest
rigid

T409-02

DUNCAN

30 cm // 12"



fest
rigid

T408-01

biegsam
malleable

T408-11

TOWNSEND

30 cm // 12"

Biopsieküretten, Biopsiezangen
Biopsy Curettes, Biopsy Forceps



MOD. MÜNCHEN
27 cm // 10 1/2"

4 mm	T412-04
5 mm	T412-05



MOD. LONDON
T413-00

Uterussekretlöffel
Secretion spoon



27 cm // 10 1/2"
T418-20



GELLHORN
23 cm // 9"
T420-23



THOMS-GAYLOR
24 cm // 9 1/2"
T422-24



SCHUBERT
21 cm // 8 1/4" | **T424-21**
29 cm // 11 1/4" | **T424-29**

Biopsiezangen Biopsy Forceps



VAN DOREN
25 cm // 10"
T426-25

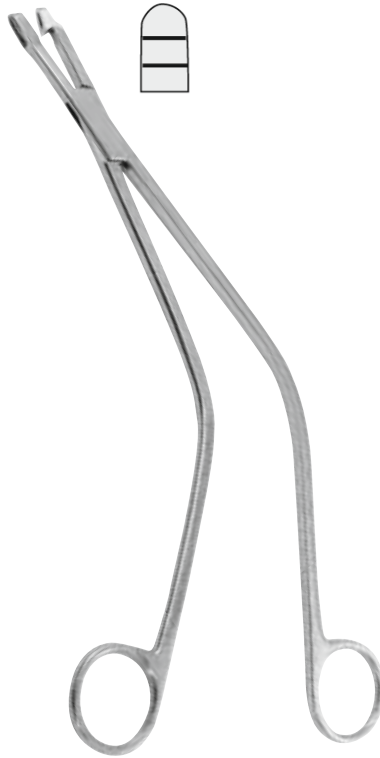

SCHUBERT
28 cm // 11"
T427-28

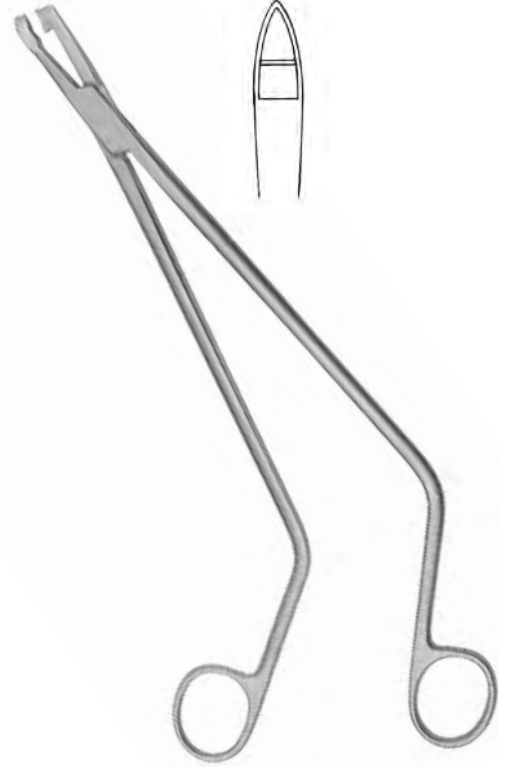

TISCHLER
27 cm // 10 1/2"
T428-27



SCHUMACHER
24 cm // 9 1/2"

Fig. 1 | **T430-01**
Fig. 2 | **T430-02**



FAURE
21 cm // 8 1/4"
T432-23

Biopsiezangen
Biopsy Forceps

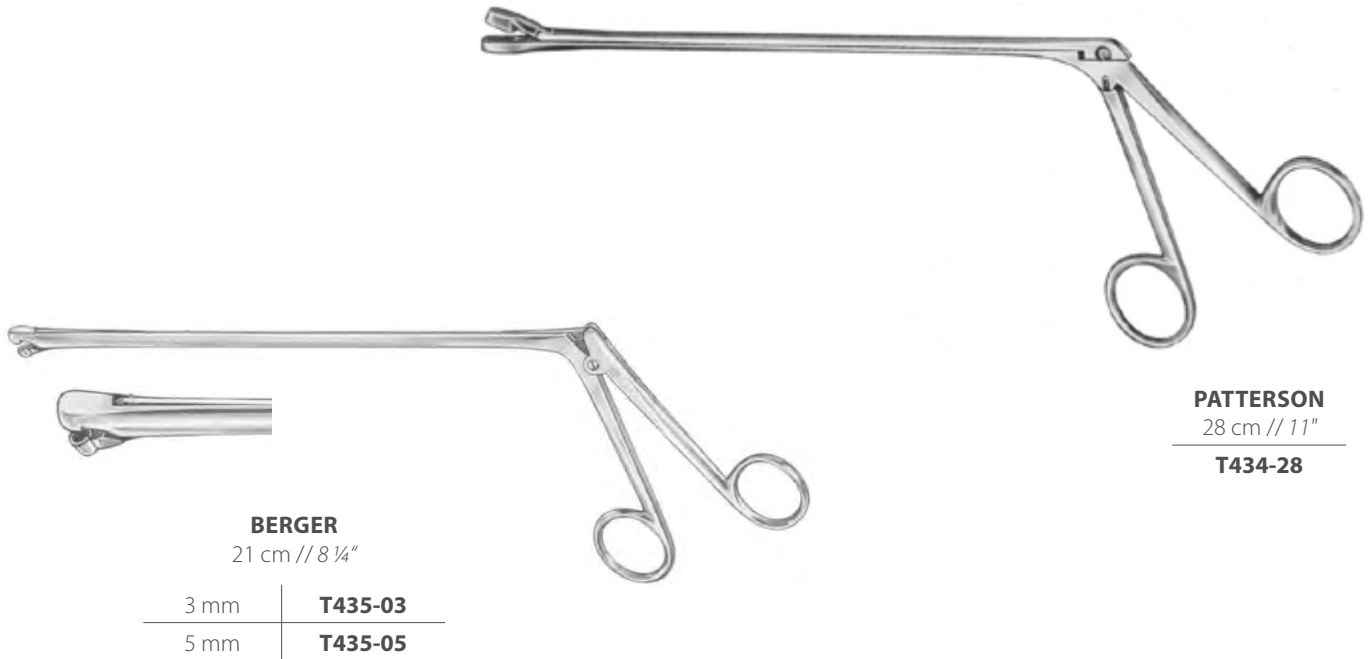

BERGER
21 cm // 8 1/4"

3 mm	T435-03
5 mm	T435-05

PATTERSON
28 cm // 11"
T434-28

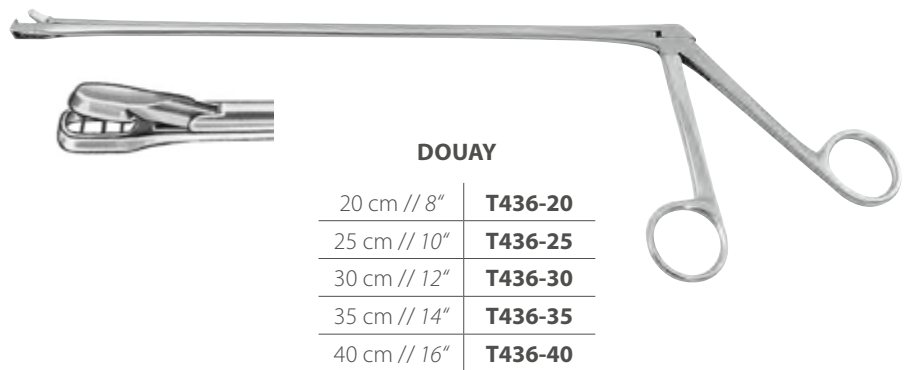

DOUAY

20 cm // 8"	T436-20
25 cm // 10"	T436-25
30 cm // 12"	T436-30
35 cm // 14"	T436-35
40 cm // 16"	T436-40

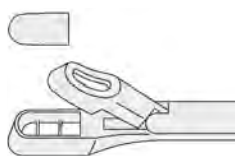

EPPENDORF
20 cm // 8"
T437-20

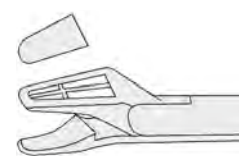

ALEXANDER
28 cm // 11"
T439-28

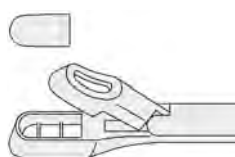

WITTNER
20 cm // 8"
T438-01

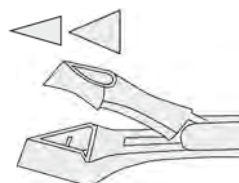

SCHUMACHER
23 cm // 9"
Fig. 1 **T440-04**
Fig. 2 **T440-06**



WITTNER
20 cm // 8"
T438-02

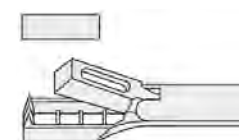

KEVORKIAN
26 cm // 10 1/4"
T442-24

Biopsiezangen Biopsy Forceps



TISCHLER
21 cm // 8 1/4"
T450-21



TISCHLER
23 cm // 9"
T452-23



BABY-TISCHLER
21 cm // 8 1/4"
T453-21



KEVORKIAN-PACIFIC
21 cm // 8 1/4"
T455-21



MINI-TOWNSEND
23 cm // 9"
T460-21



BAGGISH
23 cm // 9"
T464-23



BURKE
23 cm // 9"
T465-23

Biopsiezangen, drehbar, mit auswechselbaren Aufsätzen
Biopsy Forceps, rotatable, with exchangeable tips



TISCHLER

Aufsatz allein <i>Tip only</i>	Komplett <i>Complete</i>
T470-01	T470-51



TISCHLER
aufwärts // up

Aufsatz allein <i>Tip only</i>	Komplett <i>Complete</i>
T470-02	T470-52



TISCHLER
abwärts // down

Aufsatz allein <i>Tip only</i>	Komplett <i>Complete</i>
T470-03	T470-53



TOWNSEND

Aufsatz allein <i>Tip only</i>	Komplett <i>Complete</i>
T470-04	T470-54



TOWNSEND
aufwärts // up

Aufsatz allein <i>Tip only</i>	Komplett <i>Complete</i>
T470-05	T470-55



TOWNSEND
abwärts // down

Aufsatz allein <i>Tip only</i>	Komplett <i>Complete</i>
T470-06	T470-56



KEVORKIAN

Aufsatz allein <i>Tip only</i>	Komplett <i>Complete</i>
T470-07	T470-57



OVAL

Aufsatz allein <i>Tip only</i>	Komplett <i>Complete</i>
T470-08	T470-58



BURKE

Aufsatz allein <i>Tip only</i>	Komplett <i>Complete</i>
T470-09	T470-59



EPPENDORF

Aufsatz allein <i>Tip only</i>	Komplett <i>Complete</i>
T470-10	T470-60



SCHUMACHER

Aufsatz allein <i>Tip only</i>	Komplett <i>Complete</i>
T470-11	T470-61

Uteruslöffel Uterine Curettes



SCHRÖDER
30 cm // 12"

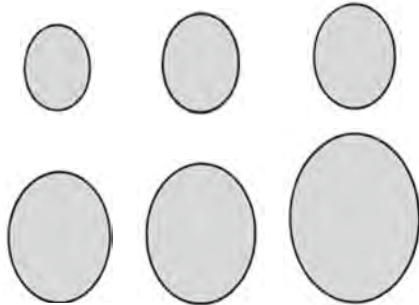

Fig. 1	T500-01
Fig. 2	T500-02
Fig. 3	T500-03
Fig. 4	T500-04
Fig. 5	T500-05
Fig. 6	T500-06



SIMON
25 cm // 10"

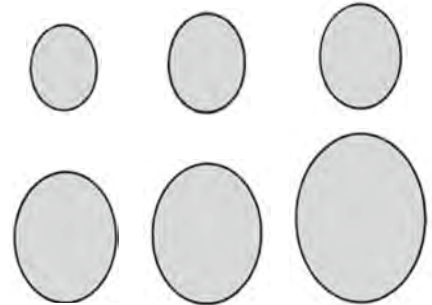
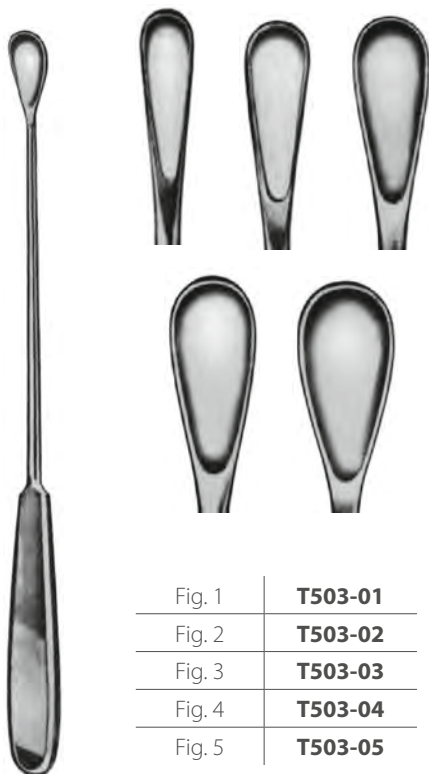

Fig. 1	T501-01
Fig. 2	T501-02
Fig. 3	T501-03
Fig. 4	T501-04
Fig. 5	T501-05
Fig. 6	T501-06



GOURDET
28 cm // 11"

Fig. 1	T503-01
Fig. 2	T503-02
Fig. 3	T503-03
Fig. 4	T503-04
Fig. 5	T503-05



HEANEY
24 cm // 9 1/2"

Ohne Korb
Without basket

T504-24

Mit Korb
With basket

T505-24

Uterusküretten
Uterine Curettes



28 cm // 11"

	Absaugküretten <i>Suction Curettes</i>
4 mm	T510-04
6 mm	T510-06
8 mm	T510-08
10 mm	T510-10
12 mm	T510-12
14 mm	T510-14



Schlauch-Verbindungsstück
Hose Connecting Piece
T510-51



stumpf, biegsam
blunt, malleable

GREENE
28 cm // 11"

10 mm	T520-10
12 mm	T520-12
14 mm	T520-14



MILAN

28,5 cm // 11 1/4"



	5 mm	7 mm	9 mm
biegsam <i>malleable</i>	T514-05	T514-07	T514-09
fest <i>rigid</i>	T514-15	T514-17	T514-19

Uterusküretten Uterine Curettes

stumpf, biegsam
blunt, malleable



THOMAS
28 cm // 11"

Fig. 0	T526-00
Fig. 1	T526-01
Fig. 2	T526-02
Fig. 3	T526-03
Fig. 4	T526-04
Fig. 5	T526-05
Fig. 6	T526-06



SIMS
25 cm // 10"

	fest/scharf <i>rigid/sharp</i>	fest/stumpf <i>rigid/blunt</i>	biegsam/scharf <i>malleable/sharp</i>	biegsam/stumpf <i>malleable/blunt</i>
Fig. 1	T530-01	T531-01	T532-01	T533-01
Fig. 2	T530-02	T531-02	T532-02	T533-02
Fig. 3	T530-03	T531-03	T532-03	T533-03
Fig. 4	T530-04	T531-04	T532-04	T533-04
Fig. 5	T530-05	T531-05	T532-05	T533-05
Fig. 6	T530-06	T531-06	T532-06	T533-06



SIMS
25 cm // 10"

	fest/scharf <i>rigid/sharp</i>	fest/stumpf <i>rigid/blunt</i>	biegsam/scharf <i>malleable/sharp</i>	biegsam/stumpf <i>malleable/blunt</i>
Fig. 1	T535-01	T536-01	T537-01	T538-01
Fig. 2	T535-02	T536-02	T537-02	T538-02
Fig. 3	T535-03	T536-03	T537-03	T538-03
Fig. 4	T535-04	T536-04	T537-04	T538-04
Fig. 5	T535-05	T536-05	T537-05	T538-05
Fig. 6	T535-06	T536-06	T537-06	T538-06

Uterusküretten
Uterine Curettes



RECAMIER

26 cm // 10 ¼"		fest/scharf <i>rigid/sharp</i>	fest/stumpf <i>rigid/blunt</i>	biegsam/scharf <i>malleable/sharp</i>	biegsam/stumpf <i>malleable/blunt</i>
Fig. 00	5 mm	T540-05	T541-05	T542-05	T543-05
Fig. 0	6 mm	T540-06	T541-06	T542-06	T543-06
Fig. 1	7 mm	T540-07	T541-07	T542-07	T543-07
Fig. 2	8 mm	T540-08	T541-08	T542-08	T543-08
Fig. 3	9 mm	T540-09	T541-09	T542-09	T543-09
Fig. 4	11 mm	T540-11	T541-11	T542-11	T543-11
Fig. 5	12 mm	T540-12	T541-12	T542-12	T543-12
Fig. 6	14 mm	T540-14	T541-14	T542-14	T543-14
Fig. 7	15 mm	T540-15	T541-15	T542-15	T543-15
Fig. 8	16 mm	T540-16	T541-16	T542-16	T543-16
Fig. 9	19 mm	T540-19	T541-19	T542-19	T543-19
Fig. 10	20 mm	T540-20	T541-20	T542-20	T543-20
Fig. 11	21 mm	T540-21	T541-21	T542-21	T543-21
Fig. 12	23 mm	T540-23	T541-23	T542-23	T543-23

31 cm // 12 ¼"		fest/scharf <i>rigid/sharp</i>	fest/stumpf <i>rigid/blunt</i>	biegsam/scharf <i>malleable/sharp</i>	biegsam/stumpf <i>malleable/blunt</i>
Fig. 00	5 mm	T544-05	T545-05	T546-05	T547-05
Fig. 0	6 mm	T544-06	T545-06	T546-06	T547-06
Fig. 1	7 mm	T544-07	T545-07	T546-07	T547-07
Fig. 2	8 mm	T544-08	T545-08	T546-08	T547-08
Fig. 3	9 mm	T544-09	T545-09	T546-09	T547-09
Fig. 4	11 mm	T544-11	T545-11	T546-11	T547-11
Fig. 5	12 mm	T544-12	T545-12	T546-12	T547-12
Fig. 6	14 mm	T544-14	T545-14	T546-14	T547-14
Fig. 7	15 mm	T544-15	T545-15	T546-15	T547-15
Fig. 8	16 mm	T544-16	T545-16	T546-16	T547-16
Fig. 9	19 mm	T544-19	T545-19	T546-19	T547-19
Fig. 10	20 mm	T544-20	T545-20	T546-20	T547-20
Fig. 11	21 mm	T544-21	T545-21	T546-21	T547-21
Fig. 12	23 mm	T544-23	T545-23	T546-23	T547-23
Fig. 13	25 mm	T544-25	T545-25	T546-25	T547-25
Fig. 14	30 mm	T544-30	T545-30	T546-30	T547-30
Fig. 15	35 mm	T544-35	T545-35	T546-35	T547-35
Fig. 16	40 mm	T544-40	T545-40	T546-40	T547-40

Uterusküretten Uterine Curettes



BUMM
29 cm // 11 1/2"

		biegsam/scharf <i>malleable/sharp</i>	biegsam/stumpf <i>malleable/blunt</i>
Fig. 0	16 mm	T550-00	T551-00
Fig. 1	18 mm	T550-01	T551-01
Fig. 2	19,5 mm	T550-02	T551-02
Fig. 3	21,5 mm	T550-03	T551-03
Fig. 4	23,5 mm	T550-04	T551-04
Fig. 5	26 mm	T550-05	T551-05
Fig. 6	28,5 mm	T550-06	T551-06



27 cm // 10 1/2" | **T553-27**
31 cm // 12 1/4" | **T553-31**

BLAKE / ZWEIFEL

Salpinograph
Salpinograph



SCHULTZE

Komplett
Complete

T555-00

Ohne Manometer
Without Manometer

T555-01

Instrumentarium zur Amnioskopie
Instruments for Amnioscopy

Amnioskop-Tuben mit Obturator
Amnioscopic tubes with obturator



12/24 x 200 mm

T560-01

16/24 x 200 mm

T560-02

20/24 x 200 mm

T560-03

Amnioskop-Tuben für Mikro-Blutentnahme
Amnioscopic tubes for Micro-bloodtaking



16/42 x 200 mm

T560-11

20/44 x 200 mm

T560-12

33/44 x 140 mm

T560-13



Kaltlicht-Proximalbeleuchtung
Cold-light proximal illumination

T560-50



Kaltlichtklammer
Cold-light clip

T560-55

Uterusmanipulatoren Uterus Manipulators

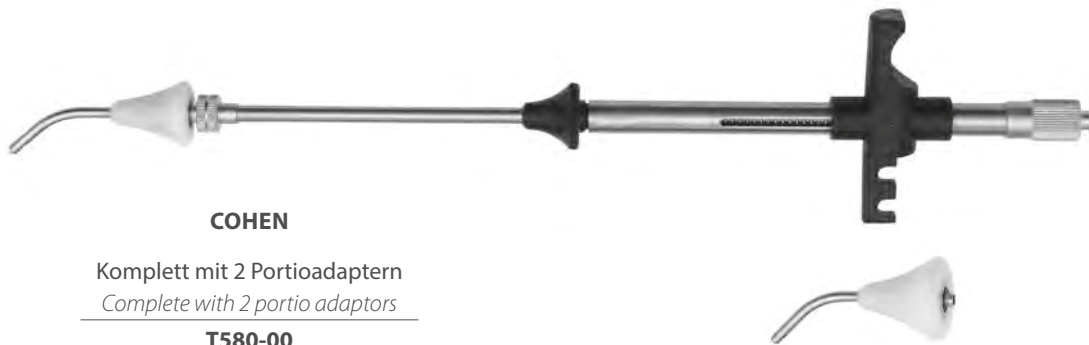

COHEN

Komplett mit 2 Portioadaptern
Complete with 2 portio adaptors

T580-00

Uterusmanipulator allein
Uterus Manipulator only

T580-10

Portioadapter, klein
Portio adaptor, small

T580-11

Portioadapter, groß
Portio adaptor, large

T580-12

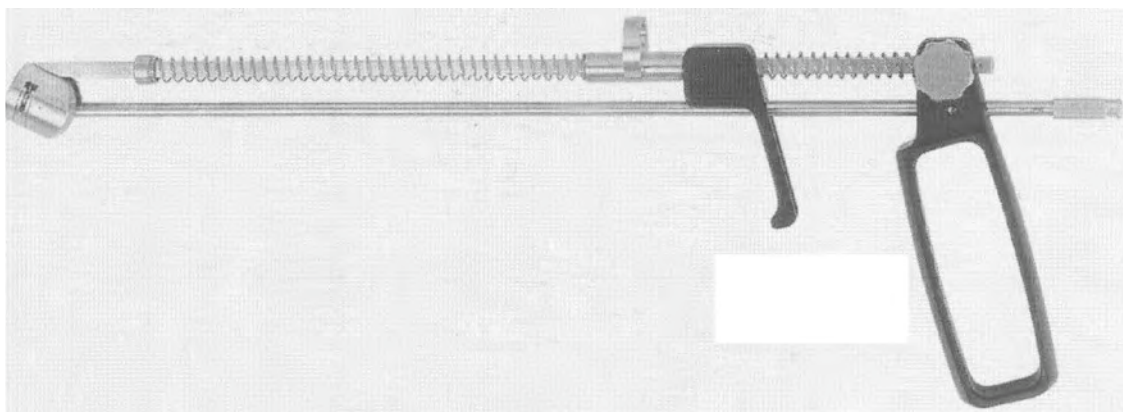

Komplett mit 6 Adaptern
Complete with 6 adaptors

T582-00

Uterusmanipulator allein
Uterus Manipulator only

T582-10



Obturator, stark, lang
Obturator, strong, long

T582-11



Obturator, dünn, lang
Obturator, thin, long

T582-21

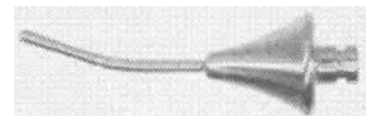

Konischer Obturator, lang
Conical adaptor, long

T582-31



Obturator, mittel, lang
Obturator, medium, long

T582-12



Obturator, dünn, kurz
Obturator, thin, short

T582-22

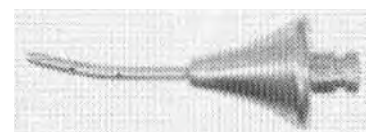

Konischer Obturator, kurz
Conical adaptor, short

T582-32

Beckenzirkel
Pelvimeters



MARTIN

cm / Zoll-Skala
cm / inch-scale

cm-Skala
cm-scale

T600-01

T600-02



COLLYER

cm / Zoll-Skala
cm / inch scale

T602-00



COLLIN

cm / Zoll-Skala
cm / inch scale

T604-00



DELEE

cm / Zoll-Skala
cm / inch scale

T606-00



IOWA

Nadelführung
Needle guide

T610-14



WALLICH

42 cm // 16 3/4"

T620-42

Abortuszangen Ovum Forceps



WINTER
28 cm // 11"

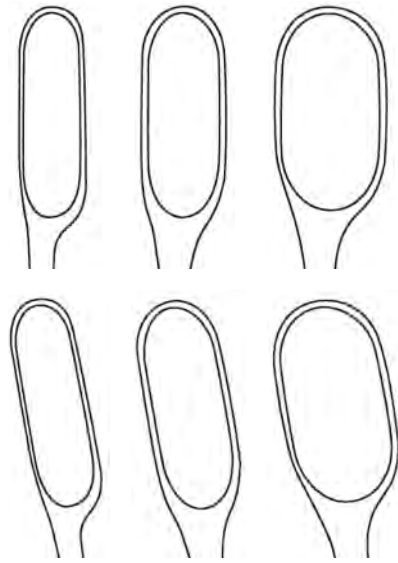

	gerade straight	gebogen curved
Fig. 1	T624-01	T625-01
Fig. 2	T624-02	T625-02
Fig. 3	T624-03	T625-03

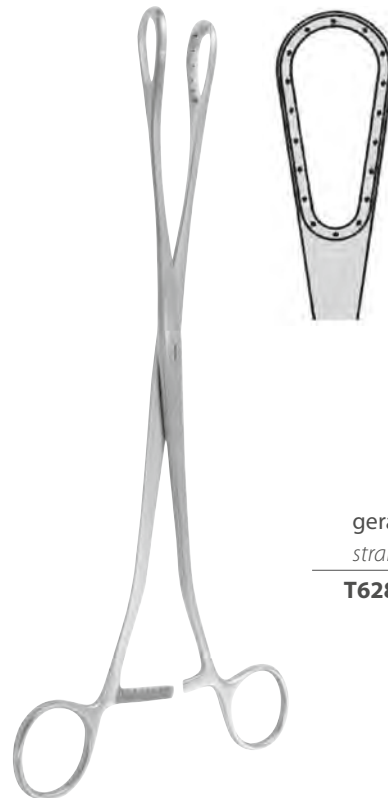

SANGER
27 cm // 10 1/2"

gerade straight	gebogen curved
T628-27	T629-27



GREEN-ARMYTAGE
21 cm // 8 1/4"
T642-21



GAUSS
26 cm // 10 1/4"
T644-26



WILLET-DEMARTEL
19 cm // 7 1/2"
G158-19

Geburtshilfe
Obstetrics



Geburtslöffel
Elevating spoon

SELLHEIM
28 cm // 11"
T650-28

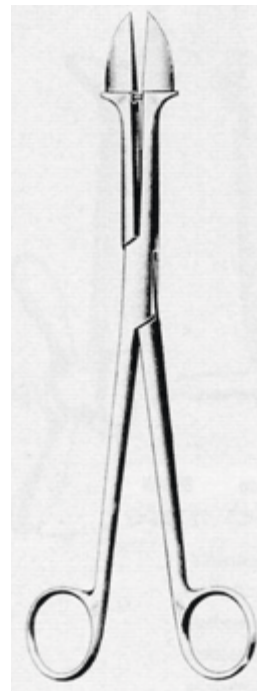

SMELLIE
25 cm // 10"
T656-25



Perforatorien
Perforators

NÄGELE
25 cm // 10"
T657-25

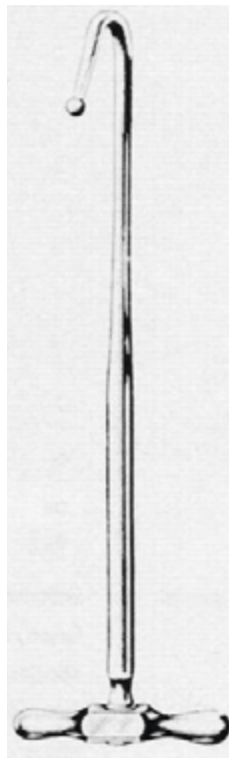

Dekapitationshaken
Decapitating hook

BRAUN
30 cm // 12"
T660-30

Nabelschnurklemme
Umbilical cord clamps



COLLIN
9 cm
T662-09

Geburtszangen
Obstetrical Forceps



SIMPSON
23 cm // 9"
T670-23



WRIGLEY
28 cm // 11"
T672-28



SIMPSON
30 cm // 12"
T674-30



SIMPSON-BRAUN
36 cm // 14"
T675-36



DELEE
30 cm // 12" | T677-30
36 cm // 14" | T677-36



NÄGELE
36 cm // 14" | T679-36
40 cm // 16" | T679-40

Geburtszangen
Obstetrical Forceps



SIMPSON-LUIKART
36 cm // 14"
T680-36



KIELLAND
41 cm // 16"
T682-41



KIELLAND-LUIKART
40 cm // 15 3/4"
T684-40



MCCLEAN
36 cm // 14"
T686-36



PIPER
44 cm // 17 1/4"
T688-44

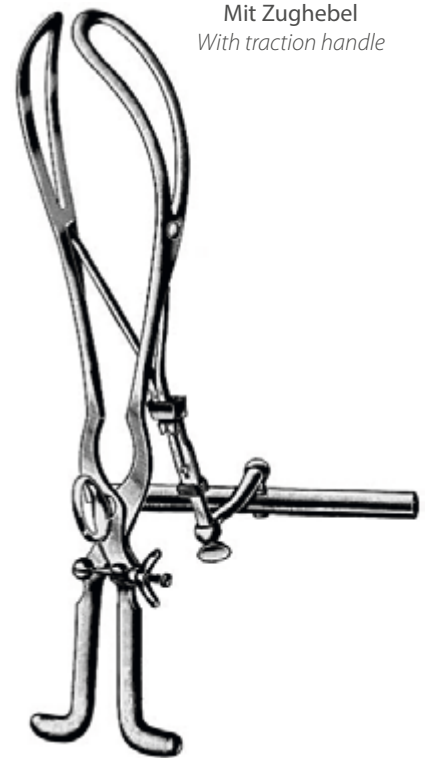

Mit Zughebel
With traction handle

TARNIER
40 cm // 16"
T690-40

Geburtszangen Obstetrical Forceps

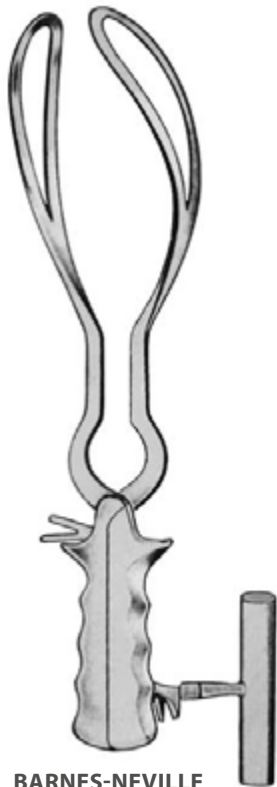

BARNES-NEVILLE
43,5 cm // 17"
T691-43



BILL
T693-00



Kranioklast
Cranioclast

BRAUN
42 cm // 16 1/2"
T695-42

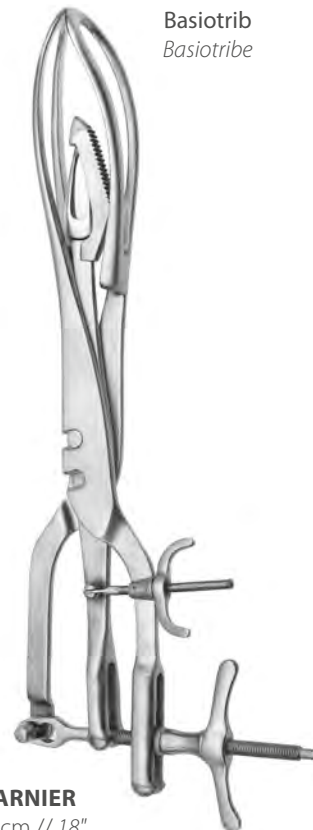

Basiotrib
Basiotribe

TARNIER
46 cm // 18"
T696-46

HF-Chirurgie

// HF-Surgery

Inhalt

Index

Abschnitt // Section **U**

Bipolare Pinzetten <i>Bipolar Forceps</i>	U02 - U09
Isolierte und Monopolare Pinzetten <i>Insulated and Monopolar Forceps</i>	U10
Bipolare Scheren <i>bipolar scissors</i>	U11 - U13
HF-Handgriffe <i>HF-Handles</i>	U14
Bipolare Kabel, Monopolare Kabel <i>Bipolar cables, Monopolar cables</i>	U15 - U17
Elektroden <i>Electrodes</i>	U18 - U29

Bipolare Pinzetten
Bipolar Forceps

Alle Bipolaren Pinzetten sind sowohl mit Flachstecker als auch mit 2-Pin-Stecker lieferbar.
All bipolar forceps are available with Flat-Plug as well as with 2-Pin-Plug.



Flachstecker
Flat-Plug



2-Pin-Stecker
2-Pin-Plug
US-Standard



11 cm // 4 1/4"



	Standard	Non-Stick
spitz <i>sharp</i>	U100-111	U100-111A
0,5 mm	U100-113	U100-113A
spitz <i>sharp</i>	U200-111	U200-111A
0,5 mm	U200-113	U200-113A



11 cm // 4 1/4"



	Standard	Non-Stick
spitz <i>sharp</i>	U101-111	U101-111A
0,5 mm	U101-113	U101-113A
spitz <i>sharp</i>	U201-111	U201-111A
0,5 mm	U201-113	U201-113A



ADSON
12 cm // 4 3/4"



	Standard	Non-Stick
	U104-120	U104-120A
	U204-120	U201-120A

Bipolare Pinzetten Bipolar Forceps



		Standard	Non-Stick
16 cm // 6 1/4"	sharp	U106-161	U106-161A
16 cm // 6 1/4"	0,5 mm	U106-163	U106-163A
16 cm // 6 1/4"	1,0 mm	U106-165	U106-165A
16 cm // 6 1/4"	2,0 mm	U106-167	U106-167A
18 cm // 7"	sharp	U106-181	U106-181A
18 cm // 7"	0,5 mm	U106-183	U106-183A
18 cm // 7"	1,0 mm	U106-185	U106-185A
18 cm // 7"	2,0 mm	U106-187	U106-187A
19,5 cm // 7 3/4"	sharp	U106-191	U106-191A
19,5 cm // 7 3/4"	0,5 mm	U106-193	U106-193A
19,5 cm // 7 3/4"	1,0 mm	U106-195	U106-195A
19,5 cm // 7 3/4"	2,0 mm	U106-197	U106-197A
22 cm // 8 3/4"	sharp	U106-221	U106-221A
22 cm // 8 3/4"	0,5 mm	U106-223	U106-223A
22 cm // 8 3/4"	1,0 mm	U106-225	U106-225A
22 cm // 8 3/4"	2,0 mm	U106-227	U106-227A
24 cm // 9 1/2"	sharp	U106-241	U106-241A
24 cm // 9 1/2"	0,5 mm	U106-243	U106-243A
24 cm // 9 1/2"	1,0 mm	U106-245	U106-245A
24 cm // 9 1/2"	2,0 mm	U106-247	U106-247A

		Standard	Non-Stick
16 cm // 6 1/4"	sharp	U206-161	U206-161A
16 cm // 6 1/4"	0,5 mm	U206-163	U206-163A
16 cm // 6 1/4"	1,0 mm	U206-165	U206-165A
16 cm // 6 1/4"	2,0 mm	U206-167	U206-167A
18 cm // 7"	sharp	U206-181	U206-181A
18 cm // 7"	0,5 mm	U206-183	U206-183A
18 cm // 7"	1,0 mm	U206-185	U206-185A
18 cm // 7"	2,0 mm	U206-187	U206-187A
19,5 cm // 7 3/4"	sharp	U206-191	U206-191A
19,5 cm // 7 3/4"	0,5 mm	U206-193	U206-193A
19,5 cm // 7 3/4"	1,0 mm	U206-195	U206-195A
19,5 cm // 7 3/4"	2,0 mm	U206-197	U206-197A
22 cm // 8 3/4"	sharp	U206-221	U206-221A
22 cm // 8 3/4"	0,5 mm	U206-223	U206-223A
22 cm // 8 3/4"	1,0 mm	U206-225	U206-225A
22 cm // 8 3/4"	2,0 mm	U206-227	U206-227A
24 cm // 9 1/2"	sharp	U206-241	U206-241A
24 cm // 9 1/2"	0,5 mm	U206-243	U206-243A
24 cm // 9 1/2"	1,0 mm	U206-245	U206-245A
24 cm // 9 1/2"	2,0 mm	U206-247	U206-247A

Bipolare Pinzetten
Bipolar Forceps



		Standard	Non-Stick
16 cm // 6 1/4"	sharp	U107-161	U107-161A
16 cm // 6 1/4"	0,5 mm	U107-163	U107-163A
16 cm // 6 1/4"	1,0 mm	U107-165	U107-165A
16 cm // 6 1/4"	2,0 mm	U107-167	U107-167A
18 cm // 7"	sharp	U107-181	U107-181A
18 cm // 7"	0,5 mm	U107-183	U107-183A
18 cm // 7"	1,0 mm	U107-185	U107-185A
18 cm // 7"	2,0 mm	U107-187	U107-187A
19,5 cm // 7 3/4"	sharp	U107-191	U107-191A
19,5 cm // 7 3/4"	0,5 mm	U107-193	U107-193A
19,5 cm // 7 3/4"	1,0 mm	U107-195	U107-195A
19,5 cm // 7 3/4"	2,0 mm	U107-197	U107-197A
22 cm // 8 3/4"	sharp	U107-221	U107-221A
22 cm // 8 3/4"	0,5 mm	U107-223	U107-223A
22 cm // 8 3/4"	1,0 mm	U107-225	U107-225A
22 cm // 8 3/4"	2,0 mm	U107-227	U107-227A
24 cm // 9 1/2"	sharp	U107-241	U107-241A
24 cm // 9 1/2"	0,5 mm	U107-243	U107-243A
24 cm // 9 1/2"	1,0 mm	U107-245	U107-245A
24 cm // 9 1/2"	2,0 mm	U107-247	U107-247A

		Standard	Non-Stick
16 cm // 6 1/4"	sharp	U207-161	U207-161A
16 cm // 6 1/4"	0,5 mm	U207-163	U207-163A
16 cm // 6 1/4"	1,0 mm	U207-165	U207-165A
16 cm // 6 1/4"	2,0 mm	U207-167	U207-167A
18 cm // 7"	sharp	U207-181	U207-181A
18 cm // 7"	0,5 mm	U207-183	U207-183A
18 cm // 7"	1,0 mm	U207-185	U207-185A
18 cm // 7"	2,0 mm	U207-187	U207-187A
19,5 cm // 7 3/4"	sharp	U207-191	U207-191A
19,5 cm // 7 3/4"	0,5 mm	U207-193	U207-193A
19,5 cm // 7 3/4"	1,0 mm	U207-195	U207-195A
19,5 cm // 7 3/4"	2,0 mm	U207-197	U207-197A
22 cm // 8 3/4"	sharp	U207-221	U207-221A
22 cm // 8 3/4"	0,5 mm	U207-223	U207-223A
22 cm // 8 3/4"	1,0 mm	U207-225	U207-225A
22 cm // 8 3/4"	2,0 mm	U207-227	U207-227A
24 cm // 9 1/2"	sharp	U207-241	U207-241A
24 cm // 9 1/2"	0,5 mm	U207-243	U207-243A
24 cm // 9 1/2"	1,0 mm	U207-245	U207-245A
24 cm // 9 1/2"	2,0 mm	U207-247	U207-247A

Bipolare Pinzetten Bipolar Forceps



		Standard	Non-Stick
19,5 cm // 7 3/4"	sharp	U109-191	U109-191A
19,5 cm // 7 3/4"	0,5 mm	U109-193	U109-193A
19,5 cm // 7 3/4"	1,0 mm	U109-195	U109-195A
19,5 cm // 7 3/4"	2,0 mm	U109-197	U109-197A
22 cm // 8 3/4"	sharp	U109-221	U109-221A
22 cm // 8 3/4"	0,5 mm	U109-223	U109-223A
22 cm // 8 3/4"	1,0 mm	U109-225	U109-225A
22 cm // 8 3/4"	2,0 mm	U109-227	U109-227A
24 cm // 9 1/2"	sharp	U109-241	U109-241A
24 cm // 9 1/2"	0,5 mm	U109-243	U109-243A
24 cm // 9 1/2"	1,0 mm	U109-245	U109-245A

		Standard	Non-Stick
19,5 cm // 7 3/4"	sharp	U209-191	U209-191A
19,5 cm // 7 3/4"	0,5 mm	U209-193	U209-193A
19,5 cm // 7 3/4"	1,0 mm	U209-195	U209-195A
19,5 cm // 7 3/4"	2,0 mm	U209-197	U209-197A
22 cm // 8 3/4"	sharp	U209-221	U209-221A
22 cm // 8 3/4"	0,5 mm	U209-223	U209-223A
22 cm // 8 3/4"	1,0 mm	U209-225	U209-225A
22 cm // 8 3/4"	2,0 mm	U209-227	U209-227A
24 cm // 9 1/2"	sharp	U209-241	U209-241A
24 cm // 9 1/2"	0,5 mm	U209-243	U209-243A
24 cm // 9 1/2"	1,0 mm	U209-245	U209-245A
24 cm // 9 1/2"	2,0 mm	U209-247	U209-247A

Bipolare Pinzetten
Bipolar Forceps



		Standard	Non-Stick	Standard	Non-Stick
19,5 cm // 7 3/4"	sharp	U111-191	U111-191A	U113-191	U113-191A
19,5 cm // 7 3/4"	0,5 mm	U111-193	U111-193A	U113-193	U113-193A
19,5 cm // 7 3/4"	1,0 mm	U111-195	U111-195A	U113-195	U113-195A
19,5 cm // 7 3/4"	2,0 mm	U111-197	U111-197A	U113-197	U113-197A
22 cm // 8 3/4"	sharp	U111-221	U111-221A	U113-221	U113-221A
22 cm // 8 3/4"	0,5 mm	U111-223	U111-223A	U113-223	U113-223A
22 cm // 8 3/4"	1,0 mm	U111-225	U111-225A	U113-225	U113-225A
22 cm // 8 3/4"	2,0 mm	U111-227	U111-227A	U113-227	U113-227A
24 cm // 9 1/2"	sharp	U111-241	U111-241A	U113-241	U113-241A
24 cm // 9 1/2"	0,5 mm	U111-243	U111-243A	U113-243	U113-243A
24 cm // 9 1/2"	1,0 mm	U111-245	U111-245A	U113-245	U113-245A
24 cm // 9 1/2"	2,0 mm	U111-247	U111-247A	U113-247	U113-247A



		Standard	Non-Stick	Standard	Non-Stick
19,5 cm // 7 3/4"	sharp	U211-191	U211-191A	U213-191	U213-191A
19,5 cm // 7 3/4"	0,5 mm	U211-193	U211-193A	U213-193	U213-193A
19,5 cm // 7 3/4"	1,0 mm	U211-195	U211-195A	U213-195	U213-195A
19,5 cm // 7 3/4"	2,0 mm	U211-197	U211-197A	U213-197	U213-197A
22 cm // 8 3/4"	sharp	U211-221	U211-221A	U213-221	U213-221A
22 cm // 8 3/4"	0,5 mm	U211-223	U211-223A	U213-223	U213-223A
22 cm // 8 3/4"	1,0 mm	U211-225	U211-225A	U213-225	U213-225A
22 cm // 8 3/4"	2,0 mm	U211-227	U211-227A	U213-227	U213-227A
24 cm // 9 1/2"	sharp	U211-241	U211-241A	U213-241	U213-241A
24 cm // 9 1/2"	0,5 mm	U211-243	U211-243A	U213-243	U213-243A
24 cm // 9 1/2"	1,0 mm	U211-245	U211-245A	U213-245	U213-245A
24 cm // 9 1/2"	2,0 mm	U211-247	U211-247A	U213-247	U213-247A

Bipolare Pinzetten Bipolar Forceps

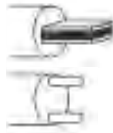

	Standard	Non-Stick
	U115-161	U115-161A
	U215-161	U215-161A

16,5 cm // 6 1/2"
spitz // sharp

Bipolare Pinzetten mit Spülung Bipolar Forceps with irrigation



		Standard
18 cm // 7"	0,5 x 8 mm	U130-181
18 cm // 7"	1,0 x 8 mm	U130-183
18 cm // 7"	2,0 x 8 mm	U130-185
20 cm // 8"	0,5 x 8 mm	U130-201
20 cm // 8"	1,0 x 8 mm	U130-203
20 cm // 8"	2,0 x 8 mm	U130-205



		Standard
18 cm // 7"	0,5 x 8 mm	U230-181
18 cm // 7"	1,0 x 8 mm	U230-183
18 cm // 7"	2,0 x 8 mm	U230-185
20 cm // 8"	0,5 x 8 mm	U230-201
20 cm // 8"	1,0 x 8 mm	U230-203
20 cm // 8"	2,0 x 8 mm	U230-205

Bipolare Pinzetten mit Spülung
Bipolar Forceps with irrigation



		Standard
18 cm // 7"	0,5 x 5 mm	U135-181
18 cm // 7"	1,0 x 5 mm	U135-183
18 cm // 7"	1,5 x 5 mm	U135-185
20 cm // 8"	0,5 x 5 mm	U135-201
20 cm // 8"	1,0 x 5 mm	U135-203
20 cm // 8"	1,5 x 5 mm	U135-205
22 cm // 8 1/2"	0,5 x 5 mm	U135-221
22 cm // 8 1/2"	1,0 x 5 mm	U135-223
22 cm // 8 1/2"	1,5 x 5 mm	U135-225

		Standard
18 cm // 7"	0,5 x 5 mm	U235-181
18 cm // 7"	1,0 x 5 mm	U235-183
18 cm // 7"	1,5 x 5 mm	U235-185
20 cm // 8"	0,5 x 5 mm	U235-201
20 cm // 8"	1,0 x 5 mm	U235-203
20 cm // 8"	1,5 x 5 mm	U235-205
22 cm // 8 1/2"	0,5 x 5 mm	U235-221
22 cm // 8 1/2"	1,0 x 5 mm	U235-223
22 cm // 8 1/2"	1,5 x 5 mm	U235-225

Bipolare Pinzetten aus Titan Bipolar titanium Forceps



		Standard
18 cm // 7"	0,5 x 8 mm	U106-183N
18 cm // 7"	1,0 x 8 mm	U106-185N
18 cm // 7"	2,0 x 8 mm	U106-187N



		Standard
18 cm // 7"	0,5 x 8 mm	U206-183N
18 cm // 7"	1,0 x 8 mm	U206-185N
18 cm // 7"	2,0 x 8 mm	U206-187N



		Standard
18 cm // 7"	0,5 x 5 mm	U109-183N
18 cm // 7"	1,0 x 5 mm	U109-185N
18 cm // 7"	1,5 x 5 mm	U109-186N
20 cm // 8"	0,5 x 5 mm	U109-203N
20 cm // 8"	1,0 x 5 mm	U109-205N
20 cm // 8"	1,5 x 5 mm	U109-206N
22 cm // 8 1/2"	0,5 x 5 mm	U109-223N
22 cm // 8 1/2"	1,0 x 5 mm	U109-225N
22 cm // 8 1/2"	1,5 x 5 mm	U109-226N



		Standard
18 cm // 7"	0,5 x 5 mm	U209-183N
18 cm // 7"	1,0 x 5 mm	U209-185N
18 cm // 7"	1,5 x 5 mm	U209-186N
20 cm // 8"	0,5 x 5 mm	U209-203N
20 cm // 8"	1,0 x 5 mm	U209-205N
20 cm // 8"	1,5 x 5 mm	U209-206N
22 cm // 8 1/2"	0,5 x 5 mm	U209-223N
22 cm // 8 1/2"	1,0 x 5 mm	U209-225N
22 cm // 8 1/2"	1,5 x 5 mm	U209-226N

Isolierte und Monopolare Pinzetten
Insulated and Monopolar Forceps

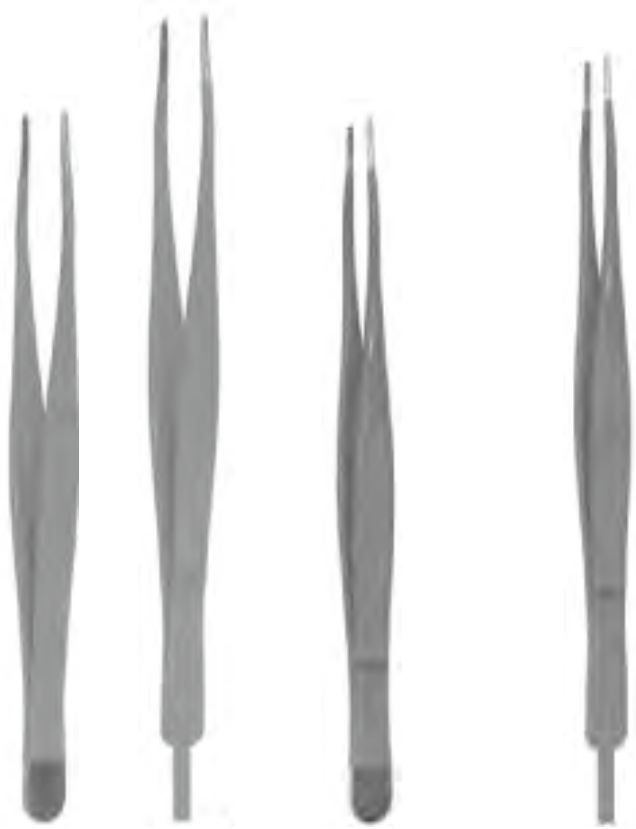

	Isoliert <i>Insulated</i>	mit Stecker <i>with plug</i>	1x2 Zähne, isoliert <i>1x2 teeth, insulated</i>	1x2 Zähne, mit Stecker <i>1x2 teeth, with plug</i>
14 cm // 5 1/2"	U300-14	U302-14	U306-14	U308-14
18 cm // 7"	U300-18	U302-18	U306-18	U308-18
21 cm // 8 1/4"	U300-21	U302-21	U306-21	U308-21
25 cm // 10"	U300-25	U302-25	U306-25	U308-25
30 cm // 12"	U300-30	U302-30	U306-30	U308-30



	Isoliert <i>Insulated</i>	mit Stecker <i>with plug</i>
14 cm // 5 1/2"	U320-14	U322-14
16 cm // 6 1/4"	U320-16	U322-16
19 cm // 7 3/4"	U320-19	U322-19

best-Bipolare Scheren *best bipolar scissors*



best-Bipolare Scheren ermöglichen das Schneiden und Präparieren bei gleichzeitiger bipolarer Koagulation und lassen sich auch zum präzisen punkt- oder flächenförmigen Koagulieren von Gefäßen und Gewebeflächen einsetzen.

Ihr Konstruktionsprinzip macht sie besonders anwendungs- und reparaturfreundlich: - das Anschlusskabel wird an lediglich an einem Ring befestigt, wodurch Behinderungen bei der Handhabung deutlich reduziert werden.

Unterschiedliche Modelle erlauben den Einsatz in allen chirurgischen Disziplinen.

best bipolar scissors enable cutting and dissection with simultaneous bipolar coagulation. They also can be used for precise pinpoint or zone coagulation of blood-vessels and tissue.

The unique and patented construction ensures an easy using: The cable is connected to one ring only, which significantly reduces interference during handling.

The program contains an entire range of Scissors for all Surgical Disciplines.



Koagulieren während des
Schneidens
Coagulation during cutting



Koagulieren vor dem
Schneiden
Coagulation prior to cutting



Punktförmige
Koagulation
Pinpoint coagulation



Flächige Koagulation
Zone coagulation

best-Bipolare Scheren
best bipolar scissors



	Standard <i>Standard</i>	Schlank <i>Delicate</i>
18 cm // 7"	U350-018	U350-118
21 cm // 8 ¼"	U350-021	U350-121
23 cm // 9"	U350-023	U350-123
28 cm // 11"	U350-028	U350-128



best Bipol-SuperCut

Mit extrem scharfen Schliff, speziell für präzises Schneiden mit Kaogulation.
With razor-sharp blades, especially for precise cutting combined with coagulation.

18 cm // 7"	U350-518
21 cm // 8 ¼"	U350-521



best Bipol-Micro

Mit extrem schlanken Schneideblättern, speziell für plastische und Wiederherstellungschirurgie.
With extreme slim blades, especially for plastic and reconstructive Surgery.

13 cm // 5"	U351-013
14 cm // 5 ½"	U351-014
17,5 cm // 6 ¾"	U351-017



BIPOL-OLSEN-HEGAR

	gerade straight	gebogen curved
14 cm // 5 1/2"	U355-014	U355-114
19 cm // 7 1/2"	U355-019	U355-119

Die best-bipol-OLSEN-HEGAR erlauben das kräftige Fassen von Gewebe in Verbindung mit bipolarer Koagulation. Das Gewebe kann ohne Instrumentenwechsel durchtrennt werden.

The best-bipol-OLSEN-HEGAR enable powerful grasping of the tissue, combined with bipolar coagulation.

The tissue can be cut without changing the instrument.

Kabel für bipolare Scheren
Cables for bipolar scissors



ERBE

3 m | **U460-003**

5 m | **U460-005**



MARTIN, AESCULAP, WOLF

3 m | **U460-103**

5 m | **U460-105**



2-BANANA

3 m | **U460-203**

5 m | **U460-205**



VALLEYLAB, LAMIDEY, EMC

3 m | **U460-303**

5 m | **U460-305**

HF-Handgriffe, wiederverwendbar, autoklavierbar
HF-Handles, reusable, autoclavable



für Elektroden	für Erbe	für Integra
2,4 mm	U400-01	U401-01
4,0 mm	U400-02	U401-02

Kabel für Handgriffe
Cables for Handles



	für Erbe	für Integra
4 m	U440-03	U441-03
5 m	U440-05	U441-05

HF-Handgriffe, wiederverwendbar, autoklavierbar, mit integriertem Kabel, für 1,6 mm Elektroden
HF-Handles, reusable, autoclavable, with integrated cable, for 1,6 mm Electrodes



für Elektroden	für Erbe	für Integra	4 mm plug
1,6 mm	U410-01	U410-02	U410-03

HF-Handgriffe, wiederverwendbar, autoklavierbar, mit integriertem Kabel
HF-Handles, reusable, autoclavable, with integrated cable



für Elektroden		für Erbe	für Integra	Internat. 3-pole
4 mm	3 m	U412-03	U413-03	U414-03
4 mm	5 m	U412-05	U413-05	U414-05
2,4 mm	3 m	U420-03	U421-03	U422-03
2,4 mm	5 m	U420-05	U421-05	U422-05

Bipolare Kabel Bipolar cables



Geräteseite <i>Generator Side</i>	Kabellänge <i>Cable length</i>	Flachstecker <i>Flat plug</i>	Flachstecker <i>Flat plug</i>	Flachstecker gewinkelt <i>Flat plug angled</i>	2-Pin Stecker gewinkelt <i>2-Pin plug angled</i>
Erbe ICC	3 m	U450-003	U450-103	-	U450-403
	5 m	U450-005	U450-105	U450-205	U450-405
Berchthold, Integra	3 m	U450-013	U450-113	-	U450-413
	5 m	U450-015	U450-115	U450-215	U450-415
US-Mod. 2-pol.	3 m	U450-023	U450-123	-	U450-423
	5 m	U450-025	U450-125	U450-225	U450-425
Int. Mod. 2-pol.	3 m	U450-033	U450-133	-	U450-433
	5 m	U450-035	U450-135	U450-235	U450-435

Monopolare Kabel
Monopolar cables

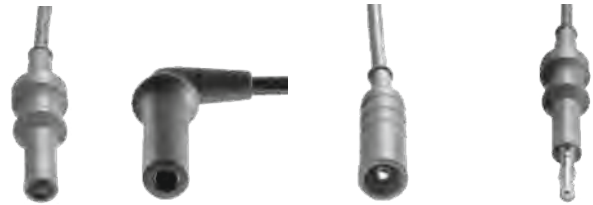

Geräteseite <i>Generator Side</i>	Kabellänge <i>Cable length</i>	4 mm gerade <i>straight</i>	4 mm gewinkelt <i>angled</i>	2 mm f. Resektoskop <i>f. Resectoscope</i>	4 mm gerade <i>straight</i>
Erbe T, Martin, Berchthold	3 m	U550-003	U550-103	U550-203	U550-603
	5 m	U550-005	-	U550-205	U550-605
Bovie, Valleylab, Conmed	3 m	U550-013	U550-113	U550-213	U550-613
	5 m	U550-015	-	U550-215	U550-615
Martin, Berchthold, Aesculap	3 m	U550-023	-	U550-223	U550-623
	5 m	U550-025	-	U550-225	-
Erbe ACC/ICC, VIO	3 m	U550-033	-	U550-233	-
	5 m	U550-035	-	U550-235	-

Bipolare Adapter Bipolar adapters



für Martin Generator
for Martin generator

U580-000

für Erbe Generator
for Erbe generator

U580-001



für Martin Kabel
for Martin cable

U580-002

für Erbe Kabel
for Erbe cable

U580-003

Monopolare Adapter Monopolar adapters



für Martin Generator
for Martin generator

U580-004



für Erbe Generator
for Erbe generator

U580-005

Wiederverwendbare Neutralelektroden Reusable neutral electrodes



Für Kinder
for children

8 x 16 cm

U585-001

für Erbe Generator
for Erbe generator

15 x 26 cm

U585-002

Elektroden für die plastische Chirurgie, 1,6 mm
Electrodes for plastic surgery, 1,6 mm

1,6 mm



Spatelektrode <i>Spatula Electrode</i>	Art.-Nr. <i>Item No.</i>	Stück <i>Unit</i>
6 x 2 mm	U601-521	5



Nadelelektrode <i>Needle Electrode</i>	Art.-Nr. <i>Item No.</i>	Stück <i>Unit</i>
20 x 0,3 mm	U601-531	5



Drahtschlingenelektrode <i>Wire Loop Electrode</i>	Art.-Nr. <i>Item No.</i>	Stück <i>Unit</i>
5 x 0,2 mm	U601-550	5
8 x 0,2 mm	U601-551	5



Drahtschlingenelektrode Rhombus <i>Wire Loop Electrode Rombic</i>	Art.-Nr. <i>Item No.</i>	Stück <i>Unit</i>
	U601-553	5



Drahtschlingenelektrode <i>Wire Loop Electrode</i>	Art.-Nr. <i>Item No.</i>	Stück <i>Unit</i>
7 x 0,2 mm	U601-554	5
9 x 0,2 mm	U601-555	5



Kuguelektrode <i>Ball Electrode</i>	Art.-Nr. <i>Item No.</i>	Stück <i>Unit</i>
1 mm	U601-560	5
3 mm	U601-564	5

Elektroden für Dental und Kosmetik, 1,6 mm
Electrodes for dental and cosmetic / plastic, 1,6 mm

1,6 mm



Koagulations- und Fulgurationselektrode <i>Coagulation- and Fulgurationselektrode</i>	Art.-Nr. <i>Item No.</i>	Stück <i>Unit</i>
	U601-601	5



Nadelelektrode <i>Needle Electrode</i>	Art.-Nr. <i>Item No.</i>	Stück <i>Unit</i>
0,2 mm	U601-630	5



Nadelelektrode <i>Needle Electrode</i>	Art.-Nr. <i>Item No.</i>	Stück <i>Unit</i>
0,2 mm	U601-631	5



Koagulationselektrode <i>Coagulation Electrode</i>	Art.-Nr. <i>Item No.</i>	Stück <i>Unit</i>
1,7 mm	U601-632	5



Drahtschlingenelektrode <i>Wire Loop Electrode</i>	Art.-Nr. <i>Item No.</i>	Stück <i>Unit</i>
3 mm	U601-640	5
5 mm	U601-641	5
8 mm	U601-642	5



Kugelelektrode <i>Ball Electrode</i>	Art.-Nr. <i>Item No.</i>	Stück <i>Unit</i>
1,7 mm	U601-660	5
3,0 mm	U601-664	5



Kugelelektrode <i>Ball Electrode</i>	Art.-Nr. <i>Item No.</i>	Stück <i>Unit</i>
1,7 mm	U601-661	5
3,0 mm	U601-665	5

Elektroden, 2,4 mm
Electrodes, 2,4 mm

2,4 mm



Messerelektrode <i>Knife Electrode</i>	Art.-Nr. <i>Item No.</i>	Stück <i>Unit</i>
20 x 2,5 mm	U602-101	5



Spatelektrode <i>Spatula Electrode</i>	Art.-Nr. <i>Item No.</i>	Stück <i>Unit</i>
20 x 2,5 mm	U602-122	5



Nadelektrode <i>Needle Electrode</i>	Art.-Nr. <i>Item No.</i>	Stück <i>Unit</i>
20 x 0,5 mm	U602-133	5
20 x 0,7 mm	U602-134	5



Nadelektrode <i>Needle Electrode</i>	Art.-Nr. <i>Item No.</i>	Stück <i>Unit</i>
20 x 0,5 mm	U602-140	1



Nadelektrode <i>Needle Electrode</i>	Art.-Nr. <i>Item No.</i>	Stück <i>Unit</i>
20 x 0,5 mm	U602-141	1



Wolframnadelektrode mit Keramikisolation <i>Tungsten Electrode with ceramic Insulation</i>	Art.-Nr. <i>Item No.</i>	Stück <i>Unit</i>
5 x 0,5 mm	U602-143	1



Drahtschlingenelektrode <i>Wire Loop Electrode</i>	Art.-Nr. <i>Item No.</i>	Stück <i>Unit</i>
5 mm	U602-150	5
10 mm	U602-152	5
14 mm	U602-154	5



Bandschlingenelektrode <i>Ribbon Loop Electrode</i>	Art.-Nr. <i>Item No.</i>	Stück <i>Unit</i>
10 mm	U602-156	5
14 mm	U602-158	5



Kugelelektrode <i>Ball Electrode</i>	Art.-Nr. <i>Item No.</i>	Stück <i>Unit</i>
2 mm	U602-163	5
4 mm	U602-164	5
6 mm	U602-165	5



Kugelelektrode <i>Ball Electrode</i>	Art.-Nr. <i>Item No.</i>	Stück <i>Unit</i>
2 mm	U602-173	5
4 mm	U602-174	5

Elektroden, 2,4 mm
Electrodes, 2,4 mm

2,4 mm



90 mm

Messerelektrode <i>Knife Electrode</i>	Art.-Nr. <i>Item No.</i>	Stück <i>Unit</i>
20 x 2,5 mm	U602-202	1



90 mm

Spatelektrode <i>Spatula Electrode</i>	Art.-Nr. <i>Item No.</i>	Stück <i>Unit</i>
20 x 2,5 mm	U602-223	1

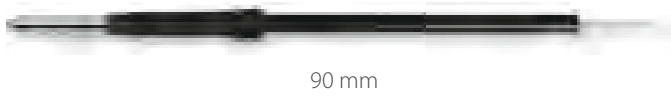

90 mm

Nadelelektrode <i>Needle Electrode</i>	Art.-Nr. <i>Item No.</i>	Stück <i>Unit</i>
20 x 0,5 mm	U602-232	1
20 x 0,7 mm	U602-233	1



90 mm

Kugelelektrode <i>Ball Electrode</i>	Art.-Nr. <i>Item No.</i>	Stück <i>Unit</i>
2 mm	U602-260	1
4 mm	U602-261	1



110 mm

Drahtschlingenelektrode <i>Wire Loop Electrode</i>	Art.-Nr. <i>Item No.</i>	Stück <i>Unit</i>
10 x 10 mm	U602-270	1
15 x 15 mm	U602-271	1
20 x 15 mm	U602-272	1
20 x 20 mm	U602-273	1
20 x 25 mm	U602-274	1



110 mm

Drahtschlingenelektrode <i>Wire Loop Electrode</i>	Art.-Nr. <i>Item No.</i>	Stück <i>Unit</i>
10 mm	U602-270	1
15 mm	U602-271	1
20 mm	U602-272	1
25 mm	U602-273	1

Elektroden für die plastische Chirurgie, 2,4 mm
Electrodes for plastic surgery, 2,4 mm

2,4 mm



Spatulelektrode <i>Spatula Electrode</i>	Art.-Nr. <i>Item No.</i>	Stück <i>Unit</i>
6 x 2 mm	U602-251	5



Drahtschlingenelektrode <i>Wire Loop Electrode</i>	Art.-Nr. <i>Item No.</i>	Stück <i>Unit</i>
5 x 0,2 mm	U602-550	5



8 x 0,2 mm	U602-551	5
------------	-----------------	---



Drahtschlingenelektrode <i>Wire Loop Electrode</i>	Art.-Nr. <i>Item No.</i>	Stück <i>Unit</i>
9 x 0,2 mm	U602-553	5



Drahtschlingenelektrode <i>Wire Loop Electrode</i>	Art.-Nr. <i>Item No.</i>	Stück <i>Unit</i>
7 x 0,2 mm	U602-554	5



9 x 0,2 mm	U602-555	5
------------	-----------------	---



Kugelelektrode <i>Ball Electrode</i>	Art.-Nr. <i>Item No.</i>	Stück <i>Unit</i>
1 mm	U602-560	5



3 mm	U602-564	5
------	-----------------	---

Elektroden für die plastische Chirurgie, 2,4 mm Electrodes for plastic surgery, 2,4 mm

2,4 mm



20 mm



20 mm



35 mm / 70 mm / 105 mm

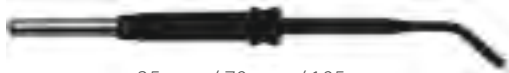

35 mm / 70 mm / 105 mm



20 mm / 35 mm / 70 mm / 105 mm

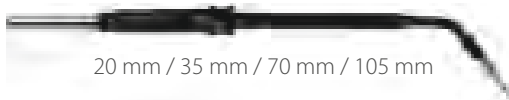

20 mm / 35 mm / 70 mm / 105 mm

Mikrodissektions- Nadelelektrode <i>Microdissection Needle Electrode</i>	Art.-Nr. <i>Item No.</i>	Stück <i>Unit</i>
20 x 0,3 mm	U602-640	5

Mikrodissektions- Nadelelektrode <i>Microdissection Needle Electrode</i>	Art.-Nr. <i>Item No.</i>	Stück <i>Unit</i>
20 x 0,3 mm	U602-641	5

Mikro-Nadelelektrode <i>Micro Needle Electrode</i>	Art.-Nr. <i>Item No.</i>	Stück <i>Unit</i>
35 x 0,3 mm	U602-642	1
70 x 0,3 mm	U602-644	1
105 x 0,3 mm	U602-646	1

Mikro-Nadelelektrode <i>Micro Needle Electrode</i>	Art.-Nr. <i>Item No.</i>	Stück <i>Unit</i>
30 x 0,3 mm	U602-643	1
70 x 0,3 mm	U602-645	1
105 x 0,3 mm	U602-647	1

Wolframnadelektrode <i>Tungsten Electrode</i>	Art.-Nr. <i>Item No.</i>	Stück <i>Unit</i>
20 x 5 x 0,5 mm	U602-650	1
35 x 5 x 0,5 mm	U602-652	1
70 x 5 x 0,5 mm	U602-654	1
105 x 5 x 0,5 mm	U602-656	1

Wolframnadelektrode <i>Tungsten Electrode</i>	Art.-Nr. <i>Item No.</i>	Stück <i>Unit</i>
20 x 5 x 0,5 mm	U602-651	1
35 x 5 x 0,5 mm	U602-653	1
70 x 5 x 0,5 mm	U602-655	1
105 x 5 x 0,5 mm	U602-657	1

Elektroden, 4 mm
Electrodes, 4 mm

4 mm



Messerelektrode <i>Knife Electrode</i>	Art.-Nr. <i>Item No.</i>	Stück <i>Unit</i>
20 x 2,5 mm	U604-101	5



Messerelektrode <i>Knife Electrode</i>	Art.-Nr. <i>Item No.</i>	Stück <i>Unit</i>
25 x 3,3 mm	U604-102	5



Messerelektrode <i>Knife Electrode</i>	Art.-Nr. <i>Item No.</i>	Stück <i>Unit</i>
27 x 1,5 mm	U604-103	5



Messerelektrode <i>Knife Electrode</i>	Art.-Nr. <i>Item No.</i>	Stück <i>Unit</i>
20 x 2,5 mm	U604-104	5



Messerelektrode <i>Knife Electrode</i>	Art.-Nr. <i>Item No.</i>	Stück <i>Unit</i>
17 x 1,5 mm	U604-107	5



Lanzettenelektrode <i>Lancet Electrode</i>	Art.-Nr. <i>Item No.</i>	Stück <i>Unit</i>
19 x 1,6 mm	U604-110	5

25 x 2,5 mm	U604-111	5
-------------	-----------------	---



Lanzettenelektrode <i>Lancet Electrode</i>	Art.-Nr. <i>Item No.</i>	Stück <i>Unit</i>
19 x 1,6 mm	U604-113	5



Spatelektrode <i>Spatula Electrode</i>	Art.-Nr. <i>Item No.</i>	Stück <i>Unit</i>
16 x 2 mm	U604-120	5



Spatelektrode <i>Spatula Electrode</i>	Art.-Nr. <i>Item No.</i>	Stück <i>Unit</i>
24 x 3 mm	U604-121	5

Elektroden, 4 mm
Electrodes, 4 mm

4 mm



Spatelektrode <i>Spatula Electrode</i>	Art.-Nr. <i>Item No.</i>	Stück <i>Unit</i>
24 x 3 mm	U604-125	1



Nadelelektrode <i>Needle Electrode</i>	Art.-Nr. <i>Item No.</i>	Stück <i>Unit</i>
15 x 0,5 mm	U604-130	5



Nadelelektrode <i>Needle Electrode</i>	Art.-Nr. <i>Item No.</i>	Stück <i>Unit</i>
15 x 0,5 mm	U604-131	5
15 x 0,7 mm	U604-132	5



Nadelelektrode <i>Needle Electrode</i>	Art.-Nr. <i>Item No.</i>	Stück <i>Unit</i>
23 x 0,5 mm	U604-135	5
23 x 0,8 mm	U604-136	5



Nadelelektrode <i>Needle Electrode</i>	Art.-Nr. <i>Item No.</i>	Stück <i>Unit</i>
29 x 0,8 mm	U604-138	1



Wolframnadelektrode <i>Tungsten Electrode</i>	Art.-Nr. <i>Item No.</i>	Stück <i>Unit</i>
20 x 0,5 mm	U604-140	1



Wolframnadelektrode <i>Tungsten Electrode</i>	Art.-Nr. <i>Item No.</i>	Stück <i>Unit</i>
20 x 0,5 mm	U604-141	1



Wolframnadelektrode mit Keramikisolation <i>Tungsten Electrode with ceramic Insulation</i>	Art.-Nr. <i>Item No.</i>	Stück <i>Unit</i>
5 x 0,5 mm	U604-143	1



Wolframnadelektrode <i>Tungsten Electrode</i>	Art.-Nr. <i>Item No.</i>	Stück <i>Unit</i>
40 x 0,5 mm	U604-145	1



Wolframnadelektrode <i>Tungsten Electrode</i>	Art.-Nr. <i>Item No.</i>	Stück <i>Unit</i>
40 x 0,5 mm	U604-146	1

Elektroden, 4 mm
Electrodes, 4 mm

4 mm



Drahtschlingenelektrode <i>Wire Loop Electrode</i>	Art.-Nr. <i>Item No.</i>	Stück <i>Unit</i>
5 mm	U604-150	5
10 mm	U604-152	5
12 mm	U604-157	5
16 mm	U604-159	5



Kugelelektrode <i>Ball Electrode</i>	Art.-Nr. <i>Item No.</i>	Stück <i>Unit</i>
2 mm	U604-163	5
4 mm	U604-164	5
6 mm	U604-165	5



Kugelelektrode <i>Ball Electrode</i>	Art.-Nr. <i>Item No.</i>	Stück <i>Unit</i>
2 mm	U604-173	5
4 mm	U604-174	5

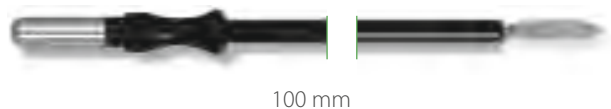

Messerelektrode <i>Knife Electrode</i>	Art.-Nr. <i>Item No.</i>	Stück <i>Unit</i>
10 x 2,4 mm	U604-201	1

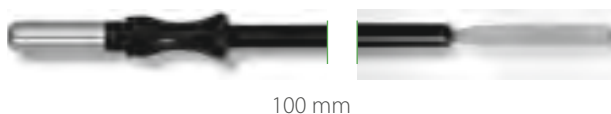

Messerelektrode <i>Knife Electrode</i>	Art.-Nr. <i>Item No.</i>	Stück <i>Unit</i>
20 x 2,4 mm	U604-202	1

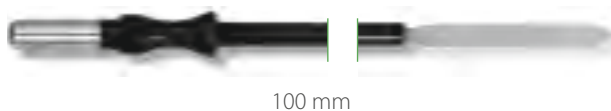

Messerelektrode <i>Knife Electrode</i>	Art.-Nr. <i>Item No.</i>	Stück <i>Unit</i>
25 x 3,3 mm	U604-203	1

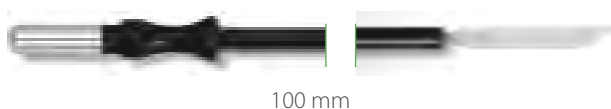

Messerelektrode <i>Knife Electrode</i>	Art.-Nr. <i>Item No.</i>	Stück <i>Unit</i>
20 x 3,3 mm	U604-205	1



Messerelektrode <i>Knife Electrode</i>	Art.-Nr. <i>Item No.</i>	Stück <i>Unit</i>
10 x 2,4 mm	U604-207	1

Elektroden, 4 mm Electrodes, 4 mm

4 mm

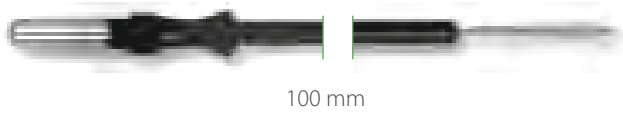

100 mm

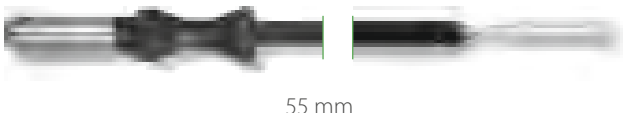

55 mm

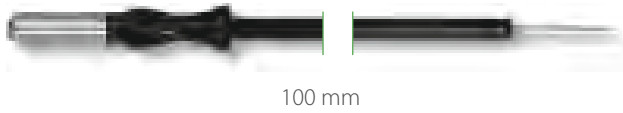

100 mm

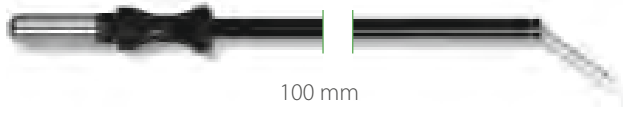

100 mm

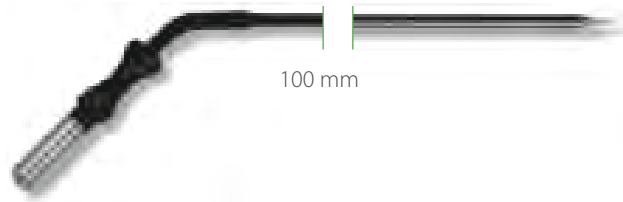

100 mm

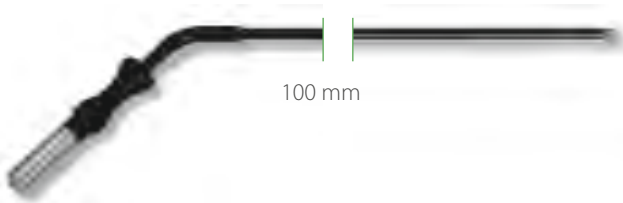

100 mm

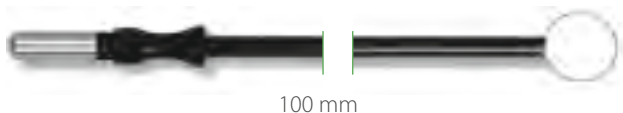

100 mm

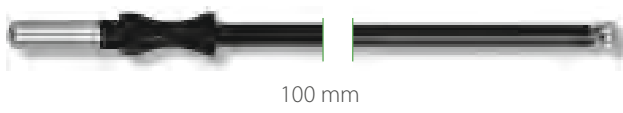

100 mm

Lanzettenelektrode <i>Lancet Electrode</i>	Art.-Nr. <i>Item No.</i>	Stück <i>Unit</i>
Fine - 20 x 1,6 mm	U604-210	1
Strong - 20 x 2,2 mm	U604-211	1

Spatelektrode <i>Spatula Electrode</i>	Art.-Nr. <i>Item No.</i>	Stück <i>Unit</i>
16 x 2 mm	U604-220	1

Nadelelektrode <i>Needle Electrode</i>	Art.-Nr. <i>Item No.</i>	Stück <i>Unit</i>
12 x 0,8 mm	U604-230	1

Nadelelektrode <i>Needle Electrode</i>	Art.-Nr. <i>Item No.</i>	Stück <i>Unit</i>
12 x 0,8 mm	U604-231	1

Nadelelektrode <i>Needle Electrode</i>	Art.-Nr. <i>Item No.</i>	Stück <i>Unit</i>
1,2 mm	U604-235	1

Kugelelektrode <i>Ball Electrode</i>	Art.-Nr. <i>Item No.</i>	Stück <i>Unit</i>
2 mm	U604-236	1

Drahtschlingenelektrode <i>Wire Loop Electrode</i>	Art.-Nr. <i>Item No.</i>	Stück <i>Unit</i>
5 mm	U604-250	1
10 mm	U604-251	1

Kugelelektrode <i>Ball Electrode</i>	Art.-Nr. <i>Item No.</i>	Stück <i>Unit</i>
2 mm	U604-260	1
4 mm	U604-261	1
6 mm	U604-262	1

Elektroden, 4 mm
Electrodes, 4 mm

4 mm

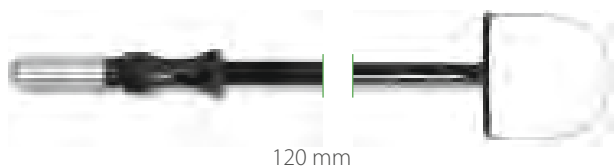

120 mm

Drahtschlingenelektrode <i>Wire Loop Electrode</i>	Art.-Nr. <i>Item No.</i>	Stück <i>Unit</i>
10 x 10 mm	U604-270	1
15 x 15 mm	U604-271	1
15 x 20 mm	U604-272	1
20 x 20 mm	U604-273	1
25 x 20 mm	U604-274	1

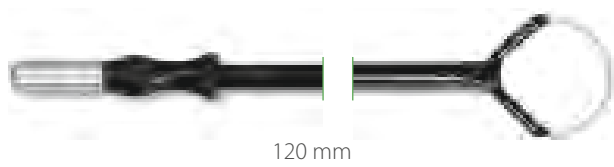

120 mm

Drahtschlingenelektrode <i>Wire Loop Electrode</i>	Art.-Nr. <i>Item No.</i>	Stück <i>Unit</i>
10 mm	U604-280	1
15 mm	U604-281	1
20 mm	U604-282	1
25 mm	U604-283	1

Mikrodissektoren - Nadelelektroden, 4 mm
Mircodessection Needle Electrodes, 4 mm



30 mm / 45 mm / 80 mm / 115 mm

Mikrodissektoren Nadelelektrode <i>Mircodessection Needle Electrodes</i>	Art.-Nr. <i>Item No.</i>	Stück <i>Unit</i>
30 x 0,3 mm	U604-640	5
45 x 0,3 mm	U604-642	1
80 x 0,3 mm	U604-644	1
115 x 0,3 mm	U604-646	1



30 mm / 45 mm / 80 mm / 115 mm

Mikrodissektoren Nadelelektrode <i>Mircodessection Needle Electrodes</i>	Art.-Nr. <i>Item No.</i>	Stück <i>Unit</i>
30 x 0,3 mm	U604-641	1
45 x 0,3 mm	U604-643	1
80 x 0,3 mm	U604-645	1
115 x 0,3 mm	U604-647	1

Nadelelektroden mit Keramikisolation, 4 mm Needle electrodes with ceramic insulation, 4 mm

4 mm



Nadelelektroden mit Keramikisolation <i>Needle Electrodes with ceramic insulation</i>	Art.-Nr. <i>Item No.</i>	Stück <i>Unit</i>
20 x 4 x 0,5 mm	U604-650	1
45 x 4 x 0,5 mm	U604-652	1
80 x 4 x 0,5 mm	U604-654	1
115 x 4 x 0,5 mm	U604-656	1



Nadelelektroden mit Keramikisolation <i>Needle Electrodes with ceramic insulation</i>	Art.-Nr. <i>Item No.</i>	Stück <i>Unit</i>
20 x 4 x 0,5 mm	U604-651	1
45 x 4 x 0,5 mm	U604-653	1
80 x 4 x 0,5 mm	U604-655	1
115 x 4 x 0,5 mm	U604-657	1

Elektrodenverlängerung für 4 mm Schaft Extension for electrodes for 4 mm shaft



Elektrodenverlängerung für 4 mm Schaft <i>Extension for Electrodes for 4 mm shaft</i>	Art.-Nr. <i>Item No.</i>
100 mm	U604-901
150 mm	U604-902

Sterilisation

// Sterilizing

Inhalt

Index

Abschnitt **W**
// Section

Sterilisierzangen, Sterilisierklammern <i>Sterilizing forceps, Safety pins</i>	W02
Instrumenten-Reinigung <i>Cleaning of Instruments</i>	W03
Instrumenten-Kassetten, Edelstahl <i>Instrument Cases, Stainless Steel</i>	W04 - W06
Verbandstofftrommeln <i>Dressing Sterilizing Drums</i>	W07
Diverse Kassetten <i>Various Baskets</i>	W08 - W09
Container-System <i>Container-System</i>	W10 - W30
Diverse Schalen, Behälter <i>Various Trays and bowls</i>	W31 - W34
Kunststoffbehälter für Endoskope <i>Plastic Container for Endoscopes</i>	W35

Sterilisierzangen, Sterilisierklammern
Sterilizing forceps, Safety pins



20 cm // 8"	W100-20
30 cm // 12"	W100-30



ROGGE
23 cm // 9"
W101-23



	gerade straight	gebogen curved
20 cm // 8"	W102-20	W103-20
28 cm // 11"	W102-28	W103-28



CHEATLE
27 cm // 10 1/2"
W105-27

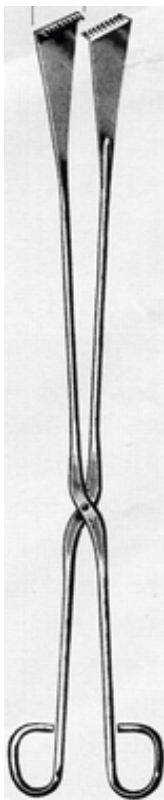

SAUERBRUCH
55 cm // 21 1/2"
W107-55



DAVIS
16 cm // 6 1/4"
W110-16
24 cm // 9 1/2"
W110-24



BUNT
W115-01



MAYO
W115-02



MAYO
W115-03



15 cm // 6"	W117-06
20 cm // 8"	W117-08
25 cm // 10"	W117-10
30 cm // 12"	W117-12
40 cm // 16"	W117-16

Instrumenten-Reinigung Cleaning of Instruments



Handwaschbürste
Hand Brushes
W150-00



Bürstenspender für 20 Bürsten
Dispenser for 20 brushes
W150-51

Reinigungsbürsten für die Endoskopie *Cleaning brushes for Endoscopy*



	ø 2,5 mm	ø 7,0 mm	ø 11,0 mm
38 cm // 15"	W155-51	W155-55	W155-59
50 cm // 20"	W155-52	W155-56	W155-60



Reinigungspistole, kplt. mit Schlauch und
Konus, mit Aufsätzen W160-25 , Anschluss 1/2"
*Cleaning gun, cplt. with tubing and cone, with
Attachments W160-25, Connector 1/2"*

W160-11

Reinigungspistole,, kplt. mit Schlauch und
Konus, mit Aufsätzen W160-25 , Anschluss 3/4"
*Cleaning gun, cplt. with tubing and cone, with
Attachments W160-25, Connector 3/4"*

W160-12

Reinigungspistole ohne Zubehör
Cleaning gun without accessories

W160-05



Satz Standardaufsätze
Set Attachments

W160-25

Instrumenten-Kassetten, Edelstahl
Instrument Cases, Stainless Steel



Herausnehmbare Siebplatte
Removable perforated plate



			Textilfilter Textile filters	Papierfilter Paper filters
Fig. 01	220 mm	165 mm	W200-101	W200-131
Fig. 02	420 mm	125 mm	W200-102	W200-132
Fig. 03	420 mm	175 mm	W200-103	-
Fig. 04	300 mm	220 mm	W200-104	W200-134
Fig. 05	285 mm	280 mm	W200-105	-
Fig. 06	400 mm	225 mm	W200-106	W200-136
Fig. 07	400 mm	290 mm	W200-107	W200-137
Fig. 08	450 mm	260 mm	W200-108	W200-138
Fig. 09	400 mm	150 mm	W200-109	-
Fig. 10	495 mm	270 mm	W200-110	-

2-fach Lagerung mit 2 herausnehmbaren Siebplatten
Double storage with 2 removable perforated plates



			Textilfilter Textile filters	Papierfilter Paper filters
Fig. 01	220 mm	165 mm	W200-201	W200-231
Fig. 02	420 mm	125 mm	W200-202	W200-232
Fig. 03	420 mm	175 mm	W200-203	-
Fig. 04	300 mm	220 mm	W200-204	W200-234
Fig. 05	285 mm	280 mm	W200-205	-
Fig. 06	400 mm	225 mm	W200-206	W200-236
Fig. 07	400 mm	290 mm	W200-207	W200-237
Fig. 08	450 mm	260 mm	W200-208	W200-238
Fig. 09	400 mm	150 mm	W200-209	-
Fig. 10	495 mm	270 mm	W200-210	-

Instrumenten-Kassetten, Edelstahl Instrument Cases, Stainless Steel

Kassetten können auch mit Silikonmatten geliefert werden.
Bitte anfragen.

*Cassettes can be delivered with Silicon mats.
On request*



Kassetten können auch mit Silikonbänken geliefert werden.
Bitte anfragen.

*Cassettes can be delivered with Silicon benches.
On request*



Langzeittextilfilter allein
Long-term textile filters only

Für Kassette <i>For Case</i>		Art.-Nr. <i>Item No.</i>
Fig. 01	178 x 115 mm	W200-501
Fig. 02	370 x 75 mm	W200-502
Fig. 03	355 x 100 mm	W200-503
Fig. 04	245 x 165 mm	W200-504
Fig. 05	230 x 22 mm	W200-505
Fig. 06	350 x 170 mm	W200-506
Fig. 07	358 x 235 mm	W200-507
Fig. 08	400 x 200 mm	W200-508
Fig. 09	355 x 100 mm	W200-509
Fig. 10	440 x 220 mm	W200-510

Einmal-Papierfilter, 100 Stück
Disposable Paper filters, 100 pcs.

Für Kassette <i>For Case</i>		Art.-Nr. <i>Item No.</i>
Fig. 01	178 x 115 mm	W200-521
Fig. 02	370 x 75 mm	W200-522
Fig. 04	245 x 165 mm	W200-524
Fig. 06	350 x 170 mm	W200-526
Fig. 07	358 x 235 mm	W200-527
Fig. 08	400 x 200 mm	W200-528

Silikon-Noppenmatten
Silicone mats

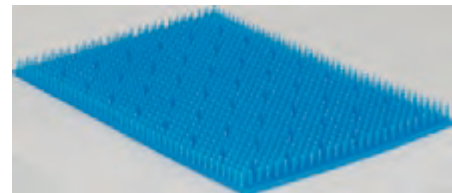

Für Kassette <i>For Case</i>		Art.-Nr. <i>Item No.</i>
Fig. 01	195 x 135 mm	W200-901
Fig. 02	390 x 91 mm	W200-902
Fig. 03	392 x 144 mm	W200-903
Fig. 04	275 x 185 mm	W200-904
Fig. 05	255 x 245 mm	W200-905
Fig. 06	370 x 185 mm	W200-906
Fig. 07	365 x 252 mm	W200-907
Fig. 08	420 x 220 mm	W200-908
Fig. 09	374 x 120 mm	W200-909
Fig. 10	460 x 231 mm	W200-910

Silikon-Noppenmatten, kann auf das gewünschte
Maß zugeschnitten werden

*Silicone mats, can be cut to the desired dimensions
545 x 255 mm*

W200-940

Container, Leichtmetall-Unterteil und robuster Edelstahl-Deckel, mit Textilfilter
Container, aluminium bottom and stainless steel cover, with textile filters



	Boden gelocht Deckel gelocht	Boden ungelocht Deckel gelocht
	<i>Bottom perforated Lid perforated</i>	<i>Bottom non-perforated Lid perforated</i>
275 x 275 x 100 mm	W250-001	W250-101
275 x 275 x 130 mm	W250-002	W250-102
275 x 275 x 170 mm	W250-003	W250-103
275 x 275 x 250 mm	W250-004	W250-104
575 x 275 x 100 mm	W251-001	W251-101
575 x 275 x 130 mm	W251-002	W251-102
575 x 275 x 170 mm	W251-003	W251-103
575 x 275 x 250 mm	W251-004	W251-104
	Langzeittextilfilter <i>Textile filters</i>	
210 x 210 mm	W250-501	
490 x 210 mm	W251-501	

Entsorgungscontainer Deckel und Boden ungelocht
Lid and bottom non-perforated



275 x 275 x 100 mm	W250-701
275 x 275 x 170 mm	W250-703
575 x 275 x 170 mm	W251-703

Verbandstofftrommeln Dressing Sterilizing Drums

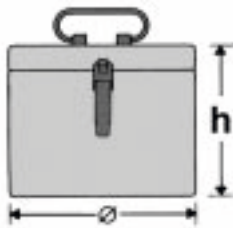

ø Durchm. ø Diameter	Höhe Height	KONRICH	Filter allein Filter only	SCHIMMELBUSCH
8 cm	8 cm	-	-	W272-001
10 cm	10 cm	W270-001	W270-101	-
12 cm	12 cm	-	-	W272-002
14 cm	14 cm	W270-002	W270-102	W272-003
16 cm	12 cm	-	-	W272-004
16 cm	15 cm	-	-	W272-005
19 cm	15 cm	W270-003	W270-103	W272-006
19 cm	19 cm	W270-004	W270-104	W272-007
24 cm	12 cm	W270-005	W270-105	W272-008
24 cm	16 cm	W270-006	W270-106	W272-009
24 cm	24 cm	W270-007	W270-107	W272-010
29 cm	16 cm	W270-008	W270-108	W272-011
29 cm	24 cm	W270-009	W270-109	W272-012
34 cm	16 cm	W270-010	W270-110	W272-013
34 cm	24 cm	W270-011	W270-111	W272-014
39 cm	14 cm	W270-012	W270-112	W272-015
39 cm	19 cm	W270-013	W270-113	W272-016
39 cm	29 cm	W270-014	W270-114	W272-017

Endoskopsiebkörbe
Endoscopy Baskets

Mit Deckel und Fixierungselement
With Lid and Silicon Holders



	Für 1 Endoskop For 1 Endoscope	Für 2 Endoskope For 2 Endoscopes
290 x 80 x 55 mm	W300-010	W300-011
460 x 80 x 55 mm	W300-030	W300-031
670 x 80 x 52 mm	W300-050	-

Mit Deckel und Fixierungselement für mehrere Endoskope
With Lid and Silicon Holders for more Endoscopes

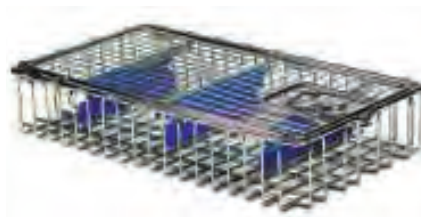

290 x 160 x 52 mm	W300-131
310 x 150 x 77 mm	W300-132
460 x 160 x 52 mm	W300-133
460 x 225 x 52 mm	W300-134
580 x 160 x 52 mm	W300-135



250 x 60 x 50 mm	W302-003
450 x 70 x 70 mm	W302-007



Lagerungsgestell für bis zu 15 Instrumente
Storing rack for up to 15 Instruments

W305-000

Bohrdrahtbehälter
Wire Containers



Für Drähte bis For wires up to	Art.-Nr. Item No.
16 cm // 6 1/4"	W310-001
23 cm // 9"	W310-002
31 cm // 12 1/8"	W310-005

Bohrdrahtbehälter
Wire Containers



Für Drähte bis For wires up to	Art.-Nr. Item No.
16 cm // 6 1/4"	W310-011
31 cm // 12 1/8"	W310-013

Implantat Kassetten Implant Cassettes

Aluminium-Behälter für Endoskope
Aluminium Cases for Endoscopes



250 x 65 x 65 mm	W303-001
320 x 75 x 55 mm	W303-003
400 x 150 x 50 mm	W303-005
500 x 200 x 50 mm	W303-007
640 x 140 x 60 mm	W303-009

Ganze Kasette in Farbe
Complete Cassette coloured

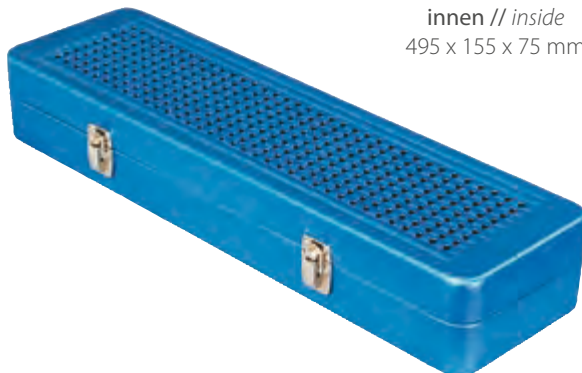

außen // outside
500 x 155 x 75 mm

innen // inside
495 x 155 x 75 mm

silber silver	W320-001
gelb yellow	W320-002
rot red	W320-003
blau blue	W320-004
grün green	W320-005

Nur Boden in Farbe
Only Bottom coloured



außen // outside
300 x 138 x 65 mm

innen // inside
295 x 138 x 65 mm

silber silver	W320-031
gelb yellow	W320-032
rot red	W320-033
blau blue	W320-034
grün green	W320-035

Container-System

Container-System

best-Sterilcontainer System ermöglichen eine systematische Organisation Ihres gesamten Sterilgutes. Die komfortable Handhabung und die Vielfalt unserer Container bietet Ihnen Sicherheit und Kontrolle in allen Anwendungsbereichen der Sterilgutversorgung. Lagerung, Transport und Entsorgung können mit unseren Containers perfekt organisiert werden. Unsere Sterilcontainer entsprechend den Anforderungen der Normen und Standards zur Sterilgutverpackung.

Die Container sind hergestellt aus eloxiertem Aluminium und zeichnen sich somit durch geringes Gewicht und gutes Trocknungsverhalten aus. Farbige Deckel und Kennzeichnungsschilder ermöglichen Ihnen eine genaue Kontrolle über Ihr Sterilgut. Durch unser umfangreiches Prgoramm bieten wir Ihnen eine genaue Anpassung an Ihre Bedürfnisse.

best-sterilisation container systems allow you a systematic organisation of your entire instrument sterilisation. The comfortable handling and diversity of our containers gives you safety and control for your instrument sterilisation. Storage, transportation and disposal are perfectly organised with our containers. Our sterilisation container systems are conform to the international standard requirements.

The containers are made of anodised aluminium, have minimum weight and excellent drying propertis. Colour-coded lids and identification labels enable you precise controll of your instruments sterilisation. Any changes or adjustments in your requirements are no problem due to our extensie range of products.

Verfügbar in 2 Modellen

Available in 2 models

Der Sicherheitsdeckel bietet zusätzlichen Schutz vor Kontaminierung bei Transport und Lagerung. Filter-, und Sicherheitsdeckel lassen sich nur bei geöffnetem Behälter trennen

The safety lid protects against contamination during transportation and storage. The filer- and safetylid can only be separated by complete opening of the container.

Standard Modell
Basic Model















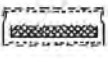

Sicherheitsmodell
Safety Model



Container-System Container-System

Suitability of our sterile containers for steam sterilization procedures¹⁾ as per DIN 58953, part 9 (issue May 1987)

Sterilization container	Packing		Steam sterilization procedure acc.to DIN 58946, part I				
	Description	Symbolic representation and packing system	Gravitation procedure	Pre - vacuum procedure	Fractional vacuum procedure	Fractional flow procedure	Steam injection procedure
with filters (StB - F)	Textiles in sterilization container with filter in lid and bottom acc.to DIN 58952 part I		+	+	+	+	+
			0	0	+	+	+
	Textiles in sterilization container with filter in lid, bottom not perforated acc.to DIN 58952 part I		-	-	+	+	+
			-	-	+	+	0
	Textiles in sterilization container with filter in bottom lid, not perforated acc.to DIN 58952 part I		0	+	+	+	+
			-	0	+	+	+
	Instruments in wire basket acc.to DIN 58952 part III in sterilization container with filter in lid and bottom acc. to DIN 58952 part I		+ ³⁾	+	+	+	+
	Instruments in wire basket acc.to DIN 58952 part III, in sterilization container with filter in lid and bottom not perforated acc. to DIN 58952 part I		-	+ ²⁾	+ ²⁾	+ ²⁾	+ ²⁾
	Instruments in wire basket acc.to DIN 58952 part III, in sterilization container with filter in bottom acc. to DIN 58952 part I		0	+	+	+	+
	with valves (StB - V)	Textiles in sterilization container with valves in lid bottom acc. to DIN 58952 part I		-	0	+	+
			-	-	+	+	0
Textiles in sterilization container with valves in lid no valves on the bottom			-	-	+	+	-
			-	-	+	+	-
Instruments in wire basket in sterilization container with valve in lid and bottom			-	+ ²⁾	+ ²⁾	+ ²⁾	+ ²⁾
Instruments in wire basket in sterilization container with valve in lid and not perforated			-	+ ²⁾	+ ²⁾	+ ²⁾	+ ²⁾

Explanation of symbols : + applicable - not applicable 0 limited application

1) In order to avoid mistakes with regards to service, operation and/or when loading the sterilizer, please refer to table 1 for correct or wrong combination of sterilization containers for standardized steam sterilization procedures.

2) Only sterilization containers guaranteeing evaporation or discharge of condensate are suitable above.

3) Gravitation procedures having no drying device do not guarantee a sufficient after - drying effect.

Container-System, Alu, mit farbigen Deckeln
Container System, Alu, with coloured lids

System 1/2



285 x 280 mm



silber
silver
gelb
yellow
rot
red
blau
blue
grün
green
schwarz
black

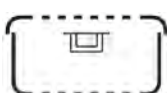
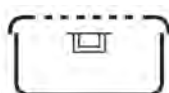

	Höhe Height	Wanne ungelocht Bottom non-perforated	Wanne gelocht Bottom perforated
silber // silver	100 mm	W400-001	W400-101
gelb // yellow	100 mm	W400-002	W400-102
rot // red	100 mm	W400-003	W400-103
blau // blue	100 mm	W400-004	W400-104
grün // green	100 mm	W400-005	W400-105
schwarz // black	100 mm	W400-006	W400-106
silber // silver	135 mm	W400-011	W400-111
gelb // yellow	135 mm	W400-012	W400-112
rot // red	135 mm	W400-013	W400-113
blau // blue	135 mm	W400-014	W400-114
grün // green	135 mm	W400-015	W400-115
schwarz // black	135 mm	W400-016	W400-116
silber // silver	150 mm	W400-021	W400-121
gelb // yellow	150 mm	W400-022	W400-122
rot // red	150 mm	W400-023	W400-123
blau // blue	150 mm	W400-024	W400-124
grün // green	150 mm	W400-025	W400-125
schwarz // black	150 mm	W400-026	W400-126
silber // silver	200 mm	W400-031	W400-131
gelb // yellow	200 mm	W400-032	W400-132
rot // red	200 mm	W400-033	W400-133
blau // blue	200 mm	W400-034	W400-134
grün // green	200 mm	W400-035	W400-135
schwarz // black	200 mm	W400-036	W400-136
silber // silver	260 mm	W400-041	W400-141
gelb // yellow	260 mm	W400-041	W400-141
rot // red	260 mm	W400-043	W400-143
blau // blue	260 mm	W400-044	W400-144
grün // green	260 mm	W400-045	W400-145
schwarz // black	260 mm	W400-046	W400-146

Wanne allein, ungelocht
Bottom only, non-perforated



100 mm	W400-501
135 mm	W400-511
150 mm	W400-521
200 mm	W400-531
260 mm	W400-541

Wanne allein, gelocht
Bottom only, perforated

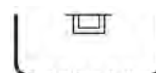

100 mm	W400-601
135 mm	W400-611
150 mm	W400-621
200 mm	W400-631
260 mm	W400-641

Container-System, Alu, mit farbigen Deckeln Container System, Alu, with coloured lids

System 1/2

Sicherheitsmodell, mit Sicherheitsdeckel
Safety Model, with safety Lids



285 x 280 mm

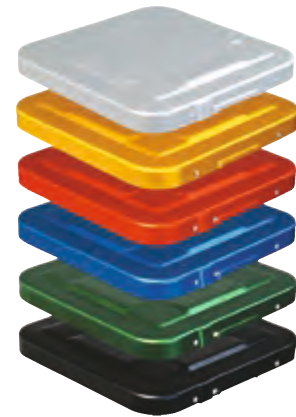

silber
silver

gelb
yellow

rot
red

blau
blue

grün
green

schwarz
black

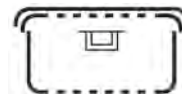
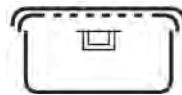

	Höhe Height	Wanne ungelocht Bottom non-perforated	Wanne gelocht Bottom perforated
silber // silver	110 mm	W400-201	W400-301
gelb // yellow	110 mm	W400-202	W400-302
rot // red	110 mm	W400-203	W400-303
blau // blue	110 mm	W400-204	W400-304
grün // green	110 mm	W400-205	W400-305
schwarz // black	110 mm	W400-206	W400-306
silber // silver	140 mm	W400-211	W400-311
gelb // yellow	140 mm	W400-212	W400-312
rot // red	140 mm	W400-213	W400-313
blau // blue	140 mm	W400-214	W400-314
grün // green	140 mm	W400-215	W400-315
schwarz // black	140 mm	W400-216	W400-316
silber // silver	155 mm	W400-221	W400-321
gelb // yellow	155 mm	W400-222	W400-322
rot // red	155 mm	W400-223	W400-323
blau // blue	155 mm	W400-224	W400-324
grün // green	155 mm	W400-225	W400-325
schwarz // black	155 mm	W400-226	W400-326
silber // silver	205 mm	W400-231	W400-331
gelb // yellow	205 mm	W400-232	W400-332
rot // red	205 mm	W400-233	W400-333
blau // blue	205 mm	W400-234	W400-334
grün // green	205 mm	W400-235	W400-335
schwarz // black	205 mm	W400-236	W400-336
silber // silver	265 mm	W400-241	W400-341
gelb // yellow	265 mm	W400-241	W400-341
rot // red	265 mm	W400-243	W400-343
blau // blue	265 mm	W400-244	W400-344
grün // green	265 mm	W400-245	W400-345
schwarz // black	265 mm	W400-246	W400-346

Container-System, Alu, mit farbigen Deckeln
Container System, Alu, with coloured lids

System 1/2

Deckel allein gelocht
Lids only, perforated



silber // silver	W400-801
gelb // yellow	W400-802
rot // red	W400-803
blau // blue	W400-804
grün // green	W400-805
schwarz // black	W400-806

Sicherheitsdeckel allein, ungelocht
Safety lid, non-perforated

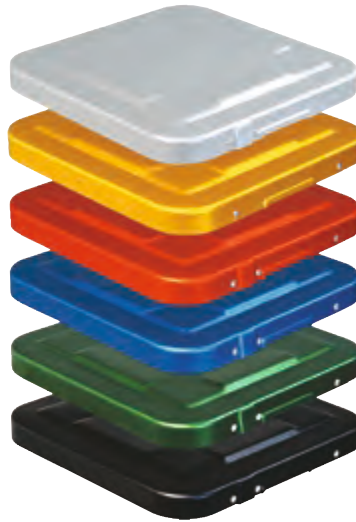

silber // silver	W400-811
gelb // yellow	W400-812
rot // red	W400-813
blau // blue	W400-814
grün // green	W400-815
schwarz // black	W400-816

Deckel allein, ungelocht
Lids only, non-perforated



silber // silver	W400-821
gelb // yellow	W400-822
rot // red	W400-823
blau // blue	W400-824
grün // green	W400-825
schwarz // black	W400-826

Siebkorb aus Edelstahlblech
Stainless Steel basket



	Ohne Deckel <i>Without Lid</i>	Mit Deckel <i>With Lid</i>
255 x 245 x 30 mm	W400-912	W400-922
255 x 245 x 50 mm	W400-913	W400-923
255 x 245 x 65 mm	W400-915	W400-925
255 x 245 x 100 mm	W400-917	W400-927

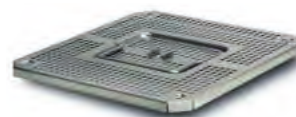

Deckel zu Siebkorb
Lid only

W400-930

Container-System Container-System

System 1/2

Drahtsiebkorb
Wire Basket



255 x 245 x 30 mm	W400-901
255 x 245 x 50 mm	W400-905
255 x 245 x 65 mm	W400-907
255 x 245 x 100 mm	W400-909

Siebschale Lochblech
Wire basket, stainless steel



240 x 258 x 50 mm	W400-955
270 x 265 x 50 mm	W400-956
240 x 240 x 80 mm	W400-957
240 x 240 x 100 mm	W400-958

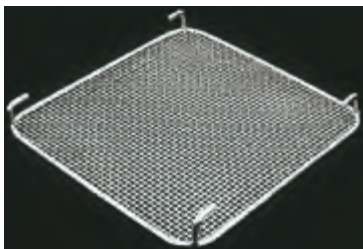

Zwischenboden
Wire Base

W400-965



Spannrahmen
Drape retainer

W400-970

Teiler
Divider



130 mm	W400-972
180 mm	W400-973
230 mm	W400-974

Silikonmatten
Silicone Mats

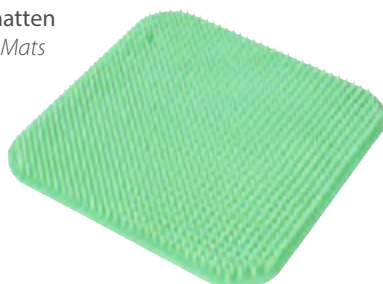

220 x 230 mm	W200-924
245 x 245 mm	W200-925

Container-System, Alu, mit farbigen Deckeln
Container System, Alu, with coloured lids

System 3/4



465 x 280 mm



- silber
silver
- gelb
yellow
- rot
red
- blau
blue
- grün
green
- schwarz
black



	Höhe <i>Height</i>	Wanne ungelocht <i>Bottom non-perforated</i>	Wanne gelocht <i>Bottom perforated</i>
silber // <i>silver</i>	100 mm	W401-001	W401-101
gelb // <i>yellow</i>	100 mm	W401-002	W401-102
rot // <i>red</i>	100 mm	W401-003	W401-103
blau // <i>blue</i>	100 mm	W401-004	W401-104
grün // <i>green</i>	100 mm	W401-005	W401-105
schwarz // <i>black</i>	100 mm	W401-006	W401-106
silber // <i>silver</i>	135 mm	W401-011	W401-111
gelb // <i>yellow</i>	135 mm	W401-012	W401-112
rot // <i>red</i>	135 mm	W401-013	W401-113
blau // <i>blue</i>	135 mm	W401-014	W401-114
grün // <i>green</i>	135 mm	W401-015	W401-115
schwarz // <i>black</i>	135 mm	W401-016	W401-116
silber // <i>silver</i>	150 mm	W401-021	W401-121
gelb // <i>yellow</i>	150 mm	W401-022	W401-122
rot // <i>red</i>	150 mm	W401-023	W401-123
blau // <i>blue</i>	150 mm	W401-024	W401-124
grün // <i>green</i>	150 mm	W401-025	W401-125
schwarz // <i>black</i>	150 mm	W401-026	W401-126

Wanne allein, ungelocht
Bottom only, non-perforated



465 x 280 x 105 mm	W401-501
465 x 280 x 135 mm	W401-511
465 x 280 x 150 mm	W401-521

Wanne allein, gelocht
Bottom only, perforated



465 x 280 x 105 mm	W401-601
465 x 280 x 135 mm	W401-611
465 x 280 x 150 mm	W401-621

Container-System, Alu, mit farbigen Deckeln Container System, Alu, with coloured lids

System 3/4

Sicherheitsmodell, mit Sicherheitsdeckel
Safety Model, with safety Lids



465 x 280 mm



silber
silver

gelb
yellow

rot
red

blau
blue

grün
green

schwarz
black

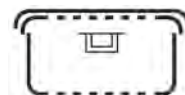
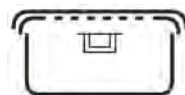

	Höhe Height	Wanne ungelocht Bottom non-perforated	Wanne gelocht Bottom perforated
silber // silver	110 mm	W401-201	W401-301
gelb // yellow	110 mm	W401-202	W401-302
rot // red	110 mm	W401-203	W401-303
blau // blue	110 mm	W401-204	W401-304
grün // green	110 mm	W401-205	W401-305
schwarz // black	110 mm	W401-206	W401-306
silber // silver	140 mm	W401-211	W401-311
gelb // yellow	140 mm	W401-212	W401-312
rot // red	140 mm	W401-213	W401-313
blau // blue	140 mm	W401-214	W401-314
grün // green	140 mm	W401-215	W401-315
schwarz // black	140 mm	W401-216	W401-316
silber // silver	155 mm	W401-221	W401-321
gelb // yellow	155 mm	W401-222	W401-322
rot // red	155 mm	W401-223	W401-323
blau // blue	155 mm	W401-224	W401-324
grün // green	155 mm	W401-225	W401-325
schwarz // black	155 mm	W401-226	W401-326

Container-System, Alu, mit farbigen Deckeln
Container System, Alu, with coloured lids

System 3/4

Deckel allein gelocht
Lids only, perforated



silber // silver	W401-801
gelb // yellow	W401-802
rot // red	W401-803
blau // blue	W401-804
grün // green	W401-805
schwarz // black	W401-806

Sicherheitsdeckel allein, ungelocht
Safety lid, non-perforated



silber // silver	W401-811
gelb // yellow	W401-812
rot // red	W401-813
blau // blue	W401-814
grün // green	W401-815
schwarz // black	W401-816

Siebkorb aus Edelstahlblech
Stainless Steel basket



	Ohne Deckel Without Lid	Mit Deckel With Lid
255 x 245 x 30 mm	W401-912	W401-922
255 x 245 x 50 mm	W401-913	W401-923
255 x 245 x 65 mm	W401-915	W401-925
255 x 245 x 100 mm	W401-917	W401-927



Deckel zu Siebkorb
Lid only

W401-930

Drahtsiebkorb
Wire Basket

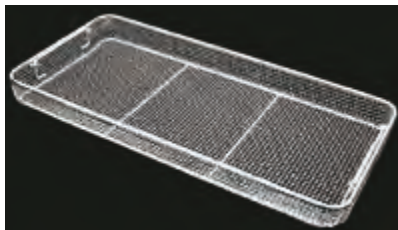

405 x 255 x 30 mm	W401-901
405 x 255 x 50 mm	W401-905
405 x 255 x 70 mm	W401-907
405 x 255 x 100 mm	W401-909

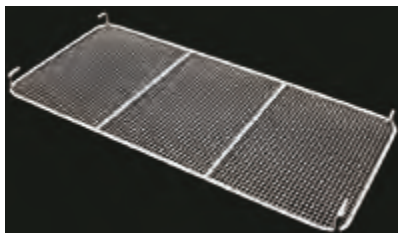

Zwischenboden
Wire Base

W401-965



Spannrahmen
Drape retainer

W401-970

Silikonmatten
Silicone Mats

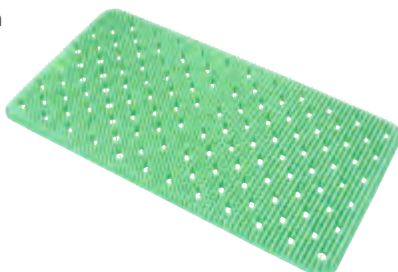

380 x 230 mm

W200-926

Container-System, Alu, mit farbigen Deckeln
Container System, Alu, with coloured lids

System 1/1



580 x 280 mm



- silber
silver
- gelb
yellow
- rot
red
- blau
blue
- grün
green
- schwarz
black

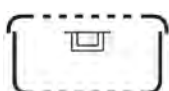
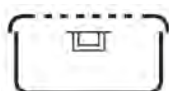

	Höhe <i>Height</i>	Wanne ungelocht <i>Bottom non-perforated</i>	Wanne gelocht <i>Bottom perforated</i>
silber // <i>silver</i>	100 mm	W402-001	W402-101
gelb // <i>yellow</i>	100 mm	W402-002	W402-102
rot // <i>red</i>	100 mm	W402-003	W402-103
blau // <i>blue</i>	100 mm	W402-004	W402-104
grün // <i>green</i>	100 mm	W402-005	W402-105
schwarz // <i>black</i>	100 mm	W402-006	W402-106
silber // <i>silver</i>	135 mm	W402-011	W402-111
gelb // <i>yellow</i>	135 mm	W402-012	W402-112
rot // <i>red</i>	135 mm	W402-013	W402-113
blau // <i>blue</i>	135 mm	W402-014	W402-114
grün // <i>green</i>	135 mm	W402-015	W402-115
schwarz // <i>black</i>	135 mm	W402-016	W402-116
silber // <i>silver</i>	150 mm	W402-021	W402-121
gelb // <i>yellow</i>	150 mm	W402-022	W402-122
rot // <i>red</i>	150 mm	W402-023	W402-123
blau // <i>blue</i>	150 mm	W402-024	W402-124
grün // <i>green</i>	150 mm	W402-025	W402-125
schwarz // <i>black</i>	150 mm	W402-026	W402-126
silber // <i>silver</i>	200 mm	W402-031	W402-131
gelb // <i>yellow</i>	200 mm	W402-032	W402-132
rot // <i>red</i>	200 mm	W402-033	W402-133
blau // <i>blue</i>	200 mm	W402-034	W402-134
grün // <i>green</i>	200 mm	W402-035	W402-135
schwarz // <i>black</i>	200 mm	W402-036	W402-136
silber // <i>silver</i>	260 mm	W402-041	W402-141
gelb // <i>yellow</i>	260 mm	W402-041	W402-141
rot // <i>red</i>	260 mm	W402-043	W402-143
blau // <i>blue</i>	260 mm	W402-044	W402-144
grün // <i>green</i>	260 mm	W402-045	W402-145
schwarz // <i>black</i>	260 mm	W402-046	W402-146

Wanne allein, ungelocht
Bottom only, non-perforated



100 mm	W402-501
135 mm	W402-511
150 mm	W402-521
200 mm	W402-531
260 mm	W402-541

Wanne allein, gelocht
Bottom only, perforated

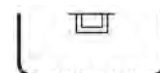

100 mm	W402-601
135 mm	W402-611
150 mm	W402-621
200 mm	W402-631
260 mm	W402-641

Container-System, Alu, mit farbigen Deckeln Container System, Alu, with coloured lids

System 1/1

Sicherheitsmodell, mit Sicherheitsdeckel
Safety Model, with safety Lids



580 x 280 mm

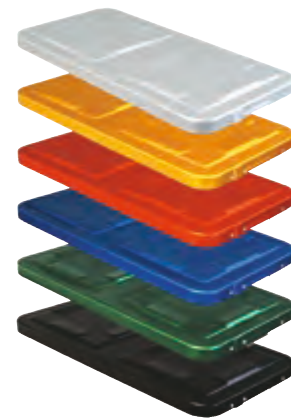

silber
silver

gelb
yellow

rot
red

blau
blue

grün
green

schwarz
black

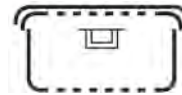
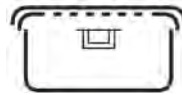

	Höhe Height	Wanne ungelocht Bottom non-perforated	Wanne gelocht Bottom perforated
silber // silver	100 mm	W402-201	W402-301
gelb // yellow	100 mm	W402-202	W402-302
rot // red	100 mm	W402-203	W402-303
blau // blue	100 mm	W402-204	W402-304
grün // green	100 mm	W402-205	W402-305
schwarz // black	100 mm	W402-206	W402-306
silber // silver	135 mm	W402-211	W402-311
gelb // yellow	135 mm	W402-212	W402-312
rot // red	135 mm	W402-213	W402-313
blau // blue	135 mm	W402-214	W402-314
grün // green	135 mm	W402-215	W402-315
schwarz // black	135 mm	W402-216	W402-316
silber // silver	150 mm	W402-221	W402-321
gelb // yellow	150 mm	W402-222	W402-322
rot // red	150 mm	W402-223	W402-323
blau // blue	150 mm	W402-224	W402-324
grün // green	150 mm	W402-225	W402-325
schwarz // black	150 mm	W402-226	W402-326
silber // silver	200 mm	W402-231	W402-331
gelb // yellow	200 mm	W402-232	W402-332
rot // red	200 mm	W402-233	W402-333
blau // blue	200 mm	W402-234	W402-334
grün // green	200 mm	W402-235	W402-335
schwarz // black	200 mm	W402-236	W402-336
silber // silver	260 mm	W402-241	W402-341
gelb // yellow	260 mm	W402-241	W402-341
rot // red	260 mm	W402-243	W402-343
blau // blue	260 mm	W402-244	W402-344
grün // green	260 mm	W402-245	W402-345
schwarz // black	260 mm	W402-246	W402-346

System 1/1

Deckel allein gelocht
Lids only, perforated



silber // silver	W402-801
gelb // yellow	W402-802
rot // red	W402-803
blau // blue	W402-804
grün // green	W402-805
schwarz // black	W402-806

Sicherheitsdeckel allein, ungelocht
Safety lid, non-perforated



silber // silver	W402-811
gelb // yellow	W402-812
rot // red	W402-813
blau // blue	W402-814
grün // green	W402-815
schwarz // black	W402-816

Deckel allein, ungelocht
Lids only, non-perforated

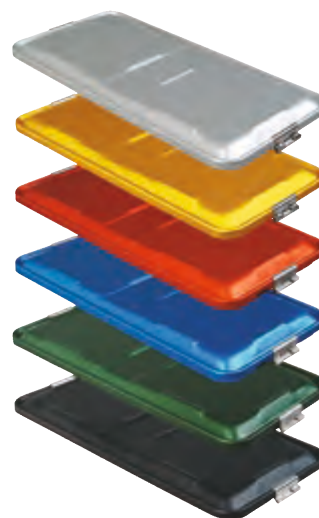

silber // silver	W402-821
gelb // yellow	W402-822
rot // red	W402-823
blau // blue	W402-824
grün // green	W402-825
schwarz // black	W402-826



Siebkorb aus Edelstahlblech
Stainless Steel basket



	Ohne Deckel <i>Without Lid</i>	Mit Deckel <i>With Lid</i>
485 x 255 x 30 mm	W402-911	W402-921
485 x 255 x 50 mm	W402-912	W402-922
485 x 255 x 70 mm	W402-913	W402-923
485 x 255 x 100 mm	W402-914	W402-924
545 x 255 x 30 mm	W402-916	W402-926
545 x 255 x 50 mm	W402-917	W402-927
545 x 255 x 70 mm	W402-918	W402-928
545 x 255 x 100 mm	W402-919	W402-929



Deckel zu Siebkorb
Lid only

485 x 255 mm	W402-930
545 x 255 mm	W402-931

Container-System Container-System

System 1/1

Drahtsiebkorb
Wire Basket

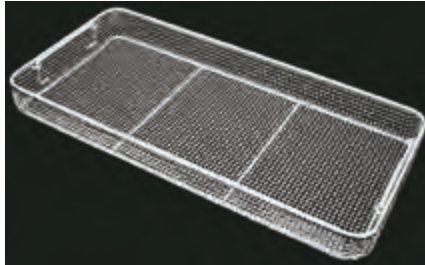

485 x 255 x 30 mm	W402-941
485 x 255 x 50 mm	W402-942
485 x 255 x 70 mm	W402-943
485 x 255 x 100 mm	W402-944
540 x 255 x 30 mm	W402-946
540 x 255 x 50 mm	W402-947
540 x 255 x 70 mm	W402-948
540 x 255 x 100 mm	W402-949

Siebschale Lochblech
Wire basket, stainless steel

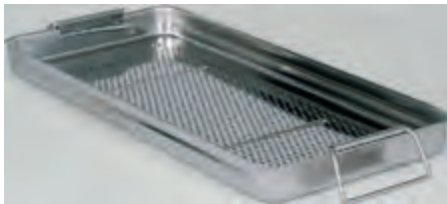

480 x 270 x 50 mm	W402-955
550 x 265 x 50 mm	W402-956
520 x 260 x 80 mm	W402-957
520 x 260 x 100 mm	W402-958

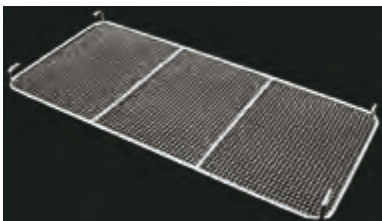

Zwischenboden
Wire Base

W402-965



Spannrahmen
Drape retainer

W402-970

Teiler
Divider



130 mm	W402-972
180 mm	W402-973
230 mm	W402-974

130 mm	W402-975
180 mm	W402-976
230 mm	W402-977

Silikonmatten
Silicone Mats



440 x 230 mm	W200-928
520 x 230 mm	W200-929

Entsorgungscontainer
Removal Container

Deckel und Boden ungelocht
Lid and Bottom non perforated



10 cm	15 cm
außen <i>outside</i>	außen <i>outside</i>
285 x 280 x 100 mm	285 x 280 x 150 mm
innen <i>inside</i>	innen <i>inside</i>
262 x 260 x 82 mm	262 x 260 x 132 mm
W400-701	W400-703

Deckel und Boden ungelocht
Lid and Bottom non perforated



15 cm
außen <i>outside</i>
580 x 280 x 150 mm
innen <i>inside</i>
548 x 258 x 130 mm
W402-703

Großraumcontainer Wide Body Container

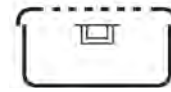

außen
outside
600 x 400 mm
innen
inside
550 x 350 mm

600 x 400 mm

	Höhe Height	Wanne ungelocht Bottom non-perforated	Wanne gelocht Bottom perforated
silber // silver	120 mm	W403-011	W403-111
gelb // yellow	120 mm	W403-012	W403-112
rot // red	120 mm	W403-013	W403-113
blau // blue	120 mm	W403-014	W403-114
grün // green	120 mm	W403-015	W403-115
schwarz // black	120 mm	W403-016	W403-116
silber // silver	180 mm	W403-031	W403-131
gelb // yellow	180 mm	W403-032	W403-132
rot // red	180 mm	W403-033	W403-133
blau // blue	180 mm	W403-034	W403-134
grün // green	180 mm	W403-035	W403-135
schwarz // black	180 mm	W403-036	W403-136

Wanne allein, ungelocht Bottom only, non-perforated



12 cm	18 cm
außen outside 600 x 400 mm	außen outside 600 x 400 mm
innen inside 550 x 350 mm	innen inside 550 x 350 mm
W403-511	W403-531

Deckel allein Lid only



silber // silver	W403-801
gelb // yellow	W403-802
rot // red	W403-803
blau // blue	W403-804
grün // green	W403-805
schwarz // black	W403-806

Wanne allein, gelocht Bottom only, perforated



12 cm	18 cm
außen outside 600 x 400 mm	außen outside 600 x 400 mm
innen inside 550 x 350 mm	innen inside 550 x 350 mm
W403-611	W403-631



470 x 337 x 51 mm	W403-903
533 x 337 x 100 mm	W403-905

Flachcontainer
Flat Container



285 x 280 mm

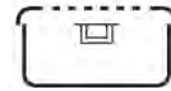

	Höhe Height	Wanne ungelocht Bottom non-perforated	Wanne gelocht Bottom perforated
silber // silver	55 mm	W405-001	W405-111
gelb // yellow	55 mm	W405-002	W405-112
rot // red	55 mm	W405-003	W405-113
blau // blue	55 mm	W405-004	W405-114
grün // green	55 mm	W405-005	W405-115
silber // silver	85 mm	W405-011	-
gelb // yellow	85 mm	W405-012	-
rot // red	85 mm	W405-013	-
blau // blue	85 mm	W405-014	-
grün // green	85 mm	W405-015	-

Wanne allein, ungelocht
Bottom only, non-perforated



285 x 280 x 55 mm | **W405-501**

285 x 280 x 85 mm | **W405-511**

Deckel allein
Lid only

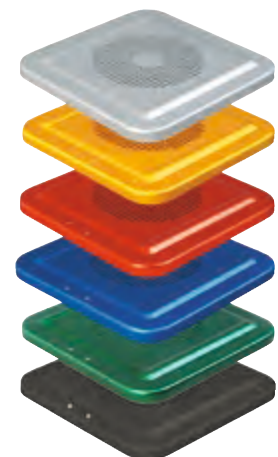

Wanne allein, gelocht
Bottom only, perforated



285 x 280 x 55 mm

W405-611

silber // silver	W405-801
gelb // yellow	W405-802
rot // red	W405-803
blau // blue	W405-804
grün // green	W405-805

Mini-Container Mini Container



	Höhe Height	Wanne ungelocht Bottom non-perforated	Wanne gelocht Bottom perforated
silber // silver	40 mm	W407-001	W407-101
gelb // yellow	40 mm	W407-002	W407-102
rot // red	40 mm	W407-003	W407-103
blau // blue	40 mm	W407-004	W407-104
grün // green	40 mm	W407-005	W407-105
silber // silver	70 mm	W407-011	W407-111
gelb // yellow	70 mm	W407-012	W407-112
rot // red	70 mm	W407-013	W407-113
blau // blue	70 mm	W407-014	W407-114
grün // green	70 mm	W407-015	W407-115
silber // silver	100 mm	W407-021	W407-121
gelb // yellow	100 mm	W407-022	W407-122
rot // red	100 mm	W407-023	W407-123
blau // blue	100 mm	W407-024	W407-124
grün // green	100 mm	W407-025	W407-125

Wanne allein, ungelocht
Bottom only, non-perforated



300 x 140 x 40 mm	W407-501
300 x 140 x 70 mm	W407-511
300 x 140 x 100 mm	W407-521

Wanne allein, gelocht
Bottom only, perforated



300 x 140 x 40 mm	W407-601
300 x 140 x 70 mm	W407-611
300 x 140 x 100 mm	W407-621

Deckel allein
Lid only



silber // silver	W407-801
gelb // yellow	W407-802
rot // red	W407-803
blau // blue	W407-804
grün // green	W407-805



Drahtsiebkorb
Wire basket
265 x 120 x 45 mm

W407-901



Siebkorb mit Deckel
Basket with lid

W407-921

Siebkorb ohne Deckel
Basket without lid

W407-911



Spannrahmen
Drape retainer

W407-970

Silikonmatten
Silicone Mats

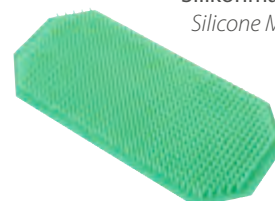

270 x 125 mm

W200-921

Filter
Filters



Einmal-Papierfilter 100 St./Packung
Disposable Paper Filters 100 pcs./Package

W420-001



Textilfilter, wiederverwendbar
Textile filter, reusable

W420-003



Teflonfilter, wiederverwendbar 1 St./Packung
Teflon filter, reusable 1 pc./Package

W420-005

Filter für Minicontainer
Filter for Mini-Containers



Einmal-Papierfilter 100 St./Packung
Disposable Paper Filters 100 pcs./Package

W420-011

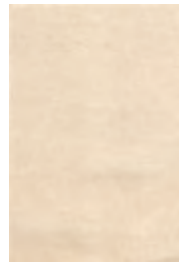

Textilfilter, wiederverwendbar
Textile filter, reusable

W420-013

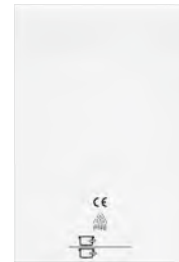

Teflonfilter, wiederverwendbar 1 St./Packung
Teflon filter, reusable 1 pc./Package

W420-015



Filterhalterung
Filter Tray

W420-051



Filterhalterung für Mini-Container
Filter Tray for Mini-Containers

W420-053

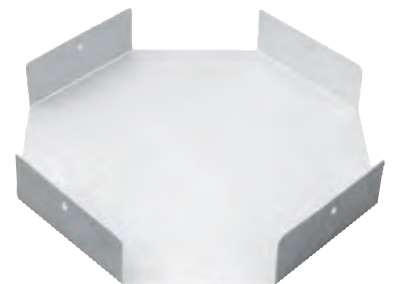

Spender für Einmalfilter
Filter Dispenser

W420-060

Indikatoretiketten Indikator Paper Labels



100 St./Packung
100 pcs./Package

W420-100

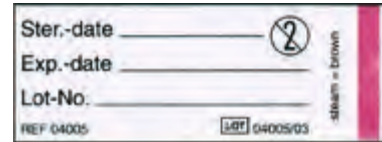

Für Mini-Container 100 St./Packung
For Mini-Containers 100 pcs./Package

W420-101



Verschlussplombe 1000 St./Packung
Plastic Seal 1000 pcs./Package

W420-120



Fixierklammer
Fixation clamp

W420-130



Karabinerhaken
Karabiner hook

W420-132

Kennzeichnungsschilder Identification labels

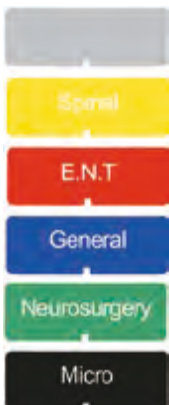

	Ohne Gravur Without engraving	Mit Gravur With engraving
silber // silver	W420-151	W420-161
gelb // yellow	W420-152	W420-162
rot // red	W420-153	W420-163
blau // blue	W420-154	W420-164
grün // green	W420-155	W420-165
schwarz // black	W420-156	W420-166



Sortiermagazin für Kennzeichnungsschilder
Dispenser for Tags

W420-150

Einschlagtücher
Drapes

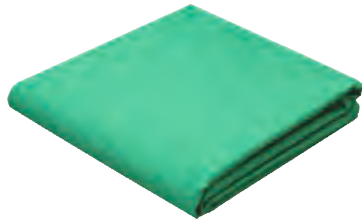

Für Container <i>For Container</i>		Art.-Nr. <i>Item No.</i>
Mini	60 x 40 cm	W425-001
Mini	65 x 65 cm	W425-003
Mini	85 x 85 cm	W425-005
1/2. Flach // Flat	90 x 60 cm	W425-007
1/2. Flach // Flat	90 x 80 cm	W425-009
1/2. Flach // Flat	130 x 45 cm	W425-011
1/1. 1/2.	130 x 60 cm	W425-013
1/1. 3/4.	140 x 100 cm	W425-015
1/1.	185 x 45 cm	W425-017
1/1.	185 x 60 cm	W425-019



Haltstift für Instrumente
Holding Pin for Instruments

W420-301



Haltstift für Trennbleche
Holding Pin for Partition

W420-302



Trennbleche
Partition sheets



50 x 20 mm	W420-312
130 x 20 mm	W420-313
225 x 20 mm	W420-314
460 x 20 mm	W420-315

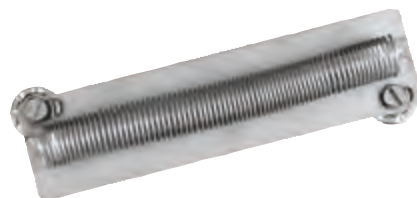

Spiralfeder
Spiral holder

W420-420



Doppelte Spiralfeder
Double spiral holder

W420-421

Diverse Schalen, Behälter Various Trays and bowls

Nierenschalen
Kidney bowls



170 x 36 mm	W800-01
250 x 32 mm	W800-02
754 x 45 mm	W800-03



Stechbecken (US-Form)
Bed pan (US-Form)

W805-12

Stechbecken
Bedpan



235 mm	W805-21
310 mm	W805-22

Medizinbecher
Medicine Cups



25 cc	W810-01
50 cc	W810-02
100 cc	W810-03
250 cc	W810-04

Meßbecher
Measuring jugs



0,25l	W821-01
0,5l	W821-02
1,0l	W821-03
1,5l	W821-04
2,0l	W821-05

Irrigatoren
Irrigators



1,0l	W825-01
1,5l	W825-02
2,0l	W825-03

Diverse Schalen, Behälter
Various Trays and bowls



	Wattespender Cotton dispensers
85 x 85 mm	W827-01
100 x 100 mm	W827-02
120 x 120 mm	W827-03
150 x 150 mm	W827-04



Sputumbecher
Sputum Cup
8,5 cm // 3 1/4"
ø 8 cm
W828-01



	Standzylinder Jars
30 x 95 mm	W838-01
50 x 105 mm	W838-03
50 x 135 mm	W838-05
50 x 180 mm	W838-07
80 x 135 mm	W838-09
80 x 175 mm	W838-11
95 x 205 mm	W838-13



	Schalen Bowls
40 x 19 mm	W850-01
61 x 30 mm	W850-03
80 x 40 mm	W850-05
116 x 50 mm	W850-07
128 x 55 mm	W850-09
147 x 65 mm	W850-11
167 x 75 mm	W850-13
187 x 85 mm	W850-15

	Volumen capacity	Art.-Nr. Item No.
15 x 7,5 cm	0,75 l	W850-41
16 x 7,5 cm	1,0 l	W850-42
22 x 7,5 cm	2,0 l	W850-43
24 x 9,5 cm	3,0 l	W850-44
26 x 12 cm	4,5 l	W850-45
30 x 12 cm	6,0 l	W850-46
32 x 14 cm	8,0 l	W850-47
38 x 13 cm	11,0 l	W850-48
40 x 15,5 cm	14,0 l	W850-49

	Durchm. ø Diameter	Volumen capacity	Höhe height	Laborschalen Laboratory bowl
B 1	4 cm	0,02 l	1,9 cm	W850-61
B 2	6 cm	0,06 l	3,0 cm	W850-62
B 4	8,5 cm	0,16 l	4,0 cm	W850-63
B 6	11 cm	0,4 l	5,5 cm	W850-64
B 8	15 cm	1,0 l	7,5 cm	W850-65
B 10	21 cm	2,0 l	9,0 cm	W850-66

Instrumentenablageplatten Instrument trays



210 x 160 x 10 mm	W852-01
240 x 180 x 10 mm	W852-02
310 x 150 x 10 mm	W852-04
310 x 210 x 10 mm	W852-05
350 x 240 x 10 mm	W852-07
400 x 270 x 20 mm	W852-09
420 x 280 x 10 mm	W852-11

Verbandstoffschalen Dressing trays

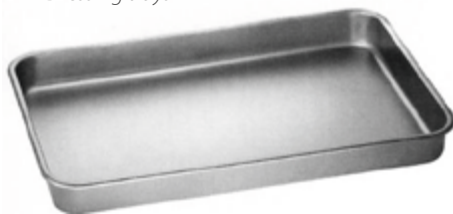

35 x 25 x 5 cm	W852-11
45 x 30 x 5 cm	W852-12
55 x 35 x 5 cm	W852-13
65 x 40 x 5 cm	W852-14



19 x 12 x 4 cm	W852-31
24 x 17 x 4 cm	W852-32
30 x 20,5 x 5,5 cm	W852-33



Schale bowl

235 x 190 x 40 mm
W852-41

Instrumentenschalen mit Deckel Instrument trays with lid



Länge Length	Breite Width	Höhe Height	
12 cm	8 cm	4 cm	W852-61
16 cm	10 cm	3 cm	W852-62
18 cm	12 cm	5 cm	W852-63
20 cm	10 cm	5 cm	W852-64
22 cm	15 cm	5 cm	W852-65
26 cm	15 cm	5 cm	W852-66
30 cm	20 cm	5 cm	W852-67
40 cm	20 cm	8 cm	W852-68
50 cm	27 cm	7 cm	W852-69

Nadeldosen
Needle Cases



Innendose allein
Insert only

W880-11

Nadeldose
Needle Case
65 x 16 mm

W880-01

Nadeldosen
Needle Cases

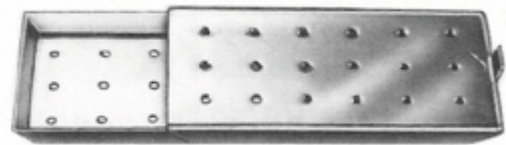

50 x 25 x 4,5 mm

W881-01

65 x 42 x 8 mm

W881-02

75 x 25 x 4,5 mm

W881-03



150 x 95 x 13 mm

W881-41

Kunststoffbehälter für Endoskope Plastic Container for Endoscopes



W350-010	270 x 70 x 35 mm (für 1 Endoskop)
W350-011	270 x 70 x 35 mm (für 2 Endoskope)
W350-015	270 x 160 x 35 mm (für 2 Endoskope)
W350-030	394 x 70 x 35 mm (für 1 Endoskop)
W350-031	394 x 70 x 35 mm (für 2 Endoskope)
W350-050	457 x 70 x 35 mm (für 1 Endoskop)
W350-051	457 x 70 x 35 mm (für 2 Endoskope)
W350-061	465 x 212 x 51 mm (für 3 Endoskope + Lichtleiter // <i>Light Cable</i>)

Kunststoffbehälter für Endoskopie-Instrumente Plastic Container for Instruments



W350-501	48 x 20 x 13 cm	Für 12 Instrumente bis 33 cm <i>For 12 Instruments up to 33 cm</i>
W350-502	63 x 30 x 14 cm	Für 16 Instrumente bis 45 cm <i>For 16 Instruments up to 45 cm</i>
W350-511	53 x 25 x 18 cm	Für 10 Instrumente bis 33 cm und Zubehör <i>For 10 Instruments up to 33 cm + Accessories</i>
W350-512	66 x 24 x 18 cm	Für 10 Instrumente bis 45 cm und Zubehör <i>For 10 Instruments up to 45 cm + Accessories</i>

Kunststoffbehälter mit Noppenmappe Plastic Case with Silicone mats



W352-005	190 x 102 x 19 mm
W352-009	267 x 159 x 16 mm
W352-010	267 x 159 x 35 mm

Index Art.-Nr. Index Item No.

Art.-Nr. Item No.	Seite Page	Art.-Nr. Item No.	Seite Page	Art.-Nr. Item No.	Seite Page	Art.-Nr. Item No.	Seite Page	Art.-Nr. Item No.	Seite Page
A100-18	A02	A350-05	A09	A370-54	A12	B109-15	B05	B155-12	B09
A102-16	A02	A350-06	A09	A370-95	A12	B109-18	B05	B157-08	B09
A102-20	A02	A350-07	A09	A372-00	A13	B109-20	B05	B159-09	B09
A104-20	A02	A350-08	A09	A372-01	A13	B109-21	B05	B180-00	B10
A105-20	A02	A350-21	A09	A372-02	A13	B109-25	B05	B180-11	B10
A106-20	A02	A350-22	A09	A372-03	A13	B110-61	B05	B180-12	B10
A107-24	A02	A350-23	A09	A372-04	A13	B110-62	B05	B181-00	B10
A108-24	A02	A350-35	A09	A372-53	A13	B110-62S	B05	B181-11	B10
A109-24	A02	A350-38	A09	A372-54	A13	B110-64	B05	B182-00	B10
A110-00	A02	A352-01	A09	A372-55	A13	B110-65	B05	B182-11	B10
A112-00	A02	A352-02	A09	A375-02	A13	B110-67	B05	B182-11	B10
A114-15	A03	A352-11	A09	A375-03	A13	B110-69	B05	B182-11	B10
A115-18	A03	A352-12	A09	A376-01	A13	B115-01	B06	B184-00	B10
A150-01	A03	A358-01	A10	A376-02	A13	B115-02	B06	B186-00	B10
A150-02	A03	A358-02	A10	A376-03	A13	B115-03	B06	B200-01	B11
A195-00	A03	A358-03	A10	A650-01	A14	B115-04	B06	B200-02	B11
A200-10	A03	A358-10	A10	A650-03	A14	B115-05	B06	B200-03	B11
A200-15	A03	A358-41	A10	A650-05	A14	B115-06	B06	B202-01	B11
A200-20	A03	A358-45	A10	A650-21	A14	B115-07	B06	B202-02	B11
A200-30	A03	A358-45	A10	A650-91	A14	B115-08	B06	B204-01	B11
A200-50	A03	A360-00	A11	B100-30	B02	B115-09	B06	B205-01	B11
A201-50	A03	A360-01	A11	B100-31	B02	B115-10	B06	B205-02	B11
A205-00	A03	A360-02	A11	B100-32	B02	B118-01	B06	B206-01	B11
A210-00	A04	A360-03	A11	B100-33	B02	B118-02	B06	B208-20	B11
A212-01	A04	A360-04	A11	B100-39	B03	B122-01	B06	B215-13	B11
A217-00	A04	A360-05	A11	B100-40	B03	B125-00	B07	B215-18	B11
A218-00	A04	A360-53	A11	B100-41	B03	B125-09	B07	B217-20	B11
A220-00	A04	A360-54	A11	B100-42	B03	B126-09	B07	B250-00	B12
A222-00	A04	A360-95	A11	B100-43	B03	B128-13	B07	B252-00	B12
A224-00	A04	A360-96	A11	B100-50	B02	B129-13	B07	B252-51	B12
A226-00	A05	A362-00	A11	B100-51	B02	B130-12	B07	B254-27	B12
A243-00	A05	A362-01	A11	B100-70	B02	B132-11	B07	B254-30	B12
A250-00	A06	A362-02	A11	B100-71	B02	B134-12	B07	B256-00	B12
A250-11	A06	A362-03	A11	B100-80	B02	B135-18	B07	B256-51	B12
A250-51	A06	A362-04	A11	B100-83	B02	B140-13	B08	B256-52	B12
A250-55	A06	A362-53	A11	B100-90	B03	B140-16	B08	B258-00	B12
A251-00	A06	A362-54	A11	B105-10	B04	B140-19	B08	B258-51	B12
A252-00	A06	A364-00	A11	B105-11	B04	B140-22	B08	B258-52	B12
A252-11	A06	A364-01	A11	B105-12	B04	B141-17	B08	B258-53	B12
A255-00	A06	A364-02	A11	B105-13	B04	B141-20	B08	B300-11	B13
A258-00	A07	A364-03	A11	B105-15	B04	B142-16	B08	B300-13	B13
A260-00	A07	A364-04	A11	B105-18	B04	B142-19	B08	B300-14	B13
A260-11	A07	A364-54	A11	B105-19	B04	B142-22	B08	B300-16	B13
A265-01	A07	A364-55	A11	B105-20	B04	B144-12	B08	B300-18	B13
A266-01	A08	A368-01	A12	B105-21	B04	B146-09	B08	B300-20	B13
A266-02	A08	A368-03	A12	B105-22	B04	B150-01	B08	B300-25	B13
A270-01	A08	A368-10	A12	B105-23	B04	B150-02	B08	B301-11	B13
A270-02	A08	A370-00	A12	B105-24	B04	B152-16	B09	B301-13	B13
A270-11	A08	A370-01	A12	B105-25	B04	B152-20	B09	B301-14	B13
A350-01	A09	A370-02	A12	B108-10	B05	B152-24	B09	B301-16	B13
A350-02	A09	A370-03	A12	B108-13	B05	B153-11	B09	B301-18	B13
A350-03	A09	A370-04	A12	B108-15	B05	B153-14	B09	B301-20	B13
A350-04	A09	A370-53	A12	B109-13	B05	B153-17	B09	B301-25	B13

Index Art.-Nr. Index Item No.

Art.-Nr. Item No.	Seite Page	Art.-Nr. Item No.	Seite Page	Art.-Nr. Item No.	Seite Page	Art.-Nr. Item No.	Seite Page	Art.-Nr. Item No.	Seite Page
B302-11	B13	B355-14	B15	B444-15	B18	B524-17	B22	B590-04	B25
B302-13	B13	B355-16	B15	B444-20	B18	B524-51	B22	B590-05	B25
B302-14	B13	B362-18	B15	B444-25	B18	B525-17	B22	B590-06	B25
B302-16	B13	B370-38	B15	B444-30	B18	B525-51	B22	B590-11	B25
B302-18	B13	B371-38	B15	B444-35	B18	B528-00	B22	B590-12	B25
B302-20	B13	B400-00	B16	B444-40	B18	B528-01	B22	B590-13	B25
B302-25	B13	B400-10	B16	B444-45	B18	B528-02	B22	B590-14	B25
B306-11	B13	B400-11	B16	B444-50	B18	B528-03	B22	B590-15	B25
B306-13	B13	B400-12	B16	B445-10	B18	B530-13	B22	B590-16	B25
B306-14	B13	B400-23	B16	B445-15	B18	B532-13	B22	B590-21	B25
B306-16	B13	B400-26	B16	B445-20	B18	B535-11	B23	B590-22	B25
B306-18	B13	B400-29	B16	B445-25	B18	B535-13	B23	B590-23	B25
B306-20	B13	B400-32	B16	B445-30	B18	B536-14	B23	B590-24	B25
B310-11	B13	B400-35	B16	B445-35	B18	B537-14	B23	B590-25	B25
B310-13	B13	B405-06	B16	B445-40	B18	B538-14	B23	B590-26	B25
B310-14	B13	B405-09	B16	B445-45	B18	B540-11	B23	B600-30	B25
B310-16	B13	B405-12	B16	B445-50	B18	B540-13	B23	B600-35	B25
B310-18	B13	B405-15	B16	B470-01	B18	B540-15	B23	B600-40	B25
B310-20	B13	B406-00	B16	B470-02	B18	B547-15	B23	B600-45	B25
B311-14	B13	B406-02	B16	B470-03	B18	B550-10	B23	B600-50	B25
B312-13	B13	B406-03	B16	B470-04	B18	B560-00	B23	B600-55	B25
B312-14	B13	B406-04	B16	B470-05	B18	B561-10	B23	B600-60	B25
B312-16	B13	B406-06	B16	B480-02	B19	B562-16	B23	B600-65	B25
B312-18	B13	B406-07	B16	B480-03	B19	B570-10	B24	B600-83	B25
B313-16	B13	B406-08	B16	B480-04	B19	B571-01	B24	B600-90	B25
B314-18	B13	B406-10	B16	B480-05	B19	B571-02	B24	B600-91	B25
B316-13	B13	B406-12	B16	B481-30	B19	B572-01	B24	B611-03	B26
B316-14	B13	B406-14	B16	B481-50	B19	B572-02	B24	B611-04	B26
B316-16	B13	B410-03	B17	B482-50	B19	B574-14	B24	B612-40	B26
B316-20	B13	B410-04	B17	B490-01	B19	B577-01	B24	B612-46	B26
B318-10	B13	B410-05	B17	B490-02	B19	B577-02	B24	B612-55	B26
B321-18	B13	B410-06	B17	B490-03	B19	B577-03	B24	B612-65	B26
B326-01	B14	B411-14	B17	B492-23	B19	B578-03	B24	B614-00	B26
B326-02	B14	B411-24	B17	B500-02	B20	B578-04	B24	B615-00	B26
B326-03	B14	B412-01	B17	B500-03	B20	B578-05	B24	B617-03	B26
B326-04	B14	B412-02	B17	B500-04	B20	B578-06	B24	B617-04	B26
B327-01	B14	B412-03	B17	B500-05	B20	B580-00	B24	B617-05	B26
B327-02	B14	B412-04	B17	B502-15	B20	B580-02	B24	B620-16	B26
B327-03	B14	B412-05	B17	B502-19	B20	B580-03	B24	B620-16	B27
B330-13	B14	B412-06	B17	B502-24	B20	B580-04	B24	B620-19	B26
B330-14	B14	B441-05	B18	B503-15	B20	B580-05	B24	B622-19	B26
B340-22	B15	B441-10	B18	B503-19	B20	B580-06	B24	B625-02	B27
B342-23	B15	B441-15	B18	B503-24	B20	B580-07	B24	B625-04	B27
B343-28	B15	B441-20	B18	B505-16	B20	B580-08	B24	B625-05	B27
B346-12	B15	B441-25	B18	B508-20	B20	B582-01	B24	B625-14	B27
B350-12	B15	B441-30	B18	B511-15	B20	B582-02	B24	B625-15	B27
B350-16	B15	B441-35	B18	B512-01	B20	B582-03	B24	B630-01	B27
B351-18	B15	B441-40	B18	B512-02	B20	B582-04	B24	B630-02	B27
B352-12	B15	B441-45	B18	B514-11	B21	B582-05	B24	B648-00	B28
B352-16	B15	B441-50	B18	B516-01	B21	B582-06	B24	B648-52	B28
B352-18	B15	B441-70	B18	B516-02	B21	B590-01	B25	B650-01	B28
B354-14	B15	B441-90	B18	B520-01	B21	B590-02	B25	B650-02	B28
B354-16	B15	B444-10	B18	B520-02	B21	B590-03	B25	B650-05	B28

Index Art.-Nr. Index Item No.

Art.-Nr. Item No.	Seite Page	Art.-Nr. Item No.	Seite Page	Art.-Nr. Item No.	Seite Page	Art.-Nr. Item No.	Seite Page	Art.-Nr. Item No.	Seite Page
B650-51	B28	B731-11	B32	B756-05	B34	B818-211	B37	B825-408	B38
B650-52	B28	B731-12	B32	B756-07	B34	B818-305	B37	B825-409	B38
B652-00	B28	B731-13	B32	B756-09	B34	B818-306	B37	B825-410	B38
B654-00	B28	B734-01	B32	B757-03	B34	B818-308	B37	B825-411	B38
B654-52	B28	B734-02	B32	B757-04	B34	B818-311	B37	B825-412	B38
B662-01	B29	B734-03	B32	B757-06	B34	B818-314	B37	B825-415	B38
B662-02	B29	B734-04	B32	B757-08	B34	B818-405	B37	B825-605	B38
B662-03	B29	B734-11	B32	B757-10	B34	B818-406	B37	B825-606	B38
B662-04	B29	B734-12	B32	B757-12	B34	B818-408	B37	B825-607	B38
B662-05	B29	B734-13	B32	B757-15	B34	B818-411	B37	B825-608	B38
B665-01	B29	B734-14	B32	B758-01	B34	B820-306	B37	B825-609	B38
B665-02	B29	B736-00	B32	B758-02	B34	B820-307	B37	B825-610	B38
B670-20	B29	B740-01	B32	B758-03	B34	B820-308	B37	B825-611	B38
B671-01	B29	B740-02	B32	B758-11	B34	B820-309	B37	B825-612	B38
B671-02	B29	B740-03	B32	B758-12	B34	B820-310	B37	B825-615	B38
B674-01	B30	B750-01	B33	B758-13	B34	B820-311	B37	B825-806	B38
B674-02	B30	B750-02	B33	B760-15	B35	B820-312	B37	B825-807	B38
B700-00	B30	B750-05	B33	B760-20	B35	B822-106	B38	B825-808	B38
B701-01	B30	B750-06	B33	B767-01	B35	B822-108	B38	B825-809	B38
B701-02	B30	B751-05	B33	B767-02	B35	B822-110	B38	B825-810	B38
B701-03	B30	B751-07	B33	B767-03	B35	B822-112	B38	B825-811	B38
B701-04	B30	B751-08	B33	B770-01	B35	B822-115	B38	B825-812	B38
B701-05	B30	B751-09	B33	B770-02	B35	B825-105	B38	B825-815	B38
B701-06	B30	B751-10	B33	B770-03	B35	B825-106	B38	B828-06	B39
B701-07	B30	B751-12	B33	B770-14	B35	B825-107	B38	B828-08	B39
B701-08	B30	B751-14	B33	B770-15	B35	B825-108	B38	B828-10	B39
B701-21	B30	B751-15	B33	B770-17	B35	B825-109	B38	B828-12	B39
B701-22	B30	B751-18	B33	B770-19	B35	B825-110	B38	B828-15	B39
B703-01	B30	B751-20	B33	B770-25	B35	B825-111	B38	B835-106	B39
B703-02	B30	B751-25	B33	B770-26	B35	B825-112	B38	B835-107	B39
B703-03	B30	B751-30	B33	B770-38	B35	B825-113	B38	B835-108	B39
B703-04	B30	B751-53	B33	B772-17	B36	B825-205	B38	B835-109	B39
B706-00	B30	B751-55	B33	B785-01	B36	B825-206	B38	B835-110	B39
B710-01	B30	B751-56	B33	B785-02	B36	B825-207	B38	B835-111	B39
B710-02	B30	B751-59	B33	B785-03	B36	B825-208	B38	B835-112	B39
B710-03	B30	B752-05	B33	B785-04	B36	B825-209	B38	B835-115	B39
B710-04	B30	B752-07	B33	B785-05	B36	B825-210	B38	B839-06	B39
B710-05	B30	B752-08	B33	B785-06	B36	B825-211	B38	B839-08	B39
B710-06	B30	B752-09	B33	B806-03	B36	B825-212	B38	B839-12	B39
B710-07	B30	B752-10	B33	B812-05	B36	B825-213	B38	B839-15	B39
B724-01	B31	B752-12	B33	B812-06	B36	B825-215	B38	B840-03	B40
B724-02	B31	B752-14	B33	B812-08	B36	B825-305	B38	B840-04	B40
B724-03	B31	B752-15	B33	B812-09	B36	B825-306	B38	B840-05	B40
B724-04	B31	B752-18	B33	B813-01	B36	B825-307	B38	B840-06	B40
B724-05	B31	B752-20	B33	B813-02	B36	B825-308	B38	B840-07	B40
B724-06	B31	B752-25	B33	B813-03	B36	B825-309	B38	B840-08	B40
B725-01	B31	B752-30	B33	B818-105	B37	B825-310	B38	B840-09	B40
B725-02	B31	B754-00	B34	B818-106	B37	B825-311	B38	B840-10	B40
B727-00	B31	B754-05	B34	B818-108	B37	B825-312	B38	B840-11	B40
B730-18	B32	B754-07	B34	B818-111	B37	B825-315	B38	B840-12	B40
B731-01	B32	B754-09	B34	B818-205	B37	B825-405	B38	B840-14	B40
B731-02	B32	B754-12	B34	B818-206	B37	B825-406	B38	B840-15	B40
B731-03	B32	B755-00	B34	B818-208	B37	B825-407	B38	B841-103	B40

Index Art.-Nr. Index Item No.

Art.-Nr. Item No.	Seite Page	Art.-Nr. Item No.	Seite Page	Art.-Nr. Item No.	Seite Page	Art.-Nr. Item No.	Seite Page	Art.-Nr. Item No.	Seite Page
B841-104	B40	C100-10	C02	C104-20	C02	C150-17N	C05	C165-17	C06
B841-105	B40	C100-11	C02	C105-10	C02	C150-17S	C05	C170-16	C06
B841-106	B40	C100-13	C02	C105-11	C02	C150-17T	C05	C172-16	C06
B841-107	B40	C100-14	C02	C105-13	C02	C150-17TS	C05	C172-18	C06
B841-108	B40	C100-14T	C02	C105-14	C02	C150-19	C05	C173-16	C06
B841-109	B40	C100-15	C02	C105-14T	C02	C150-23	C05	C173-18	C06
B841-110	B40	C100-16	C02	C105-15	C02	C150-23S	C05	C180-20	C06
B841-112	B40	C100-17	C02	C105-16	C02	C150-23T	C05	C182-25	C06
B841-203	B40	C100-18	C02	C105-17	C02	C150-23TS	C05	C186-19	C07
B841-204	B40	C100-20	C02	C105-18	C02	C150-28	C05	C188-19	C07
B841-205	B40	C101-10	C02	C105-20	C02	C150-28S	C05	C191-17	C07
B841-206	B40	C101-11	C02	C110-13	C03	C150-30S	C05	C193-17	C07
B841-207	B40	C101-13	C02	C110-14	C03	C151-14	C05	C193-17S	C07
B841-208	B40	C101-14	C02	C111-13	C03	C151-14S	C05	C193-17T	C07
B841-209	B40	C101-14T	C02	C111-14	C03	C151-14T	C05	C193-17TS	C07
B841-210	B40	C101-14TW	C02	C112-13	C03	C151-14TS	C05	C193-17TW	C07
B841-212	B40	C101-15	C02	C112-14	C03	C151-14TW	C05	C194-18	C07
B841-303	B40	C101-16	C02	C113-13	C03	C151-15	C05	C195-18	C07
B841-304	B40	C101-17	C02	C113-14	C03	C151-15N	C05	C196-18	C07
B841-305	B40	C101-18	C02	C114-13	C03	C151-17	C05	C200-14	C08
B841-306	B40	C101-20	C02	C114-14	C03	C151-17N	C05	C200-14N	C08
B841-307	B40	C102-10	C02	C115-13	C03	C151-17S	C05	C200-14S	C08
B841-308	B40	C102-11	C02	C115-14	C03	C151-17T	C05	C200-14T	C08
B841-309	B40	C102-13	C02	C120-14	C03	C151-17TS	C05	C200-14TS	C08
B841-310	B40	C102-14	C02	C121-14	C03	C151-17TW	C05	C200-18	C09
B841-312	B40	C102-14N	C02	C122-15	C03	C151-19	C05	C200-18N	C09
B841-403	B40	C102-14S	C02	C123-15	C03	C151-23	C05	C200-18S	C09
B841-404	B40	C102-14T	C02	C124-16	C04	C151-23S	C05	C200-18T	C09
B841-405	B40	C102-15	C02	C124-16S	C04	C151-23T	C05	C200-18TS	C09
B841-406	B40	C102-16	C02	C124-16T	C04	C151-23TS	C05	C200-20	C09
B841-407	B40	C102-17	C02	C124-16TS	C04	C151-23TW	C05	C200-20S	C09
B841-408	B40	C102-18	C02	C125-16	C04	C151-28	C05	C200-20T	C09
B841-409	B40	C102-20	C02	C125-16S	C04	C151-28S	C05	C200-23	C09
B841-410	B40	C103-10	C02	C125-16T	C04	C160-15	C05	C200-23N	C09
B841-412	B40	C103-11	C02	C125-16TS	C04	C160-15S	C05	C200-23S	C09
B880-02	B41	C103-13	C02	C125-16TW	C04	C160-15T	C05	C200-23T	C09
B880-05	B41	C103-14	C02	C126-16	C04	C160-15TS	C05	C200-23TS	C09
B880-10	B41	C103-14S	C02	C126-16T	C04	C160-17	C05	C200-25	C09
B880-20	B41	C103-14T	C02	C127-16	C04	C160-17S	C05	C200-25T	C09
B880-52	B41	C103-15	C02	C127-16T	C04	C160-17T	C05	C200-28	C09
B880-55	B41	C103-16	C02	C127-16TS	C04	C160-17TS	C05	C200-28T	C09
B880-60	B41	C103-17	C02	C135-13	C04	C160-19	C05	C200-30	C09
B880-70	B41	C103-18	C02	C135-14	C04	C161-15	C05	C200-30T	C09
B885-05	B41	C103-20	C02	C135-16	C04	C161-15S	C05	C201-13	C08
B885-07	B41	C104-10	C02	C136-14	C04	C161-15T	C05	C201-14	C08
B885-10	B41	C104-11	C02	C138-18	C04	C161-15TS	C05	C201-14S	C08
B885-15	B41	C104-13	C02	C150-14	C05	C161-17	C05	C201-14T	C08
B885-20	B41	C104-14	C02	C150-14S	C05	C161-17S	C05	C201-14TS	C08
B885-55	B41	C104-14T	C02	C150-14T	C05	C161-17T	C05	C201-14TW	C08
B885-57	B41	C104-15	C02	C150-14TS	C05	C161-17TS	C05	C201-15N	C08
B885-60	B41	C104-16	C02	C150-15	C05	C161-19	C05	C201-18	C09
B885-65	B41	C104-17	C02	C150-15N	C05	C161-21	C05	C201-18N	C09
B885-70	B41	C104-18	C02	C150-17	C05	C164-17	C06	C201-18S	C09

Index Art.-Nr. Index Item No.

Art.-Nr. Item No.	Seite Page	Art.-Nr. Item No.	Seite Page	Art.-Nr. Item No.	Seite Page	Art.-Nr. Item No.	Seite Page	Art.-Nr. Item No.	Seite Page
C201-18T	C09	C208-20T	C10	C227-14	C12	C311-13	C17	C380-11	C20
C201-18TS	C09	C208-23	C10	C227-19	C12	C311-19	C17	C380-11S	C20
C201-18TW	C09	C208-23T	C10	C227-22	C12	C311-19S	C17	C380-11W	C20
C201-20	C09	C208-25	C10	C228-27	C12	C312-13	C17	C381-11	C20
C201-20S	C09	C209-14	C10	C229-27	C12	C312-19	C17	C381-11S	C20
C201-20T	C09	C209-14S	C10	C231-22	C12	C312-19S	C17	C381-11W	C20
C201-20TS	C09	C209-14T	C10	C233-24	C12	C313-13	C17	C384-01	C19
C201-20TW	C09	C209-18	C10	C237-23	C12	C313-19	C17	C384-02	C19
C201-23	C09	C209-18N	C10	C241-24	C12	C313-19S	C17	C384-03	C19
C201-23N	C09	C209-18S	C10	C250-14	C13	C314-19	C17	C384-03S	C19
C201-23S	C09	C209-18T	C10	C250-14S	C13	C314-19S	C17	C384-03W	C19
C201-23T	C09	C209-20	C10	C250-22	C13	C315-19	C17	C385-01	C19
C201-23TS	C09	C209-20T	C10	C250-22S	C13	C315-19S	C17	C385-02	C19
C201-23TW	C09	C209-23	C10	C252-18	C13	C318-19	C17	C385-03	C19
C201-25	C09	C209-23S	C10	C252-18W	C13	C320-11	C17	C385-03S	C19
C201-25S	C09	C209-23T	C10	C256-19S	C13	C350-09	C18	C385-03W	C19
C201-25T	C09	C209-25	C10	C256-19T	C13	C350-09S	C18	C390-09	C20
C201-28	C09	C209-25T	C10	C256-19W	C13	C350-10	C18	C393-10	C20
C201-28S	C09	C209-28	C10	C258-231T	C13	C350-11	C18	C396-14	C20
C201-28T	C09	C209-28T	C10	C258-234T	C13	C350-11S	C18	C397-14	C20
C201-30	C09	C210-14	C10	C258-261T	C13	C350-11T	C18	C400-10	C20
C201-30S	C09	C210-14T	C10	C258-264T	C13	C351-09	C18	C401-10	C20
C201-30T	C09	C210-18T	C10	C266-10	C14	C351-09S	C18	C408-14	C20
C201-36S	C09	C210-20T	C10	C267-16	C14	C351-10	C18	C409-14	C20
C201-36T	C09	C210-23T	C10	C268-16	C14	C351-11	C18	C410-14	C21
C202-14	C08	C211-14	C10	C270-21	C14	C351-11S	C18	C410-14S	C21
C202-18	C09	C211-14T	C10	C271-21	C14	C351-11T	C18	C410-14TW	C21
C202-20	C09	C211-18T	C10	C272-21	C14	C353-11	C18	C411-14	C21
C202-23	C09	C211-23T	C10	C279-30	C15	C354-11	C18	C411-14S	C21
C202-25	C09	C214-11	C11	C294-17S	C15	C360-09	C18	C412-16	C21
C203-14	C08	C214-11S	C11	C296-01	C15	C360-10	C18	C412-16S	C21
C203-18	C09	C214-11T	C11	C296-02	C15	C360-11	C18	C412-16T	C21
C203-20	C09	C215-11	C11	C297-15	C15	C360-11T	C18	C412-16W	C21
C203-23	C09	C215-11S	C11	C300-19	C16	C361-09	C18	C412-18	C21
C203-25	C09	C215-11T	C11	C300-19S	C16	C361-10	C18	C413-16	C21
C204-14	C08	C217-15T	C11	C300-19T	C16	C361-11	C18	C413-16S	C21
C204-14W	C08	C217-18T	C11	C301-19	C16	C361-11T	C18	C413-16T	C21
C204-18	C09	C217-20T	C11	C301-19S	C16	C364-10	C19	C413-16W	C21
C204-20	C09	C217-23T	C11	C302-19	C16	C365-10	C19	C413-18	C21
C204-23	C09	C217-26T	C11	C302-19S	C16	C366-10	C19	C419-15	C21
C204-25	C09	C220-20	C11	C302-19T	C16	C366-11	C19	C420-15	C21
C205-14	C08	C220-23	C11	C305-16	C16	C367-10	C19	C420-15S	C21
C205-14W	C08	C221-20	C11	C305-16	C16	C367-11	C19	C420-18	C21
C205-18	C09	C221-23	C11	C305-23	C16	C370-11	C19	C421-13S	C21
C205-20	C09	C221-23T	C11	C305-28	C16	C371-11	C19	C421-15	C21
C205-23	C09	C222-20	C11	C306-16	C16	C374-01	C19	C421-15S	C21
C205-25	C09	C222-23	C11	C306-23	C16	C374-02	C19	C421-18	C21
C208-14	C10	C223-20	C11	C307-16	C16	C374-03	C19	C421-18S	C21
C208-14S	C10	C223-23	C11	C307-23	C16	C374-03S	C19	C423-15	C21
C208-14T	C10	C224-20	C11	C307-28	C16	C375-01	C19	C423-15S	C21
C208-18	C10	C224-23	C11	C310-13	C17	C375-02	C19	C423-18S	C21
C208-18T	C10	C225-20	C11	C310-19	C17	C375-03	C19	C423-20	C21
C208-20	C10	C225-23	C11	C310-19S	C17	C375-03S	C19	C423-23	C21

Index Art.-Nr. Index Item No.

Art.-Nr. Item No.	Seite Page	Art.-Nr. Item No.	Seite Page	Art.-Nr. Item No.	Seite Page	Art.-Nr. Item No.	Seite Page	Art.-Nr. Item No.	Seite Page
C425-13	C21	C470-23	C25	C560-13	C29	C637-10	C33	C727-01	C38
C430-01	C22	C470-25	C25	C560-13S	C29	C640-14	C34	C727-02	C38
C430-02	C22	C470-32	C25	C565-13	C29	C640-18	C34	C734-01	C38
C430-03	C22	C470-32S	C25	C565-13S	C29	C650-09	C34	C734-03	C38
C431-01	C22	C470-33	C25	C565-13T	C29	C650-11	C34	C736-01	C38
C431-02	C22	C470-33S	C25	C566-13	C29	C650-14	C34	C736-02	C38
C431-03	C22	C470-42	C25	C566-13S	C29	C650-14S	C34	C740-01	C39
C440-08	C22	C470-42S	C25	C567-13	C30	C650-15	C34	C740-02	C39
C441-08	C22	C470-43	C25	C567-13S	C30	C650-18	C34	C740-11	C39
C450-11	C22	C470-43S	C25	C570-16	C30	C650-18S	C34	C750-01	C39
C450-11T	C22	C470-47	C25	C570-16S	C30	C650-18T	C34	C750-02	C39
C451-11	C22	C470-49	C25	C570-16T	C30	C650-18TS	C34	C750-03	C39
C451-11T	C22	C470-61	C25	C576-12	C30	C650-20	C34	C751-01	C39
C455-11	C22	C470-72	C25	C577-12	C30	C650-20S	C34	C751-02	C39
C455-11S	C22	C470-72S	C25	C580-10	C30	C652-21	C34	C751-03	C39
C455-11W	C22	C470-73	C25	C580-12	C30	C655-16	C34	C798-16/25	C40
C460-10	C23	C470-73S	C25	C581-10	C30	C655-19	C34	C798-16/45	C40
C460-11	C23	C501-12	C24	C581-12	C30	C664-14	C34	C798-16/60	C40
C461-10	C23	C501-12S	C24	C582-13TW	C30	C665-14	C34	C798-16/90	C40
C461-11	C23	C501-12T	C24	C582-13W	C30	C668-20	C35	C798-16/99	C40
C462-10	C23	C501-13	C24	C583-13S	C30	C668-22	C35	C799-11/25	C40
C462-10S	C23	C501-15	C24	C583-13TW	C30	C670-23	C35	C799-11/45	C40
C462-11	C23	C504-11S	C26	C583-13W	C30	C671-23	C35	C799-11/60	C40
C462-11N	C23	C505-11S	C26	C585-13S	C30	C675-24	C35	C799-11/90	C40
C462-11S	C23	C505-14S	C26	C585-13W	C30	C675-24T	C35	C799-11/99	C40
C463-10	C23	C510-18S	C26	C587-17T	C31	C675-24W	C35	C799-11/99R	C40
C463-10S	C23	C511-18S	C26	C587-17W	C31	C678-18	C35	C799-16/25	C40
C463-11	C23	C512-19S	C26	C588-16W	C31	C680-20	C35	C799-16/25	C40
C463-11N	C23	C513-19S	C26	C589-16	C31	C681-23	C36	C799-16/60	C40
C463-11S	C23	C515-15	C26	C610-09	C31	C682-23	C36	C799-16/90	C40
C465-10	C24	C515-15S	C26	C610-10	C31	C684-22	C36	C799-16/99	C40
C466-01	C23	C515-19	C26	C610-12	C31	C685-22	C36	C800-15/25	C41
C466-02	C23	C515-19S	C26	C610-14	C31	C688-24	C36	C800-15/45	C41
C466-03	C23	C516-16S	C27	C611-11	C31	C689-23	C36	C800-15/60	C41
C466-04	C23	C517-18S	C27	C611-14	C31	C689-26	C36	C800-15/90	C41
C467-10	C24	C518-19S	C27	C613-09	C31	C689-37	C36	C800-15/99	C41
C468-11	C24	C519-19S	C27	C613-12	C31	C700-01	C37	C800-18/25	C41
C468-13	C24	C520-23S	C27	C614-11	C32	C700-02	C37	C800-18/25N	C41
C469-11	C24	C521-23S	C27	C617-11	C32	C700-03	C37	C800-18/45	C41
C469-13	C24	C530-21	C28	C621-11	C32	C700-04	C37	C800-18/45N	C41
C470-02	C25	C531-21	C28	C623-12	C32	C701-01	C37	C800-18/60	C41
C470-02S	C25	C532-14	C28	C630-12	C32	C701-02	C37	C800-18/60N	C41
C470-03	C25	C532-17	C28	C630-12T	C32	C701-03	C37	C800-18/90	C41
C470-03S	C25	C534-02	C28	C632-13	C33	C701-04	C37	C800-18/90N	C41
C470-04	C25	C536-17	C28	C632-15	C33	C705-01	C37	C800-18/99	C41
C470-05	C25	C549-19	C28	C633-17	C33	C705-03	C37	C800-18/99N	C41
C470-06	C25	C551-18	C28	C634-09	C33	C705-13	C37	C800-23/25	C41
C470-06S	C25	C552-17	C29	C634-10	C33	C705-21	C37	C800-23/45	C41
C470-07	C25	C553-19	C29	C635-09	C33	C705-22	C37	C800-23/60	C41
C470-07S	C25	C555-18	C29	C635-10	C33	C715-01	C37	C800-23/90	C41
C470-08	C25	C555-18S	C29	C636-09	C33	C715-02	C37	C800-23/99	C41
C470-09	C25	C559-01	C29	C636-10	C33	C720-01	C38	C801-18/25	C41
C470-22	C25	C559-02	C29	C637-09	C33	C720-02	C38	C801-18/45	C41

Index Art.-Nr. Index Item No.

Art.-Nr. Item No.	Seite Page	Art.-Nr. Item No.	Seite Page	Art.-Nr. Item No.	Seite Page	Art.-Nr. Item No.	Seite Page	Art.-Nr. Item No.	Seite Page
C801-18/60	C41	C817-22	C43	C834-22AN	C45	C841-22N	C46	C852-18/25	C46
C801-18/90	C41	C820-18/25	C43	C834-22N	C45	C841-22NW	C46	C852-18/45	C46
C801-18/99	C41	C820-18/25N	C43	C834-22NW	C45	C841-22W	C46	C852-18/60	C46
C806-15	C41	C820-18/45	C43	C834-22W	C45	C844-20	C46	C852-18/90	C46
C806-15A	C41	C820-18/45N	C43	C834-24	C45	C844-20N	C46	C852-18/99	C46
C806-16N	C41	C820-18/60	C43	C834-24	C45	C844-22	C46	C860-11	C48
C806-16W	C41	C820-18/60N	C43	C835-16	C45	C845-20	C46	C860-11A	C48
C806-18	C41	C820-18/90	C43	C835-16N	C45	C845-20N	C46	C860-14	C48
C806-18A	C41	C820-18/90N	C43	C835-20	C45	C845-22	C46	C860-14B	C48
C806-18N	C41	C820-18/99	C43	C835-20N	C45	C845-22N	C46	C860-14W	C48
C806-20	C41	C820-18/99N	C43	C835-22	C45	C848-17/25	C47	C860-15N	C48
C806-20A	C41	C821-18/25	C43	C835-22A	C45	C848-17/45	C47	C860-15NW	C48
C806-21N	C41	C821-18/25N	C43	C835-22AN	C45	C848-17/60	C47	C860-18	C48
C806-23	C41	C821-18/45	C43	C835-22N	C45	C848-17/90	C47	C860-18B	C48
C806-23A	C41	C821-18/45N	C43	C836-16	C45	C848-17/99	C47	C860-18N	C48
C807-15	C41	C821-18/60	C43	C836-16N	C45	C849-11/25	C47	C860-18W	C48
C807-15A	C41	C821-18/60N	C43	C836-18	C45	C849-11/45	C47	C860-21	C48
C807-16N	C41	C821-18/90	C43	C836-18N	C45	C849-11/60	C47	C860-21N	C48
C807-16W	C41	C821-18/90N	C43	C836-20	C45	C849-11/90	C47	C860-23	C48
C807-18	C41	C821-18/99	C43	C836-20N	C45	C849-11/99	C47	C860-23N	C48
C807-18A	C41	C821-18/99N	C43	C836-22	C45	C849-11/99R	C47	C861-11	C48
C807-18N	C41	C824-15	C44	C836-22N	C45	C849-17/25	C47	C861-11A	C48
C807-20	C41	C824-15N	C44	C837-20	C45	C849-17/45	C47	C861-14	C48
C807-20A	C41	C824-18	C44	C837-20N	C45	C849-17/60	C47	C861-14B	C48
C807-21N	C41	C824-18N	C44	C837-22	C45	C849-17/90	C47	C861-14N	C48
C807-23	C41	C824-21	C44	C837-22N	C45	C849-17/99	C47	C861-14W	C48
C807-23A	C41	C824-21N	C44	C839-20	C45	C849-17/99R	C47	C861-16N	C48
C808-18	C41	C824-23	C44	C839-22	C45	C849-20/99	C47	C861-18	C48
C810-11	C42	C825-15	C44	C839-51	C45	C850-11/25	C47	C861-18B	C48
C810-15	C42	C825-15N	C44	C839-52	C45	C850-11/45	C47	C861-18N	C48
C810-15A	C42	C825-18	C44	C839-53	C45	C850-11/60	C47	C861-18W	C48
C810-15W	C42	C825-18N	C44	C840-20	C46	C850-11/90	C47	C861-21	C48
C810-18A	C42	C825-21	C44	C840-20A	C46	C850-11/99R	C47	C861-21N	C48
C810-18W	C42	C825-21N	C44	C840-20AN	C46	C850-14/25	C46	C861-23	C48
C811-11	C42	C825-23	C44	C840-20N	C46	C850-14/45	C46	C861-23N	C48
C811-15	C42	C830-12	C44	C840-20NW	C46	C850-14/60	C46	C863-14	C48
C811-15A	C42	C830-12A	C44	C840-20W	C46	C850-14/90	C46	C863-14N	C48
C811-15W	C42	C830-16	C44	C840-22	C46	C850-14/99	C46	C863-18	C48
C811-18A	C42	C830-16A	C44	C840-22A	C46	C850-17/25	C46	C863-18N	C48
C811-18W	C42	C830-16W	C44	C840-22AN	C46	C850-17/45	C46	C865-18	C48
C812-15	C42	C830-18	C44	C840-22N	C46	C850-17/60	C46	C870-21	C49
C812-18	C42	C831-12	C44	C840-22N	C46	C850-17/90	C46	C870-23	C49
C814-16	C42	C831-12A	C44	C840-22NW	C46	C850-17/99	C46	C871-21	C49
C814-16A	C42	C831-16	C44	C840-22W	C46	C850-21/25	C46	C871-23	C49
C814-18	C42	C831-16A	C44	C841-20	C46	C850-21/45	C46	C886-15	C49
C814-18A	C42	C831-16W	C44	C841-20A	C46	C850-21/60	C46	C886-15N	C49
C815-16	C42	C831-18	C44	C841-20AN	C46	C850-21/90	C46	C886-18	C49
C815-16A	C42	C834-16	C45	C841-20N	C46	C850-21/99	C46	C886-18N	C49
C815-18	C42	C834-16N	C45	C841-20NW	C46	C850-23/25	C46	C886-21	C49
C815-18A	C42	C834-20	C45	C841-20W	C46	C850-23/45	C46	C886-21N	C49
C815-28	C42	C834-20N	C45	C841-22	C46	C850-23/60	C46	C886-23	C49
C815-38	C42	C834-22	C45	C841-22A	C46	C850-23/90	C46	C887-15	C49
C816-22	C43	C834-22A	C45	C841-22AN	C46	C850-23/99	C46	C887-15N	C49

Index Art.-Nr. Index Item No.

Art.-Nr. Item No.	Seite Page	Art.-Nr. Item No.	Seite Page	Art.-Nr. Item No.	Seite Page	Art.-Nr. Item No.	Seite Page	Art.-Nr. Item No.	Seite Page
C887-18	C49	D148-01	D04	D191-17	D07	D222-14	D09	D260-02	D11
C887-18N	C49	D148-02	D04	D195-01	D07	D222-16	D09	D260-03	D11
C887-21	C49	D149-01	D05	D195-04	D07	D222-18	D09	D260-04	D11
C887-21N	C49	D149-02	D05	D195-06	D07	D230-08	D09	D260-06	D11
C887-23	C49	D149-03	D05	D195-08	D07	D230-10	D09	D260-08	D11
D100-01	D02	D149-04	D05	D195-21	D07	D230-12	D09	D260-11	D11
D100-02	D02	D149-11	D05	D195-22	D07	D230-14	D09	D260-12	D11
D102-13	D02	D149-12	D05	D195-23	D07	D230-16	D09	D260-13	D11
D104-131	D02	D149-13	D05	D195-26	D07	D230-18	D09	D260-14	D11
D104-132	D02	D149-14	D05	D195-27	D07	D231-08	D09	D260-16	D11
D104-181	D02	D150-01	D05	D195-28	D07	D231-10	D09	D260-18	D11
D104-182	D02	D150-02	D05	D195-43	D07	D231-12	D09	D260-21	D11
D106-16	D02	D150-03	D05	D195-44	D07	D231-14	D09	D260-22	D11
D107-01	D02	D150-04	D05	D195-45	D07	D231-16	D09	D260-23	D11
D107-02	D02	D150-11	D05	D195-46	D07	D231-18	D09	D260-24	D11
D108-01	D02	D150-12	D05	D195-48	D07	D233-23	D10	D260-26	D11
D108-02	D02	D150-13	D05	D195-49	D07	D233-28	D10	D260-28	D11
D110-01	D02	D150-14	D05	D195-51	D07	D233-35	D10	D262-01	D12
D110-02	D02	D152-01	D05	D195-58	D07	D234-14	D10	D262-02	D12
D110-03	D02	D152-02	D05	D200-01	D08	D234-18	D10	D262-03	D12
D110-04	D02	D152-03	D05	D200-02	D08	D234-22	D10	D262-04	D12
D110-26	D02	D152-04	D05	D200-03	D08	D235-10	D10	D262-06	D12
D111-01	D03	D152-11	D05	D200-04	D08	D235-15	D10	D262-11	D12
D111-02	D03	D152-12	D05	D200-05	D08	D235-20	D10	D262-12	D12
D112-13	D03	D152-13	D05	D200-06	D08	D235-30	D10	D262-13	D12
D114-01	D03	D152-14	D05	D202-01	D08	D235-40	D10	D262-14	D12
D114-02	D03	D155-01	D05	D202-02	D08	D235-50	D10	D262-16	D12
D114-03	D03	D155-02	D05	D204-16	D08	D236-08	D10	D262-21	D12
D116-13	D03	D155-03	D05	D206-10	D08	D236-11	D10	D262-22	D12
D118-15	D03	D155-04	D05	D206-17	D08	D236-13	D10	D262-23	D12
D120-01	D03	D155-11	D05	D206-20	D08	D236-15	D10	D262-24	D12
D120-02	D03	D155-12	D05	D206-22	D08	D236-17	D10	D262-26	D12
D120-03	D03	D155-13	D05	D210-01	D08	D236-20	D10	D263-02	D12
D120-11	D03	D155-14	D05	D210-02	D08	D236-23	D10	D263-03	D12
D120-12	D03	D174-14	D06	D214-11	D08	D240-17	D10	D263-04	D12
D120-13	D03	D175-16	D06	D215-11	D08	D241-20	D10	D263-06	D12
D124-13	D03	D178-14	D06	D216-13	D09	D245-01	D10	D263-12	D12
D126-13	D04	D178-14N	D06	D218-13	D09	D245-02	D10	D263-13	D12
D130-01	D04	D180-01	D06	D218-16	D09	D245-11	D10	D263-14	D12
D130-02	D04	D180-01N	D06	D220-10	D09	D245-12	D10	D263-16	D12
D138-15	D04	D180-02	D06	D220-11	D09	D250-02	D11	D264-01	D13
D140-01	D04	D180-02N	D06	D220-12	D09	D250-03	D11	D264-02	D13
D140-01N	D04	D181-01	D06	D220-12N	D09	D250-04	D11	D264-03	D13
D140-02	D04	D181-02	D06	D220-13	D09	D250-06	D11	D264-04	D13
D140-02N	D04	D183-01	D06	D220-14	D09	D250-12	D11	D264-06	D13
D142-14	D04	D183-02	D06	D220-14N	D09	D250-13	D11	D264-08	D13
D144-20	D04	D185-01	D07	D220-15	D09	D250-14	D11	D264-11	D13
D147-02	D04	D185-02	D07	D220-16	D09	D250-16	D11	D264-12	D13
D147-03	D04	D185-04	D07	D220-16N	D09	D255-02	D11	D264-13	D13
D147-04	D04	D185-11	D07	D220-18	D09	D255-03	D11	D264-14	D13
D147-12	D04	D185-16	D07	D222-08	D09	D255-04	D11	D264-16	D13
D147-13	D04	D185-25	D07	D222-10	D09	D258-20	D11	D264-18	D13
D147-14	D04	D190-17	D07	D222-12	D09	D260-01	D11	D264-22	D13

Index Art.-Nr. Index Item No.

Art.-Nr. Item No.	Seite Page	Art.-Nr. Item No.	Seite Page	Art.-Nr. Item No.	Seite Page	Art.-Nr. Item No.	Seite Page	Art.-Nr. Item No.	Seite Page
D264-23	D13	D321-21N	D17	D351-04	D19	D390-03	D22	D433-02	D26
D264-24	D13	D322-16	D17	D355-01	D20	D390-04	D22	D433-03	D26
D264-26	D13	D324-16	D17	D355-02	D20	D390-05	D22	D433-04	D26
D264-28	D13	D329-19	D18	D355-03	D20	D392-25	D22	D433-05	D26
D265-01	D13	D330-01	D18	D356-01	D20	D394-01	D23	D435-01	D27
D265-02	D13	D330-02	D18	D356-02	D20	D394-02	D23	D435-02	D27
D266-01	D13	D330-03	D18	D356-03	D20	D394-03	D23	D438-01	D27
D266-02	D13	D330-04	D18	D358-16	D20	D396-28	D23	D438-02	D27
D268-01	D13	D330-05	D18	D358-20	D20	D397-01	D23	D440-01	D27
D268-02	D13	D330-06	D18	D358-25	D20	D397-02	D23	D440-02	D27
D268-03	D13	D330-07	D18	D360-01	D20	D398-26	D23	D441-01	D28
D268-24	D14	D330-11	D18	D360-02	D20	D400-01	D23	D441-02	D28
D270-17	D14	D330-12	D18	D360-03	D20	D400-02	D23	D442-101	D28
D272-03	D14	D330-13	D18	D360-11	D20	D400-03	D23	D442-102	D28
D272-04	D14	D330-14	D18	D360-12	D20	D400-04	D23	D442-103	D28
D275-20	D14	D330-15	D18	D360-13	D20	D400-05	D23	D442-201	D28
D280-02	D14	D330-16	D18	D361-01	D20	D400-06	D23	D442-202	D28
D280-03	D14	D330-17	D18	D361-02	D20	D400-07	D23	D442-203	D28
D280-04	D14	D332-21	D18	D361-03	D20	D400-11	D23	D445-00	D28
D280-06	D14	D333-01	D18	D361-22	D21	D400-12	D23	D445-01	D28
D280-12	D14	D333-02	D18	D365-01	D21	D400-13	D23	D445-02	D28
D280-13	D14	D333-03	D18	D365-02	D21	D400-14	D23	D445-03	D28
D280-14	D14	D334-01	D18	D365-03	D21	D400-15	D23	D446-01	D28
D280-16	D14	D334-02	D18	D365-04	D21	D400-16	D23	D446-02	D28
D282-01	D15	D334-03	D18	D365-11	D21	D401-01	D24	D446-03	D28
D282-02	D15	D334-04	D18	D365-12	D21	D401-12	D24	D446-04	D28
D284-23	D15	D335-01	D19	D365-13	D21	D401-13	D24	D446-05	D28
D285-25	D15	D335-02	D19	D365-14	D21	D401-14	D24	D446-06	D28
D286-28	D15	D335-03	D19	D365-31	D21	D402-01	D24	D447-01	D28
D290-01	D15	D335-04	D19	D370-00	D21	D402-02	D24	D447-02	D28
D290-02	D15	D335-05	D19	D370-01	D21	D402-03	D24	D447-03	D28
D290-03	D15	D335-06	D19	D370-02	D21	D402-04	D24	D447-04	D28
D290-04	D15	D335-07	D19	D374-01	D21	D410-33	D24	D447-05	D28
D300-00	D16	D335-08	D19	D374-02	D21	D411-28	D24	D447-06	D28
D300-01	D16	D335-09	D19	D374-03	D21	D412-01	D25	D448-01	D29
D300-02	D16	D335-10	D19	D374-04	D21	D412-02	D25	D448-02	D29
D300-03	D16	D344-01	D19	D377-01	D22	D412-03	D25	D448-03	D29
D300-13	D16	D344-02	D19	D377-02	D22	D413-25	D25	D448-04	D29
D301-14	D16	D344-03	D19	D377-03	D22	D415-01	D25	D450-00	D29
D302-01	D16	D345-19	D19	D377-04	D22	D415-02	D25	D450-01	D29
D302-02	D16	D348-01	D19	D377-05	D22	D415-03	D25	D450-02	D29
D302-03	D16	D348-02	D19	D377-06	D22	D422-01	D26	D450-03	D29
D308-13	D16	D349-01	D19	D379-22	D22	D422-02	D26	D450-11	D29
D308-18	D16	D349-02	D19	D381-23	D22	D422-03	D26	D450-12	D29
D310-12	D16	D349-03	D19	D382-01	D22	D422-04	D26	D450-21	D29
D310-15	D16	D350-01	D19	D382-02	D22	D424-01	D26	D450-31	D30
D316-19	D17	D350-02	D19	D382-03	D22	D424-02	D26	D450-32	D30
D317-15	D17	D350-03	D19	D382-04	D22	D424-03	D26	D450-33	D30
D318-19	D17	D350-04	D19	D382-05	D22	D428-01	D26	D450-34	D30
D320-00	D17	D350-05	D19	D382-06	D22	D428-02	D26	D450-41	D30
D320-01	D17	D351-01	D19	D383-00	D22	D432-17	D26	D450-42	D30
D320-02	D17	D351-02	D19	D390-01	D22	D432-21	D26	D450-43	D30
D321-21	D17	D351-03	D19	D390-02	D22	D433-01	D26	D451-32	D30

Index Art.-Nr. Index Item No.

Art.-Nr. Item No.	Seite Page	Art.-Nr. Item No.	Seite Page	Art.-Nr. Item No.	Seite Page	Art.-Nr. Item No.	Seite Page	Art.-Nr. Item No.	Seite Page
D451-41	D30	D708-38	D34	D762-33	D37	D801-33	D41	D846-00	D45
D451-42	D30	D708-50	D34	D771-201	D38	D802-00	D42	D846-10	D45
D451-43	D30	D712-071	D34	D771-202	D38	D802-10	D42	D846-21	D45
D455-01	D30	D712-072	D34	D772-201	D38	D802-21	D42	D847-00	D46
D455-02	D30	D712-101	D34	D772-202	D38	D802-31	D42	D847-01	D46
D455-03	D30	D712-102	D34	D773-271	D38	D810-00	D42	D848-21	D46
D456-27	D30	D712-103	D34	D773-272	D38	D810-10	D42	D848-23	D46
D458-01	D30	D715-101	D34	D774-271	D38	D810-20	D42	D848-24	D46
D458-02	D30	D715-102	D34	D774-272	D38	D812-01	D42	D848-31	D46
D458-03	D30	D717-01	D34	D780-131	D38	D812-02	D42	D848-32	D46
D462-01	D31	D717-02	D34	D780-132	D38	D812-10	D42	D849-00	D46
D462-02	D31	D719-01	D35	D780-161	D38	D812-10	D42	D849-01	D46
D462-03	D31	D719-02	D35	D780-162	D38	D812-20	D42	D851-00	D46
D480-106	D31	D720-101	D35	D780-201	D38	D812-21	D42	D855-00	D47
D480-113	D31	D720-102	D35	D780-202	D38	D812-21	D42	D855-01	D47
D480-119	D31	D720-131	D35	D780-251	D38	D812-22	D42	D857-00	D47
D480-216	D31	D720-132	D35	D780-252	D38	D815-17	D43	D857-21	D47
D480-306	D31	D730-101	D35	D782-311	D39	D816-17	D43	D857-22	D47
D480-308	D31	D730-102	D35	D782-312	D39	D820-09	D43	D857-31	D47
D480-310	D31	D730-102N	D35	D783-311	D39	D820-11	D43	D857-32	D47
D480-312	D31	D730-103	D35	D783-312	D39	D820-13	D43	D858-00	D47
D480-317	D31	D730-131	D35	D783-313	D39	D820-19	D43	D858-01	D47
D480-320	D31	D730-132	D35	D784-331	D39	D821-19	D43	D858-21	D47
D480-325	D31	D730-133	D35	D784-332	D39	D822-16	D43	D858-22	D47
D480-425	D31	D730-161	D35	D788-311	D39	D822-18	D43	D858-23	D47
D480-520	D31	D730-162	D35	D788-312	D39	D824-10	D43	D860-00	D48
D480-525	D31	D730-163	D35	D788-313	D39	D824-14	D43	D860-01	D48
D480-530	D31	D730-201	D36	D790-22	D39	D826-01	D44	D860-21	D48
D480-532	D31	D730-202	D36	D792-221	D40	D826-02	D44	D860-22	D48
D480-535	D31	D730-251	D36	D792-222	D40	D826-03	D44	D860-23	D48
D480-538	D31	D730-252	D36	D794-01	D40	D826-04	D44	D860-32	D48
D480-540	D31	D738-141	D36	D794-02	D40	D826-05	D44	D860-35	D48
D480-545	D31	D738-141N	D36	D795-331	D40	D826-06	D44	D860-38	D48
D480-550	D31	D738-142	D36	D795-332	D40	D826-11	D44	D860-41	D48
D480-564	D31	D740-131	D36	D796-33	D40	D826-12	D44	D860-51	D48
D480-576	D31	D740-132	D36	D800-00	D41	D826-13	D44	D860-52	D48
D480-602	D31	D745-131	D36	D800-10	D41	D826-14	D44	D862-00	D49
D482-20	D31	D745-132	D36	D800-11	D41	D826-15	D44	D862-10	D49
D486-01	D31	D745-161	D36	D800-12	D41	D826-16	D44	D862-21	D49
D486-02	D31	D745-162	D36	D801-01	D41	D827-01	D44	D862-22	D49
D488-28	D31	D748-13	D36	D801-02	D41	D827-02	D44	D862-23	D49
D700-051	D34	D750-121	D37	D801-03	D41	D827-03	D44	D862-24	D49
D700-052	D34	D750-122	D37	D801-04	D41	D827-04	D44	D862-25	D49
D700-071	D34	D752-151	D37	D801-11	D41	D828-01	D44	D864-00	D49
D700-072	D34	D752-152	D37	D801-12	D41	D828-02	D44	D864-10	D49
D702-071	D34	D754-16	D37	D801-13	D41	D829-19	D44	D864-11	D49
D702-072	D34	D760-21	D37	D801-14	D41	D840-00	D45	D864-21	D49
D705-08	D34	D762-01	D37	D801-21	D41	D841-10	D45	D864-22	D49
D705-11	D34	D762-02	D37	D801-21	D41	D841-14	D45	D865-00	D49
D706-101	D34	D762-11	D37	D801-22	D41	D842-00	D45	D865-10	D49
D706-102	D34	D762-12	D37	D801-23	D41	D842-10	D45	D865-31	D49
D708-25	D34	D762-31	D37	D801-31	D41	D842-21	D45	D865-32	D49
D708-31	D34	D762-32	D37	D801-32	D41	D844-00	D45	D868-01	D50

Index Art.-Nr. Index Item No.

Art.-Nr. Item No.	Seite Page	Art.-Nr. Item No.	Seite Page	Art.-Nr. Item No.	Seite Page	Art.-Nr. Item No.	Seite Page	Art.-Nr. Item No.	Seite Page
D868-02	D50	D880-23	D53	D900-130	D55	D900-388	D58	F100-15	F02
D868-10	D50	D880-24	D53	D900-130	D60	D900-388	D60	F100-15N	F02
D868-11	D50	D882-01	D53	D900-150	D55	D900-390	D58	F100-16	F02
D868-12	D50	D882-02	D53	D900-152	D55	D900-400	D57	F100-16T	F02
D868-15	D50	D882-11	D53	D900-152	D60	D900-400	D60	F100-16X	F02
D868-21	D50	D882-12	D53	D900-154	D55	D900-402	D57	F100-17N	F02
D868-22	D50	D882-21	D54	D900-160	D55	D900-402	D60	F100-18	F02
D868-23	D50	D882-22	D54	D900-160	D60	D900-403	D57	F100-18T	F02
D868-24	D50	D882-23	D54	D900-162	D55	D900-404	D60	F100-20	F02
D868-25	D50	D882-31	D54	D900-186	D56	D900-410	D58	F100-20N	F02
D868-26	D50	D882-32	D54	D900-186	D60	D900-410	D60	F100-20T	F02
D870-00	D50	D882-33	D54	D900-187	D56	D900-412	D58	F100-23	F02
D870-01	D50	D882-34	D54	D900-187	D60	D900-412	D60	F100-23T	F02
D870-10	D50	D882-41	D54	D900-188	D56	D900-414	D58	F100-25	F02
D870-21	D50	D882-42	D54	D900-188	D60	D900-414	D60	F100-25T	F02
D870-22	D50	D882-43	D54	D900-201	D56	D900-420	D58	F100-30	F02
D870-23	D50	D882-44	D54	D900-201	D60	D900-420	D60	F100-30T	F02
D870-24	D50	D882-45	D54	D900-203	D56	D900-422	D58	F101-10	F02
D874-01	D51	D882-46	D54	D900-203	D60	D900-422	D60	F101-11	F02
D874-02	D51	D882-51	D54	D900-210	D56	D900-430	D58	F101-13	F02
D874-03	D51	D882-52	D54	D900-210	D60	D900-430	D60	F101-14	F02
D874-04	D51	D882-53	D54	D900-215	D56	D900-432	D58	F101-15	F02
D874-05	D51	D882-54	D54	D900-215	D60	D900-432	D60	F101-16	F02
D874-10	D51	D882-61	D54	D900-220	D56	D900-434	D58	F101-18	F02
D874-11	D51	D882-62	D54	D900-230	D56	D900-434	D60	F101-20	F02
D874-21	D51	D882-63	D54	D900-230	D60	D900-450	D58	F101-25	F02
D875-01	D52	D882-64	D54	D900-235	D56	D900-452	D58	F101-30	F02
D875-02	D52	D882-65	D54	D900-235	D60	D900-454	D58	F106-10	F02
D875-03	D52	D882-66	D54	D900-302	D57	D900-460	D59	F106-11	F02
D875-04	D52	D882-67	D54	D900-302	D60	D900-462	D59	F106-13	F02
D876-09	D52	D882-68	D54	D900-304	D57	D900-464	D59	F106-14	F02
D876-10	D52	D882-69	D54	D900-304	D60	D900-466	D59	F106-15	F02
D876-11	D52	D882-70	D54	D900-312	D57	D900-470	D59	F106-16	F02
D876-12	D52	D882-71	D54	D900-312	D60	D900-470	D60	F106-18	F02
D876-13	D52	D882-72	D54	D900-314	D57	D900-472	D59	F106-20	F02
D876-14	D52	D882-73	D54	D900-314	D60	D900-484	D59	F106-25	F02
D876-15	D52	D882-81	D54	D900-320	D57	D900-484	D60	F106-30	F02
D876-16	D52	D882-82	D54	D900-320	D60	D900-486	D59	F107-10	F02
D876-17	D52	D882-83	D54	D900-330	D57	D900-486	D60	F107-11	F02
D876-18	D52	D882-84	D54	D900-330	D60	D900-490	D59	F107-13	F02
D876-19	D52	D882-85	D54	D900-372	D60	D900-491	D59	F107-14	F02
D876-21	D52	D882-86	D54	D900-374	D60	D900-492	D59	F107-15	F02
D876-22	D52	D882-90	D54	D900-380	D58	D900-493	D59	F107-16	F02
D876-23	D52	D882-91	D54	D900-380	D58	D900-494	D59	F107-18	F02
D876-24	D52	D882-92	D54	D900-380	D58	D900-495	D59	F107-20	F02
D876-25	D52	D900-100	D55	D900-380	D58	F100-10	F02	F107-25	F02
D876-26	D52	D900-104	D55	D900-381	D58	F100-11	F02	F107-30	F02
D876-27	D52	D900-108	D55	D900-383	D58	F100-13	F02	F108-11	F02
D876-28	D52	D900-108	D60	D900-383	D60	F100-13T	F02	F108-13	F02
D880-00	D53	D900-110	D55	D900-384	D58	F100-13X	F02	F108-14	F02
D880-10	D53	D900-110	D60	D900-384	D60	F100-14	F02	F108-15	F02
D880-21	D53	D900-114	D55	D900-386	D58	F100-14T	F02	F108-16	F02
D880-22	D53	D900-118	D55	D900-386	D60	F100-14X	F02	F108-18	F02

Index Art.-Nr. Index Item No.

Art.-Nr. Item No.	Seite Page	Art.-Nr. Item No.	Seite Page	Art.-Nr. Item No.	Seite Page	Art.-Nr. Item No.	Seite Page	Art.-Nr. Item No.	Seite Page
F108-20	F02	F138-15	F04	F180-15T	F06	F303-13	F08	F320-15T	F09
F108-25	F02	F140-12	F04	F180-18	F06	F303-14	F08	F321-12	F09
F108-30	F02	F140-15	F04	F180-18N	F06	F303-15	F08	F322-12	F09
F109-10	F02	F140-15T	F04	F180-18T	F06	F303-18	F08	F322-15	F09
F109-11	F02	F141-12	F04	F180-20N	F06	F303-20	F08	F324-12	F09
F109-13	F02	F141-15	F04	F180-20T	F06	F303-25	F08	F326-12	F09
F109-15	F02	F143-06	F04	F180-21	F06	F303-30	F08	F326-12A	F10
F109-17	F02	F143-08	F04	F180-23T	F06	F304-14	F08	F326-12N	F09
F109-20	F02	F143-10	F04	F180-25	F06	F304-15	F08	F326-12T	F09
F109-25	F02	F144-10	F05	F180-25T	F06	F304-20	F08	F326-15	F09
F109-30	F02	F144-10A	F05	F180-30	F06	F306-10	F08	F326-15T	F09
F110-12	F03	F144-10B	F05	F181-18	F06	F306-11	F08	F328-12	F10
F110-13	F03	F150-17	F05	F181-21	F06	F306-13	F08	F330-12	F10
F110-14	F03	F151-17	F05	F181-25	F06	F306-14	F08	F330-12N	F10
F110-15	F03	F152-17	F05	F184-18	F06	F306-16	F08	F330-12T	F10
F110-18	F03	F152-17T	F05	F184-18N	F06	F306-18	F08	F330-15	F10
F110-21	F03	F152-20T	F05	F184-18T	F06	F306-20	F08	F330-15T	F10
F110-25	F03	F154-17	F05	F185-18	F06	F306-25	F08	F331-12	F10
F110-30	F03	F154-17U	F05	F187-18T	F07	F306-30	F08	F336-15	F10
F112-12	F03	F154-20	F05	F188-18T	F07	F308-11	F08	F338-15	F10
F112-13	F03	F154-20U	F05	F189-18T	F07	F308-13	F08	F338-15N	F10
F112-14	F03	F156-15	F05	F190-15T	F07	F308-14	F08	F338-15T	F10
F112-15	F03	F156-18	F05	F190-23T	F07	F308-16	F08	F340-12	F10
F114-13	F03	F156-20	F05	F190-25T	F07	F308-18	F08	F340-15	F10
F114-15	F03	F158-18	F05	F192-18	F07	F308-20	F08	F340-15T	F10
F117-14	F03	F158-20	F05	F192-18T	F07	F310-12	F09	F340-52	F10
F120-12	F03	F159-20	F05	F300-10	F08	F310-13	F09	F340-55	F10
F120-12A	F04	F160-20	F06	F300-11	F08	F310-14	F09	F341-12	F10
F120-12D	F03	F161-20	F06	F300-13	F08	F310-15	F09	F341-15	F10
F120-12N	F03	F162-20	F06	F300-14	F08	F310-18	F09	F342-12	F10
F120-12NT	F03	F168-18	F06	F300-14T	F08	F310-21	F09	F342-15	F10
F120-12T	F03	F168-18D	F06	F300-15	F08	F310-25	F09	F344-06	F11
F120-12U	F03	F168-18N	F06	F300-15N	F08	F312-12	F09	F344-08	F11
F120-12X	F03	F168-18ND	F06	F300-16	F08	F312-13	F09	F344-10	F11
F120-15	F03	F168-18NU	F06	F300-16T	F08	F312-14	F09	F346-10	F11
F120-15T	F03	F168-18T	F06	F300-17N	F08	F312-18	F09	F346-10A	F11
F120-15U	F03	F168-18U	F06	F300-18	F08	F312-21	F09	F346-10B	F11
F120-52T	F03	F168-18X	F06	F300-18T	F08	F312-25	F09	F350-17	F11
F121-12	F03	F168-20D	F06	F300-20	F08	F312-31	F09	F351-17	F11
F122-12	F03	F168-20NU	F06	F300-20T	F08	F314-14	F09	F352-17	F11
F124-12	F03	F168-20U	F06	F300-23	F08	F316-12	F09	F354-17	F11
F124-12T	F03	F168-21N	F06	F300-25	F08	F316-13	F09	F354-20	F11
F124-15	F03	F168-23	F06	F300-25T	F08	F316-14	F09	F356-15	F11
F124-15T	F03	F168-23D	F06	F300-30	F08	F316-15	F09	F356-18	F11
F128-12	F03	F168-25X	F06	F300-30T	F08	F320-12	F09	F356-20	F11
F128-15	F03	F168-68D	F06	F302-11	F08	F320-12A	F09	F356-25	F11
F130-12	F04	F168-68D	F06	F302-13	F08	F320-12A	F10	F356-30	F11
F130-52	F04	F169-18	F06	F302-14	F08	F320-12N	F09	F360-20	F12
F136-15	F04	F169-18D	F06	F302-16	F08	F320-12ND	F09	F361-20	F12
F136-15D	F04	F170-18N	F06	F302-18	F08	F320-12T	F09	F365-18	F12
F136-15N	F04	F170-18ND	F06	F302-20	F08	F320-12TN	F09	F368-18	F12
F136-15ND	F04	F170-21N	F06	F302-25	F08	F320-12X	F09	F368-18N	F12
F136-15T	F04	F170-21ND	F06	F302-30	F08	F320-15	F09	F368-18T	F12

Index Art.-Nr. Index Item No.

Art.-Nr. Item No.	Seite Page	Art.-Nr. Item No.	Seite Page	Art.-Nr. Item No.	Seite Page	Art.-Nr. Item No.	Seite Page	Art.-Nr. Item No.	Seite Page
F368-23	F12	F430-15	F14	F474-15	F16	F620-18	F20	F627-18N	F20
F369-18	F12	F430-18	F14	F475-15	F16	F620-18D	F20	F627-18ND	F20
F369-18T	F12	F430-23	F14	F476-11	F16	F620-18N	F20	F628-18	F20
F380-18	F12	F432-18	F14	F480-03	F17	F620-18ND	F20	F628-18D	F20
F380-18N	F12	F432-23	F14	F480-04	F17	F621-12	F20	F628-18N	F20
F380-20N	F12	F435-15	F14	F480-05	F17	F621-12D	F20	F628-18ND	F20
F380-21	F12	F435-20	F14	F480-07	F17	F621-12ND	F20	F628-21	F20
F380-25	F12	F435-25	F14	F490-12	F17	F621-15	F20	F628-21D	F20
F380-30	F12	F438-14	F15	F490-13	F17	F621-15D	F20	F628-21N	F20
F381-18	F12	F439-20	F15	F491-13	F17	F621-15N	F20	F628-21ND	F20
F381-21	F12	F442-08	F15	F492-13	F17	F621-15ND	F20	F628-23	F20
F381-25	F12	F443-08	F15	F510-13	F17	F621-18	F20	F628-23D	F20
F384-18	F12	F446-08	F15	F510-14	F17	F621-18D	F20	F628-23N	F20
F384-18T	F12	F446-09	F15	F510-15	F17	F621-18N	F20	F628-23ND	F20
F385-18	F12	F447-09	F15	F510-16	F17	F621-18ND	F20	F629-18	F20
F400-14	F13	F449-09	F15	F510-17	F17	F622-18	F20	F629-18D	F20
F400-20	F13	F450-09	F15	F515-11	F18	F622-18D	F20	F629-18N	F20
F402-14	F13	F451-09	F15	F515-13	F18	F622-18N	F20	F629-18ND	F20
F402-20	F13	F456-10	F15	F515-15	F18	F622-18ND	F20	F629-21	F20
F404-18	F13	F457-10	F15	F515-17	F18	F622-21	F20	F629-21D	F20
F404-18T	F13	F458-12	F15	F517-13	F18	F622-21D	F20	F629-21N	F20
F405-18	F13	F459-12	F15	F519-12	F18	F622-21N	F20	F629-21ND	F20
F405-18T	F13	F460-08	F16	F522-14	F18	F622-21ND	F20	F629-23	F20
F406-18	F13	F460-08X	F16	F522-24	F18	F622-23	F20	F629-23D	F20
F406-18T	F13	F460-09	F16	F523-14	F18	F622-23D	F20	F629-23N	F20
F407-18	F13	F460-09X	F16	F526-16	F18	F622-23N	F20	F629-23ND	F20
F408-15	F13	F460-10	F16	F526-18	F18	F622-23ND	F20	F650-01N	F21
F409-15	F13	F460-10X	F16	F526-20	F18	F623-18	F20	F650-02N	F21
F412-14	F13	F460-11	F16	F526-26	F18	F623-18D	F20	F651-01N	F21
F412-20	F13	F460-11	F16	F526-28	F18	F623-18N	F20	F651-02N	F21
F414-18	F13	F460-11X	F16	F526-30	F18	F623-18ND	F20	F660-15D	F21
F414-20	F13	F460-12X	F16	F527-16	F18	F623-21	F20	F660-15ND	F21
F414-20N	F13	F461-08	F16	F527-19	F18	F623-21D	F20	F660-18D	F21
F414-25	F13	F461-08X	F16	F530-15	F18	F623-21N	F20	F660-18ND	F21
F416-15	F13	F461-09	F16	F535-11	F18	F623-21ND	F20	F660-21D	F21
F416-20	F13	F461-09X	F16	F550-15	F19	F623-23	F20	F660-21ND	F21
F416-25	F13	F461-10	F16	F550-15U	F19	F623-23D	F20	F660-23D	F21
F418-15	F13	F461-10X	F16	F550-18	F19	F623-23N	F20	F660-23ND	F21
F418-20	F13	F461-11	F16	F550-18U	F19	F623-23ND	F20	F660-25D	F21
F418-25	F13	F461-11X	F16	F550-21	F19	F626-15	F20	F660-25ND	F21
F420-15	F14	F461-12	F16	F550-21U	F19	F626-15D	F20	F661-15D	F21
F420-20	F14	F461-12X	F16	F554-01	F19	F626-15N	F20	F661-15ND	F21
F420-25	F14	F465-07	F16	F554-02	F19	F626-15ND	F20	F661-18D	F21
F423-14	F14	F465-09	F16	F554-03	F19	F626-18	F20	F661-18ND	F21
F423-16	F14	F465-11	F16	F556-14	F19	F626-18D	F20	F661-21D	F21
F423-20	F14	F466-10	F16	F556-18	F19	F626-18N	F20	F661-21ND	F21
F424-15	F14	F467-10	F16	F620-12	F20	F626-18ND	F20	F661-23D	F21
F424-20	F14	F468-10	F16	F620-12D	F20	F627-15	F20	F661-23ND	F21
F424-25	F14	F469-10	F16	F620-12ND	F20	F627-15D	F20	F661-25D	F21
F426-23	F14	F472-13	F16	F620-15	F20	F627-15N	F20	F661-25ND	F21
F427-23	F14	F472-13X	F16	F620-15D	F20	F627-15ND	F20	F667-01	F22
F427-23N	F14	F473-13	F16	F620-15N	F20	F627-18	F20	F667-02	F22
F428-22	F14	F473-13X	F16	F620-15ND	F20	F627-18D	F20	F667-03	F22

Index Art.-Nr. Index Item No.

Art.-Nr. Item No.	Seite Page	Art.-Nr. Item No.	Seite Page	Art.-Nr. Item No.	Seite Page	Art.-Nr. Item No.	Seite Page	Art.-Nr. Item No.	Seite Page
F667-04	F22	F681-15B	F24	F704-243	F25	F719-24	F27	F752-18	F28
F667-05	F22	F681-15D	F24	F704-245	F25	F719-24N	F27	F752-18N	F28
F667-06	F22	F681-15ND	F24	F704-247	F25	F719-30	F27	F752-21	F28
F670-15D	F22	F681-18A	F24	F705-163	F25	F721-16	F27	F752-21N	F28
F670-18D	F22	F681-18B	F24	F705-165	F25	F721-20	F27	F752-23	F28
F670-21D	F22	F681-18D	F24	F705-203	F25	F721-24	F27	F752-23N	F28
F670-23D	F22	F681-18ND	F24	F705-205	F25	F721-30	F27	F753-15	F28
F670-25D	F22	F681-21A	F24	F705-223	F25	F722-16	F27	F753-15N	F28
F671-18D	F22	F681-21B	F24	F705-225	F25	F722-20	F27	F753-18	F28
F671-68D	F22	F681-21D	F24	F705-243	F25	F722-24	F27	F753-18N	F28
F671-71D	F22	F681-21ND	F24	F705-245	F25	F722-30	F27	F753-21	F28
F671-73D	F22	F681-23A	F24	F706-223	F25	F723-14N	F27	F753-21N	F28
F672-01	F22	F681-23B	F24	F706-225	F25	F723-15N	F27	F753-23	F28
F672-02	F22	F681-23D	F24	F706-243	F25	F723-19N	F27	F753-23N	F28
F672-03	F22	F681-23ND	F24	F706-245	F25	F730-16	F27	F755-15	F29
F673-01	F22	F681-25D	F24	F707-01	F26	F730-20	F27	F755-15N	F29
F673-02	F22	F683-15D	F24	F707-02	F26	F730-24	F27	F755-18	F29
F674-16	F23	F683-18D	F24	F708-190	F26	F742-16T	F28	F755-18N	F29
F674-18	F23	F683-21D	F24	F708-191	F26	F742-19T	F28	F755-21	F29
F674-18D	F23	F683-23D	F24	F708-192	F26	F742-24T	F28	F755-21N	F29
F675-18	F23	F683-25D	F24	F708-195	F26	F743-16T	F28	F756-15N	F29
F675-18D	F23	F684-15D	F24	F708-196	F26	F743-19T	F28	F756-18N	F29
F676-18	F23	F684-18D	F24	F708-197	F26	F743-24T	F28	F756-21N	F29
F676-18D	F23	F684-21D	F24	F708-218	F26	F744-16T	F28	F760-16	F29
F677-18	F23	F684-23D	F24	F708-219	F26	F744-19T	F28	F760-20	F29
F677-18D	F23	F684-25D	F24	F709-234	F26	F744-24T	F28	F760-24	F29
F678-22	F23	F686-21D	F24	F709-236	F26	F745-16T	F28	G100-13	G02
F678-22D	F23	F686-23D	F24	F712-15N	F27	F745-19T	F28	G100-14	G02
F678-32	F23	F695-01	F24	F712-16	F27	F745-24T	F28	G100-14U	G02
F678-32D	F23	F695-02	F24	F712-19N	F27	F746-18T	F28	G100-16	G02
F679-21D	F23	F695-03	F24	F712-20	F27	F746-21T	F28	G100-16U	G02
F679-23D	F23	F700-16	F25	F712-24	F27	F746-23T	F28	G100-18	G02
F679-33D	F23	F700-16N	F25	F712-24N	F27	F746-68T	F28	G100-18U	G02
F680-15A	F24	F700-18	F25	F712-30	F27	F746-71T	F28	G100-20	G02
F680-15B	F24	F700-18N	F25	F714-16	F27	F746-73T	F28	G100-20U	G02
F680-15D	F24	F700-20	F25	F714-20	F27	F750-15	F28	G100-22	G02
F680-15ND	F24	F700-20N	F25	F714-24	F27	F750-15N	F28	G100-24	G02
F680-18A	F24	F700-22	F25	F714-30	F27	F750-18	F28	G100-26	G02
F680-18B	F24	F700-22N	F25	F716-15N	F27	F750-18N	F28	G100-26U	G02
F680-18D	F24	F700-24	F25	F716-16	F27	F750-21	F28	G100-28	G02
F680-18DP	F24	F701-16	F25	F716-19N	F27	F750-21N	F28	G100-28U	G02
F680-18ND	F24	F701-16N	F25	F716-20	F27	F750-23	F28	G100-30	G02
F680-21A	F24	F701-18	F25	F716-24	F27	F750-23N	F28	G100-520	G02
F680-21B	F24	F701-18N	F25	F716-24N	F27	F751-15	F28	G100-523	G02
F680-21D	F24	F701-20	F25	F716-30	F27	F751-15N	F28	G100-525	G02
F680-21DP	F24	F701-20N	F25	F717-16	F27	F751-18	F28	G101-13	G02
F680-21ND	F24	F701-22	F25	F717-20	F27	F751-18N	F28	G101-14	G02
F680-23A	F24	F701-22N	F25	F717-24	F27	F751-21	F28	G101-14U	G02
F680-23B	F24	F701-24	F25	F717-30	F27	F751-21N	F28	G101-16	G02
F680-23D	F24	F702-18	F25	F719-15N	F27	F751-23	F28	G101-16U	G02
F680-23ND	F24	F704-223	F25	F719-16	F27	F751-23N	F28	G101-18	G02
F680-25D	F24	F704-225	F25	F719-19N	F27	F752-15	F28	G101-18U	G02
F681-15A	F24	F704-227	F25	F719-20	F27	F752-15N	F28	G101-20	G02

Index Art.-Nr. Index Item No.

Art.-Nr. Item No.	Seite Page	Art.-Nr. Item No.	Seite Page	Art.-Nr. Item No.	Seite Page	Art.-Nr. Item No.	Seite Page	Art.-Nr. Item No.	Seite Page
G101-20N	G02	G112-14	G04	G132-18	G06	G182-15U	G10	G233-24	G14
G101-20U	G02	G113-14	G04	G132-21	G06	G182-18	G10	G240-01	G14
G101-22	G02	G114-14	G04	G133-12	G06	G182-18U	G10	G240-02	G14
G101-24	G02	G114-14N	G04	G133-12N	G06	G183-15	G10	G240-03	G14
G101-26	G02	G114-16	G04	G133-14	G06	G183-15U	G10	G240-11	G14
G101-26U	G02	G114-16N	G04	G133-18	G06	G183-18	G10	G240-12	G14
G101-28	G02	G115-14	G04	G133-21	G06	G183-18U	G10	G245-01	G15
G101-28U	G02	G115-14N	G04	G134-10	G07	G184-16	G11	G245-02	G15
G101-30	G02	G115-16	G04	G134-12	G07	G185-16	G11	G245-03	G15
G101-36	G02	G115-16N	G04	G135-10	G07	G188-13	G11	G245-04	G15
G101-40	G02	G116-14	G04	G135-12	G07	G188-14	G11	G245-05	G15
G101-46	G02	G117-14	G04	G135-12N	G07	G188-15	G11	G246-22	G14
G101-520	G02	G118-14	G04	G136-10	G07	G188-18	G11	G247-22	G14
G101-523	G02	G118-14N	G04	G136-12	G07	G188-20	G11	G250-18N	G15
G101-525	G02	G118-16	G04	G137-10	G07	G189-13	G11	G250-20	G15
G102-13	G02	G118-16N	G04	G137-12	G07	G189-14	G11	G250-22	G15
G102-14	G02	G119-14	G04	G137-12N	G07	G189-15	G11	G250-23N	G15
G102-16	G02	G119-14N	G04	G140-10	G07	G189-18	G11	G250-24	G15
G103-13	G02	G119-16	G04	G140-10N	G07	G189-20	G11	G250-26	G15
G103-14	G02	G119-16N	G04	G141-10	G07	G193-12	G11	G251-18N	G15
G103-16	G02	G120-14	G05	G141-10N	G07	G193-14	G11	G251-20	G15
G104-13	G03	G120-16	G05	G142-10	G07	G193-16N	G11	G251-22	G15
G104-14	G03	G120-18	G05	G143-10	G07	G193-22	G11	G251-23N	G15
G104-16	G03	G121-14	G05	G146-13	G07	G195-14	G11	G251-24	G15
G104-18	G03	G121-16	G05	G147-13	G07	G198-14	G11	G251-26	G15
G104-18N	G03	G121-18	G05	G150-09	G07	G198-18	G11	G252-18N	G15
G104-20	G03	G121-26	G05	G151-10	G07	G199-01	G12	G252-20	G15
G104-20N	G03	G122-15	G05	G152-10	G07	G199-02	G12	G252-22	G15
G104-22	G03	G122-15N	G05	G153-13	G08	G199-03	G12	G252-24	G15
G104-24	G03	G123-15	G05	G154-13	G08	G200-18	G12	G252-26	G15
G104-26	G03	G123-15N	G05	G155-13	G08	G201-18	G12	G253-18N	G15
G104-30	G03	G124-15	G05	G157-14	G08	G202-18	G12	G253-20	G15
G105-13	G03	G124-15N	G05	G158-19	G08	G203-18	G12	G253-22	G15
G105-14	G03	G125-15	G05	G158-19	T41	G205-19	G12	G253-23N	G15
G105-16	G03	G125-15N	G05	G160-15	G08	G207-18	G12	G253-24	G15
G105-18	G03	G126-14	G05	G160-20	G08	G207-22	G12	G253-26	G15
G105-20	G03	G127-14	G05	G162-15	G09	G210-19	G13	G255-01	G16
G105-22	G03	G130-12	G06	G166-16	G09	G211-19	G13	G255-02	G16
G105-24	G03	G130-12N	G06	G167-17	G09	G215-01	G13	G255-03	G16
G105-26	G03	G130-12U	G06	G167-51	G09	G215-02	G13	G260-19	G16
G105-30	G03	G130-14	G06	G169-14	G09	G225-191	G13	G260-27	G16
G106-13	G03	G130-18	G06	G170-13	G09	G225-192	G13	G261-19	G16
G106-14	G03	G130-21	G06	G171-13	G09	G225-193	G13	G261-27	G16
G106-16	G03	G131-12	G06	G174-12	G09	G225-221	G13	G264-01	G16
G107-13	G03	G131-12N	G06	G174-16	G09	G225-222	G13	G264-02	G16
G107-14	G03	G131-12U	G06	G174-18	G09	G225-223	G13	G264-03	G16
G107-16	G03	G131-14	G06	G177-14	G10	G225-241	G13	G266-14	G16
G110-14	G04	G131-18	G06	G177-16	G10	G225-242	G13	G270-211	G17
G110-16	G04	G131-21	G06	G180-16	G10	G225-243	G13	G270-212	G17
G110-16U	G04	G131-22	G06	G180-20	G10	G230-18	G14	G270-213	G17
G111-14	G04	G132-12	G06	G181-16	G10	G230-24	G14	G270-214	G17
G111-16	G04	G132-12N	G06	G181-20	G10	G230-24N	G14	G270-215	G17
G111-16U	G04	G132-14	G06	G182-15	G10	G232-24	G14	G270-216	G17

Index Art.-Nr. Index Item No.

Art.-Nr. Item No.	Seite Page	Art.-Nr. Item No.	Seite Page	Art.-Nr. Item No.	Seite Page	Art.-Nr. Item No.	Seite Page	Art.-Nr. Item No.	Seite Page
G270-217	G17	G315-27	G21	G351-304	G25	G403-18	G31	G506-25	G35
G270-271	G17	G316-18	G21	G351-351	G25	G410-18	G31	G507-25	G35
G270-272	G17	G316-27	G21	G351-352	G25	G412-01	G31	G510-26	G36
G270-273	G17	G318-18	G21	G351-353	G25	G412-02	G31	G511-26	G36
G270-274	G17	G320-21	G21	G351-354	G25	G415-01	G32	G513-26	G36
G270-275	G17	G320-26	G21	G351-401	G25	G415-02	G32	G514-26	G36
G270-276	G17	G321-21	G21	G351-402	G25	G416-24	G32	G520-20	G36
G270-277	G17	G321-26	G21	G351-403	G25	G417-24	G32	G520-25	G36
G271-01	G17	G322-21	G21	G351-404	G25	G418-20	G32	G521-20	G36
G271-02	G17	G322-26	G21	G352-241	G25	G451-09	G32	G521-25	G36
G271-03	G17	G323-21	G21	G352-242	G25	G452-09	G32	G522-20	G36
G271-04	G17	G323-26	G21	G352-243	G25	G454-05	G32	G522-25	G36
G271-05	G17	G325-22	G22	G352-244	G25	G454-09	G32	G523-20	G36
G272-01	G17	G325-25	G22	G352-301	G25	G460-09	G32	G523-25	G36
G272-02	G17	G325-28	G22	G352-302	G25	G460-11	G32	G524-20	G37
G272-03	G17	G329-24	G22	G352-303	G25	G460-11N	G32	G525-20	G37
G272-04	G17	G330-19	G22	G352-304	G25	G460-13	G32	G526-22	G37
G275-21	G18	G330-23	G22	G352-351	G25	G460-15	G32	G526-25	G37
G278-18	G18	G335-01	G22	G352-352	G25	G462-11	G33	G526-27	G37
G278-22	G18	G335-02	G22	G352-353	G25	G462-13	G33	G527-22	G37
G278-25	G18	G336-01	G23	G352-354	G25	G464-13	G33	G527-25	G37
G278-28	G18	G336-02	G23	G361-19	G26	G464-15	G33	G527-27	G37
G281-13	G18	G336-22	G23	G361-21	G26	G465-10	G33	G530-28	G37
G281-16	G18	G338-01	G23	G361-23	G26	G465-13	G33	G531-28	G37
G281-18	G18	G338-02	G23	G362-19	G26	G467-11	G33	G532-25	G37
G281-20	G18	G340-15	G24	G362-21	G26	G467-13	G33	G533-25	G37
G281-23	G18	G340-21	G24	G362-23	G26	G468-10	G33	G535-25	G38
G281-25	G18	G340-22	G24	G363-21	G26	G468-13	G33	G536-25	G38
G281-28	G18	G340-31	G24	G364-21	G26	G470-14	G33	G538-21	G38
G297-14	G19	G340-32	G24	G365-21	G26	G471-16	G34	G539-13	G38
G298-14	G19	G342-01	G24	G366-21	G27	G472-13	G34	G550-15	G39
G298-18	G19	G342-02	G24	G367-21	G27	G472-15	G34	G550-18	G39
G300-22	G19	G342-03	G24	G368-16	G27	G472-18	G34	G550-20	G39
G301-18	G19	G342-04	G24	G369-16	G27	G472-20	G34	G551-15	G39
G301-23	G19	G350-221	G25	G371-19	G27	G474-18	G34	G551-18	G39
G305-15	G19	G350-222	G25	G375-23	G28	G490-15	G34	G551-20	G39
G305-19	G19	G350-223	G25	G375-24	G28	G490-20	G34	G554-14	G39
G306-22	G19	G350-224	G25	G376-20	G28	G490-25	G34	G556-16	G39
G307-20	G19	G350-251	G25	G377-20	G28	G500-18	G35	G556-18	G39
G308-15	G20	G350-252	G25	G378-20	G28	G500-25	G35	G600-03	G40
G308-19	G20	G350-253	G25	G379-20	G28	G500-35	G35	G600-05	G40
G311-01	G20	G350-254	G25	G380-25	G28	G500-41	G35	G600-06	G40
G311-02	G20	G351-211	G25	G383-24	G29	G500-46	G35	G601-03	G40
G311-11	G20	G351-212	G25	G384-01	G29	G501-18	G35	G601-05	G40
G311-12	G20	G351-213	G25	G384-02	G29	G501-25	G35	G601-06	G40
G312-20	G20	G351-214	G25	G385-25	G29	G501-35	G35	G602-01	G40
G314-16	G20	G351-241	G25	G387-01	G30	G501-41	G35	G602-02	G40
G314-19	G20	G351-242	G25	G387-02	G30	G502-18	G35	G602-03	G40
G314-24	G20	G351-243	G25	G390-21	G30	G502-25	G35	G602-04	G40
G314-26	G20	G351-244	G25	G400-14	G31	G503-18	G35	G602-05	G40
G314-30	G20	G351-301	G25	G400-18	G31	G503-25	G35	G602-06	G40
G314-36	G20	G351-302	G25	G400-20	G31	G505-18	G35	G602-07	G40
G315-18	G21	G351-303	G25	G402-20	G31	G505-25	G35	G603-01	G40

Index Art.-Nr. Index Item No.

Art.-Nr. Item No.	Seite Page	Art.-Nr. Item No.	Seite Page	Art.-Nr. Item No.	Seite Page	Art.-Nr. Item No.	Seite Page	Art.-Nr. Item No.	Seite Page
G603-02	G40	G712-12	G41	G720-235AN	G43	G732-120	G45	G744-25V	G46
G603-03	G40	G713-08	G41	G720-235V	G43	G732-124	G45	G744-36A	G46
G603-04	G40	G713-09	G41	G720-235VN	G43	G732-126	G45	G744-36V	G46
G603-05	G40	G713-10	G41	G720-240A	G43	G732-127	G45	G745-08A	G46
G603-06	G40	G713-12	G41	G720-240AN	G43	G732-128	G45	G745-08V	G46
G603-07	G40	G714-09	G42	G720-240V	G43	G732-130	G45	G745-11A	G46
G610-00	G40	G714-10	G42	G720-240VN	G43	G732-216	G45	G745-11V	G46
G670-02	G40	G715-09	G42	G720-250A	G43	G732-226	G45	G745-14A	G46
G670-03	G40	G715-12	G42	G720-250AN	G43	G732-316	G45	G745-14V	G46
G680-04	G40	G715-12N	G42	G720-250V	G43	G732-326	G45	G745-17A	G46
G681-04	G40	G715-21	G42	G720-250VN	G43	G732-416	G45	G745-17V	G46
G706-08	G41	G715-22	G42	G722-35	G43	G732-426	G45	G745-25A	G46
G706-12	G41	G716-04	G42	G722-45	G43	G734-01	G45	G745-25V	G46
G706-16	G41	G716-05	G42	G723-35	G43	G734-02	G45	G745-36A	G46
G706-20	G41	G717-07	G42	G723-45	G43	G734-03	G45	G745-36V	G46
G706-28	G41	G717-07N	G42	G724-05	G43	G734-11	G45	G750-01	G47
G706-32	G41	G720-030A	G43	G724-06	G43	G734-12	G45	G750-02	G47
G706-40	G41	G720-030AN	G43	G724-07	G43	G734-13	G45	G750-03	G47
G706-60	G41	G720-030V	G43	G724-09	G43	G740-01	G46	G750-21	G47
G706-64	G41	G720-030VN	G43	G724-12	G43	G740-02	G46	G750-22	G47
G706-70	G41	G720-035A	G43	G725-05	G43	G742-08A	G46	G750-70	G47
G707-08	G41	G720-035AN	G43	G725-06	G43	G742-08V	G46	G750-75	G47
G707-12	G41	G720-035V	G43	G725-07	G43	G742-11A	G46	G750-80	G47
G707-16	G41	G720-035VN	G43	G725-09	G43	G742-11V	G46	G750-96	G47
G707-20	G41	G720-040A	G43	G725-12	G43	G742-14A	G46	G755-01	G48
G707-28	G41	G720-040AN	G43	G726-05	G43	G742-14V	G46	G755-02	G48
G707-32	G41	G720-040V	G43	G727-05	G44	G742-17A	G46	G755-03	G48
G707-40	G41	G720-040VN	G43	G727-07	G44	G742-17V	G46	G755-04	G48
G707-60	G41	G720-050A	G43	G727-09	G44	G742-25A	G46	G755-05	G48
G707-64	G41	G720-050AN	G43	G727-10	G44	G742-25V	G46	G755-21	G48
G707-70	G41	G720-050V	G43	G727-21	G44	G742-36A	G46	G756-01	G48
G708-60	G41	G720-050VN	G43	G728-06	G44	G742-36V	G46	G756-02	G48
G708-64	G41	G720-130A	G43	G728-07	G44	G743-08A	G46	G756-03	G48
G708-70	G41	G720-130AN	G43	G728-09	G44	G743-08V	G46	G756-04	G48
G710-08	G41	G720-130V	G43	G728-11	G44	G743-11A	G46	G760-10	G49
G710-08N	G41	G720-130VN	G43	G729-06	G44	G743-11V	G46	G760-11	G49
G710-09	G41	G720-135A	G43	G729-07	G44	G743-14A	G46	G760-12	G49
G710-09N	G41	G720-135AN	G43	G729-09	G44	G743-14V	G46	G760-13	G49
G710-10	G41	G720-135V	G43	G729-11	G44	G743-17A	G46	G760-14	G49
G710-10N	G41	G720-135VN	G43	G730-00	G44	G743-17V	G46	G760-20	G49
G710-12N	G41	G720-140A	G43	G730-01	G44	G743-25A	G46	G760-21	G49
G710-13	G41	G720-140AN	G43	G730-02	G44	G743-25V	G46	G760-22	G49
G711-08	G41	G720-140V	G43	G730-03	G44	G743-36A	G46	G760-30	G49
G711-08N	G41	G720-140VN	G43	G732-001	G45	G743-36V	G46	G760-40	G49
G711-09	G41	G720-150A	G43	G732-002	G45	G744-08A	G46	G760-51	G49
G711-09N	G41	G720-150AN	G43	G732-003	G45	G744-08V	G46	H106-12	H03
G711-10	G41	G720-150V	G43	G732-104	G45	G744-11A	G46	H108-13	H03
G711-10N	G41	G720-150VN	G43	G732-106	G45	G744-11V	G46	H108-18	H03
G711-12N	G41	G720-230A	G43	G732-108	G45	G744-14A	G46	H110-13	H03
G711-13	G41	G720-230AN	G43	G732-110	G45	G744-14V	G46	H110-13T	H03
G712-08	G41	G720-230V	G43	G732-114	G45	G744-17A	G46	H110-63	H03
G712-09	G41	G720-230VN	G43	G732-116	G45	G744-17V	G46	H110-63T	H03
G712-10	G41	G720-235A	G43	G732-118	G45	G744-25A	G46	H112-11T	H03

Index Art.-Nr. Index Item No.

Art.-Nr. Item No.	Seite Page	Art.-Nr. Item No.	Seite Page	Art.-Nr. Item No.	Seite Page	Art.-Nr. Item No.	Seite Page	Art.-Nr. Item No.	Seite Page
H112-13T	H03	H150-20T	H06	H162-30T	H08	H178-25T	H10	H220-14T	H13
H114-13T	H03	H150-22ND	H06	H162-37T	H08	H178-65T	H10	H220-17	H13
H115-13T	H03	H150-22NT	H06	H164-16T	H08	H178-68T	H10	H220-17T	H13
H116-12T	H03	H150-22T	H06	H164-18T	H08	H178-73T	H10	H220-20	H13
H116-62T	H03	H150-24	H06	H164-20T	H08	H180-12T	H10	H220-20T	H13
H117-12ND	H04	H150-24NT	H06	H164-23T	H08	H180-15D	H10	H220-24T	H13
H117-12NT	H04	H150-24T	H06	H164-24T	H08	H180-15ND	H10	H221-14	H13
H117-12T	H04	H150-26	H06	H164-26T	H08	H180-15NT	H10	H221-17	H13
H118-12	H04	H150-26ND	H06	H164-31T	H08	H180-15T	H10	H221-20	H13
H119-12	H04	H150-26T	H06	H165-12D	H08	H180-18D	H10	H222-14	H14
H120-12T	H04	H150-30	H06	H165-14D	H08	H180-18ND	H10	H222-17	H14
H120-13T	H04	H150-30T	H06	H165-16D	H08	H180-18NT	H10	H222-17T	H14
H120-62T	H04	H150-35T	H06	H165-16D	H08	H180-18T	H10	H222-20	H14
H120-63T	H04	H151-16	H06	H165-18D	H08	H180-20D	H10	H222-20T	H14
H128-13	H04	H151-16T	H06	H165-20D	H08	H180-20ND	H10	H222-24T	H14
H128-13T	H04	H151-18T	H06	H165-23D	H08	H180-20NT	H10	H223-17T	H14
H128-15	H04	H151-20	H06	H166-23	H09	H180-20T	H10	H223-20T	H14
H128-15T	H04	H151-20T	H06	H166-23T	H09	H180-23D	H10	H224-14T	H14
H130-15T	H04	H151-24T	H06	H175-15T	H09	H180-23T	H10	H224-17T	H14
H132-15	H05	H151-26T	H06	H175-18T	H09	H180-26D	H10	H224-20T	H14
H132-15T	H05	H151-30T	H06	H175-20T	H09	H180-26T	H10	H226-14T	H15
H132-18	H05	H152-14T	H07	H175-23T	H09	H180-62T	H10	H226-14T	H15
H132-18T	H05	H152-16	H07	H176-14T	H09	H180-65T	H10	H226-17T	H15
H132-20	H05	H152-16T	H07	H176-16ND	H09	H180-68T	H10	H226-17T	H15
H132-20T	H05	H152-18	H07	H176-16NT	H09	H180-70T	H10	H226-20T	H15
H132-23T	H05	H152-18T	H07	H176-16T	H09	H180-73T	H10	H226-20T	H15
H132-26T	H05	H152-20	H07	H176-18ND	H09	H180-76T	H10	H228-17T	H15
H132-31T	H05	H154-16	H07	H176-18NT	H09	H182-15T	H11	H228-20T	H15
H132-65T	H05	H154-18	H07	H176-18T	H09	H182-17T	H11	H228-24T	H15
H132-68T	H05	H154-20	H07	H176-20ND	H09	H182-20T	H11	H230-16T	H15
H132-70T	H05	H154-20T	H07	H176-20NT	H09	H186-18	H11	H230-18T	H15
H132-73T	H05	H154-24T	H07	H176-20T	H09	H186-18T	H11	H230-20T	H15
H132-76T	H05	H155-20	H07	H176-22ND	H09	H186-20T	H11	H231-20T	H15
H132-81T	H05	H156-18	H07	H176-22NT	H09	H186-26	H11	H232-18	H16
H133-18T	H05	H156-18T	H07	H176-22T	H09	H186-26T	H11	H232-18T	H16
H133-20T	H05	H157-18	H07	H176-25ND	H09	H189-20T	H11	H233-20T	H16
H133-23T	H05	H160-20T	H07	H176-25NT	H09	H189-23T	H11	H233-25T	H16
H134-15	H05	H160-24T	H07	H176-25T	H09	H192-27	H12	H234-20	H16
H138-20T	H05	H160-26T	H07	H178-13T	H10	H192-27T	H12	H234-20T	H16
H145-14	H05	H162-16ND	H08	H178-15T	H10	H194-27	H12	H235-20T	H16
H145-14T	H05	H162-16NT	H08	H178-16ND	H10	H194-27T	H12	H235-25T	H16
H150-14	H06	H162-18ND	H08	H178-16NT	H10	H195-20T	H12	H236-20T	H16
H150-16	H06	H162-18NT	H08	H178-18ND	H10	H195-27	H12	H236-23T	H16
H150-16ND	H06	H162-18T	H08	H178-18NT	H10	H195-27T	H12	H240-11	H17
H150-16NT	H06	H162-20ND	H08	H178-18T	H10	H195-30T	H12	H240-11T	H17
H150-16T	H06	H162-20NT	H08	H178-20ND	H10	H210-12	H13	H240-14	H17
H150-18	H06	H162-20T	H08	H178-20NT	H10	H210-12T	H13	H240-14T	H17
H150-18ND	H06	H162-22NT	H08	H178-20T	H10	H212-16	H13	H240-17	H17
H150-18NT	H06	H162-23ND	H08	H178-22T	H10	H212-16T	H13	H240-17T	H17
H150-18T	H06	H162-23T	H08	H178-23ND	H10	H213-16	H13	H240-18	H17
H150-20	H06	H162-26ND	H08	H178-23NT	H10	H213-16T	H13	H240-18T	H17
H150-20ND	H06	H162-26NT	H08	H178-25ND	H10	H218-15	H13	H240-61	H17
H150-20NT	H06	H162-26T	H08	H178-25NT	H10	H220-14	H13	H240-61T	H17

Index Art.-Nr. Index Item No.

Art.-Nr. Item No.	Seite Page	Art.-Nr. Item No.	Seite Page	Art.-Nr. Item No.	Seite Page	Art.-Nr. Item No.	Seite Page	Art.-Nr. Item No.	Seite Page
H244-15	H17	H330-71T	H19	H332-73T	H20	H345-21D	H22	H381-24	H24
H244-15L	H17	H330-73T	H19	H333-14	H20	H345-21T	H22	H386-20D	H24
H244-15T	H17	H331-14	H19	H333-14D	H20	H345-22	H22	H386-20ND	H24
H244-15TL	H17	H331-14D	H19	H333-14T	H20	H345-22D	H22	H386-22D	H24
H245-16	H17	H331-14T	H19	H333-15N	H20	H345-22T	H22	H386-22ND	H24
H245-16L	H17	H331-15N	H19	H333-15ND	H20	H345-71T	H22	H386-24D	H24
H245-16T	H17	H331-15ND	H19	H333-18	H20	H345-72T	H22	H386-24ND	H24
H245-16TL	H17	H331-18	H19	H333-18D	H20	H346-21	H22	H387-20D	H24
H300-16T	H18	H331-18D	H19	H333-18N	H20	H346-21D	H22	H387-20ND	H24
H300-18D	H18	H331-18N	H19	H333-18ND	H20	H346-21T	H22	H387-22D	H24
H300-18T	H18	H331-18ND	H19	H333-18T	H20	H346-22	H22	H387-22ND	H24
H300-20T	H18	H331-18T	H19	H333-21	H20	H346-22D	H22	H387-24D	H24
H300-23D	H18	H331-21	H19	H333-21D	H20	H346-22T	H22	H387-24ND	H24
H300-23T	H18	H331-21D	H19	H333-21N	H20	H346-71T	H22	H400-11	H25
H300-25T	H18	H331-21N	H19	H333-21ND	H20	H346-72T	H22	H400-11D	H25
H310-09	H18	H331-21ND	H19	H333-21T	H20	H347-21	H22	H400-11ND	H25
H310-09D	H18	H331-21T	H19	H333-23	H20	H347-21D	H22	H400-12D	H25
H310-14	H18	H331-23	H19	H333-23D	H20	H347-21T	H22	H400-13	H25
H311-09	H18	H331-23D	H19	H333-23N	H20	H347-22	H22	H400-13D	H25
H311-09D	H18	H331-23N	H19	H333-23ND	H20	H347-22D	H22	H400-13ND	H25
H311-14	H18	H331-23ND	H19	H333-23T	H20	H347-22T	H22	H400-13T	H25
H312-09	H18	H331-23T	H19	H333-64T	H20	H347-71T	H22	H400-14	H25
H312-09D	H18	H331-64T	H19	H333-68T	H20	H347-72T	H22	H400-14D	H25
H312-14	H18	H331-68T	H19	H333-71T	H20	H360-16	H23	H400-14N	H25
H313-09	H18	H331-71T	H19	H333-73T	H20	H360-16D	H23	H400-14ND	H25
H313-09D	H18	H331-73T	H19	H336-18T	H21	H360-18	H23	H400-14T	H25
H313-14	H18	H332-14	H20	H336-20T	H21	H360-18D	H23	H400-21	H25
H330-14	H19	H332-14D	H20	H336-23T	H21	H361-16	H23	H400-23	H25
H330-14D	H19	H332-14T	H20	H340-18	H21	H361-16D	H23	H400-24	H25
H330-14T	H19	H332-15N	H20	H340-18D	H21	H361-18	H23	H400-63T	H25
H330-15N	H19	H332-15ND	H20	H340-20	H21	H361-18D	H23	H400-64T	H25
H330-15ND	H19	H332-17D	H20	H340-20D	H21	H362-16	H23	H401-11	H25
H330-17 D	H19	H332-18	H20	H341-18	H21	H362-16D	H23	H401-12D	H25
H330-18	H19	H332-18D	H20	H341-18D	H21	H362-18	H23	H401-13	H25
H330-18D	H19	H332-18N	H20	H341-20	H21	H362-18D	H23	H401-13D	H25
H330-18N	H19	H332-18ND	H20	H341-20D	H21	H363-16	H23	H401-13T	H25
H330-18ND	H19	H332-18NT	H20	H342-18	H21	H363-16D	H23	H401-14	H25
H330-18NT	H19	H332-18T	H20	H342-18D	H21	H363-18	H23	H401-14D	H25
H330-18T	H19	H332-21	H20	H342-20	H21	H363-18D	H23	H401-14N	H25
H330-21	H19	H332-21D	H20	H342-20D	H21	H370-16	H23	H401-14T	H25
H330-21D	H19	H332-21N	H20	H343-18	H21	H370-18	H23	H401-21	H25
H330-21N	H19	H332-21ND	H20	H343-18D	H21	H371-16	H23	H401-23	H25
H330-21ND	H19	H332-21NT	H20	H343-20	H21	H371-18	H23	H401-24	H25
H330-21NT	H19	H332-21T	H20	H343-20D	H21	H380-20	H24	H401-63T	H25
H330-21T	H19	H332-23	H20	H344-21	H22	H380-20N	H24	H401-64T	H25
H330-23	H19	H332-23D	H20	H344-21D	H22	H380-22	H24	H402-11	H25
H330-23D	H19	H332-23N	H20	H344-21T	H22	H380-22N	H24	H402-12D	H25
H330-23N	H19	H332-23ND	H20	H344-22	H22	H381-16	H24	H402-13	H25
H330-23ND	H19	H332-23NT	H20	H344-22D	H22	H381-16N	H24	H402-13D	H25
H330-23NT	H19	H332-23T	H20	H344-22T	H22	H381-20	H24	H402-13T	H25
H330-23T	H19	H332-64T	H20	H344-71T	H22	H381-20N	H24	H402-14	H25
H330-64T	H19	H332-68T	H20	H344-72T	H22	H381-22	H24	H402-14D	H25
H330-68T	H19	H332-71T	H20	H345-21	H22	H381-22N	H24	H402-14N	H25

Index Art.-Nr. Index Item No.

Art.-Nr. Item No.	Seite Page	Art.-Nr. Item No.	Seite Page	Art.-Nr. Item No.	Seite Page	Art.-Nr. Item No.	Seite Page	Art.-Nr. Item No.	Seite Page
H402-14T	H25	H421-18T	H26	H423-25T	H27	H442-18D	H29	H473-63	H30
H402-21	H25	H421-21	H26	H423-68T	H27	H442-18N	H29	H473-63T	H30
H402-23	H25	H421-21D	H26	H423-71T	H27	H442-18ND	H29	H476-18T	H31
H402-24	H25	H421-21N	H26	H423-73T	H27	H442-21	H29	H476-68T	H31
H402-63T	H25	H421-21ND	H26	H423-75T	H27	H442-21D	H29	H480-14	H31
H402-64T	H25	H421-21T	H26	H424-23D	H28	H442-21N	H29	H480-14T	H31
H403-11	H25	H421-23	H26	H424-73D	H28	H442-21ND	H29	H480-64T	H31
H403-12D	H25	H421-23D	H26	H425-23D	H28	H442-23	H29	H481-14	H31
H403-13	H25	H421-23N	H26	H426-18T	H28	H442-23D	H29	H481-14T	H31
H403-13D	H25	H421-23ND	H26	H427-18T	H28	H443-15	H29	H481-64T	H31
H403-13T	H25	H421-23T	H26	H428-18T	H28	H443-15D	H29	H482-14	H31
H403-14	H25	H421-25	H26	H429-18T	H28	H443-15N	H29	H482-14T	H31
H403-14D	H25	H421-25D	H26	H430-15	H28	H443-15ND	H29	H484-14	H31
H403-14N	H25	H421-25T	H26	H430-15D	H28	H443-18	H29	H484-64T	H31
H403-14T	H25	H421-68T	H26	H431-15	H28	H443-18D	H29	H485-14	H31
H403-21	H25	H421-71T	H26	H431-15D	H28	H443-18N	H29	H485-64T	H31
H403-23	H25	H421-73T	H26	H432-15	H28	H443-18ND	H29	H500-01	H32
H403-24	H25	H421-75T	H26	H432-15D	H28	H443-21	H29	H500-02	H32
H403-63T	H25	H422-16D	H27	H433-15	H28	H443-21D	H29	H501-01	H32
H403-64T	H25	H422-18	H27	H433-15D	H28	H443-21N	H29	H501-02	H32
H404-10	H25	H422-18D	H27	H440-15	H29	H443-21ND	H29	H505-01	H32
H406-10	H25	H422-18N	H27	H440-15D	H29	H443-23	H29	H505-02	H32
H407-10	H25	H422-18ND	H27	H440-15N	H29	H443-23D	H29	H507-14	H32
H408-10	H25	H422-18T	H27	H440-15ND	H29	H460-19D	H30	H508-14	H32
H409-10	H25	H422-21	H27	H440-18	H29	H460-23D	H30	H509-01	H32
H420-16D	H26	H422-21D	H27	H440-18D	H29	H460-25D	H30	H509-02	H32
H420-18	H26	H422-21N	H27	H440-18N	H29	H461-19D	H30	H510-01	H33
H420-18D	H26	H422-21ND	H27	H440-18ND	H29	H461-23D	H30	H510-02	H33
H420-18N	H26	H422-21T	H27	H440-21	H29	H461-25D	H30	H511-01	H33
H420-18ND	H26	H422-23	H27	H440-21D	H29	H462-19D	H30	H511-02	H33
H420-18T	H26	H422-23D	H27	H440-21N	H29	H462-23D	H30	H512-01	H33
H420-21	H26	H422-23N	H27	H440-21ND	H29	H462-25D	H30	H512-02	H33
H420-21D	H26	H422-23ND	H27	H440-23	H29	H463-19D	H30	H513-01	H33
H420-21N	H26	H422-23T	H27	H441-15	H29	H463-23D	H30	H513-02	H33
H420-21ND	H26	H422-25	H27	H441-15D	H29	H463-25D	H30	H514-01	H33
H420-21T	H26	H422-25D	H27	H441-15N	H29	H464-23D	H30	H514-02	H33
H420-23	H26	H422-25T	H27	H441-15ND	H29	H464-73D	H30	H514-11	H33
H420-23D	H26	H422-68T	H27	H441-18	H29	H465-23D	H30	H514-12	H33
H420-23N	H26	H422-71T	H27	H441-18D	H29	H465-73D	H30	H518-211	H34
H420-23ND	H26	H422-73T	H27	H441-18ND	H29	H470-62	H30	H518-212	H34
H420-23T	H26	H422-75T	H27	H441-21	H29	H470-62T	H30	H518-241	H34
H420-25	H26	H423-16D	H27	H441-21D	H29	H470-63	H30	H518-242	H34
H420-25D	H26	H423-18	H27	H441-21ND	H29	H470-63T	H30	H518-271	H34
H420-25T	H26	H423-18D	H27	H441-23	H29	H471-62	H30	H518-272	H34
H420-68T	H26	H423-18T	H27	H441-23D	H29	H471-62T	H30	H518-281	H34
H420-71T	H26	H423-21	H27	H442-15	H29	H471-63	H30	H518-282	H34
H420-73T	H26	H423-21D	H27	H442-15D	H29	H471-63T	H30	H519-211	H34
H420-75T	H26	H423-21T	H27	H442-15ND	H29	H472-62	H30	H519-212	H34
H421-16D	H26	H423-23	H27	H442-15N	H29	H472-62T	H30	H519-271	H34
H421-18	H26	H423-23D	H27	H442-15ND	H29	H472-63	H30	H519-272	H34
H421-18D	H26	H423-23T	H27	H442-18	H29	H472-63T	H30	H530-01	H35
H421-18N	H26	H423-25	H27			H473-62	H30	H530-02	H35
H421-18ND	H26	H423-25D	H27			H473-62T	H30	H530-03	H35

Index Art.-Nr. Index Item No.

Art.-Nr. Item No.	Seite Page	Art.-Nr. Item No.	Seite Page	Art.-Nr. Item No.	Seite Page	Art.-Nr. Item No.	Seite Page	Art.-Nr. Item No.	Seite Page
H534-19	H35	H610-00	H41	K101-114	K02	K118-110	K03	K122-219	K04
H536-23	H35	H616-12	H41	K101-115	K02	K118-112	K03	K126-102	K04
H537-21	H35	H618-12	H41	K101-116	K02	K118-114	K03	K126-103	K04
H539-25	H35	H620-12	H41	K101-117	K02	K118-115	K03	K126-104	K04
H545-141	H36	H622-12	H41	K101-118	K02	K118-118	K03	K126-105	K04
H545-142	H36	H625-01	H41	K101-132	K02	K118-119	K03	K126-106	K04
H545-143	H36	H625-02	H41	K101-133	K02	K118-120	K03	K126-107	K04
H545-144	H36	H652-18	H42	K101-134	K02	K118-202	K03	K126-108	K04
H545-191	H36	H654-20	H42	K101-135	K02	K118-204	K03	K126-109	K04
H545-192	H36	H656-00	H42	K101-136	K02	K118-206	K03	K126-110	K04
H545-193	H36	H680-28	H42	K101-137	K02	K118-208	K03	K126-112	K04
H545-194	H36	H682-30	H42	K101-138	K02	K118-210	K03	K126-113	K04
H545-221	H36	H684-28	H42	K106-04	K02	K118-212	K03	K126-115	K04
H545-222	H36	H690-23	H42	K106-06	K02	K118-214	K03	K126-116	K04
H545-223	H36	H695-18	H42	K106-08	K02	K118-502	K03	K126-119	K04
H545-224	H36	H695-24	H42	K106-10	K02	K118-503	K03	K126-202	K04
H546-00	H36	H700-00	H43	K106-12	K02	K118-504	K03	K126-203	K04
H546-01	H36	H701-00	H43	K106-14	K02	K118-506	K03	K126-204	K04
H546-02	H36	H702-00	H44	K106-16	K02	K118-508	K03	K126-205	K04
H546-03	H36	H705-01	H44	K107-04	K02	K118-510	K03	K126-206	K04
H551-19	H37	H705-02	H44	K107-06	K02	K118-512	K03	K126-207	K04
H552-19	H37	H705-11	H44	K107-08	K02	K118-515	K03	K126-208	K04
H555-18	H37	H705-12	H44	K107-10	K02	K119-104	K03	K126-209	K04
H555-27	H37	H705-13	H44	K107-12	K02	K119-105	K03	K126-210	K04
H557-01	H37	H705-14	H44	K107-14	K02	K119-106	K03	K126-212	K04
H557-02	H37	H705-21	H44	K107-16	K02	K119-108	K03	K126-213	K04
H557-03	H37	H705-22	H44	K108-04	K02	K119-110	K03	K126-215	K04
H564-22	H37	H705-23	H44	K108-06	K02	K119-112	K03	K126-216	K04
H565-19	H37	H705-24	H44	K108-08	K02	K119-116	K03	K126-504	K04
H565-22	H37	H705-31	H44	K108-10	K02	K119-119	K03	K126-506	K04
H567-24	H37	H705-32	H44	K108-12	K02	K119-122	K03	K126-510	K04
H568-25	H38	H705-41	H44	K108-14	K02	K119-125	K03	K126-513	K04
H570-28	H38	H705-42	H44	K108-16	K02	K122-104	K04	K126-516	K04
H575-01	H38	H705-51	H44	K110-04	K02	K122-106	K04	K130-04	K04
H575-02	H38	H705-52	H44	K110-06	K02	K122-108	K04	K130-06	K04
H576-01	H39	H705-61	H44	K111-04	K02	K122-110	K04	K130-08	K04
H576-02	H39	H705-62	H44	K111-06	K02	K122-113	K04	K130-10	K04
H576-03	H39	K100-112	K02	K113-06	K03	K122-116	K04	K130-12	K04
H576-04	H39	K100-113	K02	K113-12	K03	K122-118	K04	K130-14	K04
H580-23	H40	K100-114	K02	K113-18	K03	K122-119	K04	K131-04	K04
H582-23	H40	K100-115	K02	K114-06	K03	K122-120	K04	K131-08	K04
H600-07	H40	K100-116	K02	K114-12	K03	K122-125	K04	K131-10	K04
H600-11	H40	K100-117	K02	K114-18	K03	K122-130	K04	K131-12	K04
H600-12	H40	K100-118	K02	K115-06	K03	K122-132	K04	K131-14	K04
H600-14	H40	K100-132	K02	K115-12	K03	K122-138	K04	K134-104	K04
H600-16	H40	K100-133	K02	K115-14	K03	K122-144	K04	K134-106	K04
H600-18	H40	K100-134	K02	K116-01	K03	K122-150	K04	K134-108	K04
H600-20	H40	K100-135	K02	K116-02	K03	K122-204	K04	K134-110	K04
H600-22	H40	K100-136	K02	K118-102	K03	K122-208	K04	K134-112	K04
H602-12	H40	K100-137	K02	K118-103	K03	K122-210	K04	K135-104	K04
H604-12	H40	K100-138	K02	K118-104	K03	K122-213	K04	K135-108	K04
H606-13	H40	K101-112	K02	K118-106	K03	K122-216	K04	K135-110	K04
H608-14	H40	K101-113	K02	K118-108	K03	K122-218	K04	K135-112	K04

Index Art.-Nr. Index Item No.

Art.-Nr. Item No.	Seite Page	Art.-Nr. Item No.	Seite Page	Art.-Nr. Item No.	Seite Page	Art.-Nr. Item No.	Seite Page	Art.-Nr. Item No.	Seite Page
K136-105	K04	K146-113	K05	K151-506	K06	K157-128	K06	K169-22	K08
K136-107	K04	K146-116	K05	K151-508	K06	K157-132	K06	K170-01	K08
K136-110	K04	K146-119	K05	K151-510	K06	K157-138	K06	K170-11	K08
K136-115	K04	K146-125	K05	K151-512	K06	K157-206	K06	K171-110	K08
K136-120	K04	K146-132	K05	K151-515	K06	K157-209	K06	K171-115	K08
K136-125	K04	K146-206	K05	K151-520	K06	K157-213	K06	K172-110	K08
K136-130	K04	K146-210	K05	K151-525	K06	K157-216	K06	K172-115	K08
K137-105	K04	K146-213	K05	K151-530	K06	K157-219	K06	K174-104	K09
K137-110	K04	K146-216	K05	K152-106	K06	K157-222	K06	K174-105	K09
K137-115	K04	K146-219	K05	K152-108	K06	K157-225	K06	K174-106	K09
K137-120	K04	K146-225	K05	K152-110	K06	K157-228	K06	K174-108	K09
K137-125	K04	K146-232	K05	K152-112	K06	K157-232	K06	K174-110	K09
K137-130	K04	K147-106	K05	K152-114	K06	K157-238	K06	K174-112	K09
K138-05	K05	K147-110	K05	K152-115	K06	K158-106	K06	K174-115	K09
K138-09	K05	K147-113	K05	K152-118	K06	K158-109	K06	K174-120	K09
K140-106	K05	K147-116	K05	K152-120	K06	K158-113	K06	K174-122	K09
K140-109	K05	K147-119	K05	K152-122	K06	K158-116	K06	K174-125	K09
K140-113	K05	K147-125	K05	K152-125	K06	K158-119	K06	K174-204	K09
K140-116	K05	K147-132	K05	K152-130	K06	K158-122	K06	K174-205	K09
K140-119	K05	K147-206	K05	K152-506	K06	K158-125	K06	K174-206	K09
K140-125	K05	K147-210	K05	K152-508	K06	K158-128	K06	K174-208	K09
K140-132	K05	K147-213	K05	K152-510	K06	K158-132	K06	K174-210	K09
K140-206	K05	K147-216	K05	K152-512	K06	K158-138	K06	K174-212	K09
K140-209	K05	K147-219	K05	K152-515	K06	K158-206	K06	K174-215	K09
K140-213	K05	K147-225	K05	K152-520	K06	K158-209	K06	K174-220	K09
K140-216	K05	K147-232	K05	K152-525	K06	K158-213	K06	K174-222	K09
K140-219	K05	K150-106	K06	K156-106	K06	K158-216	K06	K174-225	K09
K140-225	K05	K150-108	K06	K156-109	K06	K158-219	K06	K175-104	K09
K140-232	K05	K150-110	K06	K156-113	K06	K158-222	K06	K175-105	K09
K141-106	K05	K150-112	K06	K156-116	K06	K158-225	K06	K175-106	K09
K141-109	K05	K150-114	K06	K156-119	K06	K158-228	K06	K175-108	K09
K141-113	K05	K150-115	K06	K156-122	K06	K158-232	K06	K175-110	K09
K141-116	K05	K150-118	K06	K156-125	K06	K158-238	K06	K175-112	K09
K141-119	K05	K150-120	K06	K156-128	K06	K161-23	K07	K175-115	K09
K141-125	K05	K150-122	K06	K156-132	K06	K162-22	K07	K175-120	K09
K141-132	K05	K150-125	K06	K156-138	K06	K164-105	K07	K175-122	K09
K141-206	K05	K150-130	K06	K156-206	K06	K164-110	K07	K175-125	K09
K141-209	K05	K151-106	K06	K156-209	K06	K164-115	K07	K175-204	K09
K141-213	K05	K151-108	K06	K156-213	K06	K164-305	K07	K175-205	K09
K141-216	K05	K151-110	K06	K156-216	K06	K164-315	K07	K175-206	K09
K141-219	K05	K151-112	K06	K156-219	K06	K166-01	K07	K175-208	K09
K141-225	K05	K151-114	K06	K156-222	K06	K166-02	K07	K175-210	K09
K141-232	K05	K151-115	K06	K156-225	K06	K166-03	K07	K175-212	K09
K145-01	K05	K151-118	K06	K156-228	K06	K166-04	K07	K175-215	K09
K145-02	K05	K151-120	K06	K156-232	K06	K166-11	K07	K175-220	K09
K145-03	K05	K151-122	K06	K156-238	K06	K166-12	K07	K175-222	K09
K145-04	K05	K151-125	K06	K157-106	K06	K166-13	K07	K175-225	K09
K145-11	K05	K151-130	K06	K157-109	K06	K166-14	K07	K179-01	K09
K145-12	K05	K151-210	K06	K157-113	K06	K166-61	K07	K179-02	K09
K145-13	K05	K151-212	K06	K157-116	K06	K166-62	K07	K179-03	K09
K145-22	K05	K151-215	K06	K157-119	K06	K166-63	K07	K179-11	K09
K146-106	K05	K151-220	K06	K157-122	K06	K166-64	K07	K179-12	K09
K146-110	K05	K151-225	K06	K157-125	K06	K168-19	K08	K179-13	K09

Index Art.-Nr. Index Item No.

Art.-Nr. Item No.	Seite Page	Art.-Nr. Item No.	Seite Page	Art.-Nr. Item No.	Seite Page	Art.-Nr. Item No.	Seite Page	Art.-Nr. Item No.	Seite Page
K185-01	K10	K215-19	K13	K250-60	K18	K257-205	K19	K262-02	K20
K185-05	K10	K217-19	K14	K250-70	K18	K257-206	K19	K262-10	K20
K185-10	K10	K218-19	K14	K250-80	K18	K257-210	K19	K262-20	K20
K185-16	K10	K220-19	K14	K250-90	K18	K257-220	K19	K263-01	K20
K185-25	K10	K221-20	K14	K252-01	K18	K257-330	K19	K263-02	K20
K185-55	K10	K222-23	K14	K252-02	K18	K258-101	K19	K263-10	K20
K185-60	K10	K224-23	K14	K252-03	K18	K258-102	K19	K263-20	K20
K185-66	K10	K227-30	K15	K252-04	K18	K258-103	K19	K266-01	K20
K185-75	K10	K227-35	K15	K252-05	K18	K258-104	K19	K266-02	K20
K185-85	K10	K227-40	K15	K252-06	K18	K258-105	K19	K268-01	K20
K185-86	K10	K227-45	K15	K252-10	K18	K258-106	K19	K268-02	K20
K185-87	K10	K227-50	K15	K252-20	K18	K258-110	K19	K268-10	K20
K185-98	K10	K228-24	K15	K252-30	K18	K258-120	K19	K268-20	K20
K190-02	K11	K228-51	K15	K254-01	K18	K258-130	K19	K269-01	K20
K190-03	K11	K230-23	K15	K254-02	K18	K258-201	K19	K269-02	K20
K190-04	K11	K230-23	K15	K254-03	K18	K258-202	K19	K269-03	K20
K190-05	K11	K232-20	K15	K254-04	K18	K258-203	K19	K270-01	K21
K190-06	K11	K232-22	K15	K254-10	K18	K258-204	K19	K270-02	K21
K190-08	K11	K233-01	K15	K254-20	K18	K258-205	K19	K270-03	K21
K190-10	K11	K233-02	K15	K254-30	K18	K258-206	K19	K270-04	K21
K190-20	K11	K235-02	K16	K256-01	K19	K258-210	K19	K270-05	K21
K191-02	K11	K235-03	K16	K256-02	K19	K258-220	K19	K270-06	K21
K191-03	K11	K236-24	K16	K256-03	K19	K258-230	K19	K270-07	K21
K192-03	K11	K237-23	K16	K256-04	K19	K258-301	K19	K271-10	K21
K192-05	K11	K238-01	K16	K256-05	K19	K258-302	K19	K271-20	K21
K192-08	K11	K238-02	K16	K256-06	K19	K258-303	K19	K271-30	K21
K192-12	K11	K242-23	K17	K256-10	K19	K258-304	K19	K272-01	K21
K192-14	K11	K242-51	K17	K256-20	K19	K258-305	K19	K272-02	K21
K192-16	K11	K242-52	K17	K256-30	K19	K258-306	K19	K272-03	K21
K195-08	K11	K242-53	K17	K256-40	K19	K258-310	K19	K274-10	K21
K195-10	K11	K245-24	K17	K256-50	K19	K258-320	K19	K274-20	K21
K195-15	K11	K246-35	K17	K257-001	K19	K258-330	K19	K274-30	K21
K195-20	K11	K246-43	K17	K257-002	K19	K259-02	K20	K274-40	K21
K200-01	K12	K246-50	K17	K257-003	K19	K259-03	K20	K290-03	K21
K200-02	K12	K247-01	K17	K257-004	K19	K259-04	K20	K290-04	K21
K201-17	K12	K247-02	K17	K257-005	K19	K259-05	K20	K290-05	K21
K201-51	K12	K248-17	K17	K257-006	K19	K259-06	K20	K292-01	K21
K203-14	K12	K250-01	K18	K257-010	K19	K259-07	K20	K292-02	K21
K205-18	K12	K250-02	K18	K257-020	K19	K259-08	K20	K292-03	K21
K206-18	K12	K250-03	K18	K257-030	K19	K259-10	K20	K292-04	K21
K206-51	K12	K250-04	K18	K257-101	K19	K259-12	K20	K292-11	K21
K208-20	K12	K250-05	K18	K257-102	K19	K259-14	K20	K292-12	K21
K209-01	K13	K250-06	K18	K257-103	K19	K260-02	K20	K292-13	K21
K209-02	K13	K250-10	K18	K257-104	K19	K260-03	K20	K292-14	K21
K209-91	K13	K250-20	K18	K257-105	K19	K260-04	K20	K294-01	K22
K209-92	K13	K250-30	K18	K257-106	K19	K260-05	K20	K294-02	K22
K210-19	K13	K250-40	K18	K257-110	K19	K260-06	K20	K294-03	K22
K211-18	K13	K250-51	K18	K257-120	K19	K260-07	K20	K294-11	K22
K211-20	K13	K250-52	K18	K257-130	K19	K260-08	K20	K294-12	K22
K212-18	K13	K250-53	K18	K257-201	K19	K260-10	K20	K294-13	K22
K213-01	K13	K250-54	K18	K257-202	K19	K260-12	K20	K295-01	K22
K213-02	K13	K250-55	K18	K257-203	K19	K260-14	K20	K295-02	K22
K213-11	K13	K250-56	K18	K257-204	K19	K262-01	K20	K295-03	K22

Index Art.-Nr. Index Item No.

Art.-Nr. Item No.	Seite Page	Art.-Nr. Item No.	Seite Page	Art.-Nr. Item No.	Seite Page	Art.-Nr. Item No.	Seite Page	Art.-Nr. Item No.	Seite Page
K295-10	K22	K301-20	K23	K375-02	K27	K430-63	K32	K486-09	K37
K296-01	K22	K301-30	K23	K376-19	K27	K430-69	K32	K486-12	K37
K296-02	K22	K306-03	K23	K378-18	K28	K430-75	K32	K486-19	K37
K296-03	K22	K306-06	K23	K380-16	K28	K431-09	K32	K486-20	K37
K296-04	K22	K306-08	K23	K382-17	K28	K431-13	K32	K492-13	K37
K296-05	K22	K306-13	K23	K384-18	K28	K431-19	K32	K492-19	K37
K296-06	K22	K306-16	K23	K385-21	K28	K431-25	K32	K492-25	K37
K296-10	K22	K306-18	K23	K388-01	K28	K431-32	K32	K492-30	K37
K296-20	K22	K310-00	K24	K388-02	K28	K431-75	K32	K494-32	K37
K296-30	K22	K310-01	K24	K392-01	K28	K431-82	K32	K495-01	K38
K296-51	K22	K310-02	K24	K392-02	K28	K433-27	K33	K495-02	K38
K296-52	K22	K311-01	K24	K397-19	K29	K434-08	K33	K496-23	K38
K296-53	K22	K311-02	K24	K400-05	K29	K434-17	K33	K497-25	K38
K296-54	K22	K311-03	K24	K400-10	K29	K440-15	K34	K498-21	K38
K296-55	K22	K312-13	K24	K400-15	K29	K441-01	K34	K500-12	K38
K296-56	K22	K313-13	K24	K400-20	K29	K441-02	K34	K500-14	K38
K296-60	K22	K313-14	K24	K400-25	K29	K443-16	K34	K502-14	K38
K296-70	K22	K313-17	K24	K404-19	K29	K443-17	K34	K505-05	K38
K296-80	K22	K313-20	K24	K405-21	K29	K444-16	K34	K505-07	K38
K297-01	K22	K314-13	K24	K410-01	K30	K445-17	K34	K507-15	K38
K297-02	K22	K314-16	K24	K410-02	K30	K446-18	K34	K508-15	K39
K297-03	K22	K314-20	K24	K410-03	K30	K453-05	K35	K509-01	K39
K297-04	K22	K316-15	K24	K410-04	K30	K453-06	K35	K509-02	K39
K297-05	K22	K317-16	K24	K410-11	K30	K453-08	K35	K510-06	K39
K297-06	K22	K325-21	K24	K410-12	K30	K457-07	K35	K510-08	K39
K297-10	K22	K340-22	K25	K410-13	K30	K457-15	K35	K512-01	K39
K297-20	K22	K341-24	K25	K410-14	K30	K457-29	K35	K512-06	K39
K297-30	K22	K343-25	K25	K410-15	K30	K458-01	K35	K512-07	K39
K297-51	K22	K345-27	K25	K412-09	K31	K458-02	K35	K512-11	K39
K297-52	K22	K346-30	K25	K412-14	K31	K460-20	K35	K512-12	K39
K297-53	K22	K349-05	K26	K415-01	K31	K463-06	K35	K512-15	K39
K297-54	K22	K350-13	K26	K415-02	K31	K469-23	K36	K512-19	K39
K297-55	K22	K351-05	K26	K415-03	K31	K472-03	K36	K512-22	K39
K297-56	K22	K351-06	K26	K415-04	K31	K472-06	K36	K512-23	K40
K297-60	K22	K351-08	K26	K415-05	K31	K472-06N	K36	K512-30	K40
K297-70	K22	K352-15	K26	K415-06	K31	K472-10	K36	K512-35	K40
K297-80	K22	K353-13	K26	K417-22	K31	K472-13	K36	K512-46	K40
K300-01	K23	K353-18	K26	K419-29	K31	K472-16	K36	K514-27	K40
K300-02	K23	K355-05	K26	K425-01	K31	K472-19	K36	K515-40	K40
K300-03	K23	K355-07	K26	K425-02	K31	K472-25	K36	K518-42	K40
K300-04	K23	K355-09	K26	K425-11	K31	K475-17	K36	K518-65	K40
K300-05	K23	K359-01	K26	K425-12	K31	K477-19	K36	K519-25	K41
K300-06	K23	K359-02	K26	K425-21	K31	K479-19	K36	K520-01	K41
K300-10	K23	K362-03	K27	K425-22	K31	K481-21	K36	K520-02	K41
K300-20	K23	K366-01	K27	K430-04	K32	K484-09	K37	K521-27	K41
K300-30	K23	K366-02	K27	K430-06	K32	K484-11	K37	K522-01	K41
K301-01	K23	K366-03	K27	K430-08	K32	K484-13	K37	K522-02	K41
K301-02	K23	K366-04	K27	K430-10	K32	K484-14	K37	K523-01	K41
K301-03	K23	K368-06	K27	K430-13	K32	K484-15	K37	K523-02	K41
K301-04	K23	K368-08	K27	K430-19	K32	K485-01	K37	K523-03	K41
K301-05	K23	K374-01	K27	K430-25	K32	K485-02	K37	K523-04	K41
K301-06	K23	K374-02	K27	K430-32	K32	K485-03	K37	K525-22	K41
K301-10	K23	K375-01	K27	K430-60	K32	K485-04	K37	K526-01	K42

Index Art.-Nr. Index Item No.

Art.-Nr. Item No.	Seite Page	Art.-Nr. Item No.	Seite Page	Art.-Nr. Item No.	Seite Page	Art.-Nr. Item No.	Seite Page	Art.-Nr. Item No.	Seite Page
K527-01	K42	K589-30	K47	K638-02	K52	K711-186	K57	K752-19	K62
K530-27	K42	K590-14	K47	K638-03	K52	K711-187	K57	K752-22	K62
K535-01	K42	K590-17	K47	K640-01	K53	K711-235	K57	K753-14	K62
K535-02	K42	K590-21	K47	K640-02	K53	K711-236	K57	K753-17	K62
K536-17	K42	K590-33	K47	K642-01	K53	K711-237	K57	K753-19	K62
K548-10	K43	K590-45	K47	K642-02	K53	K715-20	K57	K753-22	K62
K550-12	K43	K590-83	K47	K644-16	K53	K718-24	K58	K754-13	K62
K551-14	K43	K591-14	K47	K644-19	K53	K720-01	K58	K754-15	K62
K553-13	K43	K591-17	K47	K645-16	K53	K720-02	K58	K754-17	K62
K553-17	K43	K591-21	K47	K645-19	K53	K720-03	K58	K760-15	K63
K555-13	K43	K591-33	K47	K646-15	K53	K720-12	K58	K761-15	K63
K556-13	K43	K591-45	K47	K650-17	K54	K720-13	K58	K762-15	K63
K556-17	K43	K591-83	K47	K651-17	K54	K720-22	K58	K763-15	K63
K558-09	K44	K593-01	K48	K654-17	K54	K720-23	K58	K765-17	K63
K558-13	K44	K593-02	K48	K654-67	K54	K730-22	K58	K768-11	K63
K558-17	K44	K595-34	K48	K655-17	K54	K730-26	K58	K769-11	K63
K559-17	K44	K596-01	K48	K655-67	K54	K731-22	K58	K770-18	K63
K560-17	K44	K596-02	K48	K658-17	K54	K731-26	K58	K770-68	K63
K561-01	K44	K596-12	K48	K660-18	K54	K732-22	K58	K771-18	K63
K561-02	K44	K596-22	K48	K661-20	K54	K732-26	K58	K774-23	K64
K562-15	K44	K600-17	K49	K662-20	K55	K733-22	K58	K774-27	K64
K563-16	K44	K600-25	K49	K664-18	K55	K733-26	K58	K775-23	K64
K564-20	K44	K600-26	K49	K666-19	K55	K734-23	K59	K775-27	K64
K565-20	K45	K600-27	K49	K670-20	K55	K738-02	K59	K776-26	K64
K569-20	K45	K602-23	K50	K674-07	K55	K738-03	K59	K777-27	K64
K571-20	K45	K603-22	K50	K674-08	K55	K738-04	K59	K779-25	K64
K573-01	K45	K603-27	K50	K674-70	K55	K739-03	K59	K800-00	K65
K573-02	K45	K603-32	K50	K675-07	K55	K739-04	K59	K800-11	K65
K574-01	K45	K604-23	K50	K675-08	K55	K739-05	K59	K801-00	K65
K574-02	K45	K604-26	K50	K680-20	K55	K739-06	K59	K802-00	K65
K574-03	K45	K606-26	K50	K700-02	K56	K739-07	K59	K804-00	K66
K576-23	K46	K610-12	K50	K701-02	K56	K739-08	K59	K804-01	K66
K578-20	K46	K610-18	K50	K701-03	K56	K739-13	K59	K804-02	K66
K579-20	K46	K610-20	K50	K701-13	K56	K739-14	K59	K804-03	K66
K580-21	K46	K610-22	K50	K701-22	K56	K739-15	K59	K804-04	K66
K581-21	K46	K611-12	K50	K702-02	K56	K739-16	K59	K804-05	K66
K582-01	K46	K611-18	K50	K702-03	K56	K739-17	K59	K804-06	K66
K582-02	K46	K611-20	K50	K702-04	K56	K739-18	K59	K804-07	K66
K584-16	K46	K612-18	K50	K702-05	K56	K741-04	K60	K804-08	K66
K584-24	K46	K612-20	K50	K703-02	K56	K742-05	K60	K804-09	K66
K585-15	K47	K615-00	K51	K703-03	K56	K742-06	K60	K804-10	K66
K585-19	K47	K616-00	K51	K703-04	K56	K743-24	K60	K805-00	K66
K585-24	K47	K630-12	K52	K703-05	K56	K744-01	K60	K805-01	K66
K585-26	K47	K631-01	K52	K704-18	K57	K744-02	K60	K805-02	K66
K585-28	K47	K631-02	K52	K705-18	K57	K747-23	K61	K805-03	K66
K586-18	K47	K632-12	K52	K706-17	K57	K749-04	K61	K805-04	K66
K586-23	K47	K632-14	K52	K707-18	K57	K749-05	K61	K805-05	K66
K586-25	K47	K635-01	K52	K710-184	K57	K749-08	K61	K805-06	K66
K586-28	K47	K635-02	K52	K710-185	K57	K749-12	K61	K805-07	K66
K587-18	K47	K635-03	K52	K710-186	K57	K750-15	K62	K805-08	K66
K587-28	K47	K636-14	K52	K710-187	K57	K751-19	K62	K805-09	K66
K589-21	K47	K636-17	K52	K711-184	K57	K752-14	K62	K805-10	K66
K589-27	K47	K638-01	K52	K711-185	K57	K752-17	K62	K806-00	K67

Index Art.-Nr. Index Item No.

Art.-Nr. Item No.	Seite Page	Art.-Nr. Item No.	Seite Page	Art.-Nr. Item No.	Seite Page	Art.-Nr. Item No.	Seite Page	Art.-Nr. Item No.	Seite Page
K808-10	K67	K879-17T	K72	N700-40	A05	R124-21	R06	R331-23	R12
K808-11	K67	K880-05	K72	R102-00N	R02	R124-22	R06	R334-01	R12
K808-20	K67	K880-07	K72	R106-01	R02	R127-00	R06	R334-01N	R12
K808-21	K67	K880-11	K72	R106-02	R02	R130-00	R07	R334-02	R12
K808-30	K67	K881-15T	K72	R107-01	R02	R132-02	R07	R334-02N	R12
K814-14	K68	K882-18	K73	R107-02	R02	R132-03	R07	R334-03	R12
K815-14	K68	K883-14	K73	R109-00	R02	R132-11	R07	R334-03N	R12
K816-21	K68	K884-21	K73	R110-01	R03	R133-00	R07	R336-19	R13
K820-01	K68	K886-00T	K73	R110-02	R03	R134-01	R07	R336-21	R13
K820-02	K68	K886-02T	K73	R110-03	R03	R134-02	R07	R340-01	R13
K820-03	K68	K886-03T	K73	R110-04	R03	R134-03	R07	R340-02	R13
K820-11	K68	K886-06T	K73	R110-05N	R03	R134-11	R07	R341-23	R14
K825-01	K68	K889-17	K74	R110-11	R03	R136-01	R08	R346-21	R14
K825-02	K68	K889-51	K74	R110-21	R03	R136-02	R08	R347-27	R14
K825-03	K68	K890-18	K74	R110-22	R03	R136-03	R08	R350-01	R15
K827-01	K68	K890-20	K74	R110-23	R03	R138-01	R08	R350-01N	R15
K827-02	K68	K890-24	K74	R110-24	R03	R138-02	R08	R350-02	R15
K829-01	K69	K890-72	K74	R110-25	R03	R138-03	R08	R350-02N	R15
K829-02	K69	K890-75	K74	R112-01	R03	R138-04	R08	R352-01	R16
K830-01	K69	K890-80	K74	R112-02	R03	R138-05	R08	R352-02	R16
K830-02	K69	K892-12	K75	R112-03	R03	R140-01	R08	R352-03	R16
K830-03	K69	K892-23	K75	R112-04	R03	R140-11	R08	R353-24	R16
K830-04	K69	K893-00	K75	R114-01	R04	R140-12	R08	R360-25	R17
K830-05	K69	K895-18	K75	R114-02	R04	R140-13	R08	R360-27	R17
K832-01	K69	K900-12T	K76	R114-03	R04	R150-16	R09	R360-28N	R17
K832-02	K69	K900-14T	K76	R114-04	R04	R150-18	R09	R360-31	R17
K834-01	K69	K904-00	K76	R114-05	R04	R151-18	R09	R360-32N	R17
K834-02	K69	K905-15T	K76	R116-00	R04	R153-19	R09	R360-33	R17
K834-03	K69	K906-16	K76	R116-10	R04	R155-18	R09	R360-34N	R17
K834-51	K69	K907-18T	K76	R116-21	R04	R160-23	R09	R362-24	R18
K834-61	K69	K908-18	K76	R116-22	R04	R160-26	R09	R366-28	R18
K850-14	K70	K909-22	K77	R116-23	R04	R162-27	R09	R368-30	R18
K851-01	K70	K910-18T	K77	R116-24	R04	R164-34	R09	R370-01	R19
K851-02	K70	K914-18T	K77	R116-25	R04	R166-01	R10	R370-02	R19
K851-03	K70	K914-22T	K77	R118-00	R05	R166-02	R10	R370-03	R19
K852-13T	K70	K915-01T	K77	R118-10	R05	R167-34	R10	R370-04	R19
K854-15T	K70	K915-22T	K77	R118-21	R05	R168-01	R10	R375-01	R20
K855-15	K70	K921-22T	K78	R118-22	R05	R168-02	R10	R375-02	R20
K857-16	K70	K922-18	K78	R118-23	R05	R170-01	R10	R375-03	R20
K858-01	K71	K922-18L	K78	R119-00	R05	R170-02	R10	R380-25	R20
K858-02	K71	K922-23	K78	R119-10	R05	R175-24	R11	R382-22	R20
K861-19	K71	K922-28	K78	R119-21	R05	R180-01	R11	R382-22N	R20
K865-13	K71	K922-68	K78	R119-22	R05	R180-02	R11	R383-24	R21
K865-18	K71	K922-73	K78	R119-23	R05	R180-11	R11	R383-24N	R21
K866-20	K71	K922-78	K78	R119-24	R05	R220-03	R11	R400-21	R21
K867-18	K71	K924-57	K78	R119-25	R05	R220-06	R11	R400-22	R21
K875-15T	K72	K925-47	K78	R120-05	R06	R220-20	R11	R400-22N	R21
K875-20T	K72	K925-54	K78	R120-06	R06	R220-30	R11	R400-26	R21
K875-63T	K72	K926-38T	K78	R120-07	R06	R220-40	R11	R401-21	R22
K875-65T	K72	K927-26	K78	R120-23	R06	R330-21	R12	R401-22	R22
K875-68T	K72	K927-38	K78	R120-24	R06	R330-21N	R12	R401-22N	R22
K876-18T	K72	N700-15	A05	R124-00	R06	R331-21	R12	R401-26	R22
K876-20T	K72	N700-20	A05	R124-10	R06	R331-21N	R12	R403-21	R22

Index Art.-Nr. Index Item No.

Art.-Nr. Item No.	Seite Page	Art.-Nr. Item No.	Seite Page	Art.-Nr. Item No.	Seite Page	Art.-Nr. Item No.	Seite Page	Art.-Nr. Item No.	Seite Page
R403-22	R22	R482-19N	R29	R550-30	R34	R630-03	R41	S109-19	S02
R410-20	R23	R482-20	R29	R550-32	R34	R630-04	R41	S110-16	S03
R410-23	R23	R482-20N	R29	R550-34	R34	R630-05	R41	S110-20	S03
R410-26	R23	R491-20	R30	R550-36	R34	R630-06	R41	S112-18	S03
R410-31	R23	R491-20N	R30	R561-16	R35	R630-07	R41	S114-16	S03
R411-20	R23	R491-24	R30	R564-01	R35	R630-08	R41	S118-24	S03
R411-23	R23	R491-24N	R30	R564-01N	R35	R630-09	R41	S120-16	S03
R411-26	R23	R491-25	R30	R564-02	R35	R631-01	R41	S120-16T	S03
R411-31	R23	R491-25N	R30	R564-02N	R35	R631-02	R41	S120-16U	S03
R425-01	R24	R491-30	R30	R564-03	R35	R631-03	R41	S120-18	S03
R425-02	R24	R491-30N	R30	R564-03N	R35	R631-04	R41	S120-18N	S03
R425-03	R24	R493-18	R30	R564-04	R35	R631-05	R41	S120-20	S03
R428-01	R24	R493-21	R30	R564-04N	R35	R631-06	R41	S120-20T	S03
R428-02	R24	R493-23	R30	R570-21	R36	R631-07	R41	S120-20U	S03
R428-03	R24	R493-27	R30	R570-25	R36	R631-08	R41	S120-24	S03
R428-04	R24	R500-01	R31	R579-17	R36	R631-09	R41	S120-30	S03
R432-01	R25	R500-01N	R31	R580-01	R36	R632-01	R41	S120-36	S03
R432-01N	R25	R500-02	R31	R580-02	R36	R632-02	R41	S120-40	S03
R432-02	R25	R500-02N	R31	R580-03	R36	R632-03	R41	S121-16	S03
R432-02N	R25	R500-03	R31	R610-18	R37	R632-04	R41	S122-20	S04
R432-03	R25	R500-03N	R31	R610-20	R37	R632-05	R41	S122-20N	S04
R432-03N	R25	R500-04	R31	R610-20N	R37	R632-06	R41	S122-20T	S04
R433-18	R25	R500-04N	R31	R610-27	R37	R632-07	R41	S122-23	S04
R433-18N	R25	R500-05	R31	R610-27N	R37	R632-08	R41	S122-50	S04
R440-23	R25	R500-05N	R31	R612-01	R37	R632-09	R41	S122-53	S04
R442-17	R25	R510-00	R32	R612-02	R37	R640-03	R42	S126-18	S04
R444-16	R26	R510-15	R32	R612-03	R37	R640-04	R42	S126-20	S04
R444-16N	R26	R510-30	R32	R612-04	R37	R640-06	R42	S126-23	S04
R446-16	R26	R510-45	R32	R612-05	R37	R640-08	R42	S127-25	S04
R446-16N	R26	R510-90	R32	R615-16	R38	R640-09	R42	S127-26	S04
R448-01	R26	R511-00	R32	R616-16	R38	R640-10	R42	S130-16	S05
R448-02	R26	R511-15	R32	R616-16N	R38	R640-11	R42	S130-16U	S05
R451-20	R26	R511-30	R32	R616-17	R38	S100-15	S02	S130-18	S05
R455-01	R27	R511-45	R32	R616-17N	R38	S101-15	S02	S130-18U	S05
R455-02	R27	R511-90	R32	R618-01	R38	S101-15N	S02	S130-21	S05
R455-03	R27	R515-01	R32	R618-02	R38	S101-16U	S02	S130-21U	S05
R460-14	R27	R515-02	R32	R618-03	R38	S101-19	S02	S130-23	S05
R460-18	R27	R515-03	R32	R618-04	R39	S101-19U	S02	S130-23U	S05
R460-19	R27	R515-04	R32	R618-05	R39	S101-22U	S02	S131-16	S05
R462-15	R27	R515-05	R32	R618-06	R39	S101-23	S02	S131-16U	S05
R462-15N	R27	R520-01	R33	R620-01	R39	S101-25	S02	S131-18	S05
R470-24	R28	R520-03	R33	R620-02	R39	S101-25U	S02	S131-18U	S05
R471-24	R28	R520-05	R33	R620-03	R39	S101-29	S02	S131-21	S05
R472-27	R28	R520-08	R33	R620-04	R40	S101-30U	S02	S131-21U	S05
R472-27N	R28	R520-09	R33	R620-05	R40	S101-36	S02	S131-23	S05
R473-27	R28	R520-10	R33	R624-13	R40	S101-40	S02	S131-23U	S05
R475-16	R29	R520-13	R33	R624-13N	R40	S101-46	S02	S134-21	S05
R475-17	R29	R520-15	R33	R624-15	R40	S102-12	S02	S134-23	S05
R480-20	R29	R530-15	R34	R624-15N	R40	S102-14	S02	S134-25	S05
R480-20N	R29	R530-18	R34	R624-16	R40	S106-15	S02	S134-25N	S05
R480-22	R29	R550-24	R34	R624-16N	R40	S107-15	S02	S134-25U	S05
R480-22N	R29	R550-26	R34	R630-01	R41	S108-20	S02	S135-21	S05
R482-19	R29	R550-28	R34	R630-02	R41	S109-15	S02	S135-23	S05

Index Art.-Nr. Index Item No.

Art.-Nr. Item No.	Seite Page	Art.-Nr. Item No.	Seite Page	Art.-Nr. Item No.	Seite Page	Art.-Nr. Item No.	Seite Page	Art.-Nr. Item No.	Seite Page
S135-25	.S05	S203-00	.S12	S220-435	.S16	S427-01	.S21	S520-00	.S25
S135-25N	.S05	S205-00	.S12	S220-442	.S16	S427-02	.S21	S530-06	.S26
S135-25U	.S05	S205-10	.S12	S222-01	.S16	S428-01	.S21	S530-08	.S26
S136-15	.S06	S205-21	.S12	S222-02	.S16	S428-02	.S21	S530-10	.S26
S136-20	.S06	S205-22	.S12	S222-03	.S16	S430-20	.S22	S530-12	.S26
S139-24	.S06	S205-23	.S12	S222-04	.S16	S430-70	.S22	S530-14	.S26
S139-24U	.S06	S207-01	.S12	S222-11	.S16	S431-20	.S22	S530-16	.S26
S140-13	.S06	S207-02	.S12	S222-12	.S16	S431-70	.S22	S530-18	.S26
S140-22	.S07	S210-00	.S12	S222-13	.S16	S433-01	.S22	S530-20	.S26
S140-22U	.S07	S210-00F	.S12	S222-14	.S16	S433-02	.S22	S530-22	.S26
S140-25	.S07	S211-01	.S13	S222-51	.S16	S438-24	.S22	S530-24	.S26
S140-25U	.S07	S211-02	.S13	S222-51	.S16	S440-01	.S22	S530-26	.S26
S140-28	.S07	S211-03	.S13	S222-52	.S16	S440-02	.S22	S530-28	.S26
S140-28U	.S07	S211-04	.S13	S222-53	.S16	S440-03	.S22	S530-30	.S26
S141-13	.S06	S212-01	.S13	S222-54	.S16	S440-04	.S22	S532-06	.S26
S141-22	.S07	S212-02	.S13	S222-61	.S16	S440-05	.S22	S532-08	.S26
S141-22U	.S07	S212-03	.S13	S222-62	.S16	S440-06	.S22	S532-10	.S26
S141-25	.S07	S212-04	.S13	S222-63	.S16	S440-07	.S22	S532-12	.S26
S141-25U	.S07	S213-01	.S13	S222-64	.S16	S440-08	.S22	S532-14	.S26
S141-28	.S07	S213-02	.S13	S230-30	.S17	S440-09	.S22	S532-16	.S26
S141-28U	.S07	S213-03	.S13	S234-40	.S17	S440-10	.S22	S532-18	.S26
S146-26	.S07	S214-01	.S13	S236-15	.S17	S440-11	.S22	S532-20	.S26
S146-28	.S07	S214-01	.S13	S237-14	.S17	S440-12	.S22	S532-22	.S26
S147-25	.S08	S214-02	.S13	S238-22	.S17	S440-13	.S22	S532-24	.S26
S147-25U	.S08	S214-02	.S13	S240-19	.S17	S440-30	.S22	S532-26	.S26
S149-30	.S08	S214-03	.S13	S249-25	.S18	S440-90	.S22	S532-28	.S26
S150-31	.S08	S214-03	.S13	S250-21	.S18	S444-02	.S23	S532-30	.S26
S160-30	.S09	S214-04	.S13	S251-21	.S18	S444-03	.S23	S532-32	.S26
S160-30U	.S09	S214-04	.S13	S255-00	.S18	S444-04	.S23	S532-34	.S26
S161-30	.S09	S214-04	.S13	S255-09	.S18	S444-05	.S23	S532-36	.S26
S161-30U	.S09	S214-90	.S13	S255-19	.S18	S444-06	.S23	S532-38	.S26
S170-05	.S09	S215-01	.S14	S255-51	.S18	S444-08	.S23	S532-40	.S26
S170-07	.S09	S215-02	.S14	S257-00	.S19	S444-11	.S23	S534-06	.S26
S170-10	.S09	S216-01	.S14	S257-11	.S19	S444-15	.S23	S534-08	.S26
S170-11	.S09	S216-02	.S14	S257-16	.S19	S446-01	.S23	S534-10	.S26
S170-26	.S09	S217-25	.S14	S257-51	.S19	S446-02	.S23	S534-12	.S26
S180-00	.S10	S217-29	.S14	S258-00	.S19	S446-03	.S23	S534-14	.S26
S182-30	.S10	S217-35	.S14	S259-00	.S19	S446-04	.S23	S534-16	.S26
S183-30	.S10	S217-38	.S14	S259-51	.S19	S449-01	.S23	S534-18	.S26
S185-15	.S10	S217-90	.S14	S400-20	.S20	S449-02	.S23	S534-20	.S26
S185-21	.S10	S218-01	.S15	S400-22	.S20	S449-03	.S23	S534-22	.S26
S185-29	.S10	S218-11	.S15	S400-22U	.S20	S455-28	.S23	S534-24	.S26
S185-35	.S10	S218-21	.S15	S400-24	.S20	S500-21	.S24	S534-26	.S26
S193-20	.S11	S220-128	.S16	S400-24U	.S20	S501-22	.S24	S534-28	.S26
S195-00	.S11	S220-135	.S16	S402-23	.S20	S502-21	.S24	S534-30	.S26
S195-10	.S11	S220-142	.S16	S403-23	.S20	S503-22	.S24	S534-32	.S26
S196-22	.S11	S220-228	.S16	S405-23	.S20	S508-23	.S24	S534-34	.S26
S198-06	.S11	S220-235	.S16	S407-23	.S20	S509-23	.S24	S534-36	.S26
S198-08	.S11	S220-242	.S16	S415-01	.S21	S510-00	.S25	S536-06	.S26
S198-12	.S11	S220-328	.S16	S415-02	.S21	S512-00	.S25	S536-08	.S26
S198-15	.S11	S220-335	.S16	S415-03	.S21	S514-00	.S25	S536-10	.S26
S199-19	.S11	S220-342	.S16	S415-04	.S21	S516-00	.S25	S536-12	.S26
S201-17	.S11	S220-428	.S16	S424-21	.S21	S518-00	.S25	S536-14	.S26

Index Art.-Nr. Index Item No.

Art.-Nr. Item No.	Seite Page	Art.-Nr. Item No.	Seite Page	Art.-Nr. Item No.	Seite Page	Art.-Nr. Item No.	Seite Page	Art.-Nr. Item No.	Seite Page
S536-16	S26	S544-25	S27	T101-01	T02	T130-00	T06	T144-12	T08
S536-18	S26	S544-26	S27	T101-02	T02	T130-01	T06	T144-13	T08
S536-20	S26	S544-27	S27	T101-03	T02	T130-02	T06	T146-01	T08
S536-22	S26	S544-28	S27	T102-01	T02	T130-03	T06	T146-02	T08
S536-24	S26	S544-29	S27	T102-02	T02	T130-31	T06	T146-03	T08
S536-26	S26	S544-30	S27	T102-03	T02	T130-32	T06	T146-11	T08
S536-28	S26	S550-12	S27	T104-01	T02	T130-33	T06	T146-12	T08
S536-30	S26	S550-14	S27	T104-02	T02	T130-34	T06	T146-13	T08
S536-32	S26	S550-16	S27	T104-03	T02	T130-35	T06	T147-01	T09
S536-34	S26	S550-18	S27	T108-01	T03	T130-36	T06	T147-02	T09
S536-36	S26	S550-20	S27	T108-02	T03	T131-01	T06	T147-11	T09
S538-12	S26	S550-22	S27	T108-03	T03	T131-02	T06	T147-12	T09
S538-14	S26	S550-24	S27	T108-05	T03	T131-03	T06	T147-13	T09
S538-16	S26	S550-26	S27	T109-01	T03	T131-11	T06	T152-01	T09
S538-18	S26	S550-28	S27	T109-02	T03	T131-12	T06	T152-02	T09
S538-20	S26	S550-30	S27	T109-03	T03	T131-13	T06	T152-11	T09
S538-22	S26	S550-32	S27	T109-11	T03	T131-21	T06	T152-12	T09
S538-24	S26	S550-34	S27	T109-12	T03	T131-22	T06	T153-01	T10
S538-26	S26	S550-36	S27	T109-13	T03	T131-23	T06	T153-02	T10
S538-28	S26	S550-38	S27	T110-09	T03	T132-01	T06	T153-03	T10
S540-16	S27	S561-08	S28	T110-21	T03	T132-02	T06	T153-04	T10
S540-18	S27	S561-10	S28	T110-23	T03	T132-03	T06	T153-05	T10
S540-20	S27	S561-12	S28	T115-00	T04	T134-01	T07	T153-11	T10
S540-22	S27	S561-14	S28	T115-01	T04	T134-02	T07	T153-12	T10
S540-24	S27	S562-06	S28	T115-02	T04	T134-03	T07	T153-13	T10
S540-26	S27	S562-08	S28	T115-03	T04	T134-11	T07	T153-14	T10
S540-28	S27	S562-10	S28	T116-01	T04	T134-12	T07	T153-15	T10
S540-30	S27	S562-12	S28	T116-02	T04	T134-13	T07	T155-01	T10
S540-32	S27	S562-14	S28	T116-03	T04	T135-01	T07	T155-02	T10
S540-34	S27	S562-16	S28	T116-11	T04	T135-02	T07	T155-11	T10
S540-36	S27	S562-18	S28	T116-12	T04	T135-03	T07	T155-12	T10
S542-06	S27	S562-20	S28	T116-13	T04	T136-01	T07	T160-01	T11
S542-08	S27	S570-39	S28	T118-00	T04	T136-02	T07	T160-02	T11
S542-10	S27	S571-35	S28	T118-01	T04	T136-03	T07	T160-11	T11
S542-12	S27	S574-01	S29	T118-02	T04	T140-00	T07	T160-12	T11
S542-14	S27	S574-02	S29	T118-03	T04	T140-01	T07	T169-01	T11
S542-16	S27	S575-08	S29	T121-02	T04	T140-02	T07	T169-02	T11
S542-18	S27	S575-11	S29	T123-01	T04	T140-03	T07	T169-03	T11
S542-20	S27	S575-13	S29	T123-02	T04	T140-10	T07	T170-01	T11
S542-22	S27	S575-16	S29	T123-03	T04	T140-11	T07	T170-02	T11
S544-12	S27	S575-21	S29	T125-01	T05	T140-12	T07	T170-03	T11
S544-13	S27	S575-26	S29	T125-02	T05	T140-13	T07	T170-11	T11
S544-14	S27	S575-32	S29	T125-03	T05	T140-22	T07	T170-12	T11
S544-15	S27	S578-00	S29	T126-01	T05	T140-23	T07	T170-13	T11
S544-16	S27	S580-00	S30	T126-02	T05	T142-01	T08	T170-14	T11
S544-17	S27	S582-00	S30	T128-01	T05	T142-02	T08	T170-15	T11
S544-18	S27	S585-00	S30	T128-02	T05	T142-11	T08	T170-21	T11
S544-19	S27	S585-11	S30	T128-11	T05	T142-12	T08	T170-22	T11
S544-20	S27	T100-00	T02	T128-12	T05	T144-01	T08	T170-23	T11
S544-21	S27	T100-01	T02	T129-01	T05	T144-02	T08	T170-24	T11
S544-22	S27	T100-02	T02	T129-02	T05	T144-03	T08	T170-25	T11
S544-23	S27	T100-03	T02	T129-11	T05	T144-03	T09	T171-03	T11
S544-24	S27	T101-00	T02	T129-12	T05	T144-11	T08	T171-11	T11

Index Art.-Nr. Index Item No.

Art.-Nr. Item No.	Seite Page	Art.-Nr. Item No.	Seite Page	Art.-Nr. Item No.	Seite Page	Art.-Nr. Item No.	Seite Page	Art.-Nr. Item No.	Seite Page
T171-12	T11	T185-63	T13	T200-29	T15	T205-28	T17	T316-25	T22
T171-13	T11	T185-64	T13	T200-30	T15	T205-30	T17	T317-24	T22
T171-21	T11	T185-65	T13	T200-51	T15	T205-51	T17	T319-26	T22
T171-22	T11	T185-71	T13	T200-52	T15	T205-61	T17	T320-15	T22
T171-23	T11	T185-72	T13	T200-61	T15	T206-10	T17	T322-20	T22
T174-01	T12	T185-73	T13	T200-71	T15	T206-12	T17	T324-21	T22
T174-02	T12	T187-01	T13	T201-01	T15	T206-14	T17	T325-21	T22
T174-03	T12	T187-02	T13	T201-02	T15	T206-16	T17	T326-20	T23
T181-01	T12	T190-00	T13	T201-03	T15	T206-18	T17	T326-24	T23
T181-02	T12	T190-01	T13	T201-04	T15	T206-20	T17	T327-20	T23
T182-01	T12	T190-02	T13	T201-05	T15	T206-51	T17	T327-24	T23
T182-02	T12	T190-03	T13	T201-06	T15	T206-61	T17	T329-23	T23
T182-03	T12	T190-04	T13	T201-07	T15	T208-15	T17	T330-06	T23
T183-01	T12	T190-05	T13	T201-08	T15	T208-19	T17	T330-08	T23
T183-02	T12	T190-10	T13	T201-09	T15	T208-23	T17	T330-10	T23
T183-03	T12	T190-11	T13	T201-10	T15	T208-27	T17	T332-06	T23
T184-00	T12	T190-12	T13	T201-11	T15	T208-31	T17	T332-08	T23
T184-01	T13	T192-00	T14	T201-12	T15	T208-35	T17	T332-10	T23
T184-02	T13	T192-01	T14	T201-13	T15	T208-39	T17	T334-26	T24
T184-03	T13	T192-02	T14	T201-14	T15	T208-43	T17	T336-26	T24
T184-04	T13	T192-03	T14	T201-15	T15	T208-51	T17	T344-18	T24
T185-01	T13	T192-10	T14	T201-16	T15	T208-61	T17	T344-20	T24
T185-02	T13	T195-00	T14	T201-17	T15	T210-33	T18	T348-25	T24
T185-03	T13	T195-10	T14	T201-18	T15	T211-03	T18	T350-32	T24
T185-04	T13	T197-10	T14	T201-19	T15	T211-04	T18	T354-27	T24
T185-05	T13	T200-01	T15	T202-02	T16	T211-06	T18	T356-27	T25
T185-11	T13	T200-02	T15	T202-04	T16	T212-03	T18	T358-23	T25
T185-12	T13	T200-03	T15	T202-06	T16	T212-04	T18	T360-25	T25
T185-13	T13	T200-04	T15	T202-08	T16	T212-06	T18	T382-01	T26
T185-14	T13	T200-05	T15	T202-10	T16	T213-03	T18	T382-02	T26
T185-15	T13	T200-06	T15	T202-12	T16	T213-04	T18	T384-01	T26
T185-21	T13	T200-07	T15	T202-14	T16	T213-06	T18	T384-02	T26
T185-22	T13	T200-08	T15	T202-16	T16	T214-01	T18	T384-03	T26
T185-23	T13	T200-09	T15	T202-18	T16	T214-02	T18	T384-04	T26
T185-24	T13	T200-10	T15	T202-20	T16	T218-01	T19	T384-05	T26
T185-25	T13	T200-11	T15	T202-22	T16	T218-02	T19	T384-13	T26
T185-31	T13	T200-12	T15	T202-24	T16	T219-01	T19	T384-14	T26
T185-32	T13	T200-13	T15	T202-26	T16	T219-02	T19	T384-15	T26
T185-33	T13	T200-14	T15	T202-51	T16	T220-01	T19	T386-01	T26
T185-34	T13	T200-15	T15	T202-52	T16	T221-01	T19	T386-02	T26
T185-35	T13	T200-16	T15	T202-61	T16	T221-02	T19	T386-03	T26
T185-41	T13	T200-17	T15	T202-71	T16	T223-29	T19	T386-04	T26
T185-42	T13	T200-18	T15	T202-72	T16	T226-28	T20	T386-05	T26
T185-43	T13	T200-19	T15	T205-08	T17	T227-26	T20	T390-00	T26
T185-44	T13	T200-20	T15	T205-10	T17	T230-23	T20	T391-00	T26
T185-45	T13	T200-21	T15	T205-12	T17	T250-00	T20	T400-01	T27
T185-51	T13	T200-22	T15	T205-14	T17	T300-17	T21	T400-02	T27
T185-52	T13	T200-23	T15	T205-16	T17	T302-18	T21	T400-03	T27
T185-53	T13	T200-24	T15	T205-18	T17	T304-20	T21	T400-04	T27
T185-54	T13	T200-25	T15	T205-20	T17	T310-24	T21	T402-03	T27
T185-55	T13	T200-26	T15	T205-22	T17	T311-24	T21	T402-04	T27
T185-61	T13	T200-27	T15	T205-24	T17	T311-24N	T21	T406-01	T27
T185-62	T13	T200-28	T15	T205-26	T17	T312-25	T22	T406-02	T27

Index Art.-Nr. Index Item No.

Art.-Nr. Item No.	Seite Page	Art.-Nr. Item No.	Seite Page	Art.-Nr. Item No.	Seite Page	Art.-Nr. Item No.	Seite Page	Art.-Nr. Item No.	Seite Page
T406-03	T27	T470-10	T32	T531-04	T35	T541-05	T36	T544-20	T36
T406-11	T27	T470-11	T32	T531-05	T35	T541-06	T36	T544-21	T36
T406-12	T27	T500-01	T33	T531-06	T35	T541-07	T36	T544-23	T36
T408-01	T27	T500-02	T33	T532-01	T35	T541-08	T36	T544-25	T36
T408-11	T27	T500-03	T33	T532-02	T35	T541-09	T36	T544-30	T36
T409-01	T27	T500-04	T33	T532-03	T35	T541-11	T36	T544-35	T36
T409-02	T27	T500-05	T33	T532-04	T35	T541-12	T36	T544-40	T36
T410-00	T27	T500-06	T33	T532-05	T35	T541-14	T36	T545-05	T36
T412-04	T28	T501-01	T33	T532-06	T35	T541-15	T36	T545-06	T36
T412-05	T28	T501-02	T33	T533-01	T35	T541-16	T36	T545-07	T36
T413-00	T28	T501-03	T33	T533-02	T35	T541-19	T36	T545-08	T36
T418-20	T28	T501-04	T33	T533-03	T35	T541-20	T36	T545-09	T36
T420-23	T28	T501-05	T33	T533-04	T35	T541-21	T36	T545-11	T36
T422-24	T28	T501-06	T33	T533-05	T35	T541-23	T36	T545-12	T36
T424-21	T28	T503-01	T33	T533-06	T35	T542-05	T36	T545-14	T36
T424-29	T28	T503-02	T33	T535-01	T35	T542-06	T36	T545-15	T36
T426-25	T29	T503-03	T33	T535-02	T35	T542-07	T36	T545-16	T36
T427-28	T29	T503-04	T33	T535-03	T35	T542-08	T36	T545-19	T36
T428-27	T29	T503-05	T33	T535-04	T35	T542-09	T36	T545-20	T36
T430-01	T29	T504-24	T33	T535-05	T35	T542-11	T36	T545-21	T36
T430-02	T29	T505-24	T33	T535-06	T35	T542-12	T36	T545-23	T36
T432-23	T29	T510-04	T34	T536-01	T35	T542-14	T36	T545-25	T36
T434-28	T30	T510-06	T34	T536-02	T35	T542-15	T36	T545-30	T36
T435-03	T30	T510-08	T34	T536-03	T35	T542-16	T36	T545-35	T36
T435-05	T30	T510-10	T34	T536-04	T35	T542-19	T36	T545-40	T36
T436-20	T30	T510-12	T34	T536-05	T35	T542-20	T36	T546-05	T36
T436-25	T30	T510-14	T34	T536-06	T35	T542-21	T36	T546-06	T36
T436-30	T30	T510-51	T34	T537-01	T35	T542-23	T36	T546-07	T36
T436-35	T30	T514-05	T34	T537-02	T35	T543-05	T36	T546-08	T36
T436-40	T30	T514-07	T34	T537-03	T35	T543-06	T36	T546-09	T36
T437-20	T30	T514-09	T34	T537-04	T35	T543-07	T36	T546-11	T36
T438-01	T30	T514-15	T34	T537-05	T35	T543-08	T36	T546-12	T36
T438-02	T30	T514-17	T34	T537-06	T35	T543-09	T36	T546-14	T36
T439-28	T30	T514-19	T34	T538-01	T35	T543-11	T36	T546-15	T36
T440-04	T30	T520-10	T34	T538-02	T35	T543-12	T36	T546-16	T36
T440-06	T30	T520-12	T34	T538-03	T35	T543-14	T36	T546-19	T36
T442-24	T30	T520-14	T34	T538-04	T35	T543-15	T36	T546-20	T36
T450-21	T31	T526-00	T35	T538-05	T35	T543-16	T36	T546-21	T36
T452-23	T31	T526-01	T35	T538-06	T35	T543-19	T36	T546-23	T36
T453-21	T31	T526-02	T35	T540-05	T36	T543-20	T36	T546-25	T36
T455-21	T31	T526-03	T35	T540-06	T36	T543-21	T36	T546-30	T36
T460-21	T31	T526-04	T35	T540-07	T36	T543-23	T36	T546-35	T36
T464-23	T31	T526-05	T35	T540-08	T36	T544-05	T36	T546-40	T36
T465-23	T31	T526-06	T35	T540-09	T36	T544-06	T36	T547-05	T36
T470-01	T32	T530-01	T35	T540-11	T36	T544-07	T36	T547-06	T36
T470-02	T32	T530-02	T35	T540-12	T36	T544-08	T36	T547-07	T36
T470-03	T32	T530-03	T35	T540-14	T36	T544-09	T36	T547-08	T36
T470-04	T32	T530-04	T35	T540-15	T36	T544-11	T36	T547-09	T36
T470-05	T32	T530-05	T35	T540-16	T36	T544-12	T36	T547-11	T36
T470-06	T32	T530-06	T35	T540-19	T36	T544-14	T36	T547-12	T36
T470-07	T32	T531-01	T35	T540-20	T36	T544-15	T36	T547-14	T36
T470-08	T32	T531-02	T35	T540-21	T36	T544-16	T36	T547-15	T36
T470-09	T32	T531-03	T35	T540-23	T36	T544-19	T36	T547-16	T36

Index Art.-Nr. Index Item No.

Art.-Nr. Item No.	Seite Page	Art.-Nr. Item No.	Seite Page	Art.-Nr. Item No.	Seite Page	Art.-Nr. Item No.	Seite Page	Art.-Nr. Item No.	Seite Page
T547-19	T36	T624-01	T41	U106-183	U03	U107-195	U04	U111-193	U06
T547-20	T36	T624-02	T41	U106-183A	U03	U107-195A	U04	U111-193A	U06
T547-21	T36	T624-03	T41	U106-183N	U09	U107-197	U04	U111-195	U06
T547-23	T36	T625-01	T41	U106-185	U03	U107-197A	U04	U111-195A	U06
T547-25	T36	T625-02	T41	U106-185A	U03	U107-221	U04	U111-197	U06
T547-30	T36	T625-03	T41	U106-185N	U09	U107-221A	U04	U111-197A	U06
T547-35	T36	T628-27	T41	U106-187	U03	U107-223	U04	U111-221	U06
T547-40	T36	T629-27	T41	U106-187A	U03	U107-223A	U04	U111-221A	U06
T550-00	T37	T642-21	T41	U106-187N	U09	U107-225	U04	U111-223	U06
T550-01	T37	T644-26	T41	U106-191	U03	U107-225A	U04	U111-223A	U06
T550-02	T37	T650-28	T42	U106-191A	U03	U107-227	U04	U111-225	U06
T550-03	T37	T656-25	T42	U106-193	U03	U107-227A	U04	U111-225A	U06
T550-04	T37	T657-25	T42	U106-193A	U03	U107-241	U04	U111-227	U06
T550-05	T37	T660-30	T42	U106-195	U03	U107-241A	U04	U111-227A	U06
T550-06	T37	T662-09	T42	U106-195A	U03	U107-243	U04	U111-241	U06
T551-00	T37	T670-23	T43	U106-197	U03	U107-243A	U04	U111-241A	U06
T551-01	T37	T672-28	T43	U106-197A	U03	U107-245	U04	U111-243	U06
T551-02	T37	T674-30	T43	U106-221	U03	U107-245A	U04	U111-243A	U06
T551-03	T37	T675-36	T43	U106-221A	U03	U107-247	U04	U111-245	U06
T551-04	T37	T677-30	T43	U106-223	U03	U107-247A	U04	U111-245A	U06
T551-05	T37	T677-36	T43	U106-223A	U03	U109-183N	U09	U111-247	U06
T551-06	T37	T679-36	T43	U106-225	U03	U109-185N	U09	U111-247A	U06
T553-27	T37	T679-40	T43	U106-225A	U03	U109-186N	U09	U113-191	U06
T553-31	T37	T680-36	T44	U106-227	U03	U109-191	U05	U113-191A	U06
T555-00	T38	T682-41	T44	U106-227A	U03	U109-191A	U05	U113-193	U06
T555-01	T38	T684-40	T44	U106-241	U03	U109-193	U05	U113-193A	U06
T560-01	T38	T686-36	T44	U106-241A	U03	U109-193A	U05	U113-195	U06
T560-02	T38	T688-44	T44	U106-243	U03	U109-195	U05	U113-195A	U06
T560-03	T38	T690-40	T44	U106-243A	U03	U109-195A	U05	U113-197	U06
T560-11	T38	T691-43	T45	U106-245	U03	U109-197	U05	U113-197A	U06
T560-12	T38	T693-00	T45	U106-245A	U03	U109-197A	U05	U113-221	U06
T560-13	T38	T695-42	T45	U106-247	U03	U109-203N	U09	U113-221A	U06
T560-50	T38	T696-46	T45	U106-247A	U03	U109-205N	U09	U113-223	U06
T560-55	T38	U100-111	U02	U107-161	U04	U109-206N	U09	U113-223A	U06
T580-00	T39	U100-111A	U02	U107-161A	U04	U109-221	U05	U113-225	U06
T580-10	T39	U100-113	U02	U107-163	U04	U109-221A	U05	U113-225A	U06
T580-11	T39	U100-113A	U02	U107-163A	U04	U109-223	U05	U113-227	U06
T580-12	T39	U101-111	U02	U107-165	U04	U109-223A	U05	U113-227A	U06
T582-00	T39	U101-111A	U02	U107-165A	U04	U109-223N	U09	U113-241	U06
T582-10	T39	U101-113	U02	U107-167	U04	U109-225	U05	U113-241A	U06
T582-11	T39	U101-113A	U02	U107-167A	U04	U109-225A	U05	U113-243	U06
T582-12	T39	U104-120	U02	U107-181	U04	U109-225N	U09	U113-243A	U06
T582-21	T39	U104-120A	U02	U107-181A	U04	U109-226N	U09	U113-245	U06
T582-22	T39	U106-161	U03	U107-183	U04	U109-227	U05	U113-245A	U06
T582-31	T39	U106-161A	U03	U107-183A	U04	U109-227A	U05	U113-247	U06
T582-32	T39	U106-163	U03	U107-185	U04	U109-241	U05	U113-247A	U06
T600-01	T40	U106-163A	U03	U107-185A	U04	U109-241A	U05	U115-161	U07
T600-02	T40	U106-165	U03	U107-187	U04	U109-243	U05	U115-161A	U07
T602-00	T40	U106-165A	U03	U107-187A	U04	U109-243A	U05	U130-181	U07
T604-00	T40	U106-167	U03	U107-191	U04	U109-245	U05	U130-183	U07
T606-00	T40	U106-167A	U03	U107-191A	U04	U109-245A	U05	U130-185	U07
T610-14	T40	U106-181	U03	U107-193	U04	U111-191	U06	U130-201	U07
T620-42	T40	U106-181A	U03	U107-193A	U04	U111-191A	U06	U130-203	U07

Index Art.-Nr. Index Item No.

Art.-Nr. Item No.	Seite Page	Art.-Nr. Item No.	Seite Page	Art.-Nr. Item No.	Seite Page	Art.-Nr. Item No.	Seite Page	Art.-Nr. Item No.	Seite Page
U130-205	U07	U206-227	U03	U209-191	U05	U211-247A	U06	U306-18	U10
U135-181	U08	U206-227A	U03	U209-191A	U05	U213-191	U06	U306-21	U10
U135-183	U08	U206-241	U03	U209-193	U05	U213-191A	U06	U306-25	U10
U135-185	U08	U206-241A	U03	U209-193A	U05	U213-193	U06	U306-30	U10
U135-201	U08	U206-243	U03	U209-195	U05	U213-193A	U06	U308-14	U10
U135-203	U08	U206-243A	U03	U209-195A	U05	U213-195	U06	U308-18	U10
U135-205	U08	U206-245	U03	U209-197	U05	U213-195A	U06	U308-21	U10
U135-221	U08	U206-245A	U03	U209-197A	U05	U213-197	U06	U308-25	U10
U135-223	U08	U206-247	U03	U209-203N	U09	U213-197A	U06	U308-30	U10
U135-225	U08	U206-247A	U03	U209-205N	U09	U213-221	U06	U320-14	U10
U200-111	U02	U207-161	U04	U209-206N	U09	U213-221A	U06	U320-16	U10
U200-111A	U02	U207-161A	U04	U209-221	U05	U213-223	U06	U320-19	U10
U200-113	U02	U207-163	U04	U209-221A	U05	U213-223A	U06	U322-14	U10
U200-113A	U02	U207-163A	U04	U209-223	U05	U213-225	U06	U322-16	U10
U201-111	U02	U207-165	U04	U209-223A	U05	U213-225A	U06	U322-19	U10
U201-111A	U02	U207-165A	U04	U209-223N	U09	U213-227	U06	U350-018	U12
U201-113	U02	U207-167	U04	U209-225	U05	U213-227A	U06	U350-021	U12
U201-113A	U02	U207-167A	U04	U209-225A	U05	U213-241	U06	U350-023	U12
U201-120A	U02	U207-181	U04	U209-225N	U09	U213-241A	U06	U350-028	U12
U204-120	U02	U207-181A	U04	U209-226N	U09	U213-243	U06	U350-118	U12
U206-161	U03	U207-183	U04	U209-227	U05	U213-243A	U06	U350-121	U12
U206-161A	U03	U207-183A	U04	U209-227A	U05	U213-245	U06	U350-123	U12
U206-163	U03	U207-185	U04	U209-241	U05	U213-245A	U06	U350-128	U12
U206-163A	U03	U207-185A	U04	U209-241A	U05	U213-247	U06	U350-518	U12
U206-165	U03	U207-187	U04	U209-243	U05	U213-247A	U06	U350-521	U12
U206-165A	U03	U207-187A	U04	U209-243A	U05	U215-161	U07	U351-013	U12
U206-167	U03	U207-191	U04	U209-245	U05	U215-161A	U07	U351-014	U12
U206-167A	U03	U207-191A	U04	U209-245A	U05	U230-181	U07	U351-017	U12
U206-181	U03	U207-193	U04	U209-247	U05	U230-183	U07	U355-014	U13
U206-181A	U03	U207-193A	U04	U209-247A	U05	U230-185	U07	U355-019	U13
U206-183	U03	U207-195	U04	U211-191	U06	U230-201	U07	U355-114	U13
U206-183A	U03	U207-195A	U04	U211-191A	U06	U230-203	U07	U355-119	U13
U206-183N	U09	U207-197	U04	U211-193	U06	U230-205	U07	U400-01	U14
U206-185	U03	U207-197A	U04	U211-193A	U06	U235-181	U08	U400-02	U14
U206-185A	U03	U207-221	U04	U211-195	U06	U235-183	U08	U401-01	U14
U206-185N	U09	U207-221A	U04	U211-195A	U06	U235-185	U08	U401-02	U14
U206-187	U03	U207-223	U04	U211-197	U06	U235-201	U08	U410-01	U14
U206-187A	U03	U207-223A	U04	U211-197A	U06	U235-203	U08	U410-02	U14
U206-187N	U09	U207-225	U04	U211-221	U06	U235-205	U08	U410-03	U14
U206-191	U03	U207-225A	U04	U211-221A	U06	U235-221	U08	U412-03	U14
U206-191A	U03	U207-227	U04	U211-223	U06	U235-223	U08	U412-05	U14
U206-193	U03	U207-227A	U04	U211-223A	U06	U235-225	U08	U413-03	U14
U206-193A	U03	U207-241	U04	U211-225	U06	U300-14	U10	U413-05	U14
U206-195	U03	U207-241A	U04	U211-225A	U06	U300-18	U10	U414-03	U14
U206-195A	U03	U207-243	U04	U211-227	U06	U300-21	U10	U414-05	U14
U206-197	U03	U207-243A	U04	U211-227A	U06	U300-25	U10	U420-03	U14
U206-197A	U03	U207-245	U04	U211-241	U06	U300-30	U10	U420-05	U14
U206-221	U03	U207-245A	U04	U211-241A	U06	U302-14	U10	U421-03	U14
U206-221A	U03	U207-247	U04	U211-243	U06	U302-18	U10	U421-05	U14
U206-223	U03	U207-247A	U04	U211-243A	U06	U302-21	U10	U422-03	U14
U206-223A	U03	U209-183N	U09	U211-245	U06	U302-25	U10	U422-05	U14
U206-225	U03	U209-185N	U09	U211-245A	U06	U302-30	U10	U440-03	U14
U206-225A	U03	U209-186N	U09	U211-247	U06	U306-14	U10	U440-05	U14

Index Art.-Nr. Index Item No.

Art.-Nr. Item No.	Seite Page	Art.-Nr. Item No.	Seite Page	Art.-Nr. Item No.	Seite Page	Art.-Nr. Item No.	Seite Page	Art.-Nr. Item No.	Seite Page
U441-03	U14	U550-225	U16	U602-202	U21	U604-135	U25	U604-652	U29
U441-05	U14	U550-233	U16	U602-223	U21	U604-136	U25	U604-653	U29
U450-003	U15	U550-235	U16	U602-232	U21	U604-138	U25	U604-654	U29
U450-005	U15	U550-603	U16	U602-233	U21	U604-140	U25	U604-655	U29
U450-013	U15	U550-605	U16	U602-251	U22	U604-141	U25	U604-656	U29
U450-015	U15	U550-613	U16	U602-260	U21	U604-143	U25	U604-657	U29
U450-023	U15	U550-615	U16	U602-260	U21	U604-145	U25	U604-901	U29
U450-025	U15	U550-623	U16	U602-270	U21	U604-146	U25	U604-902	U29
U450-033	U15	U580-000	U17	U602-270	U21	U604-150	U26	W100-20	W02
U450-035	U15	U580-001	U17	U602-271	U21	U604-152	U26	W100-30	W02
U450-103	U15	U580-002	U17	U602-271	U21	U604-157	U26	W101-23	W02
U450-105	U15	U580-003	U17	U602-272	U21	U604-159	U26	W102-20	W02
U450-113	U15	U580-004	U17	U602-272	U21	U604-163	U26	W102-28	W02
U450-115	U15	U580-005	U17	U602-273	U21	U604-164	U26	W103-20	W02
U450-123	U15	U585-001	U17	U602-273	U21	U604-165	U26	W103-28	W02
U450-125	U15	U585-002	U17	U602-274	U21	U604-173	U26	W105-27	W02
U450-133	U15	U601-521	U18	U602-550	U22	U604-174	U26	W107-55	W02
U450-135	U15	U601-531	U18	U602-551	U22	U604-201	U26	W110-16	W02
U450-205	U15	U601-550	U18	U602-553	U22	U604-202	U26	W110-24	W02
U450-215	U15	U601-551	U18	U602-554	U22	U604-203	U26	W115-01	W02
U450-225	U15	U601-553	U18	U602-555	U22	U604-205	U26	W115-02	W02
U450-235	U15	U601-554	U18	U602-560	U22	U604-207	U26	W115-03	W02
U450-403	U15	U601-555	U18	U602-564	U22	U604-210	U27	W117-06	W02
U450-405	U15	U601-560	U18	U602-640	U23	U604-211	U27	W117-08	W02
U450-413	U15	U601-564	U18	U602-641	U23	U604-220	U27	W117-10	W02
U450-415	U15	U601-601	U19	U602-642	U23	U604-230	U27	W117-12	W02
U450-423	U15	U601-630	U19	U602-643	U23	U604-231	U27	W117-16	W02
U450-425	U15	U601-631	U19	U602-644	U23	U604-235	U27	W150-00	W03
U450-433	U15	U601-632	U19	U602-645	U23	U604-236	U27	W150-51	W03
U450-435	U15	U601-640	U19	U602-646	U23	U604-250	U27	W155-51	W03
U460-003	U13	U601-641	U19	U602-647	U23	U604-251	U27	W155-52	W03
U460-005	U13	U601-642	U19	U602-650	U23	U604-260	U27	W155-55	W03
U460-103	U13	U601-660	U19	U602-651	U23	U604-261	U27	W155-56	W03
U460-105	U13	U601-661	U19	U602-652	U23	U604-262	U27	W155-59	W03
U460-203	U13	U601-664	U19	U602-653	U23	U604-270	U28	W155-60	W03
U460-205	U13	U601-665	U19	U602-654	U23	U604-271	U28	W160-05	W03
U460-303	U13	U602-101	U20	U602-655	U23	U604-272	U28	W160-11	W03
U460-305	U13	U602-122	U20	U602-656	U23	U604-273	U28	W160-12	W03
U550-003	U16	U602-133	U20	U602-657	U23	U604-274	U28	W160-25	W03
U550-005	U16	U602-134	U20	U604-101	U24	U604-280	U28	W200-101	W04
U550-013	U16	U602-140	U20	U604-102	U24	U604-281	U28	W200-102	W04
U550-015	U16	U602-141	U20	U604-103	U24	U604-282	U28	W200-103	W04
U550-023	U16	U602-143	U20	U604-104	U24	U604-283	U28	W200-104	W04
U550-025	U16	U602-150	U20	U604-107	U24	U604-640	U28	W200-105	W04
U550-033	U16	U602-152	U20	U604-110	U24	U604-641	U28	W200-106	W04
U550-035	U16	U602-154	U20	U604-111	U24	U604-642	U28	W200-107	W04
U550-103	U16	U602-156	U20	U604-113	U24	U604-643	U28	W200-108	W04
U550-113	U16	U602-158	U20	U604-120	U24	U604-644	U28	W200-109	W04
U550-203	U16	U602-163	U20	U604-121	U24	U604-645	U28	W200-110	W04
U550-205	U16	U602-164	U20	U604-125	U25	U604-646	U28	W200-131	W04
U550-213	U16	U602-165	U20	U604-130	U25	U604-647	U28	W200-132	W04
U550-215	U16	U602-173	U20	U604-131	U25	U604-650	U29	W200-134	W04
U550-223	U16	U602-174	U20	U604-132	U25	U604-651	U29	W200-136	W04

Index Art.-Nr. Index Item No.

Art.-Nr. Item No.	Seite Page	Art.-Nr. Item No.	Seite Page	Art.-Nr. Item No.	Seite Page	Art.-Nr. Item No.	Seite Page	Art.-Nr. Item No.	Seite Page
W200-137	W04	W250-003	W06	W272-007	W07	W350-502	W35	W400-126	W12
W200-138	W04	W250-004	W06	W272-008	W07	W350-511	W35	W400-131	W12
W200-201	W04	W250-101	W06	W272-009	W07	W350-512	W35	W400-132	W12
W200-202	W04	W250-102	W06	W272-010	W07	W352-005	W35	W400-133	W12
W200-203	W04	W250-103	W06	W272-011	W07	W352-009	W35	W400-134	W12
W200-204	W04	W250-104	W06	W272-012	W07	W352-010	W35	W400-135	W12
W200-205	W04	W250-501	W06	W272-013	W07	W400-001	W12	W400-136	W12
W200-206	W04	W250-701	W06	W272-014	W07	W400-002	W12	W400-141	W12
W200-207	W04	W250-703	W06	W272-015	W07	W400-003	W12	W400-141	W12
W200-208	W04	W251-001	W06	W272-016	W07	W400-004	W12	W400-143	W12
W200-209	W04	W251-002	W06	W272-017	W07	W400-005	W12	W400-144	W12
W200-210	W04	W251-003	W06	W300-010	W08	W400-006	W12	W400-145	W12
W200-231	W04	W251-004	W06	W300-011	W08	W400-011	W12	W400-146	W12
W200-232	W04	W251-101	W06	W300-030	W08	W400-012	W12	W400-201	W13
W200-234	W04	W251-102	W06	W300-031	W08	W400-013	W12	W400-202	W13
W200-236	W04	W251-103	W06	W300-050	W08	W400-014	W12	W400-203	W13
W200-237	W04	W251-104	W06	W300-131	W08	W400-015	W12	W400-204	W13
W200-238	W04	W251-501	W06	W300-132	W08	W400-016	W12	W400-205	W13
W200-501	W05	W251-703	W06	W300-133	W08	W400-021	W12	W400-206	W13
W200-502	W05	W270-001	W07	W300-134	W08	W400-022	W12	W400-211	W13
W200-503	W05	W270-002	W07	W300-135	W08	W400-023	W12	W400-212	W13
W200-504	W05	W270-003	W07	W302-003	W08	W400-024	W12	W400-213	W13
W200-505	W05	W270-004	W07	W302-007	W08	W400-025	W12	W400-214	W13
W200-506	W05	W270-005	W07	W303-001	W09	W400-026	W12	W400-215	W13
W200-507	W05	W270-006	W07	W303-003	W09	W400-031	W12	W400-216	W13
W200-508	W05	W270-007	W07	W303-005	W09	W400-032	W12	W400-221	W13
W200-509	W05	W270-008	W07	W303-007	W09	W400-033	W12	W400-222	W13
W200-510	W05	W270-009	W07	W303-009	W09	W400-034	W12	W400-223	W13
W200-521	W05	W270-010	W07	W305-000	W08	W400-035	W12	W400-224	W13
W200-522	W05	W270-011	W07	W310-001	W08	W400-036	W12	W400-225	W13
W200-524	W05	W270-012	W07	W310-002	W08	W400-041	W12	W400-226	W13
W200-526	W05	W270-013	W07	W310-005	W08	W400-041	W12	W400-231	W13
W200-527	W05	W270-014	W07	W310-011	W08	W400-043	W12	W400-232	W13
W200-528	W05	W270-101	W07	W310-013	W08	W400-044	W12	W400-233	W13
W200-901	W05	W270-102	W07	W320-001	W09	W400-045	W12	W400-234	W13
W200-902	W05	W270-103	W07	W320-002	W09	W400-046	W12	W400-235	W13
W200-903	W05	W270-104	W07	W320-003	W09	W400-101	W12	W400-236	W13
W200-904	W05	W270-105	W07	W320-004	W09	W400-102	W12	W400-241	W13
W200-905	W05	W270-106	W07	W320-005	W09	W400-103	W12	W400-241	W13
W200-906	W05	W270-107	W07	W320-031	W09	W400-104	W12	W400-243	W13
W200-907	W05	W270-108	W07	W320-032	W09	W400-105	W12	W400-244	W13
W200-908	W05	W270-109	W07	W320-033	W09	W400-106	W12	W400-245	W13
W200-909	W05	W270-110	W07	W320-034	W09	W400-111	W12	W400-246	W13
W200-910	W05	W270-111	W07	W320-035	W09	W400-112	W12	W400-301	W13
W200-921	W27	W270-112	W07	W350-010	W35	W400-113	W12	W400-302	W13
W200-924	W15	W270-113	W07	W350-011	W35	W400-114	W12	W400-303	W13
W200-925	W15	W270-114	W07	W350-015	W35	W400-115	W12	W400-304	W13
W200-926	W19	W272-001	W07	W350-030	W35	W400-116	W12	W400-305	W13
W200-928	W23	W272-002	W07	W350-031	W35	W400-121	W12	W400-306	W13
W200-929	W23	W272-003	W07	W350-050	W35	W400-122	W12	W400-311	W13
W200-940	W05	W272-004	W07	W350-051	W35	W400-123	W12	W400-312	W13
W250-001	W06	W272-005	W07	W350-061	W35	W400-124	W12	W400-313	W13
W250-002	W06	W272-006	W07	W350-501	W35	W400-125	W12	W400-314	W13

Index Art.-Nr. Index Item No.

Art.-Nr. Item No.	Seite Page	Art.-Nr. Item No.	Seite Page	Art.-Nr. Item No.	Seite Page	Art.-Nr. Item No.	Seite Page	Art.-Nr. Item No.	Seite Page
W400-315	W13	W400-909	W15	W401-125	W16	W401-814	W18	W402-106	W20
W400-316	W13	W400-912	W14	W401-126	W16	W401-815	W18	W402-111	W20
W400-321	W13	W400-913	W14	W401-201	W17	W401-816	W18	W402-112	W20
W400-322	W13	W400-915	W14	W401-202	W17	W401-901	W19	W402-113	W20
W400-323	W13	W400-917	W14	W401-203	W17	W401-905	W19	W402-114	W20
W400-324	W13	W400-922	W14	W401-204	W17	W401-907	W19	W402-115	W20
W400-325	W13	W400-923	W14	W401-205	W17	W401-909	W19	W402-116	W20
W400-326	W13	W400-925	W14	W401-206	W17	W401-912	W18	W402-121	W20
W400-331	W13	W400-927	W14	W401-211	W17	W401-913	W18	W402-122	W20
W400-332	W13	W400-930	W14	W401-212	W17	W401-915	W18	W402-123	W20
W400-333	W13	W400-955	W15	W401-213	W17	W401-917	W18	W402-124	W20
W400-334	W13	W400-956	W15	W401-214	W17	W401-922	W18	W402-125	W20
W400-335	W13	W400-957	W15	W401-215	W17	W401-923	W18	W402-126	W20
W400-336	W13	W400-958	W15	W401-216	W17	W401-925	W18	W402-131	W20
W400-341	W13	W400-965	W15	W401-221	W17	W401-927	W18	W402-132	W20
W400-341	W13	W400-970	W15	W401-222	W17	W401-930	W18	W402-133	W20
W400-343	W13	W400-972	W15	W401-223	W17	W401-965	W19	W402-134	W20
W400-344	W13	W400-973	W15	W401-224	W17	W401-970	W19	W402-135	W20
W400-345	W13	W400-974	W15	W401-225	W17	W402-001	W20	W402-136	W20
W400-346	W13	W401-001	W16	W401-226	W17	W402-002	W20	W402-141	W20
W400-501	W12	W401-002	W16	W401-301	W17	W402-003	W20	W402-141	W20
W400-511	W12	W401-003	W16	W401-302	W17	W402-004	W20	W402-143	W20
W400-521	W12	W401-004	W16	W401-303	W17	W402-005	W20	W402-144	W20
W400-531	W12	W401-005	W16	W401-304	W17	W402-006	W20	W402-145	W20
W400-541	W12	W401-006	W16	W401-305	W17	W402-011	W20	W402-146	W20
W400-601	W12	W401-011	W16	W401-306	W17	W402-012	W20	W402-201	W21
W400-611	W12	W401-012	W16	W401-311	W17	W402-013	W20	W402-202	W21
W400-621	W12	W401-013	W16	W401-312	W17	W402-014	W20	W402-203	W21
W400-631	W12	W401-014	W16	W401-313	W17	W402-015	W20	W402-204	W21
W400-641	W12	W401-015	W16	W401-314	W17	W402-016	W20	W402-205	W21
W400-701	W24	W401-016	W16	W401-315	W17	W402-021	W20	W402-206	W21
W400-703	W24	W401-021	W16	W401-316	W17	W402-022	W20	W402-211	W21
W400-801	W14	W401-022	W16	W401-321	W17	W402-023	W20	W402-212	W21
W400-802	W14	W401-023	W16	W401-322	W17	W402-024	W20	W402-213	W21
W400-803	W14	W401-024	W16	W401-323	W17	W402-025	W20	W402-214	W21
W400-804	W14	W401-025	W16	W401-324	W17	W402-026	W20	W402-215	W21
W400-805	W14	W401-026	W16	W401-325	W17	W402-031	W20	W402-216	W21
W400-806	W14	W401-101	W16	W401-326	W17	W402-032	W20	W402-221	W21
W400-811	W14	W401-102	W16	W401-501	W16	W402-033	W20	W402-222	W21
W400-812	W14	W401-103	W16	W401-511	W16	W402-034	W20	W402-223	W21
W400-813	W14	W401-104	W16	W401-521	W16	W402-035	W20	W402-224	W21
W400-814	W14	W401-105	W16	W401-601	W16	W402-036	W20	W402-225	W21
W400-815	W14	W401-106	W16	W401-611	W16	W402-041	W20	W402-226	W21
W400-816	W14	W401-111	W16	W401-621	W16	W402-041	W20	W402-231	W21
W400-821	W14	W401-112	W16	W401-801	W18	W402-043	W20	W402-232	W21
W400-822	W14	W401-113	W16	W401-802	W18	W402-044	W20	W402-233	W21
W400-823	W14	W401-114	W16	W401-803	W18	W402-045	W20	W402-234	W21
W400-824	W14	W401-115	W16	W401-804	W18	W402-046	W20	W402-235	W21
W400-825	W14	W401-116	W16	W401-805	W18	W402-101	W20	W402-236	W21
W400-826	W14	W401-121	W16	W401-806	W18	W402-102	W20	W402-241	W21
W400-901	W15	W401-122	W16	W401-811	W18	W402-103	W20	W402-241	W21
W400-905	W15	W401-123	W16	W401-812	W18	W402-104	W20	W402-243	W21
W400-907	W15	W401-124	W16	W401-813	W18	W402-105	W20	W402-244	W21

Index Art.-Nr. Index Item No.

Art.-Nr. Item No.	Seite Page	Art.-Nr. Item No.	Seite Page	Art.-Nr. Item No.	Seite Page	Art.-Nr. Item No.	Seite Page	Art.-Nr. Item No.	Seite Page
W402-245	W21	W402-815	W22	W403-032	W25	W407-002	W27	W420-100	W29
W402-246	W21	W402-816	W22	W403-033	W25	W407-003	W27	W420-101	W29
W402-301	W21	W402-821	W22	W403-034	W25	W407-004	W27	W420-120	W29
W402-302	W21	W402-822	W22	W403-035	W25	W407-005	W27	W420-130	W29
W402-303	W21	W402-823	W22	W403-036	W25	W407-011	W27	W420-132	W29
W402-304	W21	W402-824	W22	W403-111	W25	W407-012	W27	W420-150	W29
W402-305	W21	W402-825	W22	W403-112	W25	W407-013	W27	W420-151	W29
W402-306	W21	W402-826	W22	W403-113	W25	W407-014	W27	W420-152	W29
W402-311	W21	W402-911	W22	W403-114	W25	W407-015	W27	W420-153	W29
W402-312	W21	W402-912	W22	W403-115	W25	W407-021	W27	W420-154	W29
W402-313	W21	W402-913	W22	W403-116	W25	W407-022	W27	W420-155	W29
W402-314	W21	W402-914	W22	W403-131	W25	W407-023	W27	W420-156	W29
W402-315	W21	W402-916	W22	W403-132	W25	W407-024	W27	W420-161	W29
W402-316	W21	W402-917	W22	W403-133	W25	W407-025	W27	W420-162	W29
W402-321	W21	W402-918	W22	W403-134	W25	W407-101	W27	W420-163	W29
W402-322	W21	W402-919	W22	W403-135	W25	W407-102	W27	W420-164	W29
W402-323	W21	W402-921	W22	W403-136	W25	W407-103	W27	W420-165	W29
W402-324	W21	W402-922	W22	W403-511	W25	W407-104	W27	W420-166	W29
W402-325	W21	W402-923	W22	W403-531	W25	W407-105	W27	W420-301	W30
W402-326	W21	W402-924	W22	W403-611	W25	W407-111	W27	W420-302	W30
W402-331	W21	W402-926	W22	W403-631	W25	W407-112	W27	W420-312	W30
W402-332	W21	W402-927	W22	W403-801	W25	W407-113	W27	W420-313	W30
W402-333	W21	W402-928	W22	W403-802	W25	W407-114	W27	W420-314	W30
W402-334	W21	W402-929	W22	W403-803	W25	W407-115	W27	W420-315	W30
W402-335	W21	W402-930	W22	W403-804	W25	W407-121	W27	W420-420	W30
W402-336	W21	W402-931	W22	W403-805	W25	W407-122	W27	W420-421	W30
W402-341	W21	W402-941	W23	W403-806	W25	W407-123	W27	W425-001	W30
W402-341	W21	W402-942	W23	W403-903	W25	W407-124	W27	W425-003	W30
W402-343	W21	W402-943	W23	W403-905	W25	W407-125	W27	W425-005	W30
W402-344	W21	W402-944	W23	W405-001	W26	W407-501	W27	W425-007	W30
W402-345	W21	W402-946	W23	W405-002	W26	W407-511	W27	W425-009	W30
W402-346	W21	W402-947	W23	W405-003	W26	W407-521	W27	W425-011	W30
W402-501	W20	W402-948	W23	W405-004	W26	W407-601	W27	W425-013	W30
W402-511	W20	W402-949	W23	W405-005	W26	W407-611	W27	W425-015	W30
W402-521	W20	W402-955	W23	W405-011	W26	W407-621	W27	W425-017	W30
W402-531	W20	W402-956	W23	W405-012	W26	W407-801	W27	W425-019	W30
W402-541	W20	W402-957	W23	W405-013	W26	W407-802	W27	W800-01	W31
W402-601	W20	W402-958	W23	W405-014	W26	W407-803	W27	W800-02	W31
W402-611	W20	W402-965	W23	W405-015	W26	W407-804	W27	W800-03	W31
W402-621	W20	W402-970	W23	W405-111	W26	W407-805	W27	W805-12	W31
W402-631	W20	W402-972	W23	W405-112	W26	W407-901	W27	W805-21	W31
W402-641	W20	W402-973	W23	W405-113	W26	W407-911	W27	W805-22	W31
W402-703	W24	W402-974	W23	W405-114	W26	W407-921	W27	W810-01	W31
W402-801	W22	W402-975	W23	W405-115	W26	W407-970	W27	W810-02	W31
W402-802	W22	W402-976	W23	W405-501	W26	W420-001	W28	W810-03	W31
W402-803	W22	W402-977	W23	W405-511	W26	W420-003	W28	W810-04	W31
W402-804	W22	W403-011	W25	W405-611	W26	W420-005	W28	W821-01	W31
W402-805	W22	W403-012	W25	W405-801	W26	W420-011	W28	W821-02	W31
W402-806	W22	W403-013	W25	W405-802	W26	W420-013	W28	W821-03	W31
W402-811	W22	W403-014	W25	W405-803	W26	W420-015	W28	W821-04	W31
W402-812	W22	W403-015	W25	W405-804	W26	W420-051	W28	W821-05	W31
W402-813	W22	W403-016	W25	W405-805	W26	W420-053	W28	W825-01	W31
W402-814	W22	W403-031	W25	W407-001	W27	W420-060	W28	W825-02	W31

Index Art.-Nr. Index Item No.

Art.-Nr. Item No.	Seite Page	Art.-Nr. Item No.	Seite Page
W825-03	W31	W852-63	W33
W827-01	W32	W852-64	W33
W827-02	W32	W852-65	W33
W827-03	W32	W852-66	W33
W827-04	W32	W852-67	W33
W828-01	W32	W852-68	W33
W838-01	W32	W852-69	W33
W838-03	W32	W880-01	W34
W838-05	W32	W880-11	W34
W838-07	W32	W881-01	W34
W838-09	W32	W881-02	W34
W838-11	W32	W881-03	W34
W838-13	W32	W881-41	W34
W850-01	W32		
W850-03	W32		
W850-05	W32		
W850-07	W32		
W850-09	W32		
W850-11	W32		
W850-13	W32		
W850-15	W32		
W850-41	W32		
W850-42	W32		
W850-43	W32		
W850-44	W32		
W850-45	W32		
W850-46	W32		
W850-47	W32		
W850-48	W32		
W850-49	W32		
W850-61	W32		
W850-62	W32		
W850-63	W32		
W850-64	W32		
W850-65	W32		
W850-66	W32		
W852-01	W33		
W852-02	W33		
W852-04	W33		
W852-05	W33		
W852-07	W33		
W852-09	W33		
W852-11	W33		
W852-11	W33		
W852-12	W33		
W852-13	W33		
W852-14	W33		
W852-31	W33		
W852-32	W33		
W852-33	W33		
W852-41	W33		
W852-61	W33		
W852-62	W33		

Produkt Index Product Index

deutsch
german

Produktname Product	Seite Page
Abortuszangen	T41
ACLAND Gefäßclips	G46
ADLERKREUTZ Chirurgische Pinzetten	F13
ADSON Saugrohre	B36
Wundspreizer	D38, D40
Anat. Pinzetten	F03, F04
Chirurgische Pinzetten	F09, F10
Arterienklemmen	G12
Nadelhalter	H07
Raspatorien	K27
Hohlmeißelzangen	K55
Bipolare Pinzetten	U02
ADSON-BROWN Chirurgische Pinzetten	F10
ADSON-EWALD Anat. Pinzetten	F03
Chirurgische Pinzetten	F09
ADSON-LIGHT Anat. Pinzetten	F04
Chirurgische Pinzetten	F10
Ahlen	K68
ALDERDYCE Elevatorien	K36
ALEXANDER Flachmeißel	K04
ALEXANDER Raspatorien	K29
ALEXANDER Biopsiezangen	T30
ALLEN Darmklemmen	S06
ALLIS Darmfasszangen	S02
ALLIS-ADAIR Darmfasszangen	S02
ALLISON Lungenspatel	R11
ALM Wundspreizer	D34
ALY Sensibilitätsinstrumente	A02
Amnioskopie-Instrumente	T38
Amputationsmesser	B08
Amputations-Reaktoren	K51
Amputationssägen	B11
Anal spreizer	S12
Anastomosenklemmen	R12, R13, R29, R36, R38
Anat. Pinzetten	F02 - F07
ANDERSON-ADSON Wundspreizer	D38
ANDREW-PYNCHON Saugrohre	B28
Anlegzange	G40
ANTHONY Saugrohre	B30
Aorta-Aneurysma-Klemmen	R16 - R18, R20, R28
Aortaklemmen	R13 - R15
ARRUGA Nadelhalter	H13, H31
Arterienklemmen	G02 - G24
ATRAUMA FORCEPS Atrauma-Klemmen	R12 - R41
Atraumatische Mehrzweckklemmen	R25, R26, R30, R32, R35
Atraumatische Pinzetten	F27 - F29
Aurikelklemmen	R19
AUSTIN Mikropinzetten	F19
AUVARD Scheidenspekula	T12
BABCOCK Darmfasszangen	S03

Produktname Product	Seite Page
BABINSKY Perkussionshämmer	A02
BABY-ADSON Arterienklemmen	G11
BABY-ALLIS Darmfasszangen	S02
BABY-BABCOCK Darmfasszangen	S03
BABY-BALFOUR Bauchdeckenhalter	D45
BABY-COLLIN Wundspreizer	D41
BABY-CRILE Arterienklemmen	G04
BABY-CRILE-WOOD Nadelhalter	H04
BABY-KOCHER Darmklemmen	S06
BABY-LEXER (KNAPP) Feine Scheren	C20
BABY-METZENBAUM Präparierscheren	C11
BABY-MIKULICZ Hysterektomieklammern	G31
BABY-MIXTER Arterienklemmen	G19
BABY-OLSEN-HEGAR Nadelhalter	H17
BABY-OVERHOLT Arterienklemmen	G16
BABY-POOLE Saugrohre	B29
BABY-ROUX Wundhaken	D16
BABY-SATINSKY Arterienklemmen	G24
BABY-SENN-MILLER Feine Wundhaken	D06
BABY-TISCHLER Biopsiezangen	T31
BABY-WEBSTER Nadelhalter	H04
BABY-YANKAUER Saugrohre	B28
BACKHAUS Tuchklemmen	G32, G33
BACON Hohlmeißelzangen	K55
BAGGISH Biopsiezangen	T31
BAILEY Rippenkontraktoren	R09
BAILEY-BABY Rippenkontraktoren	R09
BAILEY-GIBBON Rippenkontraktoren	R09
BAINBRIDGE Arterienklemmen	G10
BAKES Gallengangdilatoren	S22
BALFOUR Bauchdeckenhalter	D46 - D48
BALL / SOCKET Tuchklemmen	G33
BALLENGER (FÖRSTER) Schwammzangen	G35
BANE-HARTMANN Hohlmeißelzangen	K54
BARNES Saugrohre	B35
BARNES-NEVILLE Geburtszangen	T45
BARON Saugrohre	B34
BARR Mastdarmspekula	S11
Sonden	S17
BARRAQUER Pinzetten	F15
Nadelhalter	H25
BARRAQUER-TROUTMAN Nadelhalter	H25
BARRETT Hakenzangen	T21
BARRON Skalpellgriffe	B02
BARSKY Feine Wund-, und Hauthäkchen	D03
Basiotrieb	T45
Bauchdeckenhalter	D45 - D54
BEACHAM Hakenzangen	T22
BEAUPRE Pinzetten	F15
BECK Mehrzweckklemmen	R26, R36

Produkt Index Product Index

Produktname Product	Seite Page
Beckenzirkel	T40
BECKMANN Wundspreizer	D39
BECKMANN-ADSON Wundspreizer	D39
BECKMANN-EATON Wundspreizer	D40
BEEBEE Zahnfleischscheren	C30
BEER Pinzetten	F15
BEESON Gipsspreizer	H42
BENGOLEA Arterienklemmen	G15
BENNETT Knochenhebel	K41
BENSAUDE Analspreizer	S12
BERGER Biopsiezangen	T30
BERGMANN Skalpelle	B06
Verbandscheren	C35
Feine Wund-, und Hauthäkchen	D04
Hämmer	K15, K16
BERLINER Perkussionshämmer	A02
BERNHARD Tuchklemmen	G34
BEST-SELECT Nadelhalter	H08
BETHUNE Rippenscheren	R09, R10
BEYER Hohlmeißelzangen	K55, K57
BIEMER Gefäßclips	G47
BIEMER-MÜLLER Gefäßclips	G48
BIER Amputationssägen	B12
Kanülen	B30
BILL Geburtszangen	T45
Biopsieküretten	T27, T28
Biopsiezangen	T28 - T 32
Bipolare Kabel	U15
Bipolare Pinzetten	U02 - U09
Bipolare Scheren	U11 - U13
BIRCHER Messer	B11
BIRCHER-GANSKE Knochenhalte-zangen	K45
BIRKETT Arterienklemmen	G13
BLAKE Gallensteinzangen	S22
BLAKE / ZWEIFEL Uterusküreten	T37
Blasenwundspreizer	S25
Bleihand	B21
BLOUNT Wundhaken	D26
Elevatorien	K38
Knochenhebel	K38, K42
BLUMENTHAL Hohlmeißelzangen	K52
BÖHLER Hohlmeißelzangen	K56
Knochensplitterzangen	K63
Extensionsbügel	K69
Bohrdrahtbehälter	W08
Bohrer	K66
BONNEY Anat. Pinzetten	F07
Chirurgische Pinzetten	F13
BOROWSKI Wundhaken	D28
BÖTTCHER Tonsillenscheren	C28

deutsch german

Produktname Product	Seite Page
BOYNTON Nadelhalter	H13
Hohlmeißelzangen	K52
BOYS-ADAIR Darmfasszangen	S02
BOZEMANN Tupferzangen	G36
Nadelhalter	H07
BOZEMANN-DOUGLAS Tupferzangen	G36
BRAND Sehnenführer	B19
Sehnenfasszangen	B20
BRAUN Scheidenspekula	T10
Uterus-Depressoren	T20
Hakenzangen	T21, T22
Dekapitationshaken	T42
Geburtszangen	T45
BRAUN-STADLER Episiotomiescheren	C13
BREISKY Scheidenspekula	T13
BRIDGE Arterienklemmen	G16
BRINKERHOFF Proktoskope	S13
BRISTOW Knochenhebel	K38
BRISTOW-BANKART Wundhaken	D27
BRODIE Sonden	B13
Bronchusklemmen	R20, R21
BROPHY Anat. Pinzetten	F06
Chirurgische Pinzetten	F12
BROPHY (SULLIVAN) Feine Scheren	C20
BROWN Pinzetten	F14
Nadelhalter	H03
BRÜNINGS-BRUNK Wundhaken	D19
BRUNNER Wundhaken	D23
Unterbindungsnadeln	H35
Führungshohlsonden	H37 - H39
Rippenscheren	R10
Darmklemmen	S06
BRUNS Verbandscheren	C35
Scharfe Löffel	K18, K23
Bruststützen	A09
BRYANT Tupferzangen	G38
BUCK Perkussionshämmer	A02
Watteträger	B15
BUCK-GRAMCKO Knochenhebel	K38
BUELAU Trokare	B27
BUIE Absaugrohr	S17
Bulldogklemmen	G40 - G44
BUMM Uterusküreten	T37
BUNNEL Handbohrapparate	K65
BUNNELL Sehnenführer	B19
Sehnen Schäler	B19
BUNT Sterilisierklammern	W02
BURFORD Rippensperren	R08
BURKE Biopsiezangen	T31, T32
Bürsten	W03

Produkt Index Product Index

deutsch
german

Produktname Product	Seite Page
BUSCH Nabelschnurscheren	C14
BUSHE Scharfe Löffel	K21
CAMPBELL Dilatationsbougies	S27
CANNY-RYALL Wundhaken	D20
CARELL Arterienklemmen	G07
CAROLL Messinstrumente	A04
Sehnenschnurklemmen	B20
Carotis-Shuntklemmen	R34
CASPAR Messinstrumente	A05
Wundhaken	D22
CASTANARES Scheren für plastische Chirurgie	C27
CASTANEDA Rippensperrerr	R08
Neonatal- und Pädiatrie-Klemmen	R42
CASTROVIEJO Messinstrumente	A05
Klingenhalter	B07
Mikroscheren	C38
Nadelhalter	H18 - H20, H30
CASTROVIEJO-KALT Nadelhalter	H31
CATLIN Amputationsmesser	B08
CHANDLER Elevatorien	K37
CHAPUT Arterienklemmen	G08
CHARNLEY Bauchdeckenhalter	D52
CHARRIERE Amputationssägen	B12
CHEATLE Sterilisierzangen	W02
CHELSEA-EATON Proktoskope	S14
CHERON Tupferzangen	G38
CHILD Wundklammerpinzetten	H41
Chirurgische Pinzetten	F08 - F13
Chirurgische Scheren	C02 - C06
Circumcisionsgeräte	S29
CLEVELAND Hohlmeißelzangen	K52
Knochensplitterzangen	K62
CLOWARD Hämmer	K15
COAKLEY Trokare	B26
Coarctationsklemmen	R21 - R24
COBB Osteotome	K05
Hohlmeißel	K07
Scharfe Löffel	K22
Raspatorien	K32
COBETT Dermatome	B10
COBRA Knochenhebel	K41
COHEN Uterusmanipulatoren	T39
COLLER-CRILE Arterienklemmen	G05
COLLIER Nadelhalter	H03
COLLIN Dynamometer	A03
Skalpgriffe	B02, B03
Knochenscheren	C36
Wundhaken	D17
Wundspreizer	D41, D42
Arterienklemmen	G09

Produktname Product	Seite Page
COLLIN Tupferzangen	G38
Wundklammerzangen	H40
Hämmer	K15
Scheidenspekula	T04
Uterusfasszangen	T25
Beckenzirkel	T40
Nabelschnurklemmen	T42
COLLIN-DUVAL Pinzetten	F15
COLLIN-HARTMANN Wundhaken	D17
COLLYER Beckenzirkel	T40
Columella-Pinzette	F18
CONE Wundspreizer	D38
Scharfe Löffel	K23
Container-System	W10 - W30
CONTOUR Wundspreizer	D36
CONVERSE Nadelhalter	H03
COOLEY Saugrohre	B29
Wundhaken	D29
Atraumatische Pinzetten	F29
Bulldogklemmen	G41
Rippensperrerr	R3, R7
Carotis-Shuntklemmen	R34
Mehrzweckklemmen	R35, R38
Iliaca-Klemmen	R36
Tangentialklemmen	R37
Feine Klemmen	R38 - R41
First Rippenscheren	R10
COOLEY-DERRA Anastomosenklemmen	R36, R38
COOLEY-GLOVER Bulldogklemmen	G44
COOPER Unterbindungsnadeln	H35
CORYLLOS Wundhaken	D25
CORYLLOS Rippenscheren	R10
COTTLE Messinstrumente	A04
Nasenscheren	C30
Feine Wund-, und Hauthäkchen	D02
Nasenpinzetten	F18
Hämmer	K14
Columella-Pinzette	F18
COTTLE-KAZANIJAN Knochensplitterzangen	K62
COTTLE-MASING Nasenscheren	C29
CRAFOORD Lungenlappenscheren	C15
Arterienklemmen	G14
CRAFOORD-SELLORS Arterienklemmen	G16
CRECO Elevatorien	K37
CRILE Feine Wund-, und Hauthäkchen	D04
Wundhaken	D08
Arterienklemmen	G04
Nadelhalter	H13
CRILE-MURRAY Nadelhalter	H05
CRILE-RANKIN Arterienklemmen	G04

Produkt Index Product Index

deutsch
german

Produktname Product	Seite Page
CRILE-WOOD Nadelhalter	H05
CUSCO Scheidenspekula	T02
CUSHING Wundhaken	D09 - D11
Anat.Pinzetten	F07, F07
Chirurgische Pinzetten	F12
Raspatorien	K28
Elevatorien	K35
CUSHING-KOCHER Wundhaken	D10
CUSHING-TAYLOR Anat.Pinzetten	F07
CZERNY Mastdarmspekula	S11
Gallensteinzangen	S22
Hakenzangen	T22
DAHMEN Osteotom	K09
DALE Hohlmeißelzangen	K61
Peripheal-Gefäßklemmen	R27
DANDY Feine Scheren	C28
Arterienklemmen	G11
DARDIK Mehrzweckklemmen	R32
Darm- und Magenquetschklemmen	S10
Darmfasszangen	S2, S3
Darmklemmen	S05 - S08
Darmscheren	C14
DARRACH Elevatorien	K37
DARTIGUES Uterusfasszangen	T25
DAUBENSPECK Scharfe Löffel	K20
DAVIDSON Wundhaken	D28
DAVIDSON-ALEXANDER Raspatorien	K31
DAVIS Feine Wundhaken	D06
Sterilisierzangen	W02
DEAN Zahnfleischscheren	C31
DEAVER Chirurgische Scheren	C03
Wundhaken	D29, D30
DEBAKEY Gefäß-Dilatoren	B18
Saugrohre	B28
Präparierscheren	C07
Gefäßscheren	C15, C16
Wundspreizer	D43
Mikropinzetten	F19
Atraumatische Pinzetten	F27, F28
Nadelhalter	H08
Rippensperrer	R05
Aorta-Aneurysma-Klemmen	R17, R18, R28
Coarctationsklemmen	R23, R24
Mehrzweckklemmen	R25 - R38
Präparier- und Ligaturklemmen	R28
Anastomosenklemmen	R29
Ligaturklemmen	R29
Bulldogklemmen	G41, G44
Aortaklemmen	R14
DEBAKEY (DENNIS) Atraumatische Pinzetten	F29

Produktname Product	Seite Page
DEBAKEY-BAHNSON Aorta-Aneurysma-Klemmen	R20
DEBAKEY-BAINBRIDGE Arterienklemmen	G10
DEBAKEY-BECK Mehrzweckklemmen	R26
DEBAKEY-CASTANEDA Feine Klemmen	R33
DEBAKEY-DIETRICH Atraumatische Pinzetten	F27
Bulldogklemmen	G41
DEBAKEY-HESS Bulldogklemmen	G42
DEBAKEY-SATINSKY Bulldogklemmen	G44
DEBAKEY-TITANIUM Bulldogklemmen	G41
DEJERINE Perkussionshämmer	A02
Dekapitationshaken	T42
DELEE Scheidenspekula	T12
Beckenzirkel	T40
Geburtszangen	T43
DEMARTEL Arterienklemmen	G08
DE-MARTEL-WOLFSON Magenklemmen	S09
DEMEL Drahtumführungsnaedeln	K68
DENIS-BROWN Bauchdeckenhalter	D49
DERF Nadelhalter	H04
Dermatome	B09
DERRA-DEBAKEY Anastomosenklemmen	R12
DESCHAMPS Unterbindungsnaedeln	H33, H34
DESJARDINS Nierenstielklemmen	S21
Gallensteinzangen	S22
Gallensteinlöffel	S23
DESMARRES Wundhaken	D09
DEVILBISS Scheidenspekula	T04
DIEFFENBACH Bulldogklemmen	G40
DIETRICH/HEGEMANN Gefäßscheren	C17
DIETRICH Bulldogklemmen	G41
Nadelhalter	H18
Aortaklemmen	R14
Dilatationsbougies	S26, S27
DINGMANN Knochenhalte-zangen	K45
DITTEL Dilatationsbougies	S26
DIXON-LOVELACE Arterienklemmen	G11
DOUAY Biopsiezangen	T30
DOUGLAS Pinzetten	F15
DOYEN Sonden	B12
Chirurgische Scheren	C06
Wundhaken	D22
Bauchdeckenhalter	D52
Tuchklemmen	G34
Raspatorien	K31
Darmklemmen	S05
Scheidenspekula	T11, T12
Uteruspolypenzangen	T24
Myomheber	T26
DOYEN-STILLE Wundhaken	D22
Drahtinstrumente	K69 - K79

Produkt Index Product Index

deutsch
german

Produktname Product	Seite Page
Drahtkneifzangen.....	K76 - K78
Drahtscheren	C32
Drahtumführungsnadeln.....	K68
Drahtzangen.....	K70 - K74
DUBOIS Kephalotom-Scheren.....	C12
DUEHRSEN Anat.Pinzetten	F06
DUNCAN Biopsieküretten.....	T27
DUNHILL Arterienklemmen.....	G09
DUPLAY Tupferzangen.....	G37
Hakenzangen.....	T22
DUPUY-WEISS Unterbindungsnadeln.....	H32
DURANTE Pinzetten	F14
DURHAM Unterbindungsnadeln.....	H32
DUVAL Pinzetten	F15
Gewebe- Organfasszangen.....	S04
Dynamometer	A03
EASTMAN Scheidenspekula.....	T07
ECHLIN Hohlmeißelzangen	K59
EDER Watteträger.....	B15
EICKEN Saugrohre	B32
EISELSBERG Ligaturscheren.....	C32
Elevatoren.....	K34 - K37
EMMET Tupferzangen.....	G38
Fistelhaken	T26
Endarterektomiestripper	B16
ENGEL Gipssäge	H42
ENGL. MODELL Anat.Pinzetten.....	F03
Tuchklemmen	G32
E nukleationsscheren	C23
Episiotomiescheren	C13
EPENDORF Biopsiezangen.....	T30, T32
EPSTEIN Bauchdeckenhalter	D54
Scharfe Löffel	K21
ESMARCH Verbandsscheren	C35
Gipsmesser	H42
Extensionsbügel	K69
Fadenfänger	H40
Fadengabel	H40
FANSLER Proktoskope	S14
FARABEUF Wundhaken.....	D16
Raspatorien.....	K27
Knochenhalte zangen	K50
FARABEUF-COLLIN Raspatorien	K27
FARABEUF-LAMBOTTE Knochenhalte zangen	K50
FARELL Watteträger.....	B15
FAURE Hysterektomie klemmen	G29, G32
Biopsiezangen.....	T29
FAVALORO Gefäßscheren	C15
FEHLAND Rektum-Anastomosenklemmen	S08
FEHLAND-ATRAUMA Rektum-Anastomosenklemmen.....	S08

Produktname Product	Seite Page
FEILCHENFELD Splitterpinzetten.....	F16
FEIN Watteträger.....	B15
FEINE Klemmen	R33, R38
Pinzetten	F17
Scheren	C18 - C25, C28
Wund-, und Hauthäkchen	D02 - D04
Wundhaken	D05 - D10
FERGUSSON Saugrohre.....	B38
Chirurgische Scheren	C04
Hysterektomie klemmen.....	G27
Knochenhalte zangen	K46
Gallensteinlöffel	S23
FERRIS-SMITH Chirurgische Pinzetten.....	F13
FERROZELL Führungshohlsonden.....	H37
Feststellzange.....	K74
Fingernagelbohrer	B22
Fingerringssägen	B22
FINOCHIETTO Arterienklemmen.....	G22
Nadelhalter	H12
Rippensperrerr	R03, R08
FINOCHIETTO-BABY Rippensperrerr.....	R03
FINOCHIETTO-BURFORD Rippensperrerr.....	R06
FINOCHIETTO-MINI Rippensperrerr	R03
FINSEN Wundspreizer.....	D34
FISCH Saugrohre.....	B36
Fistelhaken	T26
Flachmeißel.....	K02 - K10
FOMON Nasenscheren.....	C29, C30
FOMON (SABER-BACK) Nasenscheren	C29
FORD-DIXON Haemorrhoidal-Ligatoren.....	S19
FOREGGER Laryngoskope	A11
FÖRSTER (BALLENGER) Schwammzangen.....	G35
FOX Lupusküretten	B24
FRANKLIN-SILVERMAN Kanülen.....	B30
FRANZ Bauchdeckenhalter.....	D50
FRAZIER Saugrohre.....	B36 - B40
Feine Wund-, und Hauthäkchen	D02
Bauchdeckenhalter	D45
FREEMAN Scheren für plastische Chirurgie	C27
FREEMAN-KAYE Scheren für plastische Chirurgie	C26
Fremdkörperzange.....	S29
FRENZEL Nystagmusbrillen	A14
FRIEDMANN Hohlmeißelzangen	K52
Scheidenspekula.....	T14
FRIEDMANN-FINO Hohlmeißelzangen	K52
FRITSCH Wundhaken	D22
FRYKHOLM Hohlmeißelzangen	K60
FUCHSIG Arterienklemmen	G12
Führungshohlsonden	H37 - H39
Führungsnadeln	B25

Produkt Index Product Index

deutsch
german

Produktname Product	Seite Page
FUKUDA Wundhaken	D27
Gallengangdilatoren	S22
Gallensteinlöffel	S23
Gallensteinzangen	S22
GARDNER Ersatzbackenpaar	K12
GARRETT Gefäß-Dilatoren	B18
GAUSS Abortuszangen	T41
Geburtslöffel	T42
Geburtszangen	T43 - T45
Gefäßclips	G44 - G49
Gefäßdilatoren	F17
Gefäß-Dilatoren	B18
Gefäßscheren	C15 - C17
Gefäß-Spatel	B17
GELLHORN Biopsiezangen	T28
GELPI Wundspreizer	D43
GELPI-SELETZ Wundspreizer	D43
GEMINI Arterienklemmen	G18
GERALD Anat.Pinzetten	F06
Chirurgische Pinzetten	F12
GERZOG Hämmer	K14
Gewebe- Organfasszangen	S04
GIERTZ-STILLE Rippenscheren	R09
GILLIES Feine Wund-, und Hauthäkchen	D04
Anat.Pinzetten	F04
Chirurgische Pinzetten	F10
Nadelhalter	H17
GIL-VERNET Wundhaken	D10
Gips-Instrumente	H42 - H44
GIPSSÄGEN	H43, H44
Gipsscheren	C36
GLENOID Knochenhalte-zangen	K48
GLOVER Bulldogklemmen	G43
Anastomosenklemmen	R13
Aorta-Aneurysma-Klemmen	R16
GLOVER (POTTS) Anastomosenklemmen	R12
GLUCK Knochenscheren	C36
GOELET Wundhaken	D17
GOLDMAN-FOX Zahnfleischscheren	C30
GOOD Nasenscheren	C29
GOODELL Uterusdilatoren	T18
GORNEY Scheren für plastische Chirurgie	C27
GOSSET Bauchdeckenhalter	D45
GOURDET Uteruslöffel	T33
GRADLE Pinzetten	F15
GRAEFE Feine Scheren	C24
Feine Wund-, und Hauthäkchen	D02
GRAVE Scheidenspekula	T03
Scheidenspekula	T03
GRAVE-LASER Scheidenspekula	T03

Produktname Product	Seite Page
GRAY Nierenstielklemmen	S21
GREEN Wundhaken	D21
GREEN-ARMYTAGE Abortuszangen	T41
GREENE Uterusküreten	T34
GREGORY Peripheal-Gefäßklemmen	R27
GROSS-MAIER Tupferzangen	G36
GRÜNWALD Anat.Pinzetten	F07
GUTHRIE Feine Wund-, und Hauthäkchen	D02
GUYON Nierenstielklemmen	S20
Dilatationsbougies	S27
GUYON-ATRAUMA Nierenstielklemmen	S20
Gynäkologische Scheren	C11, C12
HABERER Spatel	D31
Haemorrhoidal-Ligatoren	S18, S19
Haemorrhoidalzangen	S18
HAGLUND-STILLE Gipsspreizer	H42
HAIGHT Rippensperrerr	R0, R07
HAJEK Saugrohre	B32
Hämmer	K14
HAKANSSON Hohlmeißelzangen	K53
Hakenzangen	T21 - T24
HALLE Tonsillenscheren	C28
Scharfe Löffel	K21
HALSEY Nadelhalter	H03
HALSTED-MOSQUITO Arterienklemmen	G06
Arterienklemmen	G06
Hämmer	K12 - K17
Handbohrapparate	K65 - K67
Handbohrfutter	K67
Handwaschbürsten	W03
HANK Uterusdilatoren	T17
HARKEN Arterienklemmen	G24
Aurikelklemmen	R19
HARRINGTON Wundhaken	D30
HARTMANN Watteträger	B15
Saugrohre	B32
Arterienklemmen	G07
Hohlmeißelzangen	K54
Hauttrephinen	B24
HAYES Knochenhebel	K39
Darmklemmen	S07
HEANEY Wundhaken	D28
Uteruslöffel	T33
Hysterektomieklammen	G26
HEANEY-BALLENTINE Hysterektomieklammen	G26
HEANEY-KANTER Hysterektomieklammen	G27
HEANEY-REZEK Hysterektomieklammen	G27
HEANEY-SLIM Hysterektomieklammen	G26
HEATH Hämmer	K13
HEERMANN Hämmer	K13

Produkt Index Product Index

deutsch
german

Produktname Product	Seite Page
HEGAR Uterusdilatoren	T15, T16
HEGAR-BAUMGARTNER Nadelhalter	H05
HEGAR-VASCULAR Nadelhalter	H09
HEGEMANN / DIETRICH Gefäßscheren	C17
HEGENBARTH Wundklammerpinzetten	H41
HEISS Wundspreizer	D34
Arterienklemmen	G14
HENLEY Wundspreizer	D37
Mehrzweckklemmen	R26
HENNING Gipsspreizer	H42
HENRY Pinzetten	F15
HEPP-SCHUIDEL Nadelhalter	H31
HERRICK Nierenstielklemmen	S20
HESSBERG Unterbindungsnadeln	H32
HEY-GROVES Knochenhaltezangen	K47
HEYMANN Nasenscheren	C29
HEYWOOD-SMITH Haemorrhoidalzangen	S18
Uteruspolypenzangen	T24
HF-Handgriffe	U14
HIBBS Wundhaken	D28
Bauchdeckenhalter	D54
Osteotom	K06
Hämmer	K14
Hirnmesser	B09
HIRSCHMANN Proktoskope	S13
HOEN Elevatorien	K35
Hohlmeißel	K02 - K10
Hohlmeißelzangen	K52 - K61
HOHMANN Knochenheber	K39, K40
HOHMANN-ALDINGER Knochenheber	K41
HOKE Osteotome	K04
HOLINGER Laryngoskope	A13
Laryngoskop	A13
HOLZBACH Wundspreizer	D42
Hysterektomieklemmen	G28
HOPKINS Gipsmesser	H42
HÖSEL Wundhaken	D22
Nadelhalter	H16
HOUSE Saughandgriffe	B33
Saugrohre	B34
HUDSON Handbohrapparate	K66
HUFFMANN-GRAVE Scheidenspekula	T03
HUMBY Dermatome	B10
HUNT Mikropinzetten	F26
HUNTER Splitterpinzetten	F16
HYLIN Raspatorien	K26
Hysterektomieklemmen	G25 - G32
Iliaca-Klemmen	R36
Indikatoretiketten	W29
Instrumentenablageplatten	W33

Produktname Product	Seite Page
Instrumenten-Kassetten	W04 - W06, W10
Instrumentenschalen	W33
Inzisionsscheren	C04
IOWA Uteruspolypenzangen	T24
Nadelführung	T40
Irrigatoren	W31
ISRAEL Wundhaken	D15
ITERSON Feine Wund-, und Hauthäkchen	D04
IUD-Extraktionshaken	T20
IUD-Zange	T20
IVES-FANSLER Analspreizer	S12
JACKSON Laryngoskope	A13
Laryngoskop	A13
Feine Wund-, und Hauthäkchen	D04
Wundhaken	D07
Scheidenspekula	T07
JACOBS Hakenzangen	T22
JACOBSEN Mikropinzetten	F23
Arterienklemmen	G07
Nadelhalter	H21, H23, H28
Scharfe Löffel	K24
JACOBSEN-ADSON Anat.Pinzetten	F03
JACOBSEN-ADSON Arterienklemmen	G12
JACOBSON Bulldogklemmen	G40
JACOBY Unterbindungsnadeln	H32
JAMESON Messinstrumente	A04
Feine Scheren	C21
Nadelhalter	H09
JAMESON-WERBER Feine Scheren	C21
JANSEN Wundspreizer	D34
Nasenpinzetten	F18
Scharfe Löffel	K24
Raspatorien	K28 - K31
Hohlmeißelzangen	K54, K55
Stirnspiegel, Stirnlampen	A07
JARCHO Hakenzangen	T21
JAVID Carotis-Shuntklemmen	R34
JOBSON-HORNE Watteträger	B15
JOHN-HOPKINS Bulldogklemmen	G40
JOHNS-HOPKINS Arterienklemmen	G19
JONES Tuchklemmen	G32
JORGENSEN Gynäkologische Scheren	C12
JOSEPH Feine Scheren	C21
JUDD-ALLIS Darmfasszangen	S02
JUDD-MASSON Blasenwundspreizer	S25
Kabelschneidzange	K76
KADER Wundhaken	D26
KAHN-GRAVE Scheidenspekula	T03
KALLMORGEN Scheidenspekula	T09
KALT Nadelhalter	H31

Produkt Index Product Index

deutsch
german

Produktname Product	Seite Page
Kaltlichtlaryngoskope	A12 - A13
KANTROWITZ Arterienklemmen	G20
Kanülen	B30
Kapselfasszangen	S24
Karabinerhaken	W29
Kassetten für Instrumente	W04 - W06, W10
Katheter-Einführungsinstrumente	S28
Katheter-Einführungszangen	G34
KATZIN Mikroscheren	C38
KAYE Feine Scheren (Ribbon type)	C25
Scheren für plastische Chirurgie	C26
KELLY Feine Scheren	C21
Wundhaken	D21, D24
Arterienklemmen	G04, G14
Proktoskope	S13, S14
Uteruspolypenzangen	T24
KELLY-ATRAUMA Arterienklemmen	G04
KELLY-RANKIN Arterienklemmen	G04
Kennzeichnungsschilder	W29
Kephalotom-Scheren	C12
KERN (LANE) Knochenhalte-zangen	K47
KEVORKIAN Biopsieküretten	T27
Biopsiezangen	T30, T32
KEVORKIAN-PACIFIC Biopsiezangen	T31
KEY Elevatorien	K36
KEYES Hauttrephinen	B24
KIELLAND Geburtszangen	T44
KIELLAND-LUIKART Geburtszangen	T44
KILLIAN Saugrohre	B32
KILNER Feine Wund-, und Hauthäkchen	D04, D06
Nadelhalter	H04
KILNER (RAGNELL) Feine Scheren	C24
KIRK Hämmer	K14
KIRSCHNER Bauchdeckenhalter	D50
Führungshohlsonden	H38
Extensionsbügel	K69
KLAPP Wundhaken	D11
KLEINERT-KUTZ Sehnenfasszangen	B20
Feine Wund-, und Hauthäkchen	D03
Hohlmeißelzangen	K56
Knochensplitterzangen	K63
KLIMA-ROSEGGGER Kanülen	B30
KLINGENBERG-LOTH Gynäkologische Scheren	C12
Klingenhalter	B07
KLINIKUM Berlin Schlauchklemmen	G39
KNAPP Feine Scheren	C22
Feine Wund-, und Hauthäkchen	D03
KNAPP (BABY-LEXER) Feine Scheren	C20
Knochenbohrer, Ahlen	K68
Knochenfeilen und -raspeln	K25

Produktname Product	Seite Page
Knochenhalte-zangen	K43 - K50
Knochenhebel	K38 - K42
Knochenmeißelzangen	A05
Knochenscheren	C36
Knochensplitterzangen	K62 - K64
KNOWLES Verbandscheren	C34
KOCHER Wundhaken	D13, D19, D22, D23
Arterienklemmen	G03
Unterbindungsnadeln	H35
Darmklemmen	S07
KOCHER-LANGENBECK Wundhaken	D19
KOCHER-WAGNER Wundhaken	D19
KOGAN Endo-Spekula	T18
Komedonenquetscher	B24
KÖNIG Wundhaken	D09
Führungshohlsonden	H37
Raspatorien	K26
Elevatorien	K34
KONRICH Verbandstofftrommeln	W07
Kopfschneider	K78
Korn- und Tupferzangen	G35 - G38
KÖRTE Wundhaken	D15, D24
KÖRTE-WAGNER Wundhaken	D15
Krampfaderbesteck	B16
Kranioklast	T45
KRAUSE Trokare	B26
KRISTELLER Scheidenspekula	T07, T08
KRONECKER Unterbindungsnadeln	H32
KRÖNLEIN Arterienklemmen	G08
KUEHNE Pinzetten	F15
KÜMMEL Wundhaken	D24
Kunststoffbehälter	W35
Laborschalen	W32
LAGRANGE Feine Scheren	C22
LAHEY Feine Wund-, und Hauthäkchen	D02
Wundhaken	D18
Arterienklemmen	G22
LAMBERT-KAY Aortaklemmen	R15
LAMBOTTE Osteotome	K04
Raspatorien	K29
Knochenhalte-zangen	K50
LANDAU Trokare	B26
Scheidenspekula	T13
LANDOLT Erukleationsscheren	C23
LANE Chirurgische Pinzetten	F13
Tuchklemmen	G34
Magenklemmen	S10
LANE-TRETHOWAN Knochenhebel	K38
LANGE-HOHMANN Knochenhebel	K41
LANGENBECK Messer	B08

Produkt Index Product Index

deutsch
german

Produktname Product	Seite Page
LANGENBECK Amputationssägen.....	B12
Wundhaken	D18
Nadelhalter.....	H15
Raspatorien.....	K28
Elevatorien	K35, K36
Knochenhaltezaugen	K46
LANGENBECK-GREEN Wundhaken.....	D07
LANGENBECK-RYDER Nadelhalter	H15
Lappenmesser	B08
LARRY Sonden	S17
LARSEN Sehnenfasspinzetten	B20
Laryngoskope.....	A10 - A13
LAWRENCE Arterienklemmen.....	G21
LAZAR Mikropinzetten.....	F19
LEBSCHKE Sternummeißel	R11
LEES Bronchusklemmen	R20
LEGUEU Blasenwundspreizer.....	S25
LEKSELL Hohlmeißelzaugen	K59
LELAND-JONES Mehrzweckklemmen	R25
LEMMON Rippenkontraktoren	R09
LEMPERT Hohlmeißelzaugen	K53
Scharfe Löffel	K21
LERCHE Chirurgische Pinzetten	F13
LERICHE Spatel	D31
Arterienklemmen	G05
LEWIN Knochenhaltezaugen	K44
LEXER Chirurgische Scheren	C04
Osteotome	K04, K08
Hohlmeißel	K07, K08
LEXER-FINO Chirurgische Scheren	C04
LICHTENBERG Nadelhalter.....	H16
LICHTWITZ Trokare	B26
Ligator-Gummiringe	S18
Ligaturklemmen	R29
Ligaturschere.....	C31, C32
LINEMANN Drahtzaugen	K73
LISTER Verbandschere.....	C34
Arterienklemmen.....	G09
LISTER-EXCENTRIC Verbandschere	C34
LISTON Amputationsmesser	B08
Knochensplitterzaugen	K62
LISTON-KEY Knochensplitterzaugen	K64
LITTAUER Knochensplitterzaugen.....	K62
Ligaturschere.....	C31
LITTLE Wundhaken	D10
LITTLER Ligaturschere.....	C32
LITTLEWOOD Darmfasszaugen	S03
LLOYD-DAVIS Rektum-Anastomosenklemmen	S08
LOCKE Knochenhaltezaugen	K44
LOCKHART-MUMMARY Sonden.....	B14

Produktname Product	Seite Page
LOCKLIN Zahnfleischschere	C31
LOCKWOOD Darmfasszaugen.....	S03
LOCKWOOD-ALLIS Darmfasszaugen.....	S03
LONG Hysterektomieklemmen	G27
LORENZ Verbandschere	C35
LORNA Tuchklemmen.....	G33
LOUTE Drahtinstrumente	K75
LOVE (MORSE) Wundhaken.....	D10
LOVELACE Arterienklemmen.....	G23
LOWER Arterienklemmen	G21
LOWMAN Knochenhaltezaugen.....	K50
LOWMAN-HOGLUND Knochenhaltezaugen.....	K50
LUCAE Ohrpinzetten.....	F18
Hämmer.....	K13
LUCAS Flachmeißel	K02
LUER Wundhaken.....	D08
Hohlmeißelzaugen	K52, K54
LUER-KÖRTE Gallensteinlöffel.....	S23
LUKENS Wundhaken.....	D07
Lungenlappenschere	C15
Lungenspatel	R11
Lupusküretten	B25
Lupusschaber	B24
Magenklemmen	S09, S10
MAGILL Katheter-Einführungszangen	G34
MANNERFELDT Wundhaken	D07
MARCHAC / THORPE Messinstrumente	A04
MARKHAM-MEYERDING Wundspreizer	D44
MARQUARDT Hohlmeißelzaugen	K57
MARSCHIK Pinzetten	F14
MARTIN Wundhaken.....	D23
Knochenhaltezaugen	K45
Uterussonden	T19
Beckenzirkel	T40
MARTIN-CARTILAGE Chirurgische Schere.....	C06
MARTINI Scharfe Löffel	K24
MASS. GEN. HOSP. Elevatorien	K34
MASSON Nadelhalter	H12
Mastdarm-Biopsiezaugen	S16
Mastdarmspekula	S11
MATHIEU Feine Wundhaken	D06
Wundhaken	D17
Nadelhalter	H13 - H15
Mastdarmspekula.....	S11
Fremdkörperzange	S29
Scheidenspekula.....	T11
MATHIEU-KOCHER Nadelhalter	H15
MATHIEU-METZENBAUM Nadelhalter	H14
MATHIEU-RYDER Nadelhalter.....	H14
MATSON Raspatorien	K31

Produkt Index Product Index

deutsch
german

Produktname Product	Seite Page
MATZENAUER Scheidenspekula	T10
MAYFIELD Hohlmeißelzangen	K57
MAYO Chirurgische Scheren	C05
Pinzetten	F14
Sterilisierklammern	W02
MAYO-ADAMS Wundspreizer	D43
MAYO-BLAKE Gallensteinzangen	S22
MAYO-COLLIN Wundhaken	D17
MAYO-GUYON Nierenstielklammern	S20
MAYO-HEGAR Nadelhalter	H6, H7
MAYO-HEGAR-SEELEY Nadelhalter	H05
MAYO-NOBLE Chirurgische Scheren	C06
MAYO-ROBSEN Darmklammern	S05
MAYO-STILLE Chirurgische Scheren	C05
MCCREA Dilatationsbougies	S26
MCDONALD Elevatorien	K36
MCGIVNEY Haemorrhoidal-Ligatoren	S18, S19
MCGLAMRY Elevatorien	K37
MCINDOE Präparierscheren	C07
Anat.Pinzetten	F04
Chirurgische Pinzetten	F10
Knochensplitterzangen	K63
MCINTOSH Laryngoskope	A11
Kaltlichtlaryngoskope	A12
MCKENTY Raspatorien	K26
MCLEAN Geburtszangen	T44
MCQUIGG-MIXTER Arterienklammern	G19
MEAD Hämmer	K12
Hohlmeißelzangen	K53
Medizinbecher	W31
MEEKER Arterienklammern	G21
Mehrzweckklammern	R25 - R38
Meißel	K02 - K10
MENGHINI Kanülen	B30
MERCEDES Rippensperrer	R06
Meßbecher	W31
Messinstrumente	A03, A04
Metallkatheter	S28
METZENBAUM Präparierscheren	C08, C09
METZENBAUM-FINO Präparierscheren	C10
MEYERDING Wundhaken	D08, D30
Wundspreizer	D44
Bauchdeckenhalter	D54
MICHEL Wundklammerzangen	H40
Wundklammern	H40
Wundklammerpinzetten	H41
MICRO (TURNER) Chirurgische Pinzetten	F11
MICRO-ADSON Anat.Pinzetten	F03
Chirurgische Pinzetten	F09
MICRO-ADSON-BEAMER Chirurgische Pinzetten	F10

Produktname Product	Seite Page
MICRO-MOSQUITO Arterienklammern	G07
MICRO-RYDER Nadelhalter	H10
MICRO-SEMKEN Chirurgische Pinzetten	F10
MICRO-VASCULAR Nadelhalter	H09
MIDDELDORPF Wundhaken	D20
MIKRO (TURNER) Anat.Pinzetten	F04
Mikropinzetten	F19 - F26
Mikroscheren	C37 - C49
MIKULICZ Wundhaken	D24
Hysterektomieklammern	G31
MILAN Uterusküreten	T34
MILLER Laryngoskope	A11
Laryngoskop	A13
Feine Wund- und Hauthäkchen	D03
MILLIGAN Wundspreizer	D36
MILLIN Kapselzangen	S24
Blasenwundspreizer	S25
MILLS Feine Scheren	C28
MINI-GEMINI Arterienklammern	G18
MINI-GILLIES Nadelhalter	H17
MINI-HOHMANN Knochenhebel	K39
MINI-LAMBOTTE Osteotome	K03
MINI-LANGENBECK Wundhaken	D08
MINI-LEXER Osteotom	K04
MINI-ROUX Wundhaken	D16
MINI-TOWNSEND Biopsiezangen	T31
MISKIMOM Wundspreizer	D40
MIXTER Chirurgische Scheren	C03
Arterienklammern	G19, G22
MIXTER O'SHAUGNESSY Arterienklammern	G20
MIXTER-SLIM Arterienklammern	G19
MOD. BONN Feine Scheren	C22
MOD. LONDON Biopsieküretten	T28
MOD. MÜNCHEN Biopsieküretten	T28
MOD. TÜBINGEN Wundhaken	D23
Wundspreizer	D37
MOD. USA Nabelschnurscheren	C14
Anat.Pinzetten	F03
Chirurgische Pinzetten	F09
Flachmeißel	K03
MOD. WIEN Fadenfänger	H40
MOD. USA Hämmer	K15, K16
MOLLISON Wundspreizer	D37
MOLT Raspatorien	K28
MÖLTGEN Winkelmesser	A03
Monopolare Kabel	U16
Monopolare Pinzetten	U10
MOORE Löffel	S23
MORGAN Proktoskope	S13
MORRIS Wundhaken	D20

Produkt Index Product Index

deutsch
german

Produktname Product	Seite Page
MORRIS-DEBAKEY Aorta-Aneurysma-Klemmen	R16
MORSE Rippensperrer	R04, R07
MOSQUITO-DANDY Arterienklemmen	G11
MOYNIHAN Hysterektomieklemmen	G28
MÜLLER Gefäßclips	G48
MURPHY-LANE Elevatorien	K37
MUSEUX Hakenzangen	T23
MYERS Venenstripper	B16
Myomheber	T26
Myrtenblattsonde	B13
NABATOFF Krampfaderbesteck	B16
Nabelschnurklemme	T42
Nabelschnurklemmen	T42
Nabelschnurscheren	C14
Nadeldosen	W34
Nadelhalter	H03 - H31
Nagelausreißzange	B22
NÄGELE Perforatorien	T42
Geburtszangen	T43
Nagelfeilen	B23
Nagelscheren	C33
Nagelspaltschere	C33
Nagelspaltzange	B22
Nagelzangen	B23
Nahtinstrumente	H37 - H40
Nasenpinzetten	F18
Nasenscheren	C29, C30
NEFF Messer	B11
NEGUS Arterienklemmen	G13
NEIVERT Nadelhalter	H03
NELATON Sonden	B13
NELSON Trokare	B25
Pinzetten	F14
Neonatal- und Pädiatrie-Klemmen	R42
Neonatal-Sperrer Titan	R02
Nerv-Präparierschere	C21
Neutralelektroden	U18 - U29
NEW ORLEANS Nadelhalter	H07
Nierenschalen	W31
Nierenstielklemmen	S20, S21
NISSEN Arterienklemmen	G12
NORFOLK-NORWICH Wundspreizer	D39
NORTHBENT / SHORTHBENT Ligaturscheren	C31
NORTHFIELD Hohlmeißelzangen	K54
NORWOOD Rektalschnürer	S17
NOTO Uteruspolypenzangen	T24
NOVAK Biopsieküretten	T27
NOYES Mikroscheren	C39
NUBOER Saugrohre	B28
Nystagmusbrillen	A14

Produktname Product	Seite Page
OCHSNER Trokare	B26
Anat.Pinzetten	F03
Aortaklemmen	R14
OCHSNER-KOCHER Arterienklemmen	G03
O'CONNOR Feine Wund-, und Hauthäkchen	D02
OLIVECRONA Messer	B11
Hohlmeißelzangen	K55
OLLIER Wundhaken	D14
OLSEN-HEGAR Nadelhalter	H17
Bipolare Scheren	U13
OMBREDANNE Hämmer	K16
Operations-Laryngoskope	A09
Organmesser	B09
Oscillierende Gippsägen	H43, H44
Osteotome	K02 - K10
O-SULLIVAN-O'CONNOR Bauchdeckenhalter	D49
Scheidenspekula	T14
OTIS Dilatationsbougies	S26
Urethrotom	S30
OVAL Biopsiezangen	T32
OVERHOLT-GEISSENDÖRFER Arterienklemmen	G17
OVERHOLT-MIXTER Arterienklemmen	G18
OVERHOLT-S Arterienklemmen	G17
OVERHOLT-SLIM-S Arterienklemmen	G17
Papierfilter	W28
PAR Scheren für plastische Chirurgie	C26
Nadelhalter	H03
Parametriumscheren	C13
PARK Analspreizer	S12
PARKER Wundhaken	D16
PARKER-LANGENBECK Wundhaken	D17
PARKER-MOTT Wundhaken	D17
PARSONNET Wundspreizer	D34
PARTSCH Flachmeißel	K02
Hohlmeißel	K02
Hämmer	K13
Raspatorien	K27
PASSOW Stößel	K11
PATTERSON Biopsiezangen	T30
PAYR Führungshohlsonden	H37
Darm- und Magenquetschklemmen	S10
PEAN Arterienklemmen	G02
Arterienklemmen	G10
PEDERSON Scheidenspekula	T04
PEDERSON-LASER Scheidenspekula	T04
PEERS-BERTRAM Tuchklemmen	G33
PEET Splitterzangen	F16
PELKMANN Tupferzangen	G37
PELTONEN Watteträger	B15
Penisklemmen	S30

Produkt Index Product Index

deutsch
german

Produktname Product	Seite Page
PENNINGTON Arterienklemmen	G08
PENNYBACKER Hohlmeißelzangen	K55
PERCY Amputations-Retraktoren	K51
Perforatorien	T42
Peripheal-Gefäßklemmen	R27
PERKINS Wundspreizer	D34
Perkussionshämmer	A02
PERTHES Reibahle	K68
PETZ Magen- und Darm Nähapparat Petz kplt.....	S10
Pflasterspatel	B14
Phalangenmesser	B08
PHANEUF Hysterektomieklammen	G28
PIERCE Trokare	B26
PIFFARD Lupusküretten	B24
PINARD Stethoskope	A03
PIPER Geburtszangen	T44
PLASTIC Feine Scheren	C19
PLESTER Saugrohre	B36
Wundspreizer	D35
POLLOSON Wundhaken	D27
POOLE Saugrohre	B29
POTTS (GLOVER) Coarctationsklemmen	R21, R22
POTTS-DE-MARTEL Feine Scheren	C28
POTTS-SMITH Präparierscheren	C07
Gefäßscheren	C16, C17
Anat.Pinzetten	F06
Chirurgische Pinzetten	F12
POZZI Hakenzangen	T22
Präparier- und Ligaturklemmen	R28
Präparierscheren	C07 - C12
PRATT Fistelsonden	B14
Arterienklemmen	G09
Mastdarmspekula	S11
Sonden	S17
Uterusdilatoren	T17
Hakenzangen	T24
PRESBYTERIAN Schlauchklemmen	G39
PRICE-THOMAS Arterienklemmen	G23
PRINCE Tonsillenscheren	C29
Profunda-Klemmen	R27
Proktoskope	S13, S14
Prostatahaken	S24
PROVIDENCE Arterienklemmen	G05
QUERVAIN Elevatorien	K35
QUINBY Zahnfleischscheren	C30
QUINKE Kanülen	B30
RADOLF Nagelausreißzange	B22
RAGNELL Feine Scheren (Ribbon type)	C25
RAGNELL (KILNER) Feine Scheren	C24
RAGNELL-DAVIS Feine Wundhaken	D06

Produktname Product	Seite Page
RALK Splitterzangen	F16
Handbohrapparate	K65
RAMPLEY Schwammzangen	G35
RANDALL Nierenstielklemmen	S21
Biopsieküretten	T27
Rasierklingen	B07
Raspatorien	K26 - K33
RECAMIER Uterusküretten	T36
REDON Führungsnadeln Redon	B25
Reibahlen	K68
REIL Knochenhalte-zangen	K44
REILL Nadelhalter	H28
Reinigungspistole	W03
Rektalinstrumente	S17
Rektoskope	S15
Rektum-Anastomosenklemmen	S08
RESANO Chirurgische Scheren	C06
Pinzetten	F14
Rektum-Anastomosenklemmen	S08
REVERDIN Spatel	D31
Unterbindungsnadeln	H36
REYNOLDS Feine Scheren	C21
RHOTON-TITAN Mikropinzetten	F21
RIBBON TYPE Feine Scheren (Ribbon type)	C25
RICARD Wundspreizer	D42
RICHARDSON Wundhaken	D21
RICHARDSON-EASTMAN Wundhaken	D21
RICHTER Chirurgische Scheren	C04
RICHTER-HEATH Wundklammerzangen	H40
RIENHOFF-FINOCHIETTO Rippensperrerr	R02
RIGBY Wundspreizer	D44
Ring-Sperrerr-System	D55 - D59
Rippenkontraktoren	R09
Rippenscheren	R09, R10
Rippensperrerr	R02 - R08
RITTER-HALLE Dilatoren	B18
ROBERTS Arterienklemmen	G14
ROCHARD Bauchdeckenhalter	D51
ROCHESTER-CARMALT Arterienklemmen	G10
RÖDER Tuchklemmen	G33
ROGGE Sterilisierzangen	W02
ROSE Wundhaken	D09
ROSEN Saugkanülen	B33
ROSS Wundhaken	D28
RÖTTGEN-RUSKIN Hohlmeißelzangen	K58
ROUX Wundhaken	D16
ROUX-MAGNUS Wundhaken	D16
RUBIO Drahtzangen	K70
RUDD Haemorrhoidal-Ligatoren	S19
RUMEL Arterienklemmen	G15

Produkt Index Product Index

deutsch
german

Produktname Product	Seite Page
RUMEL-BELMONT	R11
RUSKIN Hohlmeißelzangen	K57
RUSKIN-LISTON Knochensplitterzangen	K63
RUSKIN-ROWLAND Knochensplitterzangen	K63
RUSS. MODELL Pinzetten	F14
RYDER Nadelhalter	H10, H28
SAALFELD Komedonenquetscher	B24
SALENIUS Messer	B11
Salpinograph	T38
SÄNGER Abortuszangen	T41
SANTULLI Bulldogklemmen	G42
SANVENERO Feine Scheren	C20
SAROT Arterienklemmen	G14
Nadelhalter	H11
SATINSKY Gynäkologische Scheren	C12
Arterienklemmen	G24
SATINSKY-DEBAKEY Tangentialklemmen	R31
SATTERLEE Amputationssägen	B12
SAUERBRUCH Wundhaken	D19, D25
Hohlmeißelzangen	K60
Rippenscheren	R09
Sterilisierzangen	W02
Saughandgriffe	B33
Saugkanülen	B33
Saugrohre	B28 - B30
SCHACKE Uterusmanipulator	T20
SCHÄDEL Tuchklemmen	G32
Schalen	W32
SCHAMBERG Komedonenquetscher	B24
Scharfe Löffel	K18 - K24
SCHUDE Scharfe Löffel	K18
Scheidenspekula	T02
Scheidenspekula	T02 - T14
SCHERBAK Scheidenspekula	T13
Scheren für plastische Chirurgie	C26, C27
SCHIMMELBUSCH Verbandstofftrommeln	W07
SCHINDLER Hysterektomieklammern	G32
SCHINK Dermatome	B10
Schlauchklemmen	G39
SCHMID Spülkanülen	B17
Gefäß-Spatel	B17
SCHMIEDEN Unterbindungsnadeln	H35
Führungshohlsonden	H37
SCHMIEDEN-PAYR Führungshohlsonden	H37
SCHMIEDEN-TAYLOR Feine Scheren	C28
SCHNEIDER Raspatorien	K28
SCHNEIDER-SAUERBRUCH Raspatorien	K29
SCHNIDT-SAWTELL Arterienklemmen	G20
SCHOEMAKER-LOTH Ligaturscheren	C32
SCHRÖDER Hakenzangen	T21, T23

Produktname Product	Seite Page
SCHRÖDER Uteruslöffel	T33
SCHUBERT Biopsiezangen	T28, T29
SCHUKNECHT Saugrohre	B34
Wundspreizer	D37
Schulterahle	K68
Schultermeißel	K07
SCHULTZE Salpinograph	T38
SCHUMACHER Nabelschnurscheren	C14
Knochenhebel	K42
Biopsiezangen	T29, T30, T32
Schwammzangen	G35
SCHWARTZ Bulldogklemmen	G44
SCHWEDISCHES MODELL Scharfe Löffel	K20
SCOVILLE Bauchdeckenhalter	D43, D54
Scharfe Löffel	K20
SCOVILLE-HAVERFIELD Bauchdeckenhalter	D53
SCOVILLE-RICHTER Bauchdeckenhalter	D53
SCUDDER Magenklammern	S09
SEBILEAU Elevatorien	K34
SEDILLOT Raspatorien	K28
SEGOND Hysterektomieklammern	G32
SEGOND-LANDAU Hysterektomieklammern	G32
Sehnensasspinzetten	B20
Sehnensasszangen	B20
Sehnensführer	B19
Sehnensschäler	B19
Sehnenscheren	C23
SEIDL Scheidenspekula	T07
SEIFFERT Sonden	B13
SELDIN Raspatorien	K29
Elevatorien	K36
SELLHEIM Geburtslöffel	T42
SELLORS Rippenkontraktoren	R09
SELMAN Pinzetten	F14
SEMB Arterienklammern	G22
Raspatorien	K31
Knochenhalteklammern	K46
Hohlmeißelzangen	K59
Knochensplitterzangen	K64
SEMKEN Anat.Pinzetten	F04
Chirurgische Pinzetten	F10
SEMM Bauchdeckenhalter	D49
Scheidenspekula	T05
SENN-GREEN Wundhaken	D08
SENNING Nadelhalter	H11
SENN-MILLER Feine Wundhaken	D06
Sensibilitätsinstrumente	A02
SEUTIN Verbandscheren	C36
SEXTON Wundspreizer	D40
SEYFFERT Scheidenspekula	T05

Produkt Index Product Index

Produktname Product	Seite Page
SHAAF Pinzetten	F15
SHORTBENT / NORTHBENT Ligaturscheren	C31
SIEBOLD Gynäkologische Scheren	C12
Siebschalen	W10 - W30
Silikonmatten	W15, W19, W23, W27
SILVER Dermatome	B10
SIMON Skalpelle	B06
Wundhaken	D23
Fistelhaken	T26
Uteruslöffel	T33
Scharfe Löffel	K21
SIMPSON Uterussonden	T19
Geburtszangen	T43
SIMPSON-BRAUN Geburtszangen	T43
SIMPSON-LUIKART Geburtszangen	T44
SIMS Gynäkologische Scheren	C11
Mastdarmspekula	S11
Mastdarmspekula	S11
Scheidenspekula	T06
Uterussonden	T19
Uterus-Depressoren	T20
Uterusküreten	T35
SIMS (US-MODELL) Scheidenspekula	T06
SIMS-KELLY Scheidenspekula	T06
SIMS-MAIER Tupferzangen	G37
SINGLEY-TUTTLE Pinzetten	F14
Skalpelle	B06
Skalpellgriffe	B02, B03, B05
Skalpellklingen	B04, B05
SKENE Hakenzangen	T22
SMELLIE Perforatorien	T42
Messer	B11
Wundhaken	D26
SMITH Schere	C33
Scheidenspekula	T14
SMITH (USA) Verbandscheren	C35
SMITH-BUIE Analspreizer	S12
SMITH-PETERSEN Osteotome	K05
Hohlmeißelzangen	K58
SOMER Uterusfasszangen	T25
Sonden	B13 - B14
Spatel	D31
SPENCER Ligaturscheren	C31
SPENCER-FINO Ligaturscheren	C31
SPENCER-WELLS Arterienklemmen	G11
Splitterpinzetten	F16
Splitterzangen	F16
SPRATT Scharfe Löffel	K19
Spritzen	B41
Sputumbecher	W32

deutsch german

Produktname Product	Seite Page
ST. MARKS Wundhaken	D25
STACKE Sonden	B13
STAGBEETLE Knochenhalte-zangen	K43
Standzylinder	W32
STAUDE-MOORE Hakenzangen	T21
Stechbecken	W31
STEINER-AUVARD Scheidenspekula	T12
STEINMANN Sehnenfasszangen	B20
STELLBRINK Hohlmeißelzangen	K53
Sterilisierklammern	W02
Sterilisierzangen	W02
Sternummeißel	R11
Stethoskope	A03
Stethoskope, Div. Messinstrumente	A03
STEVENS Sehnenscheren	C23
Feine Scheren (Ribbon type)	C25
STEWART Sonden	S17
STIEGLITZ Splitterzangen	F16
STILLE Gipsscheren	C36
Flachmeißel	K06
Hohlmeißelzangen	K60
Handbohrapparate	K66
Nierenstielklemmen	S20
STILLE-BARRAYA Chirurgische Pinzetten	F13
STILLE-LISTON Knochensplitterzangen	K64
STILLE-LUER Hohlmeißelzangen	K58
STILLE-LUER-ECHLIN Hohlmeißelzangen	K60
Stirnspiegel, Stirnlampen	A06 - A08
STITCH SCISSORS Feine Scheren (Ribbon type)	C25
STOCKMANN Penisklemmen	S30
STONE Chirurgische Pinzetten	F13
Stößel	K11
Strabismusscheren	C25
STRANDELL-STILLE Wundhaken	D08
STRATTE Nadelhalter	H11
STRAUSS Penisklemmen	S30
STRUCK Rippensperrer	R04
STRULLY Feine Scheren	C28
SUBRAMANIAN-MINIATURE Peripheal-Gefäßklemmen	R27
SULLIVAN (BROPHY) Feine Scheren	C20
SWEET Amputations-Retraktoren	K51
SYPERT Stößel	K11
Hohlmeißelzangen	K61
Tangentialeklemmen	R31, R37
TARNIER Geburtszangen	T44, T45
TAYLOR Perkussionshämmer	A02
Wundhaken	D26
Bauchdeckenhalter	D54
Anat. Pinzetten	F05
Chirurgische Pinzetten	F11

Produkt Index Product Index

deutsch
german

Produktname Product	Seite Page
TAYLOR Knochenhebel	K42
TEALE Hakenzangen	T23
TERRIER Arterienklemmen	G07
Textilfilter	W28
THOMAS Uterusküreten	T35
THOMS-ALLIS Darmfasszangen	S02
THOMS-GAYLOR Biopsiezangen	T28
TISCHLER Biopsiezangen	T29, T31, T32
TOHOKU Tuchklemmen	G33
TÖNNIS Messer	B11
Präparierscheren	C07
Arterienklemmen	G21
Nadelhalter	H16
TÖNNIS-ADSON Präparierscheren	C07
TÖNNIS-FINE Präparierscheren	C07
Tonsillenanülen	B31
Tonsillenscheren	C28, C29
Torniquets	R11
TOWNLEY Messinstrumente	A04
TOWNSEND Biopsieküretten	T27
Biopsiezangen	T32
TRAVERS Wundspreizer	D37
TRELAT Scheidenspekula	T04
TREVES Chirurgische Pinzetten	F13
TROEMNER Perkussionshämmer	A02
Trokare	B25 - B27
TRÖLTSCHE (WILDE) Ohrpinzetten	F18
TROUTMAN Klingenthaler	B07
Tücher	W30
Tuchklemmen	G32 - G34
TUFFIER Wundhaken	D22
Spatel	D31
Arterienklemmen	G08
Rippensperrerr	R02
Tupferzangen	G35 - G38
UFFENORDE Scharfe Löffel	K20
Uhrmacherpinzetten	F17
ULRICH Tupferzangen	G37
Knochenhalte-zangen	K47
Scheidenspekula	T10
UNIVERSAL Drahtscheren	C32
UNNA Komedonenquetscher	B24
Unterbindungsnadeln	H32 - H36
Urethrotom	S30
US-MODELL Wundhaken	D12
Uterus-Depressoren	T20
Uterusdilatatoren	T15 - T18
Uterusfasszangen	T25
Uterusküretten	T34 - T37
Uteruslöffel	T33

Produktname Product	Seite Page
Uterusmanipulatoren	T20, T39
Uteruspolypenzangen	T24
Uterussekretilöffel	T28
Uterussonden	T19
VALLEIX Uterussonden	T19
VAN ALYEA Tonsillenanülen	B31
VAN BUREN Dilatationsbougies	S26
VAN DOREN Biopsiezangen	T29
VANBUREN Knochenhalte-zangen	K46
VANNAS Mikroscheren	C37
VANNAS-TÜBINGEN Mikroscheren	C37
VARADY Gefäßinstrumente	B16
Vasektomie-klemmen	S29
Venenstripper	B16
Verbandscheren	C34 - C36
Verbandstoffschalen	W33
Verbandstofftrommeln	W07
VERBRUGGE Knochenhalte-zangen	K49
VERBRUGGE-MÜLLER Knochenhebel	K40
Verschlussplomben	W29
VICKERS Drahtinstrumente	K75
VIDAL Lupusschaber	B24
VIRCHOW Messer	B09
WISE Feine Pinzetten	F17
VOGEN Knochenhalte-zangen	K43
VOLKMANN Wundhaken	D11, D12
VOLKMANN Scharfe Löffel	K18, K24
WACHENFELDT Wundklammerpinzetten	H41
WAGNER Feine Scheren	C19
WAGNER Hohlmeißel	K09
Raspatorien	K33
Knochenhebel	K41
WALDMANN Parametriumscheren	C13
WALLICH Abortuslöffel	T40
WALTER-CARMALT Splitterpinzetten	F16
WALTHER Dilatationsbougies	S27
WALTON Feine Scheren	C20
Feine Scheren (Ribbon type)	C25
Gipsspreizer	H42
WANGENSTEEN Anat. Pinzetten	F07
WANGENSTEEN Nadelhalter	H12
WARTENBERG Sensibilitätsinstrumente	A02
WASSMUND Wundhaken	D14
WATSON Dermatome	B10
WATSON-CHEYNE Raspatorien	K26
Elevatorien	K36
WATTESPENDER	W32
WAUGH Anat. Pinzetten	F05
Chirurgische Pinzetten	F11
Aortaklemmen	R13

Produkt Index Product Index

deutsch
german

Produktname Product	Seite Page
WEBSTER Nadelhalter	H04
WEITLANER Wundspreizer	D35, D36
WEITLANER-BABY Wundspreizer	D36
WEITLANER-WULLSTEIN Wundspreizer	D36
WELDON Bulldogklemmen	G40, G43
WERTHEIM Gynäkologische Scheren	C12
Hysterektomieklemmen	G28, G29
WERTHEIM-CULLEN Hysterektomieklemmen	G30
WEST Hohlmeißel	K03
WESTCOTT Mikroscheren	C38, C39
WICKSTRÖM Arterienklemmen	G20
WIENER MODELL Scheidenspekula	T09
WILLET-DEMARTEL Abortuszangen	T41
WILLIAM Wundspreizer	D44
WILLIAMS Darmfasszangen	S03
WILLIGER Hämmer	K14
Scharfe Löffel	K20, K24
Raspatorien	K26
Elevatorien	K34
WILMER Feine Scheren	C24
WINTER Abortuszangen	T41
WITTNER Biopsiezangen	T30
WOLF Lupusküretten	B24
WOLFF Gipsabreißzange	H42
WOODRUFF Unterbindungsnadeln	H32
WRIGLEY Geburtszangen	T43
WULLSTEIN Saugrohre	B34
Wundhaken	D05 - D30
Wundklammerbesteck	H41
Wundklammern	H40
Wundklammerzangen	H40
Wundspreizer	D34 - D45
WYLIE Aorta-Aneurysma-Klemmen	R18
YANKAUER Saugrohre	B28
Elevatorien	K34
YASARGIL Saugrohre	B37
Mikropinzetten	F22, F23, F26
Nadelhalter	H21, H22
YEOMAN Mastdarm-Biopsiezangen	S16
YOUNG Arterienklemmen	G09
Unterbindungsnadeln	H36
Prostatahaken	S24
Zahnfleischscheren	C30, C31
ZAUFAL-JANSEN Hohlmeißelzangen	K57
ZENKER Wundhaken	D26
Arterienklemmen	G16
ZIEGLER Stirnspiegel	A08
Pinzetten	F15
ZIELKE Hohlmeißel	K05
ZÖLLNER Saugrohre	B34

Produktname Product	Seite Page
ZWEIFEL Nadelhalter	H16

Produkt Index Product Index

englisch
english

Produktname Product	Seite Page
Abdominal Retractors	D45 - D54
ACLAND Vessel Clips	G46
ADLERKREUTZ Tissue Forceps	F13
ADSON Suction tubes	B36
Retractors	D38 - D40
Dressing Forceps	F03, F04
Tissue Forceps	F09, F10
Artery Forceps	G12
Needle Holders	H07
Raspatories	K27
Bone Rongeur Forceps	K55
Bipolar Forceps	U02
ADSON-BROWN Tissue Forceps	F10
ADSON-EWALD Dressing Forceps	F03
ADSON-EWALD Tissue Forceps	F09
ADSON-LIGHT Dressing Forceps	F04
Tissue Forceps	F10
ALDERDYCE Elevators	K36
ALEXANDER Chisels	K04
Raspatories	K29
Biopsy Forceps	T30
ALLEN Intestinal Tissue Forceps	S06
ALLIS Intestinal Tissue forceps	S02
ALLIS-ADAIR Intestinal Tissue forceps	S02
ALLISON Lung spatulas	R11
ALM Retractors	D34
ALY Sensibility Instruments	A02
Amnioscopy Instruments	T38
Amputation Knives	B08
Amputation Retractor	K51
Amputation Saws	B11
Anal Retractors	S12
Anastomosis Clamps	R12, R13, R29, R36, R38
ANDERSON-ADSON Retractors	D38
ANDREW-PYNCHON Suction tubes	B28
ANTHONY Suction tubes	B30
Aorta Clamps	R13 - R15
Aorta-Aneurysm Clamps	R16 - R18, R20, R28
Applying forceps	G40
ARRUGA Needle Holders	H13, H31
Artery Forceps	G02 - G24
ATRAUMA FORCEPS Atraumatic Forceps	R12 - R41
Atrauma Multi-Purpose Clamps	R25, R26, R30, R32, R35
Atraumatic forceps	F27 - F29
Auricle Clamps	R19
AUSTIN Micro forceps	F19
AUVARD Vaginal Specula	T12
AWLS	K68
BABCOCK Intestinal Tissue forceps	S03
BABINSKY Percussion hammers	A02

Produktname Product	Seite Page
BABY-ADSON Artery Forceps	G11
BABY-ALLIS Intestinal Tissue forceps	S02
BABY-BABCOCK Intestinal Tissue forceps	S03
BABY-BALFOUR Abdominal Retractors	D45
BABY-COLLIN Retractors	D41
BABY-CRILE Artery Forceps	G04
BABY-CRILE-WOOD Needle Holders	H04
BABY-KOCHER Intestinal Tissue Forceps	S06
BABY-LEXER (KNAPP) Fine Scissors	C20
BABY-METZENBAUM Dissecting Scissors	C11
BABY-MIKULICZ Hysterectomy Forceps	G31
BABY-MIXTER Artery Forceps	G19
BABY-OLSEN-HEGAR Needle Holders	H17
BABY-OVERHOLT Artery Forceps	G16
BABY-POOLE Suction tubes	B29
BABY-ROUX Retractors	D16
BABY-SATINSKY Artery Forceps	G24
BABY-SENN-MILLER Fine Retractors	D06
BABY-TISCHLER Biopsy Forceps	T31
BABY-WEBSTER Needle Holders	H04
BABY-YANKAUER Suction tubes	B28
BACKHAUS Towel Forceps	G32, G33
BACON Bone Rongeur Forceps	K55
BAGGISH Biopsy Forceps	T31
BAILEY RIB Contrators	R09
BAILEY-BABY Rib Contrators	R09
BAILEY-GIBBON Rib Contrators	R09
BAINBRIDGE Artery Forceps	G10
BAKES Bile duct dilators	S22
BALFOUR Abdominal Retractors	D46 - D49
BALL/SOCKET Towel Forceps	G33
BALLENGER (FÖRSTER) Sponge Holding Forceps	G35
Bandage Scissors	C34 - C36
BANE-HARTMANN Bone Rongeur Forceps	K54
BARNES Suction tubes	B35
BARNES-NEVILLE Obstetrical Forceps	T45
BARON Suction tubes	B34
BARR Rectal Specula	S11
Probes	S17
BARRAQUER Forceps	F15
Needle Holders	H25
BARRAQUER-TROUTMAN Needle Holders	H25
BARRETT Tenaculum Forceps	T21
BARRON Scalpel Handles	B02
BARSKY Fine Wound-, and Skin hooks	D03
Basiotribe	T45
Baskets	W10 - W30
BEACHAM Tenaculum Forceps	T22
BEAUPRE Forceps	F15
BECK Multi-Purpose Clamps	R26

Produkt Index Product Index

Produktname Product	Seite Page
BECK Atraumatic Forceps	R36
BECKMANN Retractors.....	D39
BECKMANN-ADSON Retractors.....	D39
BECKMANN-EATON Retractors.....	D40
Bedpan	W31
BEEBEE Gum Scissors	C30
BEER Forceps	F15
BEESON Plaster spreader.....	H42
BENGOLEA Artery Forceps	G15
BENNETT Bone Levers	K41
BENSAUDE Anal Retractors	S12
BERGER Biopsy Forceps.....	T30
BERGMANN Scalpels.....	B06
Bandage Scissors	C35
Fine Wound-, and Skin hooks.....	D04
Mallets	K15, K16
BERLINER Percussion hammers	A02
BERNHARD Towel Forceps	G34
BEST-SELECT Needle Holders	H08
BETHUNE Rib Shears.....	R09, R10
BEYER Bone Rongeur Forceps	K55, K57
BIEMER Vessel Clips	G47
BIEMER-MÜLLER Vessel Clips	G48
BIER Amputation Saws.....	B12
Needles	B30
Bile duct dilators	S22
BILL Obstetrical Forceps.....	T45
Biopsy Curettes	T27, T28
Biopsy Forceps.....	T28 - T32
Bipolar Cables.....	U15
Bipolar Forceps	U02 - U09
Bipolar Scissors	U11 - U13
BIRCHER Knives	B11
BIRCHER-GANSKE Bone Holding Forceps	K45
BIRKETT Artery Forceps.....	G13
Bladder Retractors	S25
BLAKE Gall Stone Forceps.....	S22
BLAKE / ZWEIFEL Uterine Curettes	T37
BLOUNT Retractors	D26
Elevators	K38
Bone Levers	K38, K42
BLUMENTHAL Bone Rongeur Forceps.....	K52
BÖHLER Bone Rongeur Forceps	K56
Bone Cutting Forceps	K63
Extension Bows	K69
Bone Calipers	A05
Bone Curettes.....	K18 - K24
Bone Cutting Forceps	K62 - K64
Bone Drills	K68
Bone Files and Rasps	K25

englisch english

Produktname Product	Seite Page
Bone Holding Forceps	K43 - K50
Bone Levers.....	K38 - K42
Bone Rongeur Forceps	K52 - K61
Bone Scissors	C36
Bone Wire Guides	K68
BONNEY Dressing Forceps	F07
BONNEY Tissue Forceps.....	F13
BOROWSKI Retractors	D28
BÖTTCHER Tonsil Scissors.....	C28
Bowls	W32
BOYNTON Needle Holders	H13
BOYNTON Bone Rongeur Forceps	K52
BOYS-ADAIR Intestinal Tissue forceps	S02
BOZEMANN Dressing Forceps.....	G36
Needle Holders	H07
BOZEMANN-DOUGLAS Dressing Forceps	G36
Brain Knives.....	B09
BRAND Tendon passing instrument	B19
Tendon Seizing Forceps	B20
BRAUN Vaginal Specula	T10
Uterine Depressors.....	T20
Tenaculum Forceps	T21, T22
Decapitating hook	T42
Obstetrical Forceps	T45
BRAUN-STADLER Episiotomy Scissors.....	C13
BREISKY Vaginal Specula.....	T13
BRIDGE Artery Forceps.....	G16
BRINKERHOFF Proctoscopes.....	S13
BRISTOW Bone Levers	K38
BRISTOW-BANKART Retractors	D27
BRODIE Probes	B13
Bronchus Forceps	R20, R21
BROPHY Dressing Forceps	F06
BROPHY Tissue Forceps	F12
BROPHY (SULLIVAN) Fine Scissors	C20
BROWN Forceps	F14
Needle Holders	H03
BRÜNINGS-BRUNK Retractors	D19
BRUNNER Retractors.....	D23
Ligature Needles.....	H35
Ligature Conductors	H37 - H39
Rib Shears	R10
Intestinal Tissue Forceps.....	S06
Bandage Scissors	C35
Bone Curettes	K18, K23
Brushes.....	W03
BRYANT Dressing Forceps.....	G38
BUCK Percussion hammers.....	A02
Cotton Applicators.....	B15
BUCK-GRAMCKO Bone Levers	K38

Produkt Index Product Index

englisch
english

Produktname Product	Seite Page
BUELAU Trocars	B27
BUIE Suction tube	S17
Bulldog Clamps	G40 - G44
BUMM Uterine Curettes	T37
BUNNEL Hand Drills	K65
Tendon passing instrument	B19
Tendon strippers	B19
BUNT Safety pins	W02
BURFORD Rib Spreader	R08
BURKE Biopsy Forceps	T31, T32
BUSCH Umbilical Scissors	C14
BUSHE Bone Curettes	K21
Cable Cutter	K76
CAMPBELL Dilating Bougies	S27
CANNY-RYALL Retractors	D20
Capsula forceps	S24
CARELL Artery Forceps	G07
CAROLL Measuring Instruments	A04
Tendon Seizing Forceps	B20
Carotid Shunt Clamps	R34
Cases for Instruments	W04 - W6, W09
CASPAR Measuring Instruments	A05
Retractors	D22
CASTANARES Scissors for plastic surgery	C27
CASTANEDA Rib Spreader	R08
Neonatal and Pediatric Clamps	R42
CASTROVIEJO Measuring Instruments	A05
Razor blade holder	B07
Micro Scissors	C38
Needle Holders	H18 - H20, H30
CASTROVIEJO-KALT Needle Holders	H31
Catheter Forceps	G34
Catheter introducing instruments	S28
CATLIN Amputation Knives	B08
Cephalotomy Scissors	C12
CHANDLER Elevators	K37
CHAPUT Artery Forceps	G08
CHARNLEY Abdominal Retractors	D52
CHARRIERE Amputation Saws	B12
CHEATLE Sterilizing forceps	W02
CHELSEA-EATON Proctoscopes	S14
CHERON Dressing Forceps	G38
Chest support	A09
CHILD Clip Forceps	H41
Chisels	K04 - K10
Circumcision instruments	S29
Cleaning Gun	W03
CLEVELAND Bone Rongeur Forceps	K52
Bone Cutting Forceps	K62
Clip Forceps	H40

Produktname Product	Seite Page
CLOWARD Mallets	K15
COAKLEY Trocars	B26
Coarctation Clamps	R21 - R24
COBB Osteotoms	K05
Gouges	K07
Bone Curettes	K22
Raspatories	K32
COBETT Dermatomes	B10
COBRA Bone Levers	K41
COHEN Uterus Manipulators	T39
COLLER-CRILE Artery Forceps	G05
COLLIER Needle Holders	H03
COLLIN Dynamometer	A03
Scalpel Handles	B02, B03
Bone Scissors	C36
Retractors	D17
Retractors	D41, D42
Artery Forceps	G09
Dressing Forceps	G38
Clip Forceps	H40
Mallets	K15
Vaginal Specula	T04
Uterine Forceps	T25
Pelvimeters	T40
Umbilical Cord Clamps	T42
COLLIN-DUVAL Forceps	F15
COLLIN-HARTMANN Retractors	D17
COLLYER Pelvimeters	T40
Columella forceps	F18
Comedo Extractors	B24
CONE Retractors	D38
Bone Curettes	K23
Container-System	W10 - W30
CONTOUR Retractors	D36
CONVERSE Needle Holders	H03
COOLEY Suction tubes	B29
Retractors	D29
Atraumatic forceps	F29
Bulldog Clamps	G41
Rib Spreader	R03, R07
Carotid Shunt Clamps	R34
Multi-Purpose Clamps	R35, R38
Iliac Clamps	R36
Tangential Clamps	R37
Fine Forceps	R38 - R41
COOLEY FIRST Rib Shears	R10
COOLEY-DERRA Anastomosis Clamps	R36, R38
COOLEY-GLOVER Bulldog Clamps	G44
COOPER Ligature Needles	H35
CORYLLOS Retractors	D25

Produkt Index Product Index

Produktname Product	Seite Page
CORYLLOS Rib Shears	R10
COTTLE Measuring Instruments	A04
Nasal Scissors	C30
Fine Wound-, and Skin hooks	D02
Nasal forceps	F18
Mallets	K14
Columella forceps	F18
COTTLE-KAZANIJAN Bone Cutting Forceps	K62
COTTLE-MASING Nasal Scissors	C29
Cotton dispensers	W32
CRAFOORD Lobectomy Scissors	C15
Artery Forceps	G14
CRAFOORD-SELLORS Artery Forceps	G16
Cranioclast	T45
CRECO Elevators	K37
CRILE Fine Wound-, and Skin hooks	D04
Retractors	D08
Artery Forceps	G04
Needle Holders	H13
CRILE-MURRAY Needle Holders	H05
CRILE-RANKIN Artery Forceps	G04
CRILE-WOOD Needle Holders	H05
CUSCO Vaginal Specula	T02
CUSHING Retractors	D09 - D11
Dressing Forceps	F06, F07
Tissue Forceps	F12
Raspatories	K28
Elevators	K35
CUSHING-KOCHER Retractors	D10
CUSHING-TAYLOR Dressing Forceps	F07
Cutaneous Trephines	B24
CZERNY Rectal Specula	S11
Gall Stone Forceps	S22
Tenaculum Forceps	T22
DAHMEN Osteotom	K09
DALE Bone Rongeur Forceps	K61
Peripheal Vascular Clamps	R27
DANDY Fine Scissors	C28
Artery Forceps	G11
DARDIK Multi-Purpose Clamps	R32
DARRACH Elevators	K37
DARTIGUES Uterine Forceps	T25
DAUBENSPECK Bone Curettes	K20
DAVIDSON Retractors	D28
DAVIDSON-ALEXANDER Raspatories	K31
DAVIS Fine Retractors	D06
Sterilizing forceps	W02
DEAN Gum Scissors	C31
DEAVER Operating Scissors	C03
DEAVER Retractors	D29, D30

englisch english

Produktname Product	Seite Page
DEBAKEY Vessel Dilators	B18
Suction tubes	B28
Dissecting Scissors	C07
Vascular Scissors	C15, C16
Retractors	D43
Micro forceps	F19, F28
Atraumatic forceps	F27
Bulldog Clamps	G41, G44
Needle Holders	H08
Rib Spreader	R05
Aorta-Aneurysm Clamps	R17, R18, R28
Coarctation Clamps	R23, R24
Multi-Purpose Clamps	R25 - R38
Dissecting and Ligature Clamps	R28
Anastomosis Clamps	R29
Ligature Clamps	R29
Aorta Clamps	R14
DEBAKEY (DENNIS) Atraumatic forceps	F29
DEBAKEY FINE Needle Holders	H08
DEBAKEY-BAHNSON Aorta-Aneurysm Clamps	R20
DEBAKEY-BAINBRIDGE Artery Forceps	G10
DEBAKEY-BECK Multi-Purpose Clamps	R26
DEBAKEY-CASTANEDA Fine Forceps	R33
DEBAKEY-DIETHRICH Atraumatic forceps	F27
DEBAKEY-DIETRICH Bulldog Clamps	G41
DEBAKEY-HESS Bulldog Clamps	G42
DEBAKEY-SATINSKY Bulldog Clamps	G44
DEBAKEY-TITANIUM Bulldog Clamps	G41
Decapitating hook	T42
DEJERINE Percussion hammers	A02
DELEE Vaginal Specula	T12
Pelvimeters	T40
Obstetrical Forceps	T43
DEMARTEL Artery Forceps	G08
DE-MARTEL-WOLFSON Stomach Clamp Forceps	S09,
DEMEL Bone Wire Guides	K68
DENIS-BROWN Abdominal Retractors	D49
DERF Needle Holders	H04
Dermatomes	B09
DERRA-DEBAKEY Anastomosis Clamps	R12
DESCHAMPS Ligature Needles	H33, H34
DESJARDINS Kidney Clamp forceps	S21
Gall Stone Forceps	S23
Gall Stone Scoops	S23
Retractors	D09
DEVILBISS Vaginal Specula	T04
DIEFFENBACH Bulldog Clamps	G40
DIETHRICH / HEGEMANN Vascular Scissors	C17
DIETRICH Bulldog Clamps	G41
Needle Holders	H18

Produkt Index Product Index

englisch
english

Produktname Product	Seite Page
DIETRICH Aorta Clamps.....	R14
Dilating Bougies.....	S26, S27
DINGMANN Bone Holding Forceps.....	K45
Dissecting and Ligature Clamps.....	R28
Dissecting Scissors.....	C07 - C12
DITTEL Dilating Bougies.....	S26
DIXON-LOVELACE Artery Forceps.....	G11
DOUAY Biopsy Forceps.....	T30
DOUGLAS Forceps.....	F15
DOYEN Probes.....	B12
Operating Scissors.....	C06
Retractors.....	D22
Abdominal Retractors.....	D52
Towel Forceps.....	G34
Raspatories.....	K31
Intestinal Tissue Forceps.....	S05
Vaginal Specula.....	T11, T12
Uterine Polypus Forceps.....	T24
Myoma Screw.....	T26
DOYEN-STILLE Retractors.....	D22
Drapes.....	W30
Dressing Forceps.....	G35 - G38
Dressing Forceps.....	F02 - F07
Dressing Sterilizing Drums.....	W07
Dressing trays.....	W33
DUBOIS Cephalotomy Scissors.....	C12
DUEHRSEN Dressing Forceps.....	F06
DUNCAN Biopsy Curettes.....	T27
DUNHILL Artery Forceps.....	G09
DUPLAY Dressing Forceps.....	G37
Tenaculum Forceps.....	T22
DUPUY-WEISS Ligature Needles.....	H32
DURANTE Forceps.....	F14
DURHAM Ligature Needles.....	H32
DUVAL Forceps.....	F15
Tissue-, Organ holding forceps.....	S04
Dynamometer.....	A03
EASTMAN Vaginal Specula.....	T07
ECHLIN Bone Rongeur Forceps.....	K59
EDER Cotton Applicators.....	B15
EICKEN Suction tubes.....	B32
EISELSBERG Ligature Scissors.....	C32
Elevating spoon.....	T42
Elevators.....	K34 - K37
EMMET Dressing Forceps.....	G38
Hooks.....	T26
Endarterectomy Scissors.....	C15
Endarterectomy Strippers.....	B16
ENGEL Plaster saw.....	H42
ENGL. MODELL Dressing Forceps.....	F03

Produktname Product	Seite Page
ENGL. MODELL Towel Forceps.....	G32
Enterotomy Scissors.....	C14
Enucleation Scissors.....	C23
Episiotomy Scissors.....	C13
EPPENDORF Biopsy Forceps.....	T30, T32
EPSTEIN Abdominal Retractors.....	D54
Bone Curettes.....	K21
ESMARCH Bandage Scissors.....	C35
Plaster Instruments.....	H42
Extension Bows.....	K69
FANSLER Proctoscopes.....	S14
FARABEUF Retractors.....	D16
Raspatories.....	K27
FARABEUF Bone Holding Forceps.....	K50
FARABEUF-COLLIN Raspatories.....	K27
FARABEUF-LAMBOTTE Bone Holding Forceps.....	K50
FARELL Cotton Applicators.....	B15
FAURE Hysterectomy Forceps.....	G29, G32
FAURE Biopsy Forceps.....	T29
FAVALORO Vascular Scissors.....	C15
FEHLAND Sigmoid Anastomosis Forceps.....	S08
FEILCHENFELD Splinter forceps.....	F16
FEIN Cotton Applicators.....	B15
FERGUSSON Suction tubes.....	B38
Operating Scissors.....	C04
Hysterectomy Forceps.....	G27
Bone Holding Forceps.....	K46
Gall Stone Scoops.....	S23
FERRIS-SMITH Tissue Forceps.....	F13
FERROZELL Ligature Conductors.....	H37
Fiber Optic Laryngoscopes.....	A12 - A13
Fine Forceps.....	F17
Fine Forceps.....	R33, R38
Fine Retractors.....	D05 - D10
Fine Scissors.....	C18 - C25, C28
Fine Wound-, and Skin hooks.....	D02 - D04
Finger nail drill.....	B22
Finger Ring Saws.....	B22
FINOCHIETTO Artery Forceps.....	G22
Needle Holders.....	H12
Rib Spreader.....	R03, R08
FINOCHIETTO-BABY Rib Spreader.....	R03
FINOCHIETTO-BURFORD Rib Spreader.....	R06
FINOCHIETTO-MINI Rib Spreader.....	R03
FINSEN Retractors.....	D34
FISCH Suction tubes.....	B36
Flap Knife.....	B08
FOMON Nasal Scissors.....	C29, C30
FOMON(SABER-BACK) Nasal Scissors.....	C29
Forceps.....	F15

Produkt Index Product Index

Produktname Product	Seite Page
Forceps for tearing out nails	B22
FORD-DIXON Haemorrhoidal Ligators	S19
FOREGGER Laryngoscopes	A11
Foreign body forceps	S29
FÖRSTER (BALLENGER) Sponge Holding Forceps	G35
FOX Lupus Curettes	B24
FRANKLIN-SILVERMAN Needles	B30
FRANZ Abdominal Retractors	D50
FRAZIER Suction tubes	B36 - B40
Fine Wound-, and Skin hooks	D02
Abdominal Retractors	D45
FREEMAN Scissors for plastic surgery	C27
FREEMAN-KAYE Scissors for plastic surgery	C26
FRENZEL Nystagmus-Spectacles	A14
FRIEDMANN Bone Rongeur Forceps	K52
Vaginal Specula	T14
FRIEDMANN-FINO Bone Rongeur Forceps	K52
FRITSCH Retractors	D22
FRYKHOLM Bone Rongeur Forceps	K60
FUCHSIG Artery Forceps	G12
FUKUDA Retractors	D27
Gall Stone Forceps	S22, S23
GARDNER Pair of spare Jaws	K12
GARRETT Vessel Dilators	B18
GAUSS Ovum Forceps	T41
GELLHORN Biopsy Forceps	T28
GELPI Retractors	D43
GELPI-SELETZ Retractors	D43
GEMINI Artery Forceps	G18
GERALD Dressing Forceps	F06
Tissue Forceps	F12
GERZOG Mallets	K14
GIERTZ-STILLE Rib Shears	R09
GILLIES Fine Wound-, and Skin hooks	D04
Dressing Forceps	F04
Tissue Forceps	F10
Needle Holders	H17
GIL-VERNET Retractors	D10
GLENOID Bone Holding Forceps	K48
GLOVER Bulldog Clamps	G43
Anastomosis Clamps	R13
Aorta-Aneurysm Clamps	R16
GLOVER (POTTS) Anastomosis Clamps	R12
GLUCK Bone Scissors	C36
GOELET Retractors	D17
GOLDMAN-FOX Gum Scissors	C30
GOOD Nasal Scissors	C29
GOODELL Uterine Dilators	T18
GORNEY Scissors for plastic surgery	C27
GOSSET Abdominal Retractors	D45

englisch english

Produktname Product	Seite Page
Gouges	K4 - K10
GOURDET Uterine Curettes	T33
GRADLE Forceps	F15
GRAEFE Fine Scissors	C24
Fine Wound-, and Skin hooks	D02
GRAVE Vaginal Specula	T03
GRAVE-LASER Vaginal Specula	T03
GRAY Kidney Clamp forceps	S21
GREEN Retractors	D21
GREEN-ARMYTAGE Ovum Forceps	T41
GREENE Uterine Curettes	T34
GREGORY Peripheal Vascular Clamps	R27
GROSS-MAIER Dressing Forceps	G36
GRÜNWALD Dressing Forceps	F07
Guide Needles	B25
Gum Scissors	C30, C31
GUTHRIE Fine Wound-, and Skin hooks	D02
GUYON Kidney Clamp forceps	S20
Dilating Bougies	S27
GUYON-ATRAUMA Kidney Clamp forceps	S20
Gynecological Scissors	C11, C12
HABERER Spatulas	D31
Haemorrhoidal Forceps	S18
Haemorrhoidal Ligators	S18, S19
HAGLUND-STILLE Plaster spreader	H42
HAIGHT Rib Spreader	R02, R07
HAJEK Suction tubes	B32
Mallets	K14
HAKANSSON Bone Rongeur Forceps	K53
HALLE Tonsil Scissors	C28
Bone Curettes	K21
HALSEY Needle Holders	H03
HALSTED-MOSQUITO Artery Forceps	G06
Hand Drills	K65 - K67
Handbrushes	W03
HANK Uterine Dilators	T17
HARKEN Artery Forceps	G24
Auricle Clamps	R19
HARRINGTON Retractors	D30
HARTMANN Cotton Applicators	B15
Suction tubes	B32
Artery Forceps	G07
Bone Rongeur Forceps	K54
HAYES Bone Levers	K39
Intestinal Tissue Forceps	S07
Head Mirrors, Head lights	A06 - A08
HEANEY Retractors	D28
Uterine Curettes	T33
Hysterectomy Forceps	G26
HEANEY-BALLENTINE Hysterectomy Forceps	G26

Produkt Index Product Index

englisch
english

Produktname Product	Seite Page
HEANEY-KANTER Hysterectomy Forceps.....	G27
HEANEY-REZEK Hysterectomy Forceps.....	G27
HEANEY-SLIM Hysterectomy Forceps	G26
HEATH Mallets.....	K13
HEERMANN Mallets.....	K13
HEGAR Uterine Dilators	T15, T16
HEGAR-BAUMGARTNER Needle Holders.....	H05
HEGAR-VASCULAR Needle Holders	H09
HEGEMANN / DIETRICH Vascular Scissors	C17
HEGENBARTH ClipForceps.....	H41
HEISS Retractors.....	D34
Artery Forceps	G14
Hemilaminectomy retractors	D40
HENLEY Retractors.....	D37
Multi-Purpose Clamps	R26
HENNING Plaster spreader	H42
HENRY Forceps	F15
HEPP-SCHWEIDEL Needle Holders.....	H31
HERRICK Kidney Clamp forceps	S20
HESSBERG Ligature Needles	H32
HEY-GROVES Bone Holding Forceps	K47
HEYMANN Nasal Scissors	C29
HEYWOOD-SMITH Haemorrhoidal Forceps.....	S18
Uterine Polypus Forceps.....	T24
HF-Handles	U14
HIBBS Retractors	D28
Abdominal Retractors.....	D54
Osteotom.....	K06
Mallets	K14
HIRSCHMANN Proctoscopes.....	S13
HOEN Elevators.....	K35
HOHMANN Bone Levers	K39, K40
HOHMANN-ALDINGER Bone Levers	K41
HOKE Osteotom	K04
HOLINGER Laryngoscopes.....	A13
Laryngoscope	A13
HOLZBACH Retractors	D42
Hysterectomy Forceps	G28
Hooks	T26
HOPKINS Plaster Instruments	H42
Horizontal Spreader	D40
HÖSEL Retractors.....	D22
Needle Holders	H16
HOUSE Suction handles.....	B33
Suction tubes.....	B34
HUDSON Hand Drills.....	K66
HUFFMANN-GRAVE Vaginal Specula	T03
HUMBY Dermatomes	B10
HUNT Micro forceps	F26
HUNTER Splinter forceps.....	F16

Produktname Product	Seite Page
HYLIN Raspatories	K26
Hysterectomy Forceps.....	G25 - G32
Identification Labels.....	W29
Iliac Clamps.....	R36
Incision Scissors.....	C04
Indicator Labels	W29
Instrument Cases.....	W04 - W06, W09
Instrument Trays	W33
Intestinal and Stomach Clamps	S10
Intestinal Tissue Forceps.....	S02 - S08
IOWA Uterine Polypus Forceps	T24
Needle guide	T40
Irrigators.....	W31
ISRAEL Retractors.....	D15
ITERSON Fine Wound-, and Skin hooks	D04
IUD Extraction Hook	T20
IUD forceps	T20
IVES-FANSLER Anal Retractors	S12
JACKSON Laryngoscopes	A13
JACKSON Fine Wound-, and Skin hooks	D04
Retractors	D07
Vaginal Specula.....	T07
JACOBS Tenaculum Forceps.....	T22
JACOBSEN Micro forceps	F23
Artery Forceps	G07
Needle Holders	H21, H23, H28
Bone Curettes	K24
JACOBSEN-ADSON Dressing Forceps	F03
Artery Forceps	G12
JACOBSON Bulldog Clamps.....	G40
JACOBY Ligature Needles	H32
JAMESON Measuring Instruments.....	A04
Fine Scissors	C21
Needle Holders	H09
JAMESON-WERBER Fine Scissors.....	C21
JANSEN Retractors.....	D34
Nasal Forceps.....	F18
Bone Curettes	K24
Raspatories	K28, K31
Bone Rongeur Forceps	K54, K55
Head Mirrors, Head lights	A07
JARCHO Tenaculum Forceps	T21
Jars	W32
JAVID Carotid Shunt Clamps	R34
JOBSON-HORNE Cotton Applicators	B15
JOHN-HOPKINS Bulldog Clamps.....	G40
JOHNS-HOPKINS Artery Forceps.....	G19
JONES Towel Forceps	G32
JORGENSEN Gynecological Scissors.....	C12
JOSEPH Fine Scissors	C21

Produkt Index Product Index

Produktname Product	Seite Page
JUDD-ALLIS Intestinal Tissue forceps	S02
JUDD-MASSON Bladder Retractors	S25
KADER Retractors	D26
KAHN-GRAVE Vaginal Specula	T03
KALLMORGEN Vaginal Specula	T09
KALT Needle Holders	H31
KANTROWITZ Artery Forceps	G20
KATZIN Micro Scissors	C38
KAYE Fine Scissors (Ribbon type)	C25
Scissors for plastic surgery	C26
KELLY Fine Scissors	C21
Retractors	D21, D24
Artery Forceps	G04, G13
Proctoscopes	S13, S14
Uterine Polypus Forceps	T24
KELLY-ATRAUMA Artery Forceps	G04
KELLY-RANKIN Artery Forceps	G04
KERN (LANE) Bone Holding Forceps	K47
KEVORKIAN Biopsy Curettes	T27
Biopsy Forceps	T30, T32
KEVORKIAN-PACIFIC Biopsy Forceps	T31
Key Elevators	K36
KEYES Cutaneous Trephines	B24
Kidney bowls	W31
Kidney Clamp forceps	S20, S21
KIELLAND Obstetrical Forceps	T44
KIELLAND-LUIKART Obstetrical Forceps	T44
KILLIAN Suction tubes	B32
KILNER Fine Wound-, and Skin hooks	D04, D06
Needle Holders	H04
KILNER (RAGNELL) Fine Scissors	C24
KIRK Mallets	K14
KIRSCHNER Abdominal Retractors	D50
Ligature Conductors	H38
Extension Bows	K69
KIRSCHNER US-PATTERN Extensoin Bows	K69
KLAPP Retractors	D11
KLEINERT-KUTZ Tendon Seizing Forceps	B20
Fine Wound-, and Skin hooks	D03
Bone Rongeur Forceps	K56
Bone Cutting Forceps	K63
KLIMA-ROSEGGER Needles	B30
KLINGENBERG-LOTH Gynecological Scissors	C12
KLINIKUM BERLIN Tubing Forceps	G39
KNAPP Fine Scissors	C22
Fine Wound-, and Skin hooks	D03
KNAPP (BABY-LEXER) Fine Scissors	C20
KNOWLES Bandage Scissors	C34
KOCHER Retractors	D13, D19, D22, D23
Artery Forceps	G03

englisch english

Produktname Product	Seite Page
KOCHER Ligature Needles	H35
Intestinal Tissue Forceps	S07
KOCHER-LANGENBECK Retractors	D19
KOCHER-WAGNER Retractors	D19
KOGAN Endocervical Specula	T18
KÖNIG Retractors	D09
Ligature Conductors	H37
Raspatories	K26
Elevators	K34
KONRICH Dressing Sterilizing Drums	W07
KÖRTE Retractors	D15, D24
KÖRTE-WAGNER Retractors	D15
KRAUSE Trocars	B26
KRISTELLER Vaginal Specula	T07, T08
KRONECKER Ligature Needles	H32
KRÖNLEIN Artery Forceps	G08
KUEHNE Forceps	F15
KÜMMEL Retractors	D24
Laboratory bowls	W32
LAGRANGE Fine Scissors	C22
LAHEY Fine Wound-, and Skin hooks	D02
Retractors	D18
Artery Forceps	G22
LAMBERT-KAY Aorta Clamps	R15
LAMBOTTE Osteotom	K04
Raspatories	K29
Bone Holding Forceps	K50
LANDAU Trocars	B26
Vaginal Specula	T13
LANDOLT Enucleation Scissors	C23
LANE Tissue Forceps	F13
Towel Forceps	G34
Stomach Clamp forceps	S10
LANE-TRETHOWAN Bone Levers	K38
LANGE-HOHMANN Bone Levers	K41
LANGE-HOHMANN MOD. Bone Levers	K41
LANGENBECK Knives	B08
Amputation Saws	B12
Retractors	D18
Needle Holders	H15
Raspatories	K28
Elevators	K35, K36
Bone Holding Forceps	K46
LANGENBECK-GREEN Retractors	D07
LANGENBECK-RYDER Needle Holders	H15
LARRY Probes	S17
LARSEN Tendon Seizing Forceps	B20
Laryngoscopes	A10 - A13
LAWRENCE Artery Forceps	G21
LAZAR Micro forceps	F19

Produkt Index Product Index

englisch
english

Produktname Product	Seite Page
Lead hands	B21
LEBSCHKE Sternum Chisel.....	R11
LEES Bronchurs Forceps.....	R20
LEGUEU Bladder Retractors	S25
LEKSELL Bone Rongeur Forceps.....	K59
LELAND-JONES Multi-Purpose Clamps.....	R25
LEMMON Rib Contrators	R09
LEMPERT Bone Rongeur Forceps.....	K53
Bone Curettes	K21
LERCHE Tissue Forceps.....	F13
LERICHE Spatulas.....	D31
Artery Forceps	G05
LEWIN Bone Holding Forceps	K44
LEXER Operating Scissors	C04
Osteotoms.....	K4, K8
Gouge.....	K7, K8
LEXER-FINO Operating Scissors	C04
LICHTENBERG Needle Holders.....	H16
LICHTWITZ Trocars	B26
Ligator Rings.....	S18
Ligature Clamps.....	R29
Ligature Conductors	H37 - H39
Ligature Fork.....	H40
Ligature Needles	H32 - H36
Ligature Scissors	C31, C32
LINEMANN Wire Pliers	K73
LISTER Bandage Scissors	C34
Artery Forceps	G09
LISTER-EXCENTRIC Bandage Scissors	C34
LISTON Amputation Knives	B08
Bone Cutting Forceps	K62
LISTON-KEY Bone Cutting Forceps	K64
LITTAUER Bone Cutting Forceps.....	K62
Ligature Scissors	C31
LITTLE Retractors	D10
Ligature Scissors	C32
LITTLEWOOD Intestinal Tissue forceps	S03
LLOYD-DAVIS Sigmoid Anastomosis Forceps.....	S08
Lobectomy Scissors	C15
LOCKE Bone Holding Forceps	K44
LOCKHART-MUMMARY Probes.....	B14
Locking Pliers	K74
LOCKLIN Gum Scissors.....	C31
LOCKWOOD Intestinal Tissue forceps.....	S03
LOCKWOOD-ALLIS Intestinal Tissue forceps.....	S03
LONG Hysterectomy Forceps	G27
LORENZ Bandage Scissors.....	C35
LORNA Towel Forceps.....	G33
LOUTE Wire Instruments	K75
LOVE (MORSE) Retractors.....	D10

Produktname Product	Seite Page
LOVELACE Artery Forceps.....	G23
LOWER Artery Forceps	G21
LOWMAN Bone Holding Forceps	K50
LOWMAN-HOGLUND Bone Holding Forceps	K50
LUCAE Ear Forceps.....	F18
Mallets	K13
LUCAS Chisel	K02
LUER Retractors.....	D08
Bone Rongeur Forceps	K52, K54
LUER-KÖRTE Gall Stone Scoops	S23
LUKENS Retractors.....	D07
Lung spatulas	R11
Lupus Curettes	B25
Lupus scraper	B24
MAGILL Catheter Forceps	G34
Mallets.....	K12 - K17
MANNERFELDT Retractors.....	D07
MARCHAC / THORPE Measuring Instruments.....	A04
MARKHAM-MEYERDING Retractors.....	D44
MARQUARDT Bone Rongeur Forceps.....	K57
MARSCHIK Forceps	F14
MARTIN Retractors	D23
Bone Holding Forceps.....	K45
Uterine Probes.....	T19
Pelvimeters	T40
MARTIN-CARTILAGE Operating Scissors	C06
MARTINI Bone Curettes	K24
MASS. GEN. HOSP. Elevators	K34
MASSON Needle Holders	H12
MATHIEU Fine Retractors	D06
Retractors	D17
Needle Holders	H13 - H15
Rectal Specula	S11
Foreign body forceps	S29
Vaginal Specula.....	T11
MATHIEU-KOCHER Needle Holders	H15
MATHIEU-METZENBAUM Needle Holders.....	H14
MATHIEU-RYDER Needle Holders	H14
MATSON Raspatories	K31
MATZENAUER Vaginal Specula	T10
MAYFIELD Bone Rongeur Forceps.....	K57
MAYO Operating Scissors	C05
Forceps.....	F14
Safety pins.....	W02
MAYO-ADAMS Retractors.....	D43
MAYO-BLAKE Gall Stone Forceps.....	S22
MAYO-COLLIN Retractors	D17
MAYO-GUYON Kidney Clamp forceps	S20
MAYO-HEGAR Needle Holders	H06, H07
MAYO-HEGAR-SEELEY Needle Holders.....	H05

Produkt Index Product Index

Produktname Product	Seite Page
MAYO-NOBLE Operating Scissors	C06
MAYO-ROBSEN Intestinal Tissue Forceps	S05
MAYO-ROBSEN-ATRAUMA Intestinal Tissue Forceps	S05
MAYO-STILLE Operating Scissors	C05
MCCREA Dilating Bougies	S26
MCDONALD Elevators	K36
MCGIVNEY Haemorrhoidal Ligators	S18, S19
MCGLAMRY Elevators	K37
MCINDOE Dissecting Scissors	C07
Dressing Forceps	F04
Tissue Forceps	F10
Bone Cutting Forceps	K63
MCINTOSH Laryngoscopes	A11, A12
MCKENTY Raspatories	K26
MCLEAN Obstetrical Forceps	T44
MCQUIGG-MIXTER Artery Forceps	G19
MEAD Mallets	K12
Bone Rongeur Forceps	K53
Measuring Instruments	A03
Measuring Instruments	A03, A04
Measuring jugs	W31
Medicine Cups	W31
MEEKER Artery Forceps	G21
MENGHINI Needles	B30
MERCEDES Rib Spreader	R06
Metal Catheters	S28
METZENBAUM Dissecting Scissors	C08, C09
METZENBAUM-FINO Dissecting Scissors	C10
MEYERDING Retractors	D08, D30
Retractors	D44
Abdominal Retractors	D54
MICHEL Suture Clips	H40
Clip Forceps	H40, H41
MICRO (TURNER) Tissue Forceps	F11
Micro forceps	F19 - F26
Micro Scissors	C37 - C49
MICRO-ADSON Dressing Forceps	F03
Tissue Forceps	F09
MICRO-ADSON-BEAMER Tissue Forceps	F10
MICRO-MOSQUITO Artery Forceps	G07
MICRO-RYDER Needle Holders	H10
MICRO-SEMKEN Tissue Forceps	F10
MICRO-VASCULAR Needle Holders	H09
MIDDELORPFF Retractors	D20
MIKRO (TURNER) Dressing Forceps	F04
MIKULICZ Retractors	D24
Hysterectomy Forceps	G31
MILAN Uterine Curettes	T34
MILLER Laryngoscopes	A11, A13
Fine Wound-, and Skin hooks	D03

englisch english

Produktname Product	Seite Page
MILLIGAN Retractors	D36
MILLIN Capsula forceps	S24
Bladder Retractors	S25
MILLS Fine Scissors	C28
MINI-GEMINI Artery Forceps	G18
MINI-GILLIES Needle Holders	H17
MINI-HOHMANN Bone Levers	K39
MINI-LAMBOTTE Osteotom.	K03
MINI-LANGENBECK Retractors	D08
MINI-LEXER Osteotom.	K04
MINI-ROUX Retractors	D16
MINI-TOWNSEND Biopsy Forceps	T31
MISKIMOM Retractors	D40
MIXTER Operating Scissors	C93
Artery Forceps	G19, G22
MIXTER O'SHAUGNESSY Artery Forceps	G20
MIXTER-SLIM Artery Forceps	G19
MOD. BONN Fine Scissors	C22
MOD. LONDON Biopsy Curettes	T28
MOD. MÜNCHEN Biopsy Curettes	T28
MOD. TÜBINGEN Retractors	D23
Retractors	D37
MOD. USA Umbilical Scissors	C14
Dressing Forceps	F03
Tissue Forceps	F09
Chisel	K03
MOD. WIEN Suture Catcher	H40
MOLLISON Retractors	D37
MOLT Raspatories	K28
MÖLTGEN Goniometer	A03
Monopolar Cables	U16
Monopolar Forceps	U10
MOORE Spoon	S23
MORGAN Proctoscopes	S13
MORRIS Retractors	D20
MORRIS-DEBAKEY Aorta-Aneurysm Clamps	R16
MORSE Rib Spreader	R04, R07
MOSQUITO-DANDY Artery Forceps	G11
MOYNIHAN Hysterectomy Forceps	G28
MÜLLER Vessel Clips	G48
Multi-Purpose Clamps	R25, R26, R30, R32, R35
MURPHY-LANE Elevators	K37
MUSEUX Tenaculum Forceps	T23
MYERS Vein Strippers	B16
Myoma Screw	T26
Myrtle-shaped	B13
NABATOFF Varicose Vein Probe Set	B16
NÄGELE Perforators	T42
Obstetrical Forceps	T43
Nail files	B23

Produkt Index Product Index

englisch
english

Produktname Product	Seite Page
Nail Nippers.....	B22, B23
Nail Scissors.....	C33
Nail splitting Scissors.....	C33
Nasal forceps.....	F18
Nasal Scissors.....	C29, C30
Needle Cases.....	W34
Needle Holders.....	H03 - H31
Needle Nose Locking Pliers.....	K74
Needles.....	B30
NEFF Knives.....	B11
NEGUS Artery Forceps.....	G13
NEIVERT Needle Holders.....	H03
NELATON Probes.....	B13
NELSON Trocars.....	B25
Forceps.....	F14
Neonatal and Pediatric Clamps.....	R42
Neonatal-Spreader Titanium.....	R02
Nerve dissecting Scissors.....	C21
Neutral Electrodes.....	U18 - U29
NEW ORLEANS Needle Holders.....	H07
NISSEN Artery Forceps.....	G12
NORFOLK-NORWICH Retractors.....	D39
NORTHBENT / SHORTHBENT Ligature Scissors.....	C31
NORTHFIELD Bone Rongeur Forceps.....	K54
NORWOOD Rectal snare.....	S17
NOTO Uterine Polypus Forceps.....	T24
NOVAK Biopsy Curettes.....	T27
NOYES Micro Scissors.....	C39
NUBOER Suction tubes.....	B28
Nystagmus-Spectacles.....	A14
Obstetrical Forceps.....	T43 - T45
OCHSNER Trocars.....	B26
Dressing Forceps.....	F03
Aorta Clamps.....	R14
OCHSNER-KOCHER Artery Forceps.....	G03
O'CONNOR Fine Wound-, and Skin hooks.....	D02
OLIVECRONA Knives.....	B11
Bone Rongeur Forceps.....	K55
OLLIER Retractors.....	D14
OLSEN-HEGAR Needle Holders.....	H17
Bipolar Scissors.....	U13
OMBREDANNE Mallets.....	K16
Operating Scissors.....	C02 - C06
Operation Laryngoscopes.....	A09
Oscillating Plaster Saws.....	H43, H44
Osteotomes.....	K4 - K10
O-SULLIVAN-O'CONNOR Abdominal Retractors.....	D49
Vaginal Specula.....	T14
OTIS Dilating Bougies.....	S26
Urethrotome.....	S30

Produktname Product	Seite Page
OVERHOLT-GEISSENDÖRFER Artery Forceps.....	G17
OVERHOLT-MIXTER Artery Forceps.....	G18
OVERHOLT-S Artery Forceps.....	G17
OVERHOLT-SLIM-S Artery Forceps.....	G17
Ovum Forceps.....	T41
Paper filters.....	W28
PAR Scissors for plastic surgery.....	C26
Needle Holders.....	H03
Parametrium Scissors.....	C13
PARK Anal Retractors.....	S12
PARKER Retractors.....	D16
PARKER-LANGENBECK Retractors.....	D17
PARKER-MOTT Retractors.....	D17
PARSONNET Retractors.....	D34
PARTSCH Chisels.....	K02
Raspatories.....	K27
PASSOW Pestle.....	K11
PATTERSON Biopsy Forceps.....	T30
PAYR Ligature Conductors.....	H37
ntestinal and Stomach Clamps.....	S10
PEAN Artery Forceps.....	G03, G10
PEDERSON Vaginal Specula.....	T04
PEDERSON-LASER Vaginal Specula.....	T04
PEERS-BERTRAM Towel Forceps.....	G33
PEET Splinter forceps.....	F16
PELKMANN Dressing Forceps.....	G37
PELTESON Cotton Applicators.....	B15
Pelvimeters.....	T40
Penis clamps.....	S30
PENNINGTON Artery Forceps.....	G08
PENNYBACKER Bone Rongeur Forceps.....	K55
Percussion hammers.....	A02
PERCY Amputation Retractor.....	K51
Perforators.....	T42
Peripheal Vascular Clamps.....	R27
PERKINS Retractors.....	D34
PERTHES Reamer (Awl).....	K68
Pestle.....	K11
PETZ Stomach and Intestinal Suturing Apparatus Petz cplt.....	S10
Phalangeal knife.....	B08
PHANEUF Hysterectomy Forceps.....	G28
PIERCE Trocars.....	B26
PIFFARD Lupus Curettes.....	B24
Pin Cutter.....	K78
PINARD Stethoscopes.....	A03
PIPER Obstetrical Forceps.....	T44
Plaster Instruments.....	H42 - H44
PLASTER SAWS.....	H43, H44
Plaster spatulas.....	B14
Plaster-of-Paris Scissors.....	C36

Produkt Index Product Index

Produktname Product	Seite Page
PLASTIC Fine Scissors	C19
Plastic Container	W35
Plastic Seals	W29
Plate and Wire cutting plier	K77
PLESTER Suction tubes	B36
PLESTER Retractors	D35
POLLOSON Retractors	D27
POOLE Suction tubes	B29
Postmortem Knives	B09
POTTS (GLOVER) Coarctation Clamps	R21, R22
POTTS-DE-MARTEL Fine Scissors	C28
POTTS-SMITH Dissecting Scissors	C07
Vascular Scissors	C16, C17
Dressing Forceps	F06
Tissue Forceps	F12
POZZI Tenaculum Forceps	T22
PRATT Fistula probes	B14
Artery Forceps	G09
Rectal Specula	S11
Probes	S17
Uterine Dilators	T17
Tenaculum Forceps	T24
PRESBYTERIAN Tubing Forceps	G39
PRICE-THOMAS Artery Forceps	G23
PRINCE Tonsil Scissors	C29
Probes	B13, B14
Proctoscopes	S13, S14
Profunda Clamps	R27
Prostatic Retractors	S24
PROVIDENCE Artery Forceps	G05
QUERVAIN Elevators	K35
QUINBY Gum Scissors	C30
QUINKE Needles	B30
RADOLF Forceps for tearing out nails	B22
RAGNELL Fine Scissors (Ribbon type)	C25
RAGNELL (KILNER) Fine Scissors	C24
RAGNELL-DAVIS Fine Retractors	D06
RALK Splinter forceps	F16
Hand Drills	K65
RAMPLEY Sponge Holding Forceps	G35
RANDALL Kidney Clamp forceps	S21
Biopsy Curettes	T27
Raspatories	K26 - K33
Razor blade holder	B07
Razor Blades	B07
RECAMIER Uterine Curettes	T36
Rectal Biopsy Forceps	S16
Rectal Instruments	S17
Rectal Specula	S11
Rectoscopes	S15

englisch english

Produktname Product	Seite Page
REDON Guide Needles Redon	B25
REIL Bone Holding Forceps	K44
Needle Holders	H28
RESANO Operating Scissors	C06
Forceps	F14
Sigmoid Anastomosis Forceps	S08
Retractors	D05 - D30
REVERDIN Spatulas	D31
Ligature Needles	H36
REYNOLDS Fine Scissors	C21
RHOTON-TITAN Micro forceps	F21
Rib Contractors	R09
Rib Shears	R09, R10
Rib Spreader	R02 - R08
RIBBON TYPE Fine Scissors (Ribbon type)	C25
RICARD Retractors	D42
RICHARDSON Retractors	D21
RICHARDSON-EASTMAN Retractors	D21
RICHTER Operating Scissors	C04
RICHTER-HEATH Clip Forceps	H40
RIENHOFF-FINOCHIETTO Rib Spreader	R02
RIGBY Retractors	D44
Ring-Retractor-System	D55 - D59
RITTER-HALLE Dilators	B18
ROBERTS Artery Forceps	G14
ROCHARD Abdominal Retractors	D51
ROCHESTER-CARMALT Artery Forceps	G10
RÖDER Towel Forceps	G33
ROGGE Sterilizing forceps	W02
ROSE Retractors	D09
ROSEN Suction cannulas	B33
ROSS Retractors	D28
RÖTTGEN-RUSKIN Bone Rongeur Forceps	K58
ROUX Retractors	D16
ROUX-MAGNUS Retractors	D16
RUBIO Wire Pliers	K70
RUDD Haemorrhoidal Ligators	S19
RUMEL Artery Forceps	G15
RUMEL-BELMONT	R11
RUSKIN Bone Rongeur Forceps	K57
RUSKIN-LISTON Bone Cutting Forceps	K63
RUSKIN-ROWLAND Bone Cutting Forceps	K63
RUSS. MODELL Forceps	F14
RYDER Needle Holders	H10, H28
SAALFELD Comedo Extractors	B24
SALENIUS Knives	B11
Salpinograph	T38
SÄNGER Ovum Forceps	T41
SANTULLI Bulldog Clamps	G42
SANVENERO Fine Scissors	C20

Produkt Index Product Index

englisch
english

Produktname Product	Seite Page
SAROT Artery Forceps	G14
Needle Holders	H11
SATINSKY Gynecological Scissors	C12
Artery Forceps	G24
SATINSKY-DEBAKEY Tangential Occlusion Clamps	R31
SATTERLEE Amputation Saws	B12
SAUERBRUCH Retractors	D19, D25
Bone Rongeur Forceps	K60
Rib Shears	R09
Sterilizing forceps	W02
Scalpel Blades	B04, B05
Scalpel Handles	B2, B3, B5
Scalpels	B06
SCHACKE Uterine Manipulators	T20
SCHÄDEL Towel Forceps	G32
SCHAMBERG Comedo Extractors	B24
SCHEDE Bone Curettes	K18
SCHERBAK Vaginal Specula	T13
SCHIMMELBUSCH Dressing Sterilizing Drums	W07
SCHINDLER Hysterectomy Forceps	G32
SCHINK Dermatomes	B10
SCHMID Irrigating cannulas	B17
Vascular spatulas	B17
SCHMIEDEN Ligature Needles	H35
Ligature Conductors	H37
SCHMIEDEN-PAYR Ligature Conductors	H37
SCHMIEDEN-TAYLOR Fine Scissors	C28
SCHNEIDER Raspatories	K28
SCHNEIDER-SAUERBRUCH Raspatories	K29
SCHNIDT-SAWTELL Artery Forceps	G20
SCHOEMAKER-LOTH Ligature Scissors	C32
SCHRÖDER Tenaculum Forceps	T21, T23
Uterine Curettes	T33
SCHUBERT Biopsy Forceps	T28, T29
SCHUKNECHT Suction tubes	B34
Retractors	D37
SCHULTZE Salpinograph	T38
SCHUMACHER Umbilical Scissors	C14
Bone Levers	K42
Biopsy Forceps	T29, T30, T32
SCHWARTZ Bulldog Clamps	G44
Scissors for plastic surgery	C26, C27
SCOVILLE Abdominal Retractors	D53, D54
Bone Curettes	K20
SCOVILLE-HAVERFIELD Abdominal Retractors	D53
SCOVILLE-RICHTER Abdominal Retractors	D53
SCUDDER Stomach Clamp Forceps	S09
SEBILEAU Elevators	K34
Secretion spoon	T28
SEDILLOT Raspatories	K28

Produktname Product	Seite Page
SEGOND Hysterectomy Forceps	G32
SEGOND-LANDAU Hysterectomy Forceps	G32
SEIDL Vaginal Specula	T07
SEIFFERT Probes	B13
SELDIN Raspatories	K29
Elevators	K36
SELLHEIM Elevating spoon	T42
SELLORS Rib Contrators	R09
SELMAN Forceps	F14
SEMB Artery Forceps	G22
Raspatories	K31
Bone Holding Forceps	K46
Bone Rongeur Forceps	K59
Bone Cutting Forceps	K64
SEMKEN Dressing Forceps	F04
Tissue Forceps	F10
SEMM Abdominal Retractors	D49
Vaginal Specula	T05
SENN-GREEN Retractors	D08
SENNING Needle Holders	H11
SENN-MILLER Fine Retractors	D06
Sensibility Instruments	A02
Septum Needles	B31
SEUTIN Bandage Scissors	C36
SEXTON Retractors	D40
SEYFFERT Vaginal Specula	T05
SHAAF Forceps	F15
SHORTBENT / NORTHBENT Ligature Scissors	C31
Shoulder Awl	K68
Shoulder Gouge	K07
SIEBOLD Gynecological Scissors	C12
Sigmoid Anastomosis Forceps	S08
Silicone mats	W15, W19, W23, W27
SILVER Dermatomes	B10
SIMON Scalpels	B06
Retractors	D23
Hooks	T26
Uterine Curettes	T33
Bone Curettes	K21
SIMPSON Uterine Probes	T19
Obstetrical Forceps	T43
SIMPSON-BRAUN Obstetrical Forceps	T43
SIMPSON-LUIKART Obstetrical Forceps	T44
SIMS Gynecological Scissors	C11
Rectal Specula	S11
Vaginal Specula	T06
Uterine Probes	T19
Uterine Depressors	T20
Uterine Curettes	T35
SIMS (BODENHAMMER) Rectal Specula	S11

Produkt Index Product Index

Produktname Product	Seite Page
SIMS (US-MODELL) Vaginal Specula	T06
SIMS-KELLY Vaginal Specula	T06
SIMS-MAIER Dressing Forceps	G37
SINGLEY-TUTTLE Forceps	F14
SKENE Tenaculum Forceps	T22
SMELLIE Perforators	T42
Knives	B11
Retractors	D26
SMITH Scissors	C33
Vaginal Specula	T14
SMITH (USA) Bandage Scissors	C35
SMITH-BUIE Anal Retractors	S12
SMITH-PETERSEN Osteotoms	K05
Bone Rongeur Forceps	K58
SOMER Uterine Forceps	T25
Spatulas	D31
SPENCER Ligature Scissors	C31
SPENCER-FINO Ligature Scissors	C31
SPENCER-WELLS Artery Forceps	G11
Splinter forceps	F16
Sponge and Dressing Forceps	G35 - G38
SPRATT Bone Curettes	K19
Sputum Cups	W32
ST. MARKS Retractors	D25
STACKE Probes	B13
STAGBEETLE Bone Holding Forceps	K43
STAUDE-MOORE Tenaculum Forceps	T21
STEINER-AUVARD Vaginal Specula	T12
STEINMANN Tendon Seizing Forceps	B20
STELLBRINK Bone Rongeur Forceps	K53
Sterilizing forceps, Safety pins	W02
Sternum Chisel	R11
Stethoscopes	A03
STEVENS Tenotomy Scissors	C23
Fine Scissors (Ribbon type)	C25
STEWART Probes	S17
STIEGLITZ Splinter forceps	F16
STILLE Plaster-of-Paris Scissors	C36
Chisels	K06
Bone Rongeur Forceps	K60
Hand Drills	K66
Kidney Clamp forceps	S20
STILLE-BARRAYA Tissue Forceps	F13
STILLE-LISTON Bone Cutting Forceps	K64
STILLE-LUER Bone Rongeur Forceps	K58
STILLE-LUER-ECHLIN Bone Rongeur Forceps	K60
STITCH SCISSORS Fine Scissors (Ribbon type)	C25
STOCKMANN Penis clamps	S30
Stomach Clamp Forceps	S09, S10
STONE Tissue Forceps	F13

englisch english

Produktname Product	Seite Page
Strabismus Scissors	C25
STRANDELL-STILLE Retractors	D08
STRATTE Needle Holders	H11
STRAUSS Penis clamps	S30
STRUCK Rib Spreader	R04
STRULLY Fine Scissors	C28
SUBRAMANIAN-MINIATURE Peripheal Vascular Clamps	R27
Suction cannulas	B33
Suction handles	B33
Suction tubes	B28 - B30
SULLIVAN (BROPHY) Fine Scissors	C20
Suture Catcher	H40
Suture Clips	H40
Suture Instruments	H37 - H40
Suture Set	H41
Swan Neck Gouge	K07
SWEDISH PATTERN Bone Curettes	K20
SWEET Amputation Retractor	K51
SYPERT Pestle	K11
Bone Rongeur Forceps	K61
Syringes	B41
Tangential Clamps	R31, R37
TARNIER Obstetrical Forceps	T44, T45
TAYLOR Percussion hammers	A02
Retractors	D26
Abdominal Retractors	D54
Dressing Forceps	F05
Tissue Forceps	F11
Bone Levers	K42
TEALE Tenaculum Forceps	T23
Tenaculum Forceps	T21 - T24
Tendon passing instrument	B19
Tendon Seizing Forceps	B20
Tendon strippers	B19
Tenotomy Scissors	C23
TERRIER Artery Forceps	G07
Textile filters	W28
THOMAS Uterine Curettes	T35
THOMS-ALLIS Intestinal Tissue forceps	S02
THOMS-GAYLOR Biopsy Forceps	T28
TISCHLER Biopsy Forceps	T29, T31, T32
Tissue Forceps	F08 - F13
Tissue Forceps	F08
Tissue-, Organ holding forceps	S04
TOHOKU Towel Forceps	G33
TÖNNIS Knives	B11
Dissecting Scissors	C07
Artery Forceps	G21
Needle Holders	H16
TÖNNIS-ADSON Dissecting Scissors	C07

Produkt Index Product Index

englisch
english

Produktname Product	Seite Page
TÖNNIS-FINE Dissecting Scissors.....	C07
Tonsil Scissors.....	C28, C29
Torniquets.....	R11
Towel Forceps.....	G32 - G34
TOWNLEY Measuring Instruments.....	A04
TOWNSEND Biopsy Curettes.....	T27
Biopsy Forceps.....	T32
TRAVERS Retractors.....	D37
TRELAT Vaginal Specula.....	T04
TREVES Tissue Forceps.....	F13
Trocars.....	B25 - B27
TROEMNER Percussion hammers.....	A02
TRÖLTSCH (WILDE) Ear Forceps.....	F18
TROUTMAN Razor blade holder.....	B07
Tubing Forceps.....	G39
TUFFIER Spatulas.....	D22, D31
Artery Forceps.....	G08
Rib Spreader.....	R02
UFFENORDE Bone Curettes.....	K20
ULRICH Dressing Forceps.....	G37
Bone Holding Forceps.....	K47
Vaginal Specula.....	T10
Umbilical cord clamps.....	T42
Umbilical Scissors.....	C14
UNIVERSAL Wire cutting Scissors.....	C32
UNNA Comedo Extractors.....	B24
Urethrotome.....	S30
US-MODELL Retractors.....	D12
US-PATTERN Mallets.....	K15, K16
Uterine Curettes.....	T33 - T37
Uterine Depressors.....	T20
Uterine Dilators.....	T15 - T18
Uterine Forceps.....	T25
Uterine Manipulators.....	T20
Uterine Polypus Forceps.....	T24
Uterine Probes.....	T19
Uterus Manipulators.....	T39
Vaginal Specula.....	T02 - T14
VALLEIX Uterine Probes.....	T19
VAN ALYEA Septum Needles.....	B31
VAN BUREN Dilating Bougies.....	S26
VAN DOREN Biopsy Forceps.....	T29
VANBUREN Bone Holding Forceps.....	K46
VANNAS Micro Scissors.....	C37
VANNAS-TÜBINGEN Micro Scissors.....	C37
VARADY Vascular Instruments.....	B16
Varicose Vein Probe Set.....	B16
Vascular Scissors.....	C15 - C17
Vascular spatulas.....	B17
Vasectomy Forceps.....	S29

Produktname Product	Seite Page
Vein Strippers.....	B16
VERBRUGGE Bone Holding Forceps.....	K49
VERBRUGGE-MÜLLER Bone Levers.....	K40
Vessel Clips.....	G44 - G49
Vessel Dilators.....	B18
Vessel Dilators.....	F17
VICKERS Wire Instruments.....	K75
VIDAL Lupus scraper.....	B24
VIRCHOW Knives.....	B09
WISE Fine Forceps.....	F17
VOGEN Bone Holding Forceps.....	K41
VOLKMANN Retractors.....	D11, D12
Bone Curettes.....	K18, K24
WACHENFELDT ClipForceps.....	H41
WAGNER Fine Scissors.....	C19
Gouge.....	K09
Raspatories.....	K33
Bone Levers.....	K41
WALDMANN Parametrium Scissors.....	C13
WALLICH Abortion Sscopes.....	T40
WALTER-CARMALT Splinter forceps.....	F16
WALTHER Dilating Bougies.....	S27
WALTON Fine Scissors.....	C20
Fine Scissors (Ribbon type).....	C25
Plaster spreader.....	H42
WANGENSTEEN Dressing Forceps.....	F07
Needle Holders.....	H12
WARTENBERG Sensibility Instruments.....	A02
WASSMUND Retractors.....	D14
Watchmaker's forceps.....	F17
WATSON Dermatomes.....	B10
WATSON-CHEYNE Raspatories.....	K26
Elevators.....	K36
WAUGH Dressing Forceps.....	F05
Tissue Forceps.....	F11
WEBER Aorta Clamps.....	R13
WEBSTER Needle Holders.....	H04
WEITLANER Retractors.....	D35, D36
WEITLANER-BABY Retractors.....	D36
WEITLANER-WULLSTEIN Retractors.....	D36
WELDON Bulldog Clamps.....	G40, G43
WERTHEIM Gynecological Scissors.....	C12
Hysterectomy Forceps.....	G28, G29
WERTHEIM-CULLEN Hysterectomy Forceps.....	G30
WEST Gouge.....	K03
WESTCOTT Micro Scissors.....	C38, C39
WICKSTRÖM Artery Forceps.....	G20
WIENER MODELL Vaginal Specula.....	T09
WILLET-DEMARTEL Ovum Forceps.....	T41
WILLIAM Retractors.....	D44

Produkt Index Product Index

englisch
english

Produktname Product	Seite Page
WILLIAMS Intestinal Tissue forceps	S03
WILLIGER Mallets	K14
Bone Curettes	K20, K24
Raspatories	K26
Elevators	K34
WILMER Fine Scissors	C24
WINTER Ovum Forceps	T41
Wire Baskets	W10 - W30
Wire Containers	W08
Wire Cutting Pliers	K76 - K78
Wire cutting Scissors	C32
Wire Instruments	K69 - K79
Wire Pliers	K70 - K74
WITTNER Biopsy Forceps	T30
WOLF Lupus Curettes	B24
WOLFF Plaster cast forceps	H42
WOODRUFF Ligature Needles	H32
WRIGLEY Obstetrical Forceps	T43
WULLSTEIN Suction tubes	B34
WYLIE Aorta-Aneurysm Clamps	R18
YANKAUER Suction tubes	B28
Elevators	K34
YASARGIL Suction tubes	B37
Micro forceps	F22, F23, F26
Needle Holders	H21, H22
YEOMAN Rectal Biopsy Forceps	S16
YOUNG Artery Forceps	G09
Ligature Needles	H36
Prostatic Retractors	S24
ZAUFAL-JANSEN Bone Rongeur Forceps	K57
ZENKER Retractors	D26
Artery Forceps	G16
ZIEGLER Headmirror	A08
Forceps	F15
ZIELKE Gouge	K05
ZÖLLNER Suction tubes	B34
ZWEIFEL Needle Holders	H16



Sold & Distributed by:
Capital Medical Resources LLC



CAPITAL MEDICAL RESOURCES LLC | 57 N SANDUSKY ST, SUITE 1 | DELAWARE, OH, 43015
614.389.1334 | INFO@CAPITALMEDICALRESOURCES.COM | WWW.CAPITALMEDICALRESOURCES.COM

best
medical

best medical GmbH

Heudorfer Straße 32
D-78576 Emmingen-Liptingen

// Fon: +49 (0)7465 / 91230

// Fax: +49 (0)7465 / 91232

// Mail: info@bestmedical.biz

www.bestmedical.biz

// C.gen.01 | 01-2014
© 2014 best medical GmbH.
Alle Rechte vorbehalten.
Technische Änderungen und Irrtum vorbehalten.
All rights reserved. Technical alterations are possible.