EASTVIEW WRESTLING

Season Review

2001 - 2002

EASTVIEW
M:P 2000
M:P 2002
WRESTLING

COMMITMENT TO EXCELLENCE



EASTVIEW WRESTLING

TEAM 2002: MISSION POSSIBLE

Congratulations for your commitment, hard work, and belief in that the mission is possible. The season was filled with many highlights for each team and the wrestling program as a whole. At last year's banquet, we celebrated a very successful year – 14 varsity wins, a 9th grade state championship, qualifying a school record 4 individuals to state, having 2 state place winners, and celebrating Eastview's first State Champion. The success in the 2001-2002 season was yet to be determined. The coaching staff challenged each returning wrestler to make a commitment and work hard during the off season. The challenge was obviously met. The success we had this year was a direct result of the efforts made in the off season. Team 2002 was not only prepared in the beginning, it continued to work hard and improve throughout the entire season.

Reflecting on this past season brings back many **positive memories**. The season officially began with the 3rd annual commitment night. What a great event to allow a team filled with underclassmen to come together, set goals, build relationships, and begin establishing trust in each other. Below is a recap of the 2001-2002 season.

The **freshman team** had an outstanding season filled with many highlights...

- ◆ 22 freshman wrestlers worked hard each day and wrestled as a team.
- ◆ 10 dual victories, placing 6th at the Eastview tournament, & qualifying for the team state tournament.
- ◆ Improving throughout the year and having a great individual region tournament placing 3rd as a team.
- ◆ Qualifying 4 individuals to the 9th grade state tournament and having a state place winner.

The **junior varsity team** also had a record breaking season having multiple wrestlers compete for each weight...

- ◆ A team that continued the tradition of dominating and becoming more prestigious.
- ◆ A school record 18 dual meet wins and a 3rd place finish in the Lake Conference.
- ◆ Earning 2nd place at the Coon Rapids Duals.
- ◆ Participating in a Varsity tournament in South Dakota and earning 4th place honors.
- ◆ Providing the depth needed to fulfill each of the varsity teams needs.

The **varsity team** was challenged from the very beginning. Our goals were to improve each day and finish better than any other Lightning wrestling team...

- ◆ Earning 16 hard fought victories and being competitive with each team wrestled.
- ◆ Accomplishing a team goal of earning 307 match wins, a team record.
- ◆ Having 12 wrestlers place at the section tournament with 7 individuals earning the opportunity to wrestle in a match that would qualify them for the state tournament.
- ◆ Qualifying 4 wrestler's to the state tournament - setting a school record.
- ◆ Earning the team title of Academic State Champions!

The **Class of 2002**, the Super Seven, has paved the way while accomplishing many great things. The senior class leaves having earned 54 varsity dual meet wins, 157 individual match wins, 65 falls, and 721 team points - all filmed by our senior videographer. To each of the seniors, I thank you for your hard work, commitment, and your ability to achieve things nobody would have believed. My hope for you is that you continue to use these life long skills to achieve great things. You will always be welcome in our wrestling room.

I share with you some final thoughts about the future of Eastview Wrestling. The **future of Eastview Wrestling** appears to be bright. However, without the support of the parents, the dedication of the coaches, and commitment and sacrifice of the wrestles, success will only be a dream. The success that our wrestling program will have in 2003 is dependent on each wrestler challenging oneself and his teammates, doing the extra little things, and having the desire to **"Fight, Inch by Inch"**. With that being said, **I challenge each of you make a commitment, sacrifice, and work hard**. Eastview is a program that is ready to take the next step in the journey of becoming **STATE CHAMPIONS!**

Coach Habeck

EASTVIEW WRESTLING TEAM

12 KRIS CARSON
12 MIKEY FORNICOIA
12 MIC HALE
12 WADE HALVORSEN
12 ERIC LEMM
12 DAVID PUDWILL
11 BRIAN BARTA
11 JOHN GETZKE
11 GRAHAM JOHNSON
11 NATE KOCER
11 ANDREW LENERTZ
11 KEVIN MCBRIDE
11 KURT MCCUE
11 RANDY PRICE
11 CHRIS SHUCK
11 JUD TURK
11 JAMES VOYLES
10 ERIC ANDERSON
10 ANDREW CHOI
10 STEVE DAVIS
10 PAT DEA
10 KEVIN EICH
10 JEREMIAH FOERTSCH
10 KYLE FOKKEN
10 DAVID GROGG
10 FRED HWANG
10 DAN KURDZIEL
10 RYAN LANGLAIS
10 ALEX PATTIE
10 JAKE RAINS
10 JESSE STAPP
10 CORY WAGNER
10 BRIAN WALLENTA
9 KANE BECHSTEIN
9 JUSTIN BROOKMAN
9 THOMAS CHIES
9 TYLER COOKAS
9 JOSH GONZALES
9 ALLEN HUDSPETH
9 DAN HILDEBRANDT
9 MATT JOHNSON
9 TYSON JOHNSON
9 JEROD LASS
9 MICHAEL LEBEIS
9 ALEX LEMAIRE
9 RYANMAAS
9 STEPHEN MCMOORE
9 TIM MILLS
9 BEN POLANSKY
9 SCOTT POLANSKY
9 JOHN REINERS
9 RYAN RUCKDASHEL
9 TERRY SHERIDAN
9 DANA VORACHEK
9 SAM VOYLES
9 KYLE WILSON

PRINCIPAL

Dr. J. Richard Dewey

ATHLETIC DIRECTOR

Bruce Miller

COACHES

Kurt Habeck

Nick Fornicoia

Todd Frost

Travis Lee

Brent Odenbrett

Shane Peters

NICKNAME

Lightning

SCHOOL COLORS

Black, Blue, Silver, White

VARSIITY MANAGERS

Taryn Noll

Kari Okonek

Melanie Putnam

FRESHMAN MANAGERS

Jen Ortendahl

Christina Spelman

Katie Peterson

VIDEOGRAPHERS

Andrew Scott

Michelle Nelson

VARSIITY CHEERLEADERS

Megan Anderson

Cassie Chapley

Suzanne Connell

Jessica Cross

Kat Frederick

Lindsey Friedlund

Lindsey Rickert

Jen Schneider

Kelsey Stevenson

FRESHMAN CHEERLEADERS

Jasmine Abdullah

Holland Baxley

Lyndsey Belbeck

Kristi Burrows

Amber Conrade

Amy Gates

Casey Kestler

Chantel McGrath

Katie Mraz

Tana Pekarek

Leanne Piette

Ashley Trimble

Alyssa Werner

Katie Wilharm

CONFERENCE

Lake

SECTION

6AAA

MISSION: POSSIBLE

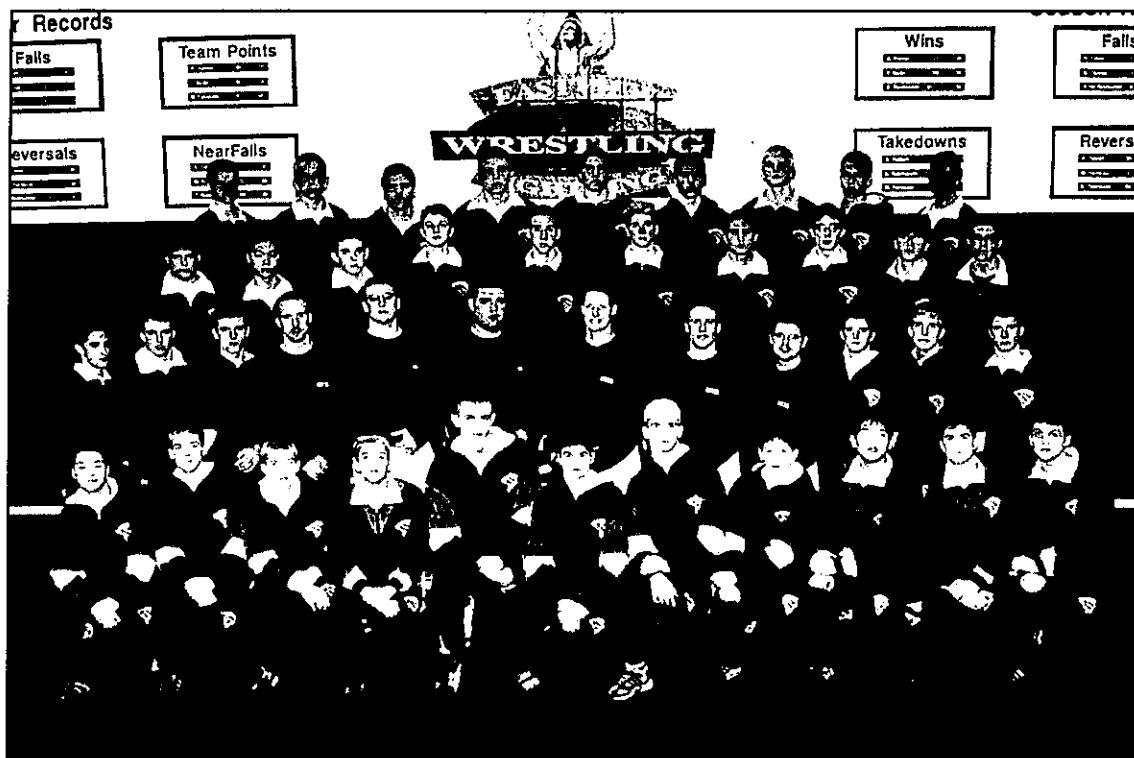

By Nick Fornicoia

Eastview Wrestling's program motto is **Commitment to Excellence**. Each year the seniors and the coaches get together to come up with a season motto that reflects the ideals of commitment to excellence and the goals of the upcoming season. This year's motto is **Mission: Possible**.

What does Mission: Possible mean?

Mission: Each individual's mission will vary. One wrestler's goal or mission could be to win 50% of his matches on Junior Varsity. Another's could be to make the Varsity team while another's could be to make it to the State Tournament. Whatever your ultimate goal is, your mission can be summed up in one sentence: **Be The Best You Can Be!** This is all you can ask of yourself and it is all that we ask of you.

Possible: In order to accomplish your mission to be the best you can be you need to make it possible. The way to make it possible is through hard work, goal setting, and doing the little things.

Working hard everyday will make your mission possible. You need to work hard even when you don't feel like it.

Setting goals is important in a facets of life and wrestling is no different. Everyone has their big goals, but you need to set short term goals that will help you reach your big long-term goal. For example, if you want to make the Varsity team you will need to have a takedown to both sides, so your short term goal would be to work on your single leg to your left.

In addition, doing the little things will make your mission possible. The little things included doing every push-up correctly, running as hard as you can, working with a coach after practice, and being a student of wrestling.

Everyone out for wrestling has the **mission** to be the best they can be and this mission will be made **possible** if you work hard, set goals and do the little things.

Are you willing to make your **Mission Possible**?

EASTVIEW
M:P 2002
WRESTLING

MINNESOTA

State Academic Champions

WRESTLING

2002

Guillotine

MN Coaches Association



TEAM 2002 RECOGNITION

LETTER WINNERS

Tyler Cookas	EV
Steve Davis	EV - EV - EV
Pat Dea	EV - EV
Kevin Eich	EV - EV
Jeremiah Foertsch	EV
Mikey Fornicoia	EV - EV - EV - EV
John Getzke	EV - EV - EV
Mic Hale	EV
Wade Halvorsen	EV
Nate Kocer	EV
Ryan Langlais	EV - EV - EV
Kevin McBride	EV
Eric Lemm	EV - EV - EV
David Pudwill	EV - EV
Chris Shuck	EV - EV - EV
Jud Turk	EV - EV
James Voyles	EV - EV

MANAGERS

Taryn Noll	EV
Kari Okonek	EV - EV



ALL - CONFERENCE

Steve Davis
Mikey Fornicoia
Eric Lemm
Kevin McBride

ALL - CONFERENCE HONORABLE MENTION

John Getzke
Nate Kocer
Ryan Langlais
Jud Turk

STATE QUALIFIER

Mikey Fornicoia - 6th place
Steve Davis
Ryan Langlais

LAKE CONFERENCE RECORDS 2001 - 2002

School	Won	Lost	Tie
Apple Valley	9	0	
Burnsville	8	1	
Rosemount	7	2	
Eastview	6	3	
Lakeville	5	4	
Kennedy	4	5	
Eden Prairie	3	6	
Eagan	2	7	
Chaska	1	8	
Jefferson	0	9	

2001 - 2002 SEASON AWARDS

ACADEMIC CLUB - GOLD

Brian Barta	Jerod Lass
Kane Bechstein	Eric Lemm
Thomas Chies	Kurt McCue
Kevin Eich	Taryn Noll
Jeremiah Foertsch	Scott Polansky
Kyle Fokken	David Pudwill
Mikey Fornicoia	Melanie Putnam
John Getzke	Ryan Ruckdashel
Mic Hale	Chris Shuck
Graham Johnson	Jesse Stapp
Tyson Johnson	Jud Turk
Fred Hwang	Sam Voyles
Dan Kurdziel	Cory Wagner

3 - D CLUB MEMBERS

Kyle Fokken
 Mikey Fornicoia
 John Getzke
 Ryan Langlais
 Eric Lemm
 Kevin McBride
 Chris Shuck
 Cory Wagner

WRESTLING SET-UP KING

ACADEMIC CLUB - SILVER

Justin Brookman	Michele Nelson
Andrew Choi	Kari Okonek
Tyler Cookas	Kate Peterson
Steve Davis	Jake Rains
Dan Hildebrandt	Christina Spelman
Ryan Langlais	Brian Wallenta
Andrew Lenertz	Kyle Wilson
Ryan Maas	

WRESTLING GAMES CHAMPION

JOHN RODIN SERVICE AWARD

	<u>Most Falls</u>	<u>Most Takedowns</u>	<u>Most Team Points</u>
Varsity	Kevin McBride - 21	Ryan Langlais - 79	Mikey Fornicoia - 160
JV	Andrew Lenertz - 18	David Pudwill - 42	Andrew Lenertz - 175
Freshman	Michael Lebeis - 11	Michael Lebeis - 28	Sam Voyles - 113

- Most Valuable Varsity Wrestler of the Year** _____
- Most Valuable Junior Varsity Wrestler of the Year** _____
- Most Valuable Freshman Wrestler of the Year** _____
- Most Improved Wrestler of the Year** _____
- Lightning Award** _____
- Junior Varsity - Varsity Drill Partner Award** _____
- Freshman Drill Partner Award** _____



Wrestling Manager Hall of Fame

Each wrestling manager inductee has successfully graduated from Eastview High School and demonstrated a tremendous commitment and work ethic to the sport and to the Eastview Wrestling program.

Erinn Roos
Class of 2000

Rachel Davis
Class of 2001

John Rodin Service Award

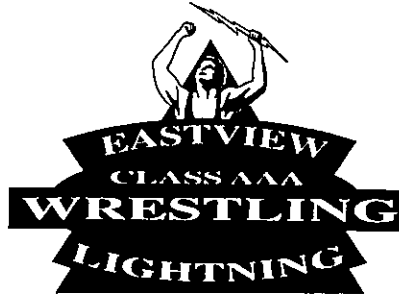

*In memory of John Rodin
and his life long commitment
to the sport of wrestling.*

This award winner is a person who has shown great commitment to the Eastview Wrestling program as well as to the youth programs in the Eastview Community.

Brad Okonek
1998

Brad Okonek
1999

Andrew Lenertz
2000

John Getzke
2001

2002

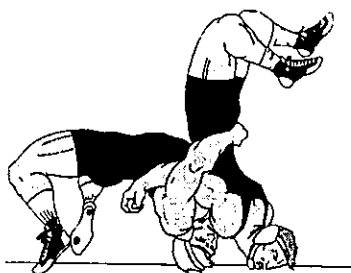

VARSITY DUAL MEET RESULTS

2001 – 2002

Overall Record: 16 Wins – 9 Losses
Lake Conference Record: 6 Wins – 3 Losses

Eastview vs			
Eastview	St. Paul Central	51 - 12	Win
Quad.	Richfield	56 - 15	Win
	Farmington	34 - 32	Win
	Bloomington Jefferson	43 - 18	Win
Coon Rapids	St. Paul Central	53 - 15	Win
Duals	Coon Rapids	19 - 34	Loss
	Rosemount	21 - 43	Loss
	New Prague	30 - 23	Win
	Tartan	51 - 14	Win
	Eagan	66 - 10	Win
	Eden Prairie	41 - 27	Win
	Prescott, WI	58-12	Win
	Wayzata	30 - 21	Win
	Somerset, WI	49 - 18	Win
	Bloomington Kennedy	33 - 21	Win
	Chaska	57 - 15	Win
Lightning	Faribault	43 - 25	Win
Invitational	Paynesville	19 - 33	Loss
	Coon Rapids	25 - 27	Loss
	Lakeville	34 - 17	Win
	Burnsville	16 - 36	Loss
	Apple Valley	12 - 52	Loss
	Centennial	16 - 47	Loss
	Rosemount	21 - 25	Loss
Team	Bloomington Kennedy	22 - 29	Loss
Sections			
Team	Coon Rapids Duals		4 th Place
Tournaments	Lightning Invitational		4 th Place
Individual	Faribault Invitational		3 rd Place
Tournaments	Burnsville Invitational		2 nd Place
	Brookings, SD Invitational		3 rd Place

VARSITY TEAM TOURNAMENT RESULTS

2001 – 2002

Coon Rapids Duals – 4th Place

Coon Rapids	1 st
Brainard	2 nd
Rosemount	3 rd
Eastview	4 th
Becker	5 th
Woodbury	6 th
St Paul Central	7 th
New London Spicer	8 th
Richfield	9 th

Lightning Invitational – 4th Place

Paynesville	1 st
Dassel Cokato	2 nd
Coon Rapids	3 rd
Eastview	4 th
Faribault	5 th
Eden Prairie	6 th
Winona	7 th
Prior Lake	8 th

Section 6AAA Tournament

Bye
Bloomington Kennedy 22 - 29 Loss

VARSITY INDIVIDUAL TOURNAMENT RESULTS

Faribault – 3rd Place

125	Kevin McBride	2 nd
135	Steve Davis	2 nd
152	John Getzke	2 nd
160	Ryan Langlais	2 nd
171	Nate Kocer	2 nd
112	Kevin Eich	3 rd
135	Mikey Fornicoia	3 rd
189	Eric Lemm	3 rd
275	James Voyles	3 rd
145	Jud Turk	4 th
119	Pat Dea	5 th
189	David Pudwill	5 th
145	Andrew Lenertz	5 th
145	Tyler Cookas	6 th
171	Chris Shuck	6 th

Burnsville – 2nd Place

130	Mikey Fornicoia	1 st
275	James Voyles	1 st
135	Steve Davis	2 nd
152	John Getzke	2 nd
152	Ryan Langlais	2 nd
189	Eric Lemm	2 nd
112	Pat Dea	3 rd
125	Jeremiah Foertsch	3 rd
160	Chris Shuck	3 rd
171	Nate Kocer	4 th
119	Kevin McBride	5 th

Brookings – 3rd Place

275	David Pudwill	1 st
125	Mikey Fornicoia	2 nd
119	Kevin McBride	3 rd
145	John Getzke	3 rd
215	James Voyles	3 rd
112	Pat Dea	4 th
130	Steve Davis	4 th
160	Chris Shuck	4 th
152	Ryan Langlais	5 th
189	Eric Lemm	5 th
103	Kevin Eich	6 th
171	Nate Kocer	8 th

Section 6AAA Tournament - 3rd Place

130	Mikey Fornicoia	1 st
135	Steve Davis	2 nd
152	Ryan Langlais	2 nd
119	Kevin McBride	3 rd
125	Jeremiah Foertsch	3 rd
171	Nate Kocer	3 rd
275	James Voyles	3 rd
103	Kevin Eich	4 th
145	John Getzke	4 th
160	Chris Shuck	4 th
112	Pat Dea	6 th
140	Jud Turk	6 th

Section 6AAA Individual Tournament

<u>Rank</u>	<u>School</u>	<u>Points</u>
1 st	Apple Valley	277.5
2 nd	Burnsville	205.5
3 rd	Eastview	184.0
4 th	Rosemount	166.0
5 th	Bloomington Kennedy	131.5
6 th	Eagan	85.5
7 th	Bloomington Jefferson	82.0
8 th	Richfield	61.0
9 th	Minneapolis SW	19.0
10 th	Minneapolis Washburn	13.0
11 th	Edina	4.0

State Tournament

130	Mikey Fornicoia	6 th	(2-3)
135	Steve Davis	DNP	(0-2)
152	Ryan Langlais	DNP	(1-2)

VARSIY STATISTICS

Wrestler	Win	Loss	TD	E	R	NF2	NF3	MAJ.	T.F.	Pin	Team Points
Tyler Cookas	6	6	15	5	4	6	4	1	0	2	28
Steve Davis	27	12	59	10	12	14	14	4	1	6	107
Pat Dea	18	17	31	12	17	10	12	1	2	5	83
Kevin Eich	17	17	31	36	10	2	5	2	1	5	79
Jeremiah Foertsch	11	16	18	24	13	6	10	1	0	8	58
Mikey Fornicoia	36	6	65	28	24	34	45	7	9	7	160
John Getzke	26	13	46	18	16	5	18	1	1	18	140
David Grogg	0	4	0	3	0	0	0	0	0	0	0
Wade Halvorsen	1	0	1	0	1	0	0	0	0	1	6
Nathan Kocer	20	14	21	46	28	8	8	0	0	17	111
Ryan Langlais	28	14	79	30	12	5	15	5	1	8	118
Eric Lemm	22	14	29	34	7	2	7	2	1	6	94
Andrew Lenertz	1	2	4	5	1	0	0	0	0	1	6
Kevin McBride	27	14	47	34	38	15	28	1	3	18	142
Kurt McCue	0	1	0	0	0	0	0	0	0	0	0
David Pudwill	7	4	7	13	0	0	1	0	0	1	27
Chris Shuck	19	20	38	40	2	4	6	0	1	6	77
Jud Turk	16	17	33	31	5	7	10	3	0	4	63
James Voyles	25	12	44	33	4	1	5	1	0	7	103

	Win	Loss	TD	E	R	NF2	NF3	MAJ.	T.F.	Falls	Team Points
Eastview Team Totals	307	203	568	402	194	119	188	29	20	120	1402
Opponents Totals	203	307	502	337	173	58	134	30	5	63	837

EASTVIEW WRESTLING M:P 2002

Team	32 Team Points	29 Falls	7 Wins	18 Takes Downs	10 Near Falls	2H 3rd Period	Forfeits Falls	Forfeits Major	Total Goals
SPRINGFIELD	51	4	11	21	10	22:19	1	0	7
BRIDGEPORT	56	4	10	9	10	8:5	1	0	6
BERKINGTON	34	4	6	12	5	11:19	2	2	2
DEERPERSON	43	4	9	18	14	28:14	1	1	8
SLEEPER CENTRAL	53	8	10	15	7	4:6	1	0	5
COONTRAPIDS	19	1	5	11	6	20:13	2	1	1
ROSEMOUNT	21	2	5	6	1	6:13	4	1	1
NEWPRAGUE	30	2	8	16	2	22:24	1	2	2
LEAVAN	51	6	10	15	8	19:9	1	0	6
LAGAN	66	9	11	7	1	4:6	0	1	5
EDENTRAIRIE	41	6	8	24	14	25:17	3	0	6
PERSCOTT/AMI	58	6	11	20	15	23:2	1	0	8
WAVZATA	30	2	8	17	11	25:8	1	0	5
SOMERSET/AMI	49	7	9	13	14	12:6	1	0	7
KENNEDY	33	3	8	21	4	26:18	0	0	5
CHASKA	51	9	10	30	17	20:9	2	0	7
PARIS/AMT	43	5	8	17	12	24:11	3	1	6
PAINESVILLE	19	0	6	16	6	21:21	3	1	1
COONTRAPIDS	25	1	7	15	9	21:23	2	2	1
LEAVERTHILL	34	3	8	16	7	20:20	1	0	4
BURNSVILLE	16	1	4	8	7	10:15	1	2	1
HAPPY VALLEY	12	2	2	3	0	6:33	3	3	0
CLENTON/JAI	16	1	4	11	4	12:4	5	2	1
ROSEMOUNT	21	1	6	13	8	15:22	1	1	2
KENNEDY	21	2	5	10	6	11:20	1	2	1

JV DUAL MEET RESULTS

2001 – 2002

Overall Record: 18 Wins – 6 Losses

Lake Conference Record: 7 Wins – 2 Losses

<u>Eastview</u>	vs			
Eastview		St. Paul Central	54 - 18	Win
Quad		Richfield	55 - 18	Win
		Farmington	66 - 6	Win
		Bloomington Jefferson	58 - 0	Win
Coon Rapids		Brainerd	58 - 18	Win
Invitational		Coon Rapids	41 - 13	Win
2 nd Place		Rosemount	18 - 54	Loss
		New Prague	34 - 31	Win
		Tartan	40 - 12	Win
		Eden Prairie	51 - 18	Win
		Eagan	39 - 12	Win
		Prescott, WI	56 - 12	Win
		Wayzata	37 - 12	Win
		Somerset, WI	60 - 3	Win
		Blooming Kennedy	36 - 31	Win
		Chaska	63 - 6	Win
Lightning		Faribault	42 - 18	Win
Invitational		Paynesville	30 - 42	Loss
4 th Place		Coon Rapids	20 - 45	Loss
		Lakeville	31 - 27	Win
		Burnsville	39 - 31	Win
		Apple Valley	3 - 64	Loss
		Centennial	21 - 49	Loss
		Rosemount	18 - 41	Loss

INDIVIDUAL TOURNAMENTS

Faribault - 3rd Place

Central Lake Conference, SD - 4th

Northfield - 3rd Place

JUNIOR VARSITY INDIVIDUAL TOURNAMENT RESULTS

2001 - 2002

Faribault – 3rd Place

Eric Anderson	1 st
Jeremiah Foertsch	1 st
Kyle Fokken	1 st
Dan Kurdziel	3 rd
Cory Wagner	3 rd
Brian Wallenta	3 rd
Randy Price	3 rd
Alex Pattie	4 th
Jesse Stapp	4 th
Kris Carson	4 th
Wade Halvorsen	4 th
David Grogg	5 th
Mic Hale	5 th
Jake Rains	6 th
Graham Johnson	6 th

Burnsville

Kyle Fokken	1 st
David Grogg	1 st
Jake Rains	1 st
Andrew Lenertz	1 st
Kurt McCue	1 st
Mic Hale	1 st
David Pudwill	1 st
Kevin Eich	1 st
Andrew Choi	2 nd
Jesse Stapp	2 nd
Cory Wagner	2 nd
Eric Anderson	3 rd
Fred Hwang	3 rd
Graham Johnson	3 rd
Kris Carson	3 rd

Northfield – 3rd Place

David Pudwill	1 st
Andrew Lenertz	2 nd
Kevin Eich	2 nd
Kurt McCue	2 nd
Kyle Fokken	3 rd
David Grogg	3 rd
Jeremiah Foertsch	3 rd
Andrew Choi	5 th
Fred Hwang	6 th
Cory Wagner	6 th
Kris Carson	6 th

Armstrong

Kyle Fokken	1 st
Adam Theisen	1 st
Ty Cookas	1 st
Fred Hwang	2 nd
Kris Carson	2 nd
David Grogg	3 rd
Cory Wagner	3 rd
Andrew Lenertz	3 rd
Matt Johnson	3 rd
Andrew Choi	7 th
Dan Kurdziel	7 th
Alex Pattie	7 th
Jesse Stapp	7 th
Brian Barta	7 th

Lake Central Conference, SD - 4th Place

Jeremiah Foertsch	1 st
Fred Hwand	2 nd
Jesse Stapp	2 nd
Eric Anderson	3 rd
Kyle Fokken	3 rd
Jake Rains	3 rd
Cory Wagner	3 rd
Kurt McCue	3 rd
Wade Halvorsen	3 rd
Mic Hale	4 th

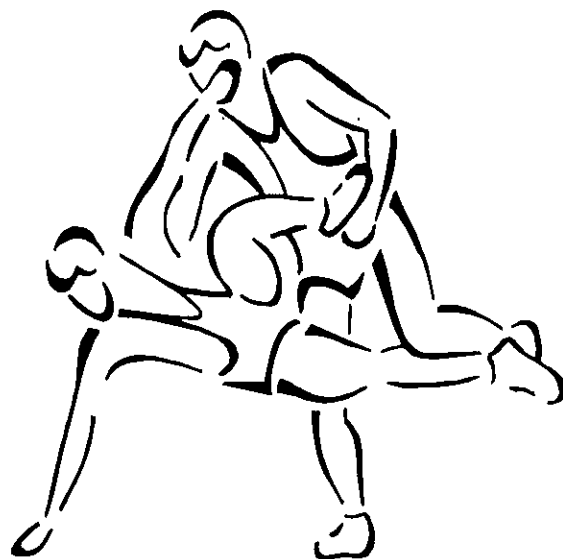

JUNIOR VARSITY STATISTICS

Wrestler	Win	Loss	TD	E	R	NF2	NF3	MAJ.	T.F.	Pin	Team Points
Eric Anderson	5	4	6	2	2	1	3	0	0	4	27
Brian Barta	1	7	2	8	2	0	0	0	0	1	6
Justin Brookman	5	4	4	3	5	1	4	0	0	2	30
Kris Carson	12	9	17	19	11	3	6	1	0	6	58
Thomas Chies	2	1	2	3	0	0	0	0	0	2	12
Andrew Choi	9	14	16	8	2	2	7	0	0	5	51
Tyler Cookas	8	0	18	2	8	6	7	2	1	3	37
Kevin Eich	7	2	6	8	4	4	5	2	0	1	34
Jeremiah Foertsch	13	1	21	5	11	10	8	3	1	4	62
Kyle Fokken	26	4	39	3	16	15	24	2	2	12	139
David Grogg	25	8	29	2	8	2	11	0	0	18	147
Mic Hale	18	6	29	9	4	4	4	1	0	8	91
Wade Halvorsen	15	10	16	16	10	5	9	2	0	6	86
Randy Hanuman	2	2	1	1	0	0	0	0	0	1	12
Fred Hwang	9	7	13	13	4	2	1	0	0	5	42
Graham Johnson	1	8	0	1	1	0	0	0	0	0	6
Matt Johnson	2	1	1	0	1	2	0	0	0	2	12
Nathan Kocer	7	0	6	0	2	3	2	1	0	2	40
Dan Kurdziel	6	12	7	9	3	1	2	0	0	3	36
Andrew Lenertz	31	8	35	10	13	4	6	1	0	18	175
Ryan Mass	1	0	0	0	0	0	0	0	0	0	6
Kurt McCue	19	10	24	5	19	6	16	2	2	7	99
Alex Pattie	3	13	4	0	0	3	1	0	0	2	18
Randy Price	1	3	3	2	2	0	0	0	0	1	6
David Pudwill	28	0	42	15	3	2	10	4	0	12	139
Jake Rains	8	14	8	4	3	1	3	0	1	3	47
Jesse Stapp	7	14	8	11	2	0	0	0	0	2	39
Adam Theisen	3	4	2	2	4	0	0	0	0	1	18
Sam Voyles	6	4	6	1	2	1	2	0	0	3	36
Cory Wagner	19	13	18	10	9	6	3	0	0	10	108
Brian Wallenta	7	9	6	3	3	4	1	0	0	1	36

	Win	Loss	TD	E	R	NF2	NF3	MAJ.	T.F.	Falls	Team Points
Eastview Team Totals	306	192	389	175	154	88	135	21	7	145	1655
Opponents Totals	192	306	336	182	130	47	113	14	4	127	982

FRESHMAN DUAL MEET RESULTS

2001 – 2002

Overall Record: 10 Wins – 10 Losses

Section Record: 4 Wins – 2 Losses

Eastview	vs			
		Eden Prairie	50 - 24	Win
		Coon Rapids	38 - 34	Win
Eastview		Faribault	37 - 36	Win
Duals		Owatonna	21 - 60	Loss
6 th Place		Totino - Grace	17 - 53	Loss
		Lakeville	40 - 45	Loss
		Lakeville	42 - 29	Win
		Apple Valley	15 - 53	Loss
Rosemount		Rosemount	39 - 48	Loss
Duals		Eden Prairie	48 - 36	Win
3 rd Place		Owatonna	18 - 69	Loss
Team		Eagan	61 - 6	Win
Section		St. Thomas	63 - 18	Win
3 rd Place		Woodbury	66 - 12	Win
		Rosemount	39 - 48	Loss
		Hastings	26 - 56	Loss
		Simley	63 - 24	Win
State		Hutchinson	48 - 18	Win
Dual		BOLD	59 - 13	Loss
Tournament		Cambridge-Isanti	41 - 32	Loss

FRESHMAN INDIVIDUAL TOURNAMENT RESULTS

<u>Burnsville</u>		<u>Northfield</u>	
Kane Bechstein	1 st	Ryan Ruckdassel	4 th
Michael Lebeis	1 st	Ben Polansky	6 th
Scott Polansky	2 nd		
Alex Lemaire	3 rd		
Dana Vorachek	3 rd		
Allen Hudspeth	4 th		
Terry Sheridan	4 th		
Kyle Wilson	4 th		
Matt Johnson	5 th		
Tyson Johnson	5 th		
Ben Polansky	5 th		
Ryan Ruckdassel	5 th		
Ryan Maas	6 th		
Steve McMoore	6 th		
Thomas Chies	7 th		
Tim Mills	7 th		
John Reiners	7 th		
Dan Hildebrandt	8 th		

9th Grade Regional – 3rd Place

Tyler Cookas	1 st
Sam Voyles	1 st
Thomas Chies	3 rd
Scott Polansky	3 rd
Kyle Fokken	3 rd
Matt Johnson	4 th
Ryan Maas	4 th
Steve McMoore	4 th
Ryan Ruckdassel	4 th
Kyle Wilson	4 th



FRESHMAN STATISTICS

Wrestler	Win	Loss	TD	E	R	NF2	NF3	MAJ.	T.F.	Pin	Team Points
Kane Bechstein	10	4	15	1	7	1	10	0	0	7	54
Justin Brookman	5	9	9	4	1	2	0	0	0	3	24
Nathan Carroll	1	2	1	3	0	0	0	0	0	1	6
Thomas Chies	12	14	15	12	8	3	4	0	0	6	53
Tyler Cookas	15	1	21	5	2	4	6	0	0	5	65
Chad Eul	0	1	1	0	0	0	0	0	0	0	0
Ben Foertsch	3	3	2	3	1	0	0	0	0	3	18
Troy Fokken	7	3	13	0	3	1	1	0	0	4	40
Josh Gonzalas	4	11	2	4	2	0	1	0	0	1	24
Dan Hildebrandt	3	8	5	2	0	1	2	0	0	1	18
Allen Hudspeth	3	1	1	0	1	0	1	0	0	1	18
Matt Johnson	8	8	7	4	9	0	3	0	0	6	48
Tyson Johnson	6	5	6	0	3	1	2	0	0	1	28
Jerod Lass	4	1	4	1	1	0	1	0	0	2	24
Michael Lebeis	17	3	28	6	4	2	13	0	0	11	78
Alex Lemaire	2	1	2	1	1	0	1	0	0	2	12
Ryan Mass	6	7	8	2	2	0	3	0	0	6	36
Stephan McMoore	8	6	12	9	2	1	2	0	0	5	42
Tim Mills	6	4	2	0	0	0	0	0	0	1	36
Matt Nuetz	2	1	2	0	1	0	1	0	0	2	12
Jake Nuetz	2	6	3	3	1	0	1	0	0	2	12
Ben Polansky	9	4	5	3	7	2	2	0	0	4	51
Scott Polansky	14	5	23	12	5	3	5	0	0	5	66
John Reiners	3	5	6	2	5	0	0	0	0	1	12
Ryan Ruckdashel	14	5	17	7	0	1	5	0	0	9	54
Terry Sheridan	2	2	4	1	0	0	1	0	0	2	12
Ryan Stephen	1	11	3	4	0	0	0	0	0	0	3
Dana Vorachek	4	1	4	0	1	0	0	0	0	4	0
Sam Voyles	21	4	27	6	5	10	8	1	0	10	113
Kyle Wilson	10	6	6	3	4	0	0	0	0	3	60

	Win	Loss	TD	E	R	NF2	NF3	MAJ.	T.F.	Falls	Team Points
Eastview Team Totals	202	142	254	98	76	32	73	1	0	108	1019
Opponents Totals	142	202	246	79	84	27	75	2	0	94	643

Wrestlers of the Week

Varsity

Pat Dea
Kevin Eich
James Voyles
Nathan Kocer
Mikey Fornicoia
Kevin McBride
Judson Turk
David Pudwill
Chris Shuck
John Getzke
Eric Lemm
Steve Davis
Jeremiah Foertsch
Mikey Fornicoia
Steve Davis
Ryan Langlais

Junior Varsity

Andrew Lenertz
David Pudwill
Jeremiah Foertsch
David Grogg
Jake Rains
Kurt McCue
Kyle Fokken
Wade Halvorsen
Brian Wallenta
Fred Hwang

9th Grade

Michael Lebeis
Scott Polansky
Sam Voyles
Tom Chies
Ryan Ruckdashel
Steve McMoore
Tyler Cookas
Matt Johnson
Sam Voyles

**EASTVIEW
M-F 2002
WRESTLING**

2001 – 2002 STATISTIC LEADERS

	Varsity		Junior Varsity		Freshman	
Wins	Mikey Fornicoia	36	Andrew Lenertz	31	Sam Voyles	21
	Ryan Langlais	28	David Pudwill	28	Michael Lebeis	17
	Kevin McBride	27	Kyle Fokken	26	Tyler Cookas	15
	Steve Davis	27				
Falls	Kevin McBride	21	Andrew Lenertz	18	Michael Lebeis	11
	John Getzke	19	David Grogg	18	Sam Voyles	10
	Nathan Kocer	17	Kyle Fokken	14	Ryan Ruckdashal	9
Team Points	Mikey Fornicoia	160	Andrew Lenertz	175	Sam Voyles	113
	Kevin McBride	142	David Grogg	147	Michael Lebeis	78
	John Getzke	140	Kyle Fokken	139	Scott Polansky	66
			David Pudwill	139		
Takedowns	Ryan Langlais	79	David Pudwill	42	Michael Lebeis	28
	Mikey Fornicoia	65	Kyle Fokken	39	Sam Voyles	27
	Steve Davis	59	Andrew Lenertz	35	Scott Polansky	23
Near Falls	Mikey Fornicoia	79	Kyle Fokken	39	Sam Voyles	18
	Kevin McBride	43	Kurt McCue	22	Michael Lebeis	15
	Steve Davis	28	Jeremiah Foertsch	18	Kane Bechstein	11
Reversals	Kevin McBride	38	Kurt McCue	19	Matt Johnson	9
	Nathan Kocer	28	Kyle Fokken	16	Thomas Chies	8
	Mikey Fornicoia	24	Andrew Lenertz	13	Ben Polansky	7
				Kane Bechstein	7	

Talent & Teamwork

VARSIITY SEASON RECORDS

FALLS

Adam Fokken	'01	28
Kevin McBride	'02	21
John Getzke	'02	19

WINS

Adam Fokken	'01	38
Mikey Fornicoia	'02	36
David Rasmussen	'01	30

TEAM POINTS

Adam Fokken	'01	200
Mikey Fornicoia	'02	160
Kevin McBride	'02	142

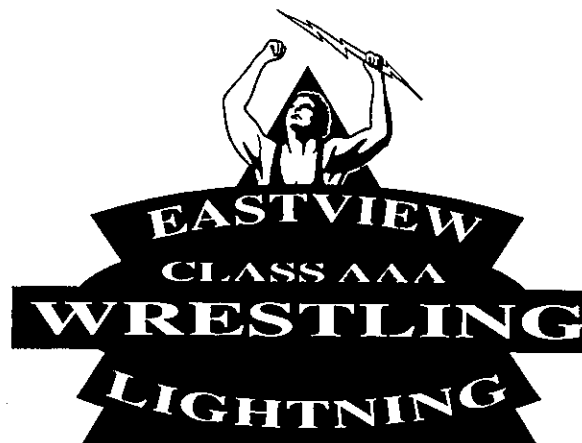

TAKEDOWNS

Adam Fokken	'01	119
David Rasmussen	'01	92
Ryan Langlais	'02	79

NEAR FALLS

Mikey Fornicoia	'02	79
Kevin McBride	'02	43
Tony Rodin	'98	32

REVERSALS

Kevin McBride	'02	38
Adam Fokken	'99	28
Mikey Fornicoia	'02	28

VARSDITY CAREER RECORDS

FALLS

Adam Fokken	'01	83
Mikey Fornicoia	'02	44
Brad Okonek	'00	33

WINS

Adam Fokken	'01	147
Mikey Fornicoia	'02	107
Tony Rodin	'99	77

TEAM POINTS

Adam Fokken	'01	727
Mikey Fornicoia	'02	491
Tony Rodin	'99	351

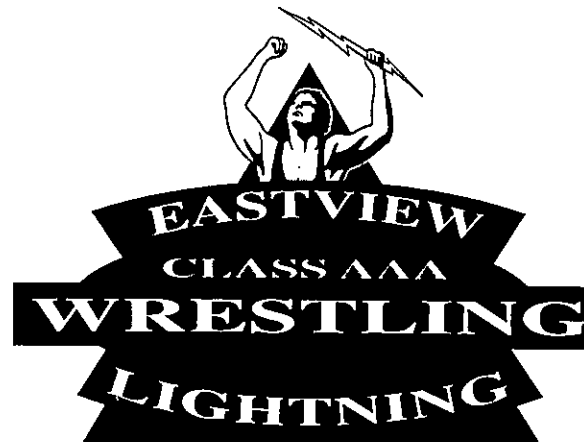

TAKEDOWNS

Adam Fokken	'01	349
Mikey Fornicoia	'02	231
Ryan Langlais	'04	186

NEAR FALLS

Mikey Fornicoia	'02	166
Adam Fokken	'01	121
Tony Rodin	'99	83

REVERSALS

Adam Fokken	'01	92
Mikey Fornicoia	'02	84
David Rasmussen	'01	43

JUNIOR VARSITY SEASON RECORDS

FALLS

Nate Kocer	'01	17
Andrew Lenertz	'02	18
David Grogg	'02	18

WINS

Andrew Lenertz	'02	31
David Pudwill	'02	28
Kyle Fokken	'02	26
James Voyles	'01	26

TEAM POINTS

Andrew Lenertz	'02	175
David Grogg	'02	147
Kyle Fokken	'02	139
David Pudwill	'02	139

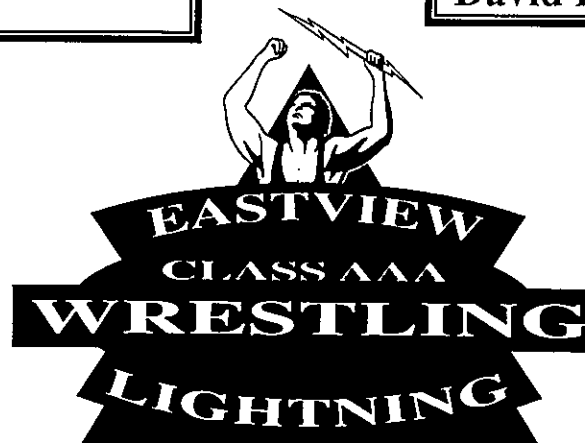

TAKEDOWNS

Eric Budd	'01	45
James Voyles	'01	44
David Pudwill	'02	42

NEAR FALLS

Kyle Fokken	'02	39
Kurt McCue	'02	22
Chris Verhaeghe	'00	19

REVERSALS

Casey Schmidt	'01	25
Nate Kocer	'01	22
Kurt McCue	'02	19

FRESHMAN SEASON RECORDS

FALLS

Bona Ku	'01	16
Kyle Fokken	'01	15
Eric Yuen	'01	13

WINS

Bryan Lewis	'00	23
Sam Voyles	'02	21
Kyle Fokken	'01	20
Bona Ku	'01	20

TEAM POINTS

Sam Voyles	'02	113
Kyle Fokken	'01	112
Bona Ku	'01	106

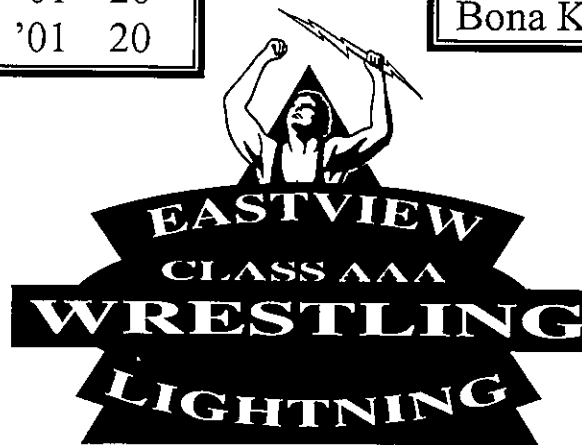

TAKEDOWNS

Bryan Lewis	'00	80
Bona Ku	'01	61
Chris Shuck	'00	43

NEAR FALLS

Kyle Fokken	'01	22
Sam Voyles	'02	18
Sean Dwyer	'01	17
Nate Kocer	'00	17

REVERSALS

Kyle Fokken	'01	17
Nate Kocer	'00	13
Jeremiah Foertsch	'01	13

EASTVIEW WRESTLER ALUMNI VARSITY CAREER STATISTICS

<u>NAME</u>	<u>YEAR</u>	<u>WINS</u>	<u>LOSSES</u>	<u>TD</u>	<u>NF</u>	<u>R</u>	<u>FALLS</u>	<u>TEAM POINTS</u>
Tony Rodin	1999	77	23	151	83	36	31	361
Brandon Jones	1999	13	20	31	18	7	5	56
Joe Theisen	1999	5	27	11	7	7	1	22
Brad Okonek	2000	49	50	84	71	24	33	255
Matt Davis	2000	44	61	76	66	25	23	204
Nate Ernst	2000	44	24	94	25	15	19	203
Adam Miller	2000	28	34	64	15	13	14	135
Nick Thompson	2000	27	21	41	23	39	13	126
Chris Verhaeghe	2000	2	3	3	2	1	1	9
Adam Fokken	2001	147	36	349	121	92	83	727
David Rasmussen	2001	66	49	154	60	43	23	298
Brian Putnam	2001	19	21	13	11	7	10	91
Adam Johnson	2001	13	45	39	16	15	7	65
Eric Budd	2001	0	1	0	0	0	0	0
Jon Hanson	2001	0	5	1	0	1	0	0
Kris Carson	2002	0	0	0	0	0	0	0
Mikey Fornicoia	2002	107	31	231	166	84	44	491
Mic Hale	2002	0	1	0	0	0	0	0
Wade Halvorsen	2002	1	0	1	0	1	1	6
Eric Lemm	2002	38	37	53	26	24	16	173
David Pudwill	2002	11	12	10	1	0	4	51

ALUMNI VARSITY RECOGNITIONS

ALL CONFERENCE

Tony Rodin (2x)
 Brad Okonek
 Nate Ernst
 Adam Fokken (4x)
 David Rasmussen
 Mikey Fornicoia (3x)

SECTIONS CHAMPIONS

Tony Rodin
 Adam Fokken
 David Rasmussen
 Mikey Fornicoia

STATE QUALIFIERS

Tony Rodin (2x) 4th Place
 Brad Okonek
 Adam Fokken (3x) 4th Place
 1st Place
 David Rasmussen
 Mikey Fornicoia (2x) 6th Place

Eastview Wrestling

The Lightning wrestlers are entering section competition.
Our goals and dreams will come to fruition!

Our motto is our creed.
The **Mission** is **Possible** if we believe!

We're gonna give it all it takes!
And then we'll dominate!

Together we will win!
'Cause we never give in!

Wrestling for the Lightning at:

103: Electric Eich

145: Great Getzke

112: Dynamite Dea

152: Lethal Langlais

119: Smokin' Smokey

160: Shockin' Shuck

125: Fearsome Foertsch

171: Krazy Kocer

130: Maulin' Mikey

189: Lightnin' Lemm

135: Smotherin' Steve

HWT: Valorous Voyles

140: Terrifyin' Turk

Xtras:

Marchin' McCue

Courageous Cookas

Poundin' Pudwill

Loomin' Lenertz

Growlin' Grogg

Flattenin' Fokken

Remember: Believe! Believe! Believe in our creed!

The Mission is Possible if you believe!

6AAA TEAM SECTIONS

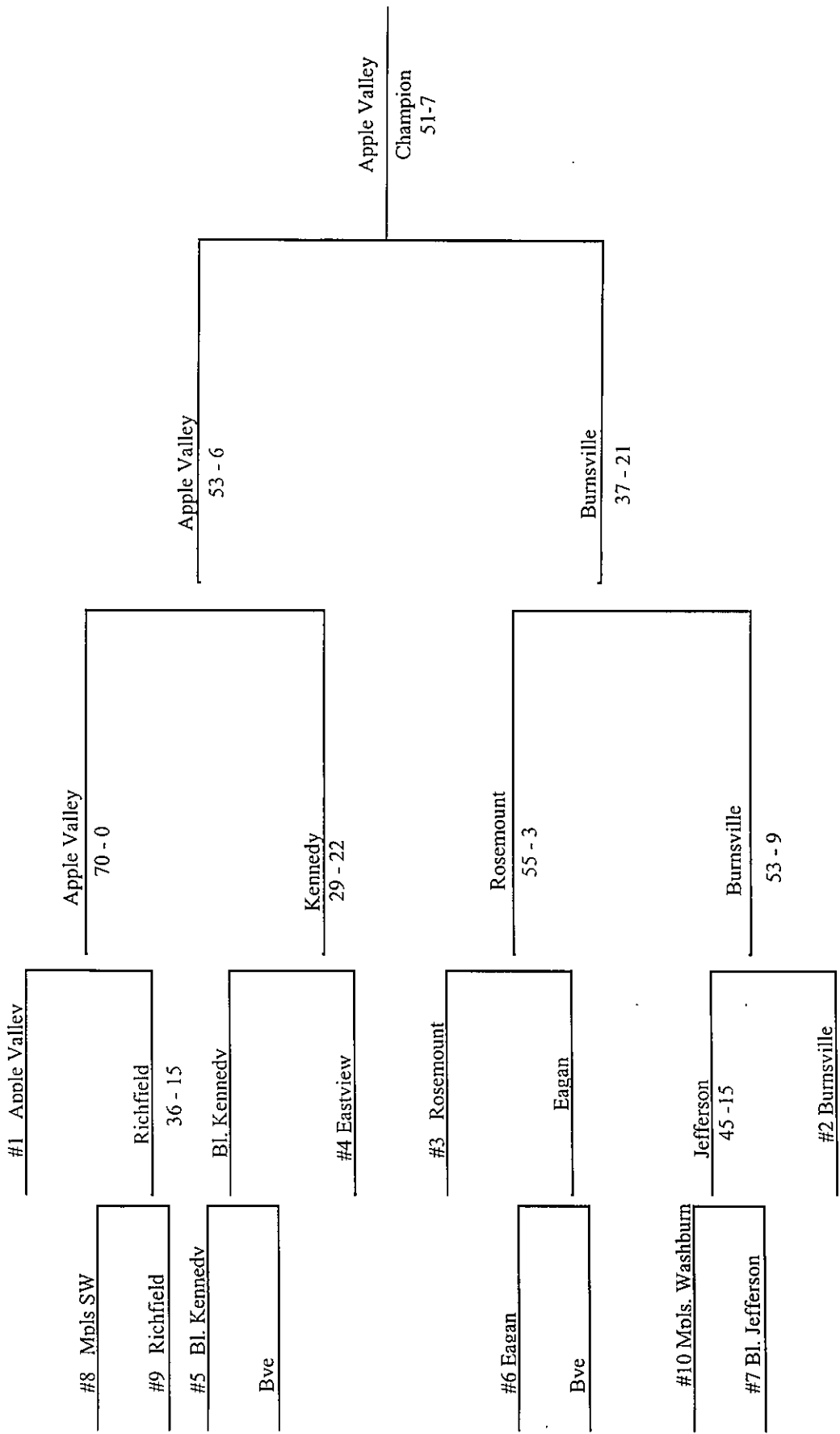

2002 Section 6AAA Individual Tournament

Championship Bracket
103 Pounds

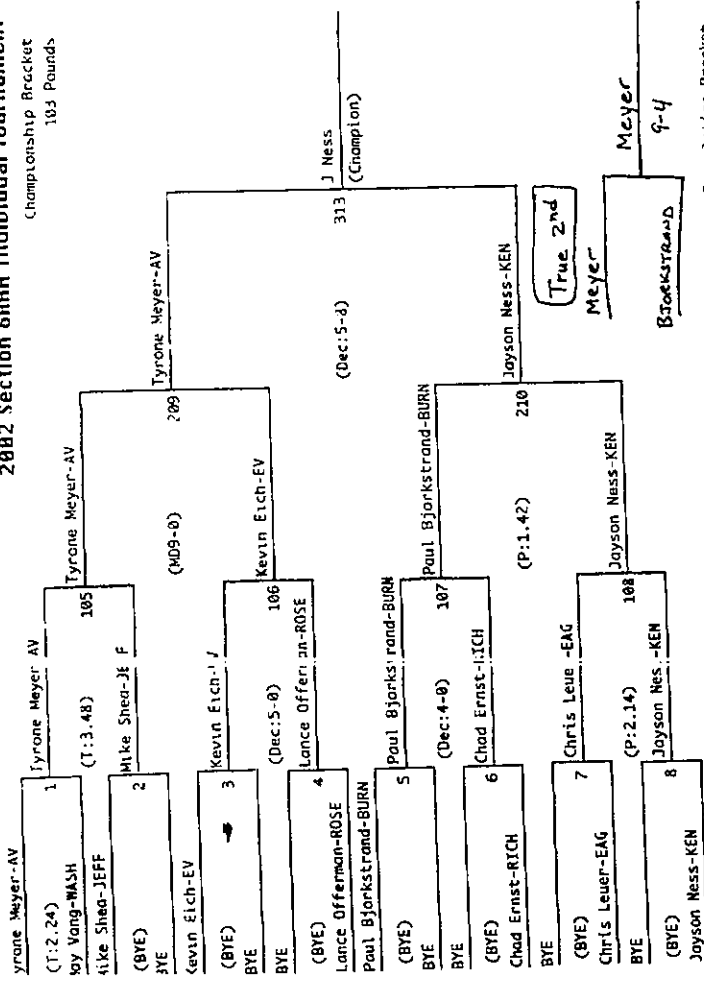

Consolation Bracket
103 Pounds

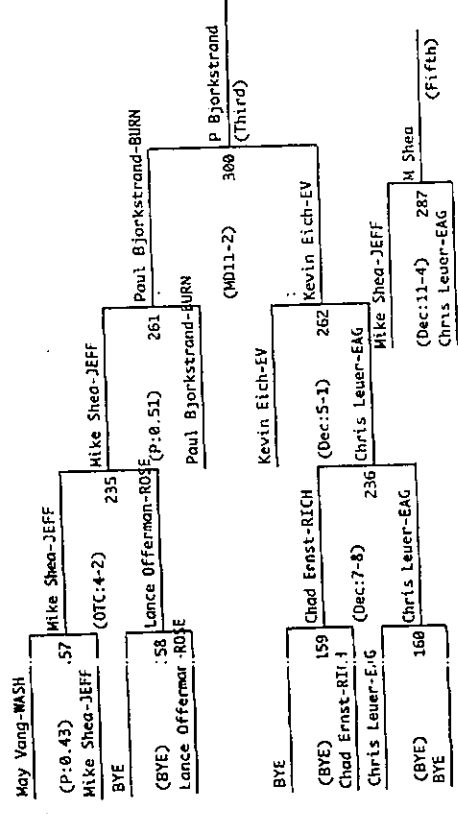

2002 Section 6AAA Individual Tournament

Championship Bracket
112 Pounds

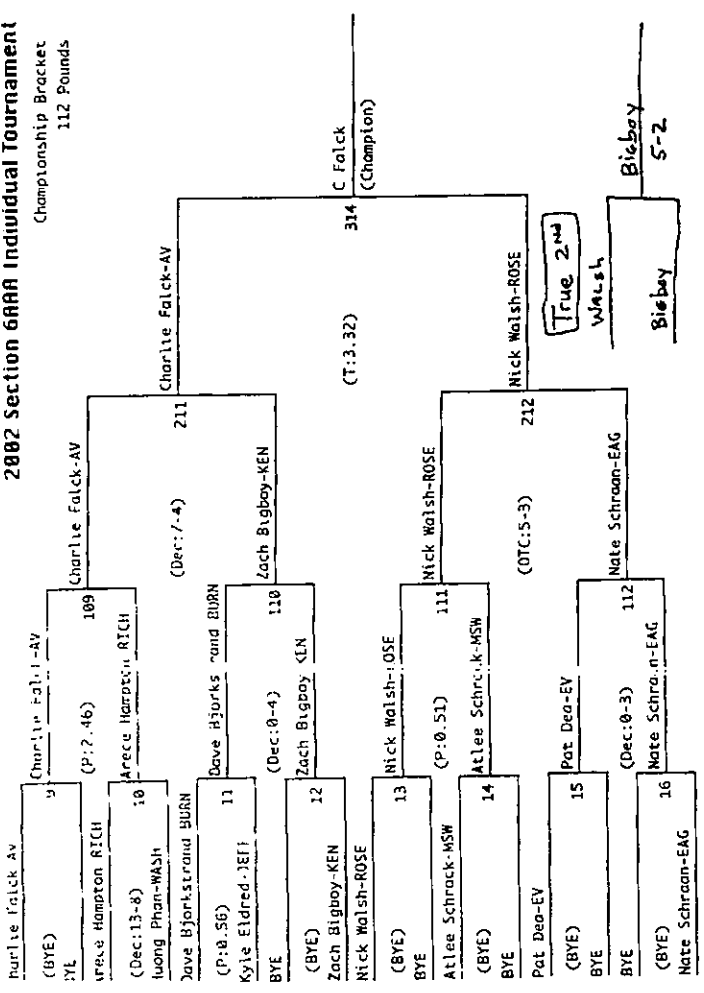

Consolation Bracket
112 Pounds

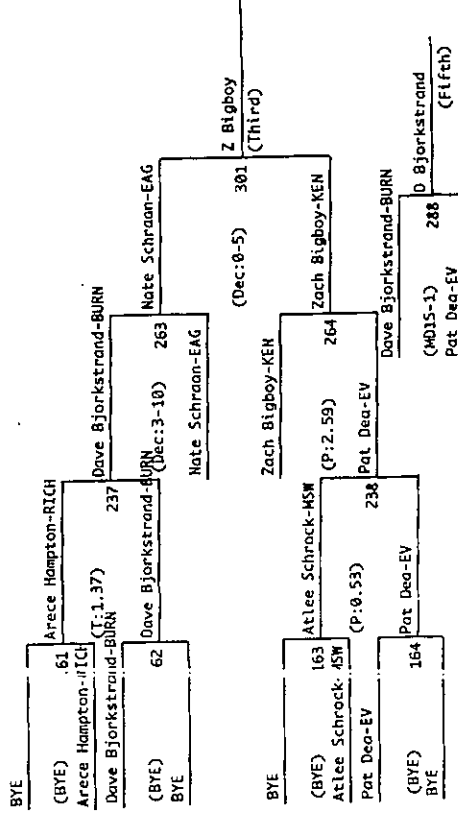

2002 Section 6AAA Individual Tournament

Championship Bracket
135 Pounds

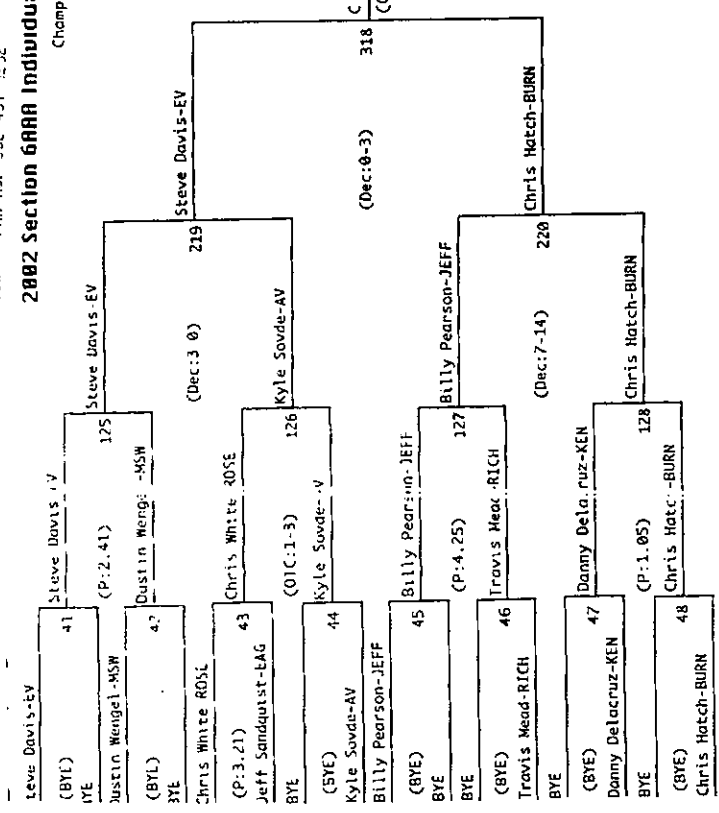

Consolation Bracket
135 Pounds

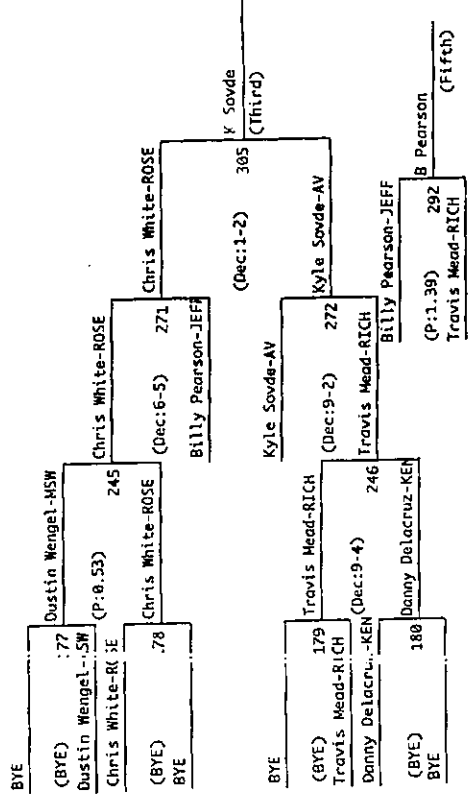

2002 Section 6AAA Individual Tournament

Championship Bracket
130 Pounds

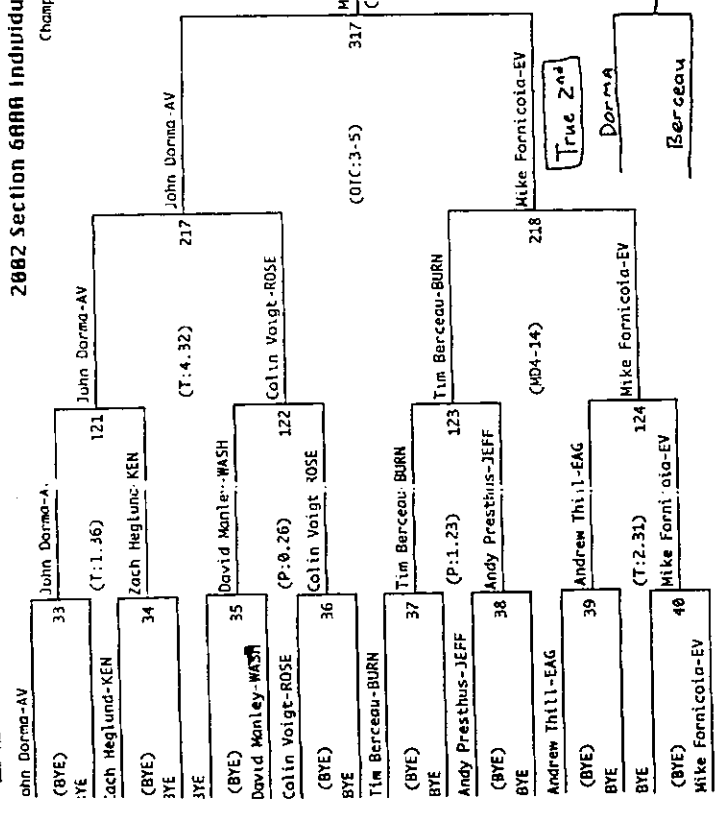

Consolation Bracket
130 Pounds

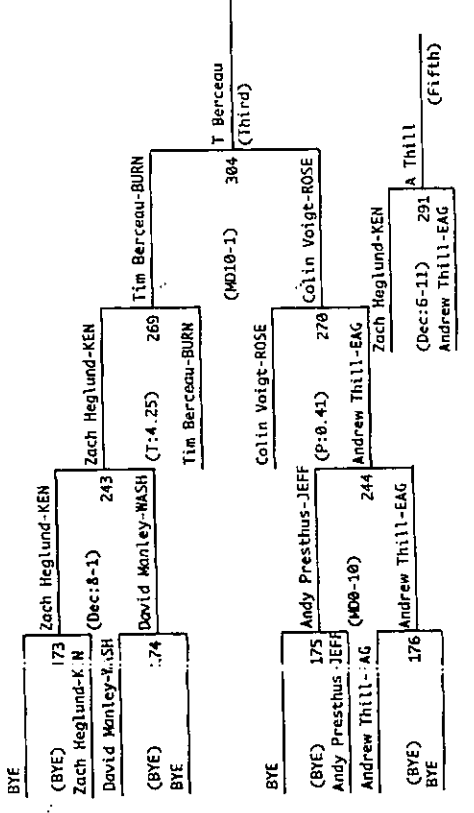

2002 Section 6AAA Individual Tournament

Championship Bracket
275 Pounds

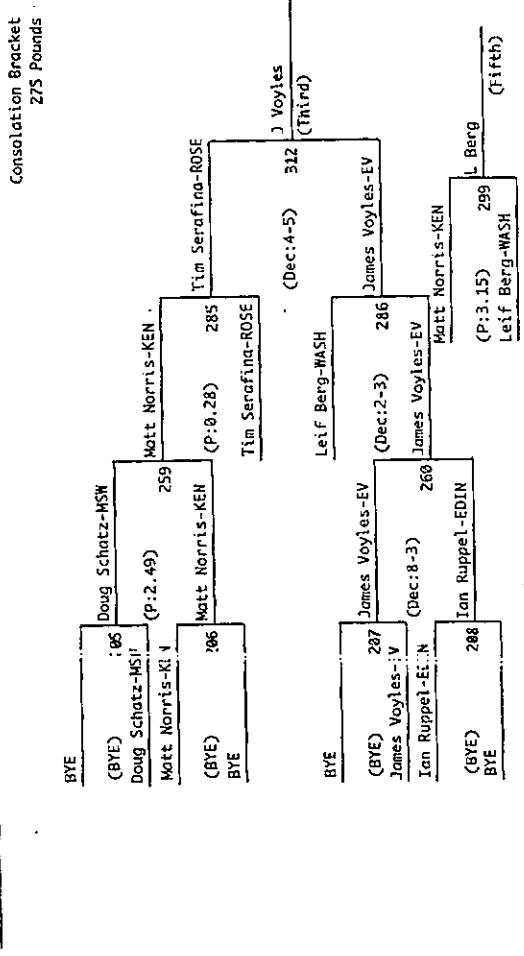
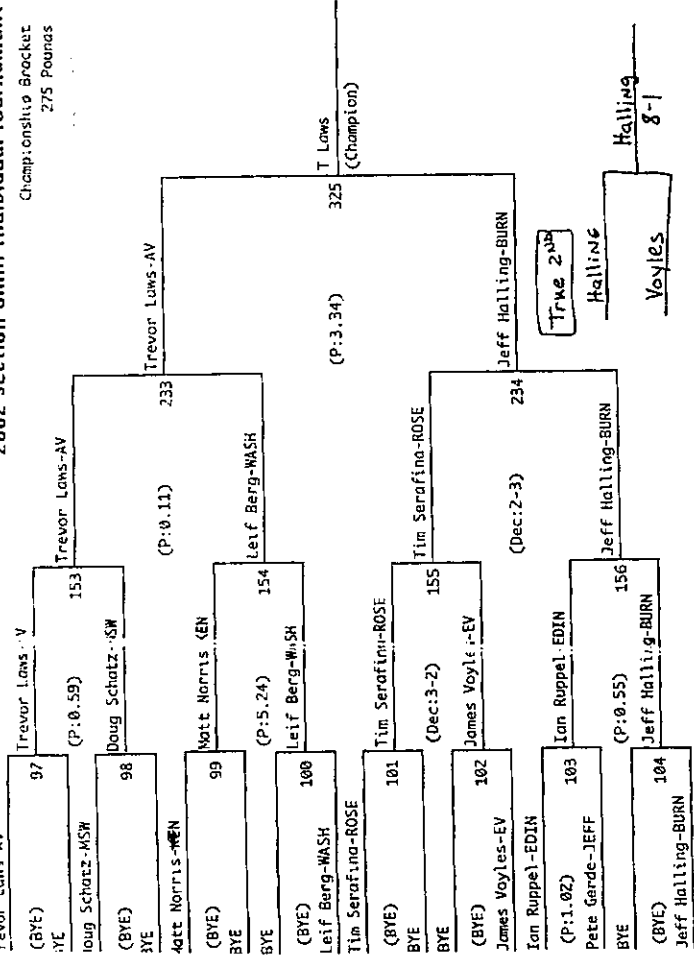

SECTION 6AAA STATE PLACE WINNERS

112	Charlie Falk	1 st	Apple Valley
119	Neil Wasmund	1 st	Apple Valley
152	Jacob Schlottke	1 st	Apple Valley
275	Trevor Laws	1 st	Apple Valley
171	Brad Bruns	2 nd	Apple Valley
103	Jayson Ness	3 rd	Bloomington Kennedy
125	Michael Fessler	3 rd	Apple Valley
140	Randy Hardman	3 rd	Burnsville
171	Matt Herman	3 rd	Burnsville
145	Ken Francois	4 th	Rosemount
103	Tyrone Meyer	5 th	Apple Valley
130	Mikey Fornicoia	6 th	Eastview
145	Joe Arrandondo	6 th	Richfield
160	Lon Welsh	6 th	Apple Valley

LAKE CONFERENCE STATE PLACE WINNERS

112	Charlie Falk	1 st	Apple Valley
119	Neil Wasmund	1 st	Apple Valley
152	Jacob Schlottke	1 st	Apple Valley
275	Trevor Laws	1 st	Apple Valley
171	Brad Bruns	2 nd	Apple Valley
103	Jayson Ness	3 rd	Bloomington Kennedy
125	Michael Fessler	3 rd	Apple Valley
140	Randy Hardman	3 rd	Burnsville
171	Matt Herman	3 rd	Burnsville
145	Ken Francois	4 th	Rosemount
103	Tyrone Meyer	5 th	Apple Valley
145	Sam Donner	5 th	Lakeville
130	Mikey Fornicoia	6 th	Eastview
152	Jared Simon	6 th	Lakeville
160	Lon Welsh	6 th	Apple Valley

130 LB. CLASS - CLASS AAA

SESSION 2 SESSION 4 SESSION 6

— CODE —
 LEG BAND AND SCOREBOARD
 RED - Upper Bracket Wrestler
 GREEN - Lower Bracket Wrestler

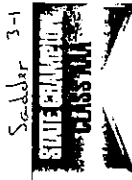
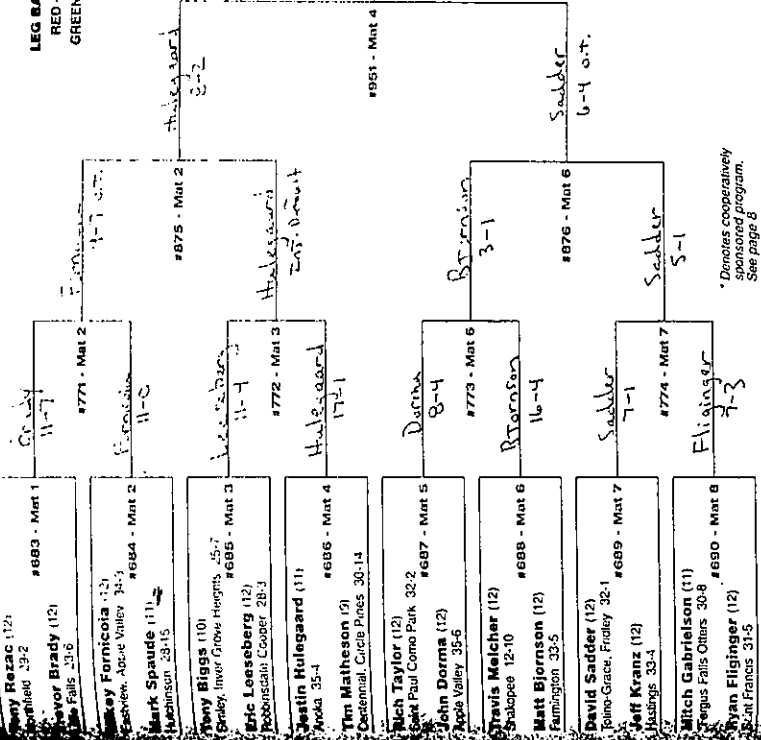

CONSOLATION SERIES

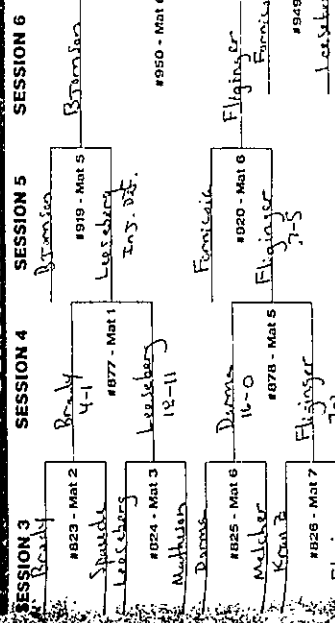

135 LB. CLASS - CLASS AAA

SESSION 2 SESSION 4 SESSION 6

— CODE —
 LEG BAND AND SCOREBOARD
 RED - Upper Bracket Wrestler
 GREEN - Lower Bracket Wrestler

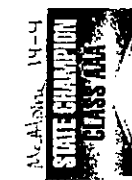
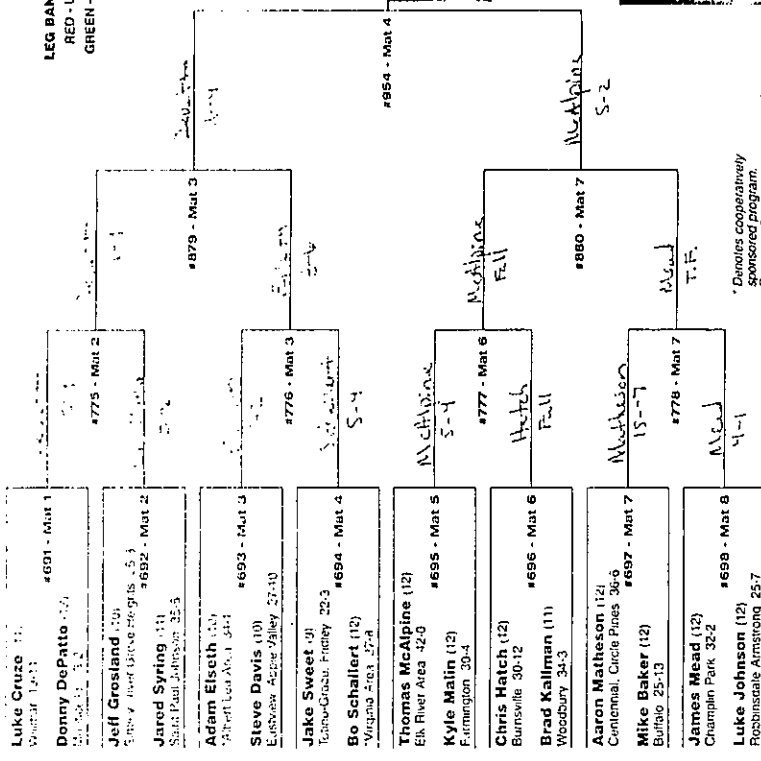

CONSOLATION SERIES

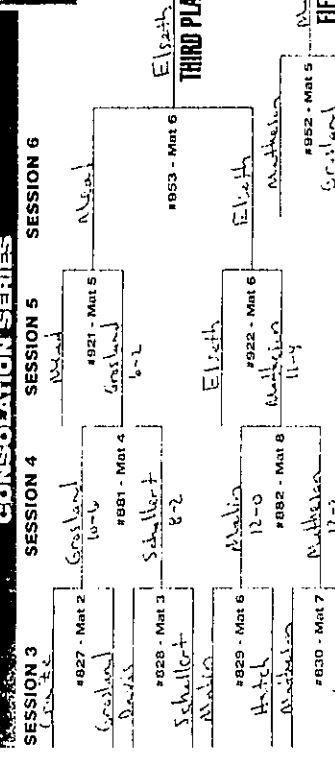

152 LB. CLASS - CLASS AAA

SESSION 2 SESSION 4 SESSION 6

— CODE —
LEG BAND AND SCOREBOARD
 RED - Upper Bracket Wrestler
 GREEN - Lower Bracket Wrestler

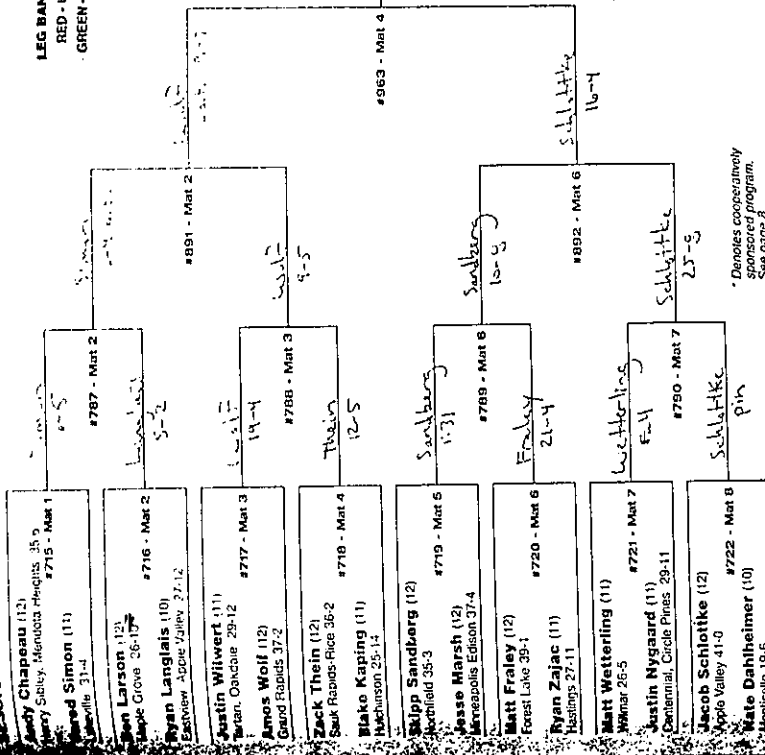

CONSOLATION SERIES

SESSION 4 SESSION 5 SESSION 6

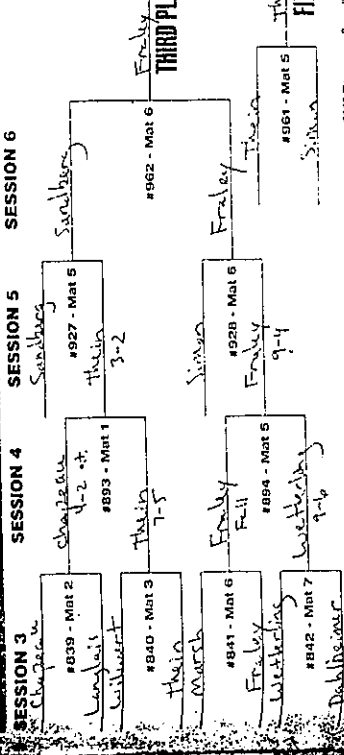



•Mikey Fornicoia, Matt Bjornson, Jestin Hullegard, David Sadder, Ryan Fliginger, Eric Leeseberg

1st - David Sadder, Totino Grace, 12

2nd - Jestin Hullegard, Anoka, 11

3rd - Ryan Fliginger, Saint Francis, 12

4th - Matt Bjornson, Farmington, 12

5th - Eric Leeseberg, Robinsdale Cooper, 12

6th - Mikey Fornicoia, Eastview, 12

First Round: Trevor Brady, Little Falls def. Tony Rezac, Northfield 11-7; Mikey Fornicoia, Eastview def. Mark Spaude, Hutchinson 11-0; Eric Leeseberg, Robinsdale Cooper def. Tony Biggs, Simley 11-9; Jestin Hullegard, Anoka def. Tim Matheson, Centennial 17-1; John Dorma, Apple Valley def. Rich Taylor, Saint Paul Como Park 8-4; Matt Bjornson, Farmington def. Travis Melcher, Shakopee 16-4; David Sadder, Totino Grace def. Jeff Kranz, Hastings 7-1; Ryan Fliginger, Saint Francis def. Mitch Gabrielson, Fergus Falls 7-3

Championship Quarterfinals: Mikey Fornicoia def. Trevor Brady 9-7 OT; Jestin Hullegard def. Eric Leeseberg inj. def.; Matt Bjornson def. John Dorma 3-1; David Sadder def. Ryan Fliginger 5-1

Wrestlebacks: Trevor Brady def. Mark Spaude 4-1; Eric Leeseberg def. Tim Matheson 18-11; John Dorma def. Travis Melcher 3:29; Ryan Fliginger def. Jeff Kranz 16-0

Consolation Quarterfinals: Eric Leeseberg def. Trevor Brady inj def; Ryan Fliginger def. John Dorma 7-5

Consolation Semifinals: Matt Bjornson def. Eric Leeseberg 3-2; Ryan Fliginger def. Mikey Fornicoia 6-3

Championship Semifinals: Jestin Hullegard def. Mikey Fornicoia 8-2; David Sadder def. Matt Bjornson 6-4

Fifth: Eric Leeseberg def. Mikey Fornicoia 6-2

Third: Ryan Fliginger def. Matt Bjornson fall 1:54

Championship: David Sadder def. Jestin Hullegard 3-1

State Team Tournament AAA

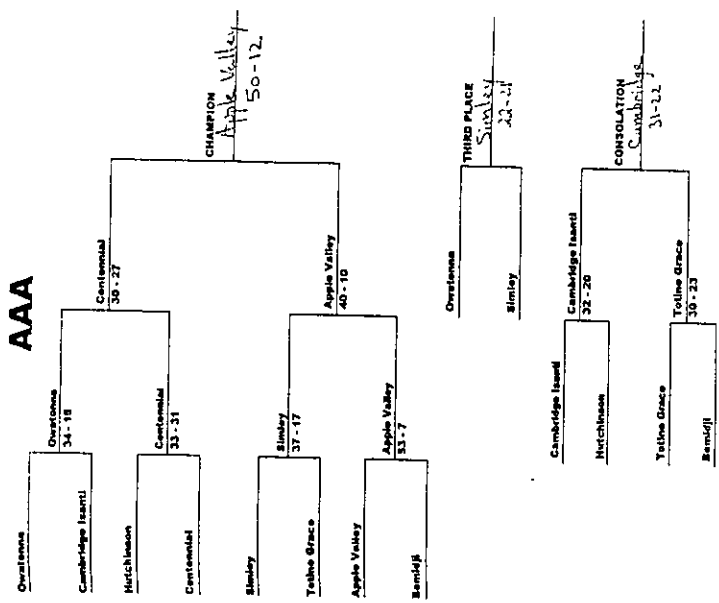

State Team Tournament AA

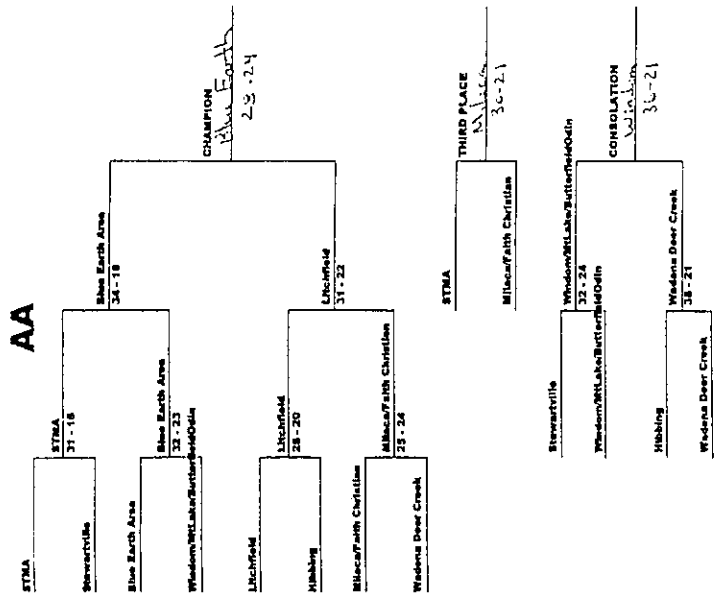

State Team Tournament A

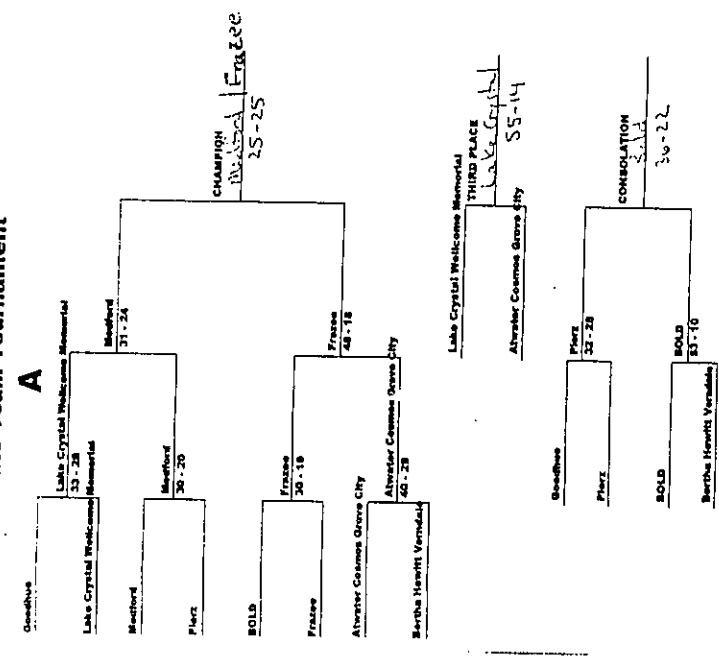

"I AM NOT AFRAID TO FALL"

By Nick Fornicoia

"I am not afraid to fall. It would be a shame if I didn't try" Michael Jordan

When his last shot fell to secure the 1998 NBA title over Utah, the sixth of his storied career, Michael Jordan left his right hand hanging in the air as if to wave farewell to the game he dominated as perhaps the greatest player of all-time. It was as beautiful an ending as any athlete ever authored.

At the risk of spoiling that lasting image of perfection, Jordan is coming back at the age of 38 with the downtrodden Washington Wizards to write

over the years was, as he put it, "that I'm not afraid to fail." He undertook something that was doomed from the start — a minor league baseball venture — and didn't care what anyone thought. He did it.

The front office was the next place. He undertook what many saw as a hopeless task and ended up doing all right. Several agents who have done business with Jordan say he is sharp, focused and knows what he's doing. But even after making some encouraging personnel moves, he still felt the need to return to the court.

He's back — again. He made one thing pretty clear: he doesn't care what people think and he's going to do what he wants to do, when he wants to do it. It's the American way.

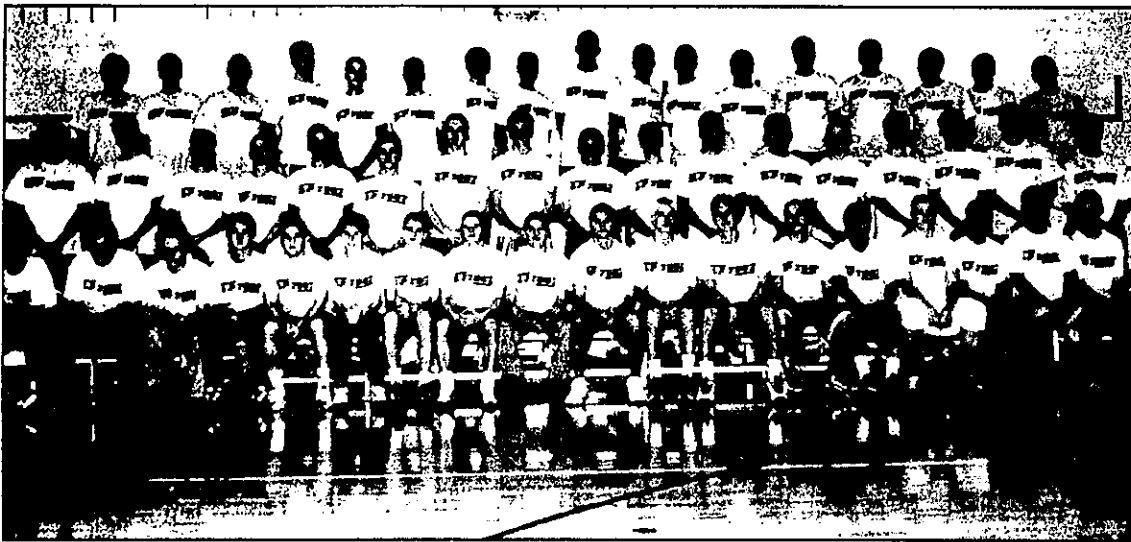

what some fear will be a tacky ending to his sterling 13-year career with the Chicago Bulls.

"I am returning as a player to the game I love," Jordan said.

Considered by many to be the greatest basketball player ever, Jordan retired after winning his sixth title in 1998, sinking a game-winning shot against the Utah Jazz. Jordan retired after that season going out on top. Now, many reporters and naysayers believe he will tarnish his image if he isn't as great as he once was. A reporter asked him: "Some people think it will be a shame if you comeback and fail." To which Jordan responded: "If I fall, I'll get back up. I'm not afraid to fall. It wouldn't be a shame if I failed, but it would be a shame if I didn't try and give it 100 percent."

The thing I think I admired most about Jordan

I believe the reason most people do not succeed in life and in wrestling is because of fear. Wrestling is a sport where you lay it all on the line alone on the mat. If you lose, you cannot blame a teammate or coach. The reward lies when you win and can take all the credit. Many people quit or never try wrestling because they are afraid of looking foolish. Those of you that join wrestling this year are laying it all on the line. It takes courage and humility to join a sport as demanding as wrestling. Yet, we can all learn from Michael Jordan when he says that it would be a shame if we did not give it a try with a complete effort.

Nobody has Michael Jordan's physical gifts, but we can adopt his mental attitude. By committing to this wrestling team, you are committing to giving 110 percent effort and putting your fears aside to risk it all for your dream. The Mission is Possible and we choose to accept it.



Eastview's Mikey Fornicoia (top) wrestles Como Park's Rich Taylor at 130 pounds. Fornicoia won the championship at 130 pounds at the Burnsville Jaycee Invitational. Photo by Rick Orndorf

the title.

Besides the two champions, Eastview had four wrestlers finish in second place and three more finish in third.

The second-place finishers were Steve Davis at 135 pounds, John Getzke at 145 pounds, Ryan Langlais at 152 pounds and Eric Lemm at 189 pounds.

Grabbing third-place honors were Pat Dea at 112 pounds, Jeremiah Foertsch at 125 pounds and Chris Schuck at 160.

Other Lightning wrestlers who placed at the Burnsville Invitational were Kevin McBride (fifth) and Nate Kocer (fourth).

Eastview

With 11 of 13 wrestlers finishing in the top six of their respective divisions, the Eastview Lightning wrestling team finished second at the Burnsville Jaycee Invitational.

The Lightning finished with 175 points, behind only Burnsville's 215 points.

Eastview had two wrestlers claim the top prize at the tournament. The two champions for the Lightning were Mikey Fornicoia at 130 pounds and James Voyles at heavyweight.

Fornicoia claimed the title when he defeated Como Park's Rich Taylor 5-2 in the championship match. Voyles defeated Jim Knoebel of Austin 4-2 for

Wrestling Team Begins Winning Season

by Dan Myers
Staff Writer

One would think that the loss of the only State Champion in the program's history would have a devastating effect on a team. But with the wrestling team, the exact opposite has happened. Led by seniors Mikey Fomicoia and Eric Lemm, the team may have the most all-around talent in school history. Underclassman Kevin Eich, Jeremiah Foertsch, Ryan Langlais, and Steve Davis all play vital roles on the varsity squad, as do Chris Shuck, John Getzke, James Voyles, and newcomer, junior sensation Kevin "Smokey" McBride. More wrestlers have realistic shots at going to state this year, among them Shuck, Getzke, and McBride. With such young talent, this team has a chance to not only be good this year, but in the coming seasons.

The team gave fans a glimpse into the future earlier this season, when they crushed state-ranked Lakeville 34-17. Recently, the team traveled to South Dakota, to compete in an annual meet with teams from not only Minnesota, but South Dakota. While previously finishing no better than 11th in the meet, this year the team finished 4th. "It was a great experience for all of us," said Shuck. "We proved that Minnesota is one of the top wrestling states around."

While wrestling in the meets is difficult, practice is as difficult as for any other sport. "Hard, intense, learning, tiring," Shuck

describes it. "But it can be enjoyable too, the hard work pays off at sections and in the close duels where you know that you are in great shape, it may be the difference between winning and losing."

But not just anybody can start wrestling during the winter season. It takes many months of training, conditioning, and weightlifting to be successful. "Going to wrestling camps and to captain's practices are a must to be successful," says Shuck, the only non-football player to finish in the top 10 in SuperGroup, a summer program designed especially for varsity level athletes in all sports. "Lifting weights, running and being active are a major help during the season."

Of course wrestling at Eastview means that you wrestle in the Lake Conference, meaning tough matches with Lakeville, and nationally-ranked power Apple Valley. Many think the key to beating the Eagles is winning the mental game. "You can't go into the match thinking you're going to lose, because anyone can win on any given night," said McBride. "It all depends on who wants it more, you or them."

Losing a state competitor may be devastating to most other schools in Minnesota, but not to Eastview. With as many as six athletes vying for state championship spots, it is an exciting time in the wrestling room. Youthful excitement is growing as five State contenders are returning next season and underclassmen development continues.

FINALS RECAP

Team highlights

- Apple Valley won its fourth consecutive Class 3A team title and 11th overall, defeating Centennial 50-12.
- Frazee and Medford tied for the 1A championship, with Frazee heavyweight Justin Olson recording a pin to secure the tie.
- Blue Earth Area repeated as the Class 1A champion, holding off Litchfield 28-24.

Individual highlights

- Blue Earth Area senior Jeff Pfaffinger captured his fourth state title with a Class 2A injury default victory over Wadena-Deer Creek's Logan Brincefield, who also was a returning champion. In another matchup of returning champs, Blue Earth Area's Jared Evans beat Leland Brincefield (Logan's twin brother) at 119 pounds.
- Wabasha-Kellogg junior Eric Sanders captured his fourth state championship with a 14-0 decision over Royalton sophomore Josh Brady in the Class 1A 112-pound final.
- Apple Valley had five wrestlers in Class 3A championship matches, and four of them won: Charlie Falck (112), Neil Wasmund (119), Jacob Schlottke (152) and Trevor Laws (heavyweight).

Repeat champs

Class 3A

- **112:** Charlie Falck, Apple Valley (103 last year)
- **119:** Neil Wasmund, Apple Valley (112 last year)
- **125:** Quincy Osborn, Grand Rapids (119 last year)
- **152:** Jacob Schlottke, Apple Valley (140 last year)

Class 2A

- **119:** Jared Evars, Blue Earth Area (103 last year)
- **125:** Jeff Pfaffinger, Blue Earth Area
- **135:** Ryan King, Grand Meadow/LeRoy-Ostrander/Kingsland (130 last year)
- **152:** Marc Harwood, Jackson Country Central (140 last year)
- **Heavyweight:** Josh Bresnahan, Pequot Lakes/Pine River-Backus

Class 1A

- **103:** Gabriel Mooney, Badger/Greenbush-Middle River
- **112:** Eric Sanders, Wabasha-Kellogg
- **145:** Mitch Kuhlman, Medford (140 last year)
- **171:** Tyler Bulleman, Adrian

Five-time champs

➤ Matt Nagel, Frazee, 1997-2001

brother) at 119 pounds.

- Wabasha-Kellogg junior Eric Sanders captured his fourth state championship with a 14-0 decision over Royalton sophomore Josh Brady in the Class 1A 112-pound final.
- Apple Valley had five wrestlers in Class 3A championship matches, and four of them won: Charlie Falck (112), Neil Wasmund (119), Jacob Schlottke (152) and Trevor Laws (heavyweight).

Repeat champs

Class 3A

- **112:** Charlie Falck, Apple Valley (103 last year)
- **119:** Neil Wasmund, Apple Valley (112 last year)
- **125:** Quincy Osborn, Grand Rapids (119 last year)
- **152:** Jacob Schlottke, Apple Valley (140 last year)

Class 2A

- **119:** Jared Evars, Blue Earth Area (103 last year)
- **125:** Jeff Pfaffinger, Blue Earth Area
- **135:** Ryan King, Grand Meadow/LeRoy-Ostrander/Kingsland (130 last year)
- **152:** Marc Harwood, Jackson Country Central (140 last year)
- **Heavyweight:** Josh Bresnahan, Pequot Lakes/Pine River-Backus

Class 1A

- **103:** Gabriel Mooney, Badger/Greenbush-Middle River
- **112:** Eric Sanders, Wabasha-Kellogg
- **145:** Mitch Kuhlman, Medford (140 last year)
- **171:** Tyler Bulleman, Adrian

Five-time champs

- Matt Nagel, Frazee, 1997-2001

Four-time champs

- Jim Van Gorden, Minneapolis Marshall, 1937-40
- Steve Carr, Battle Lake (1976-78), Moorhead (1979)
- John Miller, Renville-Sacred Heart (1982-85)
- Ty Friederichs, Osseo (1992-95)
- Chad Erikson, Apple Valley (1994-97)
- Ty Eustice, Blue Earth Area (1998-2001)
- Marcus LeVesseur, Minneapolis Roosevelt (1998-2000), Bloomington Kennedy (2001)
- Jeff Pfaffinger, Blue Earth Area (1999-2002)
- Eric Sanders, Wabasha-Kellogg (1999-2002)

Attendance

Total for three days: 59,767

