

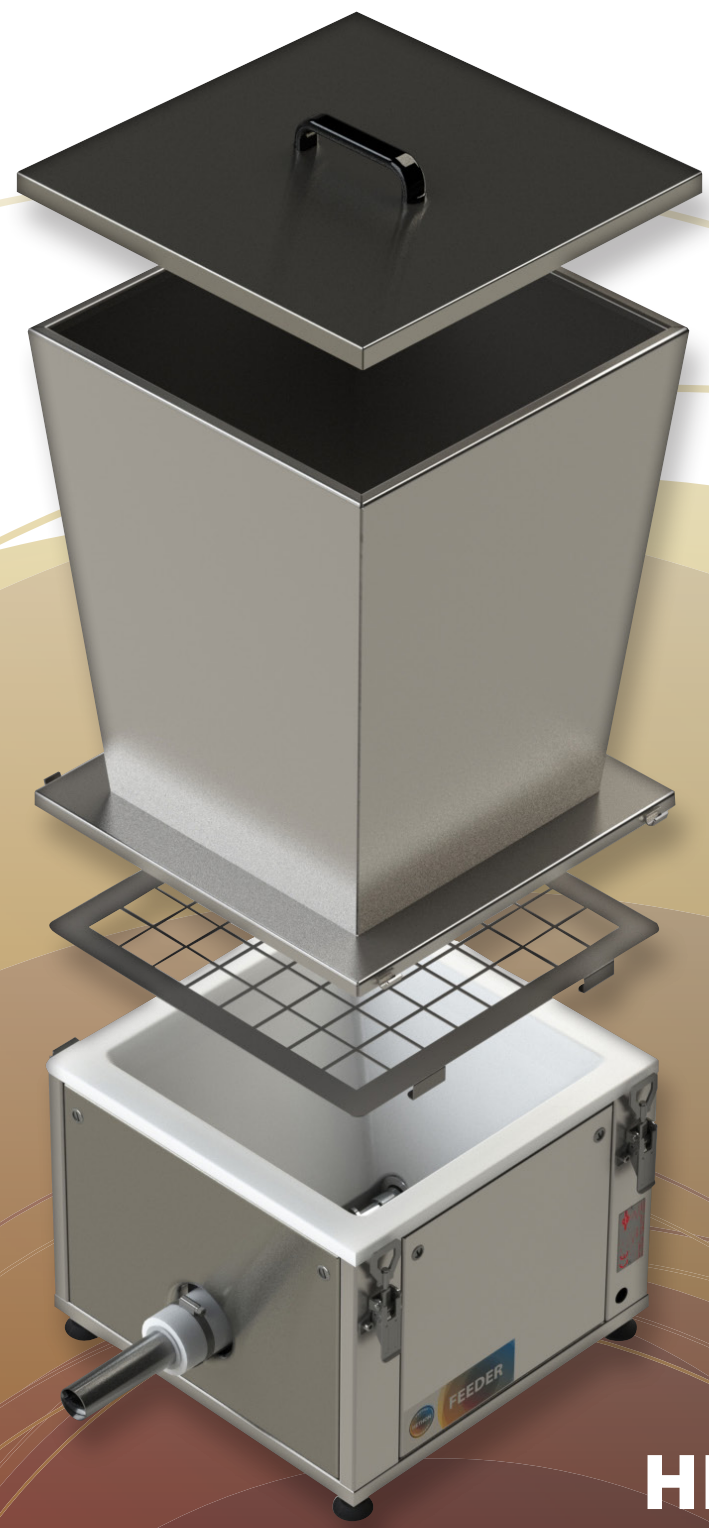

MAKES YOUR BUSINESS FLOW



HETHON

Flexible Wall Feeders
for a perfectly dosed flow
of dry materials

HETHON - Makes your business flow

It's all about the flow! The flow in your business: that is what we, at Hethon, are prepared to do anything for! For decades our Feeders have applied a perfectly dosed flow of hard-to-dose materials. That flow prevents wastage, ensures continuity of production processes and also contributes to the consistent quality of products. That is how we bring the flow into your business!



Feeder production

*The flow in your business,
that is what we, at Hethon, are prepared to do anything for!*

Hethon Feeders for the dosing of dry substances

Our Feeders are utterly versatile machines for the volumetric and gravimetric dosing of various materials. Whether it concerns powders, grains, flakes, chips, pills or fruit pieces, even frozen: Hethon offers you a feeder which can perfectly dose these for you! Also when things become difficult: we continue where others stop.

Hethon Flexible Wall Hopper

With the unique Flexible Wall Hopper technology of Hethon, dry raw materials continuously keep moving. This way ratholing and bridging of dry materials is prevented and optimal dosing is guaranteed. Many manufacturers in various industries have confidence in this proven feeder technology for the reliable dosing of their dry bulk materials. Available in 5 different variants.

Assortment

Our Feeders are capable of processing many types of ingredients with capacities of 0.08 up to 25,000 l/hour. Within this range Hethon offers six machine-variants and screws in different diameters and shapes. The dosing devices are available in volumetric and gravimetric models and can be supplemented with many options, such as nozzles, measurement and control electronics, extension hoppers and a wide assortment of complementary applications.

HETHON - Index

Hethon Makes your business flow	2
Index	3
Markets and applications	4
Hethon Feeder technology	6
Hethon Feeder 30	8
Hethon Feeder 40/50/60/70	10
Hethon Feeder 80	12
Hethon Loss in Weight System	14
Hethon single Feeder components	16
Hethon Complementary products	18
Capacity overview	20
Service	21

*Renewed Hethon Feeder-design
with easily detachable frontdoor
for T-nozzle
Optionally available*

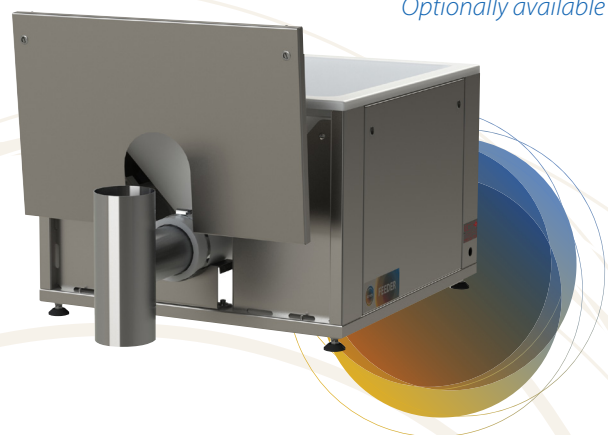

HETHON - Markets and applications

Hethon brings the perfect flow in, for instance:



*The perfect flow
in many markets and applications!*

Ceramics

- Dosing of particles, pigments, etc.
- Dosing of pigments across tiles
- Dosing of powdered ingredients in mixer

Chemistry

- Dosing of chemicals in processes
- Dosing of powders in mixers
- Dosing of powders in blenders
- Dosing of powders in reactors

Environment

- Dosing of lime in water purification plants
- Dosing of lime for exhaust gas cleaning
- Dosing of poly-electrolyte

Food industry

- Accurate administering of ingredients, colours and flavourings
- Dosing in cookers, kettles and mixers
- Scattering herbs over pastry and potato chips
- Filling of little bottles, boxes or bags with spices

Cosmetics

- Dosing of foundation in jars
- Dosing of herbs in soap
- Dosing of salt in toothpaste
- Dosing of minerals in make-up and shampoo

Pharmacy

- Dosing of powders for formulas
- Filling of bags with little portions
- Dosing of sterile products

Plastic

- Dosing of powders in mixers
- Dosing of granulates in extruders
- Dosing of recycled synthetics
- Dosing of lime as a filler

Paint

- Dosing of pigments in a coating bath
- Dosing of pigment in repeated formulas

Rubber

- Dosing in formulas

Other applications

- Dosing of structures
- Dosing of toner
- Dosing of additives to seeds

A different application? We will be happy to demonstrate.

Abovementioned matters are just a few of our many applications. If you are looking for the perfect flow in other dry substances, then feel free to let us know. In an especially furnished test space we will demonstrate, by use of material tests, that we have a solution for your product as well.

HETHON - Feeder technology

Conventional solution: stirring arms and screws

The dry substances you work with, sometimes don't have a natural flow. The accurate dosing of these substances is therefore often a challenge. In conventional machines screws and stirring arms are applied to dose the dry substances. The substance is in motion, but there is a risk of damage, segregation, ratholing, bridging and compacting of your dry material. As a result the dosing is not accurate, material is lost and the continuous flow of your production process is at risk.

In addition, the many moving components and contact parts require extra maintenance, so there is a relatively large risk of damage.

The Hethon solution: Flexible Wall Hopper

Hethon dosing machines are equipped with a Flexible Wall Hopper: a wall hopper with a flexible exterior of sustainable Polyurethane. By externally, mechanically and evenly massaging the wall hopper walls, by use of paddles, the dry substances continuously keep in motion. Thus the material is transported smoothly towards the dosing screw. As the mechanical paddles are not inside the wall hopper, as opposed to the stirring arms and screws, the dry material will not get damaged and ratholing or bridging is prevented. Therefore even poorly flowing and compacting raw materials are easily and accurately dosed. It is also possible to have the screw and the paddles move quicker or more slowly, independently. This way one can fiddle with the proper settings.

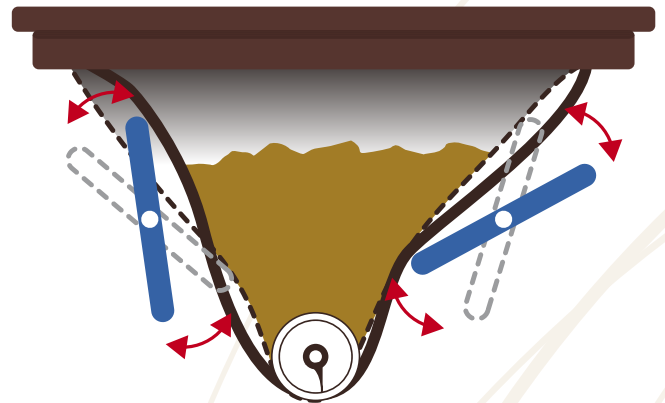
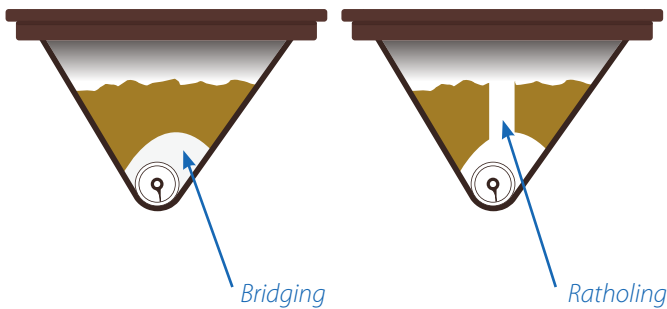

The process of The Hethon Flexible Wall Hopper

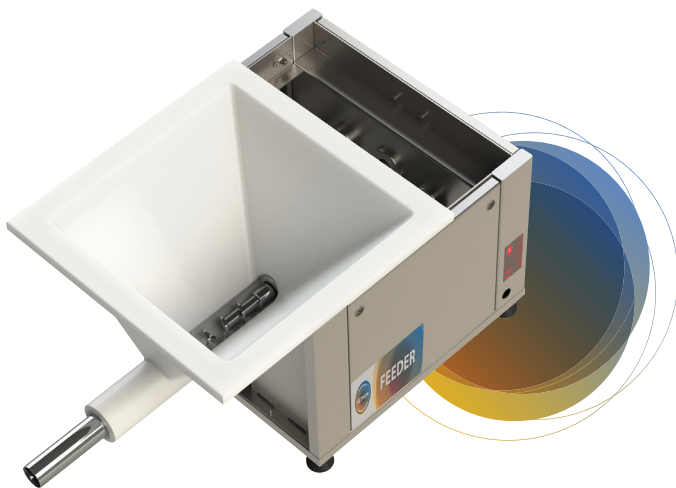

*The Hethon Flexible Wall Hopper
in a Feeder*

*The Flexible Wall Hopper
is easily detachable!*

Your benefits of a Hethon Feeder

- Prevent ratholing, bridging and damage to the material
- Minimal power consumption
- Easy to clean due to detachable components
- Low-maintenance because of few wear points
- Stable and strong thanks to high-quality Inox tube frame construction
- Separate paddle propulsion possible
- Limited segregation
- 4 easily detachable doors
- Steel profile cast in the hopper for stable retrieval
- Hopper available in 5 versions
- Very few contact elements
- Excellent price-performance ratio

A Flexible Wall Hopper for every application

Our Feeders are used for the accurate dosing of many dry substances. For every application there is a Flexible Wall Hopper with the appropriate specifications. The easily detachable dosing hoppers can, as an exchange hopper, be conveniently stored elsewhere. This saves cleaning costs, for instance in case of colour changes or pigments. Is your application not included? Feel free to enquire about the possibilities for your process!



High temperatures



Acid-resistant

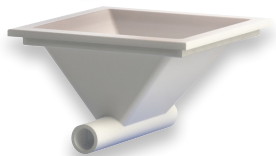

Modified Polyurethane (standard)



FDA certified

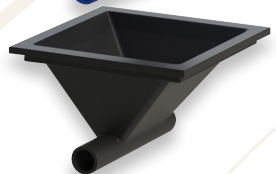

Anti-static

Capacities

Page 20 of this catalogue contains a handy fold-out page with all our theoretical capacities at a glance.

High-quality construction and material

In order to achieve optimal stability, our constructions are not made of sheet metal, but from solid steel tube frames. These are manufactured from carbon steel, 304 RVS or 316 RVS and can optionally be delivered with a white powder coating. The contact surfaces are made of Polyurethane, 316 RVS and POM. These materials have an excellent chemical resistance and are suitable for virtually all foodstuffs and pharmaceutical applications. The frame is constructed so heavily that the dosing device can be used as a support of a silo. The Hethon Feeder can also be installed as a dosing machine hanging from a silo.



A look inside The Hethon Feeder

Maintenance

Hethon Feeders have a long lifespan and require little maintenance as a consequence of a minimum number of moving parts being subject to wear. As all parts are easily detachable, our Feeders are very easy to clean. Our maintenance department is at your service to make the most of your products for many years. Moreover, your own maintenance department can easily carry out the work activities using the included manual.

HETHON - Feeder 30



The Hethon Feeder 30 was developed specifically for the dosing of small quantities. Particularly for laboratory applications and in pilot plants simulating production processes, this series has excellently proved its added value.

Possible applications

- The dosing of powders in small containers of labequipment at pharmaceutical companies
- The dosing of polyelectrolytes in water purification plants
- Adding defoamers or other additives in the extrusion process in the plastic industry
- Adding flavouring, odour and colouring substances in the food industry

Properties

The Hethon Feeder 30 is equipped with a powerful three-phase motor for driving the screw and the massaging paddles. The frame is made of 304 (and optionally 316) Inox.



Hethon Feeder 30

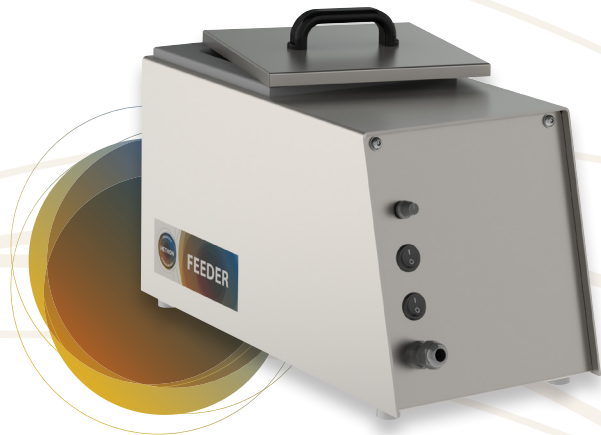

Hethon Feeder 30 with integrated control

Feeder 30

Maintenance

The flexible hopper is easily detachable, without the use of tools. Also the extension hopper can be removed quickly by loosening a single bolt. As such, the device can be cleaned quickly and easily.

Expansion possibilities

The Hethon Feeder 30 has a hopper content of approximately 1 litre, which can be increased by use of a 7 litre extension hopper. The Hethon Feeder 30 is available with or without control. It can easily be applied to your existing installation, for example in a carousel with formula or as a stand-alone.

Capacity

The content and capacities of The Hethon Feeder 30 can be found on the fold-out page at the end of this brochure.

Customisation and advice

Would you like some customised advice? Feel free to inform us about your dosing-issues!

Developed specifically for the dosing of small quantities!

HETHON - Feeder 40/50/60/70



The Hethon Feeders 40, 50, 60 and 70 have a longstanding record in industrial processes. Owing to its solid construction, this series is excellently suitable for demanding applications. The Feeders 40 up to and including 70 are, for example placed under silos, Big-Bag collectors, in a carrousel (circle) or as a stand-alone.

Possible applications

- The dosing of for instance lime for exhaust gas cleaning
- Adding colouring substances or other additives in the plastic industry
- Adding flavouring, odour and colouring substances in the food industry
- The dosing of powders in bottles, mixers or blenders in the pharma-industry
- The dosing of clay, paint and/or glaze in the ceramic industry

Properties

The Hethon Feeders 40 up to and including 70 are available with 1 of 2 motors. The optional second propulsion makes it possible to have the paddles and screw moving independently.



Hethon Feeder 40, 50, 60 en 70

A proven dosing machine for industrial applications!

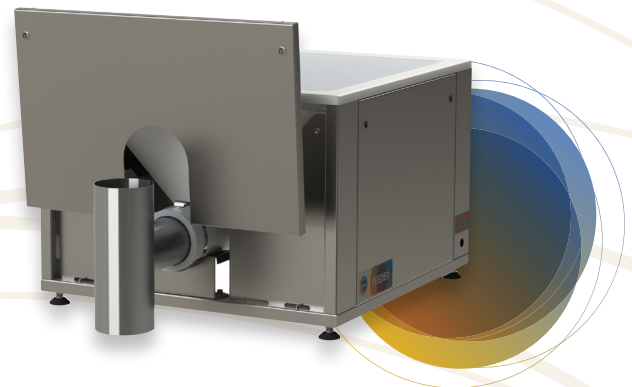

This way the paddles keep the material in motion whilst the screw only rotates slowly. The Feeders are available in powder-coated version, 304 RVS of 316 RVS.

Maintenance

The flexible hopper is easily detachable. Also a possible extension hopper can be removed quickly. Therefore the device is very easy to clean.

Expansion possibilities

The Hethon Feeders 40, 50, 60 and 70 are easy to expand with the accessories and complementary products which can be found on page 14 - 19. Using an extension hopper the capacity can be increased to no less than 250 litres.

Capacity

The content and capacities of The Hethon Feeders 40, 50, 60 and 70 can be found on the fold-out page at the end of this brochure.

Customisation and advice

Having many years of experience in the dosing of dry substances, we will be happy to think along about the optimal solution for your process!



Also available in ATEX!



Being the largest Feeder within the Hethon-family, the Feeder 80 is widely used in large, professional industries worldwide. The machine is ideal for the dosing of larger quantities dry substances and other hard-to-dose materials, with a large variety of specifications. Mostly Feeder 80-installations are assembled by use of the accessories and complementary products from our assortment.

Possible applications

- The dosing of , for instance polyelectrolytes in water purification plants
- The dosing of lime and wood pulp
- Recycling of scrap in the production flow of the plastic industry
- Filling large packaging machines in the food industry
- Adding pigments in the paint industry for use under bunkers and silos

Properties

The Hethon Feeder 80 is available with 1 of 2 motors. The optional second propulsion makes it possible to have the paddles and screw move independently.

The Feeder 80 is available in RVS 403 and comes powdercoated if required.

Maintenance

The flexible hopper can be removed easily.

Expansion possibilities

The Hethon Feeder 80 can be expanded easily with the accessories and complementary products which can be found on page 14 - 19. Using an extension hopper the capacity can be increased to no less than 1000 litres.

Capacity

The content and capacities of The Hethon Feeder 80 can be found on the fold-out page at the end of this brochure.

Customisation and advice

Feel free to inform us about your dosing issues, we will be happy to think along about a customised solution!



Hethon Feeder 80



Also available in ATEX!

Widely used in large, professional industries worldwide

HETHON - Loss in Weight System

For the automatic and accurate dosing, a weighing system can be used. The possibilities include both Loss in Weight and Gain in Weight Systems.



Fully automated dosing solution

Hethon is your experienced total supplier of complete weighing systems. Within our assortment, all necessary components, such as weighing scales, loadcells, control boxes, touchscreens and software can be found. By combining these perfectly harmonised products, you can assemble your own fully automated dosing system! Accuracy in optima forma!

Loss in Weight - Gain in Weight

Hethon dosing machines can be placed a weighing plateau with one or more built-in loadcells as you require. In combination with the software you can, as such, create a high-quality dosing system with many adjustment options. You can, for instance, apply pre-set formulas, adjustable dosing speeds, or a coarse and fine dosing for even more accuracy.

Accurate dosing in packaging

By placing your packaging on a weighing plateau, your Hethon dosing machine can dose your product directly into the packaging you desire. Instead of the Hethon Feeder, your packaging and product will be on the weighing scale. The weighing system automatically ensures the accurate dosing from the Hethon Feeder into your packaging. Trouble-free working with various formulas, weights and packaging, as such, becomes.

Customisation and advice

As you expect from us, we can also design a customised weighing system for your process and product properties, in accordance with the measurement standards you provide. Consider for example the combination of Belt weighing using a Hethon Loss In Weight system. The Hethon weighing system is intelligent and self-learning, due to which accurate and consistent dosing is assured, also under changing conditions. Feel free to contact us to discuss the many possibilities available.



The Hethon Loss in Weight System is available in ATEX version!

Hethon Feeder on weighing plateau

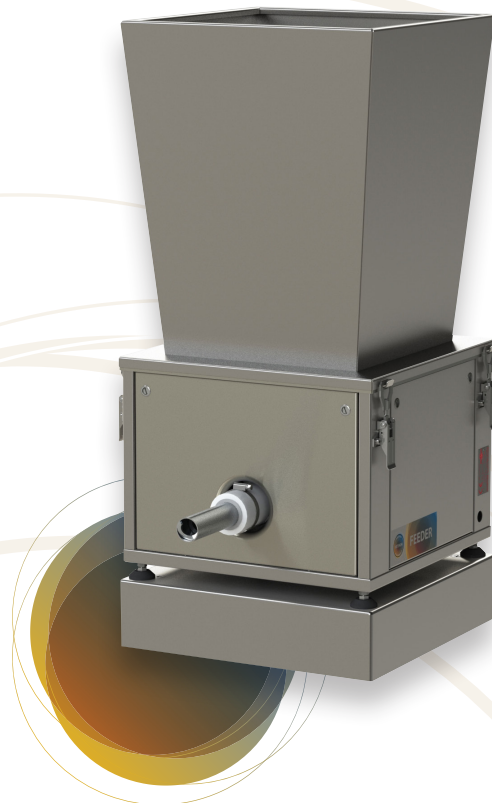

Optimal grip on accuracy and speed!

HETHON - Separate Feeder components

Hethon Feeders are available in many types, sizes and models, being able to apply a perfectly dosed flow of virtually all dry products. Using the associated separate products, you can optimise or expand your Hethon Feeder as you like.

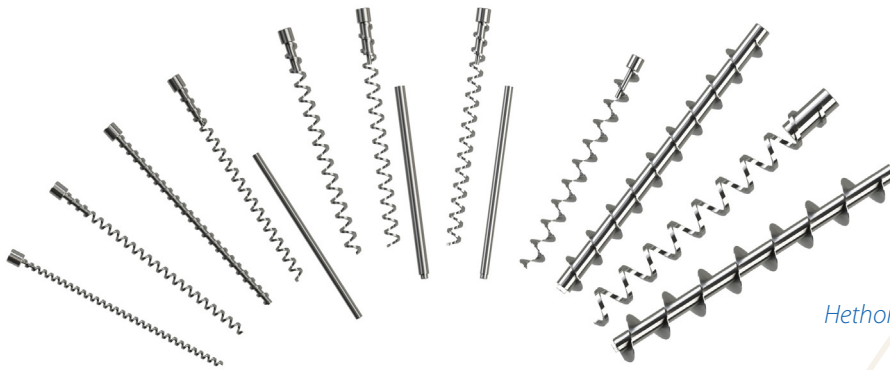

Hethon screws

Extra Hethon screws

Hethon screws are made of stainless steel 316, as a standard. Many different variants are available, for example with an open or dense core and a fixed or detachable core. The associated capacities can be found on the fold-out page at the end of this brochure.

Extra Hethon nozzles

The Hethon Feeders come standard with an open nozzle. In our option-assortment you can also find a range of other nozzles, for example horizontal or vertical T-Nozzels with or without valves, for controlled product dosing.

T-nozzle with pneumatic shut-off valve



Hethon nozzles

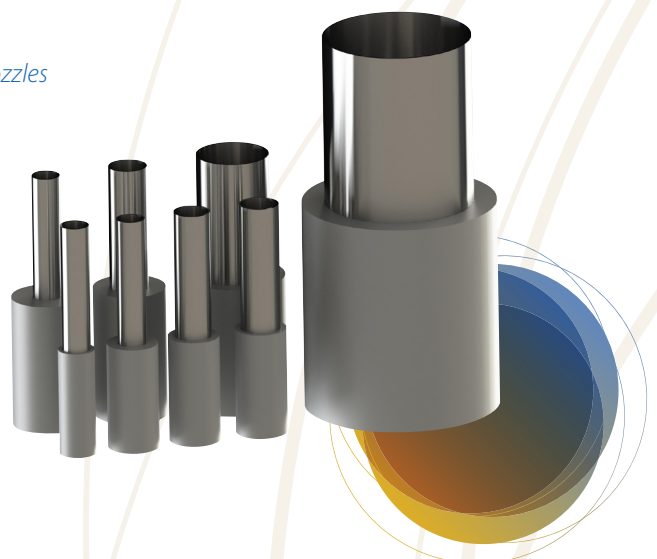

Optimise your Feeder for the perfect application in your process!

Hethon control

You can equip our Feeders with a separate control. This way you can easily control multiple Feeders simultaneously and even add other devices to your Feeder-configuration.



Hethon measuring and control equipment

Hethon Feeders can be equipped with advanced measuring and control electronics. We offer frequency-driven capacity control for volumetric continuous or batch-dosing, fine-dosing control at high/low speed for accurate batch dosing and inputs and outputs for external signals for automatic dosing.

A Flexible Wall Hopper for every application

Our Feeders are deployed for the accurate dosing of many dry substances. A Flexible Wall Hopper with the appropriate specifications exists for every application. Is your application not included? Feel free to enquire about the possibilities for your process!

Hethon extension hoppers

Using our Hethon extension hoppers you can increase the content of your Hethon Feeder up to six times. The extension hoppers are available in different shapes and capacities. Feel free to enquire about the optimal solution for your project!

Hethon Grid

Hethon Feeders and extension hoppers can optionally come equipped with a protective grid.

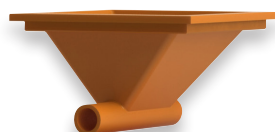

High temperatures



Acid resistant

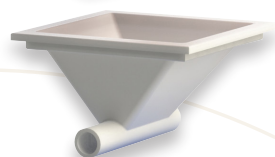

Modified Polyurethane (standard)



FDA certified

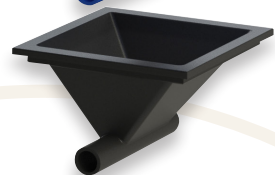

Anti-static

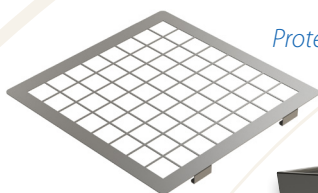

Protective grid

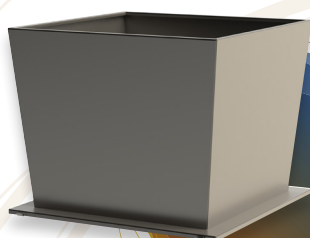

Hethon extension hopper

Optional

HETHON - Complementary products

In addition to Feeders, Hethon offers an interesting assortment of complementary products, predominantly for the dosing of ingredients. With these additional solutions you ensure that your Hethon Feeder ties in seamlessly with your process. This page shows the majority of these products.

Hethon VacuFeed

For the dust-free transportation of powders and granulates, Hethon developed the VacuFeed. This product could serve as a product feeder and can be easily adapted to your Hethon Feeder or other equipment. The VacuFeed is also suitable for dust-free emptying of tubs, barrels or bulk packaging. The products are modular and equipped with automatic filter cleaner and a pneumatic shut-off valve.

*Hethon Vacuum
Transporter VacuFeed*

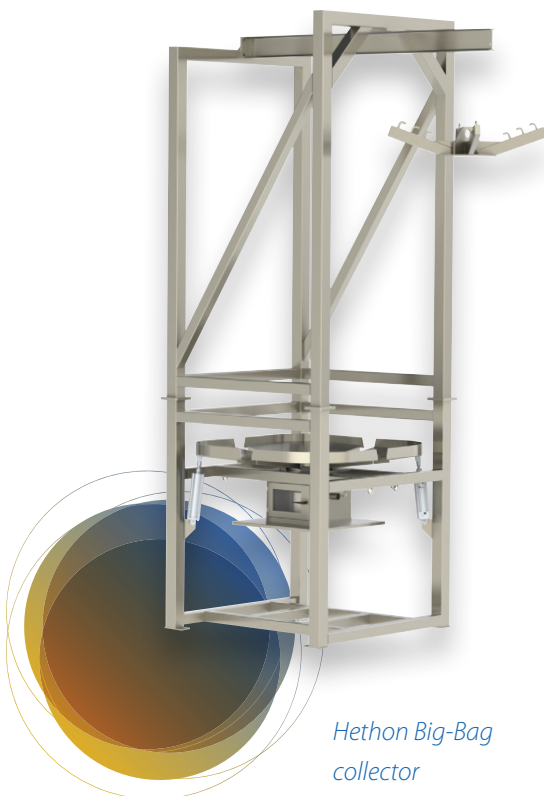

*Hethon Big-Bag
collector*

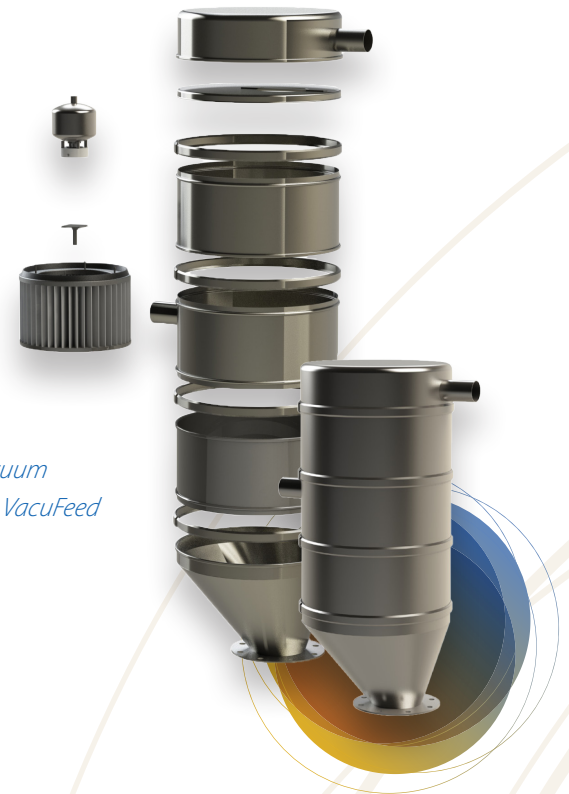

Hethon Big-Bag collectors

Hethon Big-Bag collectors are ideal for the emptying of Big-Bags with compacting dry substances. Owing to the four diagonally moving sheets with integrated air cylinders, poorly flowing dry substances are completely removed from the bag, preventing any wastage.

*Practical solutions, based on years of
experience with dry substances!*

Hethon Manual bag dump station

Hethon manual bag dump stations are custom-developed for the dust-free filling of your Feeder or other equipment. The manual bag dump station is applied to your dosing devices as an extension. The product can be fitted with a level sensor, a safety switch for the valve, connector for the extraction, an own extraction system, a self-cleaning filter and/or a safety switch.



Hethon Manual bag dump station

Hethon Bag compactor

In order to prevent uncomfortable questions by the Health and Safety Service about the risks of piles of bulk bags, we developed the bag compactor for powder processing companies. This installation compacts and packs emptied bulk bags, enabling you to store and remove them compact and easily.

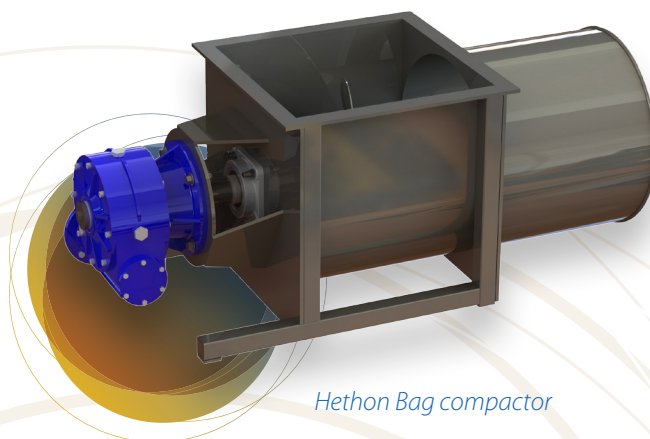

Hethon Bag compactor

THEORETICAL CAPACITIES* WHEN USING SCREW DIAMETERS IN LITRES PER HOUR**

Feeder model	Diameter screw	Screw speed in RPM						
		10	20	40	60	80	100**	120
30	10/5 + CR	0,080	0,160	0,320	0,480	0,640	0,800	0,960
30	10/5	0,100	0,200	0,400	0,600	0,800	1,000	1,200
30	10/10 + CR	0,240	0,480	0,960	1,440	1,920	2,400	2,880
30	10/10	0,300	0,600	1,200	1,800	2,400	3,000	3,600
30 / 40	13mm + CR	0,77	1,54	3,08	4,62	6,16	7,70	9,24
30 / 40	13	1,10	2,20	4,40	6,60	8,80	11,00	13,20
30 / 40	18	2,40	4,80	9,70	14,50	19,40	24,20	29,10
30* / 40	21	4,30	8,60	17,20	25,80	34,40	43,00	51,60
40	27	9,30	18,70	37,50	56,20	75,00	93,70	112,50
40* / 50 / 60	31	14	28	56	84	112	140	168
50 / 60	40	30	60	20	180	240	300	360
60	50	58	116	232	348	464	580	696
60	58	82	164	328	492	656	820	984
60* / 70 / 80	61	107	214	428	642	856	1.070	1.248
70 / 80	75 + CR	159	318	636	954	1.272	1.590	1.908
80	100 + CR	415	830	1.660	2.490	3.320	4.150	4.980
80	125 + CR	860	1.720	3.440	5.160	6.880	8.600	10.320
80	155 + CR	1.663	3.326	6.652	9.978	13.304	16.630	19.956
80*	165 + CR	2.055	4.110	8.220	12.330	16.440	20.550	24.660

Available feeder models

- Frequency-driven capacity control for volumetric continuous or batch doses
- Fine dosing control at high/low speed for accurate batch doses
- Controlled weighing-electronics via the Loss In Weight principle for utterly accurate continuous or batch doses
- Inputs and outputs for external signals for automatic dosing

- * Feeder 30, 40, 60 of 80: Largest possible screw, but only WITHOUT nozzle!
- ** Standard RPM of the screw for Feeder 40 - 80. Speeds exceeding 120 RPM are not recommended.
- *** At 100% filling degree of the screw

CR = Screw with central axe

If necessary, Feeders 40, 50, 60 and 70 can handle screw diameters up to 13 mm.

MODEL	40	50	60	70	80
A	400	400	600	600	800
Food pad thread	M8	M8	M8	M8	M12
B/C feeding distance	360	360	550	550	740
F height adjustment	20	20	20	20	20
H	320	320	420	420	640
N	120	120	150	150	225
L	150	150	150	150	250
Propulsion Kw	0,18	0,18	0,37	0,37	0,75
Hopper volume	10 ltr	10 ltr	30 ltr	30 ltr	90 ltr
Weight	45 kg	45 kg	65 kg	65 kg	120 kg

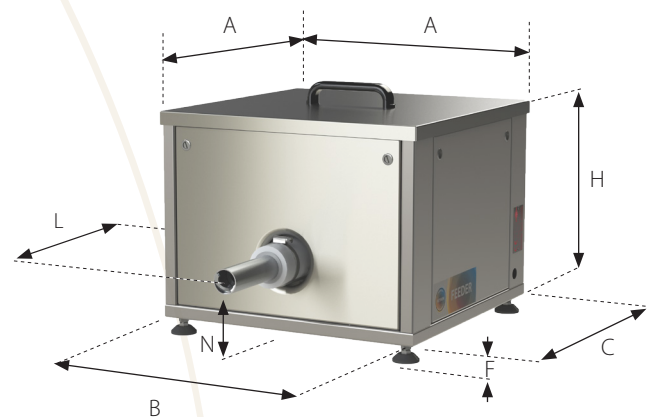

Machine construction is in our genes! Since 1973 we have been a manufacturer of machines for various industrial applications. In 1988 this was followed by the specialisation in the dosing of hard-to-dose dry materials. As an experienced manufacturer of dosing machines and accessories, we are obviously happy to advise you about the ideal solution for your dosing issue!



Tailored advice about dosing issues

Using knowledge about your dry materials and our solutions, we will be happy to think along about the installation to realise the optimal flow in your production process. If a solution is not available yet, then we will come up with a tailored one for you! Feel free to contact us for non-obligatory advice.



Supervision of your project

As soon as we are aware of your wishes, our specialists will guide you step by step towards the suitable dosing solution. For the planning, the drawing work, the structure, the design, the construction and the commissioning of the desired total solution, you can rely on our professionals.



Service on location

A good product depends on a professional commissioning and proper maintenance. In The Netherlands we can maintain your feeder. You also can ask your local agent what service he can provide.



Hethon

Also if you want to make temporary use of our Feeders, need an extra Feeder for the short-term, or want to test a Feeder in your production process, we are ready to assist you. You can rent our products at competitive prices. Feel free to contact us. Our extensive stock of Feeders and operating solutions enable us to flexibly think along with you!



MAKES YOUR BUSINESS FLOW

CONTACT

Hethon The Netherlands B.V.

Vlijtstraat 47
7005 BN Doetinchem
THE NETHERLANDS
T +31 (0)74 250 05 55
E info@hethon.nl
www.hethon.nl

Check our website to find a dealer near you



All of our goods are in compliance with CE applicable rules. Our equipment is available in ATEX and can therefore also be placed in explosive areas.



www.hethon.nl