



Towel Warmers™



AUGUSTA TOWEL WARMER (AGS-0800500-MB)  
SEE PAGE 9

2019 PRICE BOOK

## 8 DIFFERENT SERIES

ATLANTA, AUGUSTA, BOSTON, CHICAGO, DALLAS, DENVER, SEATTLE, TUCSON

## 4 FINISHES AVAILABLE

POLISHED CHROME, BRUSHED NICKEL, POLISHED NICKEL, MATTE BLACK

## 10 YEAR BODY, 5 YEAR ELECTRICAL WARRANTY

(SEE PAGE 23)



**ATLANTA TOWEL WARMER (ATL-0800600-BN)**

SEE PAGE 7

ELECTRICAL OIL FILLED  
HARDWARE KIT INCLUDED  
INSTALLATION KIT INCLUDED

# TABLE OF CONTENTS



<b>ATLANTA SERIES</b>	<b>6 - 7</b>
<b>AUGUSTA SERIES</b>	<b>8 - 9</b>
<b>BOSTON SERIES</b>	<b>10 - 11</b>
<b>CHICAGO SERIES</b>	<b>12 - 13</b>
<b>DALLAS SERIES</b>	<b>14 - 15</b>
<b>DENVER SERIES</b>	<b>16 - 17</b>
<b>SEATTLE SERIES</b>	<b>18 - 19</b>
<b>TUCSON SERIES</b>	<b>20 - 21</b>

# WELCOME TO VERNON



Vernon Towel Warmers combines luxury and design to create a unique product for EVERYONE. Each Series offers YOU the opportunity to enjoy an exclusive spa experience every day in your own home. With eight different Series, and two sizes per Series, Vernon Towel Warmers has the size you need, and the style you want. Stocked in Chrome, Matte Black, Brushed Nickel and Polished Nickel, your daily trip to the spa has never been so easy. Check our other key features below:

- 8 collections
- 2 sizes per collection
- 20"-24" wide products available
- Hardwire Kit included
- Limited Lifetime Warranty

For more information regarding our products and pricing, please contact your local representative or contact Vernon Towel Warmers Inc. at **1-604-628-0567** or **orders@vernontowelwarmers.com**. Thank you for considering Vernon Towel Warmers Inc.

## STOCKED FINISHES BY SERIES

SERIES	POLISHED CHROME	BRUSHED NICKEL	POLISHED NICKEL	MATTE BLACK	SERIES PAGE #
ATLANTA	●	●	●	●	6 - 7
AUGUSTA	●	●	●	●	8 - 9
BOSTON	●	●	●	●	10 - 11
CHICAGO	●		●	●	12 - 13
DALLAS	●	●		●	14 - 15
DENVER	●	●	●	●	16 - 17
SEATTLE	●	●	●	●	18 - 19
TUCSON	●	●	●		20 - 21

ATLANTA SERIES —  
ATL-0800600

- PC
- BN
- PN
- MB



AUGUSTA SERIES —  
AGS-0800500

- PC
- BN
- PN
- MB

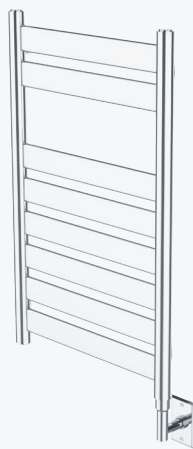

BOSTON SERIES —  
BOS-0800500

- PC
- BN
- PN
- MB



CHICAGO SERIES —  
ORD-0800500

- PC
- PN
- MB



THE COMPLETE  
VERNON TOWEL  
WARMER RANGE

DALLAS SERIES —  
DAL-0800600

- PC
- BN
- MB



DENVER SERIES —  
DEN-0800600

- PC
- BN
- PN
- MB

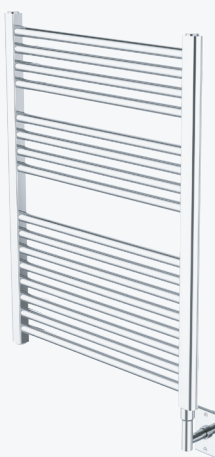

SEATTLE SERIES —  
SEA-0800600

- PC
- BN
- PN
- MB

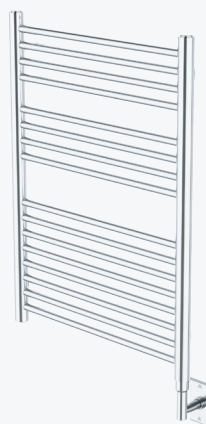

TUCSON SERIES —  
TUS-0920600

- PC
- BN
- PN



# ATLANTA SERIES



## ATL-0800600-PC

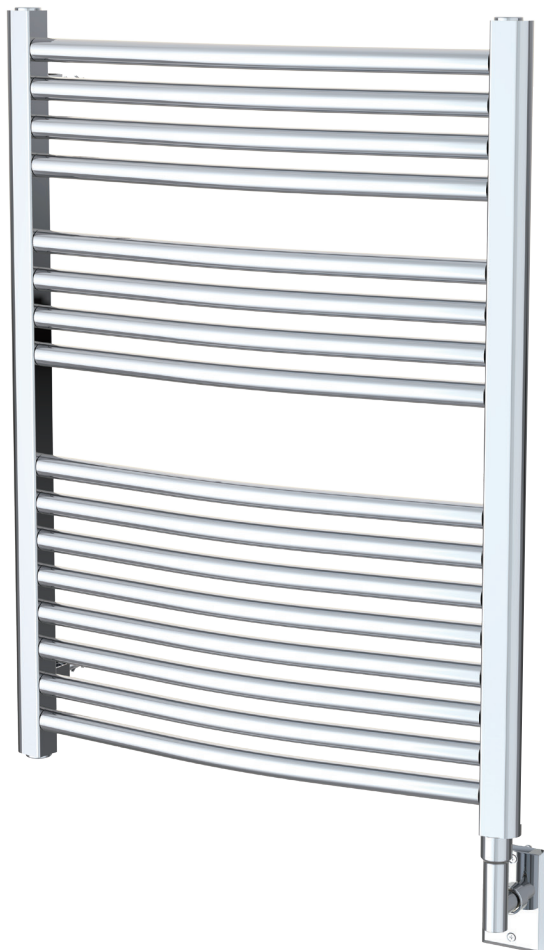

## FEATURES

- WALL MOUNTED
  - HARDWIRE INSTALLATION KIT
  - MOUNTING INSTRUCTIONS
  - ALL ELECTRIC AND OIL FILLED
  - COVER PLATES
- TIMERS AVAILABLE SEPARATELY (NOT INCLUDED)

## FINISHES IN STOCK

- POLISHED CHROME (PC)
- BRUSHED NICKEL (BN)
- POLISHED NICKEL (PN)
- MATTE BLACK (MB)

## SIZES

- 800 x 600 MM
- 1200 x 600 MM

## WARRANTY



Limited Lifetime Warranty  
Garantie à vie limitée  
Garantia limitada de por vida



Product Code	Finishes	Sizes (mm)		Sizes (Inches)		Output (Watts/BTU)	Element Size	Number of Elements
		Height	Width	Height	Width			
ATL-0800600	PC, BN, PN, MB	800	600	31.50	23.62	349 / 1191	150W	16
ATL-1200600	PC, BN, PN, MB	1200	600	47.24	23.62	523 / 1786	300W	24

# ATLANTA SERIES



ATLANTA

AUGUSTA

BOSTON

CHICAGO

DALLAS

DENVER

SEATTLE

TUCSON

PRODUCT CODE	NAME	FINISH	PRICE
--------------	------	--------	-------

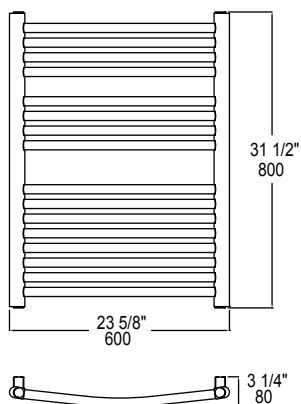

ATL-0800600-PC Towel Warmer Polished Chrome \$500

ATL-0800600-BN Towel Warmer Brushed Nickel \$600

ATL-0800600-PN Towel Warmer Polished Nickel \$600

ATL-0800600-MB Towel Warmer Matte Black \$500

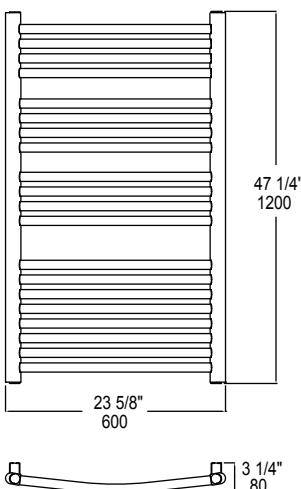

ATL-1200600-PC Towel Warmer Polished Chrome \$830

ATL-1200600-BN Towel Warmer Brushed Nickel \$995

ATL-1200600-PN Towel Warmer Polished Nickel \$995

ATL-1200600-MB Towel Warmer Matte Black \$855

AVAILABLE FINISHES

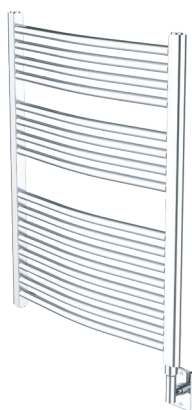

Polished Chrome (PC)



Brushed Nickel (BN)

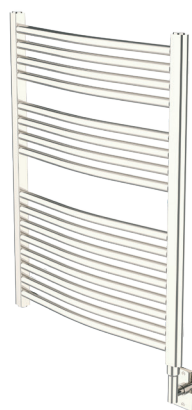

Polished Nickel (PN)

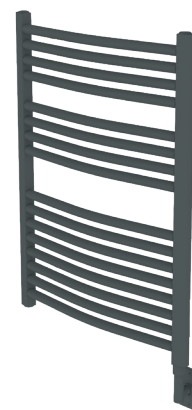

Matte Black (MB)

# AUGUSTA SERIES



## AGS-0800500-PC



## FEATURES

- WALL MOUNTED
  - HARDWIRE INSTALLATION KIT
  - MOUNTING INSTRUCTIONS
  - ALL ELECTRIC AND OIL FILLED
  - COVER PLATES
- TIMERS AVAILABLE SEPARATELY (NOT INCLUDED)

## FINISHES IN STOCK

- POLISHED CHROME (PC)
- BRUSHED NICKEL (BN)
- POLISHED NICKEL (PN)
- MATTE BLACK (MB)

## SIZES

- 800 x 500MM
- 1200 x 500MM

## WARRANTY



Limited Lifetime Warranty  
Garantie à vie limitée  
Garantia limitada de por vida



Product Code	Finishes	Sizes (mm)		Sizes (Inches)		Output (Watts/BTU)	Element Size	Number of Elements
		Height	Width	Height	Width			
AGS-0800500	PC, BN, PN, MB	800	500	31.50	19.69	262 / 895	150W	8
AGS-1200500	PC, BN, PN, MB	1200	500	47.24	19.69	393 / 1342	300W	12



# AUGUSTA SERIES



ATLANTA

AUGUSTA

BOSTON

CHICAGO

DALLAS

DENVER

SEATTLE

TUCSON

PRODUCT CODE	NAME	FINISH	PRICE
--------------	------	--------	-------

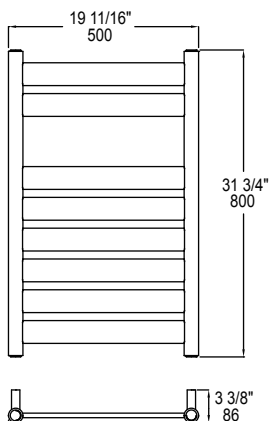

AGS-0800500-PC	Towel Warmer	Polished Chrome	\$795
----------------	--------------	-----------------	-------

AGS-0800500-BN	Towel Warmer	Brushed Nickel	\$975
----------------	--------------	----------------	-------

AGS-0800500-PN	Towel Warmer	Polished Nickel	\$975
----------------	--------------	-----------------	-------

AGS-0800500-MB	Towel Warmer	Matte Black	\$820
----------------	--------------	-------------	-------

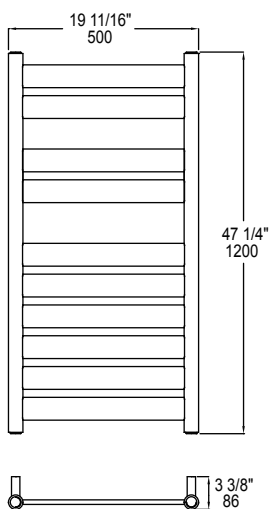

AGS-1200500-PC	Towel Warmer	Polished Chrome	\$950
----------------	--------------	-----------------	-------

AGS-1200500-BN	Towel Warmer	Brushed Nickel	\$1275
----------------	--------------	----------------	--------

AGS-1200500-PN	Towel Warmer	Polished Nickel	\$1275
----------------	--------------	-----------------	--------

AGS-1200500-MB	Towel Warmer	Matte Black	\$975
----------------	--------------	-------------	-------

AVAILABLE FINISHES

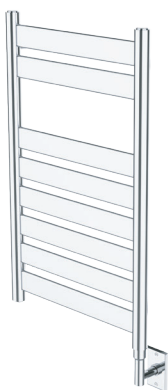

Polished Chrome (PC)

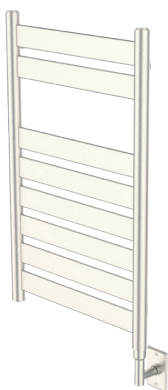

Brushed Nickel (BN)

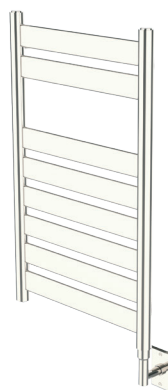

Polished Nickel (PN)

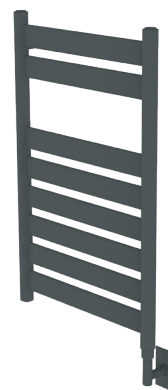

Matte Black (MB)

# BOSTON SERIES



## BOS-0800500-PC

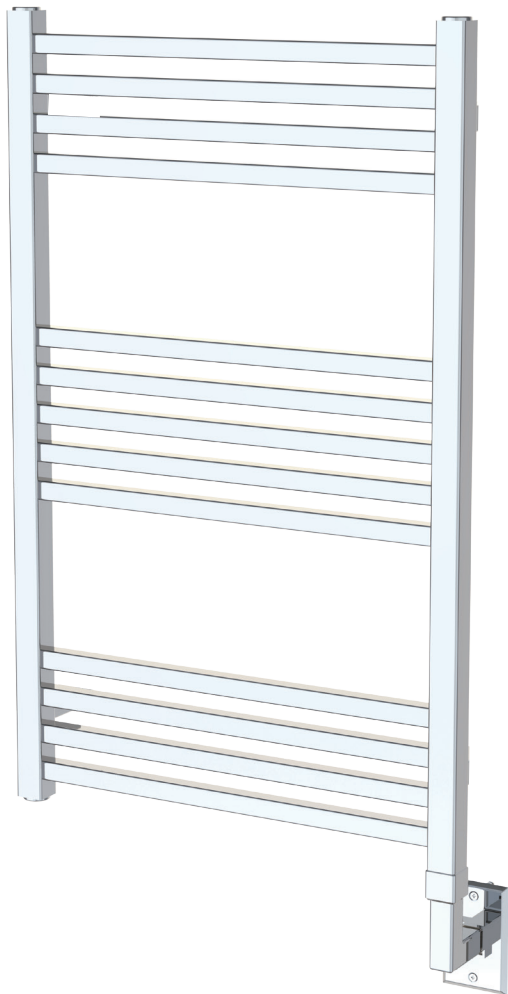

## FEATURES

- WALL MOUNTED
  - HARDWIRE INSTALLATION KIT
  - MOUNTING INSTRUCTIONS
  - ALL ELECTRIC AND OIL FILLED
  - COVER PLATES
- TIMERS AVAILABLE SEPARATELY (NOT INCLUDED)

## FINISHES IN STOCK

- POLISHED CHROME (PC)
- BRUSHED NICKEL (BN)
- POLISHED NICKEL (PN)
- MATTE BLACK (MB)

## SIZES

- 800 x 500MM
- 1200 x 600MM

## WARRANTY



Limited Lifetime Warranty  
 Garantie à vie limitée  
 Garantía limitada de por vida



Product Code	Finishes	Sizes (mm)		Sizes (Inches)		Output (Watts/BTU)	Element Size	Number of Elements
		Height	Width	Height	Width			
BOS-0800500	PC, BN, PN, MB	800	500	31.50	19.69	255 / 870	150W	13
BOS-1200600	PC, BN, PN, MB	1200	600	47.24	23.62	452 / 1543	300W	20

# BOSTON SERIES



ATLANTA

AUGUSTA

BOSTON

CHICAGO

DALLAS

DENVER

SEATTLE

TUCSON

PRODUCT CODE	NAME	FINISH	PRICE
--------------	------	--------	-------

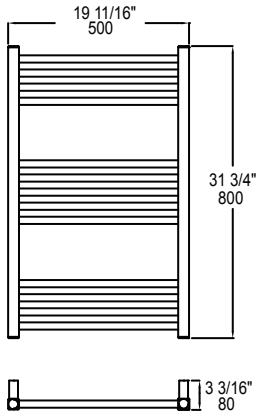

BOS-0800500-PC	Towel Warmer	Polished Chrome	\$500
BOS-0800500-BN	Towel Warmer	Brushed Nickel	\$875
BOS-0800500-PN	Towel Warmer	Polished Nickel	\$875
BOS-0800500-MB	Towel Warmer	Matte Black	\$500

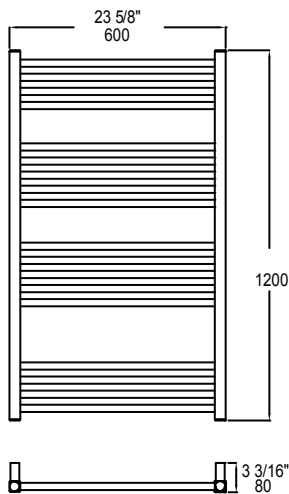

BOS-1200600-PC	Towel Warmer	Polished Chrome	\$950
BOS-1200600-BN	Towel Warmer	Brushed Nickel	\$1125
BOS-1200600-PN	Towel Warmer	Polished Nickel	\$1125
BOS-1200600-MB	Towel Warmer	Matte Black	\$975

AVAILABLE FINISHES



Polished Chrome (PC)



Brushed Nickel (BN)



Polished Nickel (PN)

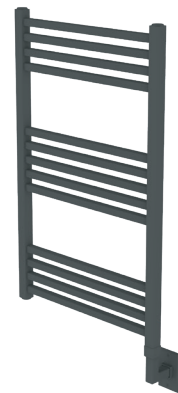

Matte Black (MB)

# CHICAGO SERIES



## ORD-0800500-PC



## FEATURES

- WALL MOUNTED
  - HARDWIRE INSTALLATION KIT
  - MOUNTING INSTRUCTIONS
  - ALL ELECTRIC AND OIL FILLED
  - COVER PLATES
- TIMERS AVAILABLE SEPARATELY (NOT INCLUDED)

## FINISHES IN STOCK

- POLISHED CHROME (PC)
- POLISHED NICKEL (PN)
- MATTE BLACK (MB)

## SIZES

- 800 x 500MM
- 1200 x 600MM

## WARRANTY



Limited Lifetime Warranty  
 Garantie à vie limitée  
 Garantia limitada de por vida



Product Code	Finishes	Sizes (mm)		Sizes (Inches)		Output (Watts/BTU)	Element Size	Number of Elements
		Height	Width	Height	Width			
ORD-0800500	PC, PN, MB	800	500	31.50	19.69	254 / 866	150W	13
ORD-1200600	PC, PN, MB	1200	600	47.24	23.62	484 / 1651	300W	22

# CHICAGO SERIES



ATLANTA

AUGUSTA

BOSTON

CHICAGO

DALLAS

DENVER

SEATTLE

TUCSON

PRODUCT CODE	NAME	FINISH	PRICE
--------------	------	--------	-------

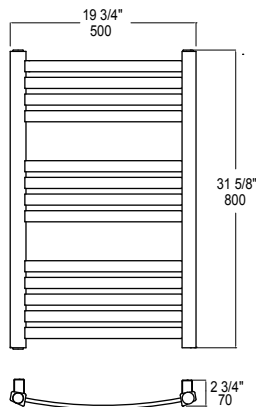

ORD-0800500-PC	Towel Warmer	Polished Chrome	\$775
ORD-0800500-PN	Towel Warmer	Polished Nickel	\$960
ORD-0800500-MB	Towel Warmer	Matte Black	\$800

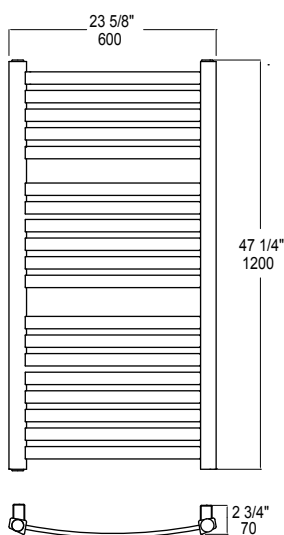

ORD-1200600-PC	Towel Warmer	Polished Chrome	\$960
ORD-1200600-PN	Towel Warmer	Polished Nickel	\$1200
ORD-1200600-MB	Towel Warmer	Matte Black	\$985

— AVAILABLE FINISHES



Polished Chrome (PC)



Polished Nickel (PN)

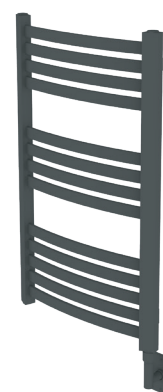

Matte Black (MB)

# DALLAS SERIES



## DAL-0800600-PC



## FEATURES

- WALL MOUNTED
  - HARDWIRE INSTALLATION KIT
  - MOUNTING INSTRUCTIONS
  - ALL ELECTRIC AND OIL FILLED
  - COVER PLATES
- TIMERS AVAILABLE SEPARATELY (NOT INCLUDED)

## FINISHES IN STOCK

- POLISHED CHROME (PC)
- BRUSHED NICKEL (BN)
- MATTE BLACK (MB)

## SIZES

- 800 x 600MM
- 1200 x 600MM

## WARRANTY



Limited Lifetime Warranty  
Garantie à vie limitée  
Garantia limitada de por vida



Product Code	Finishes	Sizes (mm)		Sizes (Inches)		Output (Watts/BTU)	Element Size	Number of Elements
		Height	Width	Height	Width			
DAL-0800600	PC, BN, MB	800	600	31.50	23.62	293 / 1000	150W	13
DAL-1200600	PC, BN, MB	1200	600	47.24	23.62	448 / 1528	300W	20

# DALLAS SERIES



ATLANTA

AUGUSTA

BOSTON

CHICAGO

DALLAS

DENVER

SEATTLE

TUCSON

PRODUCT CODE	NAME	FINISH	PRICE
--------------	------	--------	-------

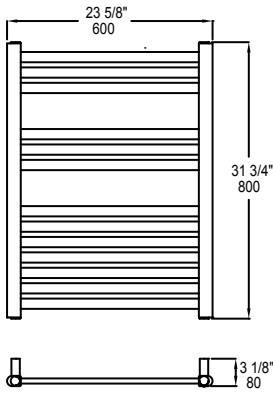

DAL-0800600-PC	Towel Warmer	Polished Chrome	\$790
DAL-0800600-BN	Towel Warmer	Brushed Nickel	\$930
DAL-0800600-MB	Towel Warmer	Matte Black	\$815

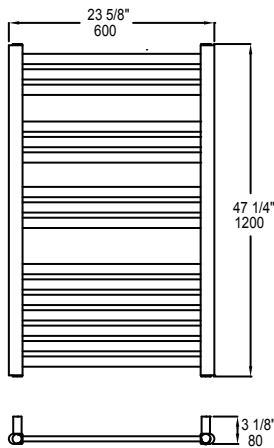

DAL-1200600-PC	Towel Warmer	Polished Chrome	\$950
DAL-1200600-BN	Towel Warmer	Brushed Nickel	\$1100
DAL-1200600-MB	Towel Warmer	Matte Black	\$975

AVAILABLE FINISHES



Polished Chrome (PC)



Brushed Nickel (BN)



Matte Black (MB)

# DENVER SERIES



## DEN-0800600-PC

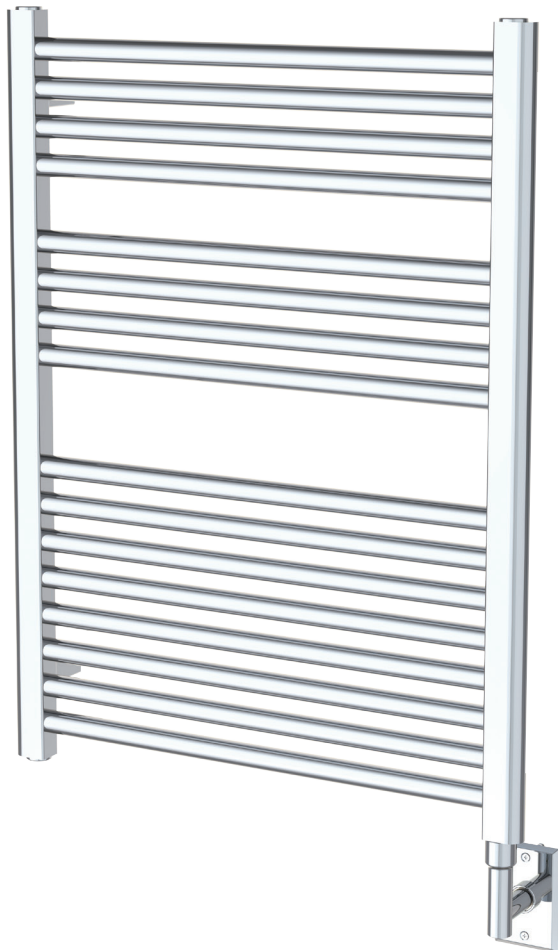

## FEATURES

- WALL MOUNTED
  - HARDWIRE INSTALLATION KIT
  - MOUNTING INSTRUCTIONS
  - ALL ELECTRIC AND OIL FILLED
  - COVER PLATES
- TIMERS AVAILABLE SEPARATELY (NOT INCLUDED)

## FINISHES IN STOCK

- POLISHED CHROME (PC)
- BRUSHED NICKEL (BN)
- POLISHED NICKEL (PN)
- MATTE BLACK (MB)

## SIZES

- 800 x 600 MM
- 1200 x 600 MM

## WARRANTY



Limited Lifetime Warranty  
 Garantie à vie limitée  
 Garantía limitada de por vida



Product Code	Finishes	Sizes (mm)		Sizes (Inches)		Output (Watts/BTU)	Element Size	Number of Elements
		Height	Width	Height	Width			
DEN-0800600	PC, BN, PN, MB	800	600	31.50	23.62	347 / 1184	150W	16
DEN-1200600	PC, BN, PN, MB	1200	600	47.24	23.62	520 / 1776	300W	24



# DENVER SERIES



ATLANTA

AUGUSTA

BOSTON

CHICAGO

DALLAS

DENVER

SEATTLE

TUCSON

PRODUCT CODE	NAME	FINISH	PRICE
--------------	------	--------	-------

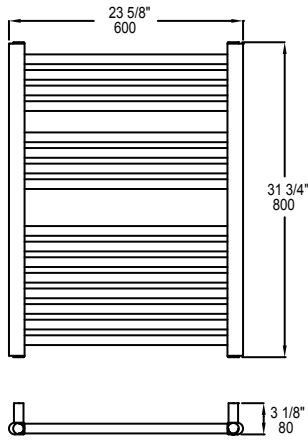

DEN-0800600-PC	Towel Warmer	Polished Chrome	\$790
----------------	--------------	-----------------	-------

DEN-0800600-BN	Towel Warmer	Brushed Nickel	\$975
----------------	--------------	----------------	-------

DEN-0800600-PN	Towel Warmer	Polished Nickel	\$975
----------------	--------------	-----------------	-------

DEN-0800600-MB	Towel Warmer	Matte Black	\$815
----------------	--------------	-------------	-------

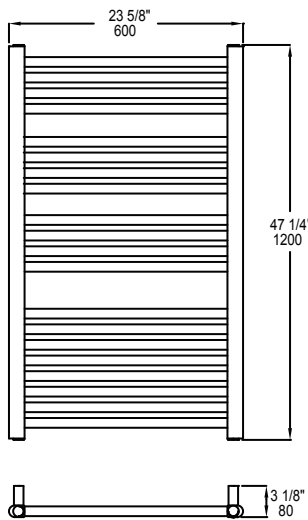

DEN-1200600-PC	Towel Warmer	Polished Chrome	\$890
----------------	--------------	-----------------	-------

DEN-1200600-BN	Towel Warmer	Brushed Nickel	\$1150
----------------	--------------	----------------	--------

DEN-1200600-PN	Towel Warmer	Polished Nickel	\$1150
----------------	--------------	-----------------	--------

DEN-1200600-MB	Towel Warmer	Matte Black	\$915
----------------	--------------	-------------	-------

AVAILABLE FINISHES

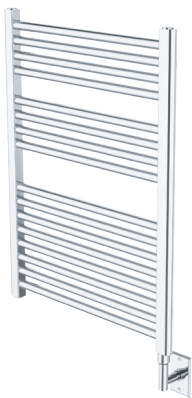

Polished Chrome (PC)

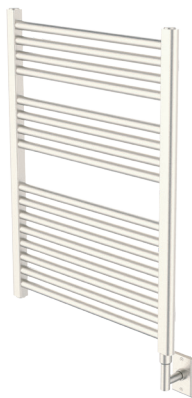

Brushed Nickel (BN)



Polished Nickel (PN)

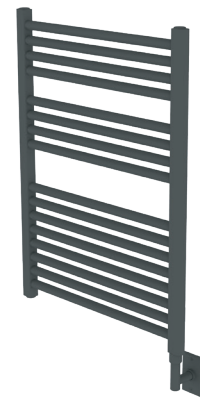

Matte Black (MB)

## SEA-0800600-PC



## FEATURES

- WALL MOUNTED
  - HARDWIRE INSTALLATION KIT
  - MOUNTING INSTRUCTIONS
  - ALL ELECTRIC AND OIL FILLED
  - COVER PLATES
- TIMERS AVAILABLE SEPARATELY (NOT INCLUDED)

## FINISHES IN STOCK

- POLISHED CHROME (PC)
- BRUSHED NICKEL (BN)
- POLISHED NICKEL (PN)
- MATTE BLACK (MB)

## SIZES

- 800 x 600 MM
- 1200 x 600 MM

## WARRANTY



Limited Lifetime Warranty  
 Garantie à vie limitée  
 Garantia limitada de por vida



Product Code	Finishes	Sizes (mm)		Sizes (Inches)		Output (Watts/BTU)	Element Size	Number of Elements
		Height	Width	Height	Width			
SEA-0800600	PC, BN, PN, MB	800	600	31.50	23.62	288 / 981	150W	16
SEA-1200600	PC, BN, PN, MB	1200	600	47.24	23.62	431 / 1472	300W	24

# SEATTLE SERIES



ATLANTA

AUGUSTA

BOSTON

CHICAGO

DALLAS

DENVER

SEATTLE

TUCSON

PRODUCT CODE	NAME	FINISH	PRICE
--------------	------	--------	-------

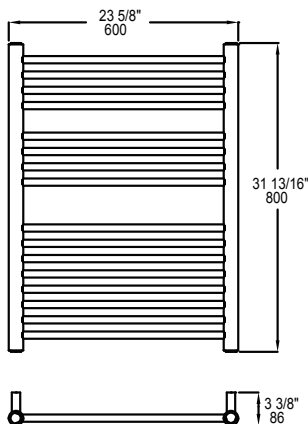

SEA-0800600-PC	Towel Warmer	Polished Chrome	\$810
----------------	--------------	-----------------	-------

SEA-0800600-BN	Towel Warmer	Brushed Nickel	\$975
----------------	--------------	----------------	-------

SEA-0800600-PN	Towel Warmer	Polished Nickel	\$975
----------------	--------------	-----------------	-------

SEA-0800600-MB	Towel Warmer	Matte Black	\$835
----------------	--------------	-------------	-------

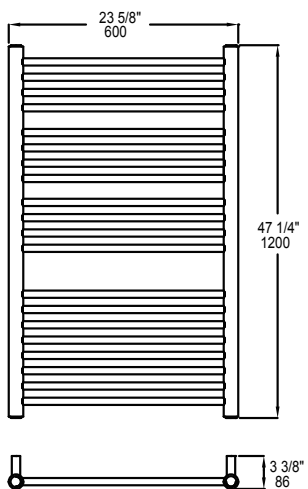

SEA-1200600-PC	Towel Warmer	Polished Chrome	\$925
----------------	--------------	-----------------	-------

SEA-1200600-BN	Towel Warmer	Brushed Nickel	\$1150
----------------	--------------	----------------	--------

SEA-1200600-PN	Towel Warmer	Polished Nickel	\$1150
----------------	--------------	-----------------	--------

SEA-1200600-MB	Towel Warmer	Matte Black	\$950
----------------	--------------	-------------	-------

AVAILABLE FINISHES

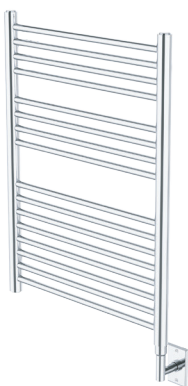

Polished Chrome (PC)



Brushed Nickel (BN)



Polished Nickel (PN)

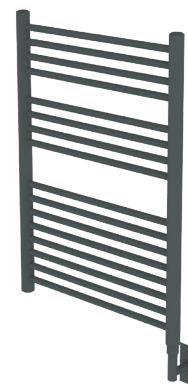

Matte Black (MB)

# TUCSON SERIES



## TUS-0920600-PC

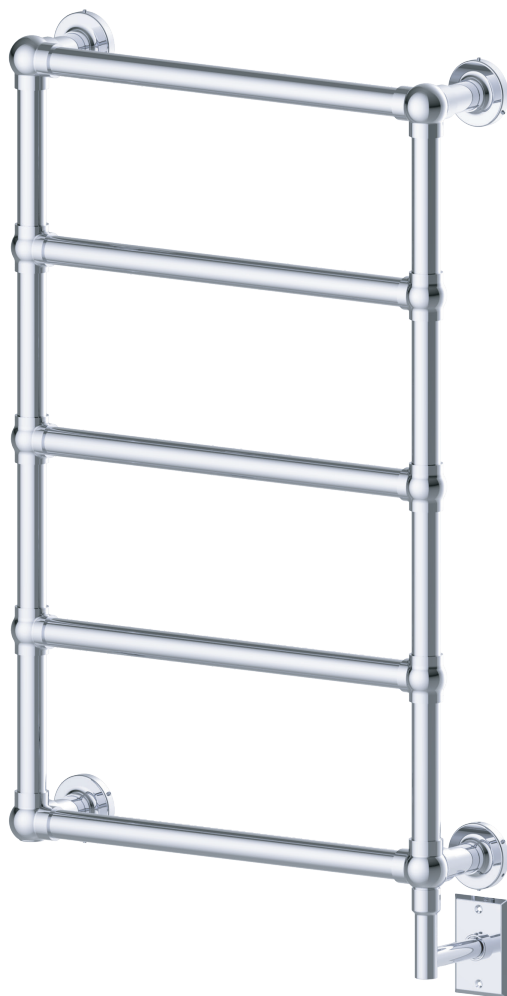

## FEATURES

- WALL MOUNTED
  - HARDWIRE INSTALLATION KIT
  - MOUNTING INSTRUCTIONS
  - ALL ELECTRIC AND OIL FILLED
  - COVER PLATES
- TIMERS AVAILABLE SEPARATELY (NOT INCLUDED)

## FINISHES IN STOCK

- POLISHED CHROME (PC)
- BRUSHED NICKEL (BN)
- POLISHED NICKEL (PN)

## SIZES

- 920 x 600 MM

## WARRANTY



Limited Lifetime Warranty  
Garantie à vie limitée  
Garantia limitada de por vida



Vernon Towel Warmer Hardwire Kit Round -PC  
Code: VTW-HWK-RD-PC

Product Code	Finishes	Sizes (mm)		Sizes (Inches)		Output (Watts/BTU)	Element Size	Number of Elements
		Height	Width	Height	Width			
TUS-0920600	PC, BN, PN	920	600	36.62	23.62	208 / 709	300W	5

# TUCSON SERIES



ATLANTA

AUGUSTA

BOSTON

CHICAGO

DALLAS

DENVER

SEATTLE

TUCSON

PRODUCT CODE	NAME	FINISH	PRICE
--------------	------	--------	-------

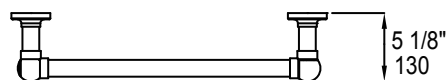
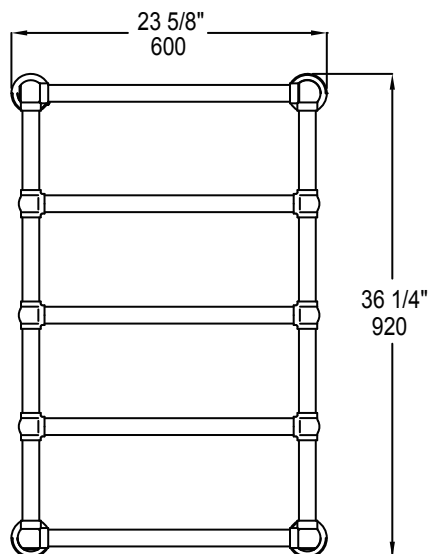

TUS-0920600-PC	Towel Warmer	Polished Chrome	\$880
TUS-0920600-BN	Towel Warmer	Brushed Nickel	\$1300
TUS-0920600-PN	Towel Warmer	Polished Nickel	\$1300

AVAILABLE FINISHES

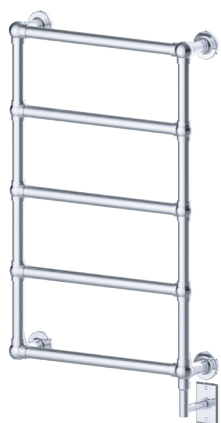

Polished Chrome (PC)

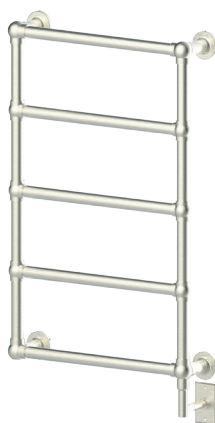

Brushed Nickel (BN)



Polished Nickel (PN)

# INDEX



<b>ATLANTA</b>	<b>5</b>	BOS-1200600-PN	7	<b>SEATTLE</b>	<b>11</b>
ATL-0800600-PC	5	BOS-1200600-MB	7	SEA-0800600-PC	11
ATL-0800600-BN	5			SEA-0800600-BN	11
ATL-0800600-PN		<b>CHICAGO</b>	<b>8</b>	SEA-0800600-PN	11
ATL-0800600-MB	5	ORD-0800500-PC	8	SEA-0800600-MB	11
ATL-1200600-PC	5	ORD-0800500-PN	8	SEA-1200600-PC	11
ATL-1200600-BN	5	ORD-0800500-MB	8	SEA-1200600-BN	11
ATL-1200600-PN	5	ORD-1200600-PC	8	SEA-1200600-PN	11
ATL-1200600-MB	5	ORD-1200600-PN	8	SEA-1200600-MB	11
		ORD-1200600-MB	8		
<b>AUGUSTA</b>	<b>6</b>			<b>TUCSON</b>	<b>12</b>
AGS-0800500-PC	6	<b>DALLAS</b>	<b>9</b>	TUS-0920600-PC	12
AGS-0800500-BN	6	DAL-0800600-PC	7	TUS-0920600-BN	12
AGS-0800500-PN	6	DAL-0800600-BN	7	TUS-0920600-PN	12
AGS-0800500-MB	6	DAL-0800600-MB	7		
AGS-1200500-PC	6	DAL-1200600-PC	7		
AGS-1200500-BN	6	DAL-1200600-BN	7		
AGS-1200500-PN	6	DAL-1200600-MB	7		
AGS-1200500-MB	6				
		<b>DENVER</b>	<b>10</b>		
<b>BOSTON</b>	<b>7</b>	DEN-0800600-PC	5		
BOS-0800500-PC	7	DEN-0800600-BN	5		
BOS-0800500-BN	7	DEN-0800600-PN	5		
BOS-0800500-PN	7	DEN-0800600-MB	5		
BOS-0800500-MB	7	ATL-1200600-PC	5		
BOS-1200600-PC	7	ATL-1200600-BN	5		
BOS-1200600-BN	7	ATL-1200600-PN	5		
		ATL-1200600-MB	5		



## CARE & WARRANTY

### Vernon Towel Warmers Inc.: Care instructions and Limited Lifetime Warranty Information

Thank you for purchasing your Vernon Towel Warmers. Each of our products are manufactured with advanced technology, assuring durability, high quality and the best design. Sydney products are manufactured using internationally met standards of lead and cadmium free copper which is also anti-bacterial.

#### Care Instructions

To care for your new Vernon Towel Warmers, clean regularly with a soft, damp cloth or sponge. Do not use rough or abrasive cleaning products that may compromise your warranty. Over time, some finishes will gently age in appearance under normal use. These finish changes are not considered a manufacturing defect and is excluded under warranty.

#### Limited Lifetime Warranty

We are pleased to offer a **LIMITED LIFETIME WARRANTY\*** – you are eligible if the product fails due to defects in materials or workmanship. Vernon Towel Warmers have been manufactured under the highest standards of quality and workmanship. Vernon Towel Warmers Inc. warrant these products to be free from defects in material and workmanship. Proof of purchase (original sales receipt) from the original customer must accompany all warranty claims. Vernon Towel Warmers will advise you of the procedure to follow in making warranty claims. Simply contact Vernon Towel Warmers, explain the defect and supply proof of purchase along with your name, address, area code and telephone number. Vernon Towel Warmers Inc. decision is absolutely final and without informal arbitration. Each product shipped will have a limited lifetime warranty enclosed with the below limitations, the below exclusions and the warranty period covered. The sole and exclusive remedy for any defect in material or workmanship under the Warranty is that a new part or product shall be mailed free of charge, and postage prepaid to the party under the Warranty. Vernon Towel Warmers is not responsible for any labour charges, injuries or any other loss or damages whatsoever. Defects or damage caused by the use of other than genuine parts are not covered by the Warranty. The Warranty is not valid unless all amounts payable by the buyer to Vernon Towel Warmers Inc., have been paid in full (including any extras, service calls or other amounts due). Vernon Towel Warmers Inc. , does not assume any liability for any work performed by third parties. There is no warranty or implied warranty other than specified above.

#### FREIGHT TERMS:

Freight allowed and prepaid to all points in North America on any order over \$1,500 or more net invoice value.

#### CLAIMS:

Any claim for errors or shortages for which Vernon Towel Warmers Inc. is responsible must be reported within 10 days after receipt of merchandise. Claims for damaged or lost shipments must be made to the carrier.

#### RETURNED GOODS/CANCELLATION:

No merchandise may be returned without written consent from Vernon Towel Warmers Inc. The RGA "Returned Goods Authorization Number" must be shown on all labels and a copy of the RGA form should be included. A 25% re-stocking charge may be applicable.

Orders for modified, special order, project order or custom products, as well as those not listed in current list books, may not be cancelled or returned. Orders for all other product in current list price books may be cancelled prior to the shipment leaving Vernon Towel Warmers Inc. Special Order Finishes (finishes other than those stocked by Vernon Towel Warmers Inc., per stocking chart) may be cancelled in 24 hours of order but may not be cancelled or returned after 24 hours of order being placed.

Vernon Towel Warmers Inc. reserves the right to give partial or no credit for the following reasons: Improperly returned merchandise, used product with no resale value as deemed by Vernon Towel Warmers Inc., merchandise has been returned after fourteen (14) days of RGA approval, merchandise did not originate from Vernon Towel Warmers Inc., or the product returned does not match the reasons for return stated on the initial RGA request.

to the original consumer during the life of the product. The product must be in the original installation site from the date of purchase to be considered. The original sales receipt must be provided to Vernon Towel Warmers Inc. for all warranty claims.

The warranty excludes products that have been accidentally damaged, altered, misused, normal wear and tear or damaged through use of abrasive cleaning agents. This warranty does not cover shipping costs for replacement parts, service or labour costs to replace this product. This is Vernon Towel Warmers Inc. exclusive written warranty. **Enjoy your Vernon Towel Warmers!**



To obtain warranty service contact:

Local Dealer: See dealer locator at [vernontowelwarmers.com](http://vernontowelwarmers.com)  
Call Toll Free: 1-877-490-3537

**Vernon Towel Warmers Inc.**  
**1146 15th Street West - North Vancouver, BC V7P 1M9**

Email us at [support@vernontowelwarmers.com](mailto:support@vernontowelwarmers.com)

