

CAMARGUE SKYE®

PRODUCT INFORMATION



TABLE OF CONTENTS

Description	3
Benefits	4
Design	4
Quality	5
Customization	7
Comfort	7
Technical details	8
Standard configuration	9
Camargue Skye weight	10
Camargue Skye snow load	11
Accessories	12
Certificates & testing	14
Configuration	15
Type	15
Construction method	18
Columns	20
Profiles	22
Blade orientation	23
Mounting bases	24
Water drainage	26
Other tools	27





DESCRIPTION

Modular aluminum patio cover with rotating and sliding blades and integrated side elements.

- Fully retractable roof
- Durable rotation and sliding technology thanks to patented S-drive technology
- All accessories are beautifully integrated
- Can be joined in multiple parts in the span or pivot
- Protection from the sun, rain and wind
- Can be controlled using RTS or the Renson® Connect App*



One roof section

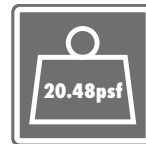

SUN
PROTECTION

VENTILATING

WATER
RESISTANT

RETRACTABLE

* Full operation via the Renson Connect app is only possible in countries where Somfy is legally allowed. In countries where only Somfy RTS is allowed, operation of Fixscreen, Led-lighting and heating is done via separate hand transmitter.

BENEFITS

Design



1 THE ROOF IS COMPLETELY FLAT WHEN CLOSED

2 MINIMAL GAPS BETWEEN THE BLADES

3 MODULAR DESIGN

Expandable to include multiple roof sections, even after initial installation. The structure can be endlessly expanded on both the span and pivot side to cover large surface areas.

4 INVISIBLE SCREWS

Create an elegant and sleek structure

5 THE FABRIC ROLLER TUBE IS FULLY

INTEGRATED INTO THE STRUCTURE

INNOVATION

No visible screen head box disrupting the aesthetic

6 THE BOTTOM BAR DISAPPEARS INTO THE HEAD BOX

7 INTEGRATED MOTOR FORMS A STUNNING MINIMALIST DESIGN, WITHOUT A MOTOR DISRUPTING THE AESTHETIC

8 INTEGRATED FIXSCREEN SIDE GUIDING CHANNELS IN THE COLUMNS

INNOVATION

Full aesthetic integration with the Camargue structure

Quality



1 'TRAIN' SYSTEM (OTHER BRANDS ON THE MARKET)

Only the first blade [the locomotive] is driven, and all other blades [the carriages] are passively pulled along

2 SYNCHRONISED DRIVE ON BOTH SIDES OF THE BLADES

Even with an asymmetric load, the roof will open and close in one smooth movement

3 RENSON® S-DRIVE

INNOVATION

Driven by a spindle that evenly distributes traction across all blades

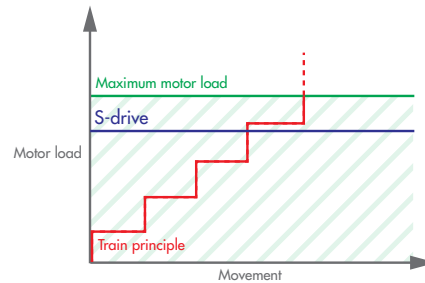

4 SPINDLE FOR SLIDING BLADES

INNOVATION

5 TROLLEYS ON RAILS ENSURE SMOOTH AND STABLE MOVEMENT

Each blade is driven individually

6 HEXAGONAL AXLE FOR ROTATING BLADES

7 STRONG, DOUBLE-WALLED BLADES CAN HANDLE HEAVY SNOW LOADS



8 UNIQUE END CAPS

Provide a solid corner connection and perfect water drainage

9 NO HOLES IN THE WATER CHANNEL

An additional chamber means no holes need to be drilled in the water channel when affixing side inserts.

10 WELDED ALUMINUM DRIPS, POWDER COATED TO MATCH THE COLOR OF THE ROOF BLADES

11 INTEGRATED WATER DRAINAGE WITH LARGE FLOW RATE

Through the wide blade gutters, water flows towards the gutters (with diffusers to counter splashing) before being drained via PVC drainpipes integrated into the columns.

Customization

1 WIDEST RANGE OF SIDE INFILLS

2 BACK ORDERS POSSIBLE

3 ACCESSORIES

For more information about the possible accessories, see the 'Accessories' section and/or the product information for the various accessories.



Comfort

1 MAXIMUM NATURAL LIGHT

The blades not only rotate through 135°, they can also be fully retracted

2 SPECIALLY DEVELOPED GUTTER BORDER

INNOVATION

Prevents your patio and furniture from getting wet when the blades are opened following a rain shower

3 SILENT AND SOFT CLOSING MECHANISM BY ADDING A BRUSH TO THE BLADES

4 QUICK INSTALLATION

Thanks to maximum pre-assembly and the modular structure of the various junctions



TECHNICAL DETAILS



Dimensions	
Span	Min. 71"* - max. 177"
Pivot	Min. 128"* - max. 244"/277"
Passage height	Min. 17" - max. 110"
Total height with blades closed	Passage height + 10 15/64"
Total height with blades 90° open	Passage height + 1' 1 31/32"
Minimum height required when installed under a roof overhang	Passage height + 1' 2 3/8"
Blade rotation	Max. 135°
Minimum number of water drainage points < 172sqm	1
Minimum number of water drainage points > 172sqm	2**
Operating methods	
Renson® Connect App***	✓
Renson Connect App + transmitter ****	✓
Home automation ready	✓

* Smaller dimensions [span min. 1800 mm and pivot min. 1256 mm] possible by special request to pre-sales - drawing office.

** Please note: If only one column is used, the water drainage capacity will be limited to 0.025 l/m².s [90 l/h]

*** For countries where Somfy io is legally allowed

**** For countries where only Somfy RTS is allowed

Electrical bladed roof drive

Parameters	Value
Supply voltage	110V AC, 50 Hz
Transformer current range	0 - 3.5 Ampère
Transformer power	2 x 150 W
Motor voltage	24 Volt DC
Motor nominal current	6 Ampère
Protection rating	IP 65
Maximum running time with continuous use	Approx. 10 minutes
Automatic	16 A Curve C



Standard configuration

Structure

- Free-standing or façade mounted (against whole wall or partial connection)
- Standard mounting bases (visible, invisible or cast)
- Custom span, pivot and passage height made to measure

Finish

- Seaside Quality A
- Monocolour or dual color according to Renson® standard colors
- Integrated water drainage (incl. PVC drainage pipes and anti-splash diffusers in the gutter)
- Adjustable installation and drainage holes

Camargue Skye weight

		Total weight (lbs) of entire Camargue Skye								
		Span								
Pivot	Dimensions in inch	# blades	59	78	98	118	137	157	177	
		127	13	519	591	662	735	807	878	951
		134	14	541	616	691	766	843	918	993
		142	15	567	644	724	803	882	960	1039
		151	16	591	675	757	838	922	1004	1085
		159	17	618	704	790	876	962	1048	1134
		168	18	644	735	823	913	1001	1090	1180
		176	19	671	763	856	948	1041	1134	1226
		185	20	697	794	889	986	1081	1178	1273
		193	21	724	823	922	1021	1120	1220	1319
		201	22	750	851	955	1059	1160	1264	1367
	210	23	777	882	988	1094	1200	1308	1414	
	218	24	803	911	1021	1131	1242	1350	1460	
	227	25	827	942	1054	1167	1281	1394	1506	
	235	26	854	971	1087	1204	1321	1438	1553	
	244	26	874	990	1107	1224	1339	1456	1572	

The table above shows the weight of the Skye frame; the weight of the columns and mounting bases is not included. Each column in the configuration adds an extra weight of 12.57lbs/column metre.

Standard mounting base weight

- invisible mounting base: 4.52lbs
- cast mounting base: 7.92lbs
- visible mounting base: 9.81lbs
- visible [corner]: 6.80lbs

Reinforced mounting base weight

- invisible mounting base: 15.97lbs
- visible mounting base: 24.88lbs
- visible [corner]: 19.87lbs

Camargue Skye snow load

		Maximum snow load Camargue Skye [psf]										
		Span										
Pivot	Dimensions in inch	78	88	98	108	118	127	137	147	157	167	177
		157	177	115	78	55	40	30	23	17	13	10
	167	177	115	78	55	40	30	23	17	13	10	8
	177	177	115	78	55	40	30	23	17	13	10	8
	187	176	115	78	55	40	30	23	17	13	10	8
	196	148	115	78	55	40	30	23	17	13	10	8
	206	126	109	78	55	40	30	23	17	13	10	8
	216	108	94	78	55	40	30	23	17	13	10	8
	226	93	80	71	55	40	30	23	17	13	10	8
	236	81	70	61	54	40	30	23	17	13	10	8
	244	72	62	55	49	40	30	23	17	13	10	8

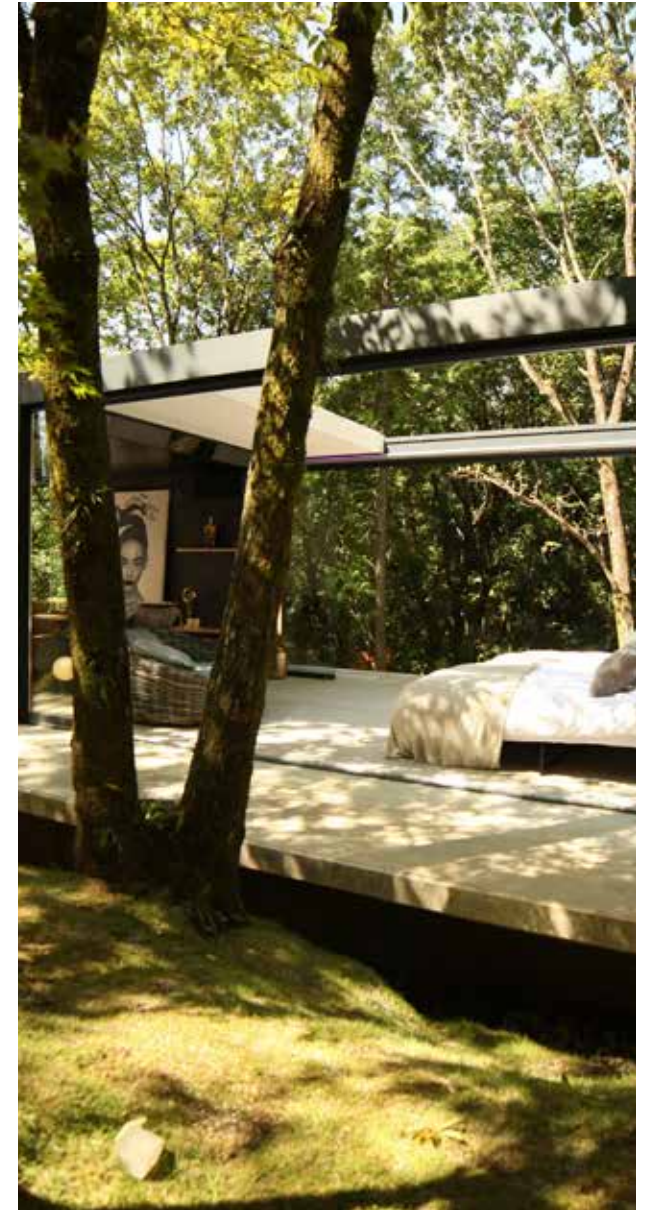

ACCESSORIES



Comfort pack		Back order
Fixscreen + Lineo Led	-	-
Side infills		
Integrated Fixscreen	✓	✓
Algarve Fixscreen	-	-
Lapure Fixscreen	-	-
Triangle	-	-
Loggia® sliding door	✓	✓
Loggiascreen Canvas sliding door	✓	✓
Glass sliding panels*	✓	✓
Linius wall*	✓	✓
Linarte wall*	✓	✓
Outdoor curtains	✓	✓
Comfort		
Lighting		
Lineo Led	-	-
UpDown Led	✓	✓
Colomno Led	✓	-
Lapure Led	-	-
Comfort and design		
Beam Heat & Sound**	✓	✓
Lineo Luce	-	-
Lineo Fix	-	-
Lineo Heat	-	-
Waterproof wall mounting	-	-
Protecto protective profile	-	-
Automation		
Wind sensor	✓	✓
Rain sensor	✓	✓
Sun sensor	-	-

* subject to use of reinforced mounting bases on adjacent columns

** only possible on span, not on pivot

Styling		Back order
Classic Line	-	-
Wooddesign roof blades	✓	-
Columns		
Extra column	✓	-
Shifted column***	✓	-
Adjustable wall column	✓	-

*** Shifted column only possible on the non-pile side



CERTIFICATES & TESTING

CE – DoP documents

- CE / DoC / DoP / ETA

Certificates

- REACH / seaside/coastal powder coating guarantee
- RoHS / AluEco
- VMRG sun protection

Declarations

- Declaration of material codes
- Declaration of powder coating
- Declaration of anodisation layer thickness
- Declaration of glass properties
- Declaration of fire resistance / reaction
- Declaration of endurance cycles
- Declaration of safety resistance water pocket
- Declaration of electrical safety
- Declaration of asbestos
- Declaration of UV resistance / gtot + others

Test reports – calculations

- Environmental statement [recycled aluminum]
- Anchoring requirements
- Wind [load] testing / verification certificate
- Static load test / calculations

Wind guarantee of roof with blades closed	up to 99mph - HC 2 (Hurricane Category 2)
Fixscreen wind guarantee when closed	up to 37mph
Wind guarantee of roof with blades closed and rotated to a vertical position (90°)	74mph
Wind guarantee of roof with blades retracted	99mph - HC 2 (Hurricane Category 2)
Max. wind speed for roof or Fixscreen operation	up to 31mph
Water drainage flow	0.66GPM [gallons per minute]
Load-bearing capacity	20.48psf

Application in sandy environments

The abrasive effect of sand can cause blockages of the Skye mechanism. Therefore the application of Skye systems is not allowed at less than 656 ft from sandy environments such as sandy beaches, dunes, deserts...

CONFIGURATION

Type

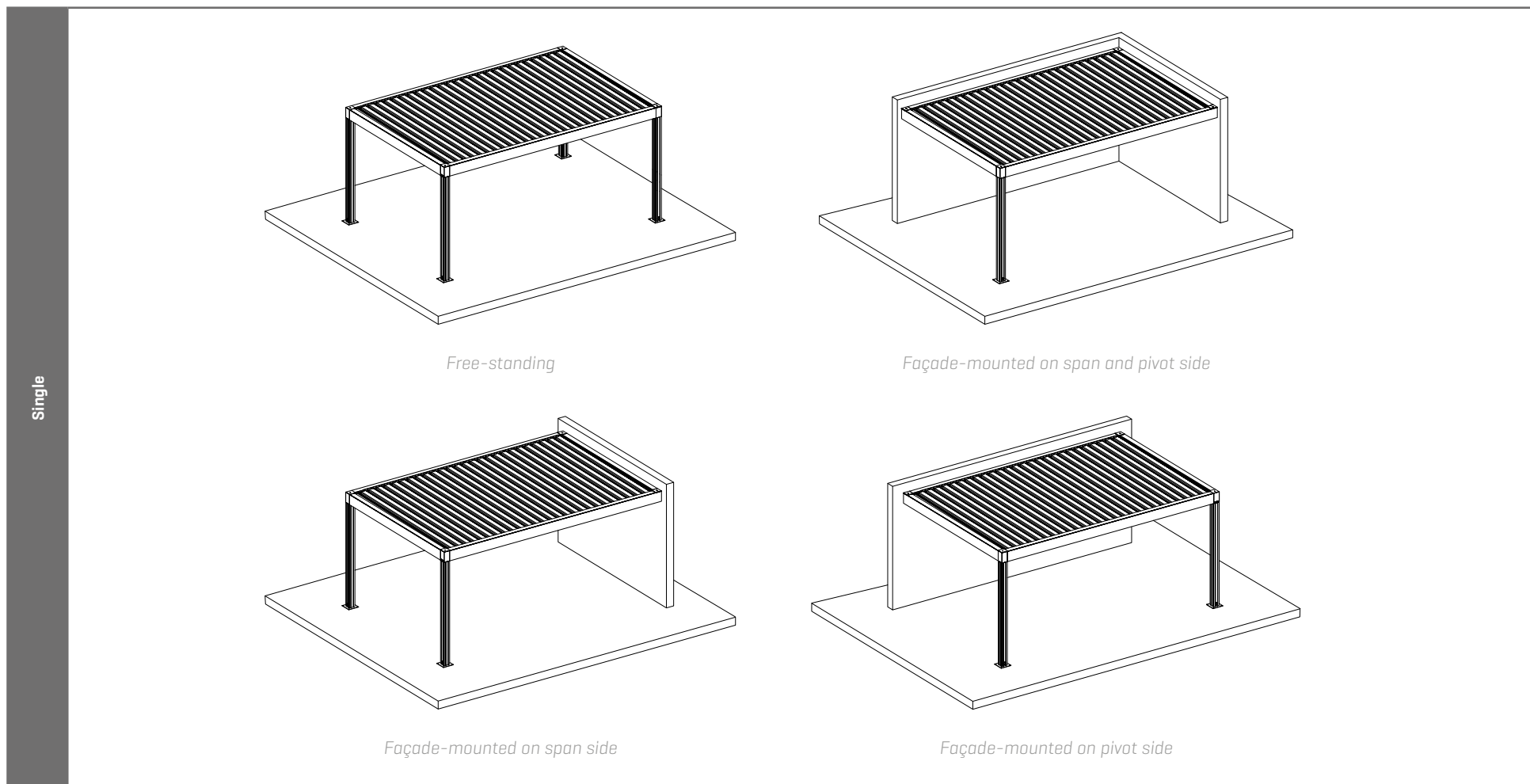

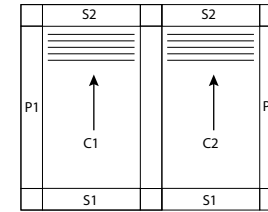
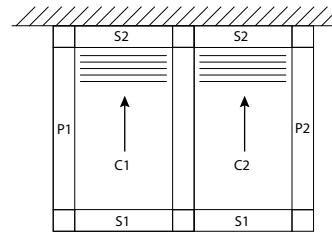
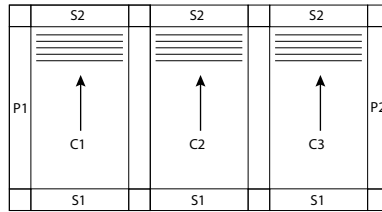

- Joined on 2 or 3 sections
- Stacking direction the same for all roof sections
- For free-standing or wall mounted types [1 or more sides]

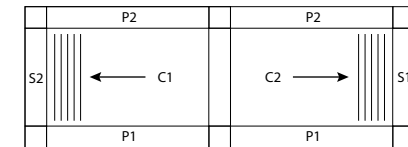
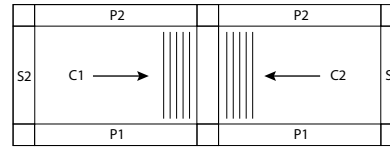
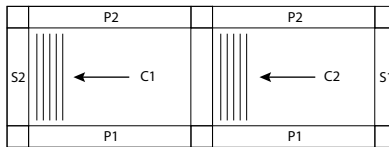

- Joined on 2 sections
- Stacking direction: same direction, towards each other, away from each other
- For free-standing or wall mounted types [1 or more sides]

The blades of the 2 roof sections rotate differently towards each other in the 2 configurations below:

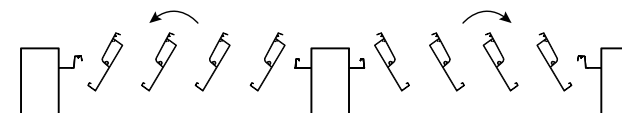
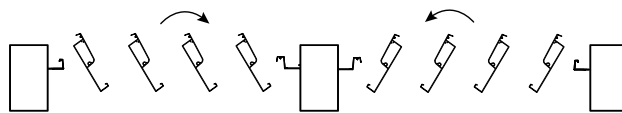
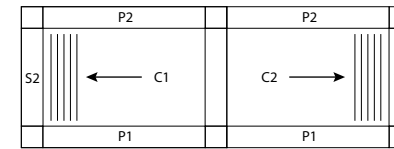
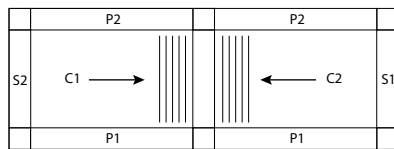

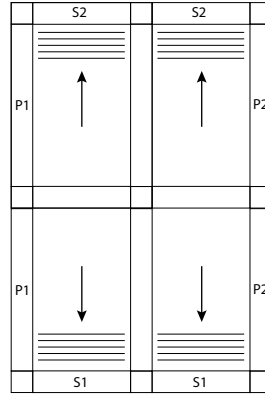
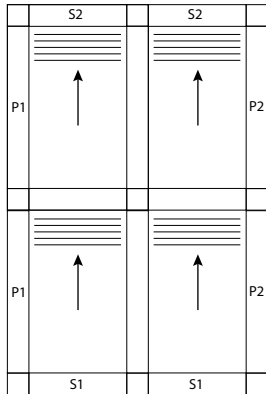

Combination Camargue / Camargue Skye is only possible in the case that all roof sections are of the same type in the span direction. Attention: in that case the coupled pivot of the Camargue part is not as wide as the coupled pivot of the Camargue Skye part, as we do not have existing profiles for that.

Construction method

Free-standing

The sides are completely separate from any walls; the cover is not mounted against any walls.

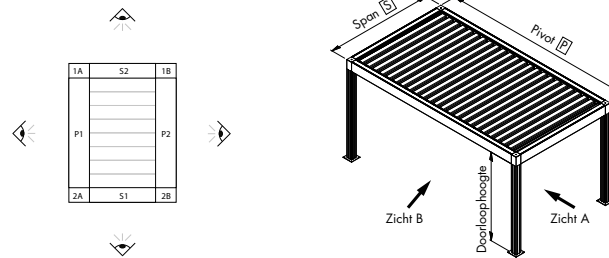

Full-length wall mounted

The full length of the side is mounted against a wall.

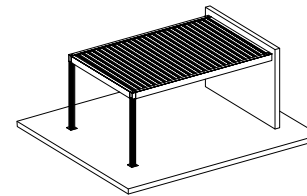
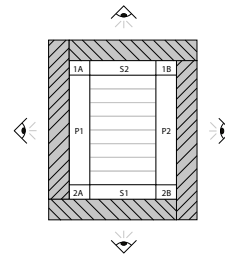

full-length wall mounted [façade mounted] on span side

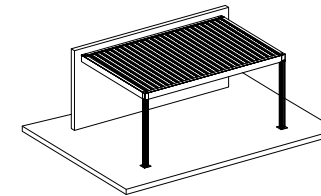

full-length wall mounted [façade mounted] on pivot side

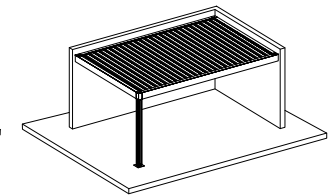

full-length wall mounted [façade mounted] on span and pivot side

Wall to the left

Only part of the side is mounted against a wall. Viewed from outside of the cover, the wall is located on the left side of the beam.

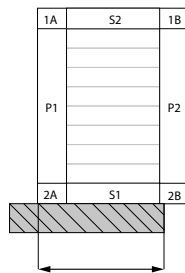

wall length

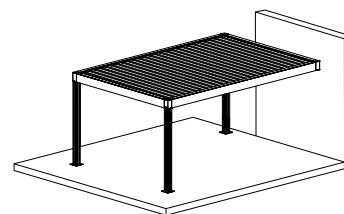

wall to the left [span]

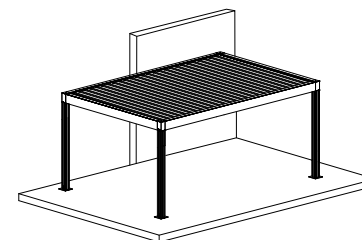

wall to the left [pivot]

Wall to the right

Only part of the side is mounted against a wall. Viewed from outside of the cover, the wall is located on the right side of the beam.

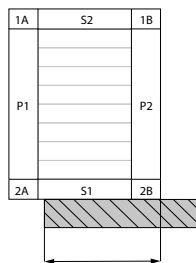

wall length

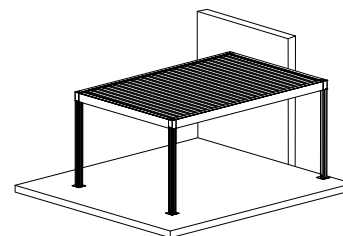

wall to the right [span]

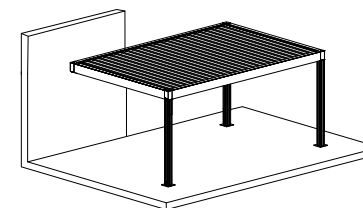

wall to the right [pivot]

Wall in the middle

A limited part of the cover is mounted against a wall. There is a free-standing section of the cover both to the left and to the right of the wall.

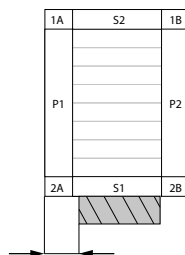

distance on the left to the wall

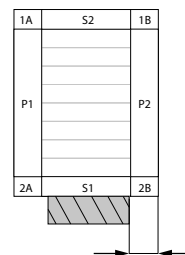

distance on the right to the wall

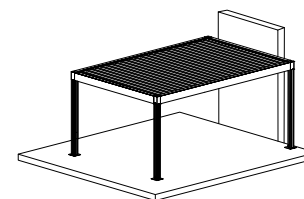

wall in the middle [span]

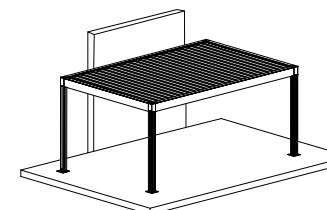

wall in the middle [pivot]

Columns

Corner column

A column is provided for each corner as standard. When installing against a wall that guarantees sufficient stability, the column on this side may be omitted.

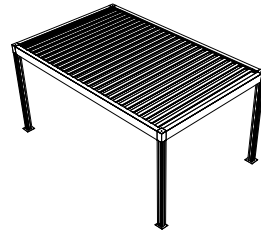

Shifted column

A column may be shifted in the direction of the pivot to a maximum of 1/5 of the pivot length. This guarantees the stability of the construction at all times.

A shifted column in Camargue and Camargue Skye is entered by entering the required distance from the corner. It is not possible to shift a column in the span direction. Shifted column cannot be on S2.

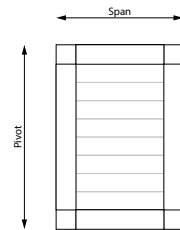
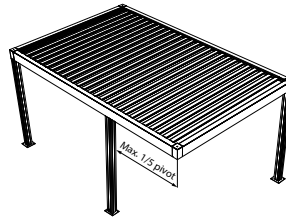

Adjustable wall column

When installing Fixscreens at a right angle to a façade, a column must be fitted.

Given the fact that outside walls are not always built perfectly plumb, a visually disruptive opening may form between the wall and the column. An adjustable wall column guarantees a flush connection and compensates for an angle of $25/64''$ to the front or $25/64''$ to the rear.

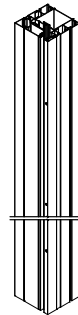
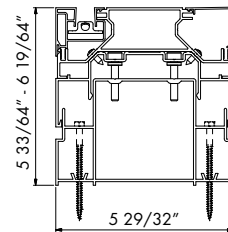

Shorter/longer columns

A column that is longer (positive overlength) or shorter (negative overlength) than the entered passage height may be ordered. Opting for a positive overlength can be useful to keep a roof perfectly level when your patio slopes downward, for example. Alternatively, if one of the columns is to be installed on a small wall, for example, it can be shortened (negative overlength).

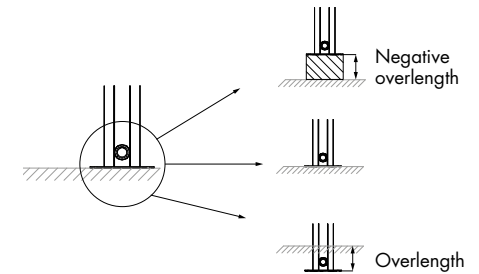

Positive overlength is possible up to the maximum passage height [110"] plus 19" [129"].

Negative overlength is possible up to the minimum passage height [= 19"].

Overlength only affects the price if the column length >118".

Additional column

By adding an additional column, one side of the covering is divided into two parts. The position of the additional column is always viewed from side P1 [additional column on span] or S1 [additional column on pivot].

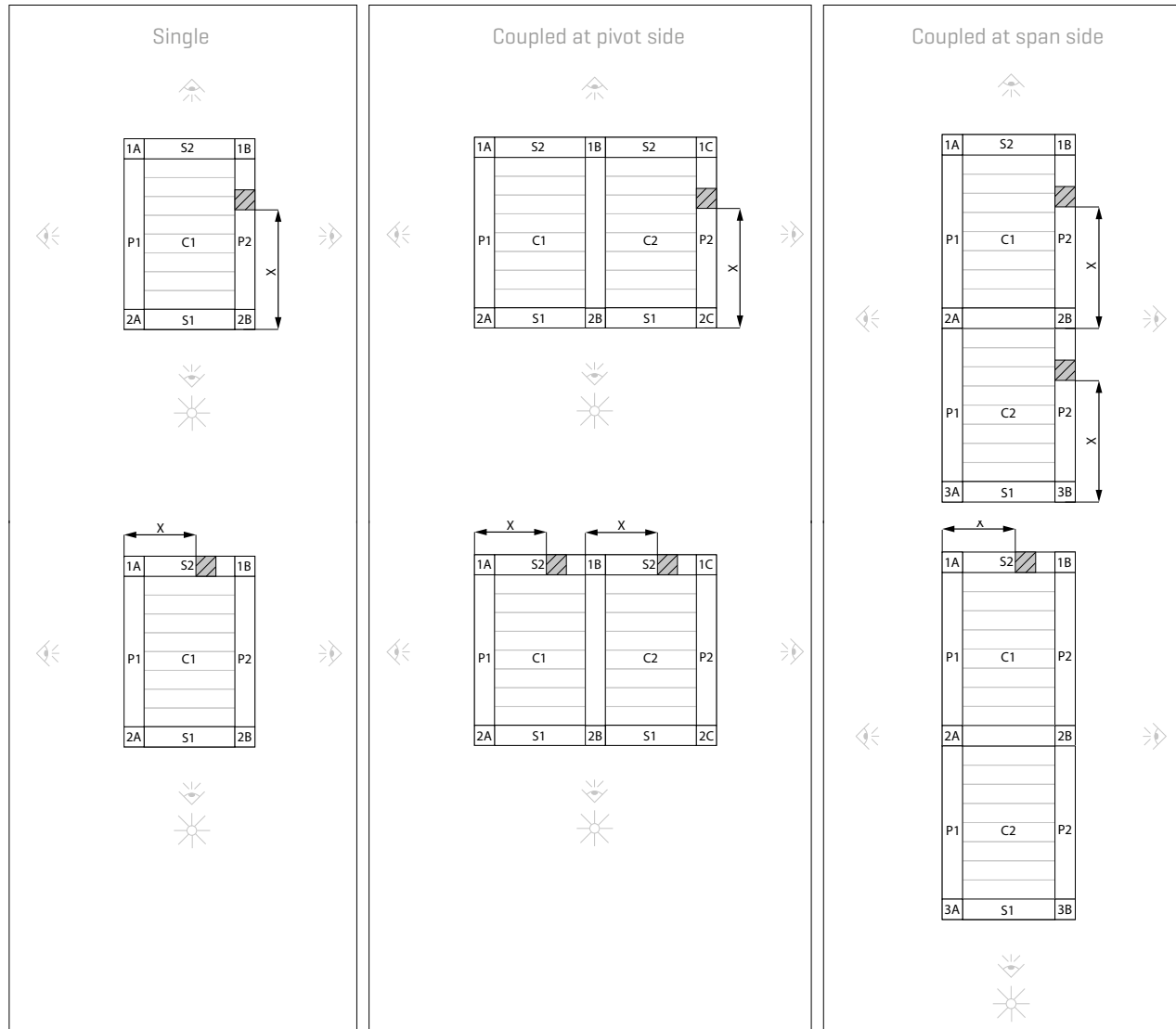
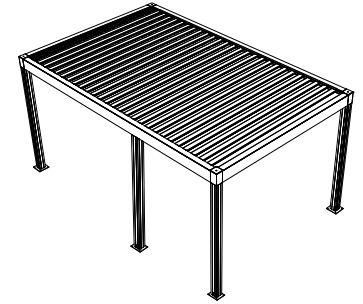

X = position of the intermediate column [mm]

Profiles

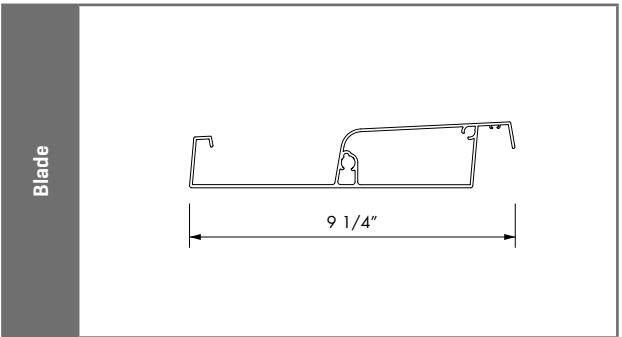
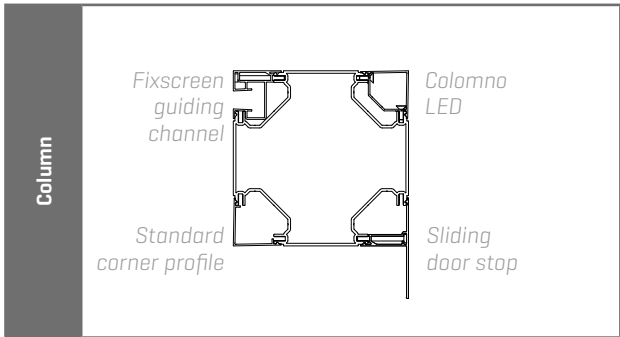
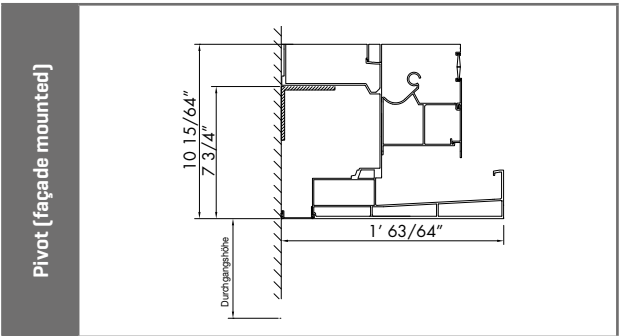
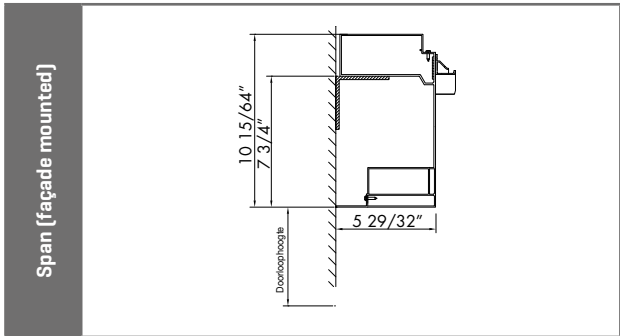
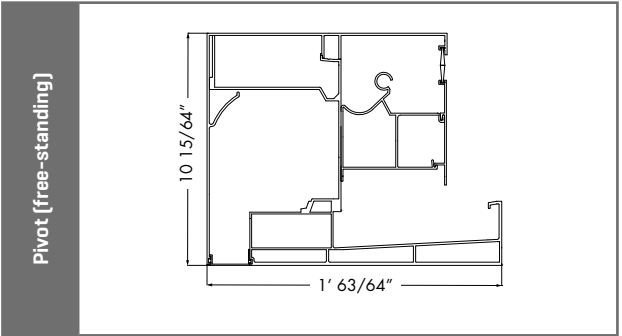
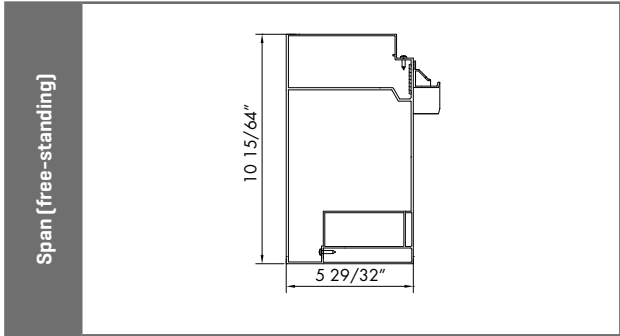
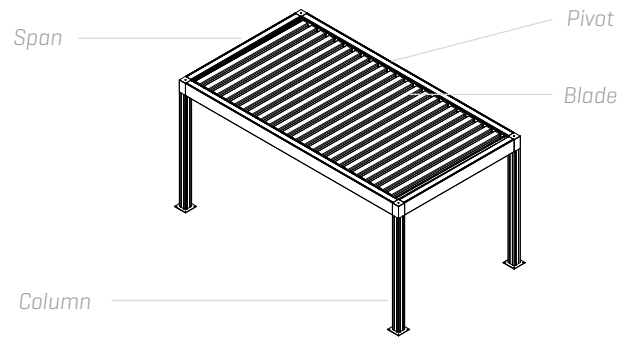

Blade orientation

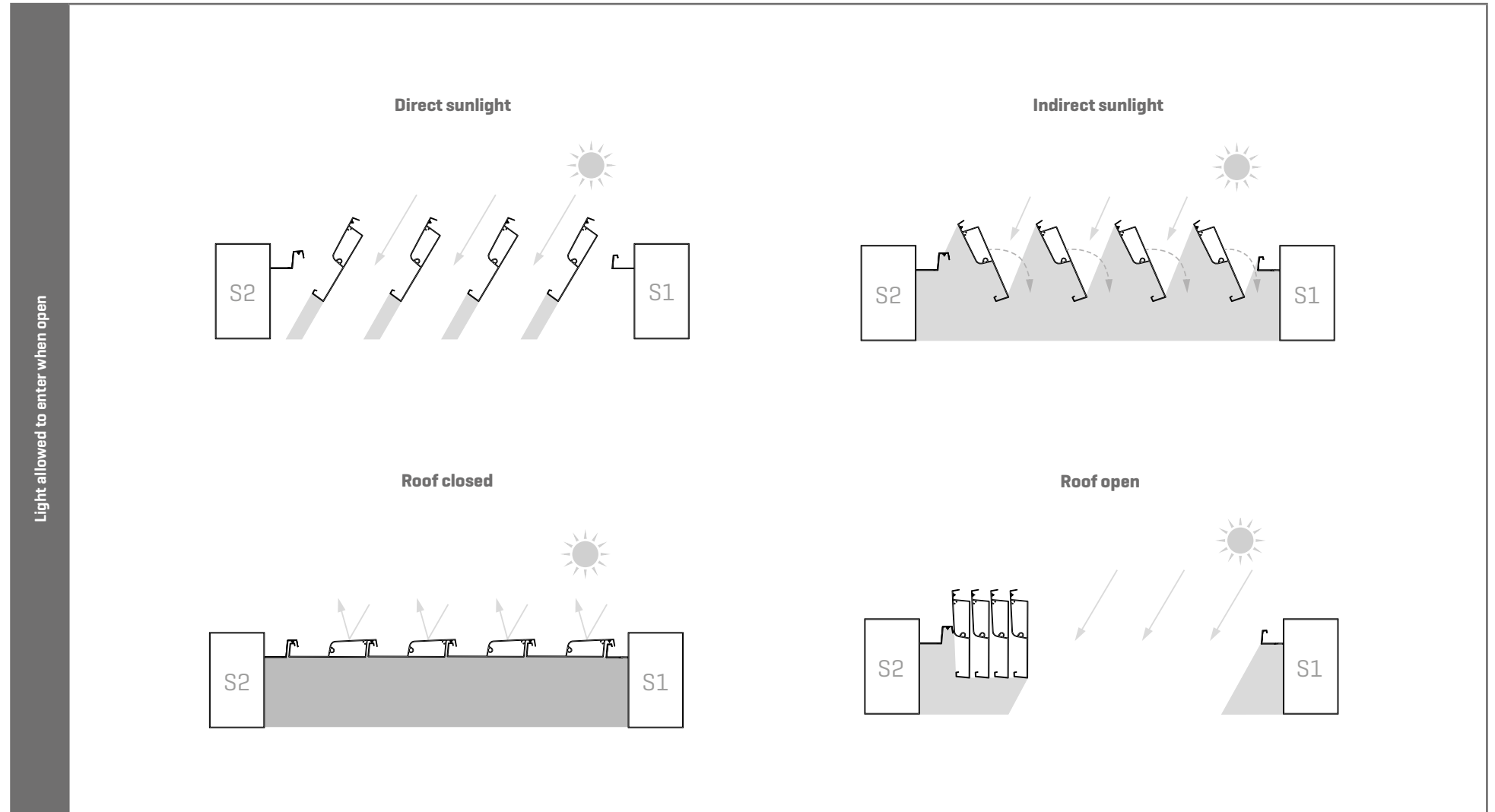

Mounting bases

The strength requirements determine whether or not reinforced mounting bases are needed.

Standard mounting bases

For use in normal circumstances, without increased wind load.

- Base plate thickness: $15/64$ "
- Core length: $11\ 13/16$ "
- Visible base plate: $10\ 5/8$ " x $10\ 5/8$ "

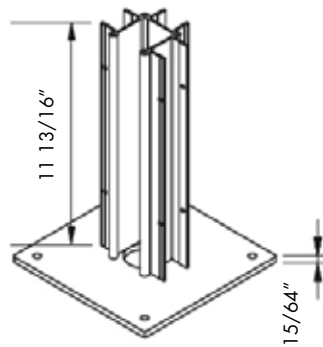

Reinforced mounting bases

At locations with increased wind loads, the cover must be equipped with reinforced mounting bases to guarantee the stability of the structure.

Examples include coastal areas, installation at a height or on a rooftop terrace.

- Base plate thickness: $25/64$ "
- Core length: $4'\ 10\ 55/64$ "
- Visible base plate: $10\ 5/8$ " x $10\ 5/8$ "

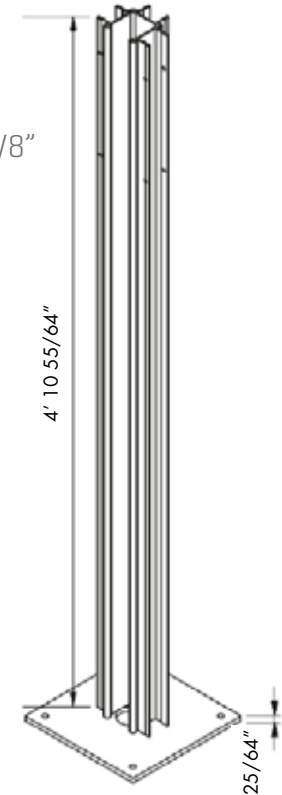

Mounting bases

The choice of reinforced or non-reinforced mounting bases will be made automatically based on the strength requirements and/or side insert selection. You can select a finish for your mounting bases from the possible options below.

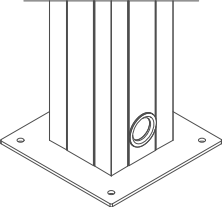
				
Type	Visible mounting base		Invisible mounting base	Cast mounting base
Application	Not against a structure	Pivot or span against a structure	All applications	Cast in concrete foundation
Non-reinforced mounting base	Available at standard price			
Reinforced mounting base	Available at a surcharge			Not available

Water drainage

Water will be drained down an integrated drainpipe in the columns of your choice. Starting at 172sqm, a minimum of two drainage outlets must be provided for each roof section, of which at least one drain must be on the lowest side of the blades (not on the motor side). For all other dimensions, at least one drain must be arranged on the lowest side of the blades (not on the motor side).

Please note!

If there is only one water-draining column and the surface area is greater than 172sqm, the drainage capacity of the roof will only be 0.40GPM [gallons per minute].

Three options for the height of the drainpipe:

- $2\ 19/32''$ + overlength relative to bottom side of the base [standard]. In case of overlength, you can choose to have the overlength size included in the standard distance of $2\ 19/32''$. For example: an overlength of $3\ 15/16''$ means water drainage at $6\ 17/32''$ relative to the bottom side of the mounting base.
- $2\ 19/32''$ relative to bottom side of the base regardless of whether or not overlength is applicable.
- Variable height
Minimum distance above ground level = $1\ 37/64''$.
Maximum distance = passage height - $1\ 4\ 11/32''$.
The height is always measured from the bottom of the mounting base to the centre of the drainage hole.

	Passage height	Negative overlength	Positive overlength
$2\ 19/32''$ + overlength relative to bottom side of base [standard]			
$2\ 19/32''$ relative to bottom side of base			
Variable height [mm]			

OTHER TOOLS

Want to find out more? Visit the Professional Portal on our website (www.renson.eu) to access the following tools.

- Technical drawings
- Training documents
- Installation manual
- User manual
- [Digital photo book & social media](#)
- ...

