





TABLE OF CONTENTS

STYLE PACKS	8
Crystal Lounge	10
Pure Essence	14
Idyllic Garden	18
Earth Oasis	22
Spiritual Harmony	26
Tech Cocoon	30
PATIO COVERS	35
Camargue® Line	36
Algarve® line	80
Aero® line	98
Lapure®	112
Applications for apartments	118
Customisation	128
Range	150
CARPORTS	152
Algarve® canvas	154
GARDEN ELEMENTS	162
Lighting - Linarte outdoor light	166
Seating & planter unit - Linearte modulo	168
Freestanding wall - Linearte icon	170
Esafe - parcel letter box	173
COMPLETE CONCEPTS	
Complete concepts for homes	176
Complete concepts for apartments	188
FAQ	196
TECHNICAL INFORMATION	212

ENJOY YOUR PATIO – ALL YEAR ROUND...

Renson outdoor rooms are for making the most of your patio and garden – all year round. It only makes sense that as soon as it's in place, you'd prefer to spend as much time there as possible. Whether it's a barbecue with friends, enjoying the sun, family time or even just some 'me time' a solution can be found. We know, that we revive mentally when we can spend more time outside experiencing these great moments.

In the past, a home extension simply meant a well-insulated add-on to the living room. However, those days are over... These days a whole new experience awaits with a Renson garden room, the seamless link between your home and garden. It provides you with genuine additional living space comfort; which means from Spring to Autumn and even in the rain there is a space for living.

When it comes to styling and design, Renson gives you the chance to configure everything according to your personal preferences – with countless options for accessories, colours, and materials. Or you could go for one of our six, all-new total 'Design Styles'. Composed of the perfect material and colour combinations, the new design styles have been curated especially for you by a renowned international trend watcher.

In addition to the cover and its related accessories, Renson offers a whole host of other products for the outdoor space around your home – from garden lighting to carports.

Would you like to extend the same unique, gorgeous style through your entire home? Renson outdoor products can make that a reality, providing you with a single design, harmonious colour palette, and style. It's possible even if you plan on developing your outdoor space in stages.

Interested? Discover the endless possibilities available at Renson for transforming your patio and outdoor setting into an enchanting haven.

WHY CHOOSE RENSON®?



TOP QUALITY AND DURABILITY

Renson® is the European trendsetter in the field of natural ventilation, outdoor sun protection, and outdoor products. Our high-quality products are manufactured in-house using our ultramodern production facilities. We put our products through their paces in the most extreme situations to ensure the end result is flawless.

This testing process means our customers can rest assured they're investing in the highest quality. With our network of well-trained Ambassadors, we can guarantee a flawless service, installation and aftercare experience. Our professional approach covers every aspect of our business.



MINIMALIST DESIGN

Our products are highly innovative in both their look and design. Seamless integration of optional elements, hidden fixation as above, durable materials, and smart solutions combine into a perfectly finished product that can be integrated into every type of home.



ENDLESS CUSTOMISATION POSSIBILITIES

With our modular product design and countless integrated options, we can offer you the perfect custom solution. Custom screens, a wide choice of colours, sliding panels in various designs, glass walls, heating, and music are just a few of the options that allow you to create a unique personal solution.



ULTIMATE EASE OF USE AND MAINTENANCE

Our products are not only designed to be easy to use, but also to retain their characteristics for many years, day in and day out, under all weather conditions.

To ensure you can enjoy our products every day with as little maintenance as possible, we use materials of the highest quality that are guaranteed to last.

CREATE A PERSONAL AMBIENCE WITH OUR 6 DESIGN STYLES

At Renson, we love the outdoors. Barbecuing with friends, relaxing in the sun, or taking some time out for yourself with an aperitif - it's about choosing quality of life. To tilt the outdoor living experience up to a whole new level, we at Renson create outdoor architecture that's not only functional, but aesthetic as well. Our outdoor concepts are a perfect match for your home and blur the boundary between indoors and outdoors. As a result, nature and architecture blend seamlessly.

Naturally, we guarantee the highest quality standards. We do this by having our products tested and certified according to the strictest standards. We use patented technology, among others, to accomplish this. But at the end of the day, it's mainly our years of experience that makes us unique. After all, Renson has been a family business since 1909. Few can make that claim.

However, we take it a step further than quality. We also believe your freedom of choice is of paramount importance. Our products are fully customisable, so you are sure to find your style within our range. Haven't made up your mind entirely about what you want yet? Then get ready to discover a number of style ideas in this brochure to inspire you. The materials and colours of each style have been selected to balance perfectly with the complete look. That way you can get the most out of your outdoor space, year after year.

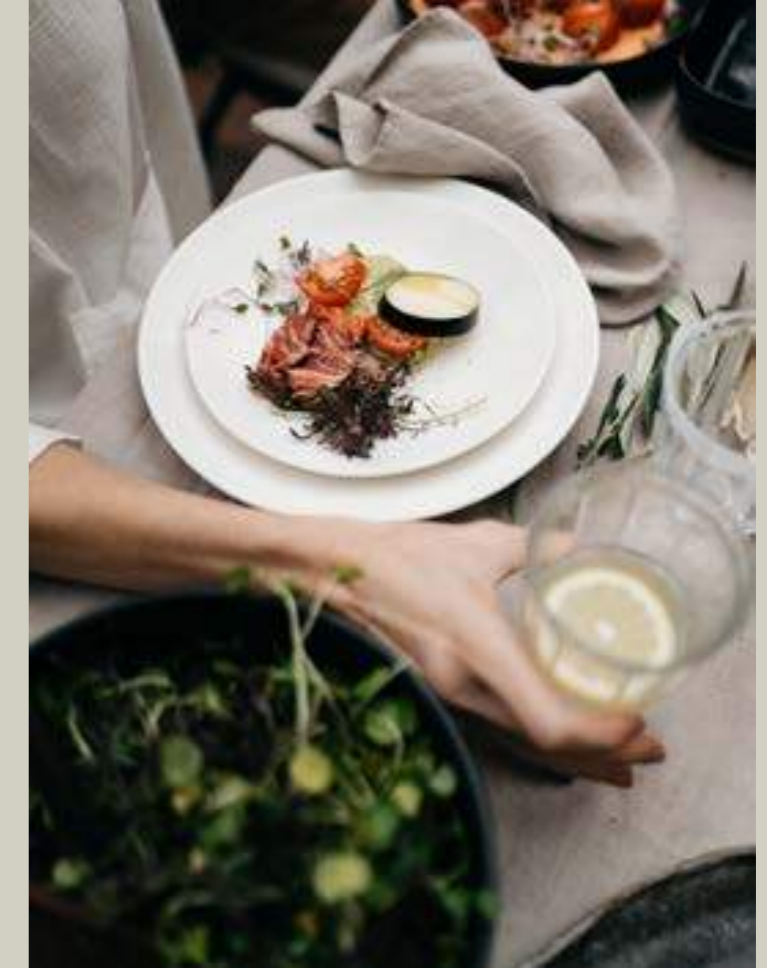



CRYSTAL LOUNGE

Crystal Lounge is sleek and minimalist. The fresh green tones create an airy feeling, which is further enhanced by the light material palette. The result is modern, light architecture that blurs the boundaries between indoors and outdoors.



Camargue®
 Frame RAL 7035
 Blades RAL 9010
 Fixscreens N-0207
 Loggialu Plano RAL 7035
 Curtains, Fine woven Jadeite
 Glass sliding panels Matt glass



Fresh, poetic colours underpin Crystal Lounge. The colour palette varies in shades from greenish beige to aqua green and a bright green grey. Matt glass provides transparency, while fine woven textures further enhance the airy feel. The materials in this style are fluid and seamless. Nothing disturbs the harmony. In this way, the architecture of Crystal Lounge blends perfectly with the surrounding nature.



Garden rooms echo this sentiment, feeling like an endless full-length film, with nature in the leading role. Enjoy the play of sun between the branches, or how plants gently move with the wind.

Crystal Lounge is for anyone who loves pure nature. In this style, the beauty of flora and fauna are central.





Camargue®
 Frame and blades Beige Essence Retreat
 Fixscreens SC 2002
 Loggiascreen Canvas Mixtrim 10 M0010
 Loggiawood Thermo-es
 Curtains, Refined woven White Corn

PURE ESSENCE

Light and space - that is Pure Essence. The pale colours and soft finishes give this style a feather-light feel. They create a place perfect for casting off your burdens, a space to completely unwind.



Lime, sand and natural shades of white set the tone in Pure Essence. Think of the soft white of cotton, the delicate beige of a shell, or the mild ivory blush of soap. Subtle tonal shades create an almost ethereal, light mood in which you can totally relax. The variations of textures reflect and diffuse the light, while the natural finishes and materials ensure this style does not become too clean and bare.



Pure Essence is all about the focus on the essential: sharing beautiful moments with friends and family, surrounded by nature. With Pure Essence, you can leave your daily troubles behind and choose pure indulgence.



Feather-light, transparent-looking furniture fits perfectly with Pure Essence. This chair adds a playful graphic accent.



IDYLLIC GARDEN



DESIGN STYLES | 19

DESIGN STYLES | 19



Camargue*
Frame & blades RAL 7032
Fixscreens SC 2050
Loggiawood Privacy Thermo-es
Curtains, Refined woven Planton

Idyllic Garden takes you along on a stroll through the garden. Sober greys and subtle greens inspired by plants give this style a contemporary look and ensure you can relax surrounded by nature.

We took inspiration from the land of dolce far niente for the colours and materials of Idyllic Garden - Italy. The Italians know all about enjoying themselves in an elegant setting. No wonder this style is ideal for those who like to relax in their garden.



Green is the colour for which the human eye recognises the most variations. Moreover, green has a relaxing effect. It's for that reason that we selected a varied palette of harmonious green tones for Idyllic Garden.



The matt green of olive leaves, the nuanced sand colour of travertine, the lively texture of linen: the atmosphere of Idyllic Garden comes from a careful selection of natural materials. An elegant, airy character with a Southern European touch is the result. With its predominantly cool grey colours, Idyllic Garden offers refreshment and a timeless look.



EARTH OASIS



DESIGN STYLES | 22

Earth Oasis leaves you with the impression that you're always on holiday. The warm earth tones evoke the feeling of summer. Natural and artisan materials connect you to the richness of the earth. They ensure perfect harmony between outdoors and indoors.



DESIGN STYLES | 23

Camargue®
Frame & blades RAL 8024
Fixscreens SC 1006
Loggiawood Thermo-es
Curtains, Thick woven Savannah Yellow



The warm colours and materials associated with the South were our inspiration for Earth Oasis. The subtle soft orange-pink of terracotta, and the powdery brown of spice were some of our references in compiling this palette. This richness of hues will transport you to far-away sun-drenched regions.



Nature offers endless inspiration. We used the matt reddish-brown texture of almonds as one of our starting points for the colours and finishes in this style.



Terracotta literally means “baked earth”. It has been used for vases and pitchers for centuries. This material is also fully on trend, and enchants with its natural, artisan look.

SPIRITUAL HARMONY

Camargue®
Frame RAL 7021
Blades Wooddesign Walnut
Fixscreens N-3006
Loggiascreen Canvas Mixtrim 10 M0017
Loggiawood Thermo-es
Curtains, Refined woven Beige Brown



DESIGN STYLES | 26

DESIGN STYLES | 27

A minimalist style in a dark colour palette, that's Spiritual Harmony. We were inspired, among other things, by Japanese traditional architecture for the colours and materials. The result is an intimate contemporary architecture that balances body and soul.



Spiritual Harmony's colour palette is inspired by the colours and materials found in ancient Japanese temples. We combine blackened wood and walnut with visible grain, canvas beige and olive green. These dark, natural tones create a protective, calming atmosphere.



In a garden pavilion, you can enjoy the seasons even more. You will experience the energy of spring and the richness of autumn like never before.

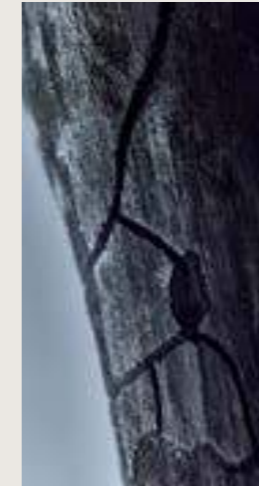

Relaxing in nature with friends or family, but in comfort: a Renson garden pavilion opens up new possibilities. Spiritual Harmony invites you to a meditative atmosphere in which you can relax.

In Japan, drinking tea is an intricate ritual. The traditional tea ceremony takes several hours and consists of a precise sequence of meticulously executed steps. But you don't have to go that far to enjoy the experience. You can enjoy your daily cup of tea and take advantage of a moment of reflection.

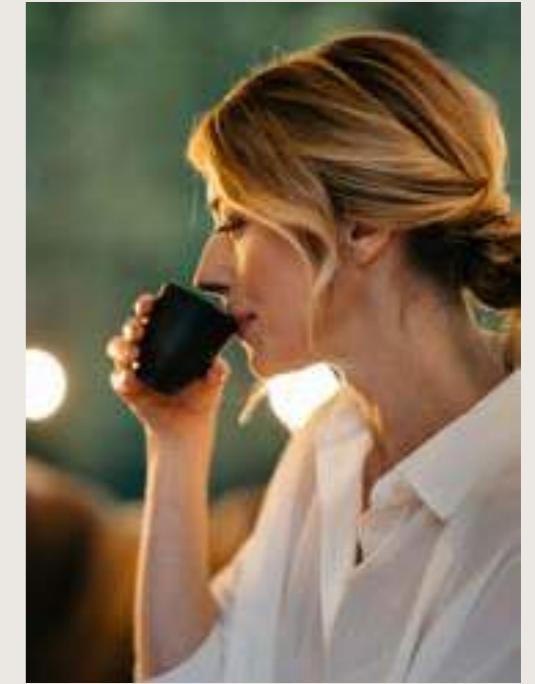

TECH COCOON

Tech Cocoon is radically contemporary and young, but with a warm side. Contemporary design converses with dynamic, playful colours such as soft coral. A feeling of pure transparency predominates, with an emphasis on technical materials such as glass and steel.



Camargue®
Frame & blades RAL 9010
Fixscreens N-0202
Loggiolu Plano RAL 9010
Curtains, Fine woven Ecrú
Glass wall



In Tech Cocoon, the playful textures of composite materials set the tone. Terrazzo in different tones is combined with clean, smooth textures. The colour palette is a combination of an energetic soft coral tone complemented by variations of white and soft grey with a greenish undertone. The orange-pink gives a warm and youthful accent to this sleek style.



Tech Cocoon calls for young design with a certain flair. The degrees of soft coral to terracotta pink give this space a southern feel that is wonderfully relaxed. Allow yourself to be inspired!



Full of energy and fresh as the scent of a freshly peeled citrus fruit - that's Tech Cocoon. This refreshing style gives your garden room a bold urban look.

PATIO COVERS



Camargue®
Frame & blades RAL 7021
Fixscreen Sergé SC0130
Loggiawood Privacy WRC

Thanks to a Renson® patio cover, you can enjoy your outdoor space even more. The possibilities to protect yourself from the wind, sun, rain, or cold are numerous and the expansion and customisation options are varied. This makes your garden or patio a natural extension of your home so that you can spend time outside in optimal conditions and the greatest comfort.



Camargue®
Frame & blades RAL 9016
Fixscreen Sergé SC0202

CAMARGUE® LINE

CAMARGUE® & CAMARGUE® SKYE

The highest quality in an ultra-minimalist design...

Perfection is just around the corner.

Everything has been seamlessly integrated, from the screens in the side to the lighting, heating, and music... This is luxury at its finest.

Enjoy the perfect temperature, morning, noon, and night - from summer to winter.



CREATE YOUR OWN
AMBIENCE





Camargue*
Frame & blades RAL 9016
Fixscreen Sergé SC0202

DAY &
NIGHT







CUSTOMISATION OPTIONS FOR EVERY STYLE

Camargue®
Frame RAL 8019
Blades Alesta urgently needed Halo 136
Loggiolu Plano RAL 8019
Loggiascreen Canvas Mixtrim 10 M0017



Loggiascreen® Canvas



Camargue®
 Frame RAL 8019
 Blades Alesta urgently needed Halo 136
 Loggialu Plano RAL 8019
 Loggiascreen Canvas Mixtrim 10 M0017

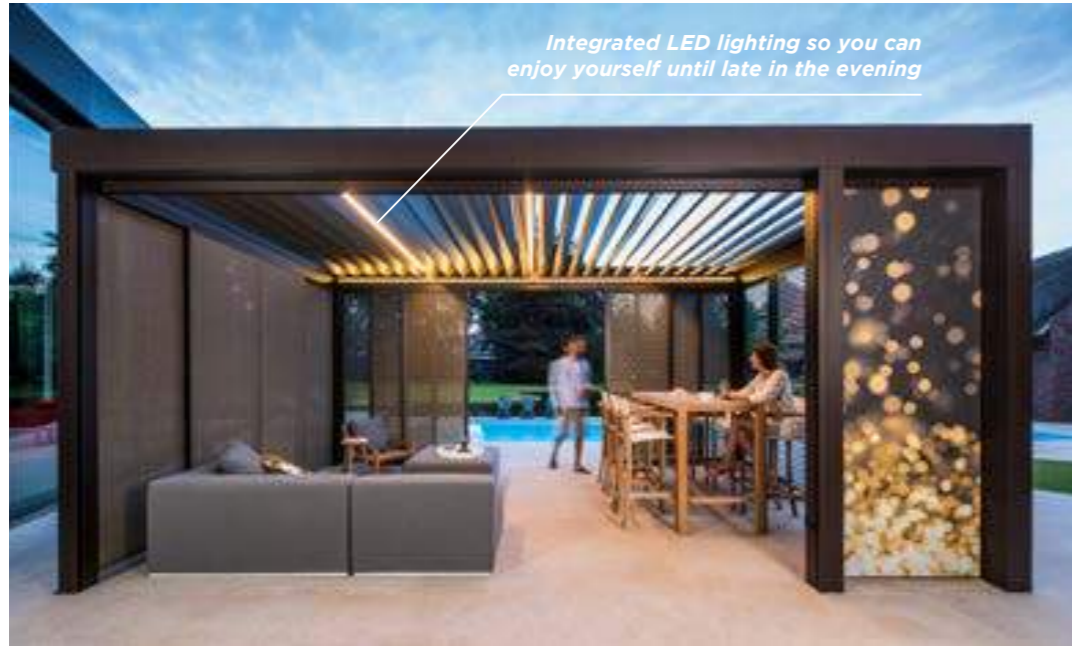

Integrated LED lighting so you can enjoy yourself until late in the evening



Perfectly customisable side screens (printed with your own design) are adjustable up to any height and are extremely windproof

Camargue*
 Frame RAL 8019
 Blades Alesta urgently needed Halo 136
 Loggiolu Plano RAL 8019
 Loggiascreen Canvas Mixtrim 10 M0017



PATIO COVERS - CAMARGUE LINE | 49

IN PERFECT
HARMONY

PATIO COVERS - CAMARGUE LINE | 50



Camargue®
Frame & blades RAL 7021
Fixscreen Sergé SC0130
Loggiawood Privacy WRC



PATIO COVERS - CAMARGUE LINE | 51



Camargue®
Frame & blades RAL 7021
Fixscreen Sergé SC0130
Loggiawood Privacy WRC



PATIO COVERS - CAMARGUE LINE | 5

Camargue® Skye
Frame & blades RAL 9005
Loggiawood Privacy WRC



PATIO COVERS - CAMARGUE LINE | 55

ENJOY NOT
JUST TODAY,
BUT TOMORROW
AS WELL



PATIO COVERS - CAMARGUE LINE 1 - 56

PATIO COVERS - CAMARGUE LINE 1 - 57



Camargue® Skye
Frame & blades RAL 9005
Loggiawood Privacy WRC

Camargue®
Frame & blades RAL 9016
Fixscreen Sergé SC0202

PATIO COVERS - CAMARGUE LINE | 58



PATIO COVERS - CAMARGUE LINE | 59

CONSTRUCTION
AGAINST YOUR
FAÇADE IS
SIMPLE



EVEN MORE ENJOYMENT

After living in the city centre for years, we built our dream home in the suburbs a few years ago. Finally, we had a garden, a quiet setting, and nature that gives us both a sense of peace. Unfortunately, we discovered that we couldn't enjoy our garden to the fullest. Spring is often accompanied by sudden gusts of wind and gathering storm clouds. While in the summer, it occasionally gets too hot.

In late summer, the evening cools down quicker and showers occur more frequently. By installing a patio cover, we can enjoy spending even more time outside. The side construction protects us from the wind. The screens can be set to the desired height in the summer. And in the event of a sudden shower, we can close the roof blades.

The result is that the extra number of hours we can spend outdoors after our working days has increased exponentially. Now our garden has really become a priceless piece of quality of life.

Dries & Monica



Camargue®
Frame & blades RAL 9016
Fixscreen Sergé SC3030



IN PERFECT
HARMONY

Camargue®
Frame RAL 9005
Blades Wooddesign walnut
Loggiolu Wooddesign walnut
Linus RAL 9005



Camargue®
Frame RAL 9005
Blades Wooddesign walnut
Loggiolu Wooddesign walnut
Linus RAL 9005





HEALTHY BODY,
HEALTHY SOUL



Camargue* Skye & Camargue*
Frame RAL 9005
Blades Camargue Skye: RAL 9005
Blades Camargue: Wooddesign white oak
Fixscreen Serge SC3030
Loggiolu Privacy Wooddesign white oak
Linarte RAL 9005





ENJOYMENT
IN EVERY SEASON

Camargue® & Camargue® Skye
Frame RAL 9004
Blades Wooddesign walnut
Fixscreen Natté N3006
Glass wall



PATIO COVERS - CAMARGUE LINE | 70

Camargue® & Camargue® Skye
 Frame RAL 9004
 Blades Wooddesign walnut
 Fixscreen Natté N3006
 Glass wall



PATIO COVERS - CAMARGUE LINE | 71



Camargue® & Camargue® Skye
Frame RAL 9004
Blades Wooddesign walnut
Fixscreen Natté N3006
Glass wall



BLISS EVEN EXTENDS
INTO WINTER

Camargue® & Camargue® Skye
Frame RAL 9004
Blades Wooddesign walnut
Fixscreen Natté N3006
Glass wall



PATIO COVERS - CAMARGUE LINE 1 76

Camargue® & Camargue® Skye
Frame RAL 9004
Blades Wooddesign walnut
Fixscreen Natté N3006
Glass wall



PATIO COVERS - CAMARGUE LINE 1 77



Camargue® & Camargue® Skye
Frame RAL 9004
Blades Wooddesign walnut
Fixscreen Natté N3006
Glass wall



Algarve®
Frame & blades RAL 7037

ALGARVE® LINE

ALGARVE® & ALGARVE® CANVAS

This gorgeous minimalist solution goes with every style, and the choice of colour is yours at no extra cost. Even better, every accessory is easily customisable.
This is enjoyment - pure and simple - without a care in the world.



Algarve®
Frame & blades RAL 7037





Algarve®
Frame & blades RAL 7037

A MORE STRUCTURAL SOLUTION

We choose a fixed patio cover to protect us from the sun and rain, depending on the weather. It's been a while since we looked for a more structural solution than a parasol awning or putting out a party tent to take shelter from the rain.

We found this execution to be an excellent fit with the existing architecture of our house and it seemed like a sound solution. It has proven to be even more comfortable than originally thought. We should have installed it much earlier. The blades rotate anyway you like. When it's too hot, we open them slightly so we can feel the breeze. When it rains, the water drains away in no time. We've been using our patio cover for five seasons now and it still looks like new. It's an incredibly solid construction. I clean the blades with Renson 'Clean' once every spring and reapply Renson 'Protect' to everything, and then we're set for a great new season.

Karel & Greet



CLASSIC IS
ALWAYS TIMELESS



Algarve® Classic Line
Frame & blades RAL 8003



PATIO COVERS - ALGARVE LINE | 88



PATIO COVERS - ALGARVE LINE | 89



Algarve® Classic Line
Frame & blades RAL 8003



Algarve® & Algarve® Canvas
Frame & blades RAL 7006
Pearl Linen Canvas
Fixscreen Sergé SC3231

GET THE MOST OUT
OF YOUR GARDEN





Patio cover

Carport

Algarve® & Algarve® Canvas
Frame & blades RAL 7006
Pearl Linen Canvas
Fixscreen Sergé SC3231



| A UNIFORM
LOOK AND FEEL



PATIO COVERS - ALGARVE LINE | 96

PATIO COVERS - ALGARVE LINE | 97



Algarve® Canvas
Frame & blades RAL 7016
Pearl Grey Canvas
Fixscreen Sergé SC0130
Loggiawood Privacy WRC



Aero®
Frame & blades RAL 9005

AERO® LINE

AERO® & AERO® SKYE

The architect seamlessly integrated the bladed roof into the design of our pool house. The technology of our 'Skye' is out-of-this-world. The blades open and slide out of sight making hardly a sound.

Too hot? Just open the blades.

Showers? Simply close the blades. It's all app controlled.

Premium design. Overwhelming luxury.



ENJOY EVERY HOUR
OF THE DAY



Aero®
Frame RAL 9016
Blades RAL 9016

PATIO COVERS - AERO LINE | 102



PATIO COVERS - AERO LINE | 103





PATIO COVERS - AERO LINE | 104

STYLISH
FINISHING



PATIO COVERS - AERO LINE | 105

SEAMLESS INTEGRATION
FOR A REFINED LOOK

PATIO COVERS - AERO LINE | 106



Aero®
Frame & blades RAL 9001



PATIO COVERS - AERO LINE | 107





Aero® Skye
Frame & blades RAL 9005



Aero° Skye
Frame & blades RAL 7035

URBAN GARDENS TRANSFORMED
INTO EXTRA LIVING SPACE





Lapure®
Frame RAL 7016
Canvas SW96 anthracite

LAPURE®

A slanted cover was a must for us because it's the best match for our home. However, finding an aesthetic option for that roof type was tricky. The quest that ultimately led us to the Lapure was a long one. But we knew it was right, straight away. It remains taught even in high winds, and it provides a perfect shield from the rain. The added value to our home is undeniable.

ENJOY
YOUR GARDEN



PATIO COVERS - LAPURE | 114



Lapure®
Frame RAL 7016
Canvas SW96 anthracite

PATIO COVERS - LAPURE | 114



Lapure®
Frame RAL 7016
Canvas SW96 anthracite





Camargue®
Frame & blades RAL 7021
Loggiolu Privacy RAL 7021

ALSO IDEAL FOR
PENTHOUSES AND
APARTMENT ROOFS





Algarve*
Frame & blades RAL 9001

SPEND MORE TIME
ON THE PATIO



PATIO COVERS - APARTMENTS | 122

Aero®
Frame & blades RAL 9010



PATIO COVERS - APARTMENTS | 123



PATIO COVERS - APARTMENTS | 123



Camargue® Skye
Frame & blades RAL 8022
Linarte RAL 8022



INFINITE APPLICATIONS





CUSTOMISATION

It really was a treat to have so many possibilities open to me for configuring my pool cover. Just about any colour was possible so I went with the colour of our windows.

By adding Loggiawood sliding panels to the mix, featuring warm wood blades - the overall ambience is characterised by a sense of welcoming and warmth.

We are genuinely happy. And in the evening, it's the perfect spot to unwind. We close the blades to keep out the chilly air out and turn on the heating. What a treat! There's no place like outside...

Camargue®
Frame & blades RAL 7021
Fixscreen Sergé SC0130
Loggiawood Privacy WRC

LIGHTING

By selecting the right lighting, you can enhance your enjoyment of your patio cover.

The following options are available:

- Functional lighting (Lineo LED, Down LED, Lapure LED)
- Ambient lighting (Up LED)
- Accent lighting (Colomno LED, Up LED)

These high-quality outdoor lighting solutions are available in warm white or pure white. What's more, Up LED ambient lighting is also available in RGB, allowing you to adjust the colours to create a certain ambience whenever the mood strikes.

All lighting is dimmable.



COLOMNO LED

Integrated accent lighting on the inner side of the Camargue Line columns help showcase the architecture. Colomno LED combines beautifully with Down LED.



UPDOWN LED

Integrated LED lighting on the inner side of the frame. Fitted with lighting running upwards and/or downwards. This lets you create indirect or direct atmospheric lighting with the Camargue Line, Algarve Line, and Aero Line.

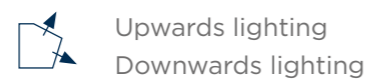

LINEO LED

LED lighting integrated into the Camargue, Algarve, and Aero blades. Extremely high light output with even distribution without visible bright spots thanks to high-quality LEDs (180 per metre).



LAPURE® LED

LED lighting integrated into the Lapure cross-beam. Extremely high light output with even distribution without visible bright spots thanks to high-quality LEDs (180 per metre).

	Warm white light	Pure white light	RGB (colour)	Dimmable
Lineo® LED Light*	✓	✓		✓
Colomno LED Light**	✓	✓		✓
UpDown LED Light** Upwards	✓	✓	✓	✓
UpDown LED Light** Downwards	✓	✓		✓
Lapure® LED Light*	✓	✓		✓

* Warm white: 1660 lm/m (180 LEDs/m) / Pure white: 1660 lm/m (180 LEDs/m)

** Warm white: 550-680 lm/m (120 LEDs/m) / Pure white: 550-680 lm/m (120 LEDs/m) / RGB: 550-700 lm/m (60 LEDs/m)

HEATING AND MUSIC

With the Heat & Sound Beam, you can enjoy your favourite tunes or benefit from the functional heating from early in the morning until late into the night.

The aluminium module extends the full width of the roof and is powder coated in the same colour as your cover. Both the speakers and heating element have been seamlessly integrated to give this option an especially sleek appearance.

What's more, you can rotate the beam up to 30 degrees to achieve the perfect heat distribution.

The combination of audio and heating guarantees a sensational total experience, but having the elements installed separately is also possible. All wiring has been invisibly concealed within the cover's structure.



Integrated heating elements and loudspeakers

The heating in your patio cover is based on short-wave infrared, which provides instant heat distribution and a safe, cosy feel.

At the same time, the waterproof sound system creates a cheerful ambience beneath your patio cover. It can be connected to a multi-room system, but control via Bluetooth is also possible.



Bluetooth



NEW
AS OF
SEPTEMBER
2021

LINEO® FIX

Renson patio covers are characterised by their huge range of customisation possibilities. Lineo Fix offers you the possibility to give your own creativity even freer rein.

This fixed blade can be used to mount your own light fixtures, a fan, projector, or any other additional accessories.

The design makes it possible to secure weights of up to 15 kg so that when the roof is closed it remains an aesthetically perfect, even surface.

Electrical cables can also be concealed invisibly within the Lineo Fix.

LINEO® LUCE

Camargue, Algarve, or Aero roofs installed with Lineo Luce's translucent blades let natural daylight in – even when the bladed roof is closed.

The translucent blades are made of high-quality safety glass, and integrate flawlessly in your patio cover's bladed roof.

To ensure the cover features the preferred amount of translucence, one to five translucent blades can be integrated per roof section. These blades can be configured next to each other or be staggered between the other blades. That way you get the most enjoyment from natural daylight under your patio cover. With a cover built onto your home, you don't lose out on natural daylight indoors, even with the bladed roof closed.

TRANSLUCENT BLADES FOR CAMARGUE®, ALGARVE® AND AERO®



Light entering the home with roof closed



Light under the patio cover with roof closed

PROTECTION PROFILE BETWEEN BLADES AND GUTTER FOR CAMARGUE®, ALGARVE® AND AERO®



PROTECTO

- Protection from wind, misty rain, and snow between the gutter and blades
- Maintains continuous contact with the blades thanks to a concealed hinge system
- Powder coated in the same colour as the frame and columns
- Reorders are possible for covers that have already been installed

LOGGIA®

Loggia sliding panels offer infinite possibilities.

In addition to the unique, customised look they lend your cover, they also offer the following benefits:

- sun protection
- wind protection
- privacy
- protection

The fixed aluminium frame of the sliding panels can be installed with blades or canvas fabric. The sliding system is supported by a bottom rail that accommodates small height differences up to 5 cm thanks to the patented Flexguide.

Loggia sliding panels can be installed with Camargue, Camargue Skye, Algarve and Algarve Canvas.

SLIDING PANELS FOR CAMARGUE® LINE AND ALGARVE® LINE

TYPES

- Loggiawood: wooden blades (Western Red Cedar or Thermo-es)
- Loggiawood Privacy: rotating wooden blades (Western Red Cedar or Thermo-es)
- Loggiascreen Canvas: screen fabric (fibreglass) + Mix-trim
- Loggialu: aluminium blades
- Loggialu Privacy: rotating aluminium blades
- Loggialu wooddesign: aluminium blades with wood design

INTEGRATION

Camargue Line: possible in Span and/or Pivot
 Algarve Line: possible in Span and/or Pivot up to 4,500 mm



PRIVACY

Manually adjustable wooden or aluminium blades. The Privacy version of the Loggiawood and Loggialu sliding panels have blades that can be rotated manually to a fully open or closed position.



UNIQUE: LOGGIA SLIDING PANELS AND ROOF BLADES IN THE SAME WOOD DESIGN

WOODDESIGN

Camargue Line, Algarve, and Aero Line fitted with aluminium roof blades in wooddesign

- Natural appearance of wood combined with the advantages of aluminium in terms of:
 - Ease of maintenance
 - Colourfastness
 - Maintains the shape
- Also available for the LED blades
- Combines perfectly with the Loggialu Wooddesign sliding panels
- Roof blade in wooddesign (frame and columns have standard coating)
- Available in 3 types:
 - White oak
 - Natural oak
 - Walnut



White oak



Natural oak



Walnut

OUTDOOR CURTAINS

Both the Camargue Line and Algarve Lines can be fitted with outdoor curtains. This allows you to create a fairy-tale atmosphere under your patio cover.

These polyester curtains for outdoor use are water-repellant, mould-resistant, and repel dirt. Moreover, these are weather-resistant and colour-fast, even after washing. The curtains are completely wrinkle-free. The curtains can be completely made to order. Plus, they can be combined with glass sliding panels and integrated Fixscreens in the Camargue Line. The outdoor curtains can be applied in combination with UpDown lighting. This gives the patio cover a romantic feel at twilight.

EARTH OASIS



Thick woven
Savannah
Yellow

PURE ESSENCE



Refined woven
White Corn

IDYLLIC GARDEN



Refined woven
Planton

SPIRITUAL HARMONY

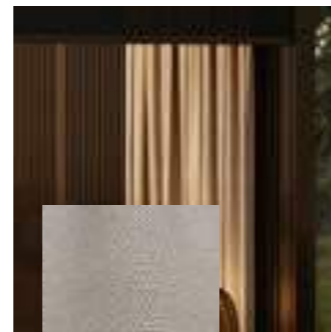

Refined woven
Beige Brown

TECH COCOON



Fine woven
Ecru

CRYSTAL LOUNGE



Fine woven
JadeitePlanton

TRANSPARENT SLIDING WALLS FOR CAMARGUE® LINE AND ALGARVE® LINE



The Camargue Line is fitted with glass sliding panels and integrated Fixscreens in the Span and Pivot side

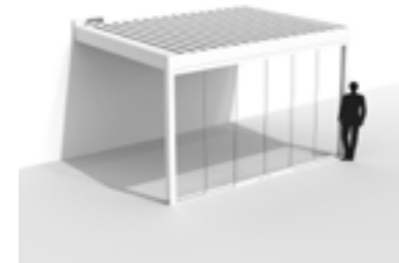

Algarve Line fitted with a glass sliding panel in the pivot

INTEGRATION

Camargue Line & Algarve Line: possible in Span and/or Pivot

DISTRIBUTION OF GLASS SLIDING PANELS

Diagram	Diagram	Diagram	Diagram
1,500 ≤ X ≤ 2,500 Width X	2500 < X ≤ 3750 Width X	3750 < X ≤ 5250 Width X	5,250 < X ≤ 6,500 Width X
3 panels	4 panels	6 panels	8 panels
3 rails	4 rails	3 rails	4 rails
Opens to the left or opens to the right	Opens to the left or opens to the right	Opens to the left and opens to the right	Opens to the left and opens to the right
Incl. 1 handle	Incl. 1 handle	Incl. 2 handles	Incl. 2 handles

GLASS SLIDING PANELS

You can also choose to install glass sliding panels. These fully transparent sliding walls accentuate the elegance of Camargue Line and Algarve Line. This also protects you from the weather and wind, and the patio cover can be completely enclosed to prevent theft. You can, of course, always integrate the vertical, windproof Fixscreen sun protection together with a glass sliding panel, which keeps the major advantage of sun protection.

Plus, you can combine the glass wall with the outdoor curtains, even when already combined with the integrated Fixscreens.

LINIUS® & LINARTE®

The Linius or Linarte bladed wall lets you create a physical barrier and decorative finishing for the supporting wall. The fixed wall is available as a single or a double-sided, cladded wall across the entire passage height, or can be finished at a customised height with a top profile to create a railing. Ideal as a border for patios in the hotels, restaurant, and catering sector. The Linarte fixed wall is always installed with tautly stretched screen fabric on one side.

The support structure ensures that the connection between the finishing blades is not visible, which creates an unbroken line along the entire width. The wall fits neatly into the space in the columns on both the front and back sides. Height differences in the floor up to 6 cm are compensated by the finishing plinth, so that no annoying openings are visible at the bottom. The wall is custom-finished in the colour of the patio cover or of your choosing. Moreover, the double-sided wall allows for the application of sound proofing. This way, you can enjoy the nature around your patio cover in utter relaxation.

FIXED WALL LINIUS FOR CAMARGUE® LINE AND ALGARVE® LINE & LINARTE FOR CAMARGUE® LINE



Linus®



Linarte®

EASY PASSAGE / SLIDING DOOR FOR CAMARGUE® LINE AND LAPURE®



Camargue fitted with an integrated Fixscreen and sliding door using a Loggiascreen Canvas in the Span side

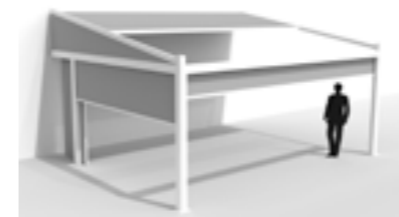

Lapure fitted with a Fixscreen and sliding door using Loggiascreen Canvas in the side

INTEGRATION

Camargue Line: possible in Span and/or Pivot

Lapure: available in Side

Width: min. 800 mm - max. 1200 mm

LOGGIA® EASY PASSAGE

Ideal if the patio cover is completely enclosed (e.g. by Fixscreen) and you want to quickly get to or from the patio cover without having to open the Fixscreen (no loss of comfort for those sitting under the patio cover).

The easy passage consists of an aluminium frame covered on one side with a fibreglass screen fabric of your choice.

INTEGRATED FIXSCREEN®

Thanks to an **ingenious zip system**, the fabric is windproof in every position and the screen is insect-proof when closed. It is an incredibly well-thought-out principle in which the sun protection fabric has a special zipped trim. This ensures that the entire structure is held firmly in place by the two side guiding channels. By integrating this Fixscreen, with or without Crystal windows to keep a view of the outside, you can create an extra outdoor room where users are protected from sun, rain, and wind. Available in more than 50 colours, these screens allow you to personalise Camargue Line and create the atmosphere you want.

SUN PROTECTION FABRIC FOR CAMARGUE® LINE



Bottom bar disappears into the head box

PERFECT INTEGRATION, EVEN AFTERWARDS!

- Ideal for:
- Privacy
 - Shade when the sun is low in the sky
 - Protection from wind, rain, and insects

CONNECT&GO TECHNOLOGY

The integrated Fixscreen is fitted with our patented Connect&Go technology. This new development offers a huge installation advantage, as well as for removing the fabric roller tube when replacing a screen or motor.

BOTTOM BAR DISAPPEARS INTO THE HEAD BOX

The Camargue Line's frame profiles are developed in such a way that the bottom bar is aesthetically hidden away in the head box when the screen is raised. Perfect integration, even afterwards!

SUN PROTECTION FABRIC FOR ALGARVE® LINE AND LAPURE®



SUBSTRUCTURE FIXSCREEN®

To close the sides of Algarve or Lapure, it is possible to combine them with a Fixscreen base. This allows for the sun protection head box to be mounted underneath the frame profiles so that this connects perfectly with the basic construction.

TIP

CUSTOM PRINT

Aside from our standard range, fabrics can also be customised. Options include printing your business logo or a photo onto a screen underneath a patio cover.



CRYSTAL FABRIC

Transparent crystal fabrics can be placed in the fibreglass fabric of the Fixscreen to maintain optimal contact with the outdoors. This transparent type of fabric consists of PVC (Fire classification M2).

This transparent crystal fabric can be integrated into a fibreglass fabric with a Fixscreen base and integrated Fixscreen®.

The Crystal fabric is always 1200 mm high and extends across the full width of the Fixscreen. A minimum distance of 400 mm applies between the Crystal fabric and the top and bottom border of the Fixscreen.

OPTIMUM CONTACT WITH THE OUTDOOR SPACE

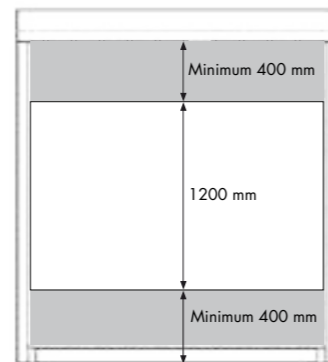

TIP

A distance of 800 to 1000 mm from the bottom side provides the best possible view for people underneath the patio cover.

FIBREGLASS FABRICS

The best choice in translucent sun protection fabric for windproof vertical sun protection is fibreglass fabric. Fibreglass fabrics score the highest in terms of tension and rigidity, and are also highly resistant to moisture and heat, all while maintaining a great outdoor view. We offer a wide range of colours so that you can find the fabric that suits you perfectly. The Architects' Selection is a colour collection that is very popular in current design and architectural trends. Our Renson® Ambassadors are happy to assist you with your selection. Fibreglass fabrics are also available with a Crystal window, providing a crystal-clear view.

TRANSPARENT SUN PROTECTION FABRIC CAMARGUE® LINE, ALGARVE® LINE AND LAPURE®



FABRIC TYPES

Fixscreen fabrics are available in 50 colours and three different woven patterns.



Sergé



Natté



Privacy

SOLTIS® PROOF W96

Lapure's roof is fitted with an innovative, waterproof, transparent sun protection fabric. Both sides of this polyester fabric are coated with a UV-resistant, waterproof coating. This fabric is available in various colours.

WATERPROOF SCREEN ROOF FOR LAPURE®



SWK TOP WATERPROOF



TENSION CEILING FOR ALGARVE® CANVAS & AERO® CANVAS

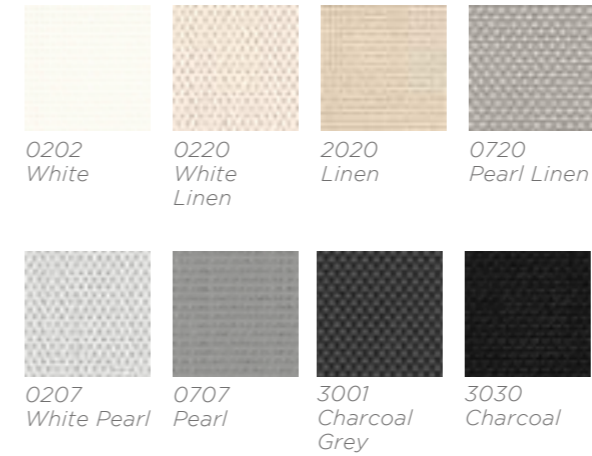

CANVAS FIBREGLASS FABRICS

The roof of Algarve Canvas and Aero Canvas is finished with a unique patented tension ceiling. Fibreglass fabric is stretched using the proven Fixscreen technology into the frame for a horizontal, seamless and clean finishing of the ceiling without annoying intermediate beams.

COLOUR SELECTION

ALUMINIUM

AVAILABLE IN OVER 100 TEXTURED COATING COLOURS

Our patio covers are powder coated with 'Seaside quality' pretreatment as standard. The products are available in over 100 RAL colours in textured coating at no extra cost.

Renson® recommends using textured coatings to achieve an architectural, contemporary look. In addition, textured coatings are more suitable for outdoor use and will hide any scratches much better.



AUTOMATION

SIMPLE REMOTE CONTROL

Somfy automation makes operating your patio cover easy. You can operate the roof and/or the screens of your patio cover by remote control. Depending on the desired use and the number of screens, you can choose from several different remote controls.

Thanks to TaHoma and Connexoon, Somfy's control interfaces, your patio cover can be controlled from your smartphone, tablet, or computer.









We recommend installing rain and/or wind sensors for optimum comfort.

TIP

The columns' smart design makes it possible to integrate a plug socket or other technology suitable for outdoor use.



RANGE

TYPE	HORIZONTAL DESIGN				HORIZONTAL DESIGN			SLOPED DESIGN	
	CAMARGUE® LINE		ALGARVE® LINE		AERO® LINE			LAPURE®	
	Camargue®	Camargue® Skye	Algarve®	Algarve® Canvas	Aero®	Aero® Canvas	Aero® Skye	Lapure®	
									
ROOF INSERTS	Rotating blades	Rotating and sliding blades	Rotating blades	Fixed roof	Rotating blades	Fixed roof	Rotating and sliding blades	Retractable, waterproof, translucent, and sun protection screen	
DIMENSIONS									
Max. width / Pivot	6200 / 7060*** mm		6200 mm		6055 mm		6055 mm	6200 mm	6000 mm**
Max. depth / Span	4500 mm		4500 / 6000 mm*		4500 / 6000 mm*		4500 / 6000 mm*	4500	5000 mm
Max. passage height	2800 mm		2800 mm		-		-	-	2900 mm
Joinable	joined in multiple parts		joined in two parts		joined in two parts		joined in two parts	joined in two parts	joined in multiple parts
Min. incline	no incline (0°)		no incline (0°)		-		-	no incline (0°)	10°
Max. blade rotation	150°	145°	150°	-	150°	-	145°	-	-
ACCESSORIES									
SIDE ELEMENTS	Integrated Fixscreen®	option	option	-	-	-	-	-	-
	Surface-mounted Fixscreen	-	-	option	option	-	-	-	option
	Loggia sliding panels	option	option	option	option	-	-	-	-
	Loggiascreen Canvas easy passage	option	option	-	-	-	-	-	option
	Glass walls	option	option	option	option	-	-	-	-
	Linus Wall	option	option	option	option	-	-	-	-
	Linarte Wall	option	option	-	-	-	-	-	-
	Triangle	-	-	-	-	-	-	-	option
	Outdoor curtains	option	option	option	option	-	-	-	-
	Extra column	option	option	option	option	-	-	-	option
Shifted column	option	option	option	option	-	-	-	option	
Adjustable wall profile	option	option	-	-	-	-	-	-	-
LIGHTING	Lineo LED	option	-	option	-	-	-	-	-
	UpDown LED	option	option	option	option	-	-	-	-
	Colomno LED	option	option	-	-	-	-	-	-
	Lapure LED	-	-	-	-	-	-	-	option
COMFORT & DESIGN	Beam Heat & Sound	option	option	option	-	-	-	-	-
	Translucent Lineo Luce blades	option	-	option	-	-	-	-	-
	Wooddesign	option	option	option	-	-	-	-	-

* > 4500 mm is possible when coupled or joined, up to max. 6000 mm

** up to 4000 mm without cross-beam > 4000 mm to 6000 mm with cross-beam

*** Pivot > 6200 mm is possible in one roof section if an extra column is used, up to a max. Pivot of 7060 mm



CARPORTS

We were looking for a patio cover with a bladed roof and a carport in the same style to match our newly built home. We found the ideal solution with Algarve and Algarve Canvas from the Algarve Line. The elegant structure fits in beautifully with our sleek architecture and meets our needs perfectly.

Our car can now be parked under the shelter of an Algarve Canvas and the value of our home has increased considerably. We used Algarve to create the ideal climate on our patio and we have a structural solution that protects us from the sun, rain, wind, and cold thanks to the adjustable bladed roof, the sun protection screens, and the stylish heating system.



Algarve® Canvas
Frame & blades RAL 9005
Canvas Charcoal

ALGARVE® CANVAS

This elegant carport offers lasting protection by means of a fixed roof made up of 2 layers: a solid top roof made of white or anthracite powder coated, profiled steel sheet with anti-condensation coating and an aesthetic lower roof, finished with a stretched fabric with zip technology.

The fabric is tautly stretched in the structure, without any visible additional beams. It is available in 8 colours. Algarve Canvas is just as useful as a fixed patio cover, carport, or as an awning above the front door, for instance. For example, the combination of an Algarve with rotatable bladed roof and an Algarve Canvas with fixed roof structure makes it possible to create a single, uniform style around the house.





ALGARVE® CANVAS EXTENSION WITH STORAGE



*Example of an extension in length:
7 x 3.5 metres*



*Example of an extension in width:
5 x 5.5 metres*



Algarve® Canvas
Frame & blades RAL 9005
Canvas Charcoal



Algarve® Canvas
Frame & blades RAL 7006
Pearl Linen Canvas
Linisus RAL 7006



A SINGLE STYLE
AROUND YOUR HOME

Algarve® Canvas
Frame & blades RAL 7006
Pearl Linen Canvas
Linus RAL 7006



GARDEN ELEMENTS

Thanks to our complete Outdoor Concept, not only can you extend the minimalist design of the Linarte façade cladding to your patio cover, but also create a unique look throughout your garden with Linarte lighting, Sit & Plant Units, and the freestanding Icon wall.



Garden elements
RAL 9005



LINARTE® OUTDOOR LIGHT

Linarte Outdoor Light is available in Renson standard textured coating colours.
The lighting is not dimmable.
Linarte is available in two heights with different options:

LINARTE OUTDOOR LIGHT SMALL



Single plug socket



Single lamp



*Double lamp
Front & back*



Lamp with plug socket

Height 325 mm
Depth 120 mm
Width 82 mm



LINARTE OUTDOOR LIGHT MEDIUM



Single plug socket



Single lamp



*Double lamp
Front & back*



Lamp with plug socket

Height 515 mm
Depth 120 mm
Width 82 mm



LINARTE® MODULO SYSTEM

Linarte Block 30 & Linarte Even models. Seating element or planter border in thermo-es. Optional with indirect lighting at the bottom or direct lighting with LED modules. Available in Renson standard textured coating colours.

OVERVIEW



Linarte Modulo 55 SIT



Linarte Modulo 97 SIT



Linarte Modulo 97 PLANT

Height 450 mm
Length 974 mm
Width 554 mm



Linarte Modulo 55 PLANT

Height 450 mm
Length 554 mm
Width 554 mm



Linarte Modulo COMBINATION



Height 450 mm
Length adjustable
Width 554 mm

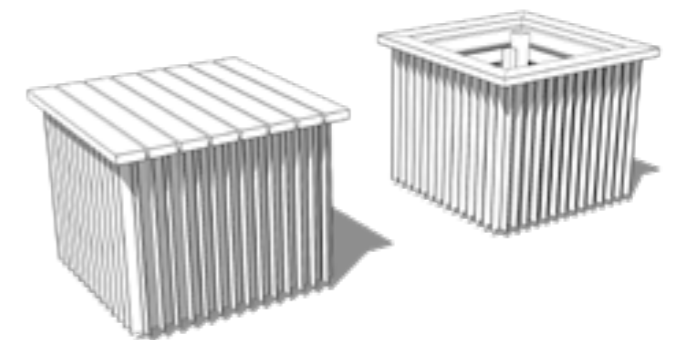

LINARTE ICON

FREESTANDING WALL

Linarte Icon adds an extra dimension to the garden. This architectural wall is available in a height and width according to your wishes, so the possibilities are endless: from a low garden wall, to a privacy wall, to spatial dividers that visually expand the garden. The vertical Linarte lines with Block 30 or Even blades form a seamless whole over the entire wall. In addition, one of the two sides can also be fitted with a stretched fibreglass fabric of your choice, which brings the warm feeling of textiles into the outdoor space. Material and colour can be matched to the outdoor furniture if required. You get extra atmosphere by adding Linarte Leds or wood inserts or by integrating an indirect lighting at the bottom of the wall that spreads a beautiful glow. Powder coated in any colour of your choice, the Linarte Icon in combination with the Linarte façade elements, seating elements, lighting, and Linarte wall in Camargue form one coherent whole around the house and throughout the garden.

SLEEK DESIGN

- Create a uniform look and feel with your façade cladding throughout your garden with the Renson Outdoor Concept range.

CUSTOMISABLE

- Combination of Linarte profiles, canvas fabric, or single-sided finishing.
- RAL colour of your choice.
- Cedar inserts or LED modules.
- Indirect lighting.

DURABLE QUALITY

- Posts in 4-mm-thick steel
- Finishing in high-quality aluminium, weatherproof and recyclable.

MAINTENANCE FRIENDLY

- Colourfast, easy to clean.

DIMENSIONS

- Width: min. 1260 mm
- Height: min. 400 - max. 2000 mm
- Thickness: min. 150 - max. 195 mm
- Distance between 2 support posts: max. 1200 mm
- Depth for concrete: 750 mm





ESAFE PARCEL LETTER BOXES

A driveway is invariably the calling card of a house & garden! By choosing the right style and materials, your driveway will have the same look as your dream home.

With a design parcel letter box, you take care of the final touch with finishing & **from now on, you will receive all your parcels safely at home 24/7.**

That's so much easier!

- Sleek design
- Available in all RAL colours
- Strong, quality powder-coating
- Stainless aluminium
- Personalisation & integration (number, name, colour, digital lock, doorbell, video-phone)
- Made in Belgium

Discover the full eSafe range of parcel letter boxes at www.my-esafe.be



FENIX TOP SMALL

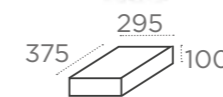

FENIX TOP MEDIUM

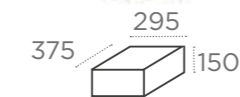

FENIX TOP LARGE



Parcel dimensions:



- ① Aero® patio cover - page 98
- ② Algarve® Canvas carport - page 152
- ③ Linius® façade element - page 140
- ④ Linarte® Outdoor Light S - page 166

CONCEPTS



- ① Linarte® façade element with LED lighting - page 140
- ② Linarte® ICON freestanding wall with LED lighting - page 170
- ③ Linarte® ICON freestanding wall with wood inserts - page 170
- ④ eSafe® Parcel letter box - page 173
- ⑤ Loggiawood® Linea sliding panels - page 136
- ⑥ Linarte® façade and gate cladding - page 140
- ⑦ Linarte® Outdoor Light S - page 166

- ① Aero® Canvas roof element - page 98
- ② Linarte® façade element with LED lighting and wood inserts - page 140
- ③ Aero® Canvas roof element - page 98
- ④ Linarte® Modulo 97 PLANT- page 168
- ⑤ Linarte® Modulo 97 SIT - page 168
- ⑥ Linarte® Outdoor Light M - page 166



- ① Algarve® Canvas Classic Line carport - page 152
- ② Linarte® Modulo combination PLANT - page 168
- ③ eSafe® Parcel letter box - page 173





- ① Algarve® 'Classic line' joined patio covers - page 80
- ② Linarte® Modulo 55 PLANT- page 168
- ③ Linarte® Outdoor Light S - page 166
- ④ Algarve® 'Classic line' Canvas coupled carport - page 152
- ⑤ Linius wall - page 140
- ⑥ Linius® Modulo 97 PLANT - page 168



- ① Camargue® joined patio covers - page 36
- ② Camargue® Skye patio cover - page 36
- ③ Linarte® Outdoor Light M - page 166
- ④ Linarte® Modulo 97 PLANT- page 168
- ⑤ Linarte® Modulo 97 SIT - page 168
- ⑥ Loggia® sliding panels - page 136
- ⑦ Linarte® custom - page 140



- ① Linarte® façade element - page 140
- ② Algarve® Canvas coupled carport - page 152
- ③ Linarte® ICON freestanding wall - page 170
- ④ Linarte® façade element with LED lighting and wood inserts - page 140
- ⑤ Linarte® Outdoor Light M - page 166
- ⑥ eSafe® Parcel letter box - page 173



- ① Algarve® roof element - page 80
- ② Linarte® façade element with LED lighting and wood inserts - page 140
- ③ Algarve® roof element - page 80
- ④ Linarte® Modulo 55 PLANT- page 168
- ⑤ Linarte® wall - page 140
- ⑥ Linarte® Outdoor Light M - page 166
- ⑦ Linarte® MODULO combination - page 168
- ⑧ Aero® roof element - page 98

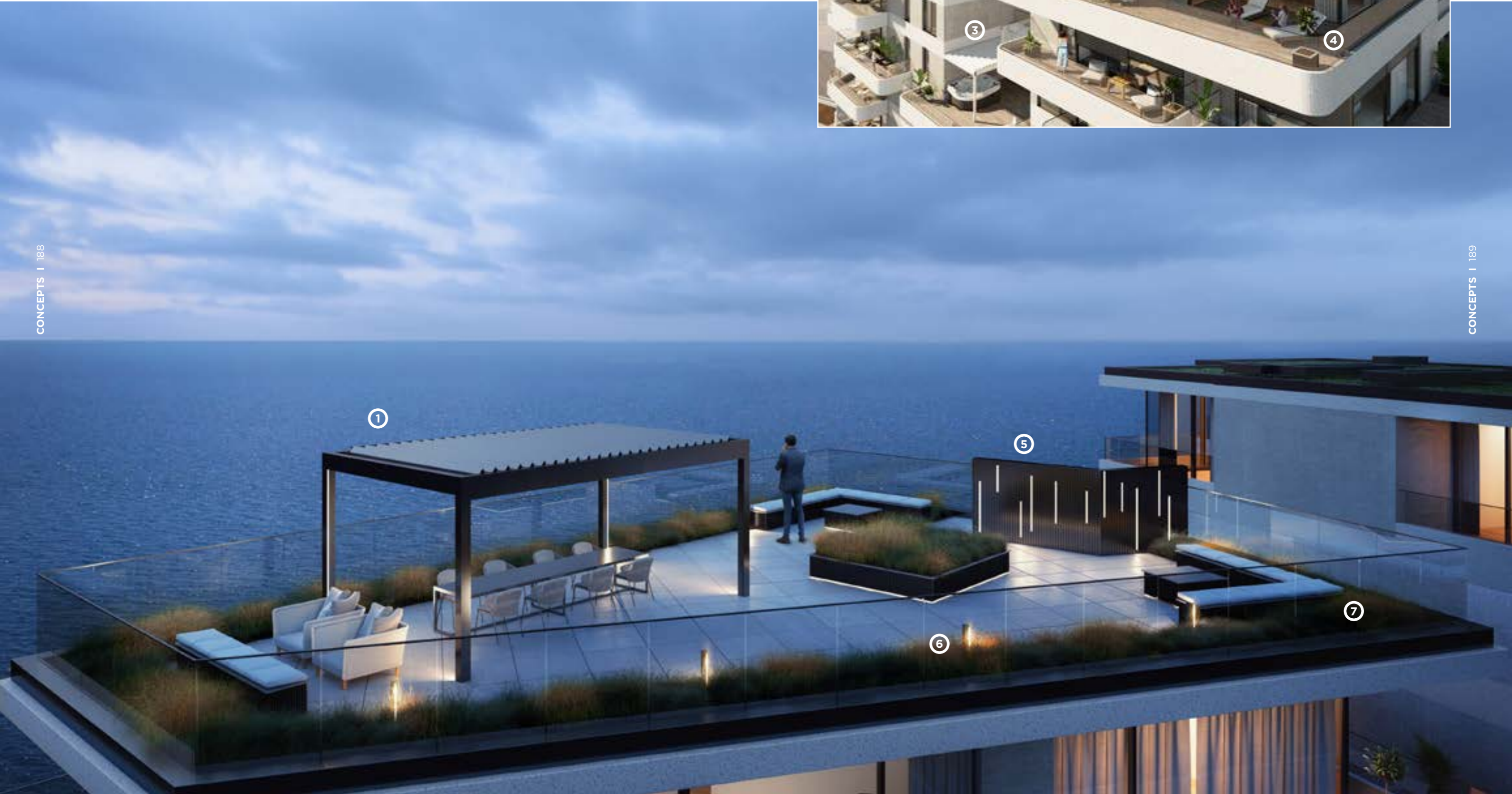

- ① Algarve® roof element - page 80
- ② Linius® façade element with LED lighting - page 140
- ③ Camargue® roof element - page 36
- ④ Side element Fixscreen® sun protection fabric - page 142
- ⑤ Linarte® Modulo combination PLANT - page 168
- ⑥ Fixscreen sun protection fabric
- ⑦ Linarte® Modulo 97 PLANT- page 168
- ⑧ Linarte® Modulo 55 & 97 SIT - page 168
- ⑨ Linarte® Outdoor Light M - page 166



- ① Camargue® roof element - page 36
- ② Linarte® façade element - page 140
- ③ Aero® Canvas roof element - page 98
- ④ Algarve® roof element - page 80
- ⑤ Linarte® modulo combination - page 140
- ⑥ Linarte® ICON - page 170
- ⑦ Linarte® Outdoor Light M - page 166



- ① Algarve® roof element - page 80
- ② Linius® façade element - page 140
- ③ Side element Fixscreen® sun protection fabric - page 142
- ④ Linarte® Modulo 55 SIT - page 168
- ⑤ Linius wall - page 140





Camargue®
Frame & blades RALxxxx
Fixscreen xxx
Loggiaxxxxx

PERFECT OUTDOOR CLIMATE, DAY AND NIGHT, IN ANY SEASON, THANKS TO RENSON®



WEATHER-RESISTANT

CAN BE CLOSED TO BLOCK OUT RAIN AND WIND

Lapure is a patio cover with waterproof, translucent sun protection fabric. The Fixscreen technology combined with optimum screen tension ensures that rainwater drains from the fabric via hidden channels. Even if the sun protection fabric is not fully unrolled, the water that falls on it is drained away via this integrated water drainage system.

Camargue Line, Algarve, and Aero Line are patio covers with rotating blades in the roof. These patented blades are designed in such a way that the water is drained off to the side even if the blades open up after it rains.

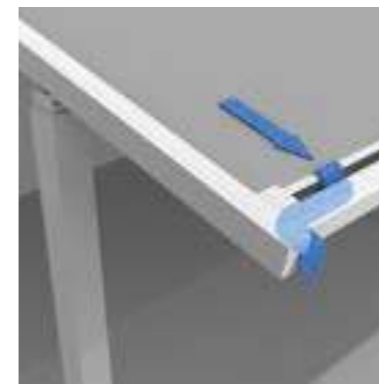

The Lapure can handle a rainfall intensity of 50 l/m² h for up to two minutes max. In heavy rainfall, water can flow over the bottom bar. Extreme rainfall can cause water sagging. In that case, the fabric must still be rolled up.

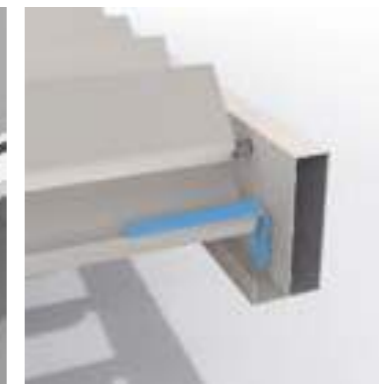

The Algarve Line can drain an amount of water equivalent to a rainfall intensity of between 120 l/m² h and 150 l/m² h that lasts up to two minutes max. This type of rainfall occurs on average once every 10 years in Belgium (cf. Belgian rain statistics: NBN B 52-011 standard).



The Camargue Line can drain an amount of water equivalent to a rainfall intensity of 150 l/m² h that lasts up to two minutes max. This type of rainfall occurs on average once every 15 years in Belgium (cf. Belgian rain statistics: standard NBN B 52-011).

TESTS

PROTECTION AND COMFORT

Our patio covers offer protection and comfort at various levels. To guarantee they can do so, they are thoroughly tested for water drainage, load-bearing capacity and wind resistance.

WATER TESTS

Water repellance and water drainage are tested using a spray installation that mimics rain. For example, we check the how much airflow our patio covers can extract and how this drainage can be optimised:

- Algarve Line: The Algarve Line can drain an amount of water equivalent to a rainfall intensity of 120 l/m² h that lasts up to two minutes maximum. This type of rainfall occurs on average once every 10 years in Belgium (cf. Belgian rain statistics: NBN B 52-011 standard).
- Camargue and Camargue Skye: The Camargue and Camargue Skye can drain an amount of water equivalent to rains with an intensity of 150 l/m² h that lasts up to 2 minutes maximum. This type of rainfall occurs on average once every 15 years in Belgium (cf. Belgian rain statistics: NBN B 52-011 standard).
- Lapure: The Lapure can maintain a precipitation rate intensity of 50 l/m² h for up to two minutes. In heavy rainfall, water can flow over the bottom bar.

LOAD-BEARING CAPACITY

Patio covers are subjected to various external forces (e.g. snow). The load-bearing capacity of our patio covers is determined using static strength calculations carried out by our engineers and validated through internal tests. The basic principle is that the structure is allowed to bend by 1/200 of its longest dimension without any permanent deformation.

The load-bearing capacity of Algarve and Camargue is dependent on the basic structure and the surface area. The diagram indicates the load-bearing capacity of our patio covers depending on their Span and Pivot dimensions.

In concrete terms: A patio cover with a Pivot of 6000 mm and a Span of 4000 mm may bend by 30 mm under a load of 55 kg/m² (i.e. 1320 kg across the entire patio cover). Another example: a patio cover with a 3375 mm Span and a 5835 mm Pivot can bear a load of an impressive 110 kg/m² (i.e. 2160 kg!).

External testing done on the Camargue shows that it can hold up at 200 kg/m² and remain intact, even for the largest patio cover dimensions.



200 Kg/m²

UNIQUE TO HEAVY WINDS AND STORMS - PERFECT FOR APPLICATION IN HIGH-RISE CONSTRUCTIONS



WIND TESTS

In order to determine the wind forces that our patio covers and vertical sun protection fabrics can withstand, wind tunnel tests were carried out.

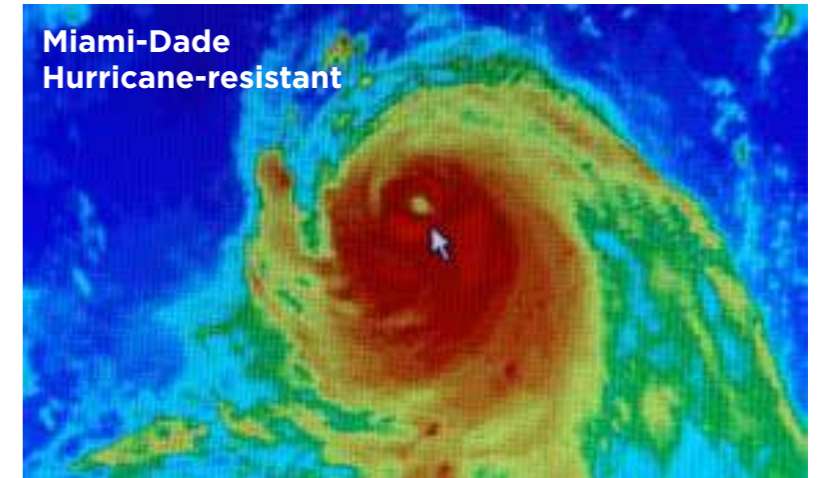

BEAUFORT SCALE



Beaufort	Description	Average speed in m/s	Average speed in km/h	Results
0	Calm	< 0.2	< 1	You don't feel the wind. Smoke will rise virtually straight up.
1	Light air	0.3 - 1.4	1 - 5	Wind direction can be read from the smoke plume, but not from the weather vane.
2	Light breeze	1.5 - 3.4	6 - 12	Wind can be felt on the face, leaves rustle, the weather vane moves visibly with the wind.
3	Gentle breeze	3.5 - 5.4	13 - 19	Flags wave and leaves move about constantly.
4	Moderate breeze	5.5 - 7.4	20 - 27	Dust blown up irritates eyes. Hair is awry.
5	Fresh breeze	7.5 - 10.4	28 - 37	Bushes rustle, white wave peaks on lakes and canals.
6	Strong breeze	10.5 - 13.4	38 - 48	Umbrellas are difficult to hold on to, large branches sway, power lines hum
7 FIXSCREEN®	High wind, moderate gale, near gale	13.5 - 17.4	49 - 62	It is difficult to walk into the wind. Trees sway.
8	Gale, fresh gale	17.5 - 20.4	63 - 73	Making headway is very difficult. Small branches break off.
9	Strong/severe gale	20.5 - 24.4	74 - 87	Chimney tops, roofing tiles and antennae blow away.
10 LAPURE®	Severe storm	24.5 - 28.4	88 - 102	Adults blow over. Major damage to buildings.
11 ALGARVE® LINE CAMARGUE SKYE®	Major, severe storm	28.5 - 32.4	103 - 117	Major damage to houses and forests.
12 CAMARGUE® LINE	Hurricane	> 32.5	> 118	Total destruction.

GUARANTEE*



	Structural elements	Motors and electronic control	Coating gloss and colour	Coating adhesion	Fixscreen® technology (zips)	Crystal window in the full width
Camargue®	10 years	2 years	5 years / 15 years*	10 years**	5 years	2 years
Camargue® Skye	10 years**	2 years	5 years / 15 years*	10 years**	5 years	2 years
Algarve® Line	10 years	2 years	5 years / 15 years*	10 years**	5 years	2 years
Aero® Line	10 years	2 years	5 years / 15 years*	10 years**	5 years	2 years
Lapure®	5 years	2 years	5 years / 15 years*	10 years**	5 years	2 years
Façade elements	5 years	2 years	5 years / 15 years*	10 years**	-	-
Garden elements	5 years	2 years	5 years / 15 years*	10 years**	-	-

* Subject to registration and annual maintenance with the Renson® Maintenance Set
 ** In areas <500 m from a coastline: 5-year warranty on adhesion
 *** 10-year warranty on the support structure and 5-year warranty on the mechanical parts

MAINTENANCE

EASY MAINTENANCE WITH THE RENSON MAINTENANCE SET

Your patio cover will be fully exposed to the elements for years – day in and day out. If you want to get the most out of your Renson® cover indefinitely, we recommend maintaining it regularly, i.e. once or twice a year. Regular maintenance will extend the lifespan of your cover. The following are important:

- The structure is made using powder coated aluminium. An annual cleaning with Renson Maintenance Set products will ensure that the intense colour is maintained for years, as well as providing extra protection from acid rain, sea air, and UV radiation. For coastal or wooded areas, we recommend maintenance of your installations at least twice a year.
- The Renson ‘Clean’ is a concentrated product with strong cleaning and degreasing properties to deal with the most frequent kinds of natural filth, such as dust, oily precipitation, grease stains, moss, insect remains, etc. This product cannot be compared to other cleaning products on the market. It sinks deeply and ‘lifts out’ the dirt. Renson ‘Clean’ can also be used to clean polyester roof fabrics and vertical fibreglass screen fabrics. After cleaning, you must protect the aluminium structure with Renson ‘Protect’. This leaves a protective film that allows the surface to be cleaned by simply wiping it down with a minimum amount of Renson ‘Clean’. It also protects the aluminium from acid rain, sea air, and UV radiation, and ensures the colour remains just as intense.
- Do not use either product in direct sunlight or in hot weather. The product’s quick-drying action can leave stains on the structure of the fabric. Do not use corrosive or aggressive products, scouring pads or other scouring products. Do not use high-pressure equipment under any circumstances.



Register your patio cover within 15 days of installation and receive a



WWW.RENSON-OUTDOOR.COM/GARANTIE



*A 5-year guarantee applies to the colour and gloss of the coating. If you register the patio cover and annually clean and protect it with the Renson Maintenance Set, you get an extended coating warranty of up to 15 years.

TIPS

COLUMN POSITIONS

Camargue Line, Algarve Line, and Lapure can also be ordered with 'shifted' columns. To give just one example, this can be useful if the patio covers needs to extend beyond the patio (but the columns need to remain on the patio), to ensure enough shade is provided even when the sun is low in the sky.

You can also choose shifted columns for placement or architectural reasons. The column can be shifted a maximal 1/5 of the total pivot length.



BLADE ROTATION DIRECTION

Blade rotation direction is important for the Camargue Line, Algarve Line, and Aero Line. Do you want to be able to protect against sunlight for as long as possible or allow sunlight to flood in as quickly as possible?

Renson® gives you that option. When adding a patio cover to a kitchen or a living room, for example, people usually want to admit light as quickly as possible.

- ① The blades rotate as standard, to the extent that the southern sunlight is blocked when opening the blades. Sunlight can also be allowed in with standard sun protection blades by rotating them further.

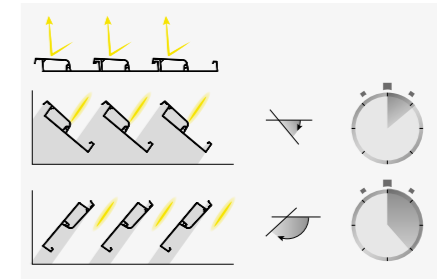

- ② With blades that draw sunlight in, the blades will move into the correct angle more quickly and the smooth, lovely bottom side remains visible.

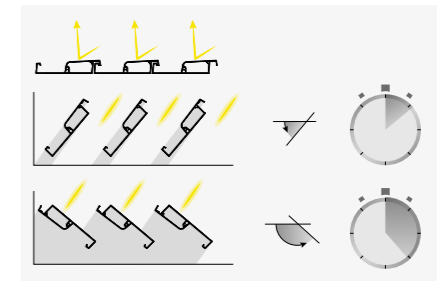

BLADE COLOUR

Camargue Line, Algarve Line, and Aero Line are available in dual colour (i.e. with roof blades in a different colour than the frame and columns) at no extra cost.

Tip: if your structure has a dark colour, select a lighter colour for the blades. A darker roof blade colour creates the impression of a lower ceiling. A lighter colour creates a sense of more space and has additional sun and heat protection properties.



VERANDA

Is a patio cover like the Camargue Line or Algarve Line similar to a veranda?
 No! A veranda is an extension of the living space enclosed in glass and creates an enclosed space that is completely wind and waterproof. In contrast, a patio cover is an open aluminium structure with a roof of rotating, aluminium blades that (possibly combined with side panels) primarily offers shelter from the sun and, to a certain extent, bad weather. The climate under a patio cover is essentially that of the outdoors, allowing users to enjoy the ambience, scents, colours, and sounds of the garden.
 Condensation can be formed on the bottom side of the blades in cold weather.
 Therefore, it is best to place weatherproof garden furniture under a Camargue Line or Algarve Line.

WIND - CAMARGUE LINE AND ALGARVE LINE

If high winds are forecast, we recommend closing the bladed roof (possible with wind speeds of up to 50 km/h). Closing the bladed roof makes the entire structure more rigid, meaning it can withstand high winds much better. We also offer a warranty on our Camargue Line and Algarve Line with the roof closed for wind speeds of up to 160 km/h for the Camargue and 120 km/h for the Algarve!

FABRIC OR BLADES?

How do I choose between a patio cover with a bladed roof (Camargue Line and Algarve Line) or a screen roof (Lapure)?
 Each type of patio cover has its own advantages. A patio cover with a sun protection fabric can be opened up completely. This allows you to keep sunlight out or allow it to enter across the full extent of the roof, depending on the weather conditions. Patio covers with roof blades allow users to control the amount of sunlight based on their requirements; when there is too much sunlight, the blades can be closed completely, but the roof can never be opened up completely to maximise the amount of sunlight.

	Bladed roof	Screen roof
Roof	Horizontal	Always at an angle
Position	Constructed, recessed, or freestanding	Only constructed
View of 'open' roof	Roof blades rotate open but don't 'disappear'	'Roof' completely disappears
Light in a "closed" roof	Opaque (except Lineo Luce blades)	Translucent
Load-bearing capacity	Can bear snow	Cannot bear snow
Colour of the roof	All possible colours	Limited range of colours available for fabric screen roof

LOW SUN: FIXSCREEN

When the sun is low in the sky, sunlight can come in underneath the patio cover and into your home. This is a great way to warm your house up naturally in winter. However, this sunlight can be disruptive at times and may cause temporary blinding, discolouration or reflections on TV and computer screens. The sunrays are blocked thanks to vertical sun protection fabric (Fixscreen) in the sides of your patio cover (Camargue Line). Since the Fixscreen fabric is translucent, contact with the outdoor environment is preserved.



PASSAGE HEIGHT

The passage height of a bladed roof (Camargue Line and Algarve Line) can be freely chosen. People usually choose a height based on their specific circumstances (e.g., for add-on constructions, there might be a rain gutter or window in the way) or for personal reasons; tall people might prefer a higher passage height to create a certain amount of 'openness'. On the other hand, it is best to have the lowest possible passage height for the most shade.



PATIO ORIENTATION

Depending on the orientation of your patio, you can decide to position your patio cover otherwise. Patio covers with fabric (Lapure) or adjustable blades (Camargue Line and Algarve Line) are both good solutions for a south-facing patio. You can keep the heat of the sun at bay by rolling out the fabric or closing the blades. For a bladed roof, blades should be placed parallel to the home. This gives you maximum control over the amount of sunlight that enters: you can choose to keep the light out entirely or partially or allow it to flood in.

For a north-facing patio, installing the blades perpendicular to the wall is a good idea. This is the best way to control the light coming in from the east and west, while allowing the maximum amount of light to enter with the roof open.

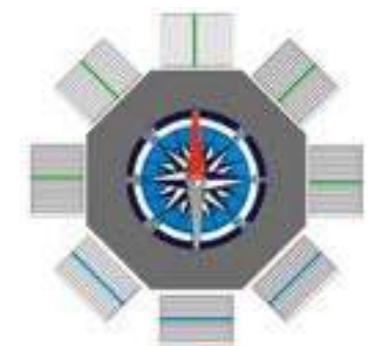

■ E-NE-N-NW-W: blades perpendicular to the wall.
 ■ SW-S-SE: blades parallel to the wall.

THE MOST FREQUENTLY ASKED QUESTIONS ABOUT RENSON® PATIO COVERS...

CAN A RENSON® PATIO COVER BE MADE TO MEASURE?

All Renson® covers are custom-made to within a millimetre, at no extra cost.

WHAT ARE THE MAXIMUM DIMENSIONS?

That depends on the type of cover. Please consult the product table in this brochure. This table shows the possible dimensions of one roof module. Modules can be joined to obtain larger dimensions.

WHICH COLOURS ARE POSSIBLE?

The top 100 RAL colours are available in textured coating at no extra cost.

This allows you to match the colour of your patio cover to the joinery of your home. The blades can be chosen in a top 100 RAL colour other than the structure at no extra cost.

DOES THE COVER ALWAYS HAVE TO BE PLACED AGAINST A WALL OR IS FREESTANDING ALSO AN OPTION?

Covers with bladed roofs (Camargue line and Algarve line) can either be placed as freestanding or against the building.

Patio covers under an incline, with a screen or fabric roof, can only be built against a house or other construction.

The Aero roofs are specially designed to be built into a new or existing support structure.

DON'T THE BLADES IN THE ROOF KEEP OUT TOO MUCH LIGHT?

You have full control over the intensity of the light with blades.

When closed, there is no light transmission. Alternatively, you could install a few glass or LED blades for more light.

When the blades are slightly rotated, a significant amount of light floods in quickly.

With the Camargue Skye, you can not only rotate, but also slide the blades to one side. This gives you a completely open roof.

IS A BLADED ROOF COMPLETELY WATERPROOF?

In addition to sun protection, bladed roofs and Fixscreen roofs also offer full protection from the rain.

However, you should bear in mind that a patio cover is an open aluminium structure, not to be confused with a veranda. Furniture and floors must therefore be suitable for outdoor use.

WHAT OPTIONS ARE POSSIBLE FOR PATIO COVERS?

Renson® covers can be equipped with a wide range of accessories and thus perfectly configured to your personal taste. (Fixscreen sun protection, Loggia sliding panels, glass sliding panels, lighting, heating, music, etc.)

CAN I ALSO ENJOY MY PATIO COVER DURING THE OTHER SEASONS?

Absolutely! The best way is to equip the cover with the appropriate side inserts (Fixscreen, Loggia, or glass sliding panels). Lighting and heating are also among the possibilities to enjoy in all seasons all year round.

HOW SHOULD I CLEAN THE PATIO COVER?

Your Renson® cover will be fully exposed to the elements for years – day in and day out. If you want to enjoy it optimally at all times, we recommend annual cleaning with the Renson Maintenance Set products. This maintenance set products will ensure that the intense colour is maintained for years, as well as providing extra protection from acid rain, sea air, and UV radiation (see also the extended warranty for annual use).

DOES A COVER INCREASE THE VALUE OF MY HOUSE OR PROPERTY?

Of course. Official estimates of homes with a Renson® cover also include this in the valuation of the property.

Investing in a Renson® cover is therefore an immediate way to increase the value of your home!

DOESN'T IT GET TOO HOT UNDER A BLADED ROOF?

Not only does a bladed roof provide protection from the sun, it also ventilates. If the air under the cover warms up too much, a ventilation effect can be created by simply rotating the blades slightly, so that the warm air flows away through the roof.

HOW LONG DOES IT TAKE THE HEATER TO REACH MAXIMUM HEAT?

Because we work with a short-wave system, the heater reaches maximum heat radiation almost immediately. Short-wave radiated heat is directly palpable, similar to the heat of solar radiation. You heat up the objects and not the space. Long-wave infrared heaters have a longer warm-up time than the short-wave heaters. They need air to transmit heat. Depending on the ambient temperature, size of the cover, if it's closed or not, etc., it can take some time before you feel the maximal radiated heat.

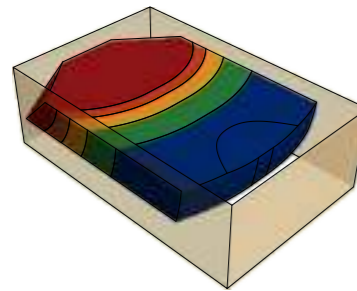

Heat effect with 1 side heated (6 x 4 m format)

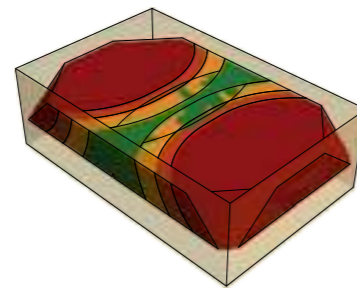

Heat effect with 2 sides heated (6 x 4 m format).

PERFECT HEATER POSITION

The perfect position for the heater is across from the fixed wall so that you can enjoy the reflected heat.



HEATED ENCLOSURES

To enjoy your heater to the fullest, we recommend adding components (such as glass walls, Fixscreen, etc.) that will enclose the sides of the patio cover.



WHAT IS THE SOUND LEVEL OF RAIN WHEN IT FALLS ON A PATIO COVER?

The sound level depends largely on the intensity of the rain and cannot easily be quantified. In covers with a screen roof, the amount of noise is comparable to rain falling on a tent. In covers with a bladed roof, you'll hear a muffled metallic sound. As we use double-walled blades, the noise is less sharp than with single-walled blades. In covers with a fixed roof (Algarve Canvas and Aero Canvas), rain falls directly on the steel roof. The anti-condensation layer on the roof slightly dampens the sound of rainfall, so it doesn't sound too sharp. The sound level on a fixed roof can be compared to that of a bladed roof in the same amount of rain.

HOW LONG DOES A PATIO COVER INSTALLATION TAKE?

It usually only takes a day for the cover to be placed. Depending on the number of options and inserts, the installation process could take two days. This does not include any foundation works.

CAN THE ROOF BLADES BE OPERATED IN FROSTY CONDITIONS?

If the blades are not fully closed, you can continue to operate them in frost. If the blades are fully closed, condensation between the blades may cause them to freeze shut. In this case, the roof should not be operated.

WILL FIXSCREENS OBSTRUCT MY OUTSIDE VIEW?

The transparency of Fixscreens is affected by the amount of light they reflect. In bright, sunny weather, it is near impossible to look into the patio cover from the outside. On the other hand, when you switch the LED lighting on in the evening, it will be less easy to look out of the cover from underneath. A darker-coloured screen will reflect less light, which makes it easier to see through than a light-coloured screen. Our Privacy fibreglass fabrics have a more tightly woven structure with just 1% openness, meaning even darker-coloured fabrics are much less transparent.

CAMARGUE® LINE

The Camargue Line is a series of innovative patio covers with a modular structure that can be expanded as required and closed on all sides with integrated side elements.

THE CAMARGUE LINE INCLUDES TWO TYPES OF COVERS:

- Camargue: with rotating blades
- Camargue Skye: with rotating and sliding blades



Camargue® + Camargue Skye®

MODULAR DESIGN

Expandable to include multiple roof sections, even after the initial installation. The structure can be endlessly expanded on both the span and pivot side to cover large surface areas.

INNOVATION THE FABRIC ROLLER TUBE IS FULLY INTEGRATED INTO THE STRUCTURE

No visible screen head box disrupting the aesthetic

THE BOTTOM BAR DISAPPEARS INTO THE HEAD BOX

INNOVATION INTEGRATED FIXSCREEN SIDE GUIDING CHANNELS IN THE COLUMNS

Full aesthetic integration with the Camargue structure



Camargue® + Camargue Skye®

INTEGRATED WATER DRAINAGE WITH LARGE AIRFLOW

Through the wide blade gutters, water flows towards gutters with diffusers to prevent splashing before being drained via PVC drainpipes integrated into the columns.

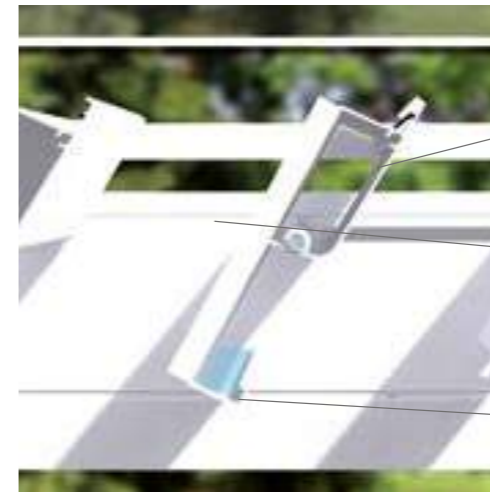

Camargue® + Camargue Skye®

DOUBLE-WALLED BLADES FOR EXTRA STRENGTH

Load-bearing capacity: 200 kg/m²

WELDED ALUMINIUM DRIPS, POWDER COATED TO MATCH THE COLOUR OF THE ROOF BLADES

INNOVATION SPECIALLY DEVELOPED GUTTER BORDER

Prevents your patio and furniture from getting wet when the blades are opened following a rain shower



Camargue®

F2 TECHNOLOGY

With a span system that ensures the rigidity of its support structure, Camargue remains stable even in strong winds.

S-DRIVE TECHNOLOGY

Reliable and durable rotating and sliding technology



SYNCHRONISED DRIVE ON BOTH SIDES OF THE BLADES

Even with an asymmetric load, the roof will open and close in one smooth movement



'TRAIN' SYSTEM (OTHER BRANDS ON THE MARKET)

Only the first blade (the locomotive) is driven, and all other blades (the carriages) are passively pulled along.



RENSON® S-DRIVE

Driven by a spindle that evenly distributes traction across all blades.

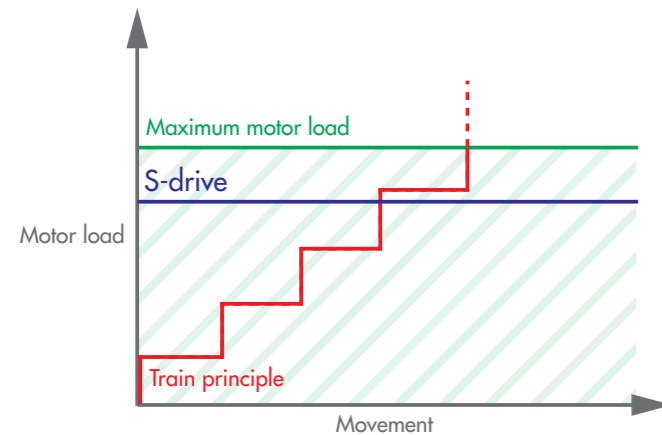

INNOVATION



SPINDLE FOR SLIDING BLADES

TROLLEYS ON RAILS ENSURE SMOOTH AND STABLE MOVEMENT

Each blade is driven individually

HEXAGONAL AXLE FOR ROTATING BLADES

STRONG, DOUBLE-WALLED BLADES CAN HANDLE HEAVY SNOW LOADS

THE ROOF IS COMPLETELY FLAT WHEN CLOSED

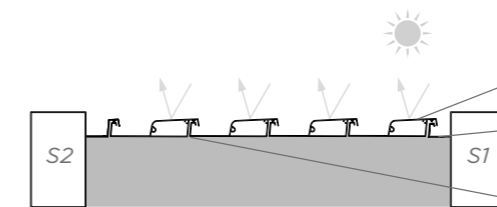

NO GAPS BETWEEN THE BLADES

INSTALLATION OPTIONS CAMARGUE® LINE

TYPES OF INSTALLATION

There are 2 types of installation possible for the Camargue Line: freestanding and facade mounting.



Freestanding: the frame of the Camargue is supported by four vertical columns



Facade mounting: the frame is placed with one or two sides against an underlying, supporting construction or structure. Vertical columns support the other part. The blades can be positioned parallel or perpendicular to the support structure.

JOINABLE

The Camargue Line can be joined using one of the larger Spans or Pivots to cover larger surface areas. In this case, a coupling side beam is used.



Camargue coupled on Pivot side



Camargue Skye 2-part coupled on the Span side, similar slide direction and orientation



2-part coupled on the Span side



Camargue coupled on the Pivot and/or Span side



Camargue Skye 2-part coupled on the Span side, opposing slide direction and orientation

INTEGRATED FIXSCREEN®

By integrating the vertical sun protection, the integrated Fixscreen, with or without Crystal Windows to maximise a view of the outside, you can create an extra outdoor room where users are protected from sun, rain, and wind. These screens come in 50 colours and allow you to customise the Camargue Line and create the atmosphere you desire.



The Camargue Line is fitted with the integrated Fixscreen in the Span and Pivot side

CUSTOMISATION OPTIONS

The Camargue Line can have various elements fitted to the front and/or sides. By adding side elements, you create infinite possibilities for customisation.



Loggia sliding panel: Loggiawood, Loggiawood Privacy, Loggiascreen Canvas, Loggialu, Loggialu Privacy



Glass sliding panel + integrated Fixscreen



Loggia easy passage: Loggiascreen Canvas

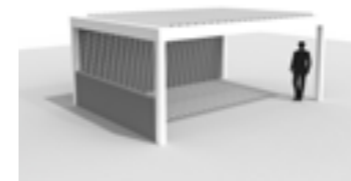

Linus fixed walls: full passage height or desired height + Linarte fixed wall



Glass sliding panels



Curtains

MOUNTING BASES

Mounting bases are available in visible (whether or not against a building), invisible, or cast-mounted. If side inserts are used or this is used in locations with increased wind forces, reinforced visible and invisible mounting bases are available to guarantee the extra stability the construction requires.

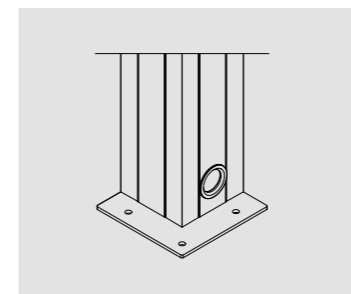

Visible mounting base

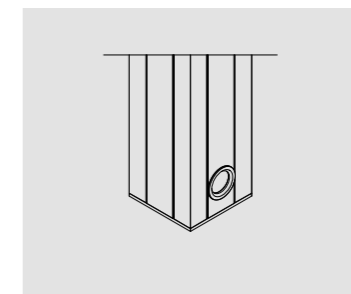

Invisible mounting base

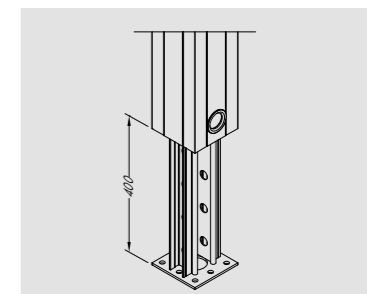

Cast mounting base

ALGARVE® LINE

The Algarve Line is a series of elegant aluminium patio covers that can be closed with surface-mounted side elements.

THE ALGARVE LINE INCLUDES 2 TYPES OF COVER:

- Algarve: with rotating aluminium roof blades to control sun protection and ventilation
- Algarve Canvas: with a horizontal, rigid, water-draining fixed roof and aesthetically finished lower roof made of tautly stretched fabric using Fixscreen technology



MINIMALIST DESIGN

Sleek profiles and invisible screw joints combine to create an elegant structure. In the Algarve bladed roof, that's made possible by a motor subtly hidden on the top of the frame to add to the overall aesthetic.

JOINED IN TWO PARTS

Two roof sections can be joined to create a maximum 6 x 6 m span without any additional columns. The roof sections can be fitted with a bladed or canvas roof, and a combination of blades and canvas is also possible. There is no need for both roof sections to have the same finish.

SURFACE-MOUNTED SIDE ELEMENTS

Fixscreens, glass sliding panels, Loggia panels, fixed walls or outdoor curtains can be fitted to the structure as surface-mounted elements.



Algarve®



F2 TECHNOLOGY

With a secure fastening system that ensures the rigidity of its support structure, Algarve remains stable even in strong winds.



Algarve®

DOUBLE-WALLED BLADES FOR EXTRA STRENGTH

Load-bearing capacity: 100 kg/m²

WELDED ALUMINIUM DRIPS, POWDER COATED TO MATCH THE COLOUR OF THE ROOF BLADES

SPECIALLY DEVELOPED GUTTER BORDER

Prevents your patio and furniture from getting wet when the blades are opened following a rain shower



Algarve® Canvas

WATER DRAINAGE VIA RIGID UPPER ROOF

Equipped with a leaf catcher to prevent blockages and an anti-condensation layer to prevent drops from forming on the underside of the roof

INTEGRATED WATER DRAINAGE

Via gutters all around the structure

RIGID, WATER-DRAINING UPPER ROOF

Made of profiled steel sheets
Load-bearing capacity: > 100 kg /m²

AESTHETIC LOWER ROOF

Made of tautly stretched fabric with Fixscreen technology

PERFECT FINISHING

Sealing profile stops dirt and insects



Algarve® Canvas



INSTALLATION OPTIONS ALGARVE® LINE

TYPES OF INSTALLATION

The Algarve Line includes two possible types of installation: freestanding and facade mounting.

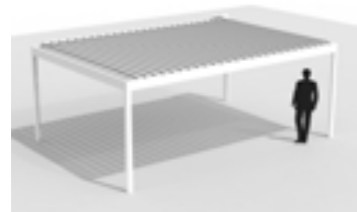

Algarve - Freestanding



Algarve Canvas - Freestanding

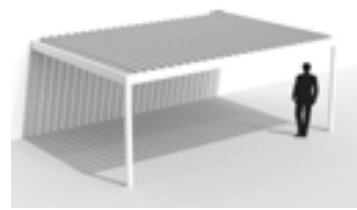

Algarve - Facade mounting

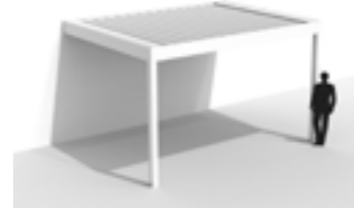

Algarve Canvas - Facade mounting

TIP

Thanks to its smart design, Algarve Canvas can be extended. By closing off the walls, you can also create an adjoining storage room. That way you can safely store bikes, garden furniture, the lawnmower, etc. while conserving space in your home. The extension of an Algarve Canvas carport can be done along both the length and width of the carport:



Example of an extension in length:
7 x 3.5 metres



Example of an extension in width:
5 x 5.5 metres

CUSTOMISATION OPTIONS

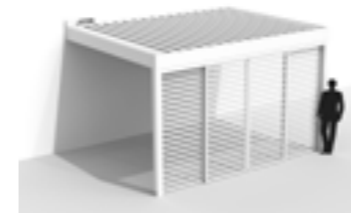

Loggia

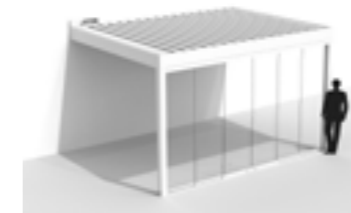

Glass sliding panels

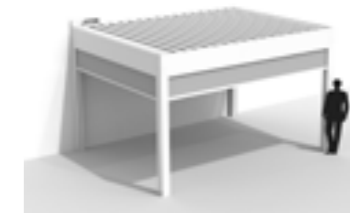

Surface-mounted Fixscreen

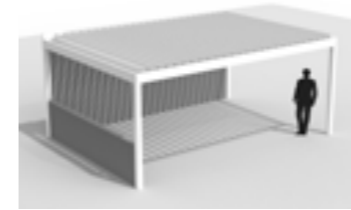

Linius fixed wall

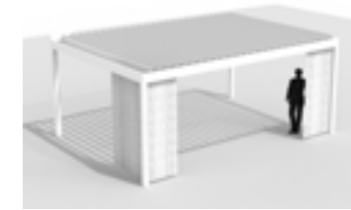

Curtains

ALGARVE® FIXSCREEN®

To close the sides of Algarve Line, it is possible to combine them with an Algarve Fixscreen. This allows the sun protection head box to be mounted underneath the frame profiles so that it connects perfectly with the basic construction.

TIP

The Algarve Line with one or two Fixscreens combined with 2 Lineo LEDs is available as an affordable Comfort Pack.

JOINABLE

Algarve can be coupled in two parts (width-wise) so that exceptional surface areas of 6 x 6.05 m can be covered without middle columns disrupting the view. Moreover, the Algarve Line in its coupled version is perfectly feasible with a bladed roof in one part of the roof and a fixed roof in the other part.

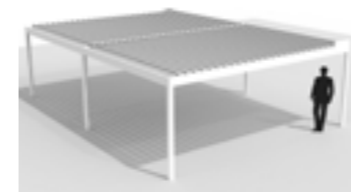

Algarve - 2-part coupled on the Span side



Algarve coupled with Algarve Canvas



Algarve Canvas - 2-part coupled on the Pivot side

AERO® LINE

The Aero Line is a series of functional roofs customised to the mm that integrate beautifully into a fixed structure.

THE AERO LINE INCLUDES TWO TYPES OF COVERS:

- Aero: with a rotatable bladed roof
- Aero Canvas: with a horizontal, rigid, water-draining fixed roof and aesthetically finished lower roof made of tautly stretched fabric using Fixscreen technology



Aero® Canvas

WATER DRAINAGE VIA RIGID UPPER ROOF

With leaf catcher to prevent blockages

INTEGRATED WATER DRAINAGE

Via gutters all around the structure



Aero® Canvas

AESTHETIC, HORIZONTAL LOWER ROOF

Tension ceiling with Fixscreen technology for outdoor use



INNOVATION

F2 TECHNOLOGY

Every blade is secured to the frame to create a strong and stable structure

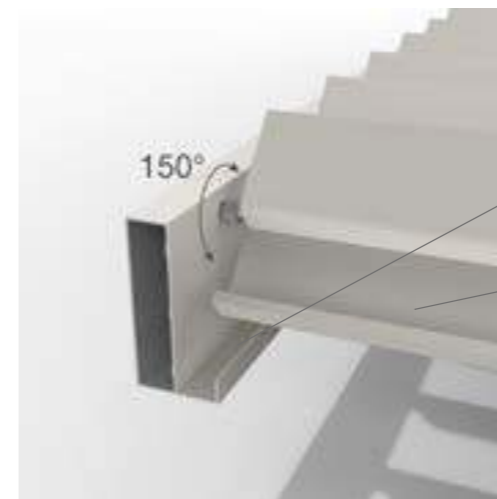

Aero®

SPLASH PREVENTION

Via integrated water-guiding system channels with diffusers

HIGH WATER DRAINAGE FLOW

Through the wide blade gutters



Aero®

BRUSHES ENSURE BLADES CLOSE GENTLY AND PREVENT THEM FROM FREEZING SHUT

DOUBLE-WALLED BLADES FOR EXTRA STRENGTH

Load-bearing capacity: 100 kg/m²

WELDED ALUMINIUM DRIPS, POWDER COATED TO MATCH THE COLOUR OF THE ROOF BLADES

SPECIALLY DEVELOPED GUTTER BORDER

Prevents your patio and furniture from getting wet when the blades are opened following a rain shower

LAPURE®

Minimalist patio cover with a water and wind-resistant sun protection Fixscreen roof and an open, panoramic view. Can be closed with surface-mounted side elements.



WATERPROOF, TRANSLUCENT FABRIC

DURABLE INNER RAIL WITH SMOOTH TECHNOLOGY

For smooth, durable, and silent zip operation

SYMMETRICAL ZIP ENSURES HIGH WIND RESISTANCE

High wind guarantee up to 100 km/h

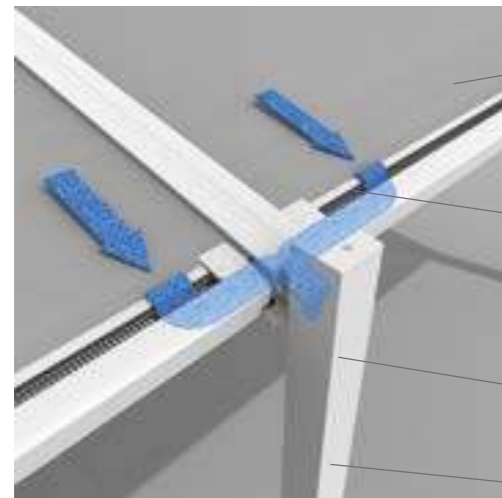

CAN BE JOINED MULTIPLE TIMES

Can be joined multiple times to cover large surface areas

INTEGRATED WATER DRAINAGE VIA BOTTOM BAR AND SIDE GUIDING CHANNELS

Water drainage even if the roof is not fully closed

WATER IS DRAINED VIA THE COLUMNS

SHIFTED COLUMNS ARE POSSIBLE



UNINTERRUPTED PANORAMIC VIEW

No visible front bar when fabric is retracted

LAPURE® INSTALLATION OPTIONS

TYPES OF INSTALLATION

1 ROOF SECTION

Without roof overhang (with 'end columns')

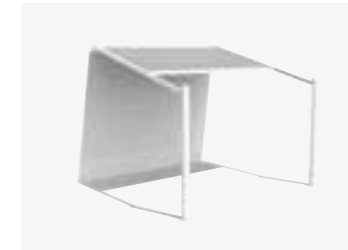

With roof overhang (with 'shifted' columns)



2 ROOF SECTIONS



3 ROOF SECTIONS

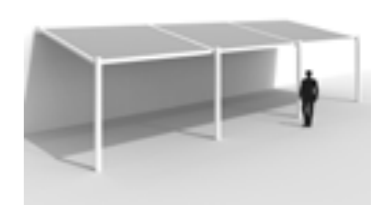

CUSTOMISATION OPTIONS



Lapure fitted with a Fixscreen and sliding door using Loggia screen Canvas in the side



The Lapure 'Classic Line' creates a classic, traditional style by adding decorative elements: stylised columns and finials in a globe or diamond shape.



1 roof section between 4 and 6 m: including a cross-beam (with or without LED)



**BUILDING OR RENOVATIONS PLANS?
VISIT OUR SHOWROOM IN BELGIUM**

EXIT 5 is open
Monday to Friday: Monday to Friday: 8.30 a.m. - 12 p.m and 1.30 p.m - 6 p.m.
Saturday: 9 a.m. - 12 p.m.

Make an appointment by phone on 056 62 96 87 or online via www.exit5.be

Maalbeekstraat 10 - 8790 Waregem - Belgium
www.exit5.be

NEW YORK SHOWROOM - USA

Ernest NY • 255 5th Avenue • 6th Floor • NY 10016
+1 310 658 4878 • www.ernestny.com



SHANGAI SHOWROOM - CHINA

No 33, Lane 672, Changle Rd
Jingan District
Shanghai, China
Tel: +86 21 6418 2566



**WHO DO I CONTACT
FOR RENSON® PRODUCTS?**

In order to guarantee that our high-quality and durable products are also placed professionally, we have built up a network of well-trained Ambassadors and Installers.

RENSON® PREMIUM AMBASSADORS

These ambassadors have years of experience in the sale and installation of Renson® products. They keep up to date on the complete range and guarantee the utmost professional assistance.

RENSON® AMBASSADORS demonstrate our products in their showrooms and ensure that everything is placed in a professional and sound manner. They also guarantee a professional after-sales service.

Also see www.renson.eu



ALSO DOWNLOAD OUR
OTHER INSPIRATION
BROCHURES FROM
WWW.RENSON.EU



VENTILATION



SUN PROTECTION



FAÇADE CLADDING

All photos shown are solely for illustration purposes and are a snapshot of the usage situation. The actual product may vary due to adjustments to the product. Renson® reserves the right to make technical changes to the products shown. The most recent brochures are available for download at www.renson.eu



RENSON® Headquarters
Maalbeekstraat 10, IZ 2 Vijverdam B-8790 Waregem
Tel. +32 (0)56 30 30 00
info@renson.eu
www.renson-outdoor.com



DISCOVER ALL OUR SOLUTIONS ON
WWW.RENSON.EU FOR:

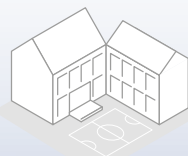

SCHOOLS



OFFICE BUILDINGS
APARTMENTS

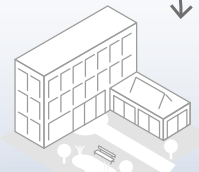

CARE SECTOR



L0000270 03/21 English