

COLDPARTS BARGAIN COMPRESSOR CATALOG

SUMMER 2023
CATALOG NO. **94**

OUR 62th YEAR OF SERVING THE REFRIGERATION
AND AIR CONDITIONING INDUSTRY

OEM SURPLUS CLOSE OUT OF REFRIGERATION AND AIR CONDITIONING
COMPRESSORS - OUT OF MANUFACTURERS WARRANTY - LIMITED QUANTITIES -
ALL COMPRESSORS OFFERED SUBJECT TO PRIOR SALE.

GO TO WWW.COLDPARTS.COM
FOR SPECIAL DEALS ON OUR
NEW WEB SITE.

AIR CONDITIONING COMPRESSORS

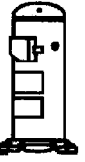

COPELAND SCROLL AIR CONDITIONING COMPRESSORS R-410a 230/60/1/PHASE

COPELAND SCROLL AIR CONDITIONING COMPRESSORS R-410a 230/60/3/PHASE

Cat.#	Model	H.P.	BTU	Volts/Ph	Price Ea.
F13ZP14	ZP14K6E-PFV	1-1/4	14,000	230/60/1	\$ 225.00
F13ZP16	ZP16K5E-PFV	1-1/2	16,000	230/60/1	250.00
F13ZP20	ZP20K5E-PFV	1-7/5	20,000	230/60/1	295.00
F13ZP21	ZP21K53-PFV	2	21,000	230/60/1	315.00
F13ZP24	ZP24K5E-PFV	2	24,000	230/60/1	325.00
F13ZP25	ZP25K5E-PFV	2	25,000	230/60/1	325.00
F13ZP26	ZP26K3E-PFV	2-1/4	26,000	230/60/1	350.00
F13ZP29	ZP29K5E-PFV	2-1/4	29,000	230/60/1	395.00
F13ZP31	ZP31K5E-PFV	2-1/2	31,000	230/60/1	395.00
F13ZP32	ZP32K3E-PFV	2-1/2	32,000	230/60/1	395.00
F13ZP34	ZP34K5E-PFV	3	34,000	230/60/1	425.00
F13ZP36	ZP36K5E-PFV	3	36,000	230/60/1	425.00
F13ZP38	ZP38K5E-PFV	3	38,000	230/60/1	450.00
F13ZP39	ZP39K5E-PFV	3-1/4	39,000	230/60/1	450.00
F13ZP42	ZP42K5E-PFV	3-1/2	42,000	230/60/1	475.00
F13ZP44	ZP44K5E-PFV	3-3/4	44,000	230/60/1	495.00
F13ZP51	ZP51K5E-PFV	4-1/2	51,000	230/60/1	575.00
F13ZP54	ZP54K5E-PFV	4-1/2	54,000	230/60/1	595.00

Cat.#	Model	H.P.	BTU	Volts/Ph	Price Ea.
F13ZP243	ZP24K5E-TF5	2	24,000	230/60/3	\$ 325.00
F13ZP253	ZP25K5E-TF5	2	25,000	230/60/3	325.00
F13ZP383	ZP38K5E-TF5	3	38,000	230/60/3	450.00
F13ZP393	ZP39K5E-TF5	3	39,000	230/60/3	450.00
F13ZP423	ZP42K5E-TF5	3-1/2	42,000	230/60/3	475.00
F13ZP503	ZP50K3E-TF5	4	50,000	230/60/3	575.00
F13ZP513	ZP51K5E-TF5	4-1/2	51,000	230/60/3	575.00
F13ZP543	ZP54K3E-TF5	4-1/2	54,000	230/60/3	595.00
F13ZP613	ZP61KCE-TF5	5	61,000	230/60/3	625.00
F13ZP673	ZP67KCE-TF5	6	67,000	230/60/3	675.00

R-410a 460/60/3/PHASE

Cat.#	Model	H.P.	BTU	Volts/Ph	Price Ea.
F13ZP29D	ZP29K5E-TFD	2-1/4	29,000	460/60/3	\$ 395.00
F13ZP31D	ZP31K5E-TFD	2-1/2	31,000	460/60/3	395.00
F13ZP36D	ZP36K5E-TFD	3	36,000	460/60/3	425.00
F13ZP42D	ZP42K5E-TFD	3-1/2	42,000	460/60/3	475.00
F13ZP49D	ZP49K5E-TFD	4	49,000	460/60/3	550.00
F13ZP51D	ZP51K5E-TFD	4-1/2	51,000	460/60/3	575.00

R-410a TWO STAGE SCROLL COMPRESSORS

Cat.#	Model	H.P.	BTU	Volts/Ph	Price Ea.
F13ZPS20	ZPS20K5E-PFV	2	20,000	230/60/1	\$ 295.00
F13ZSP21	ZPS21K5E-PFV	2	21,000	230/60/1	325.00
F13ZPS30	ZPS30K5E-PFV	2-1/2	30,000	230/60/1	395.00
F13ZPS40	ZPS40K5E-PFV	3-1/4	40,000	230/60/1	475.00
F13ZPS49	ZPS49K5E-PFV	4	49,000	230/60/1	550.00
F13ZPS51	ZPS51K5E-PFV	4-1/2	51,000	230/60/1	575.00

COPELAND SCROLL R-22 A/C COMPRESSORS

Cat.#	Model	H.P.	BTU	Volts/Ph	Price Ea.
F1132ZD	ZR32KA-TFD	2-1/2	32,000	460/60/3	\$ 350.00
F1142ZD	ZR42K3-TFD	3-1/2	42,000	460/60/3	425.00
F1144ZD	ZR44KA-TFD	3-3/4	44,000	460/60/3	450.00
*A1C144ZD	ZR144KCE-TFD	12	144,000	460/3/60	1395.00
*A1C190ZD	ZR190KCE-TFD	16	190,000	460/3/60	1895.00
*A1C50ZBD	ZB50KCE-TFD	7	79,000	460/3/60	1195.00
*A1C76ZBD	ZB76KCE-TFD	10	119,000	460/3/60	1395.00

BRISTOL 2 STAGE R410A A/C COMPRESSORS

Cat.#	Model	H.P.	BTU	Volts/Ph	Price Ea.
F13T81J19	T81J195CBCA	1-3/4	19,000	230/1/60	\$ 350.00
F13T81J38	T81J384CBCA	3-1/4	38,000	230/1/60	450.00
F13T89A51	T89A515BBCA	4-1/2	51,000	230/1/60	595.00

LG SCROLL AIR CONDITIONING COMPRESSORS R-410a 230 VOLTS 1PH 60 HZ

Cat.#	Model	H.P.	BTU	Volts/Ph	Price Ea.
F13026K1	APA026KKA	2-1/4	26,000	230/1/60	\$ 275.00
F13029K1	APA029KAB	2-1/2	29,000	230/1/60	285.00
F13030K1	APA030KAA	2-1/2	30,000	230/1/60	285.00
F13031K1	APG031KAC	2-1/2	31,000	230/1/60	325.00
F13038K1	AQA038KAA	3-1/4	38,000	230/1/60	350.00
F13040K1	AQA039KAA	3-1/4	39,000	230/1/60	350.00
F13040K1	AQA040KAA	3-1/4	40,000	230/1/60	375.00
F13042K1	AQA042KAB	3-1/2	42,000	230/1/60	395.00
F13049K1	ABG049KAA	4	49,000	230/1/60	450.00
F13051K1	ABA051KAE	4-1/4	51,000	230/1/60	495.00

LG SCROLL AIR CONDITIONING COMPRESSORS R22 230 VOLTS 1PH 60 HZ

Cat.#	Model	H.P.	BTU	Volts/Ph	Price Ea.
F13022SQ	SQA022KAC	2	22,000	230/1/60	\$ 295.00
F13026SQ	SQA026KAC	2-1/4	26,000	230/1/60	325.00
F13032SQ	SQA032KAC	2-1/2	32,000	230/1/60	350.00
F13038SQ	SQA038KAC	3-1/4	38,000	230/1/60	425.00

F13HAR COPELAND-LG WIRING HARNESS \$25.00

SAMSUNG ROTARY COMPRESSORS FOR A/C, HEAT PUMPS AND MINI-SPLIT SYSTEMS R410A

Cat.#	Model	H.P.	BTU	Volts/Ph	Price Ea.
A2C180	UG5T180INVF2	1-1/2	18,000	208-230/1	\$ 225.00
A2C200	UG5C200INXJ2	1-3/4	20,000	208-230/1	250.00
A2C220	UG5C220INWF2	1-7/8	22,000	208-230/1	265.00
A2C250	UG5C250INZJ2	2	25,000	208-230/1	265.00
A2C260	UG5C260INZF2	2-1/4	26,000	208-230/1	265.00
A2C290	UG5A290INZJ2	2-1/2	29,000	208-230/1	190.00
A2C320	UG5T320IUZF2	2-1/2	32,000	208-230/1	350.00

CARLYLE-CARRIER SCROLL R22 A/C COMPRESSORS

Cat.#	Model	H.P.	BTU	Volts/Ph	Price Ea.
F13XCH34	XCH342HA01	3	34,000	460/3/60	\$ 395.00
F13SRH45	SRH452HC01	4	45,000	460/3/60	425.00
F13SRH48	SRH482AC01	4	48,000	460/3/60	450.00
F13XRH54	SRH542HA01	4-1/2	54,000	460/3/60	495.00

Member of The
Chicagoand Chamber
of Commerce

COLDPARTS, INC.
4401 S. WESTERN BLVD. CHICAGO, IL 60609

PHONE (773) 247-8842 (800) 445-1281 FAX (773) 247-8742
www.coldparts.com E-Mail: info@coldparts.com



ORDERING INFORMATION & COMPRESSOR GUARANTEE

TERMS

15% RESTOCKING FEE ON ALL RETURNS

We accept certified checks and money orders for payments. Also UPS COD payment by certified check and money order only. Open account terms are Net 10 Days, only if credit has been established.

PRICES

Prices in this catalog supersede all previous issues and flyers. This catalog is valuable, it is full of \$\$\$ Savings Values. Save your customer money and increase your profit. You can beat inflation and higher prices when you "Cool-It" with Coldparts.

GUARANTEE

All merchandise in this catalog is sold on our policy of your complete satisfaction or your money back.

COMPRESSOR WARRANTY

All other compressors in this catalog are out of manufacturers warranty and carry Coldparts warranty. Coldparts guarantees that all compressors that are out of manufacturers warranty, will run when installed in a clean dry system, and correct electrical components are used.

90 day warranty from date of purchase

Coldparts will not replace compressors due to motor burnout, ground compressor windings or broken suction valves due to liquid slugging on compressor low side.

SHIPPING INFORMATION

All merchandise sold in this catalog and flyers is sold F.O.B. Chicago, Illinois. Shipped Freight Collect.

DAMAGED & RETURNED MERCHANDISE

Coldparts assumes no responsibility for merchandise damaged during transit. Damaged claims should be made on the delivering carrier. No merchandise can be returned without written permission from Coldparts. 15% restocking fee on all returns.

PRICES ON SILVER ALLOY AND COPPER TUBING

Prices on silver alloys and copper tubing are based on world market price and are subject to change without notice.

EXPORT ORDERS

We are experienced in shipping export orders anywhere in the free world. "Pro-Forma" quotations via air express mail are free upon request. Also we will export pack your order at no extra charge. All payments must be made in U.S. Dollars.

WHOLESALE ONLY

We sell wholesale to contractors, appliance repair, and companies related to our industry. Possession of this catalog does not obligate us to accept an order nor does it constitute an offer to sell.

USE OUR TOLL FREE NUMBER 1-800-445-1281

To place your order, get information, or to request a quote, just ask for our telephone order department. One of the friendly people there will be glad to help you in any way possible.

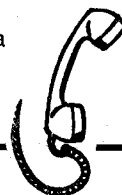

***** **QUICK REFERENCE INDEX** *****

Surplus Close Out Bargains, Page 1 to 37- Page 38 to 54 List Regular Line Mfgs. Items.

A		G	
Apoxil	46	Gas furnaces	53
Air cond. evaporators	52	Gauges, refrigeration	40
Air conditioners, Central Units	52		
"A" Coils, Evaporator	54	H	
Air Conditioners 13 SEER	53	Harris Silver Solder	51
		Harris Dyna-Flow Solder	51
B		Heat Seal Stick	51
BC Cap Tube Kits	39	Harris Flux	51
C		I	
Capacitor, motor start, motor run	41		
Charging manifold, refg.	40		49
Charging hose, refg.	40		49
			49
Capillary tubing	39		
		L	
Condenser, water cooled	48	Leak Finder foam	46
Copper fittings	45	Liquid indicators	52
Copper tube	45	Low pressure controls	17
		Leak detector	46
Condenser fan motors	12,22,28,33,34,37,43	M	
Contactors, magnetic	34, 42	Motor, evaporator commercial	49
D		Motor, evaporator domestic	47, 49
Defrost timers, domestic		Motor, condenser fan	23
Defrost switches, Termination	43	Mirrors, Inspection	42
Dryers, liquid, suction line	39	Motors, A/C Blower	41
E		O	
Evap fan motors, commercial	49		40
Evaporators, commercial	38	Oil, Polyester, Emkarate	40
Evaporator fan motors domestic	47, 49	Overloads	17,31,34
F		R	
Liquid dehydrant, Thawzone	46	Refrigerant water cooled cond.	48
Fan blades	47		
Fittings, brass, copper	45	Relays:	
Furnace, gas	53	Mars potential	17, 42
Full Gage Controls	49	Current G.E.	10,17,31,34,41
		Relay power packs, start caps.	44
		Solid state relays, overloads	31,44,49



ABOUT OUR PRICES

Prices on parts that carry the manufactures warranty are subject to change with out notice. Because of todays rapid inflation rate prices may change between catalogs. When suppliers increase prices to us, we must increase prices to you. If prices go down, we will charge you the lower price. This does not apply to bargain priced merchandise. Usually we try to hold the low price of the item until it is sold out. So look very carefully at our surplus bargain merchandise to save money and increase your profits.

We accept VISA, MASTER, DISCOVER, AMEX CARDS

S		
Super 88, oil adative	46	
Sight glass,	39	
Screws	34	
Solder, silver brazing	51	
Soldering fluxes	51	
Solder, 50/50, 95/5	51	
Solder, Stay-Brite	51	
Solder, Aluminum flux	51	
T		
Thermostats, heating	35,36	
Thawzone , liquid dehydrant	46	
Trace, leak detector	46	
Temperature control	10, 31,32, 45,47,49,50	
Transformers, 24V	42	
Time delay relay	31	
Thermometers	42	
Tools:		
Swaging tools	49	
Swaging tool, multi-size	49	
Tube cutters	48	
Vise-Grips	48	
Flaring tool	48	



HOURS
(Central Standard Time)
Monday - Friday 8 AM to 5 PM
Saturday: 9 AM to 1:00 PM

V	
Vacuum pumps	49
Vacuum pump oil	40
Vacuum hose	40
Access valves	46
Bullet piercing valves	46
Valve core tool	43
Vibration absorbers	45
W	
Water cooled condensers, Standard	48

DANFOSS-SECOP COMPRESSOR
MODEL TL2.5G 1/12HP 15V R134A
 250 BTU@-10F LOW TEMP-LST FOR
 CAP TUBE WITH ELECTRICAL AND POE OIL
CAT.# F93TL25 \$89.00 each

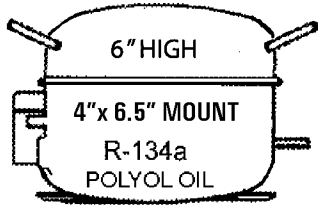

ASPERA MODEL B5128A
 1/8HP 115V R12/R134A
 H-MBP LST FOR CAP TUBE
 WITH ELECTRICAL AND POE OIL
CAT.# A1C5128 \$65.00 each

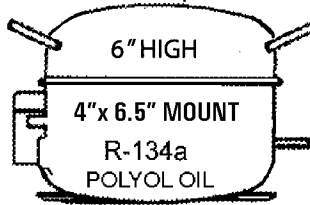

DANFOSS-SECOP COMPRESSOR
MODEL TLS4.5F 1/8HP 115V R134A
 400 btu@-10F LOW TEMP-LST FOR
 CAP TUBE WITH ELECTRICAL AND POE OIL
CAT.# F93TL45 \$110.00 each

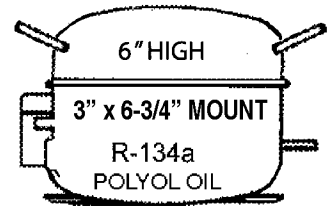

SAMSUNG COMPRESSOR
MODEL ML50CIY
 1/6HP 115V R134A LOW TEMP
 550 BTU@-10F LOW TORQUE FOR CAP TUBE
 WITH ELECTRICAL AND POE OIL
 SWEAT CONNECTIONS 4" x 6.5" MOUNT
CAT.# F10ML50 \$99.00 each

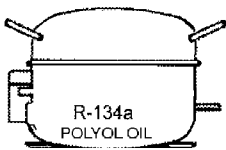

DANFOSS-SECOP COMPRESSOR
MODEL NTY5.5FK 1/5HP 115V R134A
 700 btu@-10F LOW TEMP FOR
 CAP TUBE WITH ELECTRICAL & POE OIL
CAT.# A1CNTY55 \$135.00 each

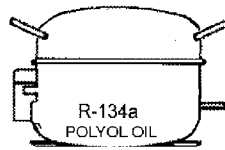

DANFOSS-SECOP COMPRESSOR
MODEL TF4CLX 1/5HP 115V R404A
 LBP-776 btu HBP-2632 btu HST FOR CAP
 TUBE OR TXV WITH ELECTRICAL & POE OIL
CAT.# A1CTL4CLX \$135.00 each

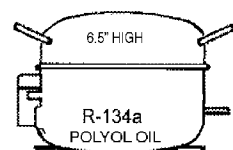

DANFOSS-SECOP COMPRESSOR
MODEL NF5.5FX 1/5HP 115V R134A
 LBP-695 btu HBP 2500 btu HST FOR CAP
 TUBE OR TXV WITH ELECTRICAL & POE OIL
CAT.# A1CNF55 \$145.00 each

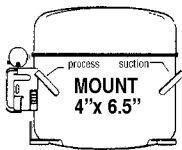

DANFOSS-SECOP COMPRESSOR
MODEL NF6.1FX 1/5HP 115V R134A
 LBP-721 btu HBP-3065 btu HST FOR CAP
 TUBE OR TXV WITH ELECTRICAL & POE OIL
CAT.# A1CNF61 \$145.00 each

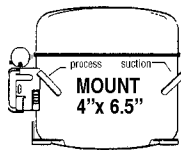

DANFOSS-SECOP COMPRESSOR
MODEL TFS4.5CLX 1/4HP 115V R404A
 LBP-921 BTU HBP- 3400 BTU HST FOR CAP
 TUBE OR TXV WITH ELECTRICAL & POE OIL
CAT.# A1CTFS45CLX \$155.00 each

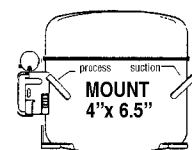

DANFOSS-SECOP COMPRESSOR
MODEL NF6FK 1/5HP 115V R134A
 LBP-670 BTU HBP 2600 BTU LST FOR CAP
 TUBE WITH ELECTRICAL & POE OIL
CAT.# A1CNF6 \$135.00 each

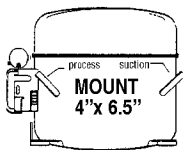

DANFOSS-SECOP COMPRESSOR
MODEL FF8.5GX 1/4HP 115V R134A
 3217 btU@45 F HBP-HST FOR CAP
 TUBE OR TXV WITH ELECTRICAL & POE OIL
CAT.# A1CFF85 \$155.00 each

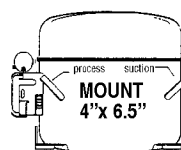

EMBRACO MODEL PW5.5K14
 1/6HP 115V R12/R134A L-MBP
 LST FOR CAP TUBE WITH
 ELECTRICAL AND POE OIL
CAT.# A1CPW55 \$115.00 each

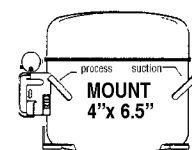

DANFOSS-SECOP COMPRESSOR
MODEL NF9FX +1/4HP 115V R134A
 3261 btu@45F HBP-HST FOR CAP
 TUBE OR TXV WITH ELECTRICAL & POE OIL
CAT.# A1CNF9 \$165.00 each

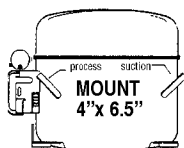

DANFOSS-SECOP COMPRESSOR
MODEL NF10FX +1/4HP 115V R134A
 LBP-1046 btu HBP-3756 btu HST FOR CAP
 TUBE OR TXV WITH ELECTRICAL & POE OIL
CAT.# A1CNF10 \$175.00 each

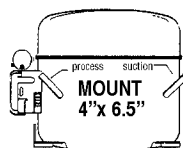

DANFOSS-SECOP COMPRESSOR
MODEL NF11FX 1/3HP 115V R134A
 LBP-1100 btu HBP-4050 btu HST FOR CAP
 TUBE OR TX WITH ELECTRICAL & POE OIL
CAT.# A1CNF11 \$185.00 each

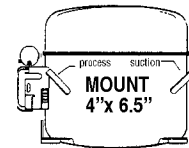

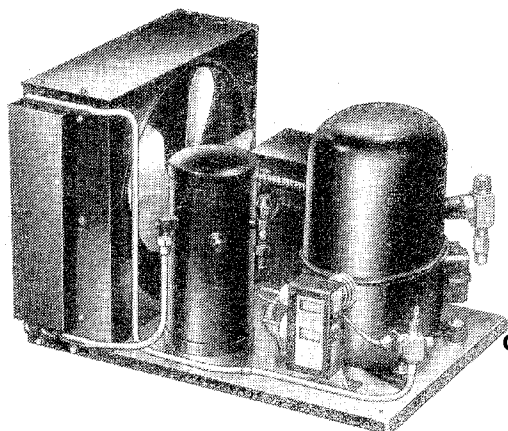

**AIR COOLED REFRIGERATION
CONDENSING UNITS 230 VOLT 1/PH 60 HZ
HIGH STARTING TORQUE FOR EXPANSION VALVE**

Efficient smooth running units consists of a hermetic compressor, condenser and motor assembly, mounted on heavy steel galvanized base. Complete with suction side service and liquid receiver tank and dual pressure control. (1 HP & 3/4 HP units have low pressure control) All starting components wired and mounted. Units available in 3-Phase. Call for 3- Phase prices.

CAT.# OUTDOOR1- \$200.00 ea. FAN CONTROL & CRANKCASE HEATER INSTALLED

ORDER UNITS FOR MEDIUM TEMP R-12 or MEDIUM TEMP R-134a

Cat.#	HP	Volts/Hz/Ph	Refrigerant	Price ea.
A1C55	3/4	115/60/1	12 or R-134a	\$ 1095.00
A1C871	3/4	230/60/1	12 or R-134a	\$ 1095.00
A1C903	1	230/60/1	12 or R-134a	\$ 1250.00
A1C861	1-1/2	230/60/1	12 or R-134a	\$ 1895.00
A1C862	2	230/60/1	12 or R-134a	\$ 1995.00
A1C863	3	230/60/1	12 or R-134a	\$ 2995.00

LOW TEMPERATURE REFRIGERANT R-404a UNITS

A1C988	3/4	230/60/1	404a	\$ 1095.00
A1C989	1	230/60/1	404a	\$ 1250.00
A1C990	1-1/2	230/60/1	404a	\$ 1895.00
A1C991	2	230/60/1	404a	\$ 1995.00
A1C992	3	230/60/1	404a	\$ 3395.00

MEDIUM TEMPERATURE R-22 - R-404a UNITS

A1C1002	3/4	115/60/1	22 or 404a	\$ 1095.00
A1C902	3/4	230/60/1	22 or 404a	\$ 1095.00
A1C904	1	230/60/1	22 or 404a	\$ 1250.00
A1C905	1-1/2	230/60/1	22 or 404a	\$ 1895.00
A1C906	2	230/60/1	22 or 404a	\$ 1995.00
A1C907	3	230/60/1	22 or 404a	\$ 2995.00
A1C976	5	230/60/1	22 or 404a	\$ 3395.00
A1C977	5	230/60/3	22 or 404a	\$ 3395.00

**SECOPI 3/4HP MEDIUM TEMP
AIR COOLED CONDENSING UNIT
115/60/1 R404A**

Med back pressure
High Starting Torque For
expansion valve. Complete
with starting components,
receiver tank, suction side
service valve and low side
pressure control.

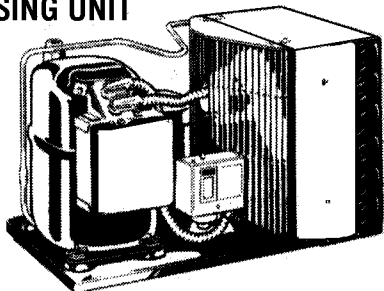

Cat.# A1C1002 \$ 1095.00 EACH

**1/2HP 115V R134A
MEDIUM TEMP CONDENSING UNIT**

Med back pressure R-134A
High Starting Torque For
expansion valve. Complete
with starting components,
receiver tank, suction side
service valve

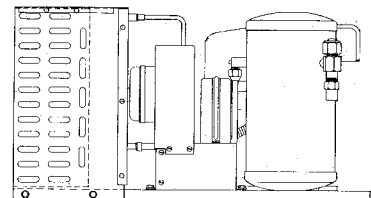

DIMENSIONS 11-1/4"H x 13-1/4"W x 18"D

CAT.# A1C54 \$625.00 EACH

MATSUSHITA MODEL S24C40KAU6
1/16HP 115V R134A LOW TEMP
 160BTU@-10F FOR CAP TUBE
 WITH ELECTRICAL & POE OIL
CAT.# F21S24 \$85.00 EACH

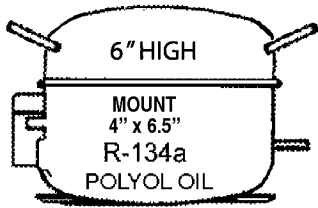

EMBRACO COMPRESSOR
MODEL VEGY6H
335 BTU TO 960 BTU R134A
 Variable capacity compressor
 WITH COVER AND POE OIL
NO INVERTER

CAT.# A1CVEGY6H
\$99.00 EACH

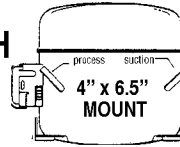

TECUMSEH MODEL AZA0335YXA
CAT.# F540335 \$85.00 each
 1/10HP 115V R134A 350btu@20F
 MED TEMP FOR CAP TUBE
 WITH RELAY, OVERLOAD, COVER AND
 POE OIL 4" x 6.5" MOUNT

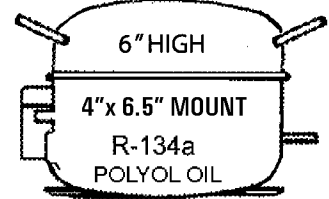

DANFOSS-SECOP COMPRESSOR
MODEL BD80F 1/4HP R134A DC
 INVERTER 12-24V COMPRESSOR ONLY
CAT.# A1CBD80 \$110.00 each

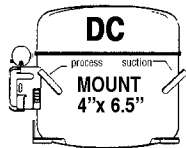

EMBRACO MODEL NE6210Z
1/3HP 230V R134A MEDIUM TEMP
 HST FOR TXV OR CAP TUBE
 WITH ELECTRICAL & POE OIL
CAT.# A1C6210Z2 \$155.00 each

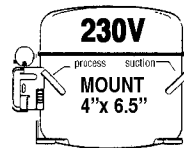

COPELAND MODEL RST55C1E-CAB
3/4HP 230V R404A L-MBP
 HST FOR TXV OR CAP TUBE
 WITH ELECTRICAL & POE OIL
CAT# A1C55C1E2 \$425.00 each

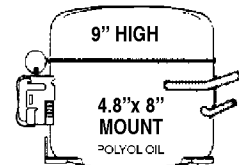

DANFOSS-SECOP COMPRESSOR
MODEL FR6G 1/5HP 230V R134A
 650 btu@-10F LOW TEMP FOR
 CAP TUBE WITH ELECTRICAL & POE OIL
CAT.# A1CFR6230 \$79.00 each

230V

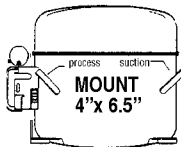

DANFOSS-SECOP COMPRESSOR
MODEL FR8.5G 1/4HP 230V R134A
 LBP-800 btu HBP-3000 btu HST FOR CAP
 TUBE OR TXV WITH ELECTRICAL & POE OIL
CAT.# A1CFR85230 \$99.00 each

230V

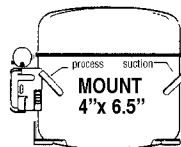

DANFOSS-SECOP COMPRESSOR
MODEL SC12G 1/3HP 230V R134A
 LBP-1200 btu HBP-4200 btu HST FOR CAP
 TUBE OR TXV WITH ELECTRICAL & POE OIL
CAT.# A1CSC12G230 \$175.00 each

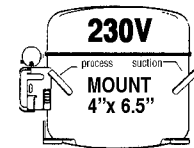

DANFOSS-SECOP COMPRESSOR
MODEL NF7MLX 1/3HP 230V R404A
 LBP-1409 btu HBP-5015 btu HST FOR CAP
 TUBE OR TXV WITH ELECTRICAL & POE OIL
CAT.# A1C7MLX230 \$185.00 each

230V

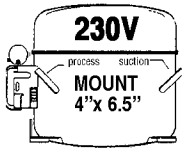

DANFOSS-SECOP COMPRESSOR
MODEL SC10CLX 1/3HP 230V R404A
 1586 btu@-10F LOW TEMP HST FOR CAP
 TUBE OR TXV WITH ELECTRICAL & POE OIL
CAT.# A1CSC10230V \$175.00 each

230V

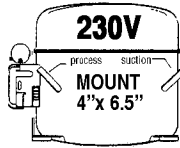

DANFOSS-SECOP COMPRESSOR
MODEL SC15G 1/2HP 230V R134A
 5500 btu@45F HST FOR CAP TUBE
 OR TXV WITH ELECTRICAL & POE OIL

CAT.# A1C15G230
\$325.00 each

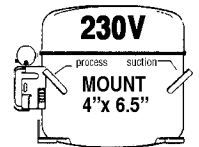

DANFOSS-SECOP COMPRESSOR
MODEL SC12CLX 1/2HP 230V R404A
 LBP-2000 btu HBP-7600 btu HST FOR CAP
 TUBE OR TXV WITH ELCTRICAL & POE OIL

CAT.#A1C12CLX230
\$295.00 each

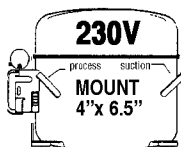

ASPERA COMPRESSOR
MODEL T6217Z-2
+1/2HP 230V R134A MED-HIGH TEMP
 7600 BTU @45F HIGH STARTING TORQUE
 WITH RELAY, OVERLOAD, START CAP, COVER
 AND POE OIL SWEAT OR 3/8" SUCTION VALVE
 SWEAT CONNECTION
CAT.# A1C6217Z2
\$325.00 EACH
 3/8" SUCTION VALVE
CAT.# A1C6217Z2V
\$350.00 EACH

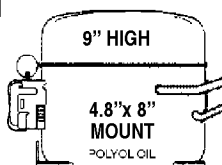

DANFOSS-SECOP COMPRESSOR
MODEL SC18MLX 3/4HP 230V R404A
 LBP-3000 btu HBP-9800 btu HST FOR CAP
 TUBE OR TXV WITH ELECTRICAL & POE OIL

CAT.# A1C18MLX230
\$400.00 each SWEAT
CAT.# A1C12MLX230V
\$425.00 each W/VALVE

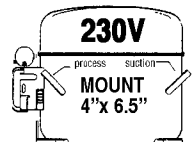

DANFOSS-SECOP COMPRESSOR
MODEL TL2.5G 230V R134A L-MBP
LOW TORQUE FOR CAP TUBE WITH
ELECTRICAL AND POE OIL
CAT.#A1CTL25230 \$85.00 each

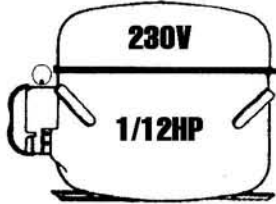

DANFOSS-SECOP COMPRESSOR
MODEL TL3G 230V R134A L-MBP
LOW TORQUE FOR CAP TUBE WITH
ELECTRICAL AND POE OIL
CAT.# A1CTL3230 \$85.00 each

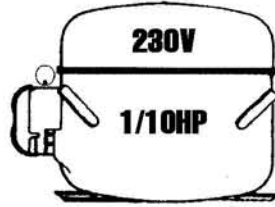

DANFOSS-SECOP COMPRESSOR
MODEL TL5G 230V R134A L-MBP
LOW TORQUE FOR CAP TUBE WITH
ELECTRICAL AND POE OIL
CAT.# A1CTL5230 \$75.00 each

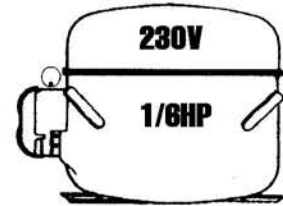

ASPERA MODEL NB6152E
CAT.# A1C6152E \$125.00 each
1/5 HP 115V R404a 2500 BTU@45°F
HIGH STARTING TORQUE MEDIUM TEMP
WITH RELAY, OVERLOAD, START CAP,
COVER AND MIN OIL CHARGE
4"x 6.5" MOUNTING 8" HIGH

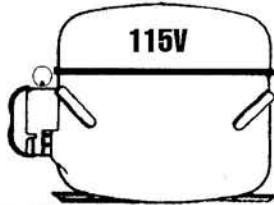

TECUMSEH MODEL AKA9427ZA
CAT.# F549427 \$250.00 each
+1/3 HP 115V R404A/R22 2700 BTU@20F
HIGH STARTING TORQUE MEDIUM TEMP
WITH ELECTRICAL AND POE OIL CHARGE
4.8" x 8" MOUNTING SWEAT CONNECTIONS

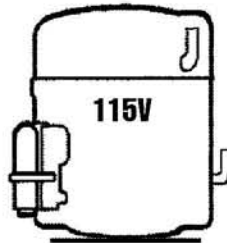

TECUMSEH MODEL AKA9427XD
CAT.# F549427D \$250.00 each
+1/3HP 230V R404A/R22 2700 BTU@20F
HIGH STARTING TORQUE MEDIUM TEMP
WITH ELECTRICAL AND POE OIL CHARGE
4.8" x 8" MOUNTING SWEAT CONNECTIONS

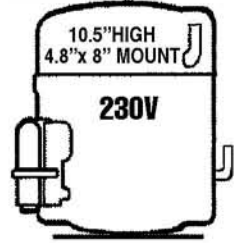

TECUMSEH MODEL HGA0440EXA
CAT.# F540440 \$295.00 each
1/2 HP 115V R22 4000 BTU@20F
NORMAL TORQUE MEDIUM TEMP
VERY LOW PROFILE WITH ELECTRICAL
AND A-B OIL CHARGE
7" HIGH

5" x 8"
Mounting Centers



TECUMSEH MODEL HGA9443YXA
CAT.# F544443YA \$325.00 each
1/2 HP 115V R134A 4300 BTU@20F
HIGH TORQUE MEDIUM TEMP
VERY LOW PROFILE WITH ELECTRICAL
AND POE OIL CHARGE
7" HIGH

5" x 8"
Mounting Centers



TECUMSEH MODEL HGA0470EXD
CAT.# F5404ED \$325.00 each
3/4 HP 230V R22 7000 BTU@20F
NORMAL TORQUE MEDIUM TEMP
VERY LOW PROFILE WITH ELECTRICAL
AND A-B OIL CHARGE
7" HIGH

5" x 8"
Mounting Centers



TECUMSEH MODEL HGA9468ZXD
CAT.# F54HG68 \$325.00 each
3/4 HP 230V R404A/R22 6800 BTU@20F
HIGH STARTING TORQUE MEDIUM TEMP
VERY LOW PROFILE WITH ELECTRICAL
AND POE OIL CHARGE
7" HIGH

5" x 8"
Mounting Centers

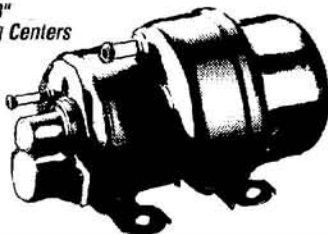

TECUMSEH MODEL HGA2434ZXA
CAT.# F54HG34 \$325.00 each
3/4 HP 115V R404A 3400 BTU@-10F
HIGH STARTING TORQUE LOW TEMP
VERY LOW PROFILE WITH ELECTRICAL
AND POE OIL CHARGE
7" HIGH

5" x 8"
Mounting Centers



DANFOSS-SECOP COMPRESSOR
NF10FX +1/4HP 115V R134A L-MBP
HIGH TORQUE FOR CAP TUBE OR TXV
WITH ELECTRICAL AND POE OIL
CAT.# A1CNF10 \$175.00 each

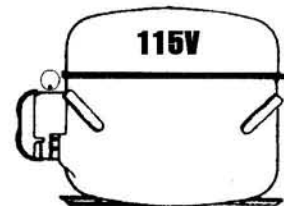

BRISTOL H22G-H92G COMPRESSORS FOR A/C AND HIGH TEMP APPLICATIONS

CAT.#	MODEL	HP	BTU	OIL	VOLTS/PH	PRICE
A1C094-4	H2NG094DPEE-S*	7.5	94,000	MINERAL	460/3/60	\$ 1095.00
A2CG094-4	H22G094DBEE-S*	7.5	94,000	MINERAL	460/3/60	1095.00
A2CG094-3	H92G094GPDE-R	7.5	94,000	POE	230/3/60	1095.00
A2CG104-4	H2BG104DBEE-R*	9	104,000	MINERAL	460/3/60	1195.00
A2CG124-3	H22G124DBDE-S*	10	120,000	POE	230/3/60	1295.00
A2CG144-4	H22G144DBEE-S*	12	144,000	MINERAL	460/3/60	1395.00
A2CG184-3	H92G184DPDF-S*	15	184,000	POE	230/3/60	1695.00
A2CG244-3	H92G244FRDF-R*	20	244,000	POE	230/3/60	1995.00
A2CG294-3	H22G294FPDF-S*	24	294,000	MINERAL	230/3/60	2095.00

S*- SWEAT CONNECTIONS

R*- ROTO LOCK CONNECTIONS SUCTION & HIGH SIDE VALVE SET EXTRA \$250.00

ALL COMPRESSORS THAT NEED MODLUS ARE INCLUDED

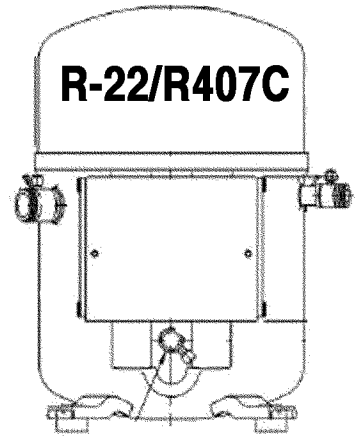

**BRISTOL A/C COMPRESSOR
MODEL T81J384BCA
3.25TON R410A 230/1/60
38,000 BTU R410A 7.5" x 7.5" MOUNT
POE OIL**

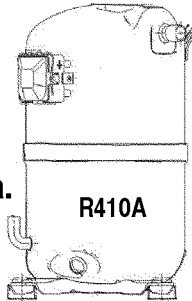

**CAT.# F13T81J38
COST \$450.00 ea.**

**BRISTOL A/C COMPRESSOR
MODEL T89A515BBCA
4.5TON R410A 230/1/60
51,000 BTU R410A 7.5" x 7.5" MOUNT
POE OIL**

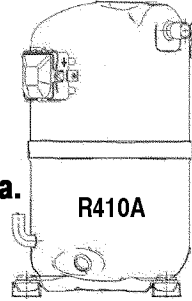

**CAT.# F13T89A51
COST \$595.00 ea.**

**BRISTOL A/C COMPRESSOR
MODEL H82J483ABCA
4TON R410A 230/1/60
48,000 BTU**

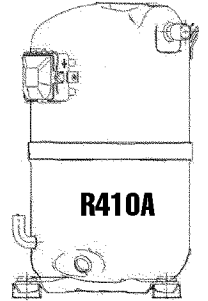

**CAT.# A2CH82J48
COST \$425.00 ea.**

**LG SCROLL MODEL SQA022KAC
22,000 BTU R22 208-230/1/60
FOR A/C 7.5" x 7.5" MOUNT 16" HIGH
WITH MINERAL OIL 1/2" LIQUID-3/4" SUCTION**
CAT.# F13022SQ \$295.00 each

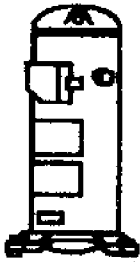

**LG SCROLL MODEL SQA026KAC
26,000 R22 208-230/1/60
FOR A/C 7.5" x 7.5" MOUNT 16 1/2" HIGH
WITH MINERAL OIL 1/2" LIQUID-3/4" SUCTION**
CAT.# F13026SQ \$325.00 each

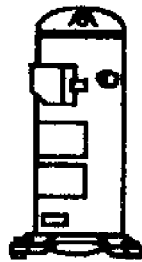

**LG SCROLL MODEL SQA032KAC
32,000 BTU R22 208-230/1/60
FOR A/C 7.5" x 7.5" MOUNT 17" HIGH
WITH MINERAL OIL 1/2" LIQUID SUCTION**
CAT.# F13032SQ \$350.00 each

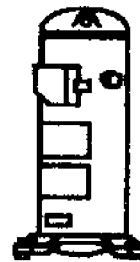

**LG SCROLL MODEL SQA038KAC
38,000 BTU R22 208-230/1/60
FOR A/C 7.5" x 7.5" MOUNT 17" HIGH**
CAT.# F13038SQ \$425.00 each

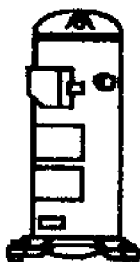

**LG SCROLL MODEL ABA051KAE
51,000 BTU R410A 208-230/1/60
FOR A/C 7.5" x 7.5" MOUNT 17" HIGH**
CAT.# F13051K1 \$495.00 each

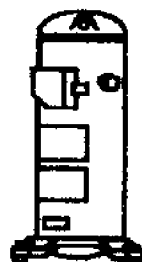

**SAMSUNG ROTARY COMPRESSOR
MODEL UG5A290INZJ2
29,000 BTU R410A 208-230/1/60
FOR A/C 6" TRIANGLE MOUNT 17" HIGH
WITH POE OIL AND COVER**
CAT.# A2C290 \$190.00 each

SPECIAL PRICING
10 LOT \$150.00
40 LOT \$125.00
120 LOT \$100.00

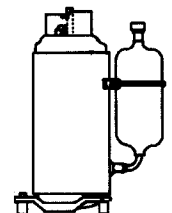

PANASONIC ROTARY COMPRESSORS FOR R410A MINI-SPLIT A/C'S DC FOR INVERTER SYSTEMS

A2C5KD24	5KD240XAC21	2	24,000	DC 280V	\$ 255.00
A2C5JD42	5JD420XAC22	3-1/2	42,000	DC 280V	295.00

**TOSHIBA ROTARY COMPRESSORS FOR R410A MINI-SPLIT A/C'S DC FOR INVERTER SYSTEMS
TWIN ROTOR BLDC STYLE COMPRESSORS**

F13DA150	DA150A1F-21F1	1-1/2	15,000	DC 171V 120 Hz	\$ 195.00
F13DA220	DA220A2F-23L	2	25,000	DC 200V 120 Hz	275.00
F13DA330	DA330A2F-20M	3	35,000	DC 197V 120 Hz	295.00
F13DA422	DA422A3F-26M	4	46,000	DC 173V 120 Hz	350.00

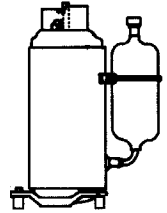

COPELAND MODEL CS12K1E-PFV
1.5HP 230/1/60 R404A L-MBP
WITH ELECTRICAL BOX, 7/8"
SUCTION VALVE & POE OIL
CAT.# A1CS12V \$625.00 each

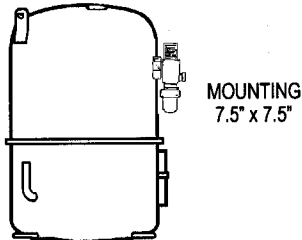

COPELAND MODEL CS16K6E-PFV
2.5HP 230/1/60 R404A L-MBP HST
WITH ELECTRICAL BOX, 7/8"
SUCTION VALVE & POE OIL
CAT.# A1CS16V \$650.00 each

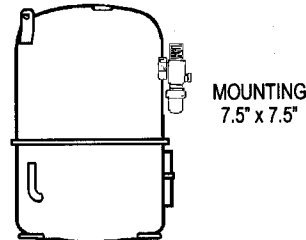

COPELAND MODEL ZB07KAE-PFV
CAT.# A1ZB07V \$ 550.00 each
+3/4HP 230/1/60 R404A MEDIUM TEMP
WITH ELECTRICAL, POE OIL AND 5/8"
SUCTION VALVE
7500 btu@20F MED TEMP



TECUMSEH MODEL AHA2445AXF
CAT.# F542445F \$ 425.00 each
1 HP 230/3/60 R134A/R12 LOW TEMP
HIGH STARTING TORQUE FOR EXPANSION VALVE
SYSTEMS 3 PHASE. WITH POE OIL CHARGE
AND 7/8" SUCTION ROTO LOCK VALVE

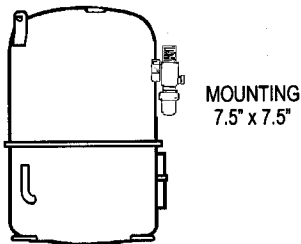

COPELAND MODEL ZB08KAE-PFV
CAT.# A1ZB08V \$ 595.00 each
1HP 230/1/60 R404A MEDIUM TEMP
WITH ELECTRICAL, POE OIL AND 5/8"
SUCTION VALVE
8200 btu@20F MED TEMP

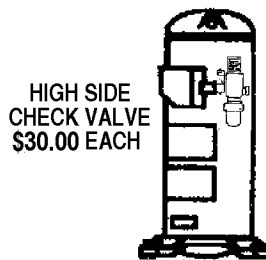

COPELAND MODEL ZB13KCE-PFV
CAT.# A1ZB13V \$ 625.00 each
1.5HP 230/1/60 R404A MEDIUM TEMP
WITH ELECTRICAL, POE OIL AND 7/8"
SUCTION VALVE
13,000 btU@20F MED TEMP

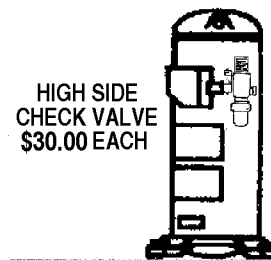

COPELAND MODEL ZB15KCE-PFV
CAT.# A1ZB15V \$ 650.00 each
2HP 230/1/60 R404A MEDIUM TEMP
WITH ELECTRICAL, POE OIL AND 7/8"
SUCTION VALVE
15,000 btu@20F MED TEMP

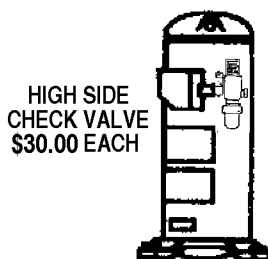

COPELAND MODEL ZB19KCE-PFV
CAT.# A1ZB19V \$ 675.00 each
2.5HP 230/1/60 R404A MEDIUM TEMP
WITH ELECTRICAL, POE OL AND 7/8"
SUCTION VALVE
18,600 btu@20F MED TEMP

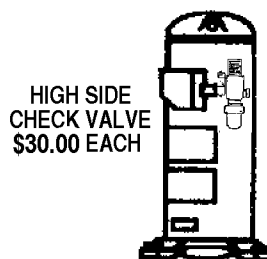

COPELAND MODEL ZB21KCE-PFV
CAT.# A1ZB21V \$725.00 each
3HP 230/1/60 R404A MEDIUM TEMP
WITH ELECTRICAL, POE OIL AND 7/8"
SUCTION VALVE
22,200 btu@20F MED TEMP

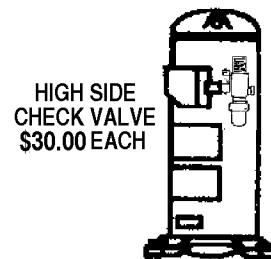

COPELAND MODEL ASE12C3E-IAA
 1/6HP 115V R404A L-MBP HST
 FOR TXV OR CAP TUBE
 1280 btu@20F WITH
 ELECTRICAL AND POE OIL
CAT.# A1C12C3E \$135.00 each

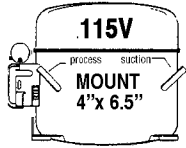

COPELAND MODEL ASE24C5E-IAA
 1/3HP 115V R404A L-MBP HST
 FOR TXV OR CAP TUBE
 2400 btU@20F WITH
 ELECTRICAL AND POE OIL
CAT.# A1C24C5E \$185.00 each

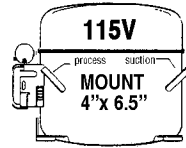

COPELAND MODEL RST40C1E-CAA
 1/2HP 115V R404A L-MBP HST
 FOR TXV OR CAP TUBE
 4000 btu@20F WITH
 ELECTRICAL AND POE OIL
A1C40C5E \$375.00 each

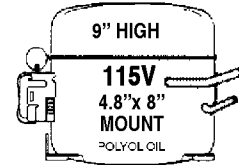

Embraco Model VEGY6H
 Cat.# A1CVEGY6H \$99.00 each
 Variable capacity compressor
 Compressor only POE oil charge
 335 btu to 960 btu 115v
 NO INVERTER

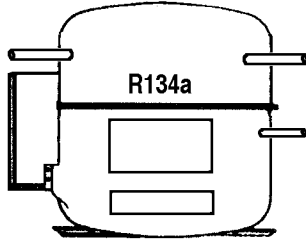

EMBRACO MODEL NE6210Z
 1/3HP 230V R134A MEDIUM TEMP
 HST FOR TXV OR CAP TUBE
 WITH ELECTRICAL & POE OIL
CAT.# A1C6210Z2 \$155.00 each

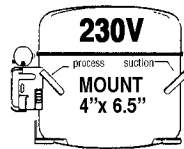

COPELAND MODEL RST55C1E-CAB
 3/4HP 230V R404A L-MBP
 HST FOR TXV OR CAP TUBE
 WITH ELECTRICAL & POE OIL
CAT# A1C55C1E2 \$425.00 each

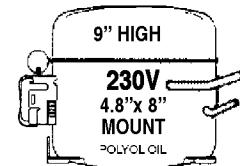

DANFOSS-SECOP COMPRESSOR
 MODEL NF7MLX 1/3HP 230V R404A
 LBP-1409 btu HBP-5015 btu HST FOR CAP
 TUBE OR TXV WITH ELECTRICAL & POE OIL
CAT.# A1C7MLX230 \$165.00 each

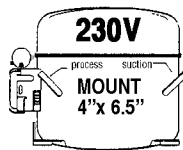

DANFOSS-SECOP COMPRESSOR
 MODEL SC10CLX 1/3HP 230V R404A
 1586 btu@-10F LOW TEMP HST FOR CAP
 TUBE OR TXV WITH ELECTRICAL & POE OIL
CAT.# A1CSC10230V \$175.00 each

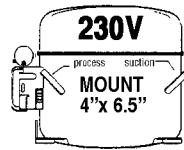

DANFOSS-SECOP COMPRESSOR
 MODEL SC12G 1/3HP 230V R134A
 LBP-1200 btu HBP-4200 btu HST FOR CAP
 TUBE OR TXV WITH ELECTRICAL & POE OIL
CAT.# A1CSC12G230 \$175.00 each

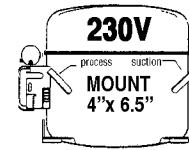

DANFOSS-SECOP COMPRESSOR
 MODEL SC12CLX 1/2HP 230V R404A
 LBP-2000 btu HBP-7600 btu HST FOR CAP
 TUBE OR TXV WITH ELCTRICAL & POE OIL

**CAT.#A1C12CLX230
 \$295.00 each**

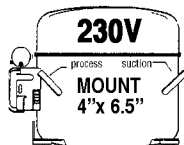

DANFOSS-SECOP COMPRESSOR
 MODEL SC15G 1/2HP 230V R134A
 5500 btu@ 45F HST FOR CAP TUBE
 OR TXV WITH ELECTRICAL & POE OIL

**CAT.# A1C12G230
 \$325.00 each**

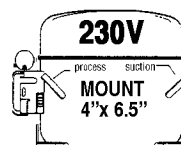

DANFOSS-SECOP COMPRESSOR
 MODEL SC18MLX 3/4HP 230V R404A
 LBP-3000 btu HBP-9800 btu HST FOR CAP
 TUBE OR TXV WITH ELECTRICAL & POE OIL

**CAT.# A1C18MLX230
 \$400.00 each SWEAT
 CAT.# A1C12MLX230V
 \$425.00 each W/VALVE**

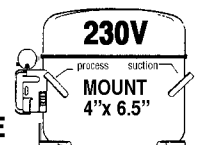

RANCO STYLE BEVERAGE WATER COOLER CONTROL TYPE K50-P1127 WITH DIAL FACE PLATE AND KNOB



BUY 6 ASSORTED GET 1 FREE

Type K50 replaces type "A" controls. Complete with Dial face plate and dial knob. Positive OFF position. Capillary 42" long, 2-1/8" mounting hole centers. Spade push-connections.

Cold-Out +35F Warm-In +54F
Cold-In +41F EACH

Cat.# A1981 K50-P1127 \$15.95

RANCO STYLE REFRIGERATOR CONTROL TYPE K50-P1125 WITH DIAL FACE PLATE AND KNOB

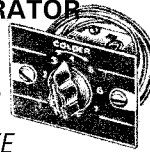

BUY 6 ASSORTED GET 1 FREE

Type K50 replaces type "A" controls. Complete with Dial face plate and dial knob. Positive OFF position. Capillary 42" long, 2-1/8" mounting hole centers. Spade push-connections.

Cold-Out 0F Warm-In +47F
Cold-In +15F EACH

Cat.# A1979 K50-P1125 \$15.95

RANCO STYLE FREEZER CONTROL TYPE K50-P1126 WITH DIAL FACE PLATE AND KNOB



BUY 6 ASSORTED GET 1 FREE

Type K50 replaces type "A" controls. Complete with Dial face plate and dial knob. Positive OFF position. Capillary 42" long, 2-1/8" mounting hole centers. Spade push-connections.

Cold-Out -12F Warm-In +15F
Cold-In 0F EACH

Cat.# A1980 K50-P1126 \$15.95

DANFOSS-SECOP COMPRESSOR MODEL SC12MLX 1/2HP 115V R404A LBP-2000 btu HBP- 7600 btu HST FOR CAP TUBE OR TXV WITH ELECTRICAL & POE OIL

CAT.# A1C12MLX
\$325.00 each SWEAT

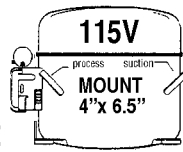

CAT.# A1C12MLXV
\$360.00 each W/VALVE

DANFOSS-SECOP COMPRESSOR MODEL SC15MLX 3/4HP 115V R404A HST FOR CAP TUBE OR TXV WITH ELECTRICAL & POE OIL

CAT.# A1C15MLX
\$360.00 each SWEAT

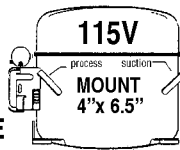

CAT.# A1C15MLXV
\$395.00 each W/VALVE

DANFOSS-SECOP COMPRESSOR MODEL SC18G 1/2HP 115V R134A 6600 btU@45F HST MEDIUM TEMP FOR CAP TUBE OR TXV WITH ELECTRICAL

CAT.# A1C18G
\$375.00 each SWEAT

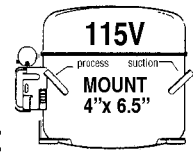

CAT.#
\$410.00 each W/VALVE

DANFOSS-SECOP COMPRESSOR MODEL SC12CLX 1/2HP 230V R404A LBP-2000 btu HBP-7600 btu HST FOR CAP TUBE OR TXV WITH ELECTRICAL & POE OIL

CAT.# A1C12CLX230
\$295.00 each SWEAT

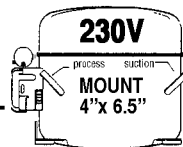

DANFOSS-SECOP COMPRESSOR MODEL SC18MLX 3/4HP 230V R404A LBP-3000 btu HBP-10,000 btu HST FOR CAP TUBE OR TXV WITH ELECTRICAL & POE OIL

CAT.# A1C18MLX230
\$400.00 each SWEAT

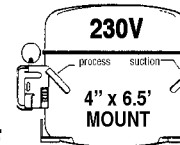

CAT.# A1C18MLX230V
\$435.00 each W/VALVE

DANFOSS-SECOP COMPRESSOR MODEL SC15G 1/2HP 230V R134A 5500 btu @45F HST FOR CAP TUBE OR TXV WITH ELECTRICAL & POE OIL

CAT.# A1C15G230
\$325.00 each

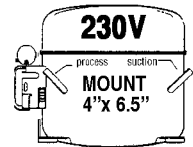

LIMITED QUANTITY ORIGINAL O.E.M. REPLACEMENT COMPRESSORS

Cat. # MFG. Model/Refg. H.P. Application Style Price Ea.

F9818	Kelvinator	AO56 2/hole mt.	1/5	LBP/R-12	A	\$ 35.00
F9804	Aspera	E7195E AK/plate mt.	5,000 btu	A/C R-22	F	ea.
F9819	Westinghouse	TL-56 3/hole mt.	1/5	LBP/R-12	H	

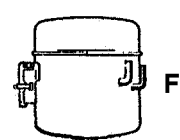

TECUMSEH ROTARY COMPRESSOR 9000 BTU 208/230/60/1

For refrigerant-22 with electrical cover and oil charge. overload protection.
Tri-angle mount. Air conditioning, Mini-Split and Heat pump application.

RKA5490EXD

CAT.# F545490D \$149.00 EACH



DANFOSS-SECOP COMPRESSOR MODEL NF10FX +1/4HP 115V R134A LBP-1046 btu HBP-3756 btu HST FOR CAP TUBE OR TXV WITH ELECTRICAL & POE OIL

CAT.# A1CNF10 \$175.00 each

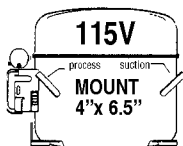

RELAY-OVERLOAD-START CAPACITOR HI-TORQUE COMPRESSOR START KIT

*1/3 HP 115V
* RELAY W/CAPACITOR CONNECTION

CAT.# F5416 \$19.95 ea. Kit

For models: AEA2410YXA-AXA, AEA2411ZXA, AEA4440YXA-AXA

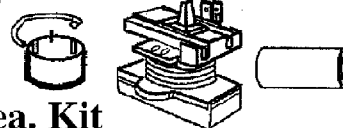

G.E. MOTOR RUN CAPACITOR-ROUND BODY
Cat. No. A1945
35 MFD x 370V
\$9.95 ea.

G.E. CURRENT RELAY

3ARR2-KCP172S
1/2 HP-3/4 HP 115V
Cat.# A1CKCP172 \$14.95 each

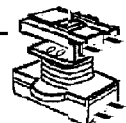

FRACTIONAL HORSEPOWER AIR COOLED CONDENSING UNITS

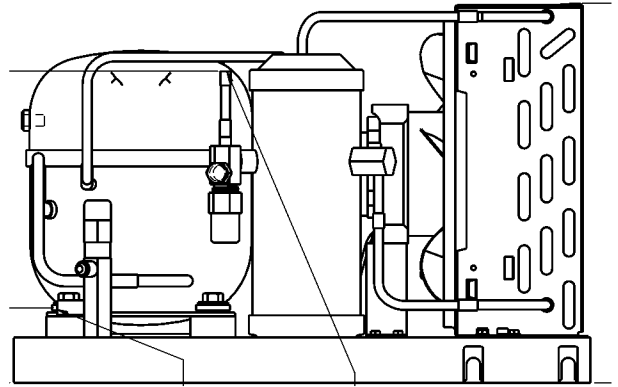

CAT.#	HP	TEMPERATURE	RECEIVER TANK	VOLTS/PH	PRICE
A2U981	1/8	L-MEDIUM/LST/R134A	NO	115/1/60	\$ 235.00
A1C981	1/5	L-MEDIUM/LST/R134A	NO	115/1/60	275.00
A1U0022	1/5	MEDIUM/HST/R404A	YES	115/1/60	325.00
A1U2480Z	1/4	L-MEDIUM/HST/R404A	YES	115/1/60	385.00
A1C936	1/4	MEDIUM/HST/R134A	NO	115/1/60	375.00
A1C71	1/4	MEDIUM/HST/R134A	YES	115/1/60	385.00
A1U800	1/4	L-MEDIUM/HST/R134A	YES	230/1/60	385.00
A1C933	1/3	MEDIUM/HST/R134A	YES	115/1/60	395.00
A1C938	1/3	L-MEDIUM/HST/R404A	YES	115/1/60	395.00
A1U801	1/3	L-MEDIUM/HST/R404A	YES	230/1/60	395.00
A1U802	1/3	L-MEDIUM/HST/R134A	YES	230/1/60	395.00
F54U2413Y	1/3	LOW/HST/R134A	NO	115/1/60	395.00
A1U9427Z	1/2	MEDIUM/HST/R404A	YES	115/1/60	595.00
A1U0440	1/2	MEDIUM/HST/R404A	YES	115/1/60	595.00
A1C54	1/2	MEDIUM/HST/R134A	YES	115/1/60	625.00
A1C54230	1/2	MEDIUM/HST/R134A	YES	230/1/60	625.00

DANFOSS MODEL NF11FX
CAT.# A1CNF11 \$185.00 each
 1/3HP 115V R134A MEDIUM TEMP
 HIGH TORQUE WITH ELECTRICAL AND
 POE OIL 4" x 6.5" MOUNT
 SWEAT CONNECTIONS

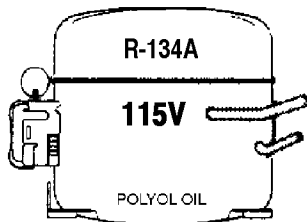

DANFOSS-SECOP COMPRESSOR
MODEL NF7MLX 1/3HP 230V
 R404A L-MBP HST FOR CAP
 TUBE OR TXV WITH
 ELECTRICAL & POE OIL
CAT.#A1C7MLX230 \$185.00 ea.

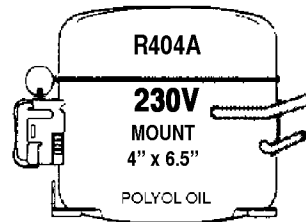

DANFOSS-SECOP COMPRESSOR
MODEL NF7CLX 1/3HP 115V R404A
 LBP-1543 btu HBP-4609 btu HST FOR CAP
 TUBE OR TXV WITH ELECTRICAL & POE OIL
CAT.# A1CNF7CLX \$185.00 each

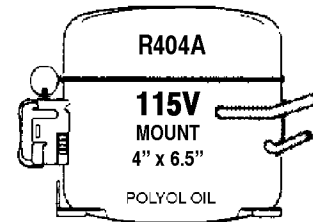

TECUMSEH MODEL HGA9468ZXD
CAT.# F54HG68 \$325.00 each
 3/4 HP 230V R404A/R22 6800 BTU@20F
 HIGH STARTING TORQUE MEDIUM TEMP
 VERY LOW PROFILE WITH ELECTRICAL
 AND POE OIL CHARGE
HORIZONTAL ROTARY COMPRESSOR

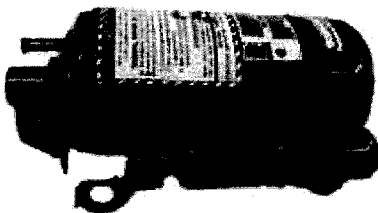

TECUMSEH MODEL HGA2434ZXA
CAT.# F54HG34 \$325.00 each
 3/4 HP 115V R404A 3400 BTU@-10F
 HIGH STARTING TORQUE LOW TEMP
 VERY LOW PROFILE WITH ELECTRICAL
 AND POE OIL CHARGE
HORIZONTAL ROTARY COMPRESSOR

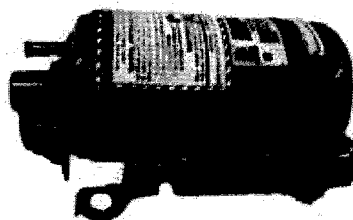

TECUMSEH MODEL HGA9443YXA
CAT.# F544443YA \$325.00 each
 1/2 HP 115V R134A 4300 BTU@20F
 HIGH TORQUE MEDIUM TEMP
 VERY LOW PROFILE WITH ELECTRICAL
 AND POE OIL CHARGE
HORIZONTAL ROTARY COMPRESSOR

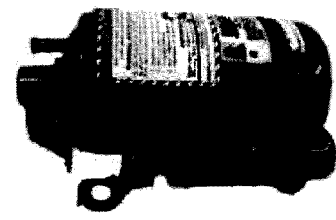

SAMSUNG ROTARY COMPRESSOR

MODEL UG5A290INZJ2

29,000 BTU R410A 208-230/1/60

FOR A/C 6" TRIANGLE MOUNT 17" HIGH
WITH POE OIL AND COVER

CAT.# A2C290 \$190.00 each

SPECIAL PRICING

10 LOT \$150.00

40 LOT \$125.00

120 LOT \$100.00

**CAN REPLACE ANY SCROLL, PISTON
OR ROTARY COMPRESSOR 2-1/2 TON R410A
IN A/C SYSTEMS. USED BY
CARRIER-NORTEK-GOODMAN**

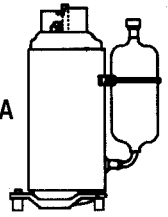

**EVAPORATOR REPLACEMENT MOTOR FOR HEATCRAFT-BOHN-CHANDLER-
LARKIN-CLIMATE CONTROL. SLEEVE BEARING 1/15 HP-3" LONG SHAFT**

Replacement for walk-in cooler evaporator fans. - Low Amp Draw Motor-
Low Temp Lub System- Frame 3.3" UL Class B Insulation- 40°C Amb.
1 Speed-1550 RPM- 5/16" Shaft X 3" Long.

CW ROTATION
FACEING SHAFT

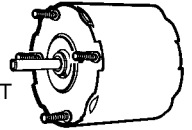

Cat.# 41124 PACKARD 1/15 HP 115V \$79.00 each

Cat.# 41126 PACKARD 1/15 HP 230V \$79.00 each

**AIR COOLED CONDESNING UNIT 3/4HP
R404A MEDIUM TEMP 230/1/60**

7000 BTU@20 F EVAP TEMP WITH COPELAND
SCOLL ZB07KAE-PFV, LP CONTROL AND
RECEIVER TANK-17"H x 15-1/4"W x 22"D

**CAT.# A1C902
\$1095.00 each**

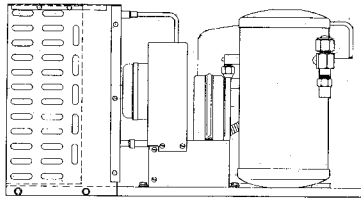

**AIR COOLED CONDESNING UNIT 1HP
R404A MEDIUM TEMP 230/1/60**

8000 BTU@20 F EVAP TEMP WITH COPELAND
SCOLL ZB08KAE-PFV, LP CONTROL AND
RECEIVER TANK-17"H x 19-1/4"W x 23"D

**CAT.# A1C904
\$1250.00 each**

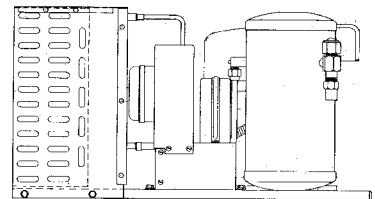

**COPELAND AIR COOLED CONDESNING UNIT
M2FH0056-IAV 1/2 HP 230V R134A MBP
4140 BTU @20F MEDIUM TEMP HIGH TORQUE
UNIT WITH RECEIVER TANK, HIGH AND
LOW SIDE VALVES**

**CAT.# A1U0056-2
\$625.00 each**

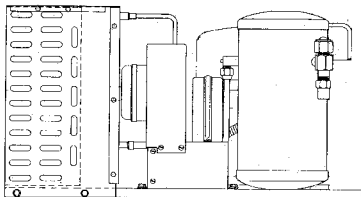

**COPELAND AIR COOLED CONDESNING UNIT
M7PH-H031-CAA-121 1/3HP 115V R134A
MBP HST W RECEIVER TANK, SWEAT LINES
AND CONDENSATE BASE PAN.
11"W x 10.5" H x 20"L**

**CAT.#A1UH031CAA
\$395.00 each**

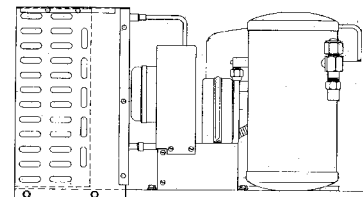

CONDENSING UNIT

**1/2HP 115V R404A LOW TEMP 2200btu@-10F
HIGH TORQUE FOR EXPANSION VALVE OR CAP TUBE
WITH RECEIVER TANK, 1/4" HIGH SIDE AND 1/2"
LOW SIDE SERVICE VALVES**

CAT.# A1U12CLX \$625.00 each

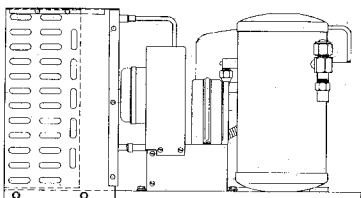

**SECOP 3/4HP MEDIUM TEMP
AIR COOLED CONDESNING UNIT
115/60/1 R404A**

Med back pressure
High Starting Torque For
expansion valve. Complete
with starting components,
receiver tank, suction side
service valve and low side
pressure control.

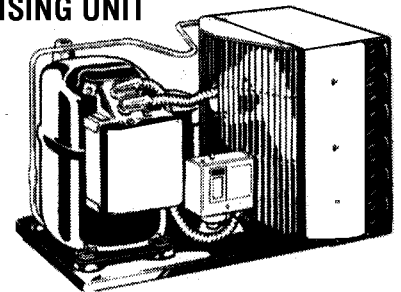

Cat.# A1C1002 \$1095.00 EACH

MATSUSHITA MODEL S24C40KAU6
1/16HP 115V R134A LOW TEMP
 160BTU@-10F FOR CAP TUBE
 WITH ELECTRICAL & POE OIL
CAT.# F21S24 \$65.00EACH

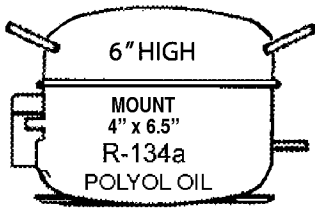

TECUMSEH MODEL AZA0335YXA
CAT.# F540335 \$65.00 each
 1/10HP 115V R134A 350btu@20F
 MED TEMP FOR CAP TUBE
 WITH RELAY, OVERLOAD, COVER AND
 POE OIL 4" x 6.5" MOUNT

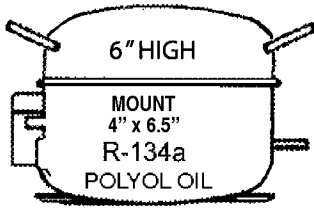

ASPERA MODEL B5128A
1/8HP 115V R12/R134A
H-MBP LST FOR CAP TUBE
WITH ELECTRICAL AND POE OIL
CAT.# A1C5128 \$65.00 each

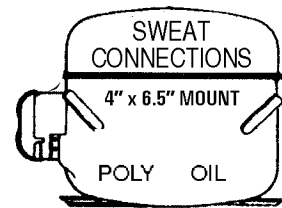

EMBRACO MODEL PW5.5K14
1/6HP 115V R12/R134A L-MBP
LST FOR CAP TUBE WITH
ELECTRICAL AND POE OIL
CAT.# A1CPW55 \$115.00 each

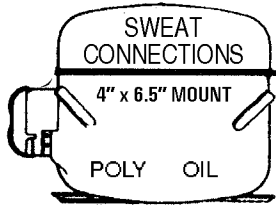

DANFOSS-SECOP COMPRESSOR
MODEL NTY5.5FK 1/5HP 115V R134A
 700 btu@-10F LOW TEMP FOR
 CAP TUBE WITH ELECTRICAL & POE OIL
CAT.# A1CNTY55 \$135.00 each

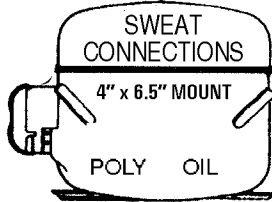

DANFOSS-SECOP COMPRESSOR
MODEL NF5.5FX 1/5HP 115V R134A
 LBP-695 btu HBP 2500 btu HST FOR CAP
 TUBE OR TXV WITH ELECTRICAL & POE OIL
CAT.# A1CNF55 \$145.00 each

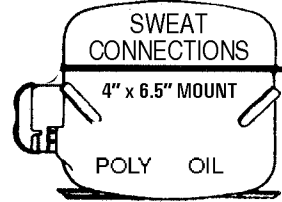

ASPERA MODEL NEK6132Z
1/6HP 115V R134A MED TEMP
 1500 BTU@45F FOR CAP TUBE OR TXV
 WITH ELECTRICAL AND POE OIL
CAT.# A1C6132Z \$125.00 each

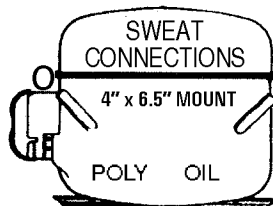

Embraco Model VEGY6H
Cat.# A1CVEGY6H \$99.00 each
 Variable capacity compressor
 Compressor only POE oil charge
 335 btu to 960 btu 115v
 NO INVERTER

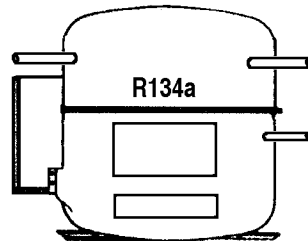

EMBRACO COMPRESSOR
MODEL EMye70HEP 1/5HP 115V
R134A L-MBP LST FOR CAP TUBE
WITH ELECTRICAL & POE OIL
CAT.# A1CEM70 \$135.00 each

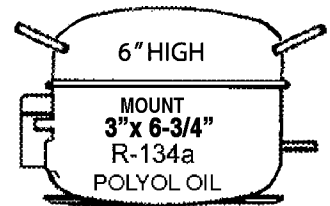

TECUMSEH COMPRESSOR
MODEL AZA1316YXA
 1/16HP 115V R134A LOW TEMP
 LOW TORQUE FOR CAP TUBE WITH
 ELECTRICAL & POE OIL
CAT.# F541316 \$65.00 each

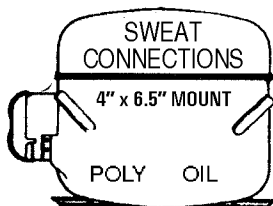

TECUMSEH COMPRESSOR
MODEL AEA0422EXA
 1/3HP 115V R22/R404A MEDIUM TEMP
 LOW TORQUE FOR CAP TUBE WITH
 ELECTRICAL & POE OIL
CAT.# F540422 \$175.00 each

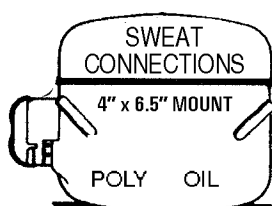

TECUMSEH COMPRESSOR
MODEL AEA0430EXA
 1/2HP 115V R22/R404A MEDIUM TEMP
 LOW TORQUE FOR CAP TUBE WITH
 ELECTRICAL & POE OIL
CAT.# F540430 \$220.00 each

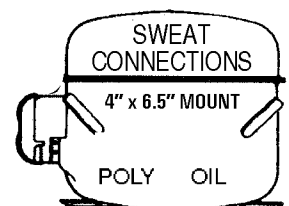

WATER COOLED COMMERCIAL CONDENSING UNITS

Complete water cooled condensing units. Compressor, w/cooled condenser, water valve, receiver tank, hi-low pressure control, service valves and electrical starting components.

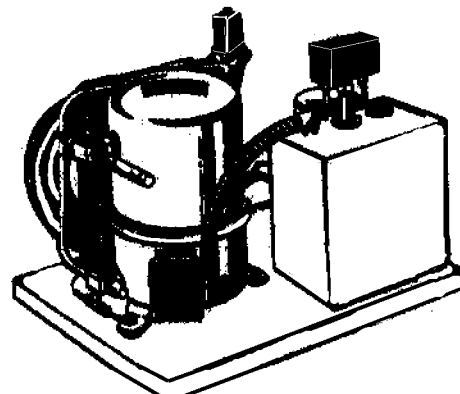

Cat.#	HP	Temperature	Refrigerant	Price Ea.
A1C982	1	Medium	R-134a / R-12	CALL FOR PRICES
A1C983	2	Medium	R-134a / R-12	
A1C984	3	Medium	R-134a / R-12	
A1C895	1	Medium	R-22 / R-404a	
A1C986	2	Medium	R-22 / R-404a	
A1C987	3	Medium	R-22 / R-404a	

DANFOSS/SECOP MODEL NF10FX
+1/4HP 115V R134A MEDIUM TEMP
 HIGH TORQUE WITH ELECTRICAL &
 POE OIL 4" x 6.5" MOUNT
CAT.# A1CNF10 \$175.00 each

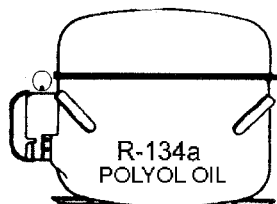

NECHHI MODEL ESM12H
CAT.# A1CESM12 \$135.00 each
1/3HP 115V R134A MEDIUM TEMP
 LOW TORQUE FOR CAP TUBE ONLY
 WITH ELECTRICAL, POE OIL AND SWEAT
 LINES 4"x 6.5" MOUNT

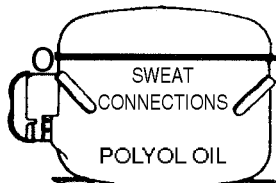

DANFOSS/SECOP MODEL NF11FX
1/3HP 115V R134A MEDIUM TEMP
 HIGH TORQUE WITH ELECTRICAL &
 POE OIL 4" x 6.5" MOUNT
CAT.# A1CNF11 \$185.00 each

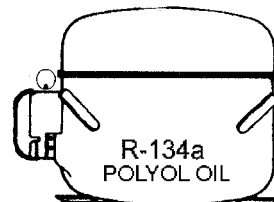

DANFOSS ELIMINATOR FILTER-DRIERS

Cat.#	MFG. #	CONN. SIZE	TYPE	HP	CU. INCH	PRICE EA.
A10033	EK-033S	3/8" ODF	033S	1/2	3	\$ 5.00
A1018	DML-305S	5/8" ODF	305S	5 - 7.5	30	\$ 22.00
A1019	DCL-305	5/8" SAE FL	305	5 - 7.5	30	22.00
A1020	DCL-417S	7/8" ODF	417S	7-1/2- 10	41	25.00

CARRIER - THERMO KING SUCTION LINE FILTER-DRIER

A1015	67-9015	1/2" SAE FL	164	3 - 5	16	\$12.95
A1016	68-167S	7/8 ODF	167	3 - 4	16	\$12.95

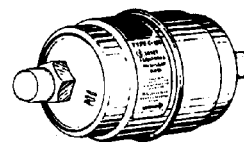

NO ACCESS
PORT FITTINGS

AIR CONDITIONING COMPRESSORS - ORDER IN LOTS OF 3 AND SAVE EVEN MORE
 THESE COMPRESSORS ARE COMPLETE WITH COVERS, OVERLOAD PROTECTORS AND OIL CHARGE
 ROTARY COMPRESSORS REFRIGERANT-22

Cat. No.	Mfg.	Model No.	Volts/HZ	BTU	Price Ea.
F2655	Matsushita	2R7S3R126A	115/60	5,500	\$ 65.00
F4022	Tecumseh	RGA5450EXA	115/60	5,000	\$ 65.00
F40946	Sanyo	C-1R30HB2	115/60	5,000	\$ 65.00
F40387	Sanyo	C-1R51H2B	115/60	8,300	\$ 85.00
F40093	Sanyo	C-R70H2B	115/60	9,000	85.00

CAT.#	MODEL #	HP	BTU	VOLTS/PH	PRICE
F13T81J19	T81J195CBCA	1-3/4	19,000	230/1/60	\$ 350.00
F13T81J38	T81J384CBCA	3-1/4	38,000	230/1/60	450.00
F13T89A51	T89A515BBCA	4-1/2	51,000	230/1/60	595.00

BRISTOL R410A 2 STAGE COMPRESSORS

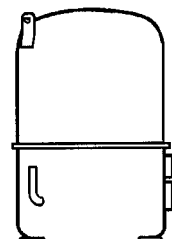

**DANFOSS-SECOP COMPRESSOR
MODEL FR6G 1/5HP 230V R134A**
650 btu@-10F LOW TEMP FOR
CAP TUBE WITH ELECTRICAL & POE OIL
CAT.# A1CFR6230 \$79.00 each

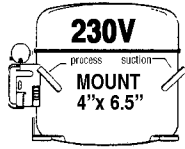

**DANFOSS-SECOP COMPRESSOR
MODEL FR8.5G 1/4HP 230V R134A**
LBP-800 btu HBP-3000 btu HST FOR CAP
TUBE OR TXV WITH ELECTRICAL & POE OIL
CAT.# A1CFR85230 \$99.00 each

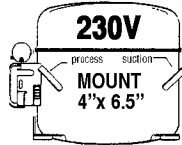

**DANFOSS-SECOP COMPRESSOR
MODEL BD80F 1/4HP R134A DC
INVERTER 12-24V COMPRESSOR ONLY**
CAT.# A1CBD80 \$110.00 each

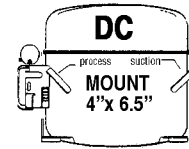

**EMBRACO MODEL FF112HBX2
CAT.# A1CFF112-2 \$135.00 ea.**
1/3HP 230/1/60 R134A L-MBP HIGH
TORQUE WITH ELECTRICAL, PO OIL
AND SWEAT CONNECTIONS

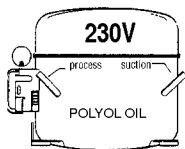

**TECUMSEH MODEL AEA4440YXD
CAT.# F544440YD \$135.00 ea.**
1/3HP 230/1/60 R134A MBP HIGH
TORQUE WITH ELECTRICAL, POE OIL
AND SWEAT CONNECTIONS

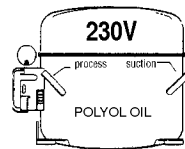

**DANFOSS-SECOP COMPRESSOR
MODEL SC12G 1/3HP 230V R134A**
LBP-1200 btu HBP-4200 btu HST FOR CAP
TUBE OR TXV WITH ELECTRICAL & POE OIL
CAT.# A1CSC12G230 \$175.00 each

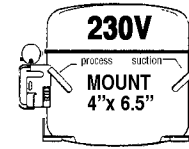

LG SCROLL MODEL SQA022KAC
22,000 BTU R22 208-230/1/60
FOR A/C 7.5" x 7.5" MOUNT 16" HIGH
WITH MINERAL OIL 1/2" LIQUID-3/4" SUCTION
CAT.# F13SQA022 \$295.00 each

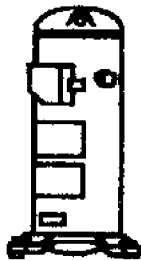

LG SCROLL MODEL SQA026KAC
26,000 BTU R22 208-230/1/60
FOR A/C 7.5" x 7.5" MOUNT 16 1/2" HIGH
WITH MINERAL OIL 1/2" LIQUID-3/4" SUCTION
CAT.# F13SQA026 \$325.00 each

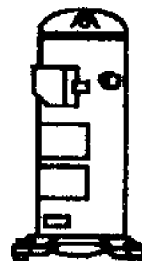

LG SCROLL MODEL SQA032KAC
32,000 BTU R22 208-230/1/60
FOR A/C 7.5" x 7.5" MOUNT 17" HIGH
WITH MINERAL OIL 1/2" LIQUID-3/4" SUCTION
CAT.# F13SQA032 \$350.00 each

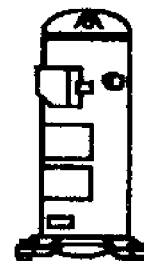

LG SCROLL MODEL SQA038KAC
38,000 BTU R22 208-230/1/60
FOR A/C 7.5" x 7.5" MOUNT 17" HIGH
CAT.# F13SQA038 \$425.00 each

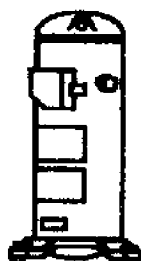

LG SCROLL MODEL ABA051KAE
51,000 BTU R410A 208-230/1/60
FOR A/C 7.5" x 7.5" MOUNT 17" HIGH
CAT.# F13051K1 \$495.00 each

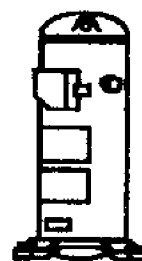

**SAMSUNG ROTARY COMPRESSOR
MODEL UG5A290INZJ2**
29,000 BTU R410A 208-230/1/60
FOR A/C 6" TRIANGLE MOUNT 17" HIGH
WITH POE OIL AND COVER
CAT.# A2C290 \$190.00 each

SPECIAL PRICING
10 LOT \$ 150.00
40 LOT \$ 125.00
120 LOT \$ 100.00

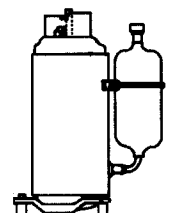

COPELAND MODEL ZB07KAE-PFV
CAT.# A1ZB07V \$550.00 each
 +3/4HP 230/1/60 R404A MEDIUM TEMP
 WITH ELECTRICAL, POE OIL AND 5/8"
 SUCTION VALVE
 7500 btu@20F MED TEMP

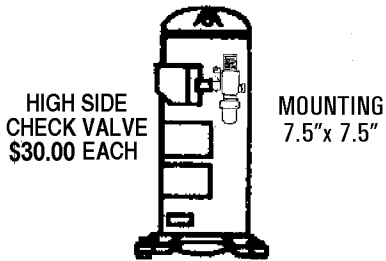

COPELAND MODEL ZB08KAE-PFV
CAT.# A1ZB08V \$595.00 each
 1HP 230/1/60 R404A MEDIUM TEMP
 WITH ELECTRICAL, POE OIL AND 5/8"
 SUCTION VALVE
 8200 btu@20F MED TEMP

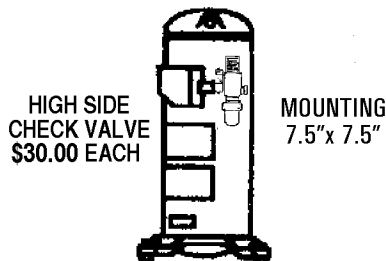

COPELAND MODEL ZB13KCE-PFV
CAT.# A1Z B13V \$625.00 each
 1.5HP 230/1/60 R404A MEDIUM TEMP
 WITH ELECTRICAL, POE OIL AND 7/8"
 SUCTION VALVE
 13,000 btu@20F MED TEMP

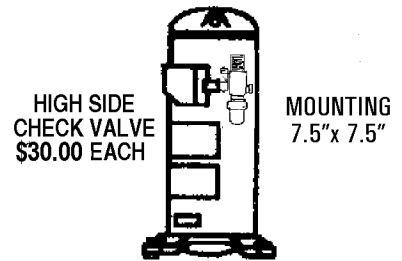

COPELAND MODEL ZB15KCE-PFV
CAT.# A1ZB15V \$650.00 each
 2HP 230/1/60 R404A MEDIUM TEMP
 WITH ELECTRICAL, POE OIL AND 7/8"
 SUCTION VALVE
 15,000 btu@20F MED TEMP

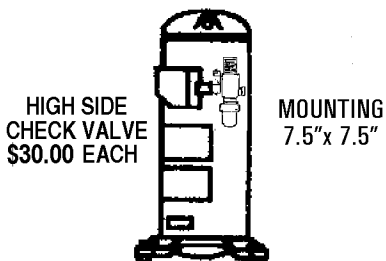

COPELAND MODEL ZB19KCE-PFV
CAT.# A1ZB19V \$675.00 each
 2.5HP 230/1/60 R404A MEDIUM TEMP
 WITH ELECTRICAL, POE OIL AND 7/8"
 SUCTION VALVE
 18,600 btu@20F MED TEMP

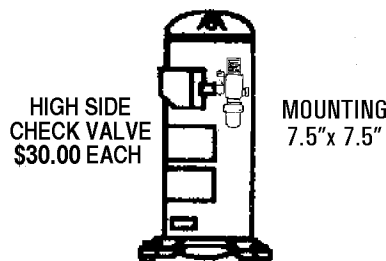

COPELAND MODEL ZB21KCE-PFV
CAT.# A1ZB21V \$725.00 each
 3HP 230/1/60 R404A MEDIUM TEMP
 WITH ELECTRICAL, POE OIL AND 7/8"
 SUCTION VALVE
 22,200 btu@20F MED TEMP

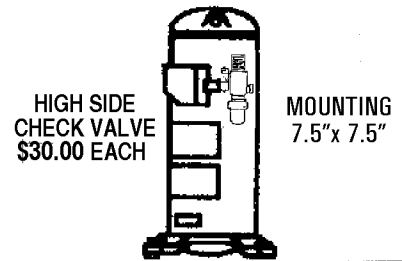

COPELAND COND. UNIT 1/3HP 115V
 R134A MBP M7PH-H031-CAA-121
 HST WITH RECEIVER TANK, SWEAT
 LINES & CONDENSATE BASE PAN
CAT.# A1UH031CAA \$395.00 each
 20"D x 11"W x 10.5"H

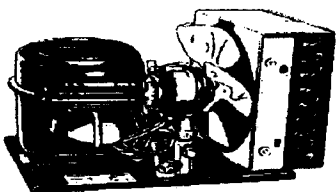

SECOP COND. UNIT 1/4HP 115V
 R134A MBP UNF9FX HST WITH
 RECEIVER TANK
 3000 btu@45F
CAT.#A1C71 \$385.00 each

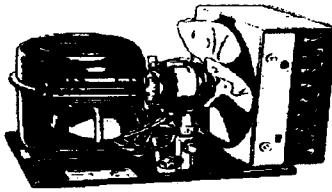

COPELAND COND. UNIT 1/2HP 230V MBP
 MODEL M2FH00561AV
CAT.# A1U0056-2 \$625.00 EACH
 R134A MED-HIGH TEMP 6870 BTU @45F
 WITH RECEIVER TANK, SUCTION & HIGH
 SIDE SERVICE VALVES, DRIER & SIGHT GLASS
 17.5"D x 14.5"W x 12"H

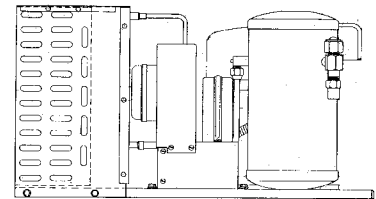

SECOP UNIT 1/2HP 115V R404A
 MODEL USC12CLX L-MBP
CAT.# A1USC12CLX \$625.00 each
 2000 btu@-10F HIGH TORQUE
 WITH RECEIVER TANK, SUCTION AND
 LIQUID SERVICE VALVES
 18"D x 13.25"W x 11"H

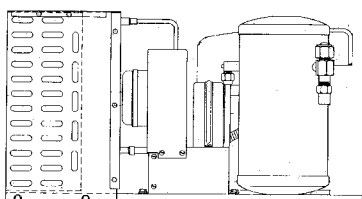

SECOP UNIT 1/2HP 115V R134A
 MODEL USC18G R134A MED TEMP
CAT.# A1C54 \$625.00 each
 6000 btu@45F HIGH TORQUE
 WITH RECEIVER TANK, SUCTION AND
 HIGHSIDE SERVICE VALVES
 18"D x 13.25"W x 11"H

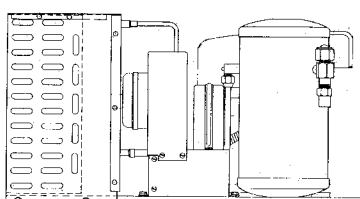

SECOP UNIT 1/3 HP 115V R404A MBP
 MODEL UNF7CLX
CAT.#A1UNF7CLX \$395.00 each
 1/3 HP 115V R404A MEDIUM TEMP
 HIGH STARTING TORQUE WITH RECEIVER
 TANK, SUCTION & LIQUID SERVICE
 VALVES, POE OIL CHARGE

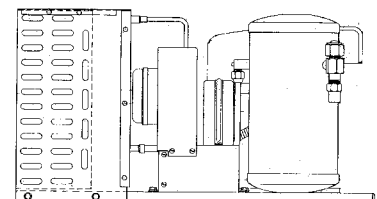

G.E. CURRENT RELAY

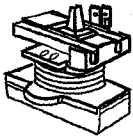

3ARR12-PL22

CAT.# F5413
\$5.95 each

- 1/3 HP
- 115V W/Capacitor connection
- Push-on terminals
- Tecumseh #P82929

For models- AEA1413YXA-AXA / AEA3440YXA-AXA / AEA4440YXA-AXA AND SIMILAR ASPERA AND COPELAND COMPRESSORS.

G.E. CURRENT RELAY

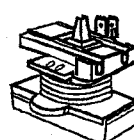

3ARR12-KPM71

CAT.# F5412
\$5.95 each

- 1/4 HP - 1/3 HP
- 115V W/Capacitor connection
- Screw-on terminals
- Tecumseh #P82473

For models- AEA2410YXA-AXA / AEA2411ZXA / AEA2413YXA-AXA / AEA2415AXA / AEA2416JXA / AEA4448YXA-AXA / AEA9422EXA-ZXA AND SIMILAR ASPERA AND COPELAND COMPRESSORS.

PARAGON DEFROST TIMER-TIME INITIATED-TEMPERATURE OR PRESSURE TERMINATED

Frequency of defrost is one to six cycles per day-A minimum of four hours between defrost cycles. Contact arrangements for electric defrost-compressor shutdown or hot gas defrost. Switch rating 40amp 230/115.

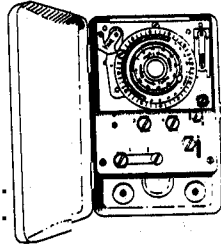

Cat.#
A1814500 120V 8145-00 \$135.00 ea.
A1814520 230V 8145-20 \$135.00 ea.

DOMESTIC-COMMERCIAL COMPRESSOR RELAY AND OVERLOAD KITS 115 VOLTS

Cat.#	HP
A118	1/8
A116	1/6
A115	1/5
A114	1/4
A113	1/3

\$7.95 each

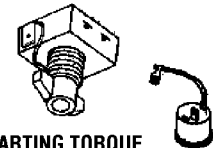

FOR LOW STARTING TORQUE COMPRESSORS NO CAPACITOR

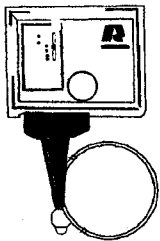

Ranco Low Pressure Control Type 016-624

Opens on low pressure.
Range 12" Vac. 80 lbs. pressure.
Differential 5 to 38 lbs. 36" capillary tube with 1/4" flare nut.
All Range.

Cat.# A1730 \$75.00 each

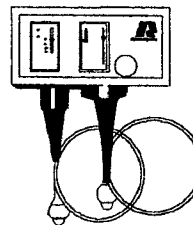

Ranco Dual Pressure Control Type 1549

All range commercial dual pressure control.
Low side pressure range 10" Vac. to 100 PSI.
High pressure side 150 PSI to 450 PSI.
With two 36" capillary tubes with 1/4" flare nuts.

Cat.# A1731 \$135.00 each

AIR COOLED CONDENSING UNIT 1HP 230/1/60 MED-LOW TEMP MODEL UCS12

UNIT WITH LOW PRESSURE CONTROL AND RECEIVER TANK
19.25"W x 23.25"D x 16.5"H 5/8" FL.SUCTION- 3/8" FL.LIQUID

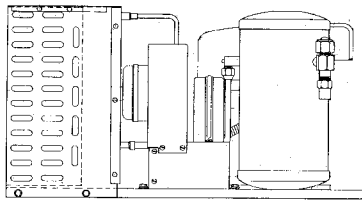

R404A LBP 4000 btu @ -10F
R134A MBP 7500 btu @ 25F

CAT.# A1UCS12
\$1250.00 EACH

REACH-IN UNIT SLOPE FRONT EVAPORATOR FOR 1/2 115V COMMERCIAL TEMPERATURE UNITS 4000 btu. @ 25°F.

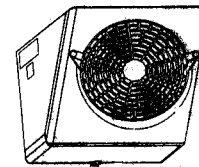

Peerless Model SF-175

Unit coolers are ideal for refrigerated reach-ins. Mounts to top of refrigerator and discharges cold air against back wall.
Cat.# F78SF175 \$275.00 ea.

DANFOSS-SECOP COMPRESSOR MODEL NTY5.5FK

1/5HP 115V R134A
700 BTU @ -10F FOR CAP TUBE
CAT.# A1CNTY55 \$135.00 each

Complete with relay, overload protector and cover. Cap tube application.
Polyol-ester oil charge for R-12 or R-134a.

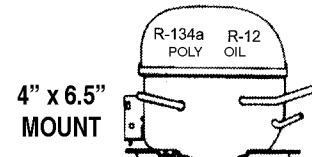

4" x 6.5"
MOUNT

EVAPORATOR REPLACEMENT MOTOR FOR HEATCRAFT-BOHN-CHANDLER-LARKIN-CLIMATE CONTROL. SLEEVE BEARING 1/15 HP-3" LONG SHAFT

Replacement for walk-in cooler evaporator fans. - Low Amp Draw Motor- Low Temp Lub System- Frame 3.3" UL Class B Insulation- 40°C Amb.
1 Speed-1550 RPM- 5/16" Shaft X 3" Long.

CW ROTATION
FACEING SHAFT

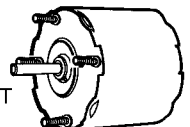

Cat.# 41124 PACKARD 1/15 HP 115V \$79.00 each
Cat.# 41126 PACKARD 1/15 HP 230V \$79.00 each

SECOP CONDENSING UNIT
3/4HP 115V R404A MEDIUM TEMP
HIGH STARTING TORQUE
MODEL SC18MLX
CAT.# A1C1002 \$1095.00 each

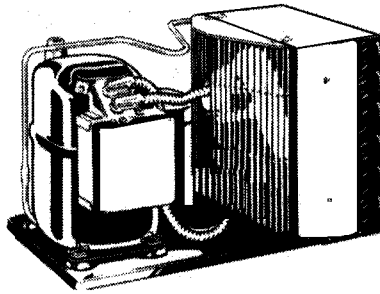

Air cooled unit - high starting torque for expansion valve complete with service valves, receiver tank and electrical parts. With low side pressure control.

SECOP CONDENSING UNIT
1/2HP 115V R134A MEDIUM TEMP
HIGH STARTING TORQUE
MODEL USC18G
CAT.# A1C54 \$625.00 each

Air cooled unit - high starting torque for expansion valve - complete with service valves, receiver tank and electrical parts. No Low Pressure control.

AIR COOLED CONDENSING UNITS
HIGH STARTING TORQUE

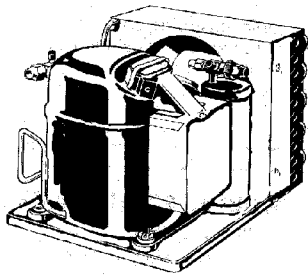

Cat.#	Model	HP/Volts	Temperature	Price Ea.
A1UZB07	ZB07KAE-PFV	+3/4HP 230/1	R404A/R22 MEDIUM	\$ 1095.00
A1UZB08	ZB08KAE-PFV	1HP 230/1	R404A/R22 MEDIUM	\$ 1250.00
* A1UZB13	ZB13KCE-PFV	1-1/2HP 230/1	R404A/R22 MEDIUM	\$ 1895.00
* A1UZB15	ZB15KCE-PFV	2HP 230/1	R404A/R22 MEDIUM	\$ 1995.00

Scroll condensing units, high starting torque with low side and high side service valves, receiver tank, and all starting components mounted and wired, with low side pressure control.

* With dual pressure control

1/5 HP 115V HIGH BACK PRESSURE UNIT R-134a CAP TUBE

Hi- back pressure condensing unit for refrigerators, salad bars, water coolers, cold tables, etc.

Cat.# A1C981
\$275.00 ea.

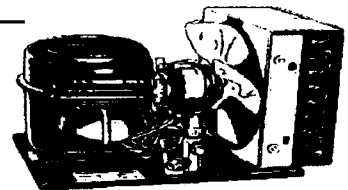

1/8 HP 115V HIGH BACK PRESSURE UNIT R134A CAP TUBE

Hi- back pressure condensing unit for refrigerators, salad bars, water coolers, cold tables, etc.

Cat.# A2U981
\$255.00 ea.

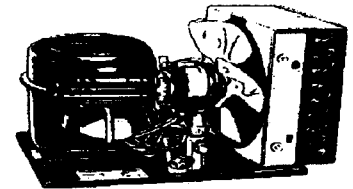

SECOP AIR COOLED CONDENSING UNIT 1/3 HP 115V MODEL UNF7CLX
LOW TEMP 1300 btu@-10F/ MED TEMP 2300 btu@25F

Hermetic condensing units, high starting torque with low side and high side service valves, receiver tank and all starting components mounted and wired.

Cat.# A1UNF7CLX **\$395.00 each**

SECOP AIR COOLED CONDENSING UNIT 1/2 HP 115V MODEL USC12CLX
LOW TEMP 2000 btu@-10F/ MED TEMP 5100 btu@25F

Hermetic condensing units, high starting torque with low side and high side service valves, receiver tank, and all starting components mounted and wired.

Cat.# A1USC12CLX **\$625.00 each**

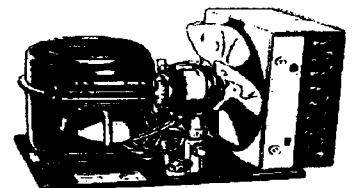

REFRIGERATION CONDENSING UNITS

SECOB COND. UNIT 1/4HP 115V R404A L-MBP
 MODEL UTFS4.5CLX
 850 btu@-10F/ 1900 btu@25F
CAT.# A1U45CLX
\$385.00 each

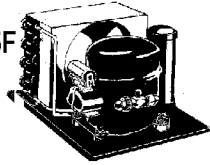

High starting torque, with receiver tank, suction and liquid service valves.

TECUMSEH MODEL AKA9427ZXA-1/3 HP 115V
 1/3+ HP 115V R-404A/R-22
 Medium Temperature
Cat.# A1U9427Z
\$595.00 each

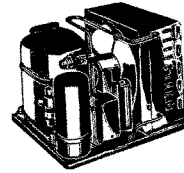

High starting torque, with receiver tank, suction and liquid service valves.

TECUMSEH MODEL AEA2413YXA 1/3HP
 115V R134A LOW TEMP
 CAP TUBE CONDENSING UNIT
 NO RECEIVER TANK.
CAT.# F54U2413Y
\$395.00 each

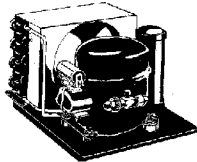

18.5" D x 10.5"W x 10" H

TECUMSEH LOW PROFILE UNIT
 1/2 HP 115V R-404A/R-22
 Rotary commercial unit
 Med/High Temperature
 High torque for tx valve
 or cap tube application.
Cat.# A1U0440
\$595.00 each

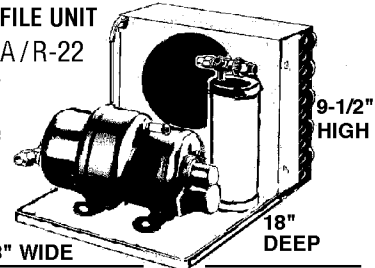

SECOB CONDENSING UNIT 1/4HP 115V
 R134A MEDIUM TEMP HIGH TORQUE
 RECEIVER TANK WITH HIGH AND
 LOW SIDE SERVICE VALVES
 MODEL UNF9FX

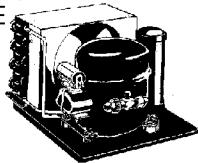

CAT.# A1C71 \$385.00 each

COPELAND CONDENSING UNIT 1/5HP 115V
 R404A MEDIUM TEMP HIGH TORQUE
 NO RECEIVER TANK, HIGH AND
 LOW SIDE SERVICE VALVES
 MODEL M4PH-0022-IAA
 CONDENSATE DRAIN PAN BASE

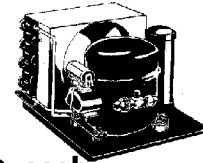

CAT.# A1U0022 \$325.00 each

SECOB CONDENSING UNIT USC18G
 1/2HP 115V R134A MEDIUM TEMP
 HIGH STARTING TORQUE WITH
 RECEIVER TANK, SUCTION AND
 LIQUID SERVICE VALVES

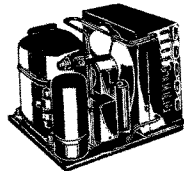

CAT.# A1C54
\$625.00 each

SECOB CONDENSING UNIT
 3/4 HP 115V Commercial Temp
 Model USC18MLX R404A

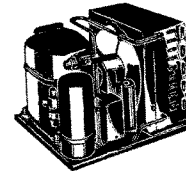

Cat.# A1C1002
\$1095.00 each

High starting torque, with low pressure control, receiver tank, suction and liquid service valves.

SECOB CONDENSING UNIT MODEL USC12CLX
 1/2HP 115V R404A LOW TEMP
 2000 BTU @ -10F HIGH TORQUE
CAT.# A1U12CLX
\$625.00 each

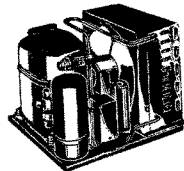

High starting torque, with receiver tank, suction and liquid service valves.

SECOB CONDENSING UNIT MODEL USC12CLX-2
 1/2 HP 230V R404A L-MBP
CAT.# A1U12CLX-2
\$625.00 each

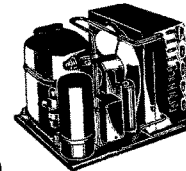

HIGH STARTING TORQUE WITH RECEIVER TANK, SUCTION AND LIQUID SERVICE VALVES.

EMBRACO COND. UNIT MODEL UT6215Z-2
 1/2HP 230V R134A MED. TEMP
 7600 btu@45F

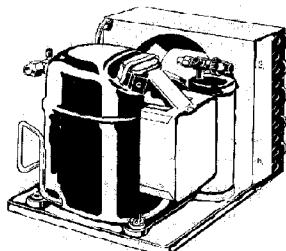

CAT.# A1C54230
\$625.00 each

HIGH STARTING TORQUE, WITH RECEIVER TANK, SUCTION AND LIQUID SERVICE VALVES.

TECUMSEH MODEL AKA9427ZXD +1/3HP 230V
 +1/3HP 230V R404A/R22
 MEDIUM TEMP

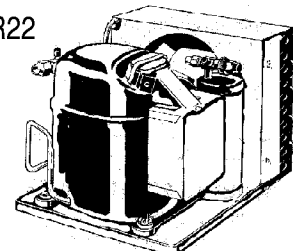

CAT.# A1U9427ZD
\$595.00 each

High Starting Torque, with receiver tank, suction and liquid service valves.

NECCHI UNIVERSAL COMPRESSOR

MODEL ESM11K 1/3 HP 115V 60HZ

With Oil Cooler Lines

For Refrigerators Up To 24 Cu. Ft.
8" High - Mounting Holes 4" x 6-1/2"

CAPILLARY TUBE APPLICATION
LOW TEMPERATURE 1,200 Btu
Evap -10 Deg. F.

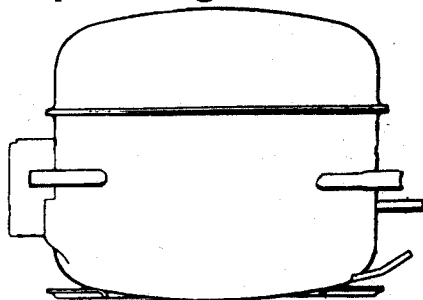

Cat.# G100 R-12 GAS \$89.00 each
Cat.# G101 R-134a GAS \$99.00 each

BRISTOL AIR CONDITIONING COMPRESSORS R410A

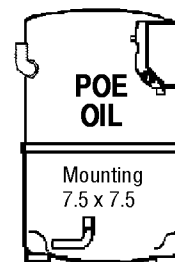

Cat.#	Model	H.P.	BTU	Volts/Ph	Price Ea.
A2CH82J13	H82J133ABCA	1	13,000	230/1/60	\$250.00
A2CH82J18	H82J18BABCA	1-1/2	18,000	230/1/60	\$275.00
A2CH82J21	H82J213ABCA	2	21,000	230/1/60	\$295.00
A2CH82J24	H82J243ABCA	2	24,000	230/1/60	\$295.00
A2CH82J28	H82J283ABCA	2-1/4	28,000	230/1/60	\$325.00
A2CH82B36	H82B363ABCA	3	36,000	230/1/60	\$350.00
A2CH82J37-3	H82J37MDBLA	3	37,000	230/3/60	\$350.00
A2CH82J37-4	H82J37MDBVA	3	37,000	460/3/60	\$350.00
A2CH82J40	H82J403ABCA	3-1/2	40,000	230/1/60	\$375.00
A2CH82J44	H82J443ABCA	3-3/4	44,000	230/1/60	\$400.00
A2CH82J48	H82J483ABCA	4	48,000	230/1/60	\$425.00

BRISTOL AIR CONDITIONING COMPRESSORS R22

A2CH22J44-4	H22J443DBEA-P	3-3/4	44,000	460/3/60	\$450.00
A2CH22A54-4	H22A543DBEA	4-1/2	54,000	460/3/60	\$525.00
A2CH22A62-4	H22A623DBEA	5	62,000	460/3/60	\$695.00
A1C094-4	H2NG094DPEE-S*	7-1/2	94,000	460/3/60	\$1095.00
A2CG094-4	H22G094DBEE-S*	7-1/2	94,000	460/3/60	\$1095.00
A2CG094-3	H92G094GPDE-PR*	7-1/2	94,000	230/3/60	\$1095.00
A2CG104-4	H2BG104DBEE-R*	9	104,000	460/3/60	\$1195.00
A2CG124-3	H22G124DBDE-PS*	10	124,000	230/3/60	\$1295.00
A2CG144-4	H22G144DBEE-S*	12	144,000	460/3/60	\$1395.00
A2CG184-3	H92G184DPDF-PS*	15	184,000	230/3/60	\$1695.00
A2CG244-3	H92G244FRDF-PR*	20	244,000	230/3/60	\$1995.00
A2CG294-3	H22G294FPDF-S*	24	294,000	230/3/60	\$2095.00

P- POE OIL CHARGE
S*- SWEAT CONNECTIONS
R*- ROTO LOCK CONNECTIONS (SET SERVICE VALVES EXTRA \$250.00)

Call Toll Free 1-800-445-1281

COLDPARTS, INC. 4401 S. Western Blvd. Chicago, IL 60609

COPELAND REFRIGERATION CONDENSING UNITS

CAT.#	MODEL	HP	TEMPERATURE	RECEIVER TANK	VOLTS/PH	PRICE
A1U0022	M4PH-0022-IAA	1/5	MEDIUM/HST/R404A	NO	115/1/60	\$325.00
A1UH031	M7PH-H031-CAA-121	1/3	MEDIUM/HST/R134A	YES	115/1/60	\$395.00
A1U0056-2	M2FH0056IAV-27	1/2	MEDIUM/HST/R134A	YES	230/1/60	\$625.00

**ASPERA MODEL TJ6217Z 1/2HP R134A UNIT 230V
MEDIUM TEMPERATURE - HIGH STARTING TORQUE
FOR EXPANSION VALVE - COMPLETE WITH SERVICE
VALVES, RECEIVER TANK & ELECTRICAL PARTS.**

CAT.# A1C54230 230V \$625.00 each

Can Be Shipped By UPS

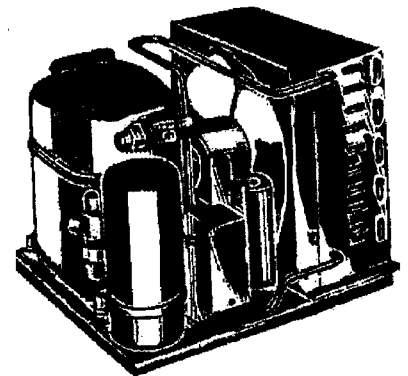

**MEDIUM TEMPERATURE AIR COOLED CONDENSING UNITS
HIGH TORQUE FOR EXPANSION VALVE OR CAP TUBE
UNIT COMPLETE WITH LIQUID RECEIVER TANK, HIGH
SIDE AND LOW SIDE SERVICE VALVES,
AND ALL ELECTRICAL STARTING COMPONENTS.**

**Cat#
A1C71 \$385.00 each
1/4 HP 115V R-134a HI-TORQUE UNIT**

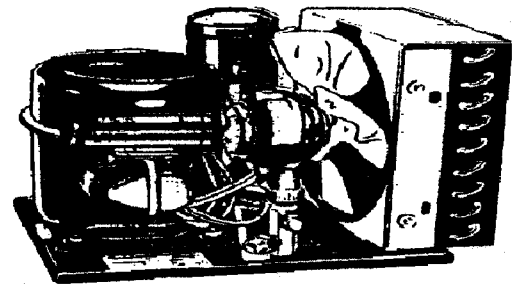

**A1C933 \$395.00 each
1/3HP 115V R-134a HI-TORQUE UNIT**

**TECUMSEH LOW PROFILE HORIZONTAL
ROTARY COMMERCIAL TEMPERATURE** *Extra Quite Muffler
7-1/2" HIGH*

**COMPRESSOR. R-22 +25° TO
45° EVAP TEMPERATURE.**

Model No. HGA0440EXA 4,000 BTU.
1/2 HP 115V CAP TUBE, AB-OIL.
6-3/4" High. Complete With
Electrical Starting Components.
1/2" ODF Suction x 1/4" ODF Discharge.

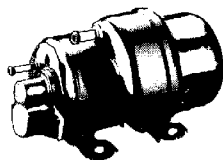

Cat.# F540440 \$295.00 each *5" x 8" Mounting
Centers*

LG SCROLL R410A AIR CONDITIONING COMPRESSORS

CAT.#	MODEL	HP	BTU	VOLTS/PH	PRICE
F13024K1	APA024KAA	2	24,000	230/1/60	\$250.00
F13026K1	APA026KAA	2 1/4	26,000	230/1/60	275.00
F13029K1	APA029KAB	2 1/2	29,000	230/1/60	285.00
F13030K1	APA030KAA	2 1/2	30,000	230/1/60	285.00
F13031K1	APG031KAC	2 1/2	31,000	230/1/60	325.00
F13038K1	AQA038KAA	3 1/4	38,000	230/1/60	350.00
F13039K1	AQA039KAA	3 1/4	39,000	230/1/60	350.00
F13040K1	AQA040KAA	3 1/4	40,000	230/1/60	375.00
F13042K1	AQA042KAB	3 1/2	42,000	230/1/60	395.00
F13049K1	ABG049KAA	4	49,000	230/1/60	450.00
F13051K1	ABA051KAE	4 1/4	51,000	230/1/60	495.00

R410A ONLY

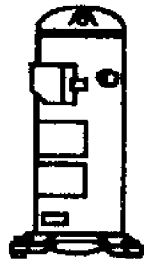

ALL COMPRESSORS
7.5" x 7.5" MOUNTING

ROTARY R22 AIR CONDITIONING AND HEAT PUMP COMPRESSORS

CAT.#	MODEL	MANUFACTURER	HP	BTU	VOLTS/PH	PRICE
F6903	RGB5472EXA	TECUMSEH	3/4	7200	115/1/60	\$ 65.00
F545492	RGA5492EXA	TECUMSEH	3/4	9200	115/1/60	99.00
F102P16	2P16S3R126B	MATSUSHITA	3/4	10,735	115/1/60	135.00
FQK145	QK145CGJ	L-G	3/4	10,000	115/1/60	99.00
F545490ED	RKA5490EXD	TECUMSEH	3/4	9000	230/1/60	149.00
F10CR101	C-R101H2H	SANYO	1	13,300	115/1/60	159.00
F10CR220	C-R220H6B	SANYO	2-1/2	32,000	230/1/60	275.00



ALL COMPRESSORS
3 LEG MOUNT WITH
COVER & OVERLOAD

ELCO MOTORS

WATTS	VOLTS	AMPS	MODEL NUMBER	PRICE Ea.
6	115	0.41	EC-6W115	\$ 79.00
6	230	0.20	EC-6W230	79.00
9	115	0.58	EC-9W115	\$ 89.00
9	115	0.58	EC-9W115NF	89.00
9	230	0.35	EC-9W230	89.00
16	115	1.00	EC-16W115	\$ 99.00
16	230	0.50	EC-16W230	99.00
34	115	1.60	EC-34W115	\$ 135.00
34	230	0.80	EC-34W230	135.00

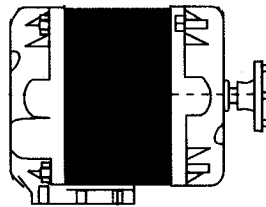

ELCO®

Shaded pole, 4 pole, 1550 RPM
Totally enclosed 50/60 Hz
Long life sleeve bearings
CW Rotation opposite shaft end
Nuts, screws, & fan blade adapter
included.
4 HOLE BOTTOM FOOT MOUNT.

UNIVERSAL PSC BLOWER / FAN MOTORS

CARRIER NO. HC52AE209
1 HP 230/60/1 3/SPEED 1075 RPM
SINGLE SHAFT 4" LONG x 1/2" OD
ROTATION CCW LEAD END
BELLY BAND MOUNT
WITH RUN CAP

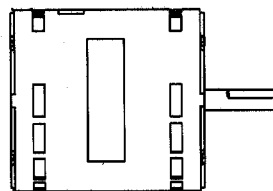

Cat.# F90052S \$79.00 ea.
230/60/1

LENNOX NO. E7033949
1 HP 115/60/1 4/SPEED 1075 RPM
SINGLE SHAFT 4" LONG x 5/8" OD
ROTATION CCW LEAD END
BELLY BAND MOUNT
WITH RUN CAP

Cat.# F903949 \$45.00 ea.
115/60/1

CARLYE-CARRIER-SCROLL-COMPRESSORS-A/C-R22

CATALOG NO. MODEL HP BTU VOLTS/PH PRICE

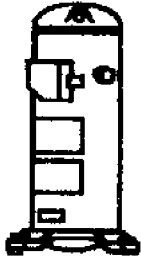

F13XCH34	XCH342HA01	3	34,000	460/3/60	\$ 395.00
F13SRH45	SRH452HC01	4	45,000	460/3/60	425.00
F13SRH48	SRH482AC01	4	48,000	460/3/60	450.00
F13XRH54	XRH542HA01	4 1/4	54,000	460/3/60	495.00

ALL COMPRESSORS
7.5"x 7.5" MOUNTING

TECUMSEH LOW PROFILE CONDENSING UNITS 9-1/2" HIGH X 28" WIDE X 18" DEEP

Tecumseh commercial temperature rotary compressor condensing units. For Cap tube or hi-torque applications. 1/2" OD suction x 1/4" OD discharge. and electrical parts.

Cat.# A1U0440 1/2 HP 115/60/1 R-22. Hi-Torque \$595.00 each
Cat.# A1U9468 3/4 HP 230/60/1 R-404a. Hi-Torque \$950.00 each

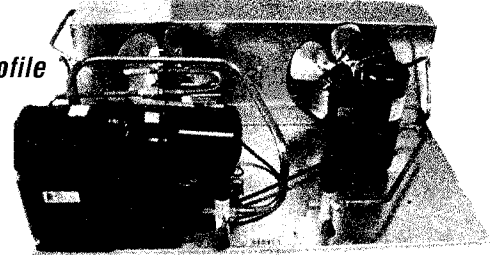

Can be used on low profile soda coolers

TECUMSEH LOW PROFILE HORIZONTAL ROTARY COMMERCIAL TEMPERATURE COMPRESSOR. R-22 +25° TO 45° EVAP TEMPERATURE.

Model No. HGA0440EXA 4,000 BTU. 1/2 HP 115V CAP TUBE, AB-OIL. 6-3/4" High. Complete With Electrical Starting Components. 1/2" ODF Suction x 1/4" ODF Discharge.

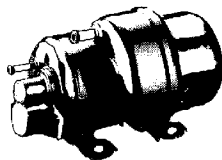

6-3/4" HIGH

Cat.# F540440 \$295.00 each

5" x 8" Mounting Centers

TECUMSEH LOW PROFILE HORIZONTAL ROTARY COMMERCIAL TEMPERATURE COMPRESSOR. R-22 +25° TO 45° EVAP TEMPERATURE.

Model No. HGA0470EXD 7000 BTU. 3/4 HP 230/60/1. CAP TUBE, A-B OIL. 6-3/4" High. Complete With Electrical Starting Components. 1/2" ODF Suction x 1/4" ODF Discharge.



6-3/4" HIGH

Cat.# F5404ED \$325.00 each

5" x 8" Mounting Centers

Cat. No.	Gauge / Cond.	Cord Length (Ft.)	Volts	Power Rating Amps	Watts	Jacket Color	Temperature Range (°F)	UL Listed	Meets OSHA	Carol Model	Each
SAFETY ORANGE GENERAL PURPOSE OUTDOOR EXTENSION CORDS - TYPE SJTW											
F16332	14/3	25	125	15	1875	Orange	-40 to 140	Yes	Yes	03328	\$12.00
F16335	14/3	50	125	15	1875	Orange	-40 to 140	Yes	Yes	03356	\$19.00
F16330	14/3	100	125	13	1625	Orange	-40 to 140	Yes	Yes	03304	\$29.00

CAROL BRAND

OSHA Acceptable
Occupational Safety and Health
Administration

MADE IN
U.S.A.



PANASONIC ROTARY COMPRESSORS FOR R410A MINI-SPLIT A/C'S DC FOR INVERTER SYSTEMS

A2C5KD24	5KD240XAC21	2	24,000	DC 280V	\$ 250.00
A2C5JD42	5JD420XAC22	3-1/2	42,000	DC 280V	295.00

TOSHIBA ROTARY COMPRESSORS FOR R410A MINI-SPLIT A/C'S DC FOR INVERTER SYSTEMS TWIN ROTOR BLDC STYLE COMPRESSORS

F13DA150	DA150A1F-21F1	1-1/2	15,000	DC 171V 120 Hz	\$ 195.00
F13DA220	DA220A2F-23L	2	25,000	DC 200V 120 Hz	275.00
F13DA330	DA330A2F-20M	3	35,000	DC 197V 120 Hz	295.00
F13DA422	DA422A3F-26M	4	46,000	DC 173V 120 Hz	350.00

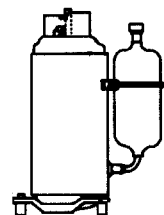

WHIRLPOOL 1/3 HP 115V

1/3 HP 115V R-12
1250 BTU Low Temp
Cap Tube
Mounting 4" x 6-1/2"

Cat.# F41390
\$85.00 ea.

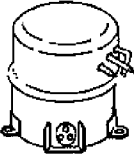

With Relay, Overload, Cover, and Oil Charge.



GENERAL REPLACEMENT PLUG-IN ELEMENTS WITH DELTA SUPPORT 240/208 VOLTS \$5.95 ea.

Will replace Frigidaire-Tappan-Westinghouse-Gibson-Kelvinator-Philco plug-in surface elements.

Cat.#	Size	Watts	Turns
F40222	6"	1100/825	3
F40161	8"	2100/1455	4

EMBRACO MODEL FF112HBX2
CAT.# A1CFF112-2 \$135.00 ea.
1/3HP 230V/1/60 R134A L-MBP HIGH TORQUE WITH ELECTRICAL, PO OIL AND SWEAT CONNECTIONS

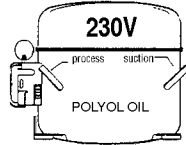

EMBRACO MODEL NE6210Z
1/3HP 230V R134A MEDIUM TEMP HST FOR TXV OR CAP TUBE WITH ELECTRICAL & POE OIL
CAT.# A1C6210Z2 \$155.00 each

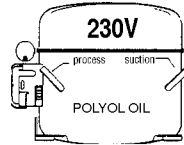

SAMSUNG ROTARY COMPRESSOR
MODEL UG5A290INZJ2
29,000 BTU R410A 208-230/1/60
FOR A/C 6" TRIANGLE MOUNT 17" HIGH WITH POE OIL AND COVER

CAT.# A2C290 \$190.00 each

SPECIAL PRICING
10 LOT \$ 150.00
40 LOT \$ 125.00
120 LOT \$ 100.00

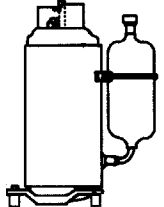

5 PCS.

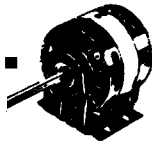

BARGAIN MOTOR ASSORTMENT

ASSORTED MOTORS

Cat.# A1M182
\$75.00

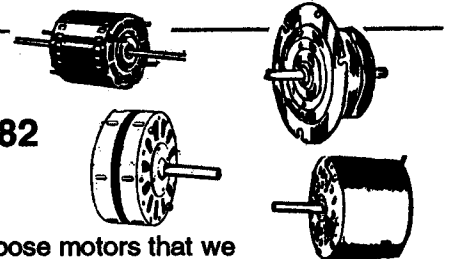

Coldparts purchases thousands of air conditioning - blower - fan and general purpose motors that we advertise in our flyers and catalogs. When we sell out to the last few we offer them to our customers in this "BARGAIN MOTOR ASSORTMENT". These motors are offered to you at prices so low you can't afford to pass up this bargain. One or two motors can easily cost you \$50.00 if you had to buy them at to-days wholesale prices.
ALL MOTORS ARE NEW - ALL MOTORS ARE 230V & 115V 60 HZ

**** NEW COPELAND SCROLL R-410A A/C COMPRESSORS ****

IMPORTANT - - - THESE COMPRESSORS ARE TO BE USED WITH R-410A GAS ONLY.

CATALOG NO.	MODEL	HP	BTU	VOLTS	PRICE
F13ZP14	ZP14K6E-PFV	1-1/4	14,000	230/1/60	\$225.00
F13ZP16	ZP16K5E-PFV	1-1/4	16,000	230/1/60	\$250.00
F13ZP20	ZP20K5E-PFV	1-3/4	20,000	230/1/60	\$295.00
F13ZP21	ZP21K5E-PFV	1-3/4	21,000	230/1/60	\$315.00
F13ZP24	ZP24K5E-PFV	2	24,000	230/1/60	\$325.00
F13ZP25	ZP25K5E-PFV	2	25,000	230/1/60	\$325.00
F13ZP26	ZP26K3E-PFV	2	26,000	230/1/60	\$350.00

DANFOSS ELIMINATOR FILTER-DRIERS

Cat.#	MFG. #	CONN.SIZE	TYPE	HP	CU.INCH	PRICE EA.
A10033	EK-0332	3/8" ODF	033-S	1/2	3	\$ 5.00
A1012	DML-1625S	5/16" ODF	162S	3/4 - 1.5	16	8.95
A1018	DML-305S	5/8" ODF	305S	5 - 7.5	30	22.00
A1019	DCL-305	5/8" SAE FL	305	5 - 7.5	30	22.00
A1020	DCL-417S	7/8" ODF	417S	7-1/2- 10	41	25.00
A1015	67-9015	1/2" SAE FL	164	3 - 5	16	9.95
A1016	68-167S	7/8 ODF	167	3 - 4	16	9.95

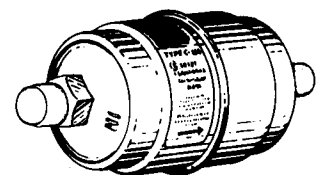

WATER COOLED COMMERCIAL CONDENSING UNITS

Complete water cooled condensing units. Compressor, w/cooled condenser, water valve, receiver tank, hi-low pressure control, service valves and electrical starting components.

Cat.#	HP	Temperature	Refrigerant	Price Ea.
A1C982	1	Medium	R-134a / R-12	CALL FOR PRICES
A1C983	2	Medium	R-134a / R-12	
A1C984	3	Medium	R-134a / R-12	
A1C895	1	Medium	R-22 / R-404a	
A1C986	2	Medium	R-22 / R-404a	
A1C987	3	Medium	R-22 / R-404a	

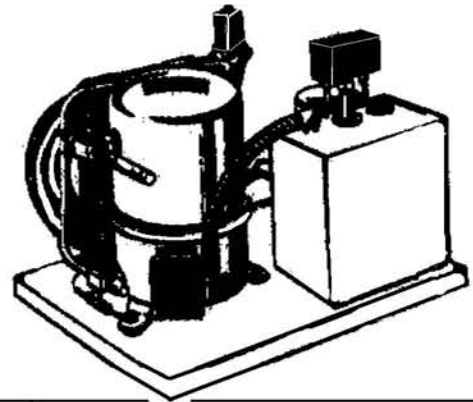

COPELAND REFRIGERATION CONDENSING UNITS

CAT.#	MODEL	HP	TEMPERATURE	RECEIVER TANK	VOLTS/PH	PRICE
A1U0022	M4PH-0022-IAA	1/5	MEDIUM/HST/R404A	NO	115/1/60	\$325.00
A1UH031	M7PH-H031-CAA-121	1/3	MEDIUM/HST/R134A	YES	115/1/60	\$395.00
A1U0056-2	M2FH0056IAV-27	1/2	MEDIUM/HST/R134A	YES	230/1/60	\$625.00

MEDIUM TEMPERATURE R-134a UNITS

Cat.#	HP	Volts/Hz/Ph	Refrigerant	Price ea.
A1C55	3/4	115/60/1	12 or R-134a	\$ 1095.00
A1C871	3/4	230/60/1	12 or R-134a	1095.00
A1C903	1	230/60/1	12 or R-134a	1250.00
A1C861	1-1/2	230/60/1	12 or R-134a	1895.00
A1C862	2	230/60/1	12 or R-134a	1995.00
A1C863	3	230/60/1	12 or R-134a	2995.00

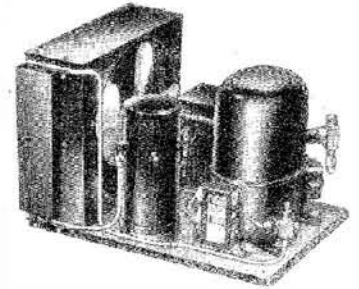

LOW TEMPERATURE R-404a UNITS

A1C988	3/4	230/60/1	R-404a	\$ 1095.00
A1C989	1	230/60/1	R-404a	1250.00
A1C990	1-1/2	230/60/1	R-404a	1895.00
A1C991	2	230/60/1	R-404a	1995.00
A1C992	3	230/60/1	R-404a	3395.00

CAT.# OUTDOOR1- \$200.00
FAN CONTROL & CRANKCASE HTG
INSTALLED

MEDIUM TEMPERATURE R-404a OR R-22 UNITS

A1C1002	3/4	115/60/1	R-404a-22	\$ 1095.00
A1C902	3/4	230/60/1	R-404a-22	1095.00
A1C904	1	230/60/1	R-404a-22	1250.00
A1C905	1-1/2	230/60/1	R-404a-22	1895.00
A1C906	2	230/60/1	R-404a-22	1995.00
A1C907	3	230/60/1	R-404a-22	2995.00
A1C976	5	230/60/1	R-404a-22	3395.00

TECUMSEH COMPRESSOR MODEL AZA1316YXA

1/16HP 115V R134A LOW TEMP
LOW TORQUE FOR CAP TUBE WITH
ELECTRICAL & POE OIL

CAT.# F541316 \$65.00 each

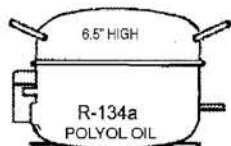

TECUMSEH COMPRESSOR MODEL AEA0422EXA

1/3HP 115V R22/R404A MEDIUM TEMP
LOW TORQUE FOR CAP TUBE WITH
ELECTRICAL & POE OIL

CAT.# F540422 \$175.00 each



TECUMSEH COMPRESSOR MODEL AEA0430EXA

1/2HP 115V R22/R404A MEDIUM TEMP
LOW TORQUE FOR CAP TUBE WITH
ELECTRICAL & POE OIL

CAT.# F540430 \$220.00 each

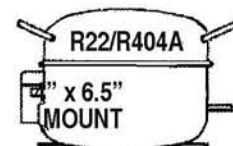

Tecumseh Rotary Compressor
Model RGB5472EXA
3/4 HP 115/1/60

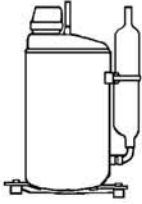

3 leg mount

7200 BTU @ 45°F for R-22
 With overload, cover and oil charge
Cat.# F6903 \$65.00 each

Roto-Rex Rotary Compressor
Model C101B026
3/4 HP 115/1/60

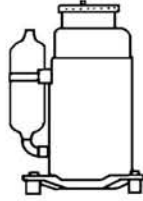

3 leg mount

10,000 BTU @ 45°F for R-22
 With overload, cover and oil charge
Cat.# F681105 \$70.00 each

Samsung Rotary Compressor
Model 44A083HW
3/4 HP 115/1/60

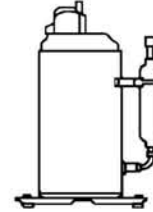

3 leg mount

8000 BTU @ 45°F for R-22
 With overload, cover and oil charge
Cat.# F681071 \$60.00 each

Samsung Rotary Compressor
Model 48A102HV
3/4 HP 115/1/60

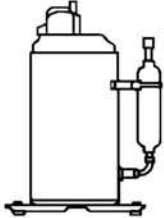

3 leg mount

10,000 BTU @ 45°F for R-22
 With overload, cover and oil charge
Cat.# F681082 \$99.00 each

L-G Rotary Compressor # QKI45CGJ
10,000 BTU 115/1/60



3 leg mount

10,000 BTU @45°F for R-22
 With overload, cover and oil charge
Cat.# FQK145 \$99.00 each

Matsushita Rotary Compressor # 2P16S3R126B
10,735 BTU 115/1/60



3 leg mount

10,000 BTU @45F for R-22
 With overload, cover and oil charge
Cat.# F682P16 \$135.00 each

Tecumseh Rotary Compressor # RGA5492EXA
9,200 BTU 115/60/1

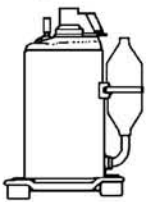

3 leg mount

9,200 BTU @45°F for R-22
 With overload, cover and oil charge
Cat.# F545492 \$99.00 each

Tecumseh Rotary Compressor # RGA5490EXD
9000 BTU R22 230/1/60



6"-3 leg mount

9000 BTU @45F for R-22
 With overload, cover and oil charge
Cat.# F545490D \$149.00 each

TOSHIBA ROTARY COMPRESSORS FOR R410A MINI-SPLIT A/C'S DC FOR INVERTER SYTEMS

CAT.#	MODEL	BTU	VOLTAGE	PRICE
F13DA150	DA150A1F	15,000	DC171V 120Hz	\$195.00
F13DA220	DA220A2F	22,000	DC200V 120Hz	\$275.00
F13DA330	DA330A2F	35,000	DC197V 120Hz	\$295.00
F13DA422	DA422A3F	46,000	DC173V 120Hz	\$350.00



Panasonic Rotary Compressor
Model 5KD240XAC21
2 HP 280V DC R410a



7.5" X 7.5" Square Mount

24,000 BTU @45F FOR R410a
 for inverter style mini-split a/c systems
 with cover, rubber feet and POE oil
Cat.# A2C5KD24 \$250.00 each

Panasonic Rotary Compressor
Model 5JD420XAC22
3-1/2 HP 280V DC R410a



7.5" X 7.5" Square Mount

42,000 BTU @45F FOR R410a
 for inverter style mini-split a/c systems
 with cover, rubber feet and POE oil
Cat.# A2C5JD42 \$295.00 each

Samsung Rotary Compressor
Model UG5A290INZJ2
2-1/2 HP 230/1/60 R410a



6" TRIANGLE 3 LEG MOUNT

29,000 BTU @45F FOR R410A
 With cover and POE oil charge
Cat.# A2C290 \$190.00 each

SECOP 1/4HP 115V R404A LOW TEMP COND. UNIT
 800 BTU @-10F R404A
 LOW TEMP-HIGH TORQUE
CAT.# A1U45CLX
\$385.00 each

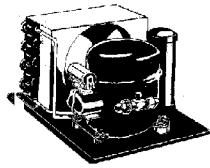

High starting torque, with receiver tank, suction and liquid service valves.

TECUMSEH MODEL AEA2413YXA 1/3HP
 115V R134A LOW TEMP
 CAP TUBE CONDENSING UNIT
 NO RECEIVER TANK.

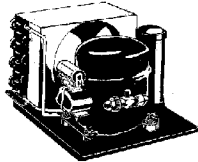

CAT.# F54U2413Y
\$395.00 each

18.5" D x 10.5"W x 10" H

SECOP CONDENSING UNIT 1/4HP 115V
 R134A MEDIUM TEMP HIGH TORQUE
 NO RECEIVER TANK WITH HIGH AND
 LOW SIDE SERVICE VALVES
MODEL UNF9FX

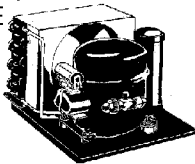

CAT.# A1C936 \$375.00 each

H-V SUPERIOR GLOBE CHECK VALVE 1-1/8" ODF

Cat.# F54806C Superior Model 806C-11S
\$69.00 ea.

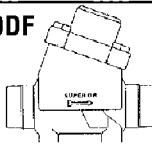

Horizontal or Vertical installation. Working pressure 500 psig. All brass construction, seat material teflon. Special non-metallic bonnet gasket. service temperature 400°F. Low pressure Y design.

FASCO DRAFT BOOST MOTOR 115V WITH CENTRIFUGAL SWITCH

1/40 HP 115/60/1 3,000 RPM
 Shaded Pole Motor-1.1 Amp-
 Shaft: 1/4" Dia. x 1" Long-
 Rotation: CW Lead End-Body Dia.
 3.3" x 4-7/8" Long-Mount:
 Tri-Angle 3-7/8" Centers-
 Centrifugal Safety Switch Pilot
 Duty 24V AC-Thermally Protected.

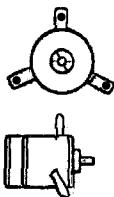

Cat.# F87121 Fasco Model 7121-578 \$29.00 ea.

UNIVERSAL PSC BLOWER / FAN MOTOR

LENNOX NO. E7033949
 1 HP 115/60/1 4/SPEED 1075 RPM
 SINGLE SHAFT 4" LONG x 5/8" OD
 ROTATION CCW LEAD END
 BELLY BAND MOUNT
 WITH RUN CAP
 5-5/8" BODY DIAMETER

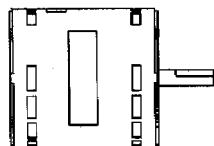

NEW LOW PRICE!!

Cat.# F903949 \$45.00 ea.

1/2 HP 230V R-134A ASPERA COMMERCIAL TEMPERATURE CONDENSING UNIT FOR EXPANSION VALVE

Air cooled unit. High starting torque, complete with service valves, receiver tank, and starting parts. No Low pressure control.

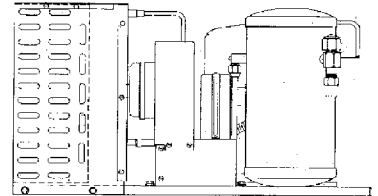

MODEL T6217Z
Cat.# A1C54230
\$625.00 each

3/4 HP 115V R404A MODEL USC15MLX MEDIUM TEMPERATURE CONDENSING UNIT FOR EXPANSION VALVE 5100 btu@20F

Air cooled unit. High starting torque, complete with service valves, receiver tank, and starting parts. Low pressure control.

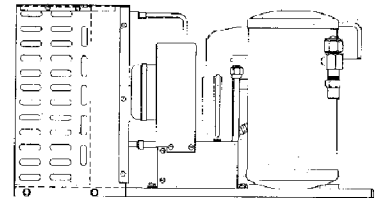

MODEL USC15MLX
Cat.# A1C1002
\$1095.00 each

JOHNSON CONTROLS AIR HANDLER-EVAPORATOR FOR 10 AND 12 SEER AIR CONDITIONING UNITS. VERTICAL OR HORIZONTAL POSITIONS. FOR R-22 OR R-410 GAS

Insulated cabinet to control sound and condensation-direct drive multi-speed motor. Built-in "A" coil-Horizontal and Vertical drain pans, with secondary drains. Can be located in a closet, utility room, crawl, space or basement. Blower motor 230/60/1. For R-22 or R-410 gas.

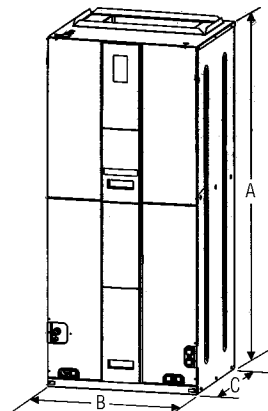

NEEDS EXPANSION VALVE

WHEN ORDERING SPECIFY REFRIGERANT FOR R-22 or R-410a

48D 48,000 BTU

230/60/1 BLOWER MOTOR

Cat.#	MODELS	Dimensions Inches			Price Each
		A Height	B Width	C Depth	
A1B48D	4 TON 48D	57	24.5	22	\$400.00

**TOTALLY ENCLOSED CONDENSER FAN UNIT BEARING MOTORS
16 WATT THRU 50 WATT 1550 RPM 230V 60HZ 1/PH**

Cat.#	Watts	Rotation	Shaft Dimensions	Price Each
28821	16	CW	1/4" x 20 Thread	\$ 65.00
28021	35	CW	1/4" x 20 Thread	119.00
28041	50	CW	3/8" x 1-1/2" Long	135.00

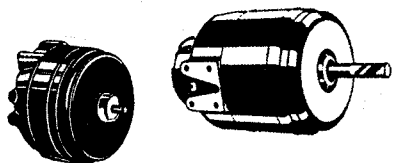

**TOTALLY ENCLOSED CONDENSER FAN UNIT BEARING MOTORS
MOTORS 2 WATTS THRU 16 WATT 1550 RPM 115V 60HZ**

Cat.#	Watts	Rotation	Shaft Dimensions	Price Each
28109	2	CW	1/4" x 20 Thread	\$ 35.00
28411	9	CW	1/4" x 20 Thread	45.00
28811	16	CW	1/4" x 20 Thread	65.00
28020	35	CW	1/4" x 20 Thread	119.00
28040	50	CW	3/8" x 1-1/2" Long	135.00

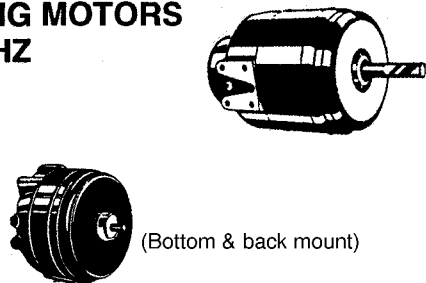

(ROTATION VIEWED END OPPOSITE SHAFT)

**PACKARD 1/6 HP 208-230V
CONDENSER FAN MOTOR**

Totally Enclosed Body
1550 RPM Reversible Rotation
Shaft: 1/2" Dia. x 6" Long
Short Body-5-5/8" Body Dia.
All Angle Mounting
With Mounted Run Cap.

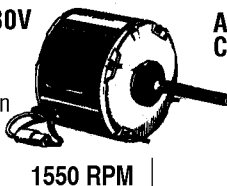

1550 RPM

**A.O. SMITH 1/4 HP 208-230V
CONDENSER FAN MOTOR**

Totally Enclosed Body
1075 RPM Reversible Rotation
Shaft: 1/2" Dia. x 6" Long
Short Body-5-5/8" Body Dia.
All Angle Mounting
PSC Motor Capacitor Required.
Capacitor Extra:
5 MFD x 37V \$2.95 ea.

Cat.# A1M40265 \$135.00 each

Cat.# FE1026SB \$125.00 ea.

EVAPORATOR MOTOR 2/SHAFT 115V

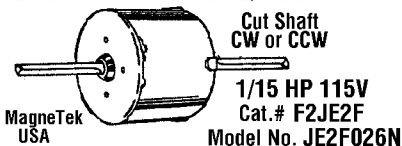

MagneTek
USA

Cut Shaft
CW or CCW

1/15 HP 115V
Cat.# F2JE2F
Model No. JE2F026N

\$18.95 ea.

PSC Evaporator Fan Motor.
2/Shafts: 5/16" diameter x 1-1/2" x 1-1/2" long
2/Speed: 1230/950 RPM Belly Band Mount.
Body Diameter: 3-1/2"
Capacitor extra 7.5 mfd x 370V \$3.95 ea.

**EMERSON EVAPORATOR
MOTOR 1/2HP 115V 48 FR**
MODEL K55HXL5F-0226
1075 RPM/5 SPD CW SHAFT END
2-3/4" LONG 1/2" DIA SHAFT
WITH RUBBER END RINGS

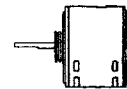

RUN CAP EXTRA POC7.5 \$3.95 EACH

CAT.# F330226 \$59.00 EACH

**G.E. EVAPORATOR DIRECT DRIVE
FAN & BLOWER MOTORS
BELLY BAND MOUNT-48 FRAME
230 VOLT
1/PH 60Hz**

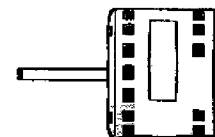

GE MOTOR MODEL 5KCP39RGU052S

CARRIER NO. HC52AE209

1 HP 230/1/60 3-SPEED 1075 RPM-
SINGLE SHAFT-SIZE 4" X 1/2"-CW FACING SHAFT-

Cat.# F90052S \$59.00 each

GE MOTOR MODEL 5KCP39SGU500BS

CARRIER NO. 113219

1 HP 460/3/60 4-SPEED 1075 RPM-
SINGLE SHAFT-SIZE 4" X 5/8"-CW FACING SHAFT-

Cat.# F900BS \$59.00 ea. 460 VOLT 3/PHASE

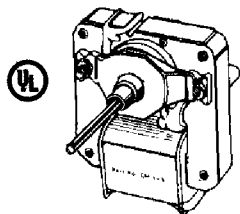

Cat.# A1M1733
\$9.95 ea.

**DOMESTIC EVAPORATOR FAN MOTOR KIT
115V 60HZ**

Replacement evaporator motor for: Admiral-Amana-Coldspot-
Frigidaire-General Electric-Hot Point-Westinghouse-Norge-
Whirlpool. Heavy duty fan motor, oversized oil reservoir.
Dimensions: 2-5/8" High x 1-1/2" wide.
Shaft Size: 1-1/4" Long x 1/8" Diameter.
Mounting: Rubber Tip Hang Mounts.

One 4" Dia. Fan Blade Included.

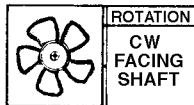

ROTATION
CW
FACING
SHAFT

EMERSON BLOWER MOTOR 1/5 HP 230/60/1



Model K55HXSL
SHAFT SIZE: 1/2" OD X 4.5" LONG
2/SPEED 1075 RPM CW FACING
SHAFT END.

Free 5 MFD/370V Run Cap. Cat.# A1M8851 \$24.95 ea.

**EMERSON BLOWER/EVAP
MOTOR 1/2 HP 230/60/1**

Model K55HXHTC SHAFT SIZE:
1/2" OD X 4.5" LONG 2/SPEED
1075 RPM CW FACING SHAFT END.

Cat.# A1M8866 \$50.00 each

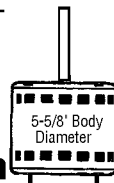

**COMMERCIAL TEMPERATURE AIR COOLED CONDENSING
UNIT 1/3 HP 115V 60 HZ 1/PH 4,000 BTU
HIGH TORQUE FOR EXPANSION VALVE OR CAP TUBE**

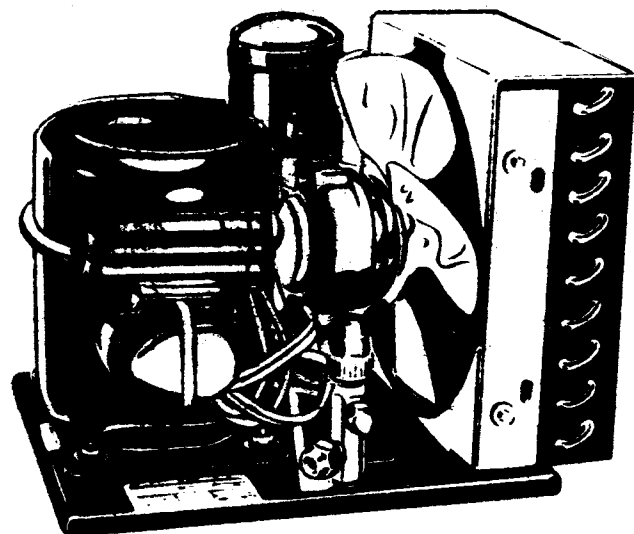

**\$395.00
Each**

HIGH STARTING TORQUE AIR COOLED CONDENSING UNIT FOR EXPANSION VALVE OR CAPILLARY TUBE APPLICATION* UNIT COMPLETE WITH LIQUID RECEIVER TANK, HIGH SIDE AND LOW SIDE SERVICE VALVES, AND ALL ELECTRICAL STARTING COMPONENTS.

**Remove receiver tank for capillary tube application.*

#A1C938 1/3HP 115V 60HZ R404A/R22 POE OIL
#A1C931 1/3 HP 115V 60HZ MINERAL OIL REFG-12
#A1C932 1/3 HP 115V 60HZ ALKY-BENZINE OIL
#A1C933 1/3 HP 115V 60HZ POLY-ESTER OIL

**COMMERCIAL TEMPERATURE AIR COOLED CONDENSING UNIT 1/4 HP 115V 60 HZ 1/PH 3,100 BTU
FOR CAPILLARY TUBE APPLICATION**

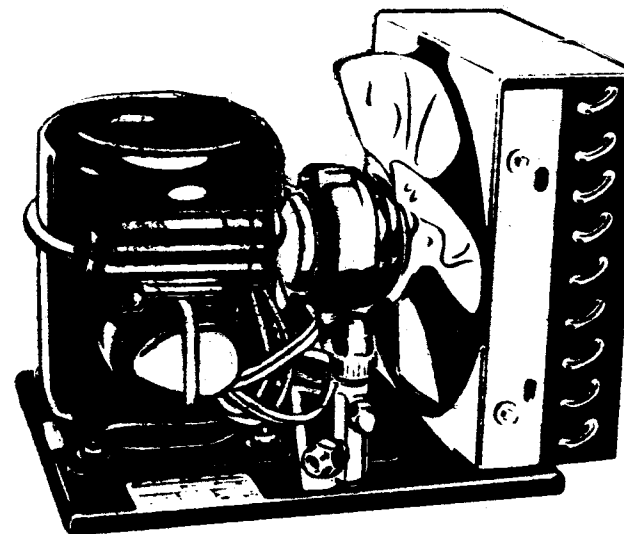

**\$375.00
Each**

LOW STARTING TORQUE FOR CAPILLARY TUBE APPLICATION. WITH STARTING COMPONENTS AND HIGH SIDE LIQUID LINE DRIER WITH 1/4" SAE ACCESS CHARGING PORT.

#A1C937 1/4 HP 115V 60HZ R404A/R22 POE OIL
#A1C934 1/4 HP 115V 60HZ MINERAL OIL REFG-12
#A1C935 1/4 HP 115V 60HZ ALKY-BENZINE OIL
#A1C936 1/4 HP 115V 60HZ POLY-ESTER OIL

CALL TOLL FREE 800-445-1281

Toll Free Phone: 800-445-1281 Phone: 773-247-8842 www.coldparts.com

PACKARD 3-3/8" EVAPORATOR MOTORS REPLACEMENT FOR-BOHN-LARKIN-CLIMATE CONTROL
 1 SPEED 1550 RPM FRAME 3.3" DIA. 5/16" SHAFT X 3" LONG. 4 MOUNTING STUDS ON FRONT AND BACK. CW ROTATION FACING SHAFT.
CAT.# 41124 1/15HP 115V \$79.00 ea.
CAT.# 41126 1/15HP 230V \$79.00 ea.

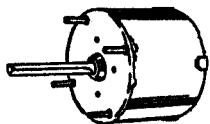

GENERAL PURPOSE 3-3/8" BODY DIAMETER MOTORS

Fasco Ball Bearing split phase motor. Model 7173-0396. 1/20 HP 120V 4/Bolt/Belly band Mt. 1/Shaft 5/16" Dia. x 2-1/4" long. CCW rotation facing shaft. 3/Speed 1550/1300/1000 RPM.
Cat.# F20717 \$24.00 ea.

TOTALLY ENCLOSED

REACH-IN UNIT SLOPE FRONT EVAPORATORS FOR 115V COMMERCIAL TEMPERATURE UNITS

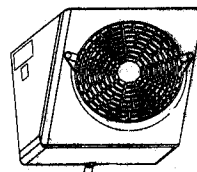

Peerless Model SF-175

Unit coolers are ideal for refrigerated reach-ins. Mounts to top of refrigerator and discharges cold air against back wall.

1/2 HP 115V 4,500 BTU @25° F evap temperature. High 9"-Wide 17"- Deep 14"

Cat.# F78SF175 \$275.00 ea.

EMBRACO CONDENSING UNIT 1/2 HP R134A 230V MODEL T6217Z

CAT.# A1C54230 \$625.00 each
 1/2 HP 230V R134A/R12 MEDIUM TEMP HIGH STARTING TORQUE WITH RECEIVER TANK, SUCTION AND LIQUID SERVICE VALVES, POE OIL CHARGE

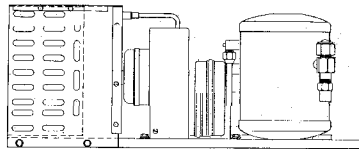

SECOP CONDENSING UNIT 3/4HP R404A 115V MED. TEMP MODEL USC15MLX

CAT. # A1C1002 \$1095.00 each

HIGH STARTING TORQUE WITH RECEIVER TANK, SUCTION AND LIQUID SERVICE VALVES, POE OIL CHARGE WITH LOW PRESSURE CONTROL

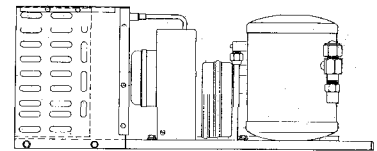

SECOP CONDENSING UNIT 1/2 HP 115V R134A MBP MODEL USC18G
CAT.# A1C54 \$625.00 each
 R134A MEDIUM TEMP HIGH STARTING TORQUE WITH RECEIVER TANK, 1/2" SWEAT SUCTION, 1/4" SWEAT LIQUID SERVICE VALVE

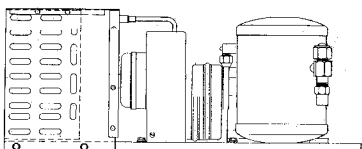

SECOP CONDENSING UNIT 1/2 HP 230/1/60 R404A MBP MODEL USC12CLX-2
CAT.# A1USC12CLX-2 \$625.00 each
 R404A MEDIUM TEMP HIGH STARTING TORQUE WITH RECEIVER TANK, 1/2" SWEAT SUCTION, 1/4" SWEAT LIQUID SERVICE VALVE

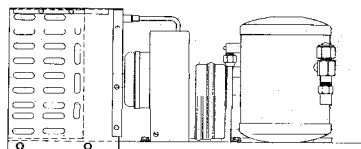

SECOP CONDENSING UNIT MODEL UTF4CLX 1/5HP 115V R404A L-MBP
CAT.# A1UTF4CLX \$295.00 each
 R404A L-MBP HST FOR CAP TUBE NO RECEIVER TANK

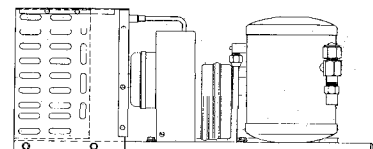

SECOP CONDENSING UNIT MODEL UTFS4.5CLX 1/4HP 115V
CAT.# A1U45CLX \$385.00 each
 1/4 HP 115V R404A MEDIUM TEMP HIGH STARTING TORQUE WITH RECEIVER TANK, SUCTION AND LIQUID SERVICE VALVES, POE OIL CHARGE

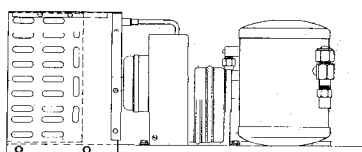

SECOP CONDENSING UNIT MODEL UNF11FX 1/3HP 115V R134A
CAT.# A1C933 \$395.00 each
 1/3 HP 115V R-134a/R-12 M/H TEMP HIGH STARTING TORQUE WITH RECEIVER TANK, SUCTION AND LIQUID SERVICE VALVES, POE OIL CHARGE

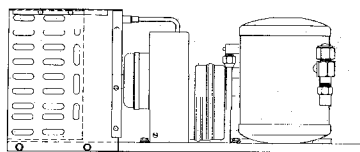

SECOP CONDENSING UNIT MODEL UNF7CLX 1/3HP 115V R404A L-MBP
CAT.# A1UNF7CLX \$395.00 each
 1/3 HP 115V R404A MEDIUM TEMP HIGH STARTING TORQUE WITH RECEIVER TANK, SUCTION & LIQUID SERVICE VALVES, POE OIL CHARGE

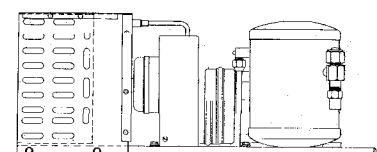

KLIXON RELAYS PUSH-ON TYPE FOR REFRIGERATOR COMPRESSORS 115V

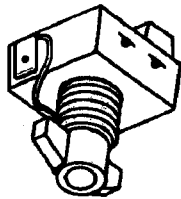

Low back pressure compressors no capacitor connection

\$5.95 each

Cat.#	Part No.	H.P.
A1E119	PR18	1/8
A1E120	PR16	1/6
A1E121	PR15	1/5
A1E122	PR14	1/4
A1E123	PR13	1/3

KLIXON OVERLOAD PROTECTORS PUSH-ON TYPE FOR REFRIGERATOR COMPRESSORS 115V

TYPE MRA 3/4" OVERLOAD PROTECTORS FOR REFRIGERATOR COMPRESSORS.



\$5.95 each

Cat.#	Part No.	H.P.
A1E200	018P	1/8
A1E201	016P	1/6
A1E202	015P	1/5
A1E203	014P	1/4
A1E204	013P	1/3

RBM RELAY SPST 24V COIL 129515-3180ZL

1 HP 125V/2 HP 230V 18 LRA. Used to control blower motors in furnaces and air conditioners. Fits 1/2" hole in all type of electrical boxes.
Cat.# F98824 \$7.95 ea.



WHITE-RODGERS 1609-101 TEMPERATURE CONTROL

White-Rodgers 1609 refrigeration temperature control easily adjusted with screw driver. Hydraulic action element provides close differential control, positive accuracy at any temperature on dial range. All position mounting. Range -30 deg. F. to +90 deg. F. With adjustable differential 3 deg. to 40 deg. F. 5 ft. capillary tube, sensor bulb 3/8" OD x 5-3/4" long.

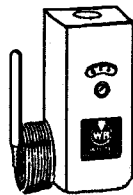

Cat.# A1T975
\$89.00 ea.

G.E. CURRENT RELAY

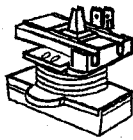

3ARR12-KPM71
CAT.# F5412
\$6.95 each

- 1/4 HP - 1/3 HP
- 115V W/Capacitor connection
- Screw-on terminals
- Tecumseh #P82473

For models- AEA2410YXA-AXA / AEA2411ZXA AEA2415AXA / AEA2416JXA / AEA4448YXA-AXA AEA2413YXA-AXA / AEA9422EXA-ZXA AND SIMILAR ASPERA AND COPELAND COMPRESSORS.

G.E. CURRENT RELAY

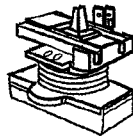

3ARR12-PL22
CAT.# F5413
\$6.95 each

- 1/3 HP
- 115V W/Capacitor connection
- Push-on terminals
- Tecumseh #P82929

For models- AEA1413YXA-AXA / AEA3440YXA-AXA AEA4440YXA-AXA AND SIMILAR ASPERA AND COPELAND COMPRESSORS

DOMESTIC-COMMERCIAL COMPRESSOR RELAY AND OVERLOAD KITS 115 VOLTS
\$8.95 each kit

Cat.#	HP
A118	1/8
A116	1/6
A115	1/5
A114	1/4
A113	1/3

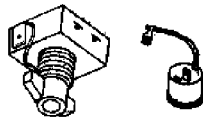

FOR LOW STARTING TORQUE COMPRESSORS NO CAPACITOR

KLIXON PUSH-ON SOLID STATE PTC RELAY FOR REFRIGERATION COMPRESSORS 115 VOLT 1/20 HP TO 1/3 HP

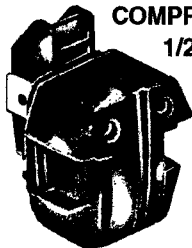

3/ TERMINALS
Cat.# F1920
\$9.95 each

PLASTIC MOTOR START CAPACITOR

Cat.# F98165 233-280 MFD x 165V

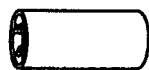

\$2.50 ea.

Cat.# F98270 270-324 MFD x 165V

4TM TYPE KLIXON COMPRESSOR OVERLOAD PROTECTOR 1/4HP #762 115V

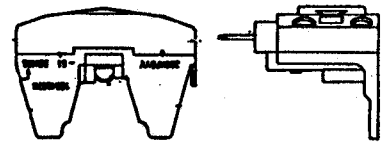

Does not require special bracket to mount. Push-on to common pin terminal of compressor. New type compressor motor protector. Compressor protector for refrigerators, freezers, vending machines. Compatible with current copper wire mechanical relays and PTC starter relays.

Cat.# F41414 Box of 6 pcs. \$14.00 ea.
Cat.# F41415 Box of 12 pcs. \$22.00 ea.

ESSEX HEAVY DUTY 30 AMP CONTACTOR

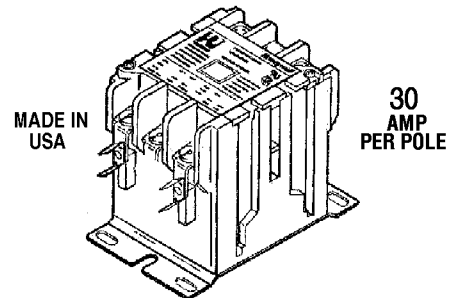

MADE IN USA

30 AMP PER POLE

30 AMP FLA PER POLE - 35AMP RES
24 VOLT AC COIL 50/60 / 2POLES
PUSH-ON OR SCREW CONNECTIONS
Cat.# F1370
\$12.95 each

MOTOR RUN METAL CASE CAPACITORS NON-PCB

70 / 7.5 MFD
X
440 VOLT

Cat.# F1369
\$9.95 ea.

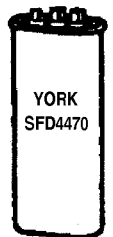

4TM TYPE KLIXON COMPRESSOR OVERLOAD PROTECTOR 1/5 HP #319 115V

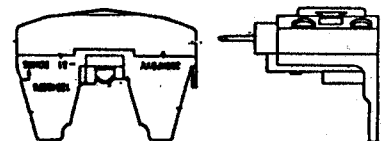

Does not require special bracket to mount. Push-on to common pin terminal of compressor.

New type compressor motor protector. Compressor protector for refrigerators, freezers, vending machines. Compatible with copper wire mechanical relays and PTCR starter relays.

Cat.# A1E319 Box of 3 pcs. **\$8.95**

TECUMSEH REFRIGERATION CONDENSING UNITS

CAT.#	MODEL	HP	TEMPERATURE	RECEIVER TANK	VOLTS/PH	PRICE
F54U2413Y	AEA2413YXA	1/3	LOW/HST/R134A	NO	115/1/60	\$ 395.00
F54U9428E	AKA9428ZXA	+1/3	MEDIUM/HST/R22/R404A	YES	115/1/60	\$ 595.00
F54U2445A	AHA2445AXF	1	LOW/HST/R134A	YES	230/3/60	\$ 1250.00

RANCO STYLE BEVERAGE WATER COOLER CONTROL TYPE K50-P1127 WITH DIAL FACE PLATE AND KNOB

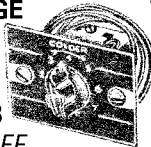

BUY 6 ASSORTED GET 1 FREE
Type K50 replaces type "A" controls. Complete with Dial face plate and dial knob. Positive OFF position. Capillary 42" long, 2-1/8" mounting hole centers. Spade push-connections.
Cold-Out +34F Warm-In +54F
Cold-In +41F

Cat.# A1981 K50-P1127 \$15.95 ea.

RANCO STYLE REFRIGERATOR CONTROL TYPE K50-P1125 WITH DIAL FACE PLATE AND KNOB

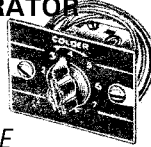

BUY 6 ASSORTED GET 1 FREE
Type K50 replaces type "A" controls. Complete with Dial face plate and dial knob. Positive OFF position. Capillary 42" long, 2-1/8" mounting hole centers. Spade push-connections.
Cold-Out 0F Warm-In +47F
Cold-In +15F

Cat.# A1979 K50-P1125 \$15.95 ea.

RANCO STYLE FREEZER CONTROL TYPE K50-P1126 WITH DIAL FACE PLATE AND KNOB



BUY 6 ASSORTED GET 1 FREE
Type K50 replaces type "A" controls. Complete with Dial face plate and dial knob. Positive OFF position. Capillary 42" long, 2-1/8" mounting hole centers. Spade push-connections.
Cold-Out -12F Warm-In +15F
Cold-In 0F

Cat.# A1980 K50-P1126 \$15.95 ea.

EVAPORATOR MOTOR 2/SHAFT 115V

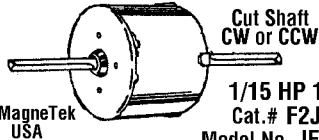

1/15 HP 115V
Cat.# F2JE2F
Model No. JE2F026N
\$16.95 ea.

PSC Evaporator Fan Motor.
2/Shafts: 5/16" diameter x 1-1/2" x 1-1/2" long
2/Speed: 1230/950 RPM Belly Band Mount.
Body Diameter: 3-1/2"
Capacitor extra 7.5 mfd x 370V \$3.95 ea.

3/4 HP 230V R134A COPELAND MEDIUM TEMPERATURE CONDENSING UNIT FOR EXPANSION VALVE

Air cooled unit. High starting torque, complete with service valves, receiver tank, and starting parts.
Low pressure control.

MODEL UZS09
Cat.# A1C871
\$1095.00 each

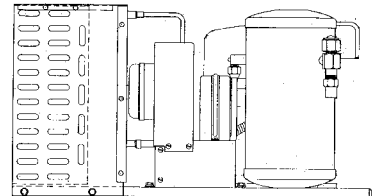

EMERSON BLOWER/EVAP MOTOR 1/2 HP 230/60/1

Model K55HXHTC SHAFT SIZE:
1/2" OD X 4.5" LONG 2/SPEED
1075 RPM CW FACING SHAFT END.

Cat.# A1M8866 \$59.00 ea.



NYLON SAND SCREEN 1-1/2" x 30" ROLL

Cat.# 18X60 \$2.50 ea.



Sand Screen is superior to sand cloth for cleaning copper surface prior to brazing or soldering. An open nylon screen-like material with abrasive on both sides. Won't break down or clog up like paper or cloth materials.

1/2 HP 230V R-134A ASPERA COMMERCIAL TEMPERATURE CONDENSING UNIT FOR EXPANSION VALVE

Air cooled unit. High starting torque, complete with service valves, receiver tank, and starting parts.
No Low pressure control.

MODEL T6217Z-2
Cat.# A1C54230
\$625.00 each

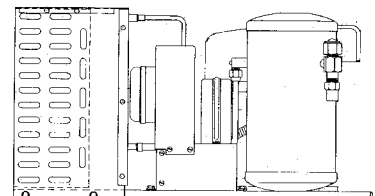

EVAPORATOR REPLACEMENT MOTOR FOR HEATCRAFT-BOHN-CHANDLER-LARKIN-CLIMATE CONTROL. SLEEVE BEARING 1/15 HP-3" LONG SHAFT

Replacement for walk-in cooler evaporator fans. - Low Amp Draw Motor-
Low Temp Lub System- Frame 3.3" UL Class B Insulation- 40°C Amb.
1 Speed-1550 RPM- 5/16" Shaft X 3" Long.

CW ROTATION
FACEING SHAFT

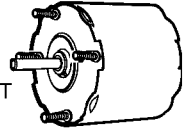

Cat.# 41124 PACKARD 1/15 HP 115V \$ 79.00 each
Cat.# 41126 PACKARD 1/15 HP 230V \$ 79.00 each

GE PSC FAN AND BLOWER MOTOR

1/3 HP 230V 1/PH 60HZ
GE # 5KCP39HG143S

Carrier # 1081398
1/Shaft: 1/2" diameter x 5" Long
3/ Speed:1075/950/800 Belly Band Mount
CCW rotation facing shaft
Run cap extra 7.5 mfd x 370V \$3.95 ea.
Cat.# F90143S \$39.00 each

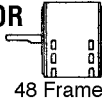

G.E. CONDENSER MOTOR 1/8 HP 230/60/1
CARRIER NO. H36GE238A
TOTALLY ENCLOSED
800 RPM 48 FRAME
SHAFT SIZE: 1/2" OD X 3" LONG.
CCW FACING SHAFT END

Cat.# F90084S GE# 5KCP39GFY084S \$25.95 ea.



GE PSC FAN AND BLOWER MOTOR

1/4 HP 230V 1/PH 60HZ
GE # 5KCP39KG164AS

Carrier # 1082061
1/Shaft: 1/2" diameter x 4" Long
3/ Speed:1075/950/800 Belly Band Mount
CCW rotation facing shaft
Run cap extra 7.5 mfd x 370V \$3.95 ea.
Cat.# F9064AS \$39.00 each

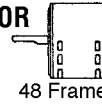

EMERSON FAN COIL BLOWER MOTOR
1/60 HP 29 FRAME

Model K48HXCSJ-1662
2/ Speed: 950/800 RPM 5" Body Dia.
2/Shaft: 1/2" diameter x 6" x 6" long.
Rubber ring mount.
Run capacitor extra 5 mfd x 370V \$2.95 ea.
Cat.#F33166 \$10.00 each

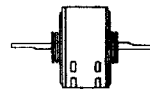

GE CONDENSER FAN MOTOR
1/2 HP 230V 1/PH 60HZ

GE # 5KCP39JGN811AS
Carrier # HC43VL600B
1/Shaft: 1/2" diameter x 3" Long
1/ Speed:1075 RPM Belly Band Mount
CW rotation facing shaft
Run cap extra 7.5 mfd x 370V \$3.95 ea.
Cat.# F9011AS \$59.00 each

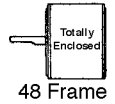

GE NO. 5KCP39RGU052S
CARRIER NO. HC52AE209
1 HP 230/1/60- 3-SPEED1075 RPM
SINGLE SHAFT-SIZE 4" X 1/2" OD
ROTATION: CW FACING SHAFT
Cat.# F90052S \$59.00 each

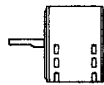

UNIVERSAL PSC FAN & BLOWER MOTOR
3/4 HP 115V
1/PH 60HZ

Model HE3T015N 5-5/8" Body Dia.
4/ Speed:1000/950/850/800 RPM
1/Shaft: 1/2" diameter x 3" long.
CCW rotation facing shaft. Belly band Mt.
Run capacitor extra \$4.25 ea.
Cat.#F1115 \$39.95 each

UNIVERSAL/MAGNETEK PSC FAN & BLOWER MOTOR
1/40 HP 115V 29 FRAME

Model DE3D432N 5" Body Dia.
3/ Speed:1000/910/820 RPM
2/Shaft: 1/2" diameter x 2-1/2" x 1-3/4" long.
CCW Rotation Lug side, 2-1/2" side.
3/Lug mount 6-1/4" centers.
Run capacitor extra 5 mfdx370V \$2.95 ea.
Cat.#F40432 \$10.00 each

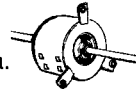

GE FAN AND BLOWER MOTOR
1/2 HP 230V 1/PH 60HZ

GE # 5KCP39MGT382S
1/Shaft: 1/2" diameter x 4" Long
3/Speed : 1075 RPM Belly band mount
CW rotation facing shaft 1/ Speed:1075 RPM
Run cap extra 7.5 mfd x 370V \$3.95 ea.
Cat.# F90382S \$59.00 each

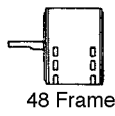

1/2 HP ASPERA T6217Z-2 COMMERCIAL COMPRESSOR

1/2 HP 230V R-134a Hi-Starting Torque
Cat.# F546217Z2 \$325.00 ea.
OD SWEAT

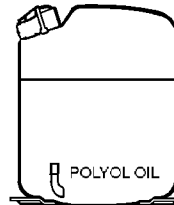

UNIVERSAL HALO MOUNT PSC FAN & BLOWER MOTOR 1/15 HP 115V

NEW LOW PRICE

Model JA2F30N
2/ Speed:1500/1250 RPM
2/Shaft:5/16" diameter x 1-1/2" x 1-1/2" long.
4/stud mount 5-1/4" centers. 3-1/2" Body dia
Capacitor extra 7.5 mfd x 370V \$4.95 ea.
Cat.#F2073 \$9.95 each

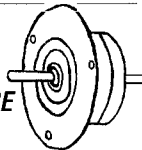

MAGNETEK FLUE EXHUST & DRAFT BOOSTER BLOWER-208/230V 60HZ 1/PH WITH CENTRIFUGAL SHUT-OFF SWITCH

Cat.# F11797
\$42.00 ea.

Model JB1C049NSV 1/40th HP
3,000 RPM. Ball bearing motor,
4" intake -2-1/4" exhaust .

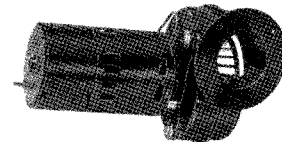

MORRILL CONDENSER FAN MOTOR 230V 6W CW

**51 FRAME (3.3" dia.)
FAN MOTOR 6 WATT
230V CW 1550 RPM**

**Cat. # F3255
\$15.95 ea.**

6 WATT CW



1/4" - 20 Threaded Shaft
All angle operation, with three mounting holes on rear of motor, 2-1/2" on center and rigid foot base mounting. All motors above are CW rotation facing end opposite shaft. Shaft Size: 1/4" threaded - 1/2" long.

POTENTIAL MOTOR STARTING RELAY

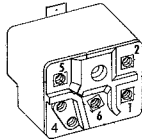

5 Screw Terminals

**Cat.# A1004
\$9.95 each**

Potential relay for 1-1/2-2-3-3-1/2-4-5 HP commercial refrigeration and air conditioning compressors. Replacement potential relay for G.E. 3ARR3 type Mars 64.

EVAPORATOR MOTOR 2/SHAFT 115V

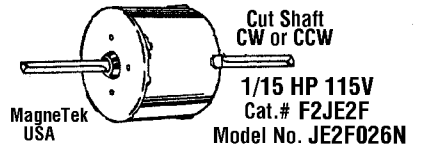

MagTek USA
Cut Shaft CW or CCW
1/15 HP 115V
Cat.# F2JE2F
Model No. JE2F026N
\$16.95 ea.
PSC Evaporator Fan Motor.
2/Shafts: 5/16" diameter x 1-1/2" x 1-1/2" long
2/Speed: 1230/950 RPM Belly Band Mount.
Body Diameter: 3-1/2"
Capacitor extra 7.5 mfd x 370V \$3.95 ea.

RELAY-OVERLOAD-START CAPACITOR HI-TORQUE COMPRESSOR START KIT

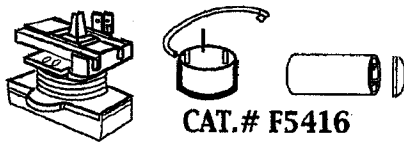

**CAT.# F5416
\$15.95 each Kit**

- 1/3 hp
- 115v w / capacitor connection
- Push-on terminals

For models- AEA2410YXA-AXA / AEA2411ZX
AEA2413YXA-AXA / AEA2415AXA
AEA4448YXA-AXA / AEA9422EXA-ZXA
AEA1413YXA-AXA / AEA3440YXA-AXA
AEA4440YXA-AXA AND SIMILAR ASPERA
AND COPELAND COMPRESSORS.

PARAGON REFRIGERATOR DEFROST TIMER

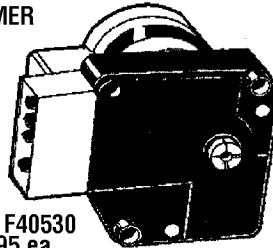

Cycle Time:
8 Hours
Defrost Time:
20 Minutes
Terminals:
2-1-4-3
**Cat.# F40530
\$9.95 ea.**

GENERAL PURPOSE PAN HEAD PHILLIPS SCREWS 8 x 1/2"

For general purpose, sheet metal duct work or appliance repair. Phillips pan head, zinc finish.
Cat.# F33812 \$5.00 each
2 Lb. Bag (608 pcs.)



**Cat.# F33813
5 Lb. Bag (1,520 pcs.) \$10.00 ea.**

SELF-TAPPING SHEET METAL HEX HEAD SCREW 8 x 5/8"

For sheet metal duct work and appliance repair. Head for 1/4" nut driver or screw driver. Anodized zinc finish.

Cat.# F33582 \$5.00 ea.
2 Lb. Bag (550 pcs.)



Cat.# F33585 \$10.00 ea.
5 Lb. Bag (1,375 pcs.)

SAMSUNG ROTARY COMPRESSOR MODEL UG5A290INZJ2

29,000 BTU R410A 208-230/1/60 FOR A/C 6" TRIANGLE MOUNT 17" HIGH WITH POE OIL AND COVER
CAT.# A2C290 \$190.00 each

SPECIAL PRICING
10 LOT \$150.00
40 LOT \$125.00
120 LOT \$100.00

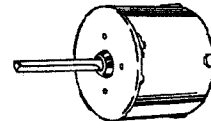

McMillan ball bearing split phase motor. Model # 8224315020 1/20HP 120V 4 bolt front and bottom mount to replace unit bearing type motors. CW facing shaft 5/16" x 1-5/8" long. 3 speed 1550/1300/1000 RPM.

Cat.# F20822 \$24.00

GENERAL PURPOSE PAN HEAD PHILLIPS SCREWS 8 x 5/8"

For general purpose, sheet metal duct work or appliance repair. Phillips pan head, zinc finish.

**Cat.# F33583
2 Lb. Bag (540 pcs.) \$7.50 ea.**



**Cat.# F33584
5 Lb. Bag (1,350 pcs.) \$15.00 ea.**

GENERAL PURPOSE PAN HEAD PHILLIPS SCREWS 8 x 1-1/4"

For general purpose, sheet metal duct work or appliance repair. Phillips pan head, zinc finish.

**Cat.# F33142
2 Lb. Bag (314 pcs.) \$6.50 ea.**



**Cat.# F33145
5 Lb. Bag (785 pcs.) \$13.50 ea.**

GEMLINE-AIR CONDITIONING AND HEATING THERMOSTAT WITH DISCHARGE FEEDBACK MODEL# GC-17 9043

**CAT.# F98GC17
COST \$29.95 each**

RANGE
COOLING 68F TO 77F
HEATING 59F TO 86F

CAPILLARY 36" DUAL AMBIENT BULB
SWITCH 2 S.P.D.T. DIFF. 4F
RATING FLA RLA
240V 20A 80A
277V 16A 60A

FAST HEAVY DUTY 115V COIL CONTACTORS-MADE IN USA

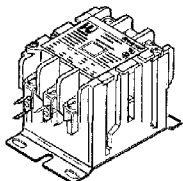

WITH LUG AND 1/4" PUSH-ON CONNECTIONS

CAT.# F9840A 40AMP/2POLE/120V \$10.95 ea.
CAT.# F9850A 50AMP/3POLE/120V \$22.95 ea.
CAT.# F9860A 60AMP/3POLE/120V \$25.95 ea.

SAMSUNG ROTARY COMPRESSORS FOR R410A A/C AND HEAT PUMPS

CAT.#	MODEL	HP	BTU	VOLTS/PH	PRICE
A2C180	UG5T1801NVF2	1 1/2	18,000	230/1/60	\$ 225.00
A2C200	UG5C2001NXJ2	1 3/4	20,000	230/1/60	250.00
A2C220	UG5C2201NWF2	2	22,000	230/1/60	265.00
A2C250	UG5C2501NZJ2	2	25,000	230/1/60	265.00
A2C260	UG5C2601NZF2	2	26,000	230/1/60	265.00
A2C290	UG5A2901NZJ2	2 1/4	29,000	230/1/60	190.00
A2C320	UG5T3201UZF2	2 1/2	32,000	230/1/60	350.00

ALL COMPRESSORS
FOR R410A WITH
INTERNAL OVERLOAD
POE OIL CHARGE &

PANASONIC ROTARY COMPRESSORS FOR R410A MINI-SPLIT A/C'S DC FOR INVERTER SYSTEMS

A2C5KD24	5KD240XAC21	2	24,000	DC 280V	\$ 255.00
A2C5JD42	5JD420XAC22	3-1/2	42,000	DC 280V	295.00

TOSHIBA ROTARY COMPRESSORS FOR R410A MINI-SPLIT A/C'S DC FOR INVERTER SYSTEMS TWIN ROTOR BLDC STYLE COMPRESSORS

F13DA150	DA150A1F-21F1	1-1/2	15,000	DC 171V 120 Hz	\$ 195.00
F13DA220	DA220A2F-23L	2	25,000	DC 200V 120 Hz	275.00
F13DA330	DA330A2F-20M	3	35,000	DC 197V 120 Hz	295.00
F13DA422	DA422A3F-26M	4	46,000	DC 173V 120 Hz	350.00

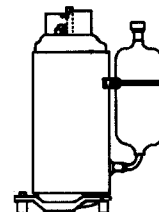

REPLACEMENT THERMOCOUPLE

30" Long
Cat.# F6330 \$4.50 ea.
\$4.25 ea. Lots of 3

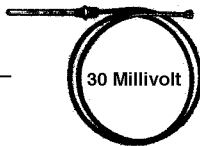

18" Long
Cat.# F6318 \$3.50 ea.
\$3.25 ea. Lots of 3

REPLACEMENT THERMOCOUPLE KITS

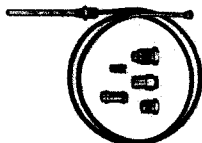

HONEYWELL

Individually packed with 4 adapters. Will replace most makes and styles in the field on 30 millivolt systems.

Cat. No. 42911 24" Long \$ 6.95 ea.
Cat. No. 42021 30" Long 7.50
Cat. No. 42912 36" Long 7.95
Cat. No. 42022 48" Long 8.75

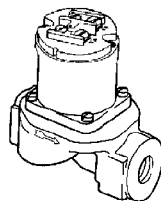

BASO-PENN LP 91 SEIES GAS VALVE

24 VOLT OPERATOR 505,000 BTU

Electrically operated valve
for LP gas. Inlet 1" FIPT x 1" FIPT
Basotrol Part No. 91S5G 36

Cat.# F191S5G \$29.95 ea.

W-R MULTI-STAGE 24V COMFORT SET ELECTRONIC PROGRAMMABLE 5+2 DAY HEATING AND COOLING THERMOSTAT WITH SUB-BASE

For use with standard heat/cool or heat only or cool only systems. For gas, oil, electric heat, millivolt, or zone valve systems. Not for heat pump. Time & room temperature. Battery back-up. Batteries included. Temperature range: 40 deg. F. to 99 deg. F. Up to 3 stage heat - 2 stage cool. System switching: Heat-Off- Auto-Cool-Auto Fan-On. Terminals: C-RH-W-Y-G-MV-6
Cat.# F11002 White-Rodgers No. IF91-71 Tempstar No. 1160591 \$55.00 ea.



HONEYWELL COMBINATION GAS VALVE FOR STANDING PILOT NG MODEL VR8200A-2132 24V UP TO 200,000 BTU. ON-OFF-PILOT 1/2" INLET X 1/2" OUTLET, WITH 3/4" NPT FLANGE. INCLUDES (1) 1/2" x 3/8" BUSHING. (1) KIT NG TO LP GAS

CAT.# A1V8200
\$125.00 each

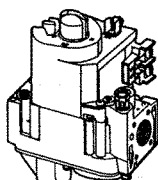

HONEYWELL T8132A ELECTRONIC PROGRAMMABLE THERMOSTAT

Thermostat provides energy savings for heating and cooling applications. 7 day programs. For gas systems, standing pilot, electronic ignition, gas boilers, oil furnace, electric furnace, air conditioning. Not for heat pumps.
Switches: Cool-Off-Heat, Fan-Auto-On.

Cat.# F11109 \$34.00 each Battery Back-Up

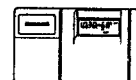

24V AC

W-R COMFORT SET II 24V AC COMFORT SET ELECTRONIC PROGRAMMABLE 5+2 DAY HEATING AND COOLING THERMOSTAT WITH SUB-BASE

For use with standard heat/cool or heat only or cool only systems. For gas, oil, electric heat, millivolt, or zone valve systems. Not for heat pump or 2 stage systems. Battery back-up. Batteries included. Temperature range: 40 deg. F. to 99 deg. F. One stage heat - One stage cool. System switching: Heat-Off- Auto-Cool-Auto Fan-On. Terminals: C-RH-W-Y-G-MV-6
Cat.# F11001 White-Rodgers No. IF90-71 Tempstar No. TAMD001TWO1 \$49.00 ea.

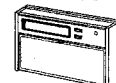

BRISTOL AIR CONDITIONING COMPRESSORS R410A

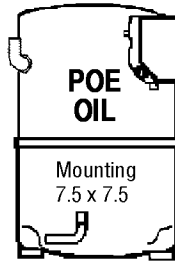

Cat.#	Model	H.P.	BTU	Volts/Ph	Price Ea.
A2CH82J13	H82J133ABCA	1	13,000	230/1/60	\$250.00
A2CH82J18	H82J18BABCA	1-1/2	18,000	230/1/60	\$275.00
A2CH82J21	H82J213ABCA	2	21,000	230/1/60	\$295.00
A2CH82J24	H82J243ABCA	2	24,000	230/1/60	\$295.00
A2CH82J28	H82J283ABCA	2-1/4	28,000	230/1/60	\$325.00
A2CH82B36	H82B363ABCA	3	36,000	230/1/60	\$350.00
A2CH82J37-3	H82J37MDBLA	3	37,000	230/3/60	\$350.00
A2CH82J37-4	H82J37MDBVA	3	37,000	460/3/60	\$350.00
A2CH82J40	H82J403ABCA	3-1/2	40,000	230/1/60	\$375.00
A2CH82J44	H82J443ABCA	3-3/4	44,000	230/1/60	\$400.00
A2CH82J48	H82J483ABCA	4	48,000	230/1/60	\$425.00

BRISTOL AIR CONDITIONING COMPRESSORS R22

A2CH22J44-4	H22J443DBEA-P	3-3/4	44,000	460/3/60	\$450.00
A2CH22A54-4	H22A543DBEA	4-1/2	54,000	460/3/60	\$525.00
A2CH22A62-4	H22A623DBEA	5	62,000	460/3/60	\$695.00
A1C094-4	H2NG094DPEE-S*	7-1/2	94,000	460/3/60	\$1095.00
A2CG094-4	H22G094DBEE-S*	7-1/2	94,000	460/3/60	\$1095.00
A2CG094-3	H92G094GPDE-PR*	7-1/2	94,000	230/3/60	\$1095.00
A2CG104-4	H2BG104DBEE-R*	9	104,000	460/3/60	\$1195.00
A2CG124-3	H22G124DBDE-PS*	10	124,000	230/3/60	\$1295.00
A2CG144-4	H22G144DBEE-S*	12	144,000	460/3/60	\$1395.00
A2CG184-3	H92G184DPDF-PS*	15	184,000	230/3/60	\$1695.00
A2CG244-3	H92G244FRDF-PR*	20	244,000	230/3/60	\$1995.00
A2CG294-3	H22G294FPDF-S*	24	294,000	230/3/60	\$2095.00

P- POE OIL CHARGE

S*- SWEAT CONNECTIONS

R*- ROTO LOCK CONNECTIONS (SET SERVICE VALVES EXTRA \$250.00)

**SAMSUNG ROTARY
COMPRESSOR 2-1/2 HP
MODEL UG5A290INZJ2
230/1/60 R410A**

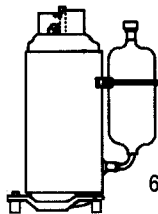

6" TRIANGLE
MOUNT

**29,000 BTU FOR R410A
WITH COVER AND POE OIL
CAT.# A2C290 \$190.00 each**

**EMERSON EVAPORATOR
MOTOR 1/2HP 115V 48 FR
MODEL K55HXLSF-0226
1075 RPM/5 SPD CW SHAFT END
2-3/4" LONG 1/2" DIA SHAFT
WITH RUBBER END RINGS**



RUN CAP EXTRA POC7.5 \$3.95 EACH
CAT.# F330226 \$59.00 EACH

EVAPORATOR MOTOR 2/SHAFT 115V

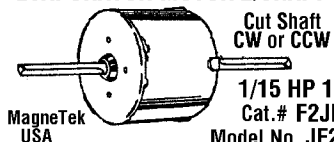

Cut Shaft
CW or CCW

1/15 HP 115V

Cat.# F2JE2F

Model No. JE2F026N

\$16.95 ea.

PSC Evaporator Fan Motor.

2/Shafts: 5/16" diameter x 1-1/2" x 1-1/2" long

2/Speed: 1230/950 RPM Belly Band Mount.

Body Diameter: 3-1/2"

Capacitor extra 7.5 mfd x 370V \$3.95 ea.

G.E. FAN & BLOWER MOTOR
1/8 HP 115V

5KCP39FGM952FS
5-5/8" Body Dia.
3/ Speed: 840/760/675 RPM
2/Shaft: 1/2" dia. x 3-1/4" X 3" long.
CCW rotation facing Mtg. hole side
Mtg. hole radius 6-3/8"
Run cap extra 10 mfd x 370V \$5.95 ea.
Cat.#F4095 **\$20.00 each**

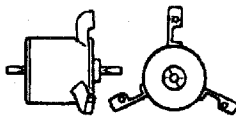

G.E. FAN & BLOWER MOTOR
1/8 HP 230V

Model 5KCP39GGF833S
3/ Speed:1050/930/800 RPM
2/Shaft: 1/2" dia.x 6" x 3-3/4" long.
Body Dia. 5-5/8" 6-1/2" Lug Mtg. Holes
Rotation: CW facing 3/ Lug mounting side
Capacitor extra 5 mfd x 370V \$2.95 ea.
Cat.#F20833 **\$20.00 each**

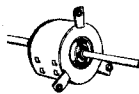

G.E. EVAPORATOR PSC FAN MOTOR

1/3 HP 115V
1/PH 60HZ Carrier# 1081398
Model No.5KCP39HG Y143S
3/ Speed:1075/950/800 RPM
1/Shaft: 1/2" diameter x 5" long
CCW rotation facing shaft
Run cap extra 7.5 mfd x 370V \$3.95 ea.
Cat.# F90143S **\$39.00 ea.**

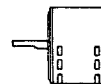

EMERSON PSC FAN & BLOWER MOTOR
1/10 HP 115V

1/PH 60HZ
Model KA55HXECL-679 5-5/8" Body Dia.
3/ Speed:1080/950/800 RPM
2/Shaft: 1/2" diameter x 3" x 3" long.
CCW rotation facing lug mounting side
Run cap 5 mfd x 370V extra \$2.95 ea.
Cat.#F4079 **\$20.00 each**

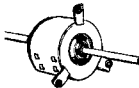

G.E. PSC FAN & BLOWER MOTOR
1/20 HP 230V

5" Body Dia.
Model 5KCP29BK6287S
3/Lug Mount 3/ Speed:1160/1100/900 RPM
2/Shaft: 1/2" diameter x 2-1/2" x 1-1/4" long
CCW rotation facing lug mount side.
Run cap extra 4 mfd x 370V \$2.95 ea.
Cat.#F4087 **\$20.00 each**

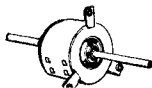

UNIVERSAL/MAGNETEK PSC FAN & BLOWER MOTOR
1/40 HP 115V 29 FRAME

Model DE3D432N 5" Body Dia.
3/ Speed:1000/910/820 RPM
2/Shaft: 1/2" diameter x 2-1/2" x 1-3/4" long.
CCW Rotation Lug side, 2-1/2" side.
3/Lug mount 6-1/4" centers.
Run capacitor extra 5 mfdx370V \$2.95 ea.
Cat.#F40432 **\$20.00 each**

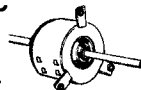

EMERSON PSC FAN & BLOWER MOTOR
1/8 HP 230V

Model K55HXLFP-3687
1/ Speed:1100 RPM
2/Shaft: 1/2" diameter x 3" x 2-1/2" long.
CW Rotation Lug side, 2-1/2" side.
3/Lug mount 6-1/4" centers. 5-5/8" Body Dia.
Run capacitor extra 5 mfdx370V \$2.95 ea.
Cat.#F33687 **\$20.00 each**

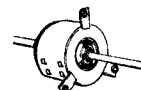

FEDDERS SHADED POLE FAN & BLOWER MOTOR
1/8 HP 115V

Model 32P128 5" Body Dia.
2/ Speed:1500/1280 RPM
2/Shaft: 1/2" diameter x 3" x 3" long.
Mounting: Bolt or Belly band
Cat.#F40997 **\$20.00 each**

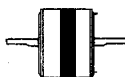

G.E. PSC FAN & BLOWER MOTOR
1/10 HP 230V

1/PH 60HZ 5-5/8" Body Dia.
Model 5KCP39CGJ020AS 5-5/8" Body Dia.
3/ Speed:1075/1000/900 RPM
2/Shaft:1/2" diameter x 2-1/2" x 2-1/2" long.
3/Lug mount 6-1/2" Mtg centers
Capacitor extra 5 mfd x 370V \$2.95 ea.
Cat.#A1M235 **\$20.00 each**

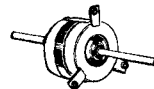

G.E. PSC FAN & BLOWER MOTOR
1/8 HP 115V

Model 5KCP39DGBB039S
2/ Speed:1080/930 RPM 5-5/8" Body Dia.
2/Shaft: 1/2" diameter x 4-1/2" x 2-3/4" long.
CCW Facing long shaft side
Rubber ring mount.
Run capacitor extra 5 mfd x 370V \$2.95 ea.
Cat.#F40535 **\$20.00 each**



G.E. PSC FAN & BLOWER MOTOR
1/8 HP 115V

5-5/8" Body Dia.
Model 5KCP39DGJ317JS
3/Lug Mount 3/ Speed:1060/940/835 RPM
2/Shaft: 1/2" diameter x 5-1/2" x 3-1/2" long
CW rotation facing 5-1/2" shaft side.
Run cap extra 10 mfd x 370V \$3.95 ea.
Cat.#F4031 **\$20.00 each**

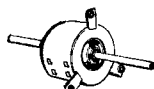

G.E. PSC FAN & BLOWER MOTOR
1/10 HP 115V

Model 5KCP29K6235AS
2/ Speed:1360/1100 RPM 5" Body Dia.
2/Shaft: 1/2" diameter x 2-1/4" x 2" long.
CCW Facing long shaft side
Rubber ring mount.
Run capacitor extra 5 mfd x 370V \$2.95 ea.
Cat.#F336235 **\$20.00 each**

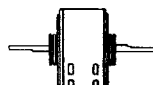

EMERSON PSC FAN & BLOWER MOTOR
1/5 HP 115V

5" Body Dia.
Model K48HXDKS-3045
2/ Speed: 1700/1300 RPM
1/Shaft: 1/2" diameter x 3" long.
CW rotation facing shaft. 3/Lug mount
Run capacitor extra \$3.50 ea.
Cat.#F11304 **\$20.00 each**

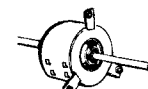

G.E. PSC FAN & BLOWER MOTOR
1/25 HP 115V

4-7/8 Body Dia.
Model 5KCP29BK6286S
3/Lug Mount 3/ Speed:1120/1020/930 RPM
2/Shaft: 1/2" diameter x 2-1/2" x 1-1/4" long
CCW rotation facing lug mount side.
Run cap extra 7.5 mfd x 370V \$3.95 ea.
Cat.#F4062 **\$20.00 each**

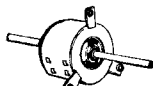

G.E. PSC FAN & BLOWER MOTOR
1/10 HP 115V

Model 5KCP39BGS39S
2/ Speed:1360/1100 RPM 5-5/8" Body Dia.
2/Shaft: 1/2" diameter x 2-3/4" x 2" long.
Rubber ring mount.
Run capacitor extra 5 mfd x 370V \$2.95 ea.
Cat.#F33393 **\$20.00 each**

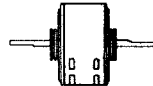

G.E. PSC FAN & BLOWER MOTOR
1/10 HP 115V

5-5/8" Body Dia.
Model 5KCP39DGG430S
3/ Speed:1075/900/800 RPM
2/Shaft: 1/2" diameter x 3-1/2" x 3" long.
CCW Facing long shaft side. Rubber ring Mt.
Run cap extra 7.5 mfd x 370V \$4.95 ea.
Cat.#GJ343 **\$20.00 each**

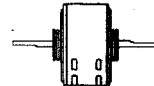

TECUMSEH MODEL AKA9427XA

+1/3 HP 115V R-404A / R-22
Medium Temperature
Compressor No. AKA9427XA

Cat.# A1U9427Z
\$595.00 each

High starting torque, with receiver tank, suction and liquid service valves.

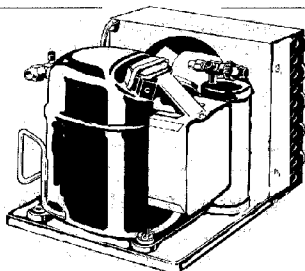

COPELAND MODEL M2FH-0056-IAV 1/2 HP 230V

1/2 HP 230V R-134a
Medium Temperature UNIT
Compressor No. ART64CIE-IAV

Cat.# F140056
\$625.00 ea.

High starting torque, with receiver tank, suction and liquid service valves.

NOTES

MUELLER-STREAMLINE

DRYMASTER Filter Driers

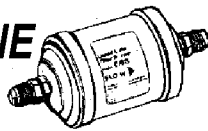

Driers are UL and CE listed max pressure 667 psig max temp 160 F
Solid core design for exceptional moisture and acid removal
Compatible with all CFC, HCFC and HFC refrigerants and oils

NOMINAL SYSTEM CAPACITY IN TONS

Cat No.	Model No.	Conn. Size	Tons R-12 R-134a	Tons R-22 R-410a	Tons R-404a R-507	Cubic Inch	Price Each
7500	032	1/4 SAE	3/4	1	1/2	3	\$ 14.00
75001	032S	1/4 ODF	3/4	1	1/2	3	14.00
7501	052	1/4 SAE	1	1.5	1/2	5	16.50
75011	052S	1/4 ODF	1	1.5	1/2	5	16.50
7502	053	3/8 SAE	3	4	1.5	5	16.50
75022	053S	3/8 ODF	3	4	1.5	5	16.50
7503	082	1/4 SAE	1.5	2	1.5	8	20.50
75033	082S	1/4 ODF	1.5	2	1.5	8	20.50
7504	083	3/8 SAE	4	5	2	8	\$ 20.50
75044	083S	3/8 ODF	4	5	2	8	20.50
7505	084	1/2 SAE	5	7.5	2	8	22.50
75055	084S	1/2 ODF	5	7.5	2	8	22.50
7506	163	3/8 SAE	4	5	3	16	26.00
75066	163S	3/8 ODF	4	5	3	16	26.00
7507	164	1/2 SAE	4	10	3	16	27.00
75077	164S	1/2 ODF	4	10	3	16	27.00
7508	303	3/8 SAE	4	6	3	30	\$ 40.00
75088	303S	3/8 ODF	4	6	3	30	40.00
7509	304	1/2 SAE	7.5	10	4	30	41.00
75099	304S	1/2 ODF	7.5	10	4	30	41.00
7510	305	5/8 SAE	10	15	5	30	42.00
75100	305S	5/8 ODF	10	15	5	30	42.00

DRYMASTER Suction Filter Driers

Driers are UL and CE listed max pressure 508 psig max temp 160 F
Solid core design for exceptional moisture and acid removal
Compatible with all CFC, HCFC and HCF refrigerants and oils

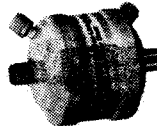

Cat No.	Model	OD Inch	Cu. In.	Filter Area	Price Each
7524	FDS-165-TT	5/8	16	26	\$ 37.00
7525	FDS-166-TT	3/4	16	26	39.00
7526	FDS-167-TT	7/8	16	26	43.00
7527	FDS-169-TT	1-1/8	16	26	47.50
7528	FDS-306-TT	3/4	30	52	54.50
7530	FDS-307-TT	7/8	30	52	55.50
7532	FDS-309-TT	1-1/8	30	52	59.50

DOMESTIC CHARGING VALVE DRYER



1/3 TON COPPER FILTER DRYER. 1/4" OD INLET & OUTLET WITH 1/4" SAE ACCESS VALVE.

Cat No. 7531 Part No. 619 **\$9.95 each**

DOMESTIC MOLECULAR SIEVE LIQUID LINE DRYER
COPPER SPUN END DRYER WITH SEALED 1/4" OD TUBE EXTENSIONS. FILTER/DRYER FOR UP TO 1/3 TON DOMESTIC REFRIGERATORS.

Cat. No. 20040  **\$3.95 each**

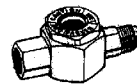

SUPCO REFRIGERATION SIGHT GLASS & MOISTURE INDICATOR

Liquid Eyes have proven reliability. They offer a high degree of flexibility for positioning the viewing port in hard to see places. The hex shoulders for tightening are of standard dimensions to accommodate standard flare nut or open end wrenches.

Cat. No.	Model No.	Size Sae Flare ODF Solder	Price ea.
80412	SSGFM2	1/4 F x M	\$ 25.95
80413	SSGFM3	3/8 F x M	26.95
80414	SSGFM4	1/2 F x M	27.95
80415	SSGSS2	1/4 OD	25.95
80416	SSGSS3	3/8 OD	27.95
80417	SSGSS4	1/2 OD	28.95
80418	SSGSS5	5/8 OD	29.95

supco Bullet Restricto cap sizes will cover 89 applications

Bullet Restricto Cap Kit contains the right capillary tubing to fit ANY domestic and commercial refrigerator and room air conditioner from 1/8 HP to 2 HP.

INDIVIDUAL KITS

Cat.#	Part #	Size	Price ea.
8013	BC-1	.031 ID x 10 ft	\$ 15.95
8014	BC-2	.941 ID x 12 ft	18.95
8015	BC-3	.052 ID x 12 ft	18.95
8016	BC-4	.064 ID x 12 ft	20.95
8017	BC-5	028 ID x 10 ft	15.95

CROSS REFERENCE

H.P.	Condenser Cooled	GAS	LOW	MEDIUM	HIGH
1/8	Fan	R134a-12	7' No. 5	7' No. 1	4' No. 1
1/8	Static	R134a-12	10' No. 5	7' No. 1	4' No. 1
1/6	Fan	R134a-12	7' No. 1	10' No. 2	6' No. 2
1/6	Static	R134a-12	8' No. 1	12' No. 2	8' No. 2
1/6	Fan	22	9' No. 1	6' No. 1	4' No. 1
1/5	Fan	R134a-12	6' No. 1	10' No. 2	5' No. 2
1/5	Static	R134a-12	7' No. 1	11' No. 2	6' No. 2
1/5	Fan	22	8' No. 1	5' No. 1	4' No. 1
1/4	Fan	R134a-12	12' No. 2	8' No. 2	3' No. 2
1/4	Fan	22	6' No. 1	12' No. 2	8' No. 2
1/4	Static	R134a-12	6' No. 1	12' No. 2	8' No. 2
1/4	Static	22	8' No. 1	12' No. 2	8' No. 2
1/4	Fan	R404a-R502	7' No. 1	4' No. 1	3' No. 1
1/3	Static	R134a-12	12' No. 2	4' No. 1	3' No. 1
1/3	Static	22	6' No. 1	4' No. 1	3' No. 1
1/3	Fan	R134a-12	10' No. 2	6' No. 2	9' No. 3
1/3	Fan	22	12' No. 2	10' No. 2	12' No. 3
1/3	Fan	R404a-R502	7' No. 1	3' No. 1	3' No. 2
1/2	Fan	R134a-12	12' No. 4	10' No. 4	5' No. 4
1/2	Fan	22	10' No. 3	8' No. 3	3' No. 3
1/2	Fan	R404a-R502	12' No. 3	10' No. 3	4' No. 3
3/4	Fan	R134a-12	10' No. 4	7' No. 4	2 1/2' No. 4
3/4	Fan	22	6' No. 3	4' No. 3	6' No. 4
3/4	Fan	R404a-R502	8' No. 3	5' No. 3	3' No. 3
1	Fan	R134a-12	6' No. 4	3' No. 4	18" No. 4
1	Fan	22	8' No. 4	6' No. 4	3' No. 4
1	Fan	R404a-R502	5' No. 3	8' No. 4	5' No. 4
1-1/2	Fan	R134a-12	4' No. 4	2' No. 4	10" No. 4
1-1/2	Fan	22	6' No. 4	4' No. 4	2' No. 4
1-1/2	Fan	R404a-R502	8' No. 4	6' No. 4	4' No. 4
2	Fan	R134a-12	3' No. 4	18" No. 4	8" No. 4
2	Fan	22	4 1/2' No. 4	3' No. 4	18" No. 4
2	Fan	R404a-R502	5' No. 4	2' No. 4	1' No. 4



**COMPLETE KIT-ALL
5 COILS
Cat. No. 8012
Part # 5 Pak \$ 75.75**

COMMERCIAL TEMPERATURE WATER COOLED CONDENSING UNITS 230 VOLT 1/PH 60 HZ

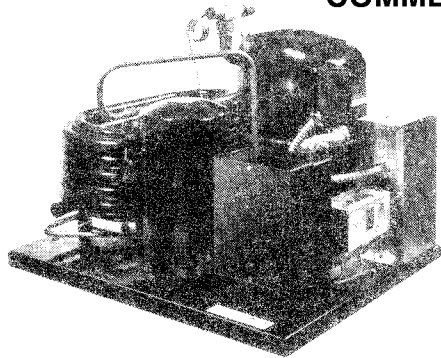

Complete water cooled condensing units. Compressor, w/cooled condenser, water valve, receiver tank, hi-low pressure control, service valves and electrical starting components.

Cat.#	HP	Temperature	Refrigerant	Price Ea.
A1C982	1	Medium	R-134a / R-12	CALL FOR PRICES
A1C983	2	Medium	R-134a / R-12	
A1C984	3	Medium	R-134a / R-12	
A1C895	1	Medium	R-22 / R404A	
A1C986	2	Medium	R-22 / R404A	
A1C987	3	Medium	R-22 / R404A	

J/B CHARGING MANIFOLD AND HOSES

R-410a / R-404a / R-22
3-60" B-R-Y KOBRA HIGH PRESSURE HOSE 4000 PSI

- *Forged brass body manifold
- *Hi-Low Pressure Gauges **Model M2-5-410A**
- *With hose holder & hook
- *"FLUTTER" FREE LEXAN GAUGES **\$ 165.00 ea.**

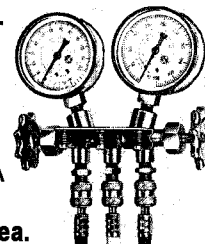

Cat. No. 45X510 M2-5-410A Manifold & 3- 60" High Pressure Hose

J/B FAST-VAC VACUUM PUMP OIL

This high quality extremely low vapor pressure mineral oil is especially formulated for use in deep vacuum mechanical pumps. The superior quality of this oil gives the extra edge in pumping speed when your pump is working under deep vacuum.

Cat. No. 4501	Gallon Bottle	DVO-24	\$ 52.00
Cat. No. 4587	Quart Bottle	DVO-12	17.00
Cat. No. 45870	Pint Bottle	DVO-8	12.00



J/B CHARGING MANIFOLD AND HOSES FACES WITH R-134a, R-22 AND R-404a SCALES

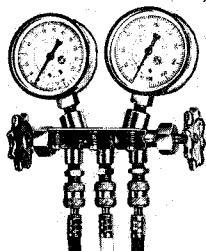

- * COMPLETE WITH 3 COLOR CODED 60"HOSES
- * EASY TO READ DIAL
- * HANDY BUILT-IN HOOK
- * FORGED BRASS BODY
- * "O" RING PISTONS ELIMINATES LEAKS
- * "FLUTTER" FREE LEXAN GAUGES

Cat. No. 45X51 M2-21131 3-60" **\$ 165.00 ea.**

BVA SYNTHETIC POLYESTER LUBRICANT FOR HFC REFRIGERANTS

Ester oil designed for high, medium, low temperature refrigeration systems. Approved by over 35 OEM manufacturers world wide.

Cat. No. 4900 Mfg # 170G 1 Gallon **\$105.00ea.**



J/B REFRIGERATION MANIFLOD GAUGES 2-1/2"

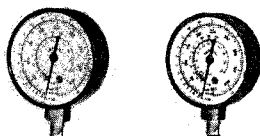

2-1/2" Dial Face * Full Size Brass movement * Pointer Flutter Dampened * Surge Dampened * Recalibration Screw * High Impact Lexan Lens

LOW PRESSURE: BLUE

Low side 30" vacuum to 120# pressure, retard to 350#. Temperature scale for (F) R-134a, R-22, R-404a 1/8" MPT connection.

Cat. No. 45X61 M2-430 LOW **\$21.50 ea.**

HIGH PRESSURE: RED

High side pressure from 0 to 500 lbs. Temperature scale (F) For R-134a, R-404a, R-22. 1/8" MPT.

Cat. No. 45X71 M2-435 HIGH **\$21.50 ea.**

LOW PRESSURE: BLUE R410a-R404a-R22
2-1/2" 1/8" MPT

Cat. No. 45X710 M2-460 LOW **\$21.50 ea.**

HIGH PRESSURE: RED R410a-R404a-R22
2-1/2" 1/8" MPT

Cat. No. 45X720 M2-465 HIGH **\$21.50 ea.**



UNSCREWS TO REVEAL ALL SIZES

Multi swage produces perfect solder cups for joining 9 different O.D. tube sizes to another tube of the same size. 3/16-1/4-5/16-3/8-7/16-1/2-5/8-3/4-7/8-" O.D.

Cat. No. 45X8 T21000 Multi Swage **\$89.00 ea.**

J/B MULTI SWAGING TOOL

J/B CHARGING LINES 36" & 60" LONG 1/4" FEMALE SAE

1/4" female SAE flare quick couplers. 45 degree elbow on one end with valve core depressor. Reinforced braid engineered for 2500 psi burst pressure. Pinpricked outer cover prevents blistering. Special compound for refrigerants & oils.

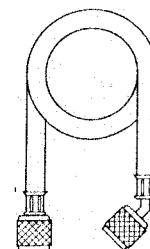

Cat. No.45X199 CCLE-60 Set of 3-60" Hose **\$90.00 ea.**
Blue-Red-Yellow 4,000 PSI R-410a

PACKARD OVAL MOTOR RUN CAPACITORS

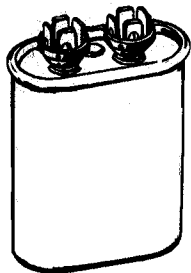

Single Section Run Capacitors 370 Volt Oval

UL Listed 370 VOLTS	CSA Approved OVAL CASE	SINGLE SECTION 50/60 HZ			
Cat.#	MFD	Width	Depth	Height	Price Each
POC5	5	1-1/4"	2"	1-1/2"	\$ 4.50
POC7.5	7.5	1-5/16"	2-5/32"	2-3/8"	4.95
POC10	10	1-5/16"	2-5/32"	2-5/8"	5.50
POC12.5	12.5	1-5/16"	2-5/32"	3"	6.95
POC15	15	1-5/16"	2-5/32"	3-3/4"	7.50
POC20	20	1-29/32"	2-29/32"	2-5/8"	8.50
POC25	25	1-29/32"	2-29/32"	2-5/8"	8.95
POC30	30	1-29/32"	2-29/32"	3"	10.50
POC35	35	1-29/32"	2-29/32"	3-3/4"	11.50
POC40	40	1-29/32"	2-29/32"	3-3/4"	13.50
POC45	45	1-29/32"	2-29/32"	3-3/4"	14.95
POC50	50	1-29/32"	2-29/32"	4-3/4"	15.95
POC55	55	1-29/32"	2-29/32"	4-3/4"	16.95
POC60	60	1-29/32"	2-29/32"	4-3/4"	17.95
POC80	80	1-29/32"	2-29/32"	4-3/4"	23.95

A O SMITH DIRECT DRIVE BLOWER MOTORS

Permanent Split Capacitor

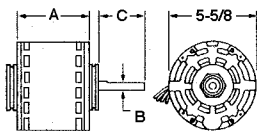

BELLY BAND OR RING MOUNT

48 Frame
Single & Three Speed • Electrically Reversible
Sleeve & Ball Bearing • Automatic Overload
2 1/2" Dia. Mounting Rings 60 Hertz

1075 RPM	Three Speed		115 & 230			Price Ea.	
Cat.#	H.P.	RPM	Volts	"A"	"B"		"C"
DL1026	1/4-1/6-1/8	1075/3	115	4.13"	1/2"	4.44"	CALL FOR PRICES
D1026	1/4-1/6-1/8	1075/3	208-230	4.13"	1/2"	4.44"	
DL1036	1/3-1/4-1/6	1075/3	115	4.38"	1/2"	4.44"	
D1036AO	1/3-1/4-1/6	1075/3	208-230	4.38"	1/2"	4.44"	
DL1056	1/2-1/3-1/4	1075/3	115	5.13"	1/2"	4.44"	
D1056	1/2-1/3-1/4	1075/3	208-230	4.90"	1/2"	4.50"	
DL1076	3/4-1/2-1/3	1075/3	115	5.63"	1/2"	4.50"	
D1076	3/4-1/2-1/3	1075/3	208-230	5.63"	1/2"	4.19"	
• BDL1106	1-3/4-1/2	1075/3	115	5.81"	1/2"	6.44"	
• BD1106	1-3/4-1/2	1075/3	208-230	5.56"	1/2"	6.44"	

•Ball Bearing

PLASTIC CASE

MOTOR START CAPACITORS

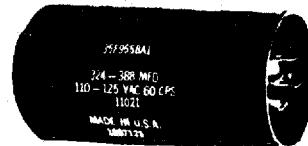

110/125 DUAL VOLTS AC 60 HZ

CAT. NO.	MICROFARD MIN - MAX	DIAMETER \$ LENGTH	PRICE EA.
12001	88-108	1-7/16 x 2-3/4	\$ 7.95
12002	108-130	1-7/16 x 2-3/4	7.95
12003	124-149	1-7/16 x 2-3/4	8.50
12004	145 - 175	1-7/16 x 2-3/4	8.75
12005	161 - 193	1-7/16 x 2-3/4	8.95
12006	189 - 227	1-7/16 x 3-3/8	\$ 9.50
12008	216-259	1-7/16 x 3-3/8	9.50
12009	233-280	1-7/16 x 3-3/8	9.95
12010	270-324	1-7/17 x 3-3/8	9.95
12012	324-389	1-13/16 x 3-3/8	\$ 11.95
12014	378-454	1-13/16 x 3-3/8	11.95
12015	400-480	1-13/16 x 3-3/8	13.95
12016	460-552	2-13/16 x 4-3/8	13.95

250/220 DUAL VOLTS AC 60 HZ

CAT. NO.	MICROFARD MIN - MAX	DIAMETER \$ LENGTH	PRICE EA.
12017	88 - 108	1-13/16 x 4-3/8	\$ 11.95
12018	108 - 130	1-13/16 x 4-3/8	12.95
12019	124 - 149	2-1/16 x 4-3/8	12.95
12021	145 - 175	2-1/16 x 4-3/8	13.95
12022	161 - 193	2-9/16 x 4-3/8	14.95
12023	189 - 227	2-9/16 x 4-3/8	15.95
12024	216 - 259	2-9/16 x 4-3/8	17.95
12025	233 - 292	2-9/16 x 4-3/8	18.95

330 VOLTS AC 60 HZ

CAT. NO.	MICROFARD MIN - MAX	DIAMETER \$ LENGTH	PRICE EA.
12027	88 - 108	2-1/16 x 4-3/8	\$ 12.95
12028	108-130	2-9/16 x 4-3/8	13.95
12029	130-156	2-9/16 x 4-3/8	14.95
12030	145 - 175	2-1/16 x 4-3/8	15.95
12031	161 - 193	2-9/16 x 4-3/8	16.95
12032	189 - 227	2-9/16 x 4-3/8	18.95

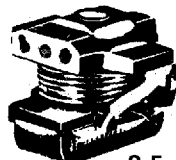

G. E. REPLACEMENT CURRENT RELAYS

RANGES FROM 1/12 HP 3/4 HP 115V
MARS 10 CR PAK
Consisting of 10 General Electric
CURRENT RELAYS will replace
over 1,000 model numbers.
INDIVIDUAL RELAYS \$ 21.95 ea.

G. E. CURRENT RELAY Cat.#
3ARR2-KCP172S A1CKCP172S
1/2 HP-3/4 HP 115V \$ 14.95 ea.

Cat. No.	Part No.	
5117	2 7001	3ARR12-PAC309A
5118	2 7002	3ARR12-PAC310A
5119	2 7003	3ARR12-PAC311A
5120	2 7004	3ARR12-PAC312A
5121	2 7005	3ARR12-PAC313A
5122	2 7006	3ARR12-PAC314A
5123	2 7007	3ARR12-PAC315A
5124	2 7008	3ARR12-PAC316A
5125	2 7009	3ARR12-PAC317A
5126	2 7010	3ARR12-PAC318A
5213	93104	TWO EACH OF QC-11

REPLACEMENT MARS II POTENTIAL MOTOR STARTING RELAYS

3ARR3 TYPE RELAYS WILL INTERCHANGE THOUSANDS OF RELAY VARIATIONS

Six relays replace thousands of OEM models. Universal mounting bracket, with push-on terminals. Mounts in any position, adaptable to a wide variety of mounting brackets. Lets you handle replacements with a minimum of stock.

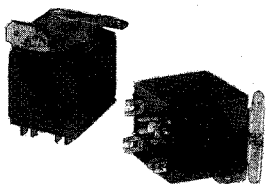

ALL ANGLE MOUNT WITH UNIVERSAL BRACKET

Cat. No.	Individual Relays	Replaces 3ARR3 Relay Groups	Price
52163	Mars II 63	2J: 2K: 2L: 2M: 5N: 7J: 7L: 7M: 8L: 8M: 8N:	\$ 42.00 each
52164	Mars II 64	3A:3B:3AV:3AU:4A:4B:6A:6B:6AV:10A:10B:10AU:10AV	
52165	Mars II 65	3P: 3R: 5R: 5S: 5T: 22S	
52166	Mars II 66	3U: 3V: 3AT: 6U: 6V: 6W: 6TV: 6TW: 10V	
52167	Mars II 67	3C: 3D: 3AA: 4C: 4D: 4BK: 6C: 6D: 6AA: 10C: 10D: 26D	
52168	Mars II 68	3E:3F:3AB:3AC:4E:4F:4G:6E:6F: 6G: 10H: 10AB: 10AC	
Optional Mars Relays			
52169	Mars II 69	3S: 3T: 10S: 10T: 25S: 25T: 10AS	\$ 42.00 each
52170	Mars II 70	5B: 5C: 5D: 5AA: 8B: 8C: 8D:	

25 TO 60 AMP COMPACT DESIGN CONTACTORS

The latest generation of GTE contactors includes one of the smallest 50 & 60 amp contactors available in the industry. The 40 amp and larger models feature large box-lug terminals for fast and easy wiring. Features of these compact contactors are: Small dimensions make replacement easy - Used in Refrigeration, Air Conditioning, and Resistance Heating. Line and coil terminals feature combination quick-connect and screw or box-lug connections. Universal mounting base. UL & CSA approved.

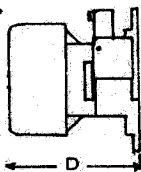
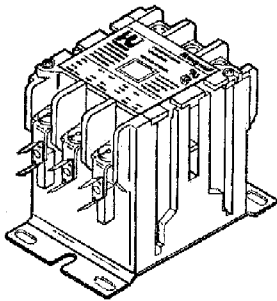

DIMENSIONS

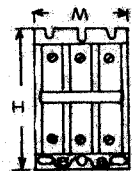

25 AMP and 30 AMP
3-3/4" H x 2-3/4" W x 3" D

40 AMP
3-3/4" H x 2-3/4" W x 3-3/8" D

50 AMP and 60 AMP
3-7/8" H x 2-3/4" W x 3-5/8" D

Cat.#	Part #	FLA	Res Amps	Coil Volts	No. of Poles	Price Ea.
1015	30AS-3P-24	30	40	24	3	\$ 22.00
1017	30AS-3P-230	30	40	230	3	22.00
1018	40AS-3P-24	40	50	24	3	28.00
1020	40AS-3P-230	40	50	230	3	28.00
1021	50AG-3P-24	50	62	24	3	48.00
1023	50AG-3P-230	50	62	230	3	48.00
1024	60AG-3P-24	60	75	24	3	59.00
1026	60AG-3P-230	60	75	230	3	59.00
1029	30AS-2P-24	30	40	24	2	\$ 19.00
1030	30AS-2P-230	30	40	230	2	19.00
1031	40AS-2P-24	40	50	24	2	20.00
1032	40AS-2P-230	40	50	230	2	20.00

DIAL POCKET THERMOMETER 1" DIAMETER HEAD

WITH CASE -40 deg. F to +160 deg. F.

Cat. No. 0566 **\$7.95 ea.**

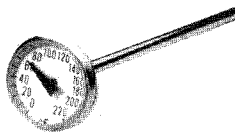

DIGITAL STEM THERMOMETER



- *Large LCD display
- *New temperature range -50° F. to 392°F. (-45 to 200°C)
- *Anti-rolling head design
- *Button battery included
- *Display updates per second
- *On-Off switch
- *Fahrenheit/Celsius switchable
- *With plastic sheath which can also be used as holder and pocket clip.

Cat.# 0541 MA-RT335 Digital Thermometer **\$18.95 ea.**

LOW VOLTAGE CLASS II CONTROL TRANSFORMERS

Easier to install than most transformers. Foot mount transformers install in any position. For gas valves, thermostats, and A/C magnetic contactors.

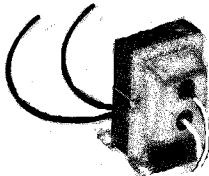

Cat. No.	VA Rated	Primary (Input)	Secondary (Output)	Model	Price
52746	40	115V	24V	MA-TX403	\$ 15.95
52747	40	208/240V	24V	MA-TX406	15.95
52171	75	208/240V	24V	MA-TX779	33.95

TELESCOPIC POCKET INSPECTION MIRRORS



1" x 2" Oval mirror telescopic from 7" to 19". With pocket clip and insulated head.

Cat. No. 0500 Part No. MA-157A **\$7.95 ea.**

1-1/4" Round inspection mirror. **MAGNIFIED TO ENLARGE WORK AREA.** Telescopic from 7" to 19". With pocket clip and insulated head.

Cat. No. 0501 Part No. MA-143M **\$10.50 ea.**

2-1/8" x 3-1/2" large rectangular mirror. Telescopic handle from 11" to 15-1/2". No pocket clip.

Cat. No. 0502 Part No. MA-149 **\$10.50 ea.**

SAMSUNG ROTARY COMPRESSORS FOR R410A A/C AND HEAT PUMPS

CAT.#	MODEL	HP	BTU	VOLTS/PH	PRICE
A2C180	UG5T1801NVF2	1 1/2	18,000	230/1/60	\$ 225.00
A2C200	UG5C2001NXJ2	1 3/4	20,000	230/1/60	250.00
A2C220	UG5C2201NWF2	2	22,000	230/1/60	265.00
A2C250	UG5C2501NZJ2	2	25,000	230/1/60	265.00
A2C260	UG5C2601NZF2	2	26,000	230/1/60	265.00
A2C290	UG5A2901NZJ2	2 1/4	29,000	230/1/60	190.00
A2C320	UG5T3201UZF2	2 1/2	32,000	230/1/60	350.00

ALL COMPRESSORS
FOR R410A WITH
INTERNAL OVERLOAD
POE OIL CHARGE &

PANASONIC ROTARY COMPRESSORS FOR R410A MINI-SPLIT A/C'S DC FOR INVERTER SYSTEMS

A2C5KD24	5KD240XAC21	2	24,000	DC 280V	\$ 255.00
A2C5JD42	5JD420XAC22	3-1/2	42,000	DC 280V	295.00

VAPOR TENSION THERMOMETERS

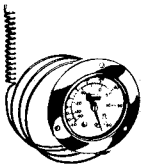

Model MA-50ABF
Replacement for most freezers and cold rooms. 2" dial with 3" front flange mount and back connections. 48" nickle plated capillary. Color coded scales. Recalibration pointer. NSF listed. Range Dual Scale: -40 deg. F. to +60 deg. F. -40 deg. C. to 15 deg. C.
Cat. No. 9017 \$ 39.95

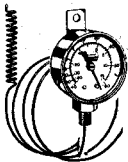

Model MA-60A
Same specifications as above, without front flange. With hanger strap, bottom connections. Wall mount.
Cat. No. 9018 \$39.95

REFRIGERATOR / FREEZER THERMOMETERS



-20 to +80 Deg. F.
Hangs or Stands-Accurate-Easy to read.
Cat.# 05X39 MA-RT1 -20F. to +80F. \$7.95 each

REFRIGERATOR / FREEZER THERMOMETER



Thermometer has dual scale fahrenheit & centigrade. Hangs or stands.
Cat.# 05X40 05X41 MA-HRFT1 -20F. to +80F. \$7.95 ea.

CD VALVE CORE REMOVAL TOOL



Designed for removing and replacing a "Schrader" type core, without loosing the charge. All brass construction.

Cat.No. 3300 Part No. CD3900 \$ 42.00 ea.

CD THUMBSCREW CORE DEPRESSOR

For use on 1/4" male sae flare to allow the core to be opened to the degree of flow desired. Solid brass construction. Compact design for close quarters.

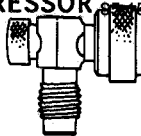

Cat.No.3310 Part No. CD5050 \$ 13.95 ea.

DEFROST TERMINATION SWITCHES

These controls are designed to replace many OEM defrost thermostats. The selection of the proper thermostat can be made by matching the temperature code of the the old thermostat. Will replace G.E. and Klixon termination switches for domestic refrigerators and freezers.

Cat.No.	Part#	Klixon#	Temp.Setting
80605	ML45	S2064RL45	Open 45 deg. F.
80606	ML50	S2064RL50	Open 50 Deg. F.
80607	ML55	S2064RL55	Open 55 Deg. F.
80608	ML60	S2064RL60	Open 60 Deg. F. \$7.95 ea.
80609	ML70	S2064RL70	Open 70 deg. F.



COMMERCIAL - DOMESTIC SUPER START RELAY

SUPCO

Combination relay, overload, & 255 mfd start capacitor for all commercial & domestic refrigerators & freezer compressors, 1/4 HP to 1/3 HP. Will increase its torque to its maximum capacity for compressors not equipped with a start capacitor.

Cat.# 80599 Mfg# SS410 \$19.95 ea.



PVC ELECTRICAL TAPE 60' x 3/4" x 7 MIL CAT.# 0520 \$ 2.95 ea.

INSULATING FOAM TAPE 30' x 2" x 1/8" CAT.# 0521 \$12.95 ea.

ALUMINUM FOIL DUCT TAPE 50 yds. x 3" CAT.# 0522 \$17.95 ea.

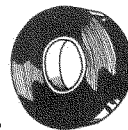

115V LINE VOLTAGE CORD ADAPTORS

RUBBER COVERED ALLIGATOR CLIPS

Cat. No.			
05X8	24 Inch Female	MA-32831	\$13.95 ea.
05X9	6 Ft. Male	MA-32832	\$13.95 ea.

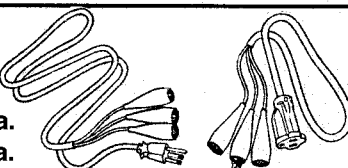

CD COPPER TEE WITH 1/4" SAE ACCESS

Cat. No.	Connection Size	Price
3305	CD8458 5/8" OD Tube	\$ 7.95
3306	CD8438 3/4" OD Tube	8.95
3307	CD8478 7/8" OD Tube	9.95
3308	CD8418 1-1/8" OD Tube	10.95

C&D SWAGED COPPER TEE-1/4"SAE ACCESS

Cat. No.	Connection Size	Price Ea.
3301	CD8414 1/4" OD	\$ 4.95
3302	CD8416 5/16" OD	\$ 5.50
3303	CD8438 3/8" OD	\$ 5.95
3304	CD8412 1/2" OD	\$ 6.95

ACCESS VALVE CORE TOOL



Furnished with 6 extra cores. Includes core remover and thread restorer bits. Hollow handle for storage.

Cat. No. 4500 Mfg.# A32004

1/4" Valve Core Tool \$12.95 each

SEALED UNIT PARTS SUPCO



SOLID STATE 3 N' 1 START RELAY COMBINATION RELAY OVERLOAD & CAP

Relay, Overload Protector and Start Capacitor all in one easy to install package. Completely pre-wired. Replaces all 3 electrical components on all capillary systems. For domestic and commercial refrigerators and freezers. For pin push-on terminals or screw connections.

Cat. No.	HP	Price
80514	RCO-810 1/12 to 1/5HP	\$ 17.95
80515	RCO-410 1/4 to 1/3 HP	17.95
80599	RCO-210 1/2 HP	19.95



"BIG RELAY" COMBINATION RELAY AND START CAPACITOR

One size for 1/12 HP to 1/2 HP 115 Volt compressors. Specifically designed for refrigerators and freezers, domestic and commercial. Prevents low voltage start problems. Replaces current type relays. Simply remove the defective current relay and install THE BIG RELAY by pushing on 3 terminals - completing the installation - Just like that.

Cat. No. 8145 Mfg. # RSC-10 \$ 18.95

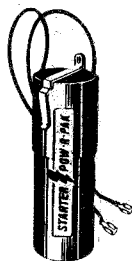

STARTER POW-R-PAK COMBINATION RELAY AND START CAPACITOR

SUPCO relay and start capacitor combination for hard to start compressors or where low voltage is a problem. Gives additional starting torque to all Single Phase 115 - 208 - 220 - 230 - 277 Volt PSC air conditioning compressors from 4,000 to 90,000 BTU. 1/2 HP to 7-1/2 HP. 2 wires connect to existing run capacitor for easy installation.

Cat. No.	Mfg.#	Increase	Starting Torque	Price
8038	SPP5		Up To 300 %	\$14.95
80511	SPP6		Up To 500 %	23.95
80544	SPP7		Up To 600 %	30.95

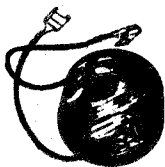

SPP POW-R-PAK FOR LOW VOLTAGE AREAS

Simply connect the two wires to the run capacitor as a super assist for all low voltage conditions. Just one model SPP is used for all PSC air conditioning units from 4,000 BTU thru 60,000 BTU. For all Single Phase 115 thru 277 Volts. For tight compressors that need an additional boost, use the SPP as a relay with a "START CAPACITOR". About 1" in diameter, the SPP packs a real boost. Every air conditioner should have one installed.

Additional boost, use the SPP as a relay with a "START CAPACITOR". About 1" in diameter, the SPP packs a real boost. Every air conditioner should have one installed.

CAT. NO. 8037 Mfg. # SPP \$ 13.95 ea.

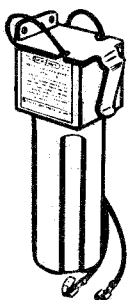

SUPER BOOST STARTER - RELAY & START CAPACITOR COMBINATION

For all air conditioning and heat pump units 4000 to 90,000 BTU Incorporates the PR90 universal relay with a large start capacitor for hard start problems. 1/2 to 7-1/2 HP 115V-208-220-230- 277 Volts Single Phase compressors

Cat. No. 80545 Mfg# SPP8 \$ 40.95

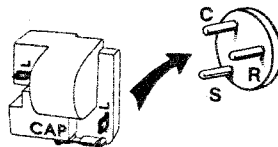

115 V PUSH-ON RELAY & OVERLOAD COMBINATION - NOW IN ONE UNIT

Replaces ALL hermetic refrigerator compressor push-on Relay and Overload protectors from 1/12hp through 1/3 hp 115V. Can be used in conjunction with a start capacitor. Fast, Simple installation. Superior overload locked rotor protection, eliminates start winding overheating.

FAST INSTALLATION... JUST PUSH IT ON!

Cat. No. 80610	1/12 to 1/5HP 115V	\$ 14.95
Cat. No. 80611	1/4 to 1/3HP 115V	14.95



SOLID STATE PUSH-ON RELAY 1/12 THRU 1/2 HP 115V

One size for all compressors 1/12 thru 1/2 HP. Replaces ALL Push-On current type relays. For use on compressors with "Pin Type" terminals. Can be used on ALL capacitor and non-capacitor start motors. Lowest resistance solid state relay. FASTEST COOL DOWN TIME OF ALL SOLID STATE RELAYS. Will restart a balanced system WITHIN ONE MINUTE. Quick and easy to install.

Cat. No. 8030 Mfg# PO-115 \$ 9.95 ea.



ICG-1 SOLID STATE RELAY 115 VOLTS

A combination snap or screw on general replacement relay. Will replace ALL CURRENT STARTING RELAYS, from 1/12 thru 1/2 HP. Comes complete with pin type terminals and can also be used on screw type terminals. Can also be used with start capacitor.

Cat. No. 8029 Mfg# ICG-1 \$ 9.95 ea.

METAL FITTINGS

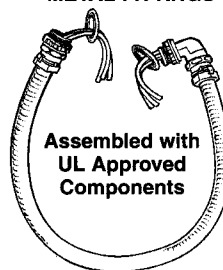

Assembled with UL Approved Components

AIR CONDITIONING WHIPS CONVENIENCE KIT

KIT COMES COMPLETE WITH 2 REDUCING WASHERS

Cat. #	Description	Price Ea.
MA4012W	1/2" x 4' #10 THHN Wire 1-straight + 1-90 Connector	\$ 19.95
MA6012W	1/2" x 6' #10 THHN Wire 2-straight Connectors	23.95
MA4034W	3/4" x 4' #8 THHN Wire 1-straight + 1-90 Connector	26.95
MA6034W	3/4" x 6' #8 THHN Wire 2-straight Connectors	32.95

PARAGON DEFROST TIMER-TIME INITIATED-TEMPERATURE OR PRESSURE TERMINATED

Frequency of defrost is one to six cycles per day-A minimum of four hours between defrost cycles. Contact arrangements for electric defrost-compressor shutdown or hot gas defrost. Switch rating 40amp 230/115.

Cat.#
A1814500 120V 8145-00 \$ 115.00 ea.
A1814520 230V 8145-20 \$ 115.00 ea.

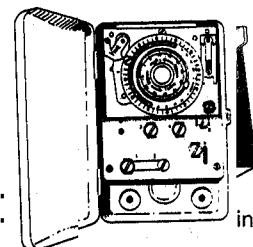

MUELLER WROT COPPER SOLDER REFRIGERATION FITTINGS

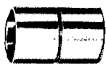

O.D. COUPLINGS

Cat. No.	OD Size	Mfg. #	Price Ea.
18X1	3/16"	W01001	\$
18X2	1/4"	W01003	
18X3	5/16"	W01042	
18X4	3/8"	W01009	CALL FOR PRICES
18X5	1/2"	W01017	
18X6	5/8"	W01022	
18X7	3/4"	W01028	
18X8	7/8"	W01034	
18X9	1-1/8"	W01047	



REDUCING O.D. COUPLINGS

Cat. No.	Size	Mfg. #	Price Ea.
18X20	1/4x3/16"	W01004	\$
18X22	3/8x1/4"	W01011	CALL FOR PRICES
18X23	1/2x3/8"	W01019	
18X24	5/8x1/2"	W01023	
18X25	3/4x5/8"	W01029	
18X26	7/8x3/4"	W01035	

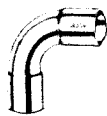

90 DEGREE O.D. ELBOWS

Cat. No.	Size	Mfg. #	Price Ea.
18X30	1/4"	W02003	\$
18X32	3/8"	W02009	CALL FOR PRICES
18X33	1/2"	W02017	
18X34	5/8"	W02022	
18X35	3/4"	W02028	
18X36	7/8"	W02034	
18X37	1-1/8"	W02047	

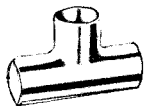

O.D. TEES

Cat. No.	Size	Mfg. #	Price Ea.
18X46	3/16"	W40302	\$
18X47	1/4"	W40306	CALL FOR PRICES
18X48	5/16"	W40313	
18X49	3/8"	W04000	
18X50	1/2"	W04001	
18X51	5/8"	W04006	
18X52	3/4"	W04017	
18X53	7/8"	W04031	

NYLON SAND SCREEN

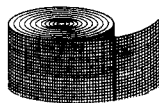

Cat. #
 05100 1-1/2" x 30" Roll \$ 2.50
 05101 1-1/2" x 5 Yards \$ 7.50
 Sand screen is superior to sand cloth for cleaning copper surface prior to brazing or soldering. An open nylon screen-like material with abrasive on both sides. Won't break down or clog up like paper or cloth type materials.

J/B REFRIGERATION



SAE BRASS FITTINGS

SHORT FORGED BRASS FLARE NUTS

Cat. No.	SAE Flare	Mfg. #	Price ea.
4502	1/4"	NS4-4	\$
4504	3/8"	NS4-6	CALL FOR PRICES
4505	1/2"	NS4-8	
4506	5/8"	NS4-10	



BRASS SAE FLARE UNION

Cat. No.	Size	Price Ea.
4513	1/4"	\$
4515	3/8"	CALL FOR PRICES
4516	1/2"	
4517	5/8"	

MUELLER SUCTION LINE P-TRAPS

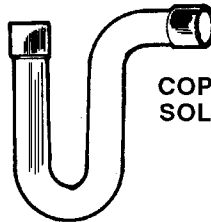

COPPER SOLDER

Cat. #	O.D. SIZE	MFG. #	PRICE EA.
18X80	5/8"	W60099	CALL FOR PRICES
18X81	3/4"	W61008	
18X82	7/8"	W61000	
18X83	1-1/8"	W61001	
18X84	1-3/8"	W61002	
18X85	1-5/8"	W61003	
18X86	2-1/8"	W61009	



BRASS HALF UNION SAE FLARE x MALE PIPE THREAD

Cat. No.	Sae x IPT	Price ea.
4523	1/4 x 1/8"	\$
4524	1/4 x 1/4"	CALL FOR PRICES
4525	1/4 x 3/8"	
4527	3/8 x 1/4"	
4528	3/8 x 3/8"	
4529	3/8 x 1/2"	
4531	1/2 x 3/8"	
4532	1/2 x 1/2"	

REFRIGERATION ROTO-LOCK SERVICE VALVES WITH TEFLON SEAL

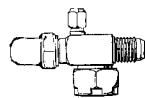

Cat. #	Tubing Connection	Size	Price Ea.
A1V38	3/8" sae		\$ 28.95
A1V12	1/2" sae		39.95
A1V58	5/8" sae		45.95
A1V78	7/8" OD		69.95
A1V18	1-1/8" OD		79.95

CERRO COPPER TUBING

Refrigeration soft copper tubing for installation and maintenance of refrigeration and air conditioning equipment. Fine copper tubing dehydrated and sealed, properly annealed to the right temper for easy flaring. When you buy CERRO copper tube you are buying American made tube of the finest quality. **SOLD ONLY IN 50 FT. INDIVIDULLY BOXED COILS.**

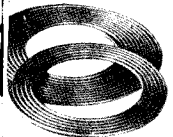

Cat. No.	OD Size	Wall Thick	Price Ea.
2402	1/4"	.030	CALL FOR CURRENT PRICE
2403	5/16"	.032	
2404	3/8"	.032	
2405	1/2"	.032	
2406	5/8"	.035	
2407	3/4"	.035	
2408	7/8"	.045	

BRONZ VIBRATION ELIMINATORS - COPPER ENDS



copper braid covered hose eliminates the vibration between the refrigeration unit and the line tubing. Prevents copper line breakage in refrigeration and air conditioning systems. Underwriters listed.

Cat. No.	For OD Tube	Long	Price ea.
40105	1/4"	7-1/2"	\$
40106	3/8"	8-1/4"	CALL FOR PRICES
40107	1/2"	9"	
40108	5/8"	9-3/4"	
40109	3/4"	11-1/4"	
40110	7/8"	11-1/2"	
40111	1-1/8"	13"	
40112	1-3/8"	14-3/4"	

SOLID STATE TIME DELAYS

INPUT 18-240 VAC
 10 MINUTE ADJUSTABLE
 MAX LOAD 1.5 AMPS

\$ 9.95 each

CAT. # 05102 DELAY ON MAKE
 CAT. # 05203 DELAY ON BREAK

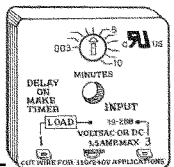

LEAK LOCK REFRIGERATION JOINT SEALER

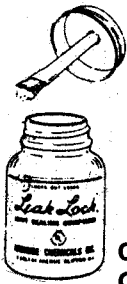

The pipe joint sealing compound especially developed for refrigeration applications. Makes a positive seal on fittings, gaskets, etc., that will not leak. Permanently insoluble, never hardens, stays plastic, smooth and free of pin holes. Can't dry out or crack. A little goes a long way.

Cat. No. 3900 1-1/3 oz. Tube **\$ 5.95 ea.**
 Cat. No. 3901 4 oz. Brush-Cap **\$14.95 ea.**

TRACE REFRIGERANT LEAK DETECTOR

HOW IT WORKS Trace locates refrigerant and oil leaks by leaving a bright red color at the location of the leak. It circulates through the system with the refrigerant and oil and is forced out with the escaping gas at the leak.



For Mineral Oil

Cat. No. 3907 4 oz. Bottle **\$ 12.50 ea.**
 Cat. No. 3908 Pint Bottle **\$ 25.95 ea.**

For Polyester Oil

Cat. No. 3999 4 oz. Bottle **\$ 13.50 ea.**

REFRIGERANT GAS LEAK DETECTOR

Revolutionary Foam Refrigerant And Gas Leak Detector



Works on the soap bubble principle but is applied as a thick creamy foam that can be spread conveniently and will not run off. Ideal for use on cold lines. Special formula will not freeze. Unbreakable plastic bottle.

Cat. No. 80512 #22008 8oz. W/Dauber **\$ 7.95 ea.**

SUPER TURBINE OIL FOR HIGH SPEED SHAFTS AND BEARINGS

Oils everything that needs to be oiled. A real problem solver for the appliance service man. Use on electric motor bearings, withstands high temperature. A must for heater blowers. Frees sticky and stuck bearings, keeps bearing surfaces clean, contains SUPCO 88, with pull-out spout for hard to reach equipment.



Cat. No. 80001 Part No. M098 **\$ 4.50 ea.**

SUPCO 88 FOR COMPRESSOR OIL



SUPCO is added to the oil in compressors to prevent acid and sludge forming on bearing surfaces. It helps reduce friction on all moving parts, prevent rusting and corrosion and increases the efficiency of the unit.

Cat. No. 8127 8 oz. Bottle S-8 **\$ 8.95 ea.**

ELECTRICAL ALL WEATHER PLASTIC TAPE

Plastic electrical tape Poly Vinyl Chloride retains its stretch conformity through a wide range of temperature and humidity. 0 deg. F. to 176 deg. F.

Cat. No. A1402 3/4" wide x 66" long **\$ 2.50 ea.**



POLYKEN MULTI-PURPOSE DUCT TAPE

Best quality duct tape with aluminum colored laminate cloth with tack rubber based adhesive.

Cat. No. 6001 2" wide x 180 ft. long **\$ 8.95 ea.**



BULLET 3 in 1 Piercing Valve

Install on the high side as a PERMANENT VALVE on the job. The BULLET Piercing Valve will not leak and cannot be budged with a Stillson wrench. The only multi-size valve with a permanent gasket. Only 2 inch clearance is required for installation and operation. One size for 1/4, 5/16, 3/8 inch

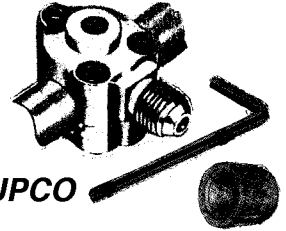

tubing. Installs on round or uneven tubing. **The Only Tap Valve Guaranteed Not To Leak On The High Side.**

Cat. No. 8024 Mfg. No. BPV-31 **\$ 4.95 each**

SAME AS ABOVE 2 SIZES ONLY 1/2 and 5/8"
 For Air Conditioners and Commercial Refrigeration.
 Cat. No. 8025 Mfg. No. BPV-21 **\$ 5.95 each**

1/4" SAE REFRIGERATION ACCESS VALVES W/QUICK SEAL CAPS

EXTENDED COPPER TUBE

Cat. No. Mfg. # Connection Size

4571	A31002	1/8" OD Tube	\$ 2.50 ea.
4572	A31003	3/16" OD	2.50 ea.
4573	A31004	1/4" OD	2.50 ea.
4574	A31005	5/16" OD	\$ 2.95 ea.
4575	A31006	3/8" OD	2.95 ea.
4576	A31008	1/2" OD	\$ 4.50 ea.



C & D "M" SERIES SADDLE TYPE COPPER TO COPPER LINE TAP VALVES 1/4" SAE ACCESS

Cat. No. Mfg. # OD Tube Price ea.

3330	CD5514	1/4"	\$ 4.95
3331	CD5516	5/16"	4.95
3332	CD5538	3/8"	5.50
3333	CD5512	1/2"	5.50
3334	CD5558	5/8"	\$ 5.95
3335	CD5578	7/8"	6.50

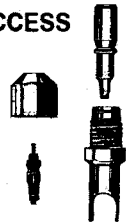

RSS UNIVERSAL AIR SWITCH

PART # RSS-495-011(210)

RANGE: .2 WC TO 1.0"WC
 SENSES: POSITIVE & NEGATIVE
 PRESSURE
 N-O AND N-C MICRO SWITCH

CAT.# 80495
\$ 29.95 each

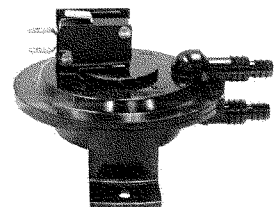

LIQUID DRIER FOR REFRIGERATION SYSTEMS

New formula all liquid Thawzone. Added to the refrigerant it circulates through the system. Chemically dries all fluoridated refrigerants, R-12, R-22, R-502, etc. Works when solid driers fail. Prevents corrosion, neutralizes acids and reduces sludge.

Cat. No. 3904 1oz. Bottle **\$ 5.95 ea.**
 Cat. No. 3905 4oz. Bottle **14.95 ea.**
 Cat. No. 3906 Pint Bottle **29.95 ea.**



WHITE-RODGERS 1609-101 COMMERCIAL TEMPERATURE CONTROL -30 Deg.F to +90 Deg.F.

White-Rodgers commercial temperature control easily adjusted with screw driver. Hydraulic action element provides close differential control, positive accuracy at any temperature on dial range. All position mounting. Range -30 deg. F. to +90 deg. F. With adjustable differential 3 deg. F. to 40 deg. F. 5 ft capillary tube, sensor bulb size 3/8 x 5-3/4" long. **Cat.#A1T975 Mfg.#1609-101 \$89.00ea.**

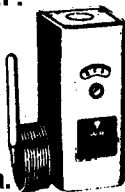

ELCO 6 WATT 230V CW CONDENSER FAN MOTOR

Hubless type fan motor 2- screw bottom mount. CW air over motor, 1400 RPM, 0.20 amp.

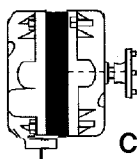

Cat.# A1MN51 Elco # N5-13222 \$19.95 ea.

ACME-MIAMI MOTOR-JOKS

LIL-JOK

*STAINLESS band - motors to 5" diameter
*Perfect for 3.3" replacement motors in air conditioners such as Whirlpool, Carrier, Frigidaire, Fedders and others with long lugs.
Cat. No. 0628 Mfg.#132 \$11.95 ea

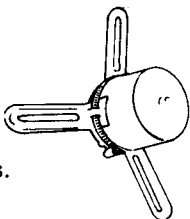

BIG-JOK

*14 ga. Stainless steel hangers 4" long
*Motors to 7" diameter
*For part-width blowers to 13" diameter
*Air conditioners and Furnaces
Cat. No. 0625 Mfg.#133 \$11.95 ea.

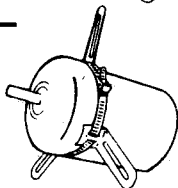

DUBL-JOK

*For full width blowers to 13" diameter
*For all motors to 7" diameter
*14 ga. steel patented hangers
*Two Stainless Steel bands grip to a full 3" of the motor for added stability and strength
Cat. No. 0626 Mfg.#134 \$13.95 ea.

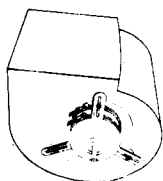

MOTO-JOK

*The old reliable for wall-mounted replacement motors
*Adjusts to fit motors 3" to 7" diameter
*Stainless Steel band for strength
Cat. No. 0600 Mfg.#136 \$10.95 ea.

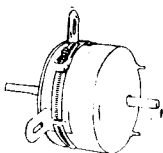

RIGID-JOK

*The newest addition to our line of JOKS. Rigid-Jok features solid 48 frame motor mounting system. Comes complete with lock-on hangers.
Cat. No. 0623 Mfg.#135 \$16.95 ea.

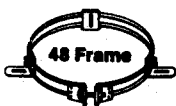

J/B REVERSIBLE RATCHET WRENCH



Double end reversible ratchet wrench features multiple openings and offer the greatest number of uses in a single wrench.

Cat.#	Square Valve Stems	Price ea.
T21124	3/16" & 1/4"	\$ 19.95
T21127	3/16", 1/4", 5/16" & 3/8"	\$ 20.95

CAP TUBE CUTTING TOOL

The sturdy design of our Cap Tube Cutter results in no collapsing of the tube, clean cuts, and no chips. **Cat.# MACL1 \$13.95 ea.**

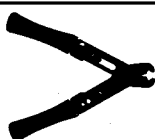

MULTI-FIT REPLACEMENT EVAPORATOR FAN MOTOR REPLACES ANY OEM EVAPORATOR MOTOR

- *115V 50/50 hz
- *Shaft: 1/8" Diameter with adaptors for 3/16" and hubless fans
- *1 Speed: 3000 RPM CW OR CCW rotation
- *Overload-Impedance protected
- *Stock one motor-save on inventory
- *Break-Off shaft
- *Mounting accessories and hardware included

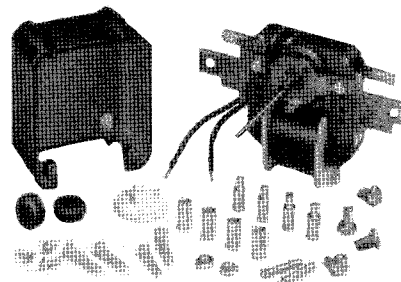

Cat.# 0200 SC99 Multi-Fit With Accessories \$26.95 ea.

HUBLESS TYPE 7, 8, 9, & 10" ALUMINUM FAN BLADES FOR GE CONDENSER FAN MOTORS - CW - AIR OVER MOTOR

Cat. No.	Diameter	Price Ea.
3706-31	7"	\$ 9.00
3806	8"	9.00
3906-31	9"	9.50
3106-31	10"	11.00
CCW ROTATION		
3706-1	7"	9.00
3706-2	8"	9.00
3706-3	9"	9.50
3706-4	10"	11.00

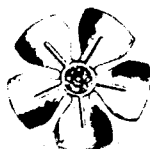

HUB TYPE ALUMINUM FAN BLADES

Designed for walk-in cooler evaporators. These fan blades can be used on Bohn, Singer, Hill, and other popular brand evaporators.

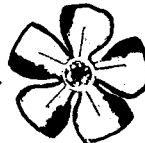

Cat. No.	Diameter	Rotation	Bore	Price Each
35504	5-1/2"	CW	1/4"	\$ 8.95
35514	5-1/2"	CCW	1/4"	8.95
30604	6"	CW	1/4"	8.95
30614	6"	CCW	1/4"	8.95
30704	7"	CW	1/4"	8.95
30714	7"	CCW	1/4"	8.95
30804	8"	CW	1/4"	9.95
30814	8"	CCW	1/4"	9.95
30805	8"	CW	5/16"	9.95
30815	8"	CCW	5/16"	9.95
31005	10"	CW	5/16"	11.95
31015	10"	CCW	5/16"	11.95
31205	12"	CW	5/16"	16.95
31215	12"	CCW	5/16"	16.95

ACME-MIAMI PLASTIC FAN BLADES

Acme-Miami plastic fan blades are made of heat-resistant celcon for truer balance smoother running no distortion. Each blade packaged in see through bags for quick identification.

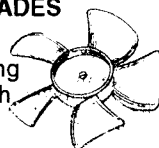

Cat.No.	Part No.	Size	Rotation	Bore	Price
0607	2303	3-1/2"	CW-White	3/16"	\$ 4.95
0608	2313	3-1/2"	CCW-Gray	3/16"	4.95
0645	2402	4"	CW	1/8"	5.95
0644	2412	4"	CCW	1/8"	5.95
0609	2402	4"	CW	3/16"	5.95
0610	2413	4"	CCW	3/16"	5.95

SAMSUNG ROTARY COMPRESSORS FOR R410A A/C AND HEAT PUMPS

CAT.#	MODEL	HP	BTU	VOLTS/PH	PRICE
A2C180	UG5T1801NVF2	1 1/2	18,000	230/1/60	\$ 225.00
A2C200	UG5C2001NXJ2	1 3/4	20,000	230/1/60	250.00
A2C220	UG5C2201NWF2	2	22,000	230/1/60	265.00
A2C250	UG5C2501NZJ2	2	25,000	230/1/60	265.00
A2C260	UG5C2601NZF2	2	26,000	230/1/60	265.00
A2C290	UG5A2901NZJ2	2 1/4	29,000	230/1/60	190.00
A2C320	UG5T3201UZF2	2 1/2	32,000	230/1/60	350.00

ALL COMPRESSORS
FOR R410A WITH
INTERNAL OVERLOAD
POE OIL CHARGE &

PANASONIC ROTARY COMPRESSORS FOR R410A MINI-SPLIT A/C'S DC FOR INVERTER SYSTEMS

A2C5KD24	5KD240XAC21	2	24,000	DC 280V	\$ 255.00
A2C5JD42	5JD420XAC22	3-1/2	42,000	DC 280V	295.00

TOSHIBA ROTARY COMPRESSORS FOR R410A MINI-SPLIT A/C'S DC FOR INVERTER SYSTEMS TWIN ROTOR BLDC STYLE COMPRESSORS

F13DA150	DA150A1F-21F1	1-1/2	15,000	DC 171V 120 Hz	\$ 195.00
F13DA220	DA220A2F-23L	2	25,000	DC 200V 120 Hz	275.00
F13DA330	DA330A2F-20M	3	35,000	DC 197V 120 Hz	295.00
F13DA422	DA422A3F-26M	4	46,000	DC 173V 120 Hz	350.00

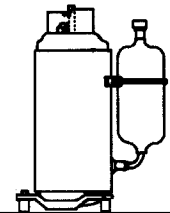

J/B HEAVY DUTY TUBE CUTTER

No. 45T12 RT70020 Tube Cutter 1/8" to 1-1/8" OD
\$45.75 each

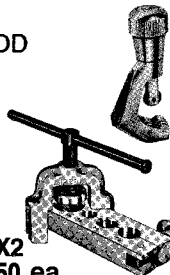

PROFESSIONAL HEAVY DUTY FLARING TOOL 45 DEGREE SAE

Bar type heavy duty forged steel yoke
slips over flaring bar and locks with turn.

Flare Sizes: 3/16", 1/4", 5/16", 3/8",
7/16", 1/2", 5/8" OD
Cat. No. 45X2
#T20195 \$ 85.50 ea.

J/B TUBE CUTTERS

No. 45T20 RT70015 Cutter 1/8 to 7/8" OD
\$33.95 each



MINI tube cutter. Designed for
service work in cramped spac-
es. Nickel chrome plated.

SUPCO FIN JACK

Cat.# 8122 FPT10 9 & 10 fins per inch
Cat.# 8123 FPT10 11, 12 & 13 fins per inch \$ 21.95 ea.
Cat.# 8124 FPT10 14, 15 & 16 fins per inch



One Year Warranty From Date Of Purchase - All Embraco Compressors On This Page

Embraco Refrigeration Compressors Refrigerant-134a For Low Back Pressure & High Back Pressure

Cat. No.	Model No.	H.P.	Low Temp. -10 deg.F.	High Temp. +45 deg. F.	Mtg. Centers	High	Length	Price Each
0330	EMI45HER	1/8	Btu 485	Btu 1465	4 x 6-1/2"	6.5"	8.42"	\$ CALL FOR PRICES
0331	EMI55HER	1/6	570	1845	4 x 6-1/2"	6.5"	8.42"	
0332	EMI70HER	1/5	705	2345	4 x 6-1/2"	6.5"	9.41"	
0333	FF8.5HBK1	1/4	820	2665	4 x 6-1/2"	8"	10.25"	
0334	FF10HBK1	1/4	920	2985	4 X 6-1/2"	8"	10.75"	
Compressors below are high starting torque for expansion valve or capillary tube application								
0337	FF10HBX1	1/4	920	3000	4 X 6-1/2"	8"	10.75"	
0338	FF12HBX1	1/3	1190	4375	4 X 6-1/2"	8"	10.75"	

All compressors complete with electrical starting components, terminal cover, oil charge, rubber grommets.

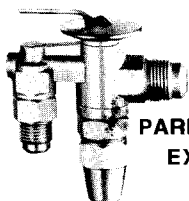

PARKER THERMOSTATIC EXPANSION VALVES

FLARE TO SWEAT ADAPTORS

CAT. NO. 4580 1/4" FL NUT TO 1/4" OD \$ 5.50
CAT. NO. 4581 3/8" FL NUT TO 3/8" OD 6.50
CAT. NO. 4582 1/2" FL NUT TO 1/2" OD 6.95

Cat. No.	Refrigerant	Nom. Tons Range	Equalizer Type	Connections SAE Inlet	Flars Outlet	Parker Model	COST	AJUSTABLE TEMP.
7570	R134A	1/4-3/4	INTERNAL	1/4"	1/2"	N-1/2-JW	\$ 125.00	NO MEDIUM
7571	R134A	1/2- 1	INTERNAL	3/8"	1/2"	N-1-JW	125.00	NO MEDIUM
7572	R404A	1/4-3/4	INTERNAL	1/4"	1/2"	N-1/2-SW	125.00	NO MEDIUM
7573	R404A	1/4-3/4	INTERNAL	3/8"	1/2"	N-1/2-SZ	125.00	NO LOW
7574	R134A	1/2-1	INTERNAL	3/8"	1/2"	C-A-JW	155.00	YES MEDIUM
7575	R134A	1-2	INTERNAL	3/8"	1/2"	C-B-JW	155.00	YES MEDIUM
7576	R134A	1-2	EXTERNAL(1/4"FL)	3/8"	1/2"	CE-B-JW	155.00	YES MEDIUM
7577	R134A	2-3	EXTERNAL(1/4"FL)	3/8"	1/2"	CE-C-JW	155.00	YES MEDIUM
7578	R404A	1/2-1	INTERNAL	3/8"	1/2"	C-A-SW	155.00	YES MEDIUM
7579	R404A	1/2-1	INTERNAL	3/8"	1/2"	C-A-SZ	155.00	YES LOW
7580	R404A	1-2	EXTERNAL(1/4"FL)	3/8"	1/2"	CE-B-SW	155.00	YES MEDIUM
7581	R404A	1-2	EXTERNAL(1/4"FL)	3/8"	1/2"	CE-B-SZ	155.00	YES LOW
7582	R404A	2- 3 1/2	EXTERNAL(1/4"FL)	3/8"	1/2"	CE-C-SW	155.00	YES MEDIUM
7583	R404A	2- 3 1/2	EXTERNAL(1/4"FL)	3/8"	1/2"	CE-C-SZ	155.00	YES LOW

FULL GAUGE CONTROLS

Controllers for walk in coolers, display coolers, walk in freezers and display freezers.

TC-900 power Cat. No. 6061 **\$139.00 each**
 MT-512 Cat. No. 6062 **\$119.00 each**

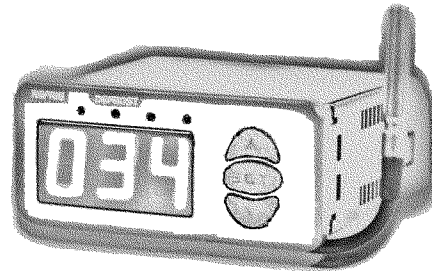

DIMENSIONS: 71x28x71 mm/ 2.8"x1.1"x2.8"

TC-900 power- For walk in and display freezers

For cooling and defrosting, works with two sensors, one being for ambient temperature and the other fixed to the evaporator that controls defrost ending. With the powerful 16-amp relay it directly controls compressors up to 1HP and uses a switch mode power supply (universal input range from 90 to 264Vac). The defrost output has a 10A current capacity, as well as having Normally Closed (NC) contact available. It also has indicators in C and F and digital filter, which have the purpose of simulating an increase of mass in the environment sensor(S1), thus increasing its response time and preventing unnecessary activation of the compressor.

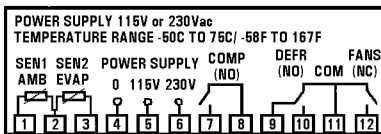

MT-512 - For walk in and display coolers (medium temp)

Featuring an off cycle defrost function, by means of compressor shutdown, and permanent ventilation, it presents one command output and an intergrated cyclic timer to set cooling and defrosting cycle. It also features an intelligent system to lock the keys and deactivate the control functions, besides a digital filter aimed at simulating an increase of mass in the environment sensor(S1) thus increasing its response time preventing unnecessary activation of the compressor. Available in 16 amp version for direct operation of compressors up to 1 HP.

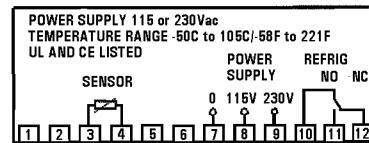

COMMERCIAL EVAPORATOR FAN MOTOR KIT

ACME 700 SERIES REVERSIBLE MOTOR KIT CONTAINS 3 FAN BLADES, MOUNTING HARDWARE AND SPECIAL "H" BRACKET 1/100HP 115V AND 230V KITS REPLACEMENT FOR BOHN, McQUAY AND OTHER Mfg's

CAT.# 0601 ACME 700 115V
CAT.# 0602 ACME 702 230V
\$26.95 EACH

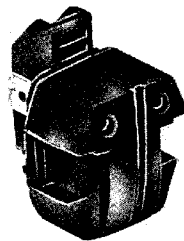
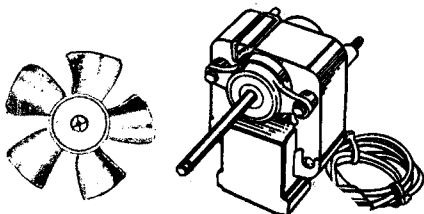

PTC SOLID STATE PUSH-ON RELAY 1/2HP TO 1/3HP 115V FOR REFRIGERATORS AND FREEZERS 4 TERMINAL USE WITH OR WITH OUT RUN CAP

CAT.# 80102
\$9.95 each
SOLID STATE RELAY

EVCO 6-IN-ONE SCREW DRIVER



Screw driver has reversible shanks. 2 Standard screwdrivers and 2 Phillips screwdrivers, plus 2 nut drivers.
 Cat. No. 0561 Mfg. # MA-9357 **\$8.95 ea.**

J/B SWAGING TOOLS

J/B swaging tools are not just a piece of steel, but a precision engineered tool for today's service technicians. They minimize the chance of leakage by reducing the number of solder joints.

Cat. No.	Mfg.#	Description	Price Ea.
4545	T21002	1/8" OD	\$ 8.95
4546	T21003	3/16" OD	9.95
4547	T21004	1/4" OD	11.95
4548	T21005	5/16" OD	13.95
4549	T21006	3/8" OD	13.95
4551	T21008	1/2" OD	15.95
4552	T21010	5/8" OD	19.95
4554	T21014	7/8" OD	32.95
4555	T21018	1-1/8" OD	52.95
4590	T21024	Swaging tool set 1/4,3/8,1/2,5/8"OD	55.95

SOLID STATE TIME DELAYS

INPUT 18-240 VAC
 10 MINUTE ADJUSTABLE
 MAX LOAD 1.5 AMPS

\$10.95 each

CAT.# 05102 DELAY ON MAKE
 CAT.# 05203 DELAY ON BREAK

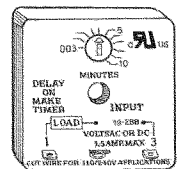



**COPELAND SCROLL AIR CONDITIONING COMPRESSORS
R-410a 230/60/1/PHASE**

**COPELAND SCROLL AIR CONDITIONING COMPRESSORS
R-410a 230/60/3/PHASE**

Cat.#	Model	H.P.	BTU	Volts/Ph	Price Ea.
F13ZP14	ZP14K5E-PFV	1-1/4	14,000	230/60/1	\$ 225.00
F13ZP16	ZP16K5E-PFV	1-1/2	16,000	230/60/1	250.00
F13ZP20	ZP20K5E-PFV	2	20,000	230/60/1	295.00
F13ZP21	ZP21K53-PFV	2	21,000	230/60/1	315.00
F13ZP24	ZP24K5E-PFV	2	24,000	230/60/1	\$ 325.00
F13ZP25	ZP25K5E-PFV	2	25,000	230/60/1	325.00
F13ZP26	ZP26K3E-PFV	2-1/4	26,000	230/60/1	350.00
F13ZP29	ZP29K5E-PFV	2-1/4	29,000	230/60/1	395.00
F13ZP31	ZP31K5E-PFV	2-1/2	31,000	230/60/1	\$ 395.00
F13ZP32	ZP32K3E-PFV	2-1/2	32,000	230/60/1	395.00
F13ZP34	ZP34K5E-PFV	3	34,000	230/60/1	425.00
F13ZP36	ZP36K5E-PFV	3	36,000	230/60/1	425.00
F13ZP38	ZP38K5E-PFV	3	38,000	230/60/1	\$ 450.00
F13ZP39	ZP39K5E-PFV	3-1/4	39,000	230/60/1	450.00
F13ZP42	ZP42K5E-PFV	3-1/2	42,000	230/60/1	475.00
F13ZP44	ZP44K5E-PFV	3-3/4	44,000	230/60/1	495.00
F13ZP51	ZP51K5E-PFV	4-1/2	51,000	230/60/1	575.00
F13ZP54	ZP54K5E-PFV	4-1/2	54,000	230/60/1	595.00

Cat.#	Model	H.P.	BTU	Volts/Ph	Price Ea.
F13ZP243	ZP24K5E-TF5	2	24,000	230/60/3	\$ 325.00
F13ZP253	ZP25K5E-TF5	2	25,000	230/60/3	325.00
F13ZP383	ZP38K5E-TF5	3	38,000	230/60/3	450.00
F13ZP393	ZP39K5E-TF5	3	39,000	230/60/3	450.00
F13ZP423	ZP42K5E-TF5	3-1/2	42,000	230/60/3	\$ 475.00
F13ZP513	ZP51K5E-TF5	4-1/2	51,000	230/60/3	575.00
F13ZP543	ZP54K3E-TF5	4-1/2	54,000	230/60/3	595.00
F13ZP613	ZP61KCE-TF5	5	61,000	230/60/3	\$ 625.00
F13ZP673	ZP67KCE-TF5	6	67,000	230/60/3	675.00

**LG SCROLL AIR CONDITIONING COMPRESSORS
R-410a 230 VOLTS 1PH 60 HZ**

Cat.#	Model	H.P.	BTU	Volts/Ph	Price Ea.
F13024K1	APA024KAA	2	24,000	230/1/60	\$ 250.00
F13026K1	APA026KKA	2-1/4	26,000	230/1/60	275.00
F13029K1	APA029KAB	2-1/2	29,000	230/1/60	285.00
F13030K1	APA030KAA	2-1/2	30,000	230/1/60	285.00
F13031K1	APG031KAC	2-1/2	31,000	230/1/60	\$ 325.00
F13038K1	AQA038KAA	3-1/4	38,000	230/1/60	350.00
F13040K1	AQA039KAA	3-1/4	39,000	230/1/60	350.00
F13040K1	AQA040KAA	3-1/4	40,000	230/1/60	\$ 375.00
F13042K1	AQA042KAB	3-1/2	42,000	230/1/60	395.00
F13049K1	ABG049KAA	4	49,000	230/1/60	450.00
F13051K1	ABA051KAE	4-1/4	51,000	230/1/60	495.00
F13054K1	ABA054KAB	4-1/2	54,000	230/1/60	525.00

**COPELAND SCROLL AIR CONDITIONING COMPRESSORS
R-410a 460/60/3/PHASE**

Cat.#	Model	H.P.	BTU	Volts/Ph	Price Ea.
F13ZP29D	ZP29K5E-TFD	2-1/4	29,000	460/60/3	\$ 395.00
F13ZP31D	ZP31K5E-TFD	2-1/2	31,000	460/60/3	395.00
F13ZP36D	ZP36K5E-TFD	3	36,000	460/60/3	425.00
F13ZP42D	ZP42K5E-TFD	3-1/2	42,000	460/60/3	475.00
F13ZP49D	ZP49K5E-TFD	4	49,000	460/60/3	550.00
F13ZP51D	ZP51K5E-TFD	4-1/2	51,000	460/60/3	575.00

COPELAND SCROLL AIR CONDITIONING COMPRESSORS R-22

Cat.#	Model	H.P.	BTU	Volts/Ph	Price Ea.	Cat.#	Model	H.P.	BTU	Volts/Ph	Price Ea.
*A1C144ZD	ZR144KCE-TFD	12	144,000	460/3/60	\$ 1395.00						
*A1C190ZD	ZR190KCE-TFD	16	190,000	460/3/60	1895.00						
*A1C50ZBD	ZB50KCE-TFD	7	79,000	460/3/60	1195.00						
*A1C76ZBD	ZB76KCE-TFD	10	119,000	460/3/60	1395.00						
*WITH SPUD-ROTO LOCK VALVES EXTRA \$ 250.00											
						F1132ZD	ZR32KA-TFD	2-1/2	32,000	460/60/3	\$ 350.00
						F1140ZD	ZR40K3-TFD	3-1/4	40,000	460/60/3	\$ 400.00
						F1142ZD	ZR42K3-TFD	3-1/2	42,000	460/60/3	425.00
						F1144ZD	ZR44KA-TFD	3-1/2	44,000	460/60/3	450.00

SAMSUNG ROTARY COMPRESSORS FOR R410A MINI-SPLIT A/C & HEAT PUMPS

CAT.#	MODEL	HP	BTU	VOLTS/PH	PRICE
A2C180	UG5T1801NVF2	1 1/2	18,000	230/1/60	\$ 225.00
A2C200	UG5C2001NXJ2	1 3/4	20,000	230/1/60	250.00
A2C220	UG5C2201NWF2	2	22,000	230/1/60	265.00
A2C250	UG5C2501NZJ2	2	25,000	230/1/60	265.00
A2C260	UG5C2601NZF2	2	26,000	230/1/60	265.00
A2C290	UG5A2901NZJ2	2 1/4	29,000	230/1/60	190.00
A2C320	UG5T3201UZF2	2 1/2	32,000	230/1/60	350.00

ALL COMPRESSORS FOR R410A WITH INTERNAL OVERLOAD POE OIL CHARGE &

BRISTOL PISTON COMPRESSORS FOR R410A A/C AND HEAT PUMPS

CAT.#	MODEL	HP	BTU	VOLTS/PH	PRICE
F13T81J38	T81J384CBCA	3-1/4	38,000	230/1/60	\$ 450.00
F13T89A51	T89A515BBCA	4-1/2	51,000	230/1/60	595.00

HARRIS STAY-SLIV 45% SILVER SOLDER



The most widely used alloy in the industry. Has lowest working temperature and excellent flow properties. Forms highly ductile joints on similar or dissimilar metals. Melting range 1125 deg. F. to 1145 deg. F. wire diameter 1/16" x 66" long.

CAT.No. 3600 1 Troy Oz. Stay-Sliv 45 **CALL FOR PRICE**

HARRIS SAFETY-SILV 45% FLUX COATED STICKS

Blue flux coated 45% silver brazing rods for copper to copper, copper to steel and steel to steel. Wire diameter 1/16" x 18"

Cat. No. 3645-1 1 pc. Flux coated rod
Cat. No. 3645-3 3 pc. Flux coated rod **CALL FOR PRICES**

HARRIS STAY-SLIV BRAZING ALLOY



STAY-SLIV 15% SILVER

For general brazing of copper to brass where higher ductility is required. 1/8" x .050 x 20"

Cat. No. 3601 1/4 lb. 7 pcs.
Cat. No. 3602 1 lb. 28 pcs. **CALL FOR PRICE**

STAY-SLIV 0%

For copper to copper joints. Fills poorly fitted joints.

Cat. No. 3604 1/8" x .050 x 20" **CALL FOR PRICE**

SOLID WIRE SOLDER FOR REFRIGERATION AND AIR CONDITIONING



Cat. No. 3606 50/50 1 lb. Spool 1/8" dia. **CALL FOR PRICES**
Cat. No. 3607 95/5 Lead Free 1 lb. Spool 1/8" dia.



SUPER TURBINE OIL FOR HIGH SPEED SHAFTS & BEARINGS

Oils everything that needs to be oiled *A real problem solver for the appliance service man. *Use on electric motor bearings *Withstands high temperature *A must for heater blowers *With pull-out spout for hard to reach equipment.

Cat. No. 80001 Part No. MO98 \$ 4.50 ea.

LEAK FOAM FINDER

Revolutionary foam refrigerant and gas leak detector. Works on the soap bubble principle but is applied as a thick creamy foam that can be spread conveniently and will not run off. Ideal for use on cold lines. Special formula will not freeze.

Cat. No. 80512 Mfg. No. DD-2 \$ 7.95 ea.



SUPCO RUST BUSTER MO-44

Loosens rust in seconds with the ZOOM SPOUT telescoping spout applicator. Quickly frees all screws nuts, shafts and frozen parts.

Cat. No. 80002 Part No. MO-44 \$ 4.50 ea.



HARRIS DYNA FLOW SOLDER 6% SILVER



With silver prices soaring, DYNAFLOW is the answer to all copper to copper joining applications. DYNAFLOW'S perfect balance of phosphorus and silver produces properties so similar to a 15% silver alloy, the only difference you will notice is the price. 28 pieces per lb. 1/8" x .050 x 20". 1/4 lb. 7 pieces.

Cat. No. 3615 1 lb. 28 pcs.
Cat. No. 3616 1/4 lb. 7 pcs. **CALL FOR PRICE**

STAY-BRITE 8- SILVER BEARING SOLDER 6% SILVER

Low-Temperature STAY-BRITE SILVER bearing solder melts at 400 deg. F., eliminates oxy-acetylene soldering. Tensile strength is four times greater than copper tubing. 14,000 PSI. Use STAY-CLEAN FLUX or any soft solder flux. 1/8" wire diameter. **USED WITH STAY-CLEAN ALUMINUM FLUX it will solder aluminum to itself or other metals.**



CALL FOR PRICE

Cat. No. 3605 Stay-Brite 1 LB. Spool 6% Silver

STAY-SLIV SILVER BRAZING FLUX

For use with high temperature silver solder. Joins all dissimilar metals other than aluminum.



Cat. No. 3608 7 oz. Brush-Top Jar **\$ 8.95 ea.**

STAY - CLEAN ALUMINUM FLUX

Use with STAY-BRITE silver bearing solder, to join aluminum to aluminum and most other metals, including stainless steel.

4 oz. plastic bottle with brush-top.
Cat. No. 3612 Aluminum Flux **\$ 13.95 ea.**



STAY-CLEAN SOFT SOLDER FLUX

For all solders melting under 700 deg. F., except aluminum.

LIQUID FLUX

Cat. No. 3610 4 oz. Flip-Spout Cap **\$ 7.95 ea.**
Cat. No. 3611 16 oz. Bottle **\$11.95 ea.**



LA-CO HEAT SEAL STICK



LA-CO HEAT SEAL STICK has been acclaimed to be a fast easy fool-proof way to repair leaks, punctures and knife wounds in refrigerator evaporators and tubing. Heat part to 400 deg. F. apply LA-CO HEAT SEAL STICK and job is done. Sets in 30 seconds, withstands 250 lbs. os pressure at 350 deg. F.
Cat. No. 4803 La-Co Heat Seal Stick **\$ 10.95 ea.**

DIAL POCKET THERMOMETER 1" DIAMETER HEAD

WITH CASE -40 deg. F to +160 deg. F.

Cat. No. 0566 \$ 7.95 ea.

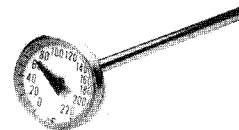

VIRGINIA QWIK-BRITE ACID COIL CLEANER

- * NEW PATENT PENDING ACID FORMULATION
- * NO HYDROFLUORIC ACID
- * HEAVY FOAMING ACTION
- * BRIGHT PINK LIQUID

1 GALLON CAT. NO. 0401

\$ 30.95 ea.

LG SCROLL R410A AIR CONDITIONING COMPRESSORS

CAT.#	MODEL	HP	BTU	VOLTS/PH	PRICE
F13024K1	APA024KAA	2	24,000	230/1/60	\$ 250.00
F13026K1	APA026KAA	2 1/4	26,000	230/1/60	275.00
F13029K1	APA029KAB	2 1/2	29,000	230/1/60	285.00
F13030K1	APA030KAA	2 1/2	30,000	230/1/60	285.00
F13031K1	APG031KAC	2 1/2	31,000	230/1/60	325.00
F13038K1	AQA038KAA	3 1/4	38,000	230/1/60	350.00
F13039K1	AQA039KAA	3 1/4	39,000	230/1/60	350.00
F13040K1	AQA040KAA	3 1/4	40,000	230/1/60	375.00
F13042K1	AQA042KAB	3 1/2	42,000	230/1/60	395.00
F13049K1	ABG049KAA	4	49,000	230/1/60	450.00
F13051K1	ABA051KAE	4 1/4	51,000	230/1/60	495.00
F13054K1	ABA054KAB	4 1/2	54,000	230/1/60	525.00

R410A ONLY

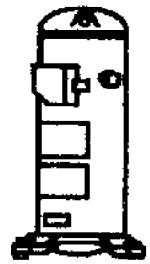

ALL COMPRESSORS
7.5"x 7.5" MOUNTING

ROTARY R22 AIR CONDITIONING AND HEAT PUMP COMPRESSORS

CAT.#	MODEL	MANUFACTURER	HP	BTU	VOLTS/PH	PRICE
F6903	RGB5472EXA	TECUMSEH	3/4	7200	115/1/60	\$ 65.00
F545492	RGA5492EXA	TECUMSEH	3/4	9200	115/1/60	99.00
F545490D	RKA5490EXD	TECUMSEH	3/4	9000	230/1/60	149.00
FQK145	QK145CGJ	L-G	3/4	10,000	115/1/60	99.00
F682P16	2P16S3R126B	MATSUSHITA	3/4	10,735	115/1/60	135.00



ALL COMPRESSORS
3 LEG MOUNT WITH
COVER & OVERLOAD

PACKARD OVAL MOTOR RUN CAPACITORS

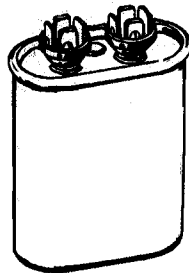

Single Section Run Capacitors 370 Volt Oval

Cat.#	MFD	Width	Depth	Height	Price Each
POC5	5	1-1/4"	2"	1-1/2"	\$ 4.50
POC7.5	7.5	1-5/16"	2-5/32"	2-3/8"	4.95
POC10	10	1-5/16"	2-5/32"	2-5/8"	5.50
POC12.5	12.5	1-5/16"	2-5/32"	3"	6.95
POC15	15	1-5/16"	2-5/32"	3-3/4"	7.25
POC20	20	1-29/32"	2-29/32"	2-5/8"	7.95
POC25	25	1-29/32"	2-29/32"	2-5/8"	7.95
POC30	30	1-29/32"	2-29/32"	3"	9.95
POC35	35	1-29/32"	2-29/32"	3-3/4"	12.95
POC40	40	1-29/32"	2-29/32"	3-3/4"	12.95
POC45	45	1-29/32"	2-29/32"	3-3/4"	13.95
POC50	50	1-29/32"	2-29/32"	4-3/4"	13.95
POC55	55	1-29/32"	2-29/32"	4-3/4"	13.95
POC60	60	1-29/32"	2-29/32"	4-3/4"	15.95
POC80	80	1-29/32"	2-29/32"	4-3/4"	20.50

PARKARD- ROUND DUAL RUN CAPACITORS

CAT.NO.	MFD	VOLTS	DIA.	HEIGHT	COST
28355	30+5	440	2"	3-7/8"	\$ 12.95
28405	40+5	440	2"	3-7/8"	14.95
28455	45+5	440	2"	3-7/8"	16.95
28505	50+5	440	2"	3-7/8"	18.95
28555	55+5	440	2"	3-7/8"	19.95
28605	60+5	440	2-3/8"	3-7/8"	19.95
28607	60+7.5	440	2-1/2"	4-3/4"	20.95

* UL AND CE APPROVED
* INDIVIDUALLY BOXED
* METAL CASES
* METALLIZED FILM
* NON-PCB OIL FILLED
* INSULATED TERMINALS
ADD 1/2" FOR TERMINALS
* 50/60 Hz MADE IN USA



**HIGH-SIDE AC LEAK REPAIR
KIT #R3 FOR AC & REFRIGERATION**
ALL IN ONE QUICK SEALING LEAK STOP,
LUBRICATOR, CONDITIONER, WITH UV
DYE TO LOCATE LARGER LEAKS

CAT.#39R3
\$69.00 each

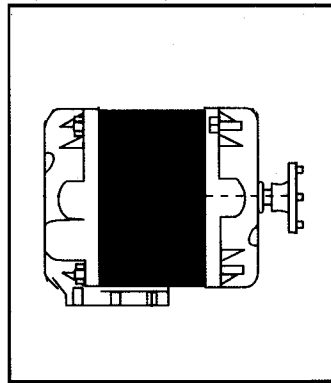

Shaded pole, 4 pole, 1550 RPM
Totally enclosed 50/60 Hz
Long life sleeve bearings
CW Rotation opposite shaft end
Nuts, screws, & fan blade adapter
included.
4 HOLE BOTTOM FOOT MOUNT.

WATTS	VOLTS	AMPS	MODEL NUMBER	PRICE Ea.
6	115	0.41	EC-6W115	\$ 79.00
6	230	0.20	EC-6W230	79.00
9	115	0.58	EC-9W115	\$ 89.00
9	230	0.35	EC-9W230	89.00
16	115	1.00	EC-16W115	\$ 99.00
16	230	0.50	EC-16W230	99.00
34	115	1.60	EC-34W115	\$ 135.00
34	230	0.80	EC-34W230	135.00

DANFOSS-SECOP COMPRESSOR
MODEL TL4G 1/8HP 230V R134A
400 btu@-10F LOW TEMP FOR
CAP TUBE WITH ELECTRICAL & POE OIL
CAT.# A1CTL4G230 \$69.00 each
230V

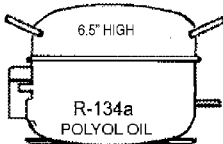

DANFOSS-SECOP COMPRESSOR
MODEL FR6G 1/5HP 230V R134A
650 btu@-10F LOW TEMP FOR
CAP TUBE WITH ELECTRICAL & POE OIL
CAT.# A1CFR6230 \$79.00 each
230V

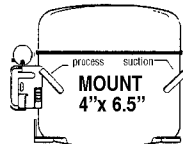

DANFOSS-SECOP COMPRESSOR
MODEL FR8.5G 1/4HP 230V R134A
LBP-800 btu HBP-3000 btu HST FOR CAP
TUBE OR TXV WITH ELECTRICAL & POE OIL
CAT.# A1CFR85230 \$99.00 each
230V

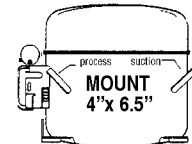

DANFOSS-SECOP COMPRESSOR
MODEL NF7MLX 1/3HP 230V R404A
LBP-1409 btu HBP-5015 btu HST FOR CAP
TUBE OR TXV WITH ELECTRICAL & POE OIL
CAT.# A1C7MLX230 \$165.00 each
230V

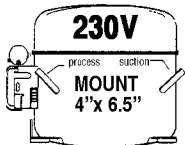

DANFOSS-SECOP COMPRESSOR
MODEL SC10CLX 1/3HP 230V R404A
1586 btu@-10F LOW TEMP HST FOR CAP
TUBE OR TXV WITH ELECTRICAL & POE OIL
CAT.# A1CSC10230V \$175.00 each
230V

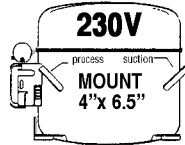

DANFOSS-SECOP COMPRESSOR
MODEL SC12G 1/3HP 230V R134A
LBP-1200 btu HBP-4200 btu HST FOR CAP
TUBE OR TXV WITH ELECTRICAL & POE OIL
CAT.# A1CSC12G230 \$175.00 each
230V

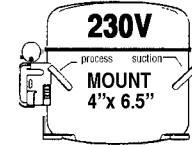

DANFOSS-SECOP COMPRESSOR
MODEL SC12CLX 1/2HP 230V R404A
LBP-2000 btu HBP-7600 btu HST FOR CAP
TUBE OR TXV WITH ELECTRICAL & POE OIL
CAT.# A1C12CLX230
\$295.00 each
230V

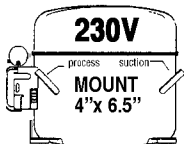

DANFOSS-SECOP COMPRESSOR
MODEL SC15G 1/2HP 230V R134A
5500 btu@45F HST FOR CAP TUBE
OR TXV WITH ELECTRICAL & POE OIL
CAT.# A1C12G230
\$325.00 each
230V

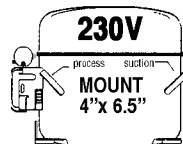

DANFOSS-SECOP COMPRESSOR
MODEL SC18MLX 3/4HP 230V R404A
LBP-3000 btu HBP-9800 btu HST FOR CAP
TUBE OR TXV WITH ELECTRICAL & POE OIL
CAT.# A1C18MLX230
\$400.00 each SWEAT
CAT.# A1C12MLX230V
\$425.00 each W/VALVE
230V

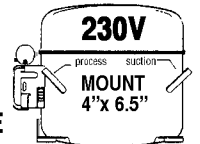

**DANFOSS-SECOP COMPRESSOR
MODEL TL2.5G 1/12HP 15V R134A**
250 BTU@-10F LOW TEMP-LST FOR
CAP TUBE WITH ELECTRICAL AND POE OIL
CAT.# F93TL25 \$89.00 each

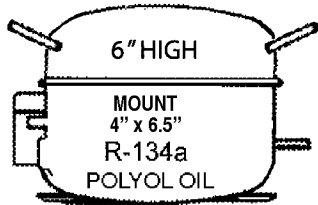

**DANFOSS-SECOP COMPRESSOR
MODEL TLS4.5F 1/8HP 115V R134A**
400 btu@-10F LOW TEMP FOR
CAP TUBE WITH ELECTRICAL & POE OIL
CAT.# F93TL45 \$110.00 each

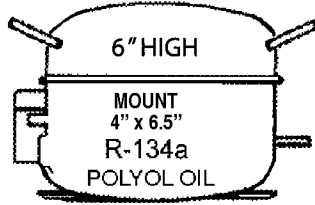

**DANFOSS-SECOP COMPRESSOR
MODEL TF4CLX 1/5HP 115V R404A**
LBP-776 btu HBP-2632 btu HST FOR CAP
TUBE OR TXV WITH ELECTRICAL & POE OIL
CAT.# A1CTL4CLX \$135.00 each

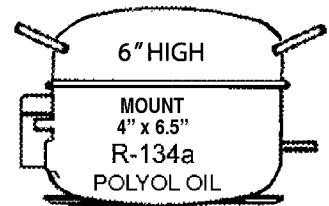

**DANFOSS-SECOP COMPRESSOR
MODEL NTY5.5FK 1/5HP 115V R134A**
700 btu@-10F LOW TEMP FOR
CAP TUBE WITH ELECTRICAL & POE OIL
CAT.# A1CNTY55 \$135.00 each

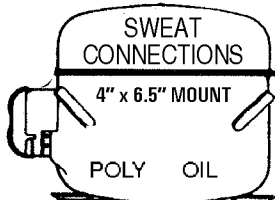

**DANFOSS-SECOP COMPRESSOR
MODEL NF5.5FX 1/5HP 115V R134A**
LBP-695 btu HBP 2500 btu HST FOR CAP
TUBE OR TXV WITH ELECTRICAL & POE OIL
CAT.# A1CNF55 \$145.00 each

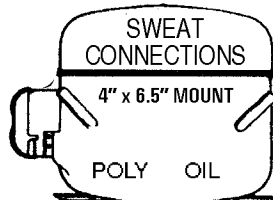

**DANFOSS-SECOP COMPRESSOR
MODEL NF6.1FX 1/5HP 115V R134A**
LBP-721 btu HBP-3065 btu HST FOR CAP
TUBE OR TXV WITH ELECTRICAL & POE OIL
CAT.# A1CNF61 \$145.00 each

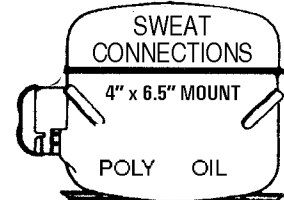

**DANFOSS-SECOP COMPRESSOR
MODEL NF6FK 1/5HP 115V R134A**
LBP-670 BTU HBP 2600 BTU LST FOR CAP
TUBE WITH ELECTRICAL & POE OIL
CAT.# A1CNF6 \$135.00 each

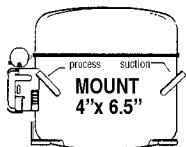

COPELAND MODEL ASE12C3E-IAA
1/6HP 115V R404A L-MBP HST
FOR TXV OR CAP TUBE
1280 btu@20F WITH
ELECTRICAL AND POE OIL
CAT.# A1C12C3E \$135.00 each

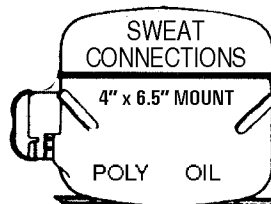

**DANFOSS-SECOP COMPRESSOR
MODEL FF8.5GX 1/4HP 115V R134A**
3217 btU@45 F HBP-HST FOR CAP
TUBE OR TXV WITH ELECTRICAL & POE OIL
CAT.# A1CFF85 \$155.00 each

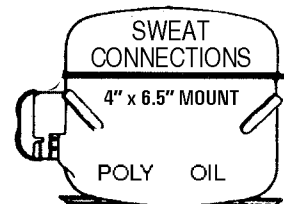

**DANFOSS-SECOP COMPRESSOR
MODEL NF9FX +1/4HP 115V R134A**
3261 btu@45F HBP-HST FOR CAP
TUBE OR TXV WITH ELECTRICAL & POE OIL
CAT.# A1CNF9 \$165.00 each

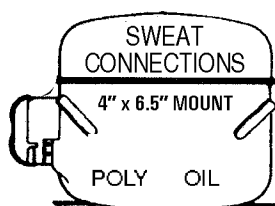

**DANFOSS-SECOP COMPRESSOR
MODEL NF10FX +1/4HP 115V R134A**
LBP-1046 btu HBP-3756 btu HST FOR CAP
TUBE OR TXV WITH ELECTRICAL & POE OIL
CAT.# A1CNF10 \$175.00 each

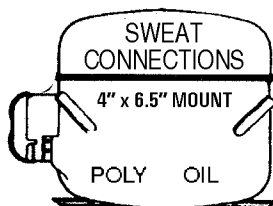

**DANFOSS-SECOP COMPRESSOR
MODEL NF11FX 1/3HP 115V R134A**
LBP-1100 btu HBP-4050 btu HST FOR CAP
TUBE OR TX WITH ELECTRICAL & POE OIL
CAT.# A1CNF11 \$185.00 each

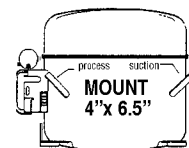

**COMMERCIAL TEMPERATURE AIR COOLED CONDENSING
UNIT 1/3 HP 115V 60 HZ 1/PH 4,000 BTU
HIGH TORQUE FOR EXPANSION VALVE OR CAP TUBE**

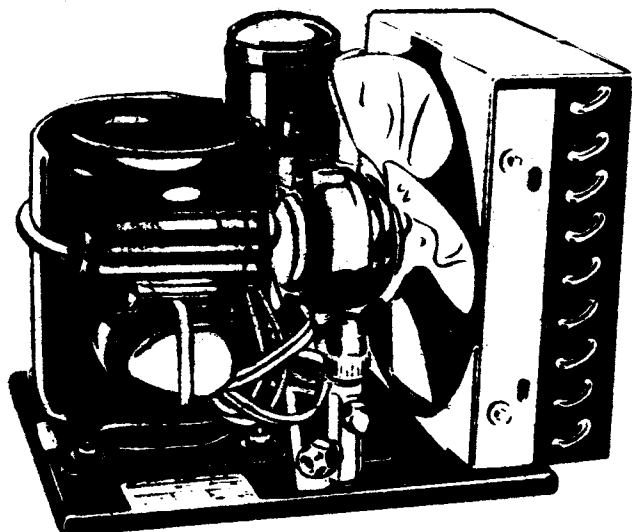

**\$395.00
EACH**

HIGH STARTING TORQUE AIR COOLED CONDENSING UNIT FOR EXPANSION VALVE OR CAPILLARY TUBE APPLICATION.*UNIT COMPLETE WITH LIQUID RECEIVER TANK, HIGH SIDE AND LOW SIDE SERVICE VALVES, AND ALL ELECTRICAL STARTING COMPONENTS.

**Remove receiver tank for capillary tube application.*

#A1C938 1/3 HP 115V 60HZ R404A/R22 POE OIL

#A1C933 1/3 HP 115V 60HZ POLY-ESTER OIL

**COMMERCIAL TEMPERATURE AIR COOLED CONDENSING
UNIT 1/4 HP 115V 60 HZ 1/PH 3,100 BTU
FOR CAPILLARY TUBE APPLICATION**

55

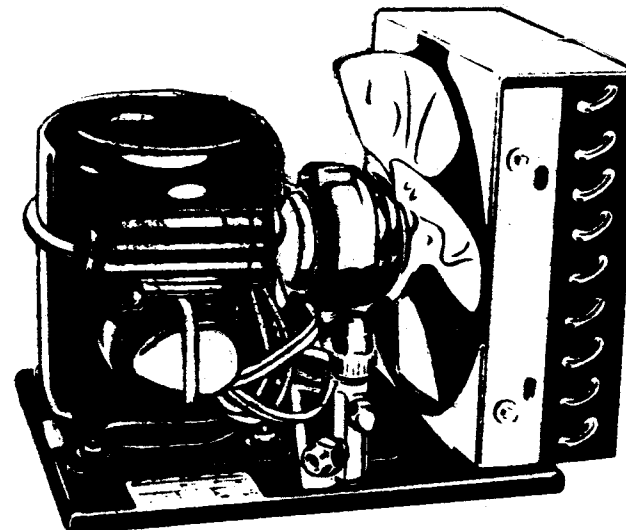

**\$375.00
EACH**

LOW STARTING TORQUE FOR CAPILLARY TUBE APPLICATION. WITH STARTING COMPONENTS AND HIGH SIDE LIQUID LINE DRIER WITH 1/4" SAE ACCESS CHARGING PORT.

#A1C937 1/4 HP 115V 60HZ R404A/R22 POE OIL

#A1C936 1/4 HP 115V 60HZ POLY-ESTER OIL

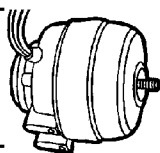

Morrill 6 W CW 230/1/60 motor. 1500 RPM. 1/4" threaded shaft. 3 hole back mount or 4 hole top and bottom mount. For up to 9" hubless fan blade.

UNIT BEARING CONDENSER MOTORS

Cat.# F3255
\$12.95 each

Cat.# F5416W
\$25.00 each

Morrill 16 W CW 230/1/60 motor. 1500 RPM. Cast Iron Body, 1/4" threaded shaft. 3 hole back mount or 4 hole top and bottom mount. For up to 10" hubless fan blade.

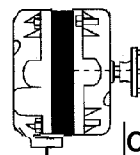
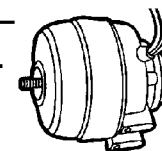

**ELCO 6 WATT 230V CW CONDENSER
FAN MOTOR**

Hubless type fan motor 2- screw bottom mount. CW air over motor, 1400 RPM, 0.20 amp.

Cat.# A1MN51 Elco # N5-13222 **\$19.95 each**

COLDPARTS, INC.

4401 S. WESTERN BLVD.
CHICAGO, IL 60609
PHONE (773) 247-8842
FAX (773) 247-8742

Domestic and Export Wholesale
Distributors of Refrigeration-
Air Conditioning - Heating - Motors
Parts and Supplies

CURRENT RESIDENT OR

PRST STD
U.S. POSTAGE
PAID
CHICAGO, IL
PERMIT NO. 4784

DANFOSS-SECOP COMPRESSOR
MODEL NF9FX +1/4HP 115V R134A
LBP-935 btu HBP-3374 btu HST FOR CAP
TUBE OR TXV WITH ELECTRICAL & POE OIL
CAT.# A1CNF9 \$165.00 each

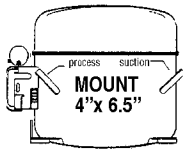

DANFOSS-SECOP COMPRESSOR
MODEL NF10FX +1/4HP 115V R134A
LBP-1046 btu HBP-3756 btu HST FOR CAP
TUBE OR TXV WITH ELECTRICAL & POE OIL
CAT.# A1CNF10 \$175.00 each

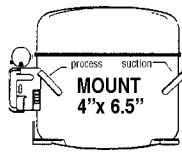

DANFOSS-SECOP COMPRESSOR
MODEL NF11FX 1/3HP 115V R134A
LBP-1100 btu HBP-4050 btu HST FOR CAP
TUBE OR TXV WITH ELECTRICAL & POE OIL
CAT.# A1CNF11 \$185.00 each

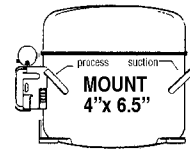

DANFOSS-SECOP COMPRESSOR
MODEL SC15G 1/2HP 115V R134A
5500 btu @45F HST MEDIUM TEMP FOR CAP
TUBE OR TXV WITH ELECTRICAL

CAT.# A1C15G
\$325.00 each SWEAT

CAT.# A1C15GV
\$350.00 each W/VALVE

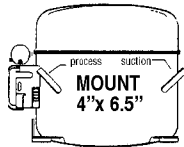

DANFOSS-SECOP COMPRESSOR
MODEL SC18G 1/2HP 115V R134A
6600 btU@45F HST MEDIUM TEMP FOR CAP
TUBE OR TXV WITH ELECTRICAL

CAT.# A1C18G
\$375.00 each SWEAT

CAT.# A1C12GV
\$400.00 each W/VALVE

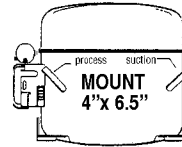

DANFOSS-SECOP COMPRESSOR
MODEL SC12MLX 1/2HP 115V R404A
LBP-2000 btu HBP- 7600 btu HST FOR CAP
TUBE OR TXV WITH ELECTRICAL & POE OIL

CAT.# A1C12MLX
\$325.00 each SWEAT

CAT.# A1C12MLXV
\$350.00 each W/VALVE

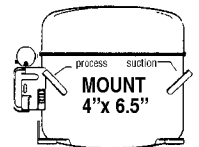

DANFOSS-SECOP COMPRESSOR
MODEL SC15MLX 3/4HP 115V R404A
LBP-2400 btu HBP-8700 btu HST FOR CAP
TUBE OR TXV WITH ELECTRICAL & POE OIL

CAT.# A1C15MLX
\$375.00 each SWEAT

CAT.# A1C15MLXV
\$400.00 each W/VALVE

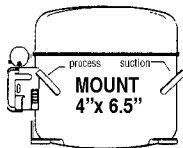

DANFOSS-SECOP COMPRESSOR
MODEL SC18MLX 115V R404A
LBP-3000 btu HBP-10,000 btu HST FOR CAP
TUBE OR TXV WITH ELECTRICAL & POE OIL

CAT.# A1C18MLX
\$400.00 ea. SWEAT

CAT.# A1C18MLXV
\$425.00 ea. W/VALVE

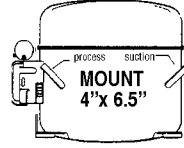

DANFOSS-SECOP COMPRESSOR
MODEL SC18MLX 3/4HP 230V R404A
LBP-3000 btu HBP-10,000 btu HST FOR CAP
TUBE OR TXV WITH ELECTRICAL & POE OIL

CAT.# A1C18MLX230
\$400.00 ea. SWEAT

CAT.# A1C18MLX230V
\$425.00 ea. W/VALVE

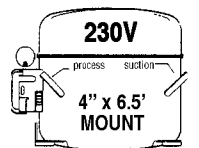

DANFOSS-SECOP COMPRESSOR
MODEL NF7CLX 1/3HP 115V R404A
LBP-1543 btu HBP-4609 btu HST FOR CAP
TUBE OR TXV WITH ELECTRICAL & POE OIL
CAT.# A1CNF7CLX \$185.00 each

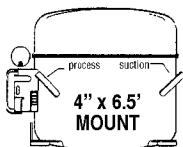

TECUMSEH MODEL AKA9427ZA
+1/3HP 115V R404A
MEDIUM TEMP HIGH TORQUE WITH
ELECTRICAL AND POE OIL SWEAT LINES

SWEAT CONNECTION
CAT.# F549427
\$250.00 ea.

1/2" SUCTION VALVE
CAT.# F549427V
\$275.00 ea.

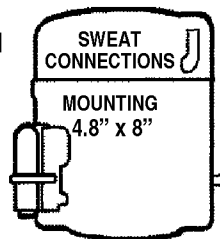

COPELAND MODEL RST55C1E-CAB
3/4HP 230V R404A L-MBP
HST FOR TXV OR CAP TUBE
WITH ELECTRICAL & POE OIL
CAT# A1C55C1E2 \$425.00 each

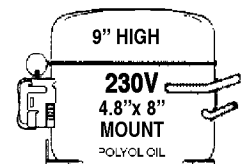

WEB SITE: www.coldparts.com EMAIL: info@coldparts.com
TOLL FREE PHONE NUMBER: 1-800-445-1281