



KAY PARK RECREATION

MAKING PLACES PEOPLE FRIENDLY • **SINCE 1954**

Family Owned and Operated

**2022
Catalog
Coupon Code:
CAT22**



American Made Quality for 68 Years!



Tables, Benches, Litter Receptacles, Grills, Bike Racks, Highway Towable Bleachers & Stages and so MUCH MORE!



1-800-553-2476 Thousands of Products Online WWW.KAYPARK.COM

Due to material price volatility, please check website for current pricing.

Kay Park Recreation

Table of Contents

Ash/Trash Rec.:

Hot Ash	25
Litter Recept.	30-33
Snuffers	27, 58
Concrete Trash	38
Windsor Select	47
Recycled Plastic	30,49
Thermoplastic	33
Strap Steel	58
Iron Valley	59

Bag Toss/Cornhole:	35
---------------------------	----

Benches:

Concrete	36, 40
Park Benches	45-46, 48-50,52, 53, 54, 56, 60-65
Aluminum Cast	66
Windsor Select	46
Thermoplastic	52-54, 56
Strap Steel Amenities	58
Iron Valley Amenities	59
Portable Benches	60-62
Stationary Benches	63-65
Player Benches	60-65, 72

Bike Storage & Racks:	67-71
----------------------------------	-------

Bleachers:	74-89
-------------------	-------

Bollards:	37
------------------	----

Car Stops	92
------------------	----

Concrete Site Amenities:	34-41
---------------------------------	-------

Crowd Control:	72
-----------------------	----

Dog Park Equipment	28-29, 42-43, 52-57
---------------------------	---------------------

Drinking Fountains:	42-43
----------------------------	-------

Grills & Fire Rings:	22-26
---------------------------------	-------

Iron Valley:	59
---------------------	----

Message Centers:	92
-------------------------	----

Outdoor Games:	34-35
-----------------------	-------

Pedal Boats:	90-91
---------------------	-------

Perforated Steel:	54-57
--------------------------	-------

Pet Waste Stations:	28
----------------------------	----

Planters:

Concrete	41
----------	----

Windsor	46
---------	----

Strap Steel	58
-------------	----

Plaques:	44
-----------------	----

Shades (Bleacher/Dugout):	73
----------------------------------	----

Snuffers:	27, 58
------------------	--------

Solar Charge Station	21
-----------------------------	----

Strap Steel Amenities:	58-59
-------------------------------	-------

Tables:

Rectangular	4-14, 17, 39, 47, 49, 51, 55, 57
-------------	----------------------------------

Round	14-17, 51, 53, 55, 57
-------	-----------------------

Square	14, 16,-17, 47, 55, 57
--------	------------------------

Pedestal	14, 47
----------	--------

Concrete	39
----------	----

Windsor Select	47
----------------	----

Recycled Plastic	4-14, 16-17, 47, 49, 51, 53
------------------	-----------------------------

Perforated Steel	53, 55, 57
------------------	------------

Umbrellas:	18-21
-------------------	-------

Windsor Select Site Amenities:	46-47
---------------------------------------	-------

Our Guarantee:

Kay Park guarantees all materials and workmanship (except labor and transportation) for one year, excluding vandalism, misuse, and acts of God. Claim for defects must be filed within one year, accompanied by copy of original invoice or invoice number.

Quick Ship Symbol

Look for this symbol to indicate Quick Ship items. Quick Ship items will ship in 7 business days from receipt of order. For quantities above 4 call for lead-time.

2 Day Shipping



Look for this symbol to indicate 2 day shipping items. For quantities up to approximately 4 only. Inquire for larger quantities.

Kay Park Recreation

Kay Park Recreation has been a manufacturer of commercial outdoor furniture since 1954. We offer a large selection of park and playground equipment and commercial grade site furnishings, including outdoor tables, grills, benches, trash containers, drinking fountains, planters, umbrellas, bollards, shade canopies and bike racks. We have a complete line of bleachers and grandstands, as well as some outdoor athletic equipment, ADA products and a rental heavy-duty fiberglass pedal boat.

Please browse through our selection and feel free to contact us if you have any questions.

1-800-553-2476, sales@kaypark.com, www.kaypark.com

Our Manufacturing Facility



Our Mission Statement:

We do this to help you build and fulfill your vision of people friendly environments. One that invites people to stay, enjoy your space with new acquaintances, friends and family. Every place has different needs and we are here to help bring your needs to life. We see cities, parks, ball fields and your people spaces across America busy with people who are staying as long they wish because the amenities are comfortable, functional and inviting.

Every design choice, every material choice and product choice is challenged by the question “Is this people friendly?”. For decades, starting with our founder Keith Borglum, a good enough design has never been good enough. Our products are built to last so that the next time you are buying products, it is because you want new designs.



2022

J2 Series Welded Frame Tables - 2 3/8" O.D. Pipe, Galvanized After Fabrication



Galvanized Frame Only

Frame Only Plus Hardware

J2G-6	Galvanized Frame for 6'	108 Lbs
J2G-8	Galvanized Frame for 8'	108 Lbs
J2G-12	Galvanized Frame for 12'	146 Lbs
J2C-6	Coated Frame for 6'	108 Lbs
J2C-8	Coated Frame for 8'	108 Lbs
J2C-12	Coated Frame for 12'	146 Lbs



2 Day Shipping Galvanized Only

Shown: J2C-6 Frame Only



Shown: 6J2CF Fiberglass

Fiberglass Plank Table

6J2GF	6' Galvanized Frame	223 Lbs
8J2GF	8' Galvanized Frame	269 Lbs
6J2CF	6' Coated Frame	223 Lbs
8J2CF	8' Coated Frame	269 Lbs

Fiberglass:

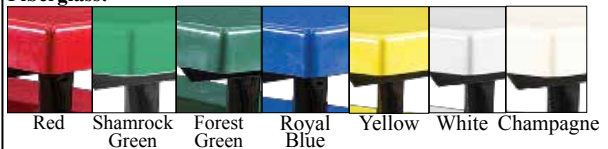

Shown: 6J2CRRP Recycled Plastic

Recycled Plastic Plank Table

6J2GRRP	6' Galvanized Frame	261 Lbs
8J2GRRP	8' Galvanized Frame	333 Lbs
6J2CRRP	6' Coated Frame	261 Lbs
8J2CRRP	8' Coated Frame	333 Lbs

Recycled Plastic:



Cedar Gray Brown
Steel Reinforced

WARNING: Cancer and Reproductive Harm www.P65Warnings.com

- 2 3/8" O.D. pipe
- Hot dip galvanized after fabrication or powder coated black
- Center cleat holds top level
- 1 5/16" O.D. Cross braces stabilize this extra heavy frame
- Convenient walk-thru design and welded rigidity can stand up to rough use
- This frame can be purchased as a frame set only, including hardware, or with your choice of planking to make a complete table

*American Made
Quality You Can Trust*

Anchors



UGANCH	Under ground table anchor	1 Lbs
CANCH2G	Set of 4 Galvanized table clamp	1 Lbs
CANCH2C	Set of 4 Coated table clamp	1 Lbs

J2 Series Welded Frame Tables



Shown: 6J2GVP Vinyl Plastisol

Quality Thick Vinyl Plastisol:

Additional Colors Available
Please Inquire



Black Brown Green Blue Gray

Plastisol Plank (PVC) Table

6J2GVP	6' Galvanized Frame	265 Lbs
8J2GVP	8' Galvanized Frame	333 Lbs
6J2CVP	6' Coated Frame	265 Lbs
8J2CVP	8' Coated Frame	333 Lbs



WARNING: Cancer and Reproductive Harm www.P65Warnings.com



Shown: 6J2GW Wood

Treated Southern Yellow Pine Wood Plank Table

6J2GW	6' Galvanized Frame	215 Lbs
8J2GW	8' Galvanized Frame	255 Lbs
12J2GW	12' Galvanized Frame	386 Lbs
6J2CW	6' Coated Frame	215 Lbs
8J2CW	8' Coated Frame	225 Lbs
12J2CW	12' Coated Frame	386 Lbs



Shown: 6J2GA Aluminum

Aluminum Plank Table

6J2GA	6' Galvanized Frame	147 Lbs
8J2GA	8' Galvanized Frame	165 Lbs
12J2GA	12' Galvanized Frame	249 Lbs
6J2CA	6' Coated Frame	147 Lbs
8J2CA	8' Coated Frame	165 Lbs
12J2CA	12' Coated Frame	249 Lbs

CJ Series Welded Frame Tables - 1 5/8" O.D. Pipe, Galvanized After Fabrication



Shown: CJC-6
Frame Only



Galvanized
Frame Only

Frame Only Plus Hardware

CJG-6	Galvanized Frame for 6'	79 Lbs
CJG-8	Galvanized Frame for 8'	79 Lbs
CJG-12	Galvanized Frame for 12'	122 Lbs
CJC-6	Coated Frame for 6'	79 Lbs
CJC-8	Coated Frame for 8'	79 Lbs
CJC-12	Coated Frame for 12'	122 Lbs



2 Day Shipping Galvanized Only



Shown: 6CJCF Fiberglass



Shown: 6CJCRRP
Recycled Plastic

Fiberglass Plank Table

6CJGF	6' Galvanized Frame	207 Lbs
8CJGF	8' Galvanized Frame	245 Lbs
6CJCF	6' Coated Frame	207 Lbs
8CJCF	8' Coated Frame	245 Lbs

Fiberglass:

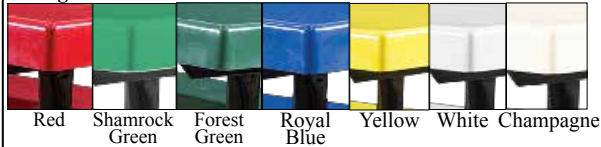

Recycled Plastic Plank Table

6CJGRRP	6' Galvanized Frame	258 Lbs
8CJGRRP	8' Galvanized Frame	298 Lbs
6CJCRRP	6' Coated Frame	258 Lbs
8CJCRRP	8' Coated Frame	298 Lbs

Recycled Plastic:



Steel Reinforced



WARNING: Cancer and Reproductive Harm www.P65Warnings.com

- 1 5/8" O.D. pipe
- Hot dip galvanized after fabrication or powder coated black
- Center cleat holds top level
- 2" x 2" x 3/16" steel angles
- 1 5/16" OD Cross braces, stabilize the table
- Convenient walk-thru design and welded rigidity can stand up to rough use
- This frame can be purchased as a frame set only, including hardware, or with your choice of planking to make a complete table

Great Value!



Anchors

UGANCH	Under ground table anchor	1 Lbs
CANCH2G	Set of 4 Galvanized table clamp	1 Lbs
CANCH2C	Set of 4 Coated table clamp	1 Lbs

CJ Series Welded Frame Tables



Shown: 6CJGW Wood

Treated Southern Yellow Pine Wood Plank Table

6CJGW	6' Galvanized Frame	199 Lbs
8CJGW	8' Galvanized Frame	241 Lbs
12CJGW	12' Galvanized Frame	362 Lbs
6CJCW	6' Coated Frame	199 Lbs
8CJCW	8' Coated Frame	241 Lbs
12CJCW	12' Coated Frame	362 Lbs



Shown: 6CJCVP
Vinyl Plastisol

Plastisol Plank (PVC) Table

6CJGVP	6' Galvanized Frame	243 Lbs
8CJGVP	8' Galvanized Frame	306 Lbs
6CJCVP	6' Coated Frame	243 Lbs
8CJCVP	8' Coated Frame	306 Lbs

Quality Thick Vinyl Plastisol:

Additional Colors Available
Please Inquire

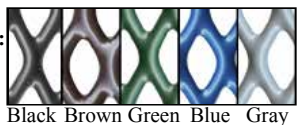

Black Brown Green Blue Gray



Shown: 6CJGA Aluminum

Aluminum Plank Table

6CJGA	6' Galvanized Frame	132 Lbs
8CJGA	8' Galvanized Frame	151 Lbs
12CJGA	12' Galvanized Frame	229 Lbs
6CJCA	6' Coated Frame	132 Lbs
8CJCA	8' Coated Frame	151 Lbs
12CJCA	12' Coated Frame	229 Lbs

 **WARNING:** Cancer and Reproductive Harm www.P65Warnings.com

2BG Series Bolted Frame Tables - 2 3/8" O.D. Galvanized Tube



Galvanized Frame Only

Frame Only Plus Hardware

682BG	Galvanized Frame for 6' or 8'	84 Lbs
682BC	Coated Frame for 6' or 8'	84 Lbs



2 Day Shipping Galvanized Only



Shown: 682BG Frame Only



Shown: 62BGF Blue Fiberglass

Fiberglass Plank Table

62BGF	6' Galvanized Frame	208 Lbs
82BGF	8' Galvanized Frame	244 Lbs
62BCF	6' Coated Frame	208 Lbs
82BCF	8' Coated Frame	244 Lbs

Fiberglass:

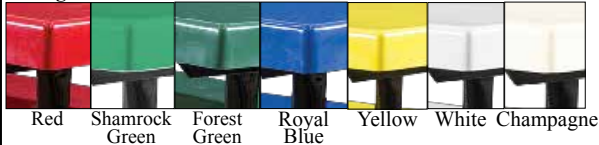

Shown: 62BGRRP Gray Recycled Plastic

Recycled Plastic Plank Table

62BGRRP	6' Galvanized Frame	257 Lbs
82BGRRP	8' Galvanized Frame	297 Lbs
62BCRRP	6' Coated Frame	257 Lbs
82BCRRP	8' Coated Frame	297 Lbs

Recycled Plastic:



Steel Reinforced



WARNING: Cancer and Reproductive Harm www.P65Warnings.com

- 2 3/8" O.D. Pre galvanized tube with a shiny clear coat standard
- 1 5/16" Cross braces stabilize this extra heavy frame
- 10 ga. steel seat brackets
- 2" x 2" steel top angles
- Powder coated black, optional at extra cost
- This frame can be purchased as a frame set only, including hardware, or with your choice of planking to make a complete table

Extra heavy - duty!



Anchors

UGANCH	Under ground table anchor	1 Lbs
CANCHIG	Set of 4 Galvanized table clamp	1 Lbs
CANCHIC	Set of 4 Coated table clamp	1 Lbs

2BG Series Bolted Frame Tables



Shown: 62BGA
Aluminum

Aluminum Plank Table

62BGA	6' Galvanized Frame	133 Lbs
82BGA	8' Galvanized Frame	151 Lbs
62BCA	6' Coated Frame	133 Lbs
82BCA	8' Coated Frame	151 Lbs



Shown: 62BGVP Red Seats Black Top Vinyl Plastisol Plank

Plastisol Plank (PVC) Table

62BGVP	6' Galvanized Frame	244 Lbs
82BGVP	8' Galvanized Frame	305 Lbs
62BCVP	6' Coated Frame	244 Lbs
82BCVP	8' Coated Frame	305 Lbs

Quality Thick Vinyl Plastisol:
Additional Colors Available
Please Inquire

Black Brown Green Blue Gray



Shown: 62BGW SYP Wood

Treated Southern Yellow Pine Wood Plank Table

62BGW	6' Galvanized Frame	198 Lbs
82BGW	8' Galvanized Frame	238 Lbs
62BCW	6' Coated Frame	198 Lbs
82BCW	8' Coated Frame	238 Lbs



WARNING: Cancer and Reproductive Harm www.P65Warnings.com

BG Series Bolted Frame Tables- 1 5/8" O.D. Galvanized Tube



2 DAY SHIPPING
Galvanized Frame Only

Frame Only Plus Hardware

68BG	Galvanized Frame for 6' or 8'	79 Lbs
68BC	Coated Frame for 6' or 8'	79 Lbs



2 Day Shipping Galvanized Only

Shown: 68BG



Shown: 6BCF Yellow Fiberglass

Fiberglass Plank Table

6BGF	6' Galvanized Frame	183 Lbs
8BGF	8' Galvanized Frame	221 Lbs
6BCF	6' Coated Frame	183 Lbs
8BCF	8' Coated Frame	221 Lbs

Fiberglass:

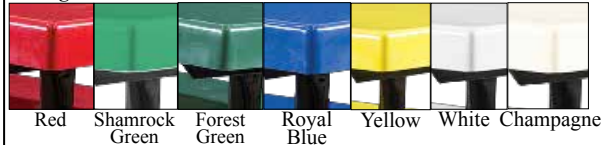

Red Shamrock Green Forest Green Royal Blue Yellow White Champagne



WARNING: Cancer and Reproductive Harm www.P65Warnings.com



Shown: 6BGW Wood Plank

Treated Southern Yellow Pine Wood Plank Table

6BGW	6' Galvanized Frame	173 Lbs
8BGW	8' Galvanized Frame	212 Lbs
6BCW	6' Coated Frame	173 Lbs
8BCW	8' Coated Frame	212 Lbs

- 1 5/8" O.D. Pre galvanized tube with a shiny clear coat standard
- 1 5/16" Cross braces stabilize this extra heavy frame
- 2" x 2" Steel top angles
- Powder coated black, optional at extra cost
- This frame can be purchased as a frame set only, including hardware, or with your choice of planking to make a complete table

Anchors



UGANCH	Under ground table anchor	1 Lbs
CANCH1G	Set of 4 Galvanized table clamp	1 Lbs
CANCH1C	Set of 4 Coated table clamp	1 Lbs

*Commercial - duty
at
economical price!*

BG Series Bolted Frame Tables- 1 5/8" O.D. Galvanized Tube



Shown: 6BGRRP Brown Recycled Plastic Plank

Recycled Plastic

Recycled Plastic:



Cedar Gray Brown

Steel Reinforced



6BGRRP	6' Galvanized Frame	233 Lbs
8BGRRP	8' Galvanized Frame	275 Lbs
6BCRRP	6' Coated Frame	223 Lbs
8BCRRP	8' Coated Frame	275 Lbs



Shown: 6BGVP Yellow Seats Blue Top Vinyl Plastisol Plank

Plastisol Plank (PVC) Table

6BGVP	6' Galvanized Frame	219 Lbs
8BGVP	8' Galvanized Frame	281 Lbs
6BCVP	6' Coated Frame	219 Lbs
8BCVP	8' Coated Frame	281 Lbs

Quality Thick Vinyl Plastisol:

Additional Colors Available
Please Inquire



Black Brown Green Blue Gray

 **WARNING:** Cancer and Reproductive Harm www.P65Warnings.com



Aluminum Plank Table

6BGA	6' Galvanized Frame	108 Lbs
8BGA	8' Galvanized Frame	126 Lbs
6BCA	6' Coated Frame	108 Lbs
8BCA	8' Coated Frame	126 Lbs

J2GWC Welded Frame Tables - 2 3/8" O.D Pipe



Universal Access Table - 2 Wheelchair Spaces

- 2 3/8" O.D. Pipe
- **ADA 24" Overhang 30" W and 29" H Clearance**
- Galvanized after fabrication or powder coated black
- Dual end ADA access
- *Standard frame galvanized 'G' change to 'C' for powder coat*

8J2G-UWC	8' Frame only	138 Lbs
8J2GW-UWC	8' Treated SYP Wood	282 Lbs
8J2GA-UWC	8' Aluminum	201 Lbs
8J2GF-UWC	8' Fiberglass	269 Lbs
8J2GVP-UWC	8' Vinyl Plastisol (PVC)	342 Lbs
8J2GRRP-UWC	8' Recycled Plastic	340 Lbs



8J2CA-UWC
Aluminum

Add ADA Without Losing Seats!



8J2CVP-UWC
Plastisol



Safe Sturdy Design



End Access Table - 1 Wheelchair Space

- 2 3/8" O.D. Pipe
- **ADA 24" Overhang 30" W and 29" H Clearance**
- Galvanized after fabrication or powder coated black
- 6' Seats with 8' Top
- Patented anti-tip extensions
- *Standard frame galvanized 'G' change to 'C' for powder coat*

8J2G-EWC	8' Frame only	106 Lbs
8J2GW-EWC	8' Treated SYP Wood	250 Lbs
8J2GA-EWC	8' Aluminum	169 Lbs
8J2GF-EWC	8' Fiberglass	237 Lbs
8J2GVP-EWC	8' Vinyl Plastisol (PVC)	310 Lbs
8J2GRRP-EWC	8' Recycled Plastic	308 Lbs



8J2CVP-EWC
Plastisol

← Anti-tip extensions.



Side + End Access Table - 2 Wheelchair Spaces

- 2 3/8" O.D. Pipe
- **ADA 24" Overhang 30" W and 29" H Clearance**
- Galvanized after fabrication or powder coated black
- Side Plus End Access
- Patented anti-tip extensions (pat#6116681)
- *Standard frame galvanized 'G' change to 'C' for powder coat*

8J2G-SEWC	8' Frame only	120 Lbs
8J2GW-SEWC	8' Treated SYP Wood	250 Lbs
8J2GA-SEWC	8' Aluminum	177 Lbs
8J2GF-SEWC	8' Fiberglass	255 Lbs
8J2GVP-SEWC	8' Vinyl Plastisol (PVC)	315 Lbs
8J2GRRP-SEWC	8' Recycled Plastic	300 Lbs



← Anti-tip extensions.

8J2CRRP-SEWC
Recycled Plastic

← Patented Seat Stabilizer Bracket

Plank Color Options For Page 12 & 13

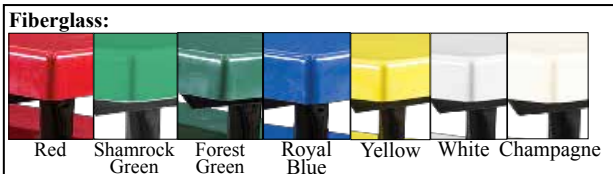

WARNING:
Cancer and Reproductive Harm
www.P65Warnings.com
Fiberglass & Vinyl Plastisol

Recycled Plastic:



J2GWC Welded Frame Tables - 2 3/8" O.D Pipe



6J2GW-SWC
SYP Wood

Side Access Table - 1 Wheelchair Space



- 2 3/8" O.D. Pipe
- **ADA 24" Overhang 30" W and 29" H Clearance**
- Galvanized after fabrication or powder coated black
- Side Access
- *Standard frame galvanized 'G' change to 'C' for powder coat*

*See Page 23 & 26 For
ADA Grills and Fire Rings!*

6J2G-SWC	6' Frame only	107 Lbs
6J2GW-SWC	6' Treated SYP Wood	213 Lbs
6J2GA-SWC	6' Aluminum	155 Lbs
6J2GF-SWC	6' Fiberglass	225 Lbs
6J2GVP-SWC	6' Vinyl Plastisol (PVC)	251 Lbs
6J2GRRP-SWC	6' Recycled Plastic	251 Lbs
8J2G-SWC	8' Frame only	107 Lbs
8J2GW-SWC	8' Treated SYP Wood	246 Lbs
8J2GA-SWC	8' Aluminum	167 Lbs
8J2GF-SWC	8' Fiberglass	252 Lbs
8J2GVP-SWC	8' Vinyl Plastisol (PVC)	311 Lbs
8J2GRRP-SWC	8' Recycled Plastic	305 Lbs

Round ADA Table - 1 Wheelchair Space



- 1 5/8" O.D. Pipe
- **ADA 24" Overhang 30" W and 29" H Clearance**
- Standard frame powder coated black 'C'

RTRCFADA	Frame w/ Fiberglass top & seats	153 Lbs
RTRCVPADA	Frame w/ Plastisol top & seats	336 Lbs
RTRCFVPSADA	Frame w/ Fiberglass top & Plastisol seats	376 Lbs



RTRCFADA
Fiberglass

*Thicker, Softer Protection
For Long-Lasting
Durability.*

Quality Thick Vinyl Plastisol:
Additional Colors Available
Please Inquire



WARNING:
Cancer and
Reproductive Harm
www.P65Warnings.com
Fiberglass & Vinyl Plastisol

2022

Pedestal Tables



4SPT Series Table - 6" Square Tube Frame

- 6" Square Pedestal 2 1/2" square tube arms
- 48" Square Top
- Heavy center cross braces
- Powder coated black
- Surface mount add "SM"
- Change "C" to "G" for Galvanized Frame

4SPTC	Frame only 48" x 48"	256 Lbs
4SPTCW	Treated SYP Wood 48" x 48"	367 Lbs
4SPTCA	Aluminum 48" x 48"	321 Lbs
4SPTCF	Fiberglass 48" x 48"	391 Lbs
4SPTCVP	Vinyl Plastisol (PVC) 46" x 46"	393 Lbs
4SPTCRP	Recycled Plastic 48" x 48"	435 Lbs



Backrest Available
Pg 16



Octagon Top

4SPTGVPSM
Plastisol

Octagon Top Table - 6" Square Tube Frame

- 6" Square Pedestal 2 1/2" square tube arms
- 48" Square Top
- Heavy center cross braces
- Powder coated black
- Surface mount add "SM"
- Change "C" to "G" for Galvanized Frame

4SPTCFO	Fiberglass 48" x 48"	396 Lbs
4SPTCVPO	Vinyl Plastisol (PVC) 46" x 46"	398 Lbs



6SPTGASM
Aluminum

6SPT Series Table

- 6" Square Pedestal 2 1/2" tube arms
- Surface mount add "SM"
- Change "C" to "G" for Galvanized Frame

6SPTC	Frame only	212 Lbs
6SPTCW	6' Treated SYP Wood	332 Lbs
6SPTCA	6' Aluminum	264 Lbs
6SPTCF	6' Fiberglass	343 Lbs
6SPTCVP	6' Vinyl Plastisol (PVC)	378 Lbs
6SPTCRP	6' Recycled Plastic	430 Lbs



RSPTCVPSM
Plastisol

RSPTGVP Series- Round Vinyl Plastisol Table

- 6" Square Pedestal 2 1/2" square tube arms
- Powder coated black
- Surface mount add "SM"
- Change "C" to "G" for Galvanized Frame

RSPTCVP	Plastisol - Single Post	402 Lbs
RSPTCF	Fiberglass - Single Post	402 Lbs
RSPTCVPADA	ADA	380 Lbs

Recycled Plastic:



Cedar Gray Brown
Steel Reinforced

Plank Color Options For Page 14 & 15

Quality Thick Vinyl Plastisol:
Additional Colors Available
Please Inquire



Black Brown Green Blue Gray



WARNING:
Cancer and
Reproductive Harm
www.P65Warnings.com
Fiberglass & Vinyl Plastisol



**RTRCVP
Plastisol**

RTRVP Series Table - Round Vinyl Plastisol

- 1 5/8" O.D. Pipe
- 48" Diameter Top
- PVC coated #9 expanded metal
- Frame galvanized after fabrication or powder coated black
- Umbrella hole

RTRCVP	Black Frame	354 Lbs
RTRGVP	Galv. Frame	354 Lbs
RTRCVPADA	Black Frame ADA	336 Lbs
RTRGVPADA	Galv. Frame ADA	336 Lbs



**RTRCF
Fiberglass**

RTRF Series Table - Fiberglass

- 1 5/8" O.D. Pipe
- 48" Diameter Top
- Fiberglass top & seats coated with Ultragel
- Frame galvanized after fabrication or powder coated black
- Umbrella hole - **add- "U"** to model number

RTRCF	Black Frame	255 Lbs
RTRGF	Galv. Frame	255 Lbs
RTRCFADA	Black Frame ADA	180 Lbs
RTRGFADA	Galv. Frame ADA	180 Lbs

ADA Tables
Page 13

Custom Game Top Shown

**Chess Pieces
Not Included**



*Logo Inlay
Additional
Cost*

RTRFVPS Series Table - Fiberglass/Vinyl Plastisol

- 1 5/8" O.D. Pipe
- 48" Diameter Top
- Fiberglass top coated with Ultragel
- PVC seats coated #9 expanded metal
- Frame galvanized after fabrication or powder coated black
- Umbrella hole - **add- "U"** to model number

RTRCFVPS	Black Frame	402 Lbs
RTRGFVPS	Galv. Frame	402 Lbs
RTRCFVPSADA	Black Frame ADA	376 Lbs
RTRGFVPSADA	Galv. Frame ADA	376 Lbs



*Customize Your Tables
Call For Pricing*

RTR3CFVPS 36" Top Table - Fiberglass/Vinyl Plastisol

RTR3CFVPS	Black Frame	235 Lbs
RTR3GFVPS	Galv. Frame	235 Lbs

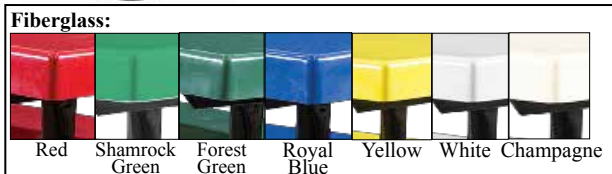

WARNING:
Cancer and
Reproductive Harm
www.P65Warnings.com

Umbrella Stabilizer Brace
on Round table frames.



2022

Square, Octagon Tables and Back Rests



4SJCF
Fiberglass

4SJ Series- 1 5/8" O.D. "J" Style Frame

- 1 5/8" O.D. Pipe
- Heavy center cross braces
- Frame galvanized after fabrication 'G' or powder coated black 'C'
- Fiberglass umbrella hole - add- "U" to model number

4SJC	Frame Only	108 Lbs
4SJCW	SYP Wood- 48"x48"	234 Lbs
4SJCA	Aluminum- 48"x48"	168 Lbs
4SJCF	Fiberglass- 48"x48"	238 Lbs
4SJCVP	Vinyl Plastisol (PVC)- 4"x46"	349 Lbs
4SJCRP	Recycled Plastic- 48"x48"	338 Lbs



4SJCVP
Plastisol

Octagon Top- 1 5/8" O.D. "J" Style Frame

- 1 5/8" O.D. Pipe
- Heavy center cross braces
- Frame powder coated black 'C' change to 'G' for galvanized
- Fiberglass umbrella hole - add- "U" to model number

4SJCFO	Fiberglass 48" x 48"	243 Lbs
4SJCVP	Vinyl Plastisol (PVC) 46" x 46"	354 Lbs



Steel Reinforced

Backrests- Optional

- One pair of brackets with one 36" long backrest plank.

BackrestW	Treated SYP Wood	36 Lbs
BackrestA	Aluminum	30 Lbs
BackrestF	Fiberglass	40 Lbs
BackrestVP	Vinyl Plastisol (PVC)	30 Lbs
BackrestRP	Recycled Plastic	43 Lbs

Fiberglass:

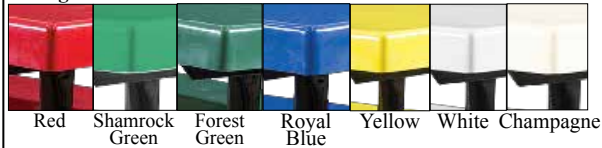

Recycled Plastic:



Steel Reinforced

Quality Thick Vinyl Plastisol:

Additional Colors Available
Please Inquire



Black Brown Green Blue Gray



WARNING:
Cancer and
Reproductive Harm
www.P65Warnings.com

Fiberglass & Vinyl Plastisol

Choose plank and frame colors when ordering

Child Sized Tables

Rectangle Child Size- 1 5/8" O.D.

- 1 5/8" O.D. Pipe Frame
- Plastisol coated 3/4" No. 9 expanded metal
- Choose powder coat frame: black, blue, red, yellow or green

4CSVPT	4' Table	140 Lbs
6CSVPT	6' Table	175 Lbs
8CSVPT	8' Table	198 Lbs



**6CSVPT
Plastisol**

Square Child Size- 48" Square

- 1 5/8" O.D. Pipe Frame
- Plastisol coated 3/4" No. 9 expanded metal
- Choose powder coat frame: black, blue, red, yellow or green

CS4SJCW	48" Sq. Syp Wood	224 Lbs
CS4SJCA	48" Sq. Aluminum	158 Lbs
CS4SJCF	48" Sq. Fiberglass	228 Lbs
CS4SJCVP	46" Sq. Vinyl Plastisol	239 Lbs
CS4SJC RP	48" Sq. Recycled Plastic	292 Lbs



**CS4SJCVP
Plastisol**

Quality Thick Vinyl Plastisol:

Additional Colors Available
Please Inquire

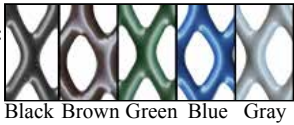

Black Brown Green Blue Gray

Round Vinyl Plastisol Child Size- 1 5/8" O.D.

- 1 5/8" O.D. Pipe Frame
- Plastisol coated 3/4" No. 9 expanded metal
- Choose powder coat frame: black, blue, red, yellow or green

CSRTRGVP	48" Dia top Galv. Frame	280 Lbs
CSRTRCVP	48" Dia top Pwder Coated	280 Lbs



**CSRTRCVP
Plastisol**

Impact Absorbing, Kid Friendly Coating!

Round Fiberglass Child Size- 1 5/8" O.D.

- 1 5/8" O.D. Pipe Frame
- Fiberglass top & seats coated with Ultragel
- Choose powder coat frame: black, blue, red, yellow or green

CSRTRGF	48" Dia top Galv. Frame	215 Lbs
CSRTRCF	48" Dia top Powder Coated	215 Lbs

Fiberglass:



Red Shamrock Green Forest Green Royal Blue Yellow White Champagne



**CSRTRCF
Fiberglass**

WARNING:
Cancer and
Reproductive Harm
www.P65Warnings.com
Fiberglass & Vinyl Plastisol

Umbrellas



Square Umbrellas Wind Resistant

- 6' or 7 1/2' fiberglass ribs
- 7 1/2' and 9' diameter
- 1 1/2" 1 piece aluminum pole white or bronze finish
- .065 wall thickness
- Push up or Pulley & Pin
- No Tilt

ULSQ6MP 6' Marine Grade, Pulley & Pin 24 Lbs

ULSQ6MU 6' Marine Grade, Push Up 24 Lbs

ULSQ7MP 7 1/2' Marine Grade, Pulley & Pin 24 Lbs

Marine Grade Fabric Colors:



Detail of Crank

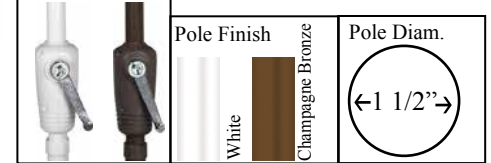

Garden Valance 6 Rib Wind Resistant

- 6 fiberglass ribs
- 3/8" Dia.
- 7 1/2' diameter
- 1 1/2" 2 piece aluminum pole white or bronze finish
- .065 wall thickness
- Textilene Fabric
- Crank mechanism
- No Tilt

UVFL7-TC 7 1/2 ft Textilene crank 15 Lbs

Colors:

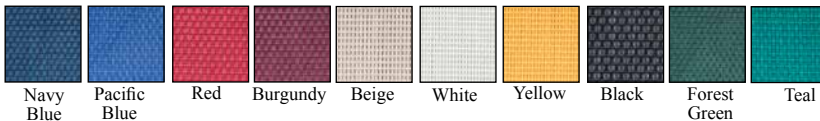

Market Octagon 8 Rib Wind Resistant

- 8 fiberglass ribs
- 1/2" Diam.
- 7 1/2', 9' or 11' diameter
- 1 1/2" 2 piece aluminum pole white or bronze finish .080 wall thickness
- Crank, push up or pulley and pin
- No Tilt

UOM7MC	7 1/2' Marine grade fabric, crank	17 Lbs
UOM7MU	7 1/2' Marine grade fabric, push up	17 Lbs
UOM9MC	9' Marine grade fabric, crank	19 Lbs
UOM9MP	9' Marine grade fabric, pulley & pin	19 Lbs
UOM11MP	11' Marine grade fabric, pulley & pin	20 Lbs

Marine Grade Fabric Colors:



Detail of Crank

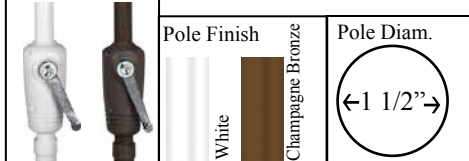

Detail of Hub

Commercial Ultra Heavy Wind Resistant

- 8 fiberglass ribs
- 1/2" Dia.
- 7 1/2', 9' or 11' diameter
- 1 1/2" 1 piece aluminum pole white or bronze finish .125 wall thickness
- Push up or pulley and pin
- No Tilt

ULP7MU	7 1/2' Marine grade fabric, push up	15 Lbs
ULP9MU	9' Marine grade fabric, push up	17 Lbs
ULP11MP	11' Marine grade fabric, pulley & pin	26 Lbs

Marine Grade Fabric Colors:



Champagne Bronze Pole

Note: Alternating colors are available. Add "A" to model and 10% to price.



5 Year Warranty on Fabric!

5 Year no fade fabric warranty!



Detail of Hub

Wind Resistant Umbrellas

Specially designed for windy conditions. A wind vent in the top lets air out and 'fishing pole type fiberglass ribs will flex with the wind, but do not break! They come with powder coated aluminum poles. Tops are easily changed - buy- extra tops to quickly change your color scheme! Ask rep for pricing.

Umbrellas & Umbrella Bases



Fiberglass:

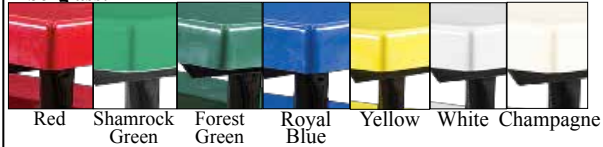

Fiberglass Umbrellas

- Weather-resistant fiberglass
- 7 1/2 ft diameter
- 1 1/2" Pole
- Ultragel coating 20 mils UV inhibitors

UF Fiberglass w/pole swivels 81 Lbs



WARNING: Cancer and Reproductive Harm www.P65Warnings.com

Concrete Bases

- 19" diameter
- 7 1/2' and 9' diameter umbrellas only
- Powder coated black finish
- 14" sleeve height 1 1/2"- 1 3/4" diameter

UBCW White concrete base 50 Lbs
UBCC Bronze concrete base 50 Lbs
UBCB Beige concrete base 50 Lbs



This base does not fit under Thermoplastic or Hex Tables

Heavy-Duty Steel Bases

- 30" square thick steel
- Black powder coat finish
- 12 1/2" sleeve height 2" diameter

UBSL30 Umbrella base 200 Lbs



U Brace Umbrella Anchor

- Prevents umbrella from coming out
- No maintenance
- Attaches to umbrella pole underneath table top
- Stainless steel
- Ships UPS

UBRACE Anchor 2 Lbs

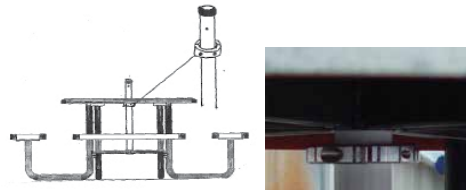



Solar Charge Station

- Standard 4 USB ports, 2 Apple, 2 Andriod
- 2.1 amp fast charge
- 100 watt solar panel
- 7 amp hour sealed lead acid battery back-up
- Black color hub housing
- 1 1/2" O.D. Pole
- Fiberglass umbrella kit or Powder coated steel ring kit

KCSSUF Fiberglass Umbrella Kit 156 Lbs
KCSSSR Powder Coated Steel Ring Kit 165 Lbs

If purchased to go with a concrete table an umbrella bracket is required

Table Purchased Separately

Great For:

*Malls, Courtyards, Parks, Resorts, Pools
 Amusements, Schools, Colleges, Fairs*

*Ring Kit
 Shown with
 Fiberglass
 Table*



Powder Coat Colors:
Black
Red
Burgundy
Forest Green
Royal Blue
Yellow
White
Tan

*Makes places people friendly
 Allows people to
 charge multiple devices!
 Keeps people at your
 outdoor facility longer!
 Great addition to any venue!*

Pedestal Grills



SBD60035

- Dual 302 Sq. Inch Cook Surface
- 1/2" Rods on 1" Centers
- 3/16" Steel Body
- 3 1/2" Galvanized Pedestal
- Rotates 360 Degrees
- Optional Utility Shelf
- Dual 4 Position Cook Surface
- Vandal Resistant
- High Heat Paint or Hot Dip Galvanized Fire box

Dual 302 Sq. Inch Cook Sp.
3600 Rotation
Dual 4 Position Cooking Surface
3 1/2" Pedestal

SBD60035	Standard (3 1/2") Ped.	140 Lbs
UT	Optional utility shelf	10 Lbs



SB400

- 392 Sq. Inch Cook Surface 14"x28"
- 1/2" Rods on 1" Centers
- 3/16" Steel Body
- 2 3/8" or 3 1/2" Galvanized Pedestal
- Rotates 360 Degrees
- Optional Utility Shelf
- 4 Position Cook Surface
- Vandal Resistant
- High Heat Paint

392 Sq. Inch Cook Sp.
3600 Rotation
4 Position Cooking Surface
2 3/8" or 3 1/2" Pedestal

SB400	Standard (2 3/8") Ped.	101 Lbs
SB40035	Grill with 3 1/2" Ped.	110 Lbs
UT	Optional utility shelf	10 Lbs



Surface Mount Option:
See Page 23



Cooking Surface Cut From Single Piece of 5/16" Steel Plate

SB16FI Flat Iron Grill

- 300 Sq. Inch Cook Surface 15"x20"
- 3/16" Steel Body
- 2 3/8" or 3 1/2" Galvanized Pedestal
- Rotates 360 Degrees
- Optional Utility Shelf
- 4 Position Cook Surface
- Vandal Resistant
- High Heat Paint

300 Sq. Inch Cook Sp.
3600 Rotation
4 Position Cooking Surface
2 3/8" or 3 1/2" Pedestal

SB16FI	Standard 2 3/8" Ped.	79 Lbs
SB16FI35	Grill with 3 1/2" Ped.	88 Lbs
UT	Optional utility shelf	10 Lbs



7 Business Days



Entire Page WARNING:

Cancer and Reproductive Harm
www.P65Warnings.com



Call For Your Personalized Grates!



Only Models:
SB16
SB16ADA

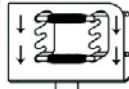

SB16 Grill

- 300 Sq. Inch Cook Surface 15"x20"
- 1/2" Rods on 1" Centers
- 3/16" Steel Body
- 2 3/8" or 3 1/2" Galvanized Pedestal
- Rotates 360 Degrees
- Optional Utility Shelf
- 4 Position Cook Surface
- Vandal Resistant
- High Heat Paint or
- Hot Dip Galvanized Fire box

SB16	Standard (2 3/8") Ped.	79 Lbs
SB16G	Galv. body	79 Lbs
SB1635	3 1/2" Ped.	88 Lbs
SB1635G	3 1/2" Ped. & gal. body	88 Lbs
UT	Optional utility shelf	10 Lbs
UTG	Optional galv. utility shelf	10 Lbs
SM	Add Surface Mount Option - See Below	



SB16ADA Wheel Chair Accessible Grill

- 300 Sq Inch Cook Surface 15"x20"
- 1/2" Rods on 1" Centers
- 3/16" Steel Body
- 2 3/8", or 3 1/2" O.D. Galvanized Pedestal
- Rotates 360 Degrees
- Easy Swivel Cook Surface
- High Heat Paint

SB16ADA	2 3/8" Pedestal Grill	80 Lbs
SB16ADA3.5	3 1/2" Pedestal Grill	89 Lbs
UTADA	Optional utility shelf	10 Lbs
Add surface mount option		



ADA Pedestal Grill

WARNING: Cancer and Reproductive Harm www.P65Warnings.com



Only Models:
SF16



SF16 Grill

- All the features of the SB16 with the added feature of a flip back cook surface.

SF16	Standard (2 3/8") Ped.	79 Lbs
SF16G	Galv. body	79 Lbs
SF1635	3 1/2" Ped.	88 Lbs
SF1635G	3 1/2" Ped. & gal. body	88 Lbs
UT	Optional utility shelf	10 Lbs
UTG	Optional galv. utility shelf	10 Lbs
Add surface mount option		

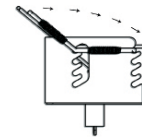

Hot Dip Galvanized Body
SB16 and SF16 only are available with hot dip galvanized body. Cooking grate coated with black high heat paint. Please add "G" to model number.



Grill Cover
Black Vinyl Cover with drawstring closure fits standard pedestal grills.

PGCOVER 2 Lbs



Utility Shelf
Utility Shelf - 8"x20" x 3/16" bolts onto rear. Available for grills above. Model "UT" is painted black and model "UTG" is galvanized. Not available for ADA Pedestal SB16ADA



Surface Mount
To add surface mount to any grill on this page add "SM" to model number and a increase in price.

Group Grills



SPD450 - Large Group Grill

- 1368 Sq Inch Cook Surface 38"x36"
- 1/2" Rods on 1" Centers
- 3/16" Steel Body
- 6" Square Pedestal (Anchors Included)
- 12"x36" Bolt On Utility Shelf
- Adjustable 4 Position Fire Grate
- Flip up Grates for Easy Fire Building
- High Heat Paint
- Surface mount is standard

SPD450 Standard w/1 shelf SM 460 Lbs

SPD450IG In ground mount 460 Lbs

SPDUT Additional shelf 29 Lbs

 7 Business Days



**Room to Cook Enough
Food For a
Family Reunion!**

 **WARNING:** Cancer and Reproductive Harm www.P65Warnings.com



SB3628U - Medium Group Grill

- 1008 Sq Inch Cook Surface 28"x36"
- 1/2" Rods on 1" Centers
- 3/16" Steel Body
- 6" Square Pedestal (Anchors Included)
- 10"x28" Bolt On Utility Shelf
- 2 Separately Adjustable Cook Surfaces
- High Heat Paint
- Surface mount is standard

SB3628U Standard (6" sq ped) SM 246 Lbs

SB3628UIG In ground mount 266 Lbs

 7 Business Days



XB16 - Small Group Grill

- 860 Sq Inch Cook Surface 18"x 48"
- 1/2" Rod on 1" Centers
- 3/16" Steel Body
- Two 2 3/8" O.D. Galvanized In Ground Posts
- 4 Position Adjustable Cook Surface
- High Heat Paint
- In ground mount is standard

XB16 Standard (2 peds) IG 197 Lbs

XB16SM Surface Mount 177 Lbs

 7 Business Days

2022



←
Shown with
Optional Warming
Basket



Only for
ECG1929
ECG1941

Covered Grills

- 320 or 500 Sq. In Cook Surface
- 1/2" dia. Non removable steel cooking grates
- 14 ga. Sheet Steel
- 10 ga. steel plate fire box
- 11 ga. steel end panels
- 360 degree rotation heat and smoke control
- 3 1/2" O.D. pedestal
- High heat, non-toxic, black enamel
- Utility Shelf included

ECG1929	320 Sq. in 19.5"x29.25"x16.5"	155 Lbs
ECG1941	500 Sq. in 19.5"x41.5"x16.5"	198 Lbs
ECPCB	Optional portable casters	29 Lbs
ECQB29	Optional warming basket	16 Lbs
ECQB41	Optional warming basket	12 Lbs



2 Day on **ECG1929** **ECG1941**



WARNING: Cancer and Reproductive Harm www.P65Warnings.com



Ash Shovel

ASHSHOVEL Ash Shovel 1 Lbs



Recommended for any public picnic grounds where charcoal grills are being used!



Steel Coal Ash Receptacle

- 23" Square top funnels to 12"
- Holds 32 gallon trash
- Or let goals fall to concrete slab

KPHCB	23" Square Recept.	90 Lbs
CG32HDNL	32 Gal Galv. Can 25 gauge	15 Lbs
KPHCBSM	Surface mount	5 Lbs
KPHCBANCH	Ground Anchors	3 Lbs



Concrete Options:
Concrete colors and aggregate textures.

	Smooth	Light Sand Blast	Perma Stone	Dura Brite
Dove Gray				
Terra Cotta				
Light Brown				
Sand Tan				

Hot Ash Receptacle

- 22"sq. x 35" tall
- Welded steel bars on top
- Select color and texture when ordering

CHAR2235 650 Lbs

Select Texture: Smooth, Light Sand Blast, Perma Stone or Durabrite
Select Color: Dove Gray, Terra Cotta, Light Brown or Sand Tan

Fire Rings

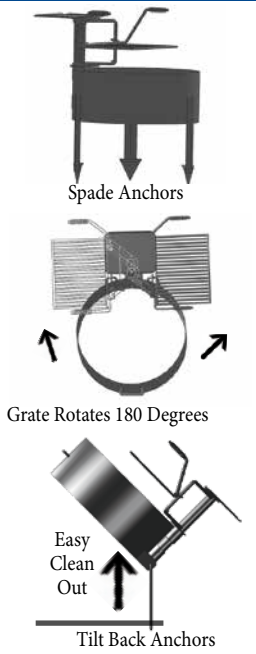

Grate adjust-ability means you can put the heat where you want it!



UFR30 Creates the Ultimate Cooking Experience!

UFR30 "The Ultimate" Fire Ring

- 300 Sq. Inch Cook Surface 15"x20"
- 1/2" Rods on 1" Centers
- 30" Diameter
- 12" High Sides
- Grate Swings 180 Degrees
- Integrated Utility Shelf
- Cool Spring Handles
- Vandal Resistant
- High Heat Paint & Rust-Resistant Black Enamel

UFR30TB	UFR30 Tilt back staples	116 Lbs
UFR30SAS	UFR30 Spade anchors	121 Lbs



Flip - Up Grate
Flips out of the way!

FR30 Fire Ring

- 300 Sq. Inch Cook Surface 15"x20" grate
- 1/2" Rods on 1" Centers
- 30" Diameter
- 3/16" thick steel
- "TB" = tilt back hinges
- "SAS" = spade anchors
- Cool Spring Handles
- 4 Heights Available

FR730TB	7" High tilt back staples	69 Lbs
FR730SAS	7" High spade anchors	74 Lbs
FR930TB	9" High tilt back staples	88 Lbs
FR930SAS	9" High spade anchors	95 Lbs
FR1130TB	11" High tilt back staples	105 Lbs
FR1130SAS	11" High spade anchors	116 Lbs
FR1830WCSAS	18" High Sides ADA Compliant fire ring	130 Lbs



AFG80 Fire Ring

- 300 Sq. Inch Cook Surface 15"x20"
- 1/2" Rods on 1" Centers
- 34" Diameter
- 6" High Sides (18" High Sides for ADA)
- 4 Adjustable Cooking Heights
- Reinforcing Angle Across Pit
- Cool Spring Handles
- Vandal Resistant
- High Heat Paint & Rust-Resistant Black Enamel
- AFG80WCSAS is ADA compliant

AFG80TB	AFG80 Tilt back staples	86 Lbs
AFG80SAS	AFG80 Spade anchors	91 Lbs
AFG80WCSAS	ADA Compliant fire ring	167 Lbs

WARNING:
Cancer and
Reproductive Harm
www.P65Warnings.com

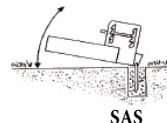

Fire Ring Anchor Options:

ADA units
have spade
anchors



Classico Smoker's Outpost

Perfect for entrances, designated smoking areas and more! Save on Maintenance with no messy sand or continual clean up. The steel pail liner safely collects cigarette waste and makes cleaning easy and convenient. Patented oxygen-restricting design extinguishes cigarettes quickly - no sand or water needed. 40" height encourages use and makes disposing cigarette waste easy and convenient. Durable all-steel construction is fire-safe, won't melt or burn. The textured powder-coated finish, won't rust or discolor pavement. Airtight screw closure attaches base to lid; base-to-lid security chain included to deter theft. Pre-drilled hole in base for bolt-down hardware. Keyhole cigarette opening discourages unwanted litter. Select Color: Bronze, black or pewter.

CSO 40"H x 15"D 15 Lbs



Upscale!
Attractive appearance and steel construction enhances your image by keeping cigarette butts out of sight and hidden from public view.

Safe Smoker

Cigarette receptacle is made of high density polyethylene with UV inhibitors and a flame retardant additive. The tubular top design restricts oxygen to extinguish burning butts. It keeps rain out and odors in. Top is easily removed to empty the internal 4 gallon galvanized collection bucket. Sand can be added to give weight, or use the integrated hold down tabs to bolt it down. Aesthetic appeal for indoor or outdoor use.

Select color: Beige, black, brown, and gray.

SSCR 17 1/2" dia. x 43" high 11 Lbs



Thermoplastic Cigarette Snuffer

This thermoplastic coated ash urn is available in different colors and styles to suit your design needs.

- 11" Diameter x 24 1/2" High
- Choose from Expanded Metal, Perforated Steel or Slatted Steel
- Choose from multiple colors
- Comes Free Standing with Holes for Surface Mount

MCAUSS Slatted Steel 25 Lbs
MCAUPS Perforated Steel 20 Lbs
MCAUEXP Expanded Metal 19 Lbs

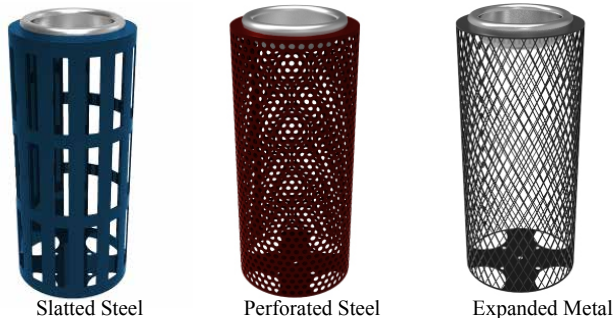

Thermoplastic Colors:



Smoker's Butler

Add neatness and a look of class to your facility, indoors or at the entrance. The industrial poly material has the look of beautiful granite. The 9" diameter 25" high snuffer holds 3,000 butts. When full, simply twist the lid off and empty. No messy buckets.

SBCR 9" dia. x 25" high 21 Lbs

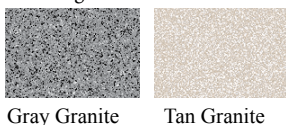

**Holds Up to
 3,000 Cigarette Butts!**

Dogipot Pet Waste Disposal System - 2 Year Ltd Warranty



Dispenser Only

Dogipot Poly Station

- Forest Green Poly Dispenser
- Forest Green 10 gal Poly Trash Receptacle
- Snap on Lid (holds bag in place)
- 2" x 2" x 4'-8" poly telescopic mounting post with installation hardware
- Clearly Printed Instructions on Top
- Locked Bottom Compartment
- Aluminum DOGIPOT Pet Sign (Choice of On or Off leash)
- 2 Litter Bag Rolls @ 200 Bags Each
- 50 Ten Gal. Trash Liner Bags
- Mounting Hardware

KDP1010 Poly station, complete 23 Lbs



Dispenser Only

Dogipot Pet Station

- 15.5" x 9.4" x 3.25" Aluminum Bag Dispenser
- Locking Front Access Panel
- Clearly Printed Instructions
- "Please clean up after your dog"
- 2 Rolls (200 ea.)
- 8" Telescoping Gal. Steel Post for Direct Bury
- 10 Gallon Steel Trash Receptacle with Lid
- 50 Heavy-duty Drawstring Trash Liner Bags
- 12" x 18" Aluminum DOGIPOT Pet Sign (Choice of On or Off leash)

KDP1003 Pet station, complete 62 Lbs
KDP1003BLK Black Complete Station 62 Lbs



Dispenser Only

Dogipot Header Station

- Aluminum DOGIPOT Pet Sign (Choice of On or Off leash)
- 15.5" x 9.4" x 3.25" Aluminum Bag Dispenser
- 12 Gauge Aluminum
- Powder Coated Forest Green
- Clearly Printed Instruction on Top
- 4-100CT Cards
- 10 Gallon Steel Trash Receptacle with stainless steel lid. (Can be upgraded to include the all Aluminum Trash)
- Box of 50 Count Liner Trash Bags
- Mounting Hardware

KDP1003HP Junior Header Station 29 Lbs
KDP1003HPBLK Black Header Station 29 Lbs

Dogipot Poly-Dispenser Only

- 17" x 9.4" x 3.25" Poly Bag Dispenser
- Locking Front Access Panel
- Forest Green 2.5 mm Poly Dispenser
- Clearly Printed Instructions on Top
- 2 Diamond Bag Dispenser Slots
- 400 Litter Bags Installed
- Mounting Hardware

KDP1007 Poly, dispenser only 6 Lbs

Dogipot-Dispenser Only

- 15.5" x 9.4" x 3.25" Aluminum Bag Dispenser
- Locking Front Access Panel
- Clearly Printed Instructions
- "Please clean up after your dog"
- 400 Litter Bags Installed
- Mounting Hardware

KDP1002 Junior, dispenser only 8 Lbs

Dogipot Header-Dispenser Only

- 15.5" x 9.4" x 3.25" Aluminum Bag Dispenser
- Locking Front Access Panel
- 12 Gauge Aluminum
- Powder Coated Forest Green
- Clearly Printed Instruction on Top
- 4-100CT Cards
- Mounting Hardware

KDP1002HP Junior, dispenser only 9 Lbs

Dogipot Bags



Brown litter bags come in 10, 20 or 30 roll cases of 200 ct each roll. (10 roll case is 2,000 total bags, less than 5 cents each!)

KDP140210 12 Lbs
KDP140220 24 Lbs
KDP140230 36 Lbs



Header Packs

- Fits header dispenser
- 100 Bags per Header Pack
- 20 Header Packs Per Case
- Clearly Printed Instructions on each header pack
- Perforated Tear Away Bag

KDP1402HP20 1 Header Case 10 Lbs



Trash liner bags - 50 Heavy-duty 10 gallon drawstring bags. (50 total bags, less than 44 cents each!)

KDP1404 6 Lbs



Mutt Mitt Refill Card

Mutt Mitt Refills - 10 cards per case, 80 Mitts stapled to a card. (800 Mitts). Each of 2 plys 1.0 mil thick. Made in U.S.A.

MMREFILLS 2 Ply 18 Lbs

More Mutt Mitt Online!

2022

Make Your Dog Park Play Friendly!



Triple Hoop Jump

- 46" L x 39" H
- 3 Hoops
- 1/2" Rods
- Puppy, Kay and Doghouse Logos
- Powder Coated Frame

K9P3H 3 Hoop Jump 20 Lbs

Hoop **Blue**
Colors **Red**
Green



Double Hoop Jump

- 46" L x 34" H
- 2 Hoops
- 1/2" Rods
- Puppy and Kay Logos
- Powder Coated Frame

K9P2H 2 Hoop Jump 18 Lbs



Dog A Ramp

- 118" L x 28" W x 40" H
- 1 1/2" X 3/16" Steel Angle Plank Support
- 1 5/8" Tubular Uprights
- Black Powder Coated Frame
- Cedar and Brown Recycled Plastic Slats

K9PDR Dog Peak Ramp 254 Lbs



Platform

- 36" Square x 12" High
- 1 1/2" x 3/16" Steel Angle Plank Support
- 1 5/8" Tubular Uprights
- Black Powder Coated Frame
- Cedar Recycled Plastic Slats

K9PPT Platform 82 Lbs



Dog Tunnel

- HDPE with UV Stabilizer
- 12" Galvanized tie down stakes
- Aluminum Anchors
- Outside 37" H x 41" W x 61" L
- Flat Tunnel Bottom w/Traction Panels
- Material is resistant to most chemicals to make clean up easy..

K9PDT Dog Tunnel 105 Lbs



Fire Hydrant

- 25" H X 16" W
- 6" Round Steel Tube
- 4" Round Arms
- Red Powder Coated

K9PFH Fire Hydrant 46 Lbs



Leash Post

- 36" High
- 2 3/8" Steel Tube
- 1/2" Rod Leash Holder
- Surface mount plate w/stakes
- Powder Coated Frame

K9PLP Leash Post 32 Lbs

Leash Post
Colors **Blue**
Red
Green

Litter Receptacles



132 LR Series

- 32 gal each
- Engraved tops
- 2" x 4" slats available

- Recycled plastic or
- Pressure Treated Yellow Pine
- Lids & Liners sold separately

Frame Only	132LRP	36 Lbs
Southern Yellow Pine Slats	132LRSYPP	98 Lbs
Recycled Plastic Slats	132LRPP	102 Lbs

Surface Mount		
132LRSM	39 Lbs	
132LRSPSM	111 Lbs	
132LRPSM	105 Lbs	

In Ground		
132LRIG	42 Lbs	
132LRSPIG	114 Lbs	
132LRPIG	108 Lbs	



Galvanized Dome Lid
DLG55
23 3/4" ID, 12 Lbs
\$191.00

Plastic Dome Lid
DLMP32-55
24" ID, 10 Lbs
\$105.00



CP32 11 Lbs
CG32 13 Lbs
CG32LID 3 Lbs

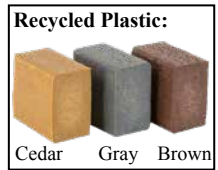

Recycled Plastic:

Best Selling Litter Receptacle



Triple Square Bin Recycling Center

- 96 Gallon Total
- 32 gal each
- Engraved tops
- 1" x 4" slats available
- Gray, Cedar and Green
- Heavy-Duty Zine Coated Hardware
- Liners sold separately

JP3SRC	3-Square Bins	230 Lbs
JP32LINER	32 gal. Liner	6 Lbs

Recycled Plastic Colors:



Square Bin Recycled Plastic Recycling Container

- 32 gal
- Engraved tops
- 1" x 4" slats
- Gray, Cedar and Green
- Liners sold separately
- Specify - Glass, Cans, Bottles, Paper, Plastic, etc.
- Place multiple squares side by side to create a recycling center

JP32SRC	32 Gallon Receptacle	90 Lbs
JP32LINER	32 gal. Liner	6 Lbs



*Recycling Do Your Part
Keep It Green*

CPW Can Posts

CPW timber canpost is a 6" x 6" post in a treated pine or recycled plastic post for direct bury. Powder coated steel arms support cans at handle and bottom. Chains are provided to prevent loss of lid. Holds 32 or 20 gallon cans that are sold separately.

CPW-S	Single side wood holder	56 Lbs
CPW-D	Double side wood holder	62 Lbs
CPH-D	Double side hardware only	20 Lbs
CPRP-S	Single side recycled plastic holder	71 Lbs
CPPR-D	Double side recycled plastic holder	77 Lbs
CPH-S	Single side hardware only	10 Lbs
CG32	32 Gallon Can	13 Lbs
CG32LID	32 Gallon Lid	3 Lbs
CG20	20 Gallon Can	11 Lbs
CG20LID	20 Gallon Lid	3 Lbs



Tippy Trash

- 52 Gallon
- 2-3/8" O.D.
- Powder Coated Steel
- Unlock and tip
- Custom lettering on solid band
- Black, Brown, or Green
- Lids Sold Separately

TT52IG	52 Gal. In Ground	110 Lbs
TT52SM	52 Gal. Surf. Mt	100 Lbs
TT52LID	27 Inner Dome Lid	12 Lbs



52 Gallon
Unlock, Tip and Go!

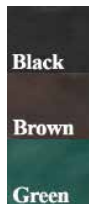

Steel Mesh Basket

Designed to withstand constant use and harsh weather conditions. See-through mesh means they don't blow over easily in strong winds and the tapered design permits nesting for storage. These baskets will hold up to 52 gallons of trash in a light weight basket which is ideal for high traffic area where trash must be emptied often. These units feature reinforced steel edges and bottom drain holes. Specify your choice of galvanized (silver), or powder coat (C) color (green, red, black, or blue) when ordering. 23" O.D. at top.

SMTB52	52 gal. galv. mesh basket	31 Lbs
SMTB52C	52 gal. pc. mesh basket	31 Lbs



DLMP3255 lid fits this model. See page 33

Litter Receptacles



Beige Granite

Light Granite

Dark Granite

Shown in Light Granite

TUFFCAN Round 42 Gallon

- 42 Gallon
- 25" Diameter
- Virtually Indestructible
- Beige Granite
- Light Granite or Dark Granite

TC42LRD 42 Gal. Dome Top 25 Lbs
TC42LRH 42 Gal. 10" Hole Top 25 Lbs

42 Gallon Round TUFFCAN Colors:



Shown in Beige Granite

Light Granite
 Beige Granite
 Dark Granite

TUFFCAN Square, w/Dome Lid

- 32 Gallon
- 18"x18"x38"
- Rigid molded resin
- Complete with hole top
- Unique slatted appearance

TC32LRD 32 Gal. w/Dome Lid 31 Lbs



*Rigid Molded Resin:
 Unique & Durable*

Shown in Dark Granite

Light Granite
 Beige Granite
 Dark Granite

TUFFCAN Square 32 Gallon

- 32 Gallon
- 18"x18"x38"
- Rigid molded resin
- Complete with hole top
- Unique slatted appearance

TC32LRH 32 Gal. w/Hole Top 25 Lbs

Round Litter Receptacles

Vinyl Plastisol 32 Gallon Receptacle

Choose other items from our vinyl plastisol line for a complete look. Choose colors to go with any design or choose school colors to show school spirit.

- 22 Gallon, 32 Gallon or 55 Gallon
- 3/4" No 9 Expanded Metal
- Heavy PVC Coating, UV and Mildew Resistant
- Choose Portable, Surface Mount or In Ground Mount
- Available in several colors
- Lids and liners sold separately
- Two Piece Design

- 132LRVP** 32 Gal. Freestanding 70 Lbs
- 132LRVPIG** 32 Gal in ground 70 Lbs
- 132LRVPSM** 32 Gal surface mount 70 Lbs



Recycle Dome
DLMP32-55P
24" ID,
10 Lbs



Plastic Dome
DLMP32-55
24" ID,
10 Lbs

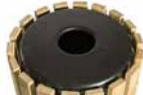

Steel 8" Hole
FLS8-32
17Lbs

Blue Only

Plastic Dome Colors:



Red Yellow Blue Green Gray Brown Black



Plastic Liners
CP32
11 Lbs

Quality Thick Vinyl Plastisol:

Additional Colors Available
Please Inquire



Black Brown Green Blue Gray



WARNING: Cancer and Reproductive Harm www.P65Warnings.com

Thermoplastic 32 Gallon Receptacles

A great option to match you school colors or make our playgrounds more colorful.

- Comes Standard as Portable
- In Ground and Surface Mount kits available
- 1/2" Perforated
- Slatted Steel
- Expanded Metal
- Lids and Liners Sold Separately

- MCPS32LR** Perforated 32 Gal. 81 Lbs
- MCSS32LR** Slatted Steel 32 Gal. 110 Lbs
- MC32GALEXP** Expanded Metal 32 Gal. 70 Lbs



Perforated Steel



Slatted Steel



Expanded Metal



Steel Dome Top
MCDT
20 Lbs



Flat Top
MCFT
20 Lbs



Ash bonnet top
MCABT
26 Lbs



Black Plastic liner
for use with 32 Gal.
Litter receptacles.
MCLR32L 9 Lbs



Portable Mount
Comes Standard



Surface Mount
MCPSLRSM



In-Ground Mount
MCPSLRIG

Thermoplastic Colors:



Black Brown Green Dk. Blue Lt. Blue Red Burgundy Purple Tan

Kay Park Pong Table

New!



Disc-Connect 4

- Outdoor concrete Connect 4
- Heavy duty reinforced concrete
- Weather proof
- Virtually maintenance free
- Bead blast finish Stainless Steel
- Secured with stainless steel tamper resistant security screws
- Includes a concrete Disc collection tray 43"x"wx4 3/4" 105 lbs
- 48 Discs included

Disc-Connect Only:

KPDC 54" L x 42" H x 4" W 350 Lbs

Disc Connect with Support Base:

KPDCWSB 60" x 30" x 3" 446 Lbs

KPDCDISCS 48 Discs, Red & Blue Only 5 Lbs



Tamper Resistant Security Screws

Disc Collection Tray

Two New Outdoor Ping Pong Tables!



Weatherproof Steel Nets

Outdoor Ping Table

- Thicker panel for better bounce
- Panels made from resin laminate for weather resistance
- Softmat coating to reduce sun glare
- Frame made from noncorrosive aluminum/zinc alloy
- Table top made from High Pressure Laminate
- Resistant to blows, impacts, color fading
- Soft protection pads on each order
- Frame made form zinc and aluminum alloy
- Fixed Steel Net with non corrosive treatment
- Racket holds added to the sides to store 4 rackets
- Ball dispensers under the table top
- Choose from Blue or Gray Top

CNPRO510MGR 9'L x 5'W x 30"H Gray 172 Lbs
CNPRO510MBL 9'L x 5'W x 30"H Blue 172 Lbs

10 Year Table Top Warranty!

Rugged Outdoor Ping Table

- 9 MM thick resin laminate panel for perfect bounce
- Structure made form galvanized steel
- Table top made from High Pressure Laminate
- Resistant to blows, impacts, color fading
- Round edges for maximum safety
- Fixed Steel Net with non corrosive treatment

CNPROPONG 9'L x 5'W x 30"H Gray 620 Lbs

Perfect For:

- Parks
- Resorts
- Camps
- College Campuses
- Military Bases
- Playground
- Campground
- Backyards
- Apartment Complexes



2022

Bag Toss, Ladder Toss & Foosball

Kay Park Bag Toss

All concrete construction with a smooth playing surface. Set up multiples for a great addition to park or outdoor recreation area for family outings or tournaments! **Available in gray finish only.** Add throwers blocks or bike and skate deterrents to finish the bag toss setting.

KPBT	Bag Toss (Set 2)	1330 Lbs
KPBTB	Throwers Blocks (Set 2)	1040 Lbs
KPBTBD	Bike Deterrent	212 Lbs
KPBTSD	Skate Deterrent	8 Lbs
KPBTB	Bags (Set 8)	7 Lbs

Bag Toss Options:

Throwers Blocks



Bike Deterrent



Skate Deterrent



Custom Bag Toss Colors and Printing
Please inquire for cost.

Bag Options:

Set of 8 bags for your bag toss game. This comes with 4 of each color; choose 2 colors when ordering.

Available in:



Outdoor Concrete Bag Toss

Bags Sold Separately

**Bag Toss
2 Year
Warranty**



Kay Park Concrete Ladder Toss

- Outdoor concrete Ladder Toss
- Heavy duty reinforced concrete
- Weather proof
- Virtually maintenance free
- Graphite Color finish
- Powder coated solid steel rungs
- Powder coating colors Black or Red, and Blue
- Base Sold Separately
- Bolas Sold Separately

KPCLTC	Color Rungs Concrete Toss	42"H x 32"W	280 Lbs
KPCLTB	Black Rungs Concrete Toss	42"H x 32"W	280 Lbs
KPSLT	Steel Ladder Toss	42"H x 32"W	160 Lbs
KPCSB	Ladder Support Base	42"H x 42"W x 3H"	425 Lbs
KPCTB	Throwers Base	42"H x 42"W x 3H"	425 Lbs
KPLTB	Bolas		2 Lbs



Ladder Support Base



Throwers Base

Kay Park Steel Ladder Toss

- I beam steel supports
- Powder coated twice extra protection
- Powder coated solid steel rungs
- Black Color finish
- Powder coated solid steel rungs



Kay Park Concrete Foosball

- Regulation Size Table 54 1/2" x 36" x 36"H
- Standard Finish is Natural Gray with Light Sandblast Frame
- Heavy Duty Reinforced Concrete
- Table Side Thickness 3"
- UHPC Ultra High Performance Concrete field, green and charcoal
- 316 Stainless Steel Rods
- Stenciled Playing Lines
- Center Ball Drop Holes
- Easy Access Ball Drop
- Optional Stainless Steel Scorekeepers
- Stainless Steel Table Levelers
- Optional Anchor Inserts, Stainless Steel Sold Separate
- Tamper Resistant Stainless Steel Assembly Screws
- Heavy Duty 4" High Steel I-Beam Supports
- Standard Foosball Players, Red and Blue

KPFBT	54 1/2" x 36" x 36"H	Gray	Lbs
--------------	----------------------	------	-----



2022

New CONCRETE AMENITIES!



Concrete Mailboxes

Offer strong and durable mailboxes for your community, multi housing or neighborhood.

- Standard in ground mount
- 5 standard mailboxes
- Includes nameplates
- Choose color and aggregate texture

CMLBX5 MailBox 60" W x 79"H x 20"D 800 Lbs



Concrete Handicap Bollard

A great way to mark handicap parking without having to paint and also offer some protection for your area as well. (you can modify this)

- Choose color and aggregate texture
- Choose mounting option

CBH Handicap Bollard 16" W x 48"H x 12"D 150 Lbs



Concrete Wrap Bench

Add stylized and sturdy seating to your area with this unique concrete wrap bench.

- Choose color and texture.
- One piece solid concrete

CPBWRAP Concrete Bench 76" L x 22"H x 44"W 2,500 Lbs

Concrete Colors and finish:

Concrete Options:

Concrete colors and aggregate textures:

	Smooth	Light Sand Blast	Perma Stone	DuraBrite
Dove Gray				
Terra Cotta				
Light Brown				
Sand Tan				

Select Color:

Dove Gray, Terra Cotta, Light Brown, or Sand Tan

Select Texture:

Smooth, Light Sand Blast, PermaStone, or Durabrite

Square Concrete Planter

- Includes 4 – 1" drain holes
- Tapered look
- 2 3/4" thick concrete walls

CPAS2828 Square Planter 28" L x 24"H x 28"W 600 Lbs



Shown Custom Black Stain

Concrete Ball Bollards

Concrete ball bollards are available in different sport balls for schools and sport facilities.

CBBB36	Baseball	36" W x 36" H	2,000 Lbs
CBSB36	Softball	36" W x 36" H	2,000 Lbs
CBFB21	Football	21" W x 42" H	700 Lbs
CBKT18	Basketball	36" W x 36" H	2,000 Lbs
CBSCR36	Soccerball	36" W x 36" H	2,000 Lbs
CBGB36	Golfball	36" W x 36" H	1,700 Lbs



Football Bollard



Golf Bollard



Soccerball Bollard



Basketball Bollard



Baseball Bollard



Softball Bollard

Concrete Sphere Bollard

Sphere bollard comes in two sizes with a square base, very aesthetic.

CBSPH39	39"W x 39" L x 42"H	3,950 Lbs
CBSPH52	52"W x 52" L x 51"H	6,560 Lbs

Concrete Colors and finish:

Concrete Options:

Concrete colors and aggregate textures.



Select Color:

Dove Gray, Terra Cotta, Light Brown, or Sand Tan

Select Texture:

Smooth, Light Sand Blast, Permstone, or Durabrite



Mounting Options:

Option A:

Bollard is precast with hollow core. Dimensions of this core are predetermined by the contractor, and need to be specified when placing the order. Existing pad, slab or sidewalk is cast with exposed vertical tubing or pipe to fit inside the core of the bollard. Before bollard is set on exposed tube. On the existing pad, epoxy, caulk, or other bonding agent is applied to core and/or vertical pipe for securing purposes. The bollard is then set in place.

Option B:

Bollard is precast with pipe or tube protruding from bottom of bollard. Dimensions of protruding pipe or tube are pre-determined by the contractor, and need to be specified when placing order. Existing pad, slab, or sidewalk is cast with sleeve correlating to protruding pipe on the bottom of the bollard. Before bollard is set, epoxy, caulk, or other bonding agent is applied to either the tube or the pipe, and/or applied to the sleeves in the existing pad. The bollard is then set in place.

Option C:

Bollard is precast with apre-determined number and pattern of inserts into the bottom of the bollard. Size and pattern of inserts are determined by the contractor and need to be specified when placing the order. The existing pad, slab or sidewalk is cast with sleeves correlating to the inserts in the bottom of the bollard. Threaded rod (included with purchase of bollard) are then screwed into the inserts in the bottom of the bollard. Epoxy, caulk, or bonding agent is applied to the rod and/or into the sleeves in the existing pad. and the bollard is set into place..

Concrete Receptacles



CTCR30MD

Has a brown plastic dome lid with self-closing door.
Shown as Sand Tan Durabrite.

CTCR30MD	24" dia x 43"	Lbs
CTCR30PL	30 Gal. liner	420
		12



CTCS22PB & CTCS40PB

Holds a liner up to 22 gal.
At 40" h (to top of dome) x 20 1/2" square & has a rigid plastic bonnet top with a self-closing door.
Shown in Sand Tan Durabrite. Larger, 40 gallon size model also available.

CTCS22PB	22 Gal. unit	Lbs
CTC20PL	20 Gal. liner	400
CTCS40PB	40 Gal. unit	11
CTC36PL	36 Gal. liner	740
		13



CTCR30PH

Has a dark brown rigid plastic hood top open on two sides. Shown in Sand Tan Durabrite.

CTCR30PH	26 1/4" dia x 44"	Lbs
CTCR30PL	30 Gal. liner	700
		12



CTCR30AR

Has a concave pitch in top. Shown in Light Brown Permastone.

CTCR30AR	24" dia x 33"	Lbs
CTCR30PL	30 Gal. liner	640
		11

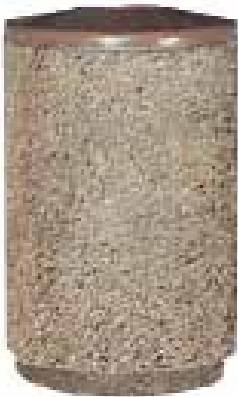

CTCR22FP/30FP

Two pieces fit together with brown fiberglass pitch in top.

CTCR22FP	21" dia x 33"	Lbs
CTCR20PL	20 Gal. liner	300
CTCR30FP	31" dia x 33"	870
CTCR30PL	30 Gal. liner	12



CTCR30AP

Has a convex spun aluminum pitch in top. Shown here in Sand Tan Permastone.

CTCR30AP	24" dia x 33"	Lbs
CTCR30PL	30 Gal. liner	420
		12

Concrete Options:

Concrete colors and aggregate textures.

	Smooth	Light Sand Blast	Perm Stone	Dura Brite
Dove Gray				
Terra Cotta				
Light Brown				
Sand Tan				

Select Texture:

Smooth,
Light Sand Blast,
Permastone
or
Durabrite

Select Color:

Dove Gray,
Terra Cotta,
Light Brown
or
Sand Tan



Popular Square

Features a brown pitch in top and is available in 2 sizes: 22 gal unit is 36" high x 22" square, 30 gal. unit is 30" high x 26" wide x 29" long. Shown in Sand Tan Permastone.

(22 gal top is plastic, 30 gal top is fiberglass.)

CTCS22FP	22 Gal. unit	Lbs
CTC20PL	20 Gal. liner	620
CTCS30FP	30 Gal. unit	11
CTC30PL	30 Gal. liner	870
		12



Round Concrete Table

A modern design with four surrounding seats offers great aesthetics and practicality for patios, food service, etc. It's heavily reinforced concrete construction is very durable. Comes with smooth top and seat surfaces, as well as smooth legs. Available in Sand Tan, Dove Gray, Light Brown, and Terra Cotta. Dedication plaques and logos also available, please inquire. Shown in Dove Gray

- CTR4S** Round 66" L x 30" H x 68" W 1040 Lbs
- CTR3H** ADA 900 Lbs
- UMBRKT** Umbrella bracket option

Square Concrete Table

Perfect for dressing up a patio or courtyard. Made of strong steel reinforced concrete. Top and seats have protective sealer to assure years of service. Two and four seat models available. Ask about umbrella attachment option. Choose a combination of color and texture to best suit your decor. Photo shows Sand Tan tops and seats with Sand Tan PermaStone legs.



- CTS4S** 4 seat sq 67 1/2" L x 29" H x 67 1/2" W 1,040 Lbs
- CTS2S** 2 seat sq 30" L x 29" H x 66" W 640 Lbs
- UMBKT** Umbrella bracket option

CTR Rectangle Table

"The good old standby." These tables have a combination of beautiful exposed aggregate legs and smooth colored tops and seats to enhance surroundings with a look of natural beauty. You choose the texture and color to best match your decor. SMOOTH CONCRETE tops and seats with color all the way through come in 60" and 84" lengths. A handicap model is also available with the top extended at one end. Shown with Light Brown top and seats and Light Brown Durabrite Legs.



- CTRJ60C** Standard 60" L x 29" H x 62" W 1,040 Lbs
- CTRJ84C** Standard 84" L x 29" H x 62" W 1,128 Lbs
- CTRJ84H** Handicap 84" L x 29" H x 62" W 1,028 Lbs

Concrete Oval Top Tables

A contemporary look along with a walk through design perfect for almost any setting. Shown with Sand Tan Light Sandblast legs and smooth top and seats. Choose any color for your tables from the selection. Two sizes available. Handicap unit has one end extended to allow for wheelchair.



- CTOV72** 72" L x 30"H x 60"W oval table 1,400 Lbs
- CTOV84** 84" L x 30"H x 60"W oval table 1,600 Lbs
- CTOV84H** 84" L x 30"H x 60"W oval table 1,600 Lbs

Game Board Option

Permanent insert for concrete table tops. Provide the fun!

GBI

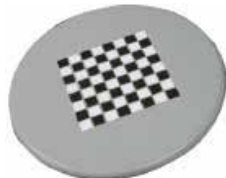

Concrete Benches



CPB Bench

CPB Series concrete park benches are the most popular because they are a style suitable for almost any decor- and reasonably priced! The seats and back are: 2" thick smooth concrete. Benches come in 58", 72" and 84" lengths. Shown with Gray seats and sand tan permastone legs. All available textures and colors shown on page 39. Plaques sold separately see page 44.

CPB58C	33" H x 58" L concrete	420 Lbs
CPB72C	33" H x 72" L concrete	465 Lbs
CPB84C	33" H x 84" L concrete	485 Lbs



'X' Leg Bench

A unique look for a standard park bench. Heavy, reinforced concrete provides years of trouble-free service. Seat and back are 60" long, so it holds three comfortably. Available in smooth only. Shown in Light Brown.

CPB60X	34" H x 60" L x 24" W	500 Lbs
---------------	-----------------------	---------



CCB72CL

Contoured seat and contoured legs are cast in one piece, 72" long. Available with smooth finish seat and legs, or can be a combination of smooth seat and exposed aggregate legs of your choice. Shown in Light Brown.

CCB72CL	Concrete 18" H x 72" L	500 Lbs
----------------	------------------------	---------



CTB58C

Practical bench has three seat lengths, 58" as shown, 72" and 84" long units that can be used along sides of tables or as stand alone benches. Easy bolt-together assembly! A good value! Shown in Sand Tan seat with Durabrite Gray Legs.

CTB58C	18 1/2" H x 58" L	235 Lbs
CTB72C	18 1/2" H x 72" L	210 Lbs
CTB84C	18 1/2" H x 84" L	230 Lbs

Concrete Fountains and Planters

Handicap Accessible Fountain

A beautiful exposed aggregate finish offers a great natural look for any outdoor setting. This model has plenty of knee clearance for persons in wheelchairs and an easy front push button. Choose optional features to best suit your needs, such as concrete or chrome bowl, side facet, freeze proof valve, or tamper-resistance concrete bubbler guard for your drinking fountain. Comes with drain tile piece and bubbler valve for attaching your plumbing connection. Access panel provides ease of installation and heavy concrete construction offers you peace of mind. Pictured at right is **CHFFBS** shown in Durabrite finish, with a chrome bowl and optional side facet.

CHFFBS	Standard, chrome bowl	400 Lbs
CHFFBC	Standard, concrete bowl	410 Lbs
CHFFBCT	Tamper guard, concrete bowl	420 Lbs
CHFFBSF	Freeze proof, chrome bowl	400 Lbs
CHFFBSTF	Tamper & freeze proof, chrome bowl	410 Lbs
CDFOSF	Optional Side facet	10 Lbs



Upright Cylinder

Worry-free near outdoor sports fields, hiking trails, etc. Choose concrete color and texture you prefer. Comes in various model features. Optional concrete child step can be purchased so youngsters can get up to drink from bubbler. Model shown is **CDFPBC** with a PermaStone aggregate finish. Dove gray color, concrete bowl, and push button on the bubbler. Each fountain 220 lbs. Child step 105 pounds.

CDFPBC	Concrete, push button	220 Lbs
CDFIBC	Concrete, 1 side button	220 Lbs
CDFIBCF	Concrete, push button & freeze	220 Lbs
CDFFBS	Chrome, front push button	220 Lbs
CDFOSF	Optional side faucet	220 Lbs
CDFOCS	Optional concrete child step	105 Lbs

Concrete Options:

Concrete colors and aggregate textures.

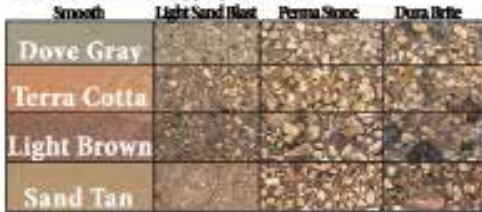

Select Color:

Dove Gray, Terra Cotta, Light Brown or Sand Tan

Select Texture:

Smooth, Light Sand Blast, PermaStone or DuraBrite



Ever Popular Round Planters

An elegant look in a variety of sizes. All models have drain holes. Specify color and texture choice.

CPR2417	24" dia. x 17" H	300 Lbs
CPR2424	24" dia. x 24" H	350 Lbs
CPR2433	24" dia. x 33" H	420 Lbs
CPR3017	30" dia. x 17" H	500 Lbs
CPR3030	30" dia. x 30" H	800 Lbs
CPR3624	36" dia. x 24" H	800 Lbs
CPR3630	36" dia. x 30" H	900 Lbs
CPR4817	48" dia. x 17" H	900 Lbs
CPR4824	48" dia. x 24" H	1,200 Lbs
CPR6036	60" dia. x 36" H	2,100 Lbs



Aspen Rectangle/Square Planters

An elegant look in a variety of sizes. All models have drain holes. Specify color and texture choice.

CPAS2418	24" H x 24" L x 18" W	450 Lbs
CPAS2436	24" H x 36" L x 18" W	530 Lbs
CPAS2448	24" H x 48" L x 30" W	1,200 Lbs
CPAS3648	36" H x 48" L x 36" W	1,700 Lbs
CPAS4848	48" H x 48" L x 36" W	2,500 Lbs
CPAS3660	36" H x 60" L x 36" W	2,700 Lbs
CPAS3672	36" H x 72" L x 36" W	3,100 Lbs
CPAS1660	16" H x 60" L x 18" W	650 Lbs
CPAS2472	24" H x 72" L x 18" W	935 Lbs



Fountains



Black
Dark Bronze
Sand
Blue
Green
Red
Orange
Yellow
Silver
White



Dual-Height

Meets multiple needs.

KP57SDF	Standard	155 Lbs
KP57SDFFP	Freeze proof	185 Lbs

Our commercial steel drinking fountains come in many configurations. Choose from pedestal type or wall mounted drinking fountains, or ADA drinking fountains for public buildings, or shower towers and foot washing stations for public beaches. We also offer pet drinking fountains, which are popular for dog parks and walking trails. Heavy Steel Drinking Fountains shown can withstand rough conditions, and have a powder coat finish. Specify color when ordering.



Wall Mounted Fountain

It has a chrome-plated brass bubbler locked to a stainless steel receptor, a push button valve and a clear coat protective finish over the powder coat.

KP53SWF	Standard	70 Lbs
KP53SWFFP	Freeze proof	90 Lbs



Outdoor Shower + Footwash

Excellent for beach sides.

KP62BFS	Standard	210 Lbs
----------------	----------	---------



Bottle Filler

Bottle Filler with ADA Drinking Fountain

Water bottle filler is great for any location.

KP77BDF	Standard	180 Lbs
----------------	----------	---------

- Brushed aluminum gravity type filler spout
- Vandal resistant interlock chrome plated brass drain
- Replaceable in line water filter
- Push button valve



Pet Fountain

Slow draining pet fountain, great for dog parks.

KP90PF	Standard	85 Lbs
KP90PFFP	Freeze proof	115 Lbs



Triple Height

Perfect for high traffic areas.

KP59THF	Standard	190 Lbs
KP59THFFP	Freeze proof	250 Lbs



Cylindrical

Popular choice for years.

KP25SPF	Standard	120 Lbs
KP25SPFFP	Freeze proof	150 Lbs

Made of Powder Coated Heavy-Duty Steel

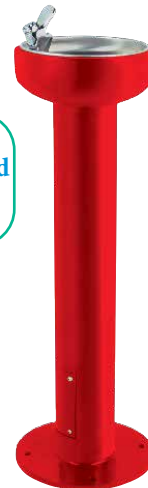

Economical

Offers low cost durability.

KP44SEF	Standard	45 Lbs
----------------	----------	--------

Standard Features:

- Steel Guard over a chrome-plated brass bubbler
- Chrome-plated push-button brass valve
- Adjustable flow regulation
- Stainless Steel Bowl



Cylinder + Pet

Perfect near walking trails.

KP53SWPF	Standard	140 Lbs
KP53SWPFFP	Freeze proof	170 Lbs



ADA Fountain

Domed cylinder type.

KP545H	Standard	145 Lbs
KP545HFP	Freeze proof	175 Lbs



Wheelchair Accessible

A contemporary design.

KP47SHF	Standard	80 Lbs
KP47SHFFP	Freeze proof	100 Lbs

Drinking fountain accessories listed the website:
WWW.KAYPARK.COM

Plaques

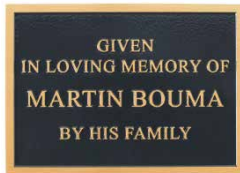

Cast Aluminum

Cast Aluminum

ALMPLQ Cast Aluminum -Forever 4"H x 6" L 2 Lbs

Cast Bronze

Cast Bronze

BRZPLQ Cast Bronze -Forever 4"H x 6" L 2 Lbs

Black Plastic w/Gold Lettering

Black Plastic w/Gold Lettering

PLAQUE40-B Black w/ Gold Lettering 2-3" H x 4-6" L 1 Lbs
Larger sizes available at an additional cost.

Gold Plastic w/Black Lettering

Gold Plastic w/Black Lettering

PLAQUE40-G Gold w/Black Lettering 2-3" H x 4-6" L 1 Lbs

Engraving Only on Recycled Plastic

Engraving Options:

PLASTICENGRAVE8 Engraving 8' Plank 48 Characters
PLASTICENGRAVE6 Engraving 6' Plank 38 Characters
PLASTICENGRAVE4 Engraving 4' Plank 28 Characters



Solid Top Hex Table

Has a 41" diameter top on standard or ADA version.

PRSHT	Std hex table	354 Lbs
PRADAHT	ADA hex table	316 Lbs

**Furniture has black frames:
Choose Slat Color**

Post Consumer
Recycled Plastic Used
On this Page



Rock Island Bench

Has 2" x 6" planks on back and 2"x4" on seat.

PR4RIB	4' Bench	118 Lbs
PR6RIB	6' Bench	178 Lbs
PR8RIB	8' Bench	237 Lbs
PRIARM	Arm Rest	11 Lbs
PRSMKIT	Surface mount kit	

Go Green!!!



Hi-Back Bench

This multi-slat bench has a comfortable contour. Made with 6 - 2"x 4" slats and 2 - 2" x 6" bull nose boards

PR4HBB	4' Bench	140 Lbs
PR5HBB	5' Bench	159 Lbs
PR6HBB	6' Bench	172 Lbs
PRSMKIT	Surface mount kit	

Recycled Plastic:



Brown Black Gray Cedar

**Available with
in-ground mount legs**



Curved Mesa Bench

Comes in 5ft. lengths and can be placed end-to-end to form an "S" or semi-circle. Great around trees or fire pits! 8 of these benches make a circle.

PR5CMB	5' Curved mesa bench	67 Lbs
PRSMKIT		



**8 Benches makes a
10' Diameter inside
12' Diameter outside**

Windsor Select Site Amenities



Windsor Select

Is a line of fine quality site amenities for indoor or outdoor use. The recycled plastic slats are 2" x 3" to create a finer, more elegant look. Slats are attached from the back side using stainless steel fasteners. Recycled plastic is UV protected and will maintain its good appearance for many years with little or no maintenance. Colors are Gray, Cedar, Brown, or Redwood. Please specify when ordering. Recycled plastic is steel reinforced where needed to avoid sagging. All frames are powder coated black.

Windsor Lumbar Comfort Bench

WS4LCBRP	4' Lumbar bench	189 Lbs
WS6LCBRP	6' Lumbar bench	213 Lbs
WS4LCBRPIG	4' In Ground Lumbar	199 Lbs
WS6LCBRPIG	6' In Ground Lumbar	223 Lbs
ARCB	Armrest (set of two)	18 Lbs



Recycled Colors:



Cedar Redwood Gray Brown

Windsor Flat Bench

Both the lumbar comfort and flat benches utilize 2"x3" slats which come in recycled plastic colors of cedar, brown, gray, or redwood. The gentle curve of the lumbar comfort feels so good you will almost hear the sighs of relaxation. Plan for comfort along with a pleasing look. Steel frames are powder coated black. Please specify color of recycled plastic when ordering.

WS4FCBRP	4' Flat bench	108 Lbs
WS6FCBRP	6' Flat bench	174 Lbs
WS4FCBRPIG	4' In Ground Flat bench	118 Lbs
WS6FCBRPIG	6' In Ground Flat bench	184 Lbs



Great For:

- * Malls
- * Pavilions
- * Food Courts
- * Courtyards
- * City Parks
- * Street Projects
- * River Walks
- * Zoos
- * Office
- * And Much More!



Windsor Select Planters

These Windsor Select Planters are 26" diameter and 30", 24", and 18" high. They are also made in round or square shapes. Slats are 2"x3" recycled plastic. Planters are free-standing on a 2" high circular base and have a plate for bolting down to the concrete or can be mounted on an in-ground post. Includes fiberglass liner with drain holes.

Round Windsor Select Planters

WSRP2630RP	Recycled plastic	128 Lbs
WSRP2624RP	Recycled plastic	110 Lbs
WSRP2618RP	Recycled plastic	92 Lbs
3032LRIG	In-ground post	15 Lbs

Square Windsor Select Planters

WSSP2630RP	Recycled plastic	185 Lbs
WSSP2624RP	Recycled plastic	160 Lbs
WSSP2618RP	Recycled plastic	135 Lbs
3032LRIG	In-ground post	15 Lbs

Windsor Select Square Table

Windsor Select square table with a 48" top and 36" long seats. Frames are powder coated black. Legs are 1 5/8" O.D. schedule 40 pipe. Ground space 6'8" x 6'8".

WS4JCRP 4' Square Table 312 Lbs



Windsor Select Picnic Table

Windsor Select picnic table top and seats are 6' long. Frames are powder coated black. Legs are 1 5/8" O.D. schedule 40 pipe. Ground space 5' x 6'

WS6JCRP 6' Table 242 Lbs



Magnificent Modern Design

Windsor Single Post Table

Windsor Select Single Post Table frames are powder coated black, center post is 6" x 6" x 1/4" sq tube, seats support arms are 3 1/2" O.D. pipe. Ground space 6' x 5' (rectangle). 'SM' = Surface Mount. 'IG' = In-Ground.

WS6SPTCRP-SM Single Post 374 Lbs
WS6SPTCRP-IG Single Post 374 Lbs



Recycled Colors:



Cedar Redwood Gray Brown

32 Gallon Litter Receptacle

The Windsor Select 32 Gallon Litter Receptacle slats are 2" x 3" x 30" recycled plastic that are available in gray, cedar, brown, or redwood colors. This receptacle is free-standing on a 2" high circular base, but also has a plate for mounting on a post. Other lids purchased separately.

WS3032LRRP Litter receptacle 128 Lbs
3032LRIG In-ground post 15 Lbs

 Plastic Dome
DLMP32-55
 24" ID, 10 Lbs

Plastic Dome Colors:

Blue	Red
Yellow	Brown
Grey	Black
Green	



 Galvanized Dome
DLG55
 23 3/4" ID, 12 Lbs

 Steel 8" Hole
FLS8-32
 13 Lbs

 Galvanized Lid
CG32LID
 3 Lbs

 Galvanized Can
CG32
 13 Lbs

 Plastic Liner
CP32
 11 Lbs

Park Benches

**Premium
Recycled
Plastic**



6CB4RPIG
4x4's Shown

In Ground Contour Bench

Designed for indoor or outdoor use. The contoured supports are 3/8" x 4" rolled steel that is formed to shape a smooth comfortable seat and backrest. The steel leg consists of 2 1/2" square support tube welded to an arched 3/8" x 4" formed steel base. The entire frame is coated black for long life and good appearance. This frame is specifically designed so it can be fitted with 2" x 4", 3" x 4", or 4" x 4" slats of your choice, pressure treated No. 1 Southern Yellow Pine, or Recycled Plastic slats. In Ground mount.

CB2IG	Frame only, In ground mount	80 Lbs
6CB2SYP	6' Frame w/SYP 2x4s	170 Lbs
8CB2SYP	8' Frame w/SYP 2x4s	196 Lbs
4CB3RPIG	4' Frame w/rec plastic 3x4s	178 Lbs
6CB3RPIG	6' Frame w/rec plastic 3x4s	234 Lbs
8CB3RPIG	8' Frame w/rec plastic 3x4s	348 Lbs
4CB4RPIG	4' Frame w/rec plastic 4x4s	288 Lbs
6CB4RPIG	6' Frame w/rec plastic 4x4s	354 Lbs
8CB4RPIG	8' Frame w/rec plastic 4x4s	440 Lbs
ARCB24	Set of two armrests 2x4, 3x4, 4x4	18 Lbs



6FB3RP
4x4's Shown

Flat Bench

The Flat Bench has a black powder coated frame and three seat material options. Your choice of Southern Yellow Pine 2x4, or Recycled Plastic in 3x4 or 4x4s. The legs are 2 1/2" square steel tube with 3/8" x 4" mounting plates 4', 6' or 8' long.

FB2	Frame only, surface mount	40 Lbs
6FB2SYP	6' Frame w/SYP 2x4s	84 Lbs
8FB2SYP	8' Frame w/SYP 2x4s	98 Lbs
4FB3RP	4' Frame w/rec plastic 3x4s	105 Lbs
6FB3RP	6' Frame w/rec plastic 3x4s	135 Lbs
8FB3RP	8' Frame w/rec plastic 3x4s 3 Legs	177 Lbs
4FB4RP	4' Frame w/rec plastic 4x4s	113 Lbs
6FB4RP	6' Frame w/rec plastic 4x4s	155 Lbs
8FB4RP	8' Frame w/rec plastic 4x4s 3 Legs	218 Lbs
FB2IG	In-Ground Frame only	50 Lbs
6FB2SYP	In-Ground 6' Frame w/SYP 2x4s	94 Lbs
8FB2SYP	In-Ground 8' Frame w/SYP 2x4s	108 Lbs
4FB3RPIG	In-Ground 4' Frame w/rec plastic 3x4s	115 Lbs
6FB3RPIG	In-Ground 6' Frame w/rec plastic 3x4s	145 Lbs
8FB3RPIG	In-Ground 8' Frame w/rec plastic 3x4s	187 Lbs
4FB4RPIG	In-Ground 4' Frame w/rec plastic 4x4s	123 Lbs
6FB4RPIG	In-Ground 6' Frame w/rec plastic 4x4s	165 Lbs
8FB4RPIG	In-Ground 8' Frame w/rec plastic 4x4s	228 Lbs

Recycled Plastic:



Cedar Gray Brown



6CB3RP
3x4's Shown

Surface Mount Contour Bench

Designed for indoor or outdoor use. The contoured supports are 3/8" x 4" rolled steel that is formed to shape a smooth comfortable seat and backrest. The steel leg consists of 2 1/2" square support tube welded to an arched 3/8" x 4" formed steel base. The entire frame is coated black for long life and good appearance. This frame is specifically designed so it can be fitted with 2" x 4", 3" x 4", or 4" x 4" slats of your choice, pressure treated No. 1 Southern Yellow Pine, or Recycled Plastic. Comes standard with Surface Mount Legs.

CB2	Frame only, surface mount	70 Lbs
6CB2SYP	6' Frame w/SYP 2x4s	160 Lbs
8CB2SYP	8' Frame w/SYP 2x4s	186 Lbs
4CB3RP	4' Frame w/rec plastic 3x4s	168 Lbs
6CB3RP	6' Frame w/rec plastic 3x4s	224 Lbs
8CB3RP	8' Frame w/rec plastic 3x4s 3 Legs	330 Lbs
4CB4RP	4' Frame w/rec plastic 4x4s	278 Lbs
6CB4RP	6' Frame w/rec plastic 4x4s	344 Lbs
8CB4RP	8' Frame w/rec plastic 4x4s 3 Legs	430 Lbs
ARCB24	Set of two armrests 2x4, 3x4, 4x4	18 Lbs



Landmark Series Amenities

Good for the environment! Not only do they save trees, but they also reduce landfill use! Our recycled plastic is colored with a unique UV process that adds an attractive wood grain appearance. It never needs to be sealed, painted, stained and will not rot. It is maintenance-free! It is also vandal-resistant. Pens and markers can be washed off and paint will not bond to the surface - it can be removed with sandpaper or a paint scraper. Scratches to the surface can easily be ironed or sanded away. These products are designed to give years and years of trouble free service, while keeping their nice appearance. Choose color when ordering.

Landmark Bench with Back

Our Landmark series benches are a popular choice for any environment.

JPAB4	4' Bench w/ 2 Legs	120 Lbs
JPAB5	5' Bench w/ 2 Legs	135 Lbs
JPAB6	6' Bench w/ 2 Legs	155 Lbs

Recycled Plastic Colors:



Cedar Gray Green



Landmark Backless Bench

Our Landmark series backless benches are a popular choice for any environment.

Made with 2 x 4 recycled plastic slats
 Heavy-duty cast aluminum frame is powder-coated
 Stainless Steel Hardware
 Colored with UV process that adds wood grain appearance
 Maintenance-free - no need to seal, paint or stain and will not rot
 Bench frame is portable but includes holes in the legs for surface mounting
 Plastic made with minimum of 30% recycled plastic that is 100% post-consumer HDPE

JPAPL4	4' Backless Bench	70 Lbs
JPABL5	5' Backless Bench	80 Lbs
JPABL6	6' Backless Bench	90 Lbs



Square Receptacle

JPSPLR32	32 Gal. Receptable	75 Lbs
JP32LINER	32 Gal Liner	6 Lbs



Round Receptacle

JPRLR32	32 Gal. Receptable	60 Lbs
JP32LINER	32 Gal. Liner	6 Lbs
JPRLR55	55 Gal. Receptable	75 Lbs
JP55LINER	55 Gal. Liner	11 Lbs



32 Gallon Hinged Receptacle

JPSLR32	32 Gal. Receptable	140 Lbs
JP32LINER	32 Gal Liner	6 Lbs

Recycled Plastic Benches



2" x 6" Slats

2 Slat Bench

JPCB4	4' Bench - 2 legs	105 Lbs
JPCB6	6' Bench - 3 legs	160 Lbs
JPCB8	8' Bench - 4 legs	210 Lbs

JPSMBOLT Surface Mount

*100% Maintenance Free
Recycled Plastic!*



2" x 4" Slats

3 Slat Backless Bench

JPSB42	4' Bench - 2 legs	75 Lbs
JPSB63	6' Bench - 3 legs	85 Lbs
JPSB83	8' Bench - 4 legs	125 Lbs

JPSMBOLT Surface Mount



100%
Recycled Plastic

Benches have black frame - choose slat color.



1" x 4" Slats

Furniture Colors:



Seaside Adirondack Style Furniture

Seaside Adirondack style furniture made of thick recycled plastic for long life and great appearance.

JPSAC	Chair
JPOT	Ottoman
JPST	Side Table

3 Slat Bench

JPCB42	4' Bench - 2 legs	130 Lbs
JPCB63	6' Bench - 3 legs	185 Lbs
JPCB83	8' Bench - 4 legs	205 Lbs

JPSMBOLT Surface Mount

Recycled Plastic Colors:



Cedar Brown Gray Green

Recycled Plastic Table

JPPT63 6' Table - 3 legs 425 Lbs
JPPT83ADA 8' Table - 3 legs 475 Lbs
JPPT83 8' Table - 3 legs 480 Lbs

JPSMBOLT Surface Mount

100%
Recycled Plastic



2" x 10" Planks

Hexagon Table

JPHT Hexagon table 250 Lbs
JPHTADA Hex - table ADA 210 Lbs

JPSMKIT L - Bracket

Recycled Plastic Colors:



Cedar Gray Green



Green or Black Frame
Cedar, Gray or Green Plank

6 Foot Table

JPAF6 6' Table 240 Lbs
JPAF6ADA 6' Table - ADA 280 Lbs

JPSMKIT L - Bracket

Recycled Plastic Colors:



Cedar Brown Gray Green



2" x 10" Planks

Tables have black frame - choose plank color.

100% Recycled Plastic Child Table

Made from 100% post consumer recycled plastic. Maintenance free. Black frame. Specify plank color.

JPAFCS4 4' Child size table 100 Lbs

JPSMKIT L - Bracket



Cedar Green Only



Child's Table

Thermoplastic Expanded Metal Benches



Wide Flat Bench with Back

The **14.5" wide flat** seat of this classic bench has rounded corners. Coated in a thermoplastic finish. Choose between surface mount, in ground mount or portable. Available in several colors with black legs.

MCWB6EXPP	6' Portable	139 Lbs
MCWB8EXPP	8' Portable	167 Lbs
MCWB6EXPSM	6' Surface mount	125 Lbs
MCWB8EXPSM	8' Surface mount	153 Lbs
MCWB6EXPIG	6' In-ground	131 Lbs
MCWB8EXPIG	8' In-ground	159 Lbs



Wide Flat Backless Bench

The **14.5" wide flat** seat of this classic bench has rounded corners. Coated in a thermoplastic finish. Choose between surface mount, in ground mount or portable. Available in several colors with black legs.

MCWBB6EXPP	6' Portable	71 Lbs
MCWBB8EXPP	8' Portable	84 Lbs
MCWBB6EXPSM	6' Surface mount	64 Lbs
MCWBB8EXPSM	8' Surface mount	76 Lbs
MCWBB6EXPIG	6' In-ground	66 Lbs
MCWBB8EXPIG	8' In-ground	79 Lbs



Expanded Bench with Back

A great option for parks, playgrounds and for use as a players bench. Available in different lengths and colors to suit anyone needs.

- 3/4" #9 Expanded Metal
- 3/4" x 2" Angle Iron Outer Frame
- 1 1/2" x 1/4" Flat Steel Inside Bracing
- 2 3/8" Round Tubing Frame Material
- 2" x 2" Angle Iron Frame Bracing
- 1" Round Tubing Diagonal Braces for Portable Braces
- Choose between Portable, Surface Mount or In Ground Mount
- Black Powder Coated Frame
- Several Color Options to Choose From

MCPB6EXPP	6' Portable	118 Lbs
MCPB8EXPP	8' Portable	142 Lbs
MCPB6EXPPSM	6' Surface mount	120 Lbs
MCPB8EXPPSM	8' Surface mount	130 Lbs
MCPB6EXIG	6' In-ground	114 Lbs
MCPB8EXIG	8' In-ground	135 Lbs

Thermoplastic Colors:



WARNING: Cancer and Reproductive Harm www.P65Warnings.com

Special Colors Available at Additional Charge

Dog Park Bench

Portable thermoplastic perforated steel bench.

- 1/2" Punched Steel
- 3/4" x 2" Angle Iron Outer Frame
- 1 1/2" x 1/4" Flat Steel Inside Bracing
- 2 3/8" Round Tubing Frame Material
- 2" x 2" Angle Iron Frame Bracing
- 1" Round Tubing Diagonal Braces for Portable Braces
- Choose between Portable, Surface Mount or In Ground Mount
- Black Powder Coated Frame
- Several Color Options to Choose From

MCPB6DOGP	6' Portable	210 Lbs
MCPB8DOGP	8' Portable	249 Lbs
MCPB6DOGSM	6' Surface mount	210 Lbs
MCPB8DOGSM	8' Surface mount	249 Lbs
MCPB6DOGIG	6' In-ground	210 Lbs
MCPB8DOGIG	8' In-ground	249 Lbs



Buddy Bench

- 1/2" Punched Steel
- 3/4" x 2" Angle Iron Outer Frame
- 1 1/2" x 1/4" Flat Steel Inside Bracing
- 2 3/8" Round Tubing Frame Material
- 2" x 2" Angle Iron Frame Bracing
- 1" Round Tubing Diagonal Braces for Portable Braces
- Choose between Portable, Surface Mount or In Ground Mount
- Black Powder Coated Frame
- Several Color Options to Choose From

MCPB6BUDP	6' Portable	210 Lbs
MCPB8BUDP	8' Portable	249 Lbs
MCPB6BUDSM	6' Surface mount	210 Lbs
MCPB8BUDSM	8' Surface mount	249 Lbs
MCPB6BUDIG	6' In-ground	210 Lbs
MCPB8BUDIG	8' In-ground	249 Lbs



Square Dog Park Table

Portable thermoplastic perforated steel square table.

- 1/2" Punched Steel
- 4 Seat is Standard
- 3/4" x 2" Angle Iron Outer Frame
- 1 1/2" x 1/4" Flat Steel Inside Bracing
- 2" Round Tubing Frame Material
- 2" x 2" Angle Iron Frame Bracing
- 1" Round Tubing Cross Braces

MC46PSTDPD	46" Dog Park Table	250 Lbs
-------------------	--------------------	---------

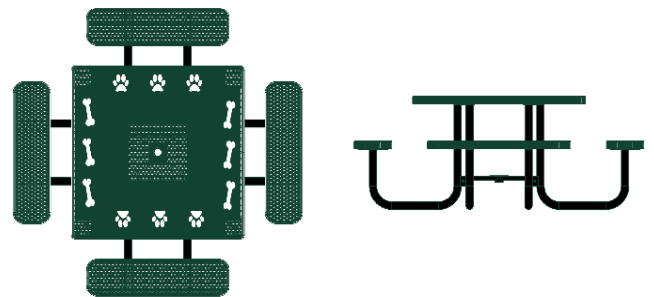

Thermoplastic Colors:



WARNING: Cancer and Reproductive Harm www.P65Warnings.com

Special Colors Available at
Additional Charge

NEW! Thermoplastic Coated Benches



Visit our website for perforated and expanded metal options

Now Available for Quick Ship

Rolled Bench

One bench with several options. 11 gauge Slatted Steel. The seat and back are finished with a rolled edge for a more modern look. The bench frame is made from 2 3/8" outer diameter steel. Coated in a thermoplastic finish. Choose between surface mount, in ground mount or portable. Available in several colors with black legs.

- Rolled Edge Seats
- 3/4" x 2" Angle Iron Outer Frame
- 1" Round Tubing Diagonal Braces for Portable Benches
- 1 1/2" x 1/4" Flat Steel Inside Bracing
- 2 3/8" Round Tubing Frame Material
- 2" x 2" Angle Iron Frame Bracing

MCRB4SSP	4' Portable Bench	136 Lbs
MCRB6SSP	6' Portable Bench	167 Lbs
MCRB4SSSM	4' Surface Mount Bench	118 Lbs
MCRB6SSSM	6' Surface Mount Bench	151 Lbs
MCRB4SSIG	4' In-ground Bench	125 Lbs
MCRB6SSIG	6' In-ground Bench	157 Lbs

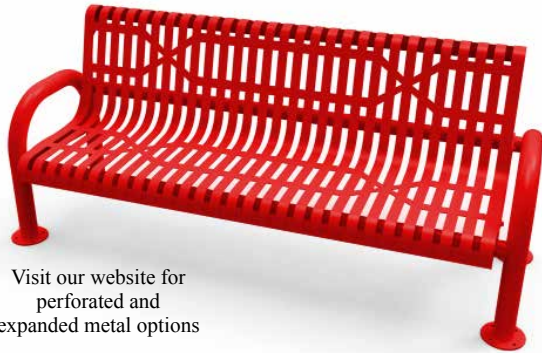

Visit our website for perforated and expanded metal options

Modern Bench with Back

One bench with several options. 11 gauge Slatted Steel. The bench frame is made from 2 7/8" outer diameter steel. Coated in a thermoplastic finish. Legs and seat are the same color. Choose between surface mount or in ground mount.

MCMD4SSIG	In-ground 4' Bench	165 Lbs
MCMD6SSIG	In-ground 6' Bench	204 Lbs
MCMD4SSSM	Surface Mount 4' Bench	145 Lbs
MCMD6SSSM	Surface Mout 6' Bench	184 Lbs

Slatted Bench without Back

11 gauge Slatted Steel. The bench frame is made from 2 7/8" outer diameter steel. Coated in a thermoplastic finish. Legs and seat are the same color.

MCMDBB4PSSM	4' Surface Mount	119 Lbs
MCMDBB6PSSM	6' Surface mount	152 Lbs
MCMDBB4PSIG	4' In-ground	135 Lbs
MCMDBB6PSIG	6' In-ground	167 Lbs

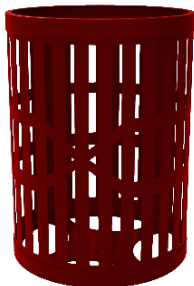

Slatted Litter Receptacle

This 11 ga metal receptacle has thermoplastic coating in variety of colors. Lids and liners sold separately. Lids and liners on page 57

MCSS32LR	32 Gal. Strap Steel	71 Lbs
-----------------	---------------------	--------

Thermoplastic Colors:



Special Colors Available at Additional Charge



WARNING: Cancer and Reproductive Harm www.P65Warnings.com

Expanded Thermoplastic Picnic Table

Picnic table frame is 2 3/8" O.D. in a convenient, walk-through design, and comes with a standard black powder coat finish. The top and seats are fabricated of 9 ga. flattened expanded metal in various lengths. Tops and seats have thermoplastic coating – see color selection below.

MC4EXP	4' Portable table	160 Lbs
MC6EXP	6' Portable table	210 Lbs
MC8EXP	8' Portable table	280 Lbs

Maximize your Budget



46" Round Expanded Thermoplastic Table

Round table frame has black powder coated 2" O.D. steel tubular legs. Top is 46" dia. curved seats surround top. Top and seats are 9 ga. flattened expanded metal with your color choice of thermoplastic coating. Choose from colors below.

MC46RO	46" Round Table	255 Lbs
MC46RO3S	46" Round Table 3 Seats	220 Lbs



46" Octagon Spider Leg Expanded Thermoplastic Table

Octagon table frame has black powder coated 2" O.D. steel tubular spider legs. Top is 46" dia. curved seats surround top. Top and seats are 9 ga. flattened expanded metal with your color choice of thermoplastic coating. Choose from colors below.

MC46OSL	46" Table	302 Lbs
MC46OSL3S	46" Round Table 3 Seats	275 Lbs



46" Square Expanded Thermoplastic Table

Square table has 46" top and 36" seats of 9 ga. flattened expanded metal that is thermoplastic coated in a variety of colors. Legs are 2" O.D. tubular steel with a standard black powder coated finish. Select top and seat color when ordering.

MC46SQ	46" Sq. Square Table	265 Lbs
MC46SQ3S	46" Sq. Table 3 Seats	230 Lbs



Expanded Thermoplastic Colors:



Special Colors Available at Additional Charge

Thermoplastic Steel Benches



Standard Perforated Bench

A great option for parks, playgrounds and for use as a players bench. Available in different lengths and colors to suit anyone needs.

- 1/2" Punched Steel
- 3/4" x 2" Angle Iron Outer Frame
- 1 1/2" x 1/4" Flat Steel Inside Bracing
- 2 3/8" Round Tubing Frame Material
- 2" x 2" Angle Iron Frame Bracing
- 1" Round Tubing Diagonal Braces for Portable Benches
- Choose between Portable, Surface Mount or In Ground Mount
- Black Powder Coated Frame
- Several Color Options to Choose From

MCPB6TPP	6' Portable Bench	120 Lbs
MCPB8TPP	8' Portable Bench	149 Lbs
MCPB10TPP	10' Portable Bench	190 Lbs
MCPB15TPP	15' Portable Bench	225 Lbs
MCPB6TPSM	6' Surface Bench	112 Lbs
MCPB8TPSM	8' Surface Bench	137 Lbs
MCPB10TPSM	10' Surface Bench	187 Lbs
MCPB15TPSM	15' Surface Bench	215 Lbs
MCPB6TPIG	6' In-ground Bench	117 Lbs
MCPB8TPIG	8' In-ground Bench	142 Lbs
MCPB10TPIG	10' In-ground Bench	183 Lbs
MCPB15TPIG	15' In-ground Bench	218 Lbs

Backless Bench Available

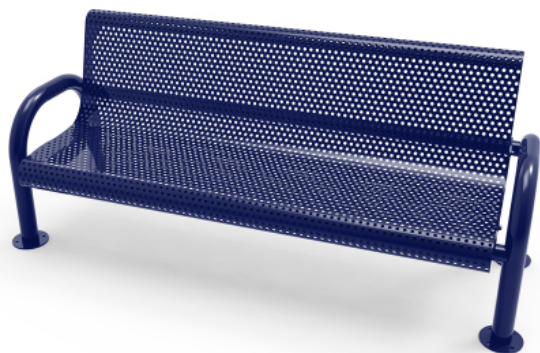

Perforated Modern Bench

One bench with several options. 1/2" hole Punched Steel. The bench frame is made from 2 7/8" outer diameter steel. Coated in a thermoplastic finish. Legs and seat are the same color. Choose between surface mount or in ground mount

MCMD4PSIG	In-ground 48" Bench	165 Lbs
MCMD6PSIG	In-ground 72" Bench	204 Lbs
MCMD4PSSM	Surface Mount 48" Bench	145 Lbs
MCMD6PSSM	Surface Mount 72" Bench	184 Lbs

Perforated Backless Modern Bench

One bench with several options. 1/2" hole Punched Steel. The bench frame is made from 2 7/8" outer diameter steel. Coated in a thermoplastic finish. Legs and seat are the same color. Choose between surface mount or in ground mount

MCMDBB4PSIG	In-ground 48" Bench	135 Lbs
MCMDBB6PSIG	In-ground 72" Bench	167 Lbs
MCMDBB4PSSM	Surface Mount 48" Bench	119 Lbs
MCMDBB6PSSM	Surface Mount 72" Bench	152 Lbs

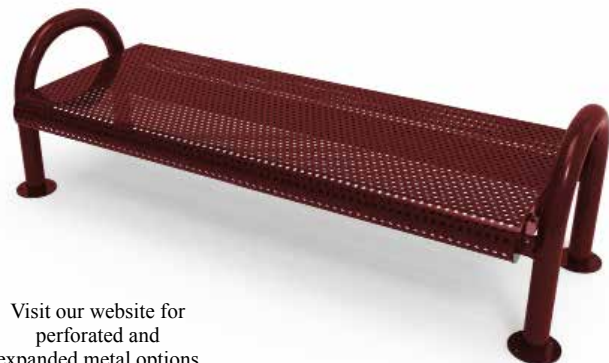

Visit our website for perforated and expanded metal options

Thermoplastic Colors:



Special Colors Available at Additional Charge

Perforated Steel Site Furnishings

Perforated Picnic Table

Weather resistant thermoplastic coating on 11 ga tops and seats. With a 2 3/8" O.D. steel tube frame comes with a black powder coat finish. The combination makes this an attractive and durable table for any outdoor setting.

MC6PSTP	6' Portable table	225 Lbs
MC8PSTP	8' Portable table	271 Lbs
MC8PSTPADA	8' Portable table ADA	238 Lbs
MC10PSTP	10' Portable table	388 Lbs



46" Round Perforated Table

Thermoplastic tops and seats that are made of 11 ga perforated steel that comfortably seat eight around a 46" top. The 1 5/8" O.D. tube legs are powder coated black. The 3 seat model is used for ADA wheelchair accessibility.

MC46PSRTP	46" Portable table	257 Lbs
MC46PSRTPADA2	46" Portable table, 2 seat	210 Lbs
MC46PSRTPADA3	46" Portable table, 3 seat	233 Lbs



Square Table

Portable thermoplastic perforated steel square table.

MC46PSTP	46" Sq. Square Table	259 Lbs
MC46PSTPADA2	46" Sq. Square, 2 seat	245 Lbs
MC46PSTPADA3	46" Sq. Square, 3 seat	251 Lbs



32 Gal. Perf. Receptacle

This 11 ga metal has thermoplastic coating in variety of colors. Lids and liners sold separately.

32 Gal. Perf.

32 Gal. Dog Trash

32 Gal Perf round	81 Lbs	MCPS32LR
Surface Mount	6 Lbs	MCPSLRSM
In Ground Mount	6 Lbs	MCPSLRIG

MCPSDP32
MCPSDPSM
MCPSDPIG



Black Plastic liner for use with 32 Gal. Perf. and 32 Gal. Custom Litter receptacles.
MCLR32L
9 Lbs

Thermoplastic Colors:

Special Colors Available at Additional Charge



Strap Steel Amenities



A.



B.



C.



D.

*Beautify your street scape with
Maintenance-FREE
Elegant Strap Steel*



E.

A. 32 Gal recept w/Snuffer top	SSHRLRCS	340 Lbs
B. Cigarette Snuffer	SSCS	80 Lbs
C. 32 Gal "V" Style Litter Receptacle	SSVSLR32	250 Lbs
C. "V" Style Cigarette Snuffer w/Bowl	SSVCS	80 Lbs
D. 48" Backless Bench	SSABB48	150 Lbs
D. 72" Backless Bench	SSABB72	180 Lbs
E. 36"W x 24"H Planter	SSAP362432	300 Lbs
F. 48" Contour Bench	SSCB48	240 Lbs
F. 72" Contour Bench	SSCB72	300 Lbs



F.

Don't Forget the Round Litter Receptacles Page 33



A. 48" Bench

B.

C.

Powder Coat Colors:

White	Tan	Bronze	Brown	Black	Royal Blue	Evergreen	Hunter Green
-------	-----	--------	-------	-------	------------	-----------	--------------



Recycling Bins come complete w/liners, specify compartment wording

G.



48" Backless Bench

D.

Ashtray top



E.

Rain Cover



F.

- A. 48" Bench with back 170 Lbs **IVB48PC**
- A. 60" Bench with back 190 Lbs **IVB60PC**
- A. 72" Bench with back 210 Lbs **IVB72PC**
- A. 96" Bench with back 260 Lbs **IVB96PC**
- B. 45 Gal recept Flat Lid 340 Lbs **IVILRPC**
- C. 30" dia. x 25"h w/liner 290 Lbs **IVPLANTER**

- D. 48" Backless Bench 115 Lbs **IVBB48PC**
- D. 60" Backless Bench 140 Lbs **IVBB60PC**
- D. 72" Backless Bench 165 Lbs **IVBB72PC**
- D. 96" Backless Bench 215 Lbs **IVBB96PC**
- E. Ashtray top/rain cover 10 Lbs **IVAT**
- F. Rain Cover 12 Lbs **IVATC**
- G. 3 Bin Oval Recycling 390 Lbs **IVRC3R**

Portable Benches - With Back



Portable benches are 2 3/8" O.D. hot-dip galvanized with 1 1/16" cross brace and portable leg style to allow for mobility. These benches are perfect for indoor or outdoor use and drilled to accept 2" x 4" slats or 2" x 10" planks. Great for parks, locker rooms, ball diamonds, or soccer fields etc.

Frame and hardware Only

62PG2	FRAME ONLY for 6'	48 Lbs
82PG2	FRAME ONLY for 8'	50 Lbs
153PG3	FRAME ONLY for 15'	76 Lbs

Change "G" to "C" for powder coat frame.



Treated SYP Wood 2x4" Slat Bench

62PGPS	6' Treated SYP 2x4"	107 Lbs
82PGPS	8' Treated SYP 2x4"	127 Lbs

62PG-PS
SYP Wood



Treated SYP Wood 2x10" Plank Bench

62PGP	6' Treated SYP, 2x10"	96 Lbs
82PGP	8' Treated SYP, 2x10"	111 Lbs
152PGP	15' Treated SYP, 2x10"	187 Lbs

62PGP
SYP Wood Plank



Recycled Plastic 2x4" Slat Bench

62PGRPS	6' Recycled plastic, 2x4" 2 Legs	110 Lbs
82PGRPS	8' Recycled plastic, 2x4" 3 Legs	153 Lbs

82PGRPS
Recycled Plastic



Portable Benches - With Back

See Plank Options Page 94

Recycled Plastic 2x10" Plank Bench

62PGRRP	6' Recycled plastic, 2x10"	108 Lbs
82PGRRP	8' Recycled plastic, 2x10" (3 Legs)	167 Lbs



Recycled Plastic:



Cedar Gray Brown

Steel Reinforced



62PG-RRP
Recycled Plastic



Aluminum 2x10" Plank Bench

62PGA	6' Aluminum, 2x10"	69 Lbs
82PGA	8' Aluminum, 2x10"	80 Lbs
152PGA	15' Aluminum, 2x10"	127 Lbs
212PGA	21' Aluminum, 2x10"	165 Lbs

Same Durable Frame Just
Choose Your Plank!



Shown: 62PCA
Aluminum Plank
Powder Coat Price Pg. 60

Fiberglass 2x10" Plank Bench

62PGF	6' Fiberglass, 2x10"	101 Lbs
82PGF	8' Fiberglass, 2x10"	119 Lbs
152PGF	15' Fiberglass, 2x10"	189 Lbs

Fiberglass:



Red Shamrock Green Forest Green Royal Blue Yellow White Champagne

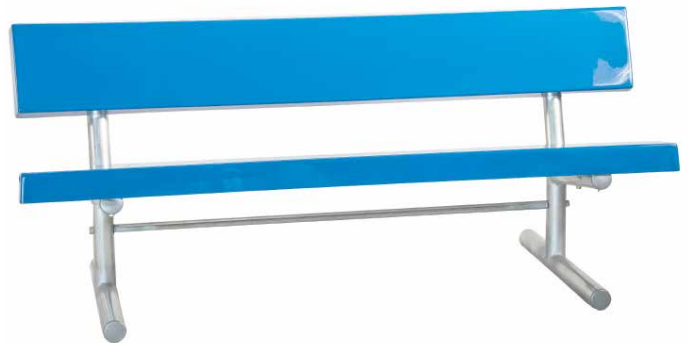

Shown: 62PGF
Fiberglass

Vinyl Plastisol 2x10" Plank Bench

62PGVP	6' Vinyl Plastisol 2x10"	130 Lbs
82PGVP	8' Vinyl Plastisol 2x10"	147 Lbs
152PGVP	15' Vinyl Plastisol 2x10"	260 Lbs

Impact Absorbing, Kid Friendly Coating!

Quality Thick Vinyl Plastisol:

Additional Colors Available
Please Inquire



Black Brown Green Blue Gray



Shown: 62PCVP
Vinyl Plastisol



WARNING: Cancer and Reproductive Harm www.P65Warnings.com

Portable Benches - NO Back



Shown: 62PGLP Treated SYP Wood



Shown: 62PGLRRP Recycled Plastic

Recycled Plastic:



Cedar Gray Brown

Steel Reinforced

Portable benches are 2 3/8" O.D. hot-dip galvanized with 1 1/16" cross brace and portable leg style to allow for mobility. These benches are perfect for indoor or outdoor use. Great for parks, locker rooms, ball diamonds, or soccer fields etc. These benches are only available with 2" x 10" plank seats, 6', 8', or 15'. 15 foot bench has 3 legs.

Treated SYP Wood 2x10" Plank Bench

62PGLP	6' Treated SYP, 2x10"	54 Lbs
82PGLP	8' Treated SYP, 2x10"	65 Lbs
152PGLP	15' Treated SYP, 2x10"	105 Lbs

Recycled Plastic 2x10" Plank Bench

62PGLRRP	6' Recycled plastic, 2x10"	54 Lbs
82PGLRRP	8' Recycled plastic, 2x10"	86 Lbs



Shown: 62PGLA Aluminum Plank



Aluminum 2x10" Plank Bench

62PGLA	6' Aluminum, 2x10"	42 Lbs
82PGLA	8' Aluminum, 2x10"	49 Lbs
152PGLA	15' Aluminum, 2x10"	74 Lbs

Frame Plus Hardware

62PGL2	FRAME ONLY for 6'	32 Lbs
82PGL2	FRAME ONLY for 8'	34 Lbs
152PGL3	FRAME ONLY for 15'	49 Lbs

Change "G" to "C" for powder coat frame.

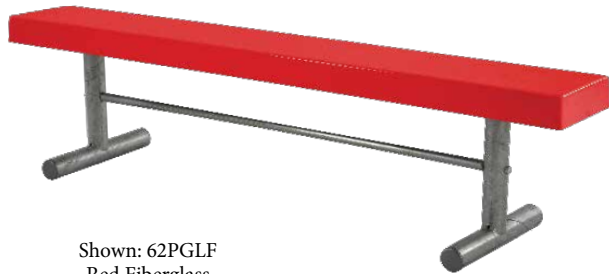

Shown: 62PGLF Red Fiberglass

Fiberglass 2x10" Plank Bench

62PGLF	6' Fiberglass, 2x10"	64 Lbs
82PGLF	8' Fiberglass, 2x10"	95 Lbs
152PGLF	15' Fiberglass, 2x10"	113 Lbs

Fiberglass:

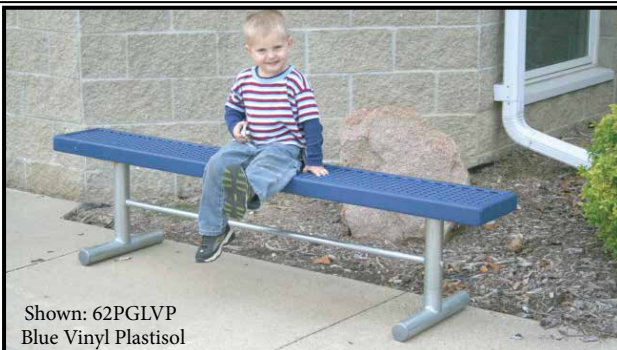
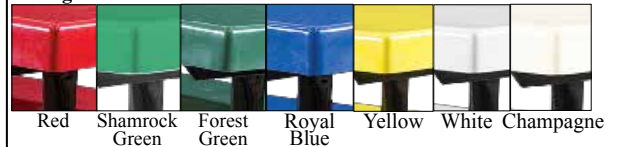

Shown: 62PGLVP Blue Vinyl Plastisol

Vinyl Plastisol 2x10" Plank Bench

62PGLVP	6' Vinyl Plastisol 2x10"	71 Lbs
82PGLVP	8' Vinyl Plastisol 2x10"	81 Lbs
152PGLVP	15' Vinyl Plastisol 2x10"	139 Lbs

Impact Absorbing, Kid Friendly Coating!

Quality Thick Vinyl Plastisol:

Additional Colors Available
Please Inquire



Black Brown Green Blue Gray



WARNING:

Cancer and
Reproductive Harm
www.P65Warnings.com

Fiberglass & Vinyl Plastisol

Stationary Benches - NO Back

Stationary benches are 2 3/8" O.D. hot-dip galvanized with in-ground leg style to allow for permanent installation. These benches are perfect for indoor or outdoor use. Great for parks, locker rooms, ball diamonds, soccer fields, etc. These benches are only available in 2" x 10" planks. **For Surface mount add "SM"** to the model number.

Treated SYP Wood 2x10" Plank Bench

62SGLP	6' Treated SYP, 2x10"	54 Lbs
82SGLP	8' Treated SYP, 2x10"	62 Lbs
152SGLP	15' Treated SYP, 2x10"	103 Lbs



62SGL_P
Treated SYP Wood

Recycled Plastic 2x10" Plank Bench

62SGLRRP	6' Recycled plastic, 2x10" 2 legs	48 Lbs
82SGLRRP	8' Recycled plastic, 2x10" 3 Legs	72 Lbs



62SGLRRP
Recycled Plastic

Aluminum 2x10" Plank Bench

62SGLA	6' Aluminum, 2x10"	41 Lbs
82SGLA	8' Aluminum, 2x10"	44 Lbs
152SGLA	15' Aluminum, 2x10"	69 Lbs



62SGLA
Aluminum Plank

Frame Only

62SGL2	FRAME ONLY for 6'	28 Lbs
82SGL2	FRAME ONLY for 8'	28 Lbs
152SGL3	FRAME ONLY for 15'	42 Lbs

Change "G" to "C" for powder coat frame.

Fiberglass 2x10" Plank Bench

62SGLF	6' Fiberglass, 2x10"	65 Lbs
82SGLF	8' Fiberglass, 2x10"	65 Lbs
152SGLF	15' Fiberglass, 2x10"	98 Lbs

Commercial Quality



62SGLF
Fiberglass

Vinyl Plastisol 2x10" Plank Bench

62SGLVP	6' Vinyl Plastisol 2x10"	69 Lbs
82SGLVP	8' Vinyl Plastisol 2x10"	78 Lbs
152SGLVP	15' Vinyl Plastisol 2x10"	140 Lbs

*Thicker,
Softer Protection
For Long-Lasting Quality.*

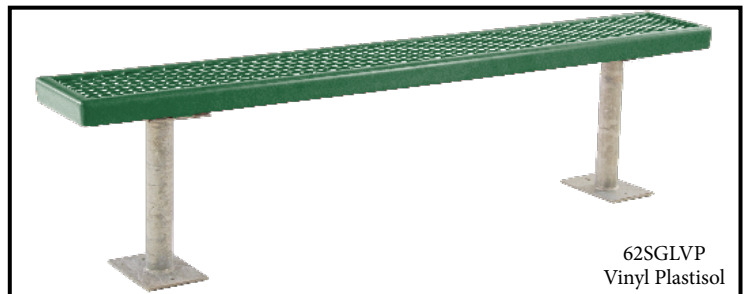

62SGLVP
Vinyl Plastisol

See Plank Options Page 94

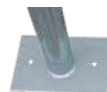

Surface Mount
Add "SM" to end of Model#

Stationary Benches - With Back

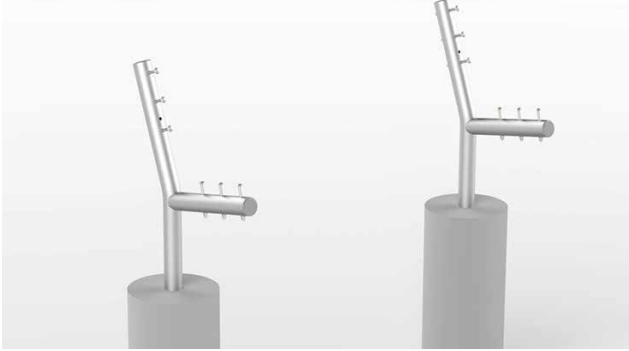

Stationary Benches With Back

Stationary Benches are 2 3/8" O.D. hot-dip galvanized with in-ground leg style to allow for permanent installation. These benches are perfect for indoor or outdoor use. Great for parks, locker rooms, ball diamonds, soccer fields, etc. for **surface mount** and "SM" to the model number.

Frame and hardware Only

62SG2	FRAME ONLY for 6'	35 Lbs
82SG2	FRAME ONLY for 8'	35 Lbs
152SG2	FRAME ONLY for 15'	60 Lbs

Change "G" to "C" for powder coat frame.



Shown: 62SG-PS SYP Wood

Treated SYP Wood 2x4" Slat Bench

62SGPS	6' Treated SYP 2x4"	98 Lbs
82SGPS	8' Treated SYP 2x4"	117 Lbs



Shown: 62SGP SYP Wood Plank

Treated SYP Wood 2x10" Plank Bench

62SGP	6' Treated SYP, 2x10"	87 Lbs
82SGP	8' Treated SYP, 2x10"	103 Lbs
152SGP	15' Treated SYP, 2x10"	180 Lbs



Shown: 82SGRPS Cedar Recycled Plastic

Recycled Plastic 2x4" Slat Bench

62SGRPS	6' Recycled plastic, 2x4" 2 Legs	100 Lbs
82SGRPS	8' Recycled plastic, 2x4" 3 Legs	145 Lbs

Recycled Plastic:



Cedar



Gray



Brown

Steel Reinforced



Surface Mount
Add "SM" to end of Model#

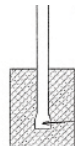

Standard In-Ground Mount

Stationary Benches - With Back

Recycled Plastic 2x10" Plank Bench

62SGRRP 6' Recycled plastic, 2x10" 2 Legs 85 Lbs
82SGRRP 8' Recycled plastic, 2x10" 3 Legs 130 Lbs



Aluminum 2x10" Plank Bench

62SGA 6' Aluminum, 2x10" 61 Lbs
82SGA 8' Aluminum, 2x10" 98 Lbs
152SGA 15' Aluminum, 2x10" 111 Lbs
212SGA 21' Aluminum, 2x10" 136 Lbs



Fiberglass 2x10" Plank Bench

62SGF 6' Fiberglass, 2x10" 93 Lbs
82SGF 8' Fiberglass, 2x10" 109 Lbs
152SGF 15' Fiberglass, 2x10" 169 Lbs

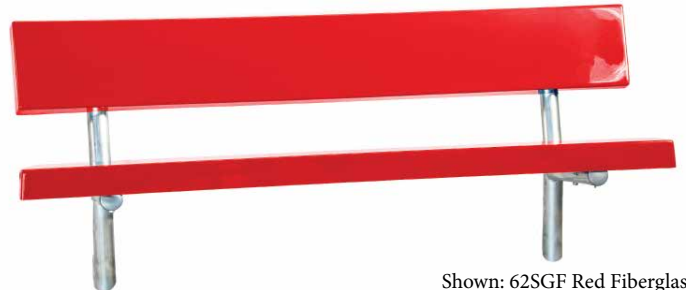
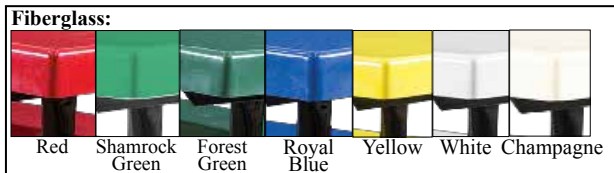

Vinyl Plastisol 2x10" Plank Bench

62SGVP 6' Vinyl Plastisol 2x10" 121 Lbs
82SGVP 8' Vinyl Plastisol 2x10" 136 Lbs
152SGVP 15' Vinyl Plastisol 2x10" 253 Lbs

*Thicker,
 Softer Protection
 For Long-Lasting Quality.*



WARNING:
 Cancer and
 Reproductive Harm
 www.P65Warnings.com
Fiberglass & Vinyl Plastisol

Quality Thick Vinyl Plastisol:
 Additional Colors Available
 Please Inquire



Ornate Cast Aluminum Benches



Add “ageless” elegance to any area with these cast aluminum benches. Cast aluminum frame has electrostatic powder finish. The aluminum frames will never rust and can never leave rusty marks on your floor. Pre-finished White Oak slats, 2 1/2” x 3/4”, with rounded edges add beauty to these well-chosen benches. Also available in maintenance-free recycled plastic Hi-wood slats. Perfect for interior or exterior use. Feet can be drilled for stationary mounting. Add ‘SM’ to the model number. Benches are available in 48”, 60”, or 80” lengths. For extra strength, 60” and 80” benches have a third leg in the center with the armrest removed.

Victorian Bench

VBS48	48” Standard oak bench 2 legs	47 Lbs
VBS48RP	48” Bench w/recycled slats	70 Lbs
VBP60	60” Plantation oak bench	73 Lbs
VBP60RP	60” Bench w/recycled slats	109 Lbs
VBLF80	80” Longfellow oak bench 3 legs	88 Lbs
VBLF80RP	80” Bench w/recycled slats	132 Lbs



Renaissance Bench

RBS48	48” Standard oak bench 2 legs	60 Lbs
RBS48RP	48” Bench w/recycled slats	90 Lbs
RBP60	60” Plantation oak bench	80 Lbs
RBP60RP	60” Bench w/recycled slats	120 Lbs
RBLF80	80” Longfellow oak bench 3 legs	100 Lbs
RBLF80RP	80” Bench w/recycled slats	150 Lbs

*Rust FREE
Aluminum Frames*



Woodland Bench

WBS48	48” Standard oak bench 2 legs	75 Lbs
WBS48RP	48” Bench w/recycled slats	112 Lbs
WBP60	60” Plantation oak bench	90 Lbs
WBP60RP	60” Bench w/recycled slats	135 Lbs
WBLF80	80” Longfellow oak bench 3 legs	100 Lbs
WBLF80RP	80” Bench w/recycled slats	149 Lbs

Frame Colors:
Brown
Green
Black
White

Recycled Colors:



Cedar Redwood



Backless Renaissance

RBBS48	48” Standard oak bench 2 legs	45 Lbs
RBBS48RP	48” Bench w/recycled slats	56 Lbs
RBBP60	60” Plantation oak bench	60 Lbs
RBBP60RP	60” Bench w/recycled slats	75 Lbs
RBBLF80	80” Longfellow oak bench 3 legs	70 Lbs
RBBLF80RP	80” Bench w/recycled slats	88 Lbs

RepairSTAN™ Bicycle Repair Stand

- 52 5/8"H x 18"W x 1 7/8" L
- Allen Wrenches: 2.5, 3, 4, 5, 6, 8mm
- Adjustable Wrench
- Headset Wrench
- Pedal Wrench
- Open Wrenches 8, 9, 10, 11mm
- Tire Lever
- Phillips Screwdriver
- Straight Screwdriver
- Surface mount plate for bolt down

MBRSCM	Powder Coated Repair Stand	80 Lbs
MBRSGM	Galvanized Repair Stand	80 Lbs



Phil Up Air Pump

- 5"H x 12"W x 14" L
- Steel housing with an aluminum handle
- Presta and Schrader valve head
- 160 PSI Air Gauge
- Electro polish stainless finish
- Surface mount plate for bolt down

MBRSSM	Fill Up Station	22 Lbs
---------------	-----------------	--------



Vertical Single Bike Storage

- 28" H x 28" D x 3 1/4" W
- 1/2" and 5/8" Steel Bar
- Mounts one bicycle vertically to the wall of a garage, basement, or other storage area.
- Galvanized "G" or Powder Coated Finish "C"

MBBSVIGWM	Galvanized Wall Rack	7 Lbs
MBBSVICWM	Powder Coated Wall Rack	7 Lbs

*These are ideal for
apartment/residential use*

Powder Coating Colors:

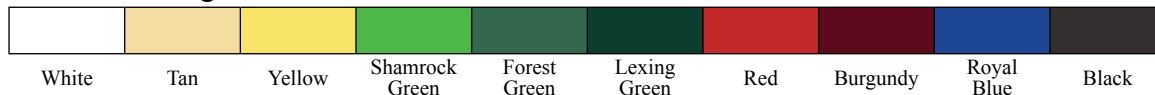

Bike Racks

Kay Park Recreation offers a variety of bicycle parking racks, including vertical bar style bike racks, loop style bicycle racks, as well as some unique low profile, circle, horseshoe and triangle bicycle parking racks. A similar item is offered specifically for skateboards and scooters. We have bicycle parking racks for any application.



Post Hoop Bike Rack

Made of 4 1/2" pipe tube and 3/4" loops. The base is made of 3/8" thick flange. Choose from a powder coat or galvanized finish and choose from surface mount in ground mount.

MBB2GIG	Galvanized In-Ground	57 Lbs
MBB2GSM	Galvanized Surface Mount	41 Lbs
MBB2CIG	Powder Coat In-Ground	53 Lbs
MBB2CSM	Powder Coat Surface Mount	37 Lbs



Horseshoe Style Bike Rack

Made of 2 3/8" O.D. steel pipe with surface mount base plate for bolting down. Available in hot dip galvanized or powder coated finish. Specify powder coat color. 2 bikes can be locked to it. One each side.

MHS2GSM	Galvanized Horseshoe Rack	32 Lbs
MHS2CSM	Powder Coated Horseshoe Rack	32 Lbs

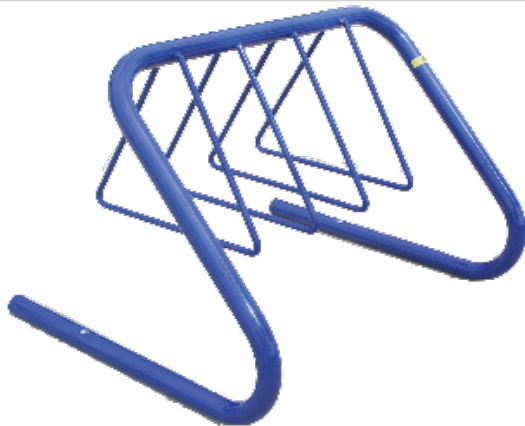

Triangle Style Bike Rack

A unique design made of 2 3/8" O.D. steel tubing frame with 3/4" solid steel rod triangles to lock bikes to. Comes in a variety of powder coat color finishes. Bike spaces are figured one between each triangle and one on each side of the end frames. (Loading from both sides.) This bike rack can hold 7 bikes.

TRBR7C	50" Length, 7 Spaces	85 Lbs
---------------	----------------------	--------

Powder Coating Colors:



1 5/8" O.D. Loop Style Bike Rack

A popular modern design and economically priced. Made of 1 5/8" O.D. schedule 40 pipe, these units come with either a hot-dip galvanized finish, or powder coated. Custom colors are available to match your surroundings. Comes as either an in-ground mount or with flanges for surface mounting. (The number of spaces is figured at one bicycle per loop and one at each end.)

In Ground

Length	Spaces	Loops		Galvanized	Powder Coated
15"	3	1	12 Lbs	611GIG	611CIG
39"	5	3	28 Lbs	613GIG	613CIG
71"	7	5	43 Lbs	615GIG	615CIG
88"	9	7	70 Lbs	617GIG	617CIG
113"	11	9	86 Lbs	619GIG	619CIG

Surface Mount

Length	Spaces	Loops		Galvanized	Powder Coated
15"	3	1	13 Lbs	611GSM	611CSM
39"	5	3	36 Lbs	613GSM	613CSM
71"	7	5	51 Lbs	615GSM	615CSM
88"	9	7	70 Lbs	617GSM	617CSM
113"	11	9	92 Lbs	619GSM	619CSM



2 3/8" O.D. Loop Style Bike Rack

Super heavy duty modern design unit. This model is made of 2 3/8" O.D. schedule 40 pipe, with either a hot-dip galvanized finish, or powder coated. Custom colors are available. Comes as either an in-ground mount, or with flanges for surface mounting. (The number of spaces is figured at one bicycle per loop and one at each end.)

In Ground

Length	Spaces	Loops		Galvanized	Powder Coated
15"	3	1	25 Lbs	621GIG	621CIG
39"	5	3	58 Lbs	623GIG	623CIG
71"	7	5	83 Lbs	625GIG	625CIG
88"	9	7	109 Lbs	627GIG	627CIG
113"	11	9	134 Lbs	629GIG	629CIG

Surface Mount

Length	Spaces	Loops		Galvanized	Powder Coated
15"	3	1	25 Lbs	621GSM	621CSM
39"	5	3	58 Lbs	623GSM	623CSM
71"	7	5	83 Lbs	625GSM	625CSM
88"	9	7	109 Lbs	627GSM	627CSM
113"	11	9	134 Lbs	629GSM	629CSM



Powder Coating Colors:



Vertical Bar Bike Racks



“J” Style Bike Racks

1052	5' galvanized, 8 spaces	74 Lbs
1052C	5' powder coated, 8 spaces	74 Lbs
1082	8' galvanized, 14 spaces	93 Lbs
1082C	8' powder coated, 14 spaces	93 Lbs
1102	10' galvanized, 18 spaces	122 Lbs
1102C	10' powder coated, 18 spaces	122 Lbs
1162	16' galvanized, 28 spaces	174 Lbs
1162C	16' powder coated, 28 spaces	174 Lbs
1202	20' galvanized, 36 spaces	234 Lbs
1202C	20' powder coated, 36 spaces	234 Lbs
1100	Anchor	3 Lbs

Vertical Bar Bike Racks

- 1 5/8" O.D. Frame
- 1" O.D. Tube Stall
- Powder coated 'C'
- Specify Color

1052 5' Galvanized
8 Spaces
Bike Rack
Only



Powder Coat Colors:
Black
Red
Burgundy
Forest Green
Royal Blue
Yellow
White
Tan

Custom color available upon agreed RAL number.

American Made Quality with an Affordable Price



“W” Style Bike Racks

7052	5' galvanized, 8 spaces	82 Lbs
7052C	5' powder coated, 8 spaces	82 Lbs
7082	8' galvanized, 14 spaces	98 Lbs
7082C	8' powder coated, 14 spaces	98 Lbs
7102	10' galvanized, 18 spaces	124 Lbs
7102C	10' powder coated, 18 spaces	124 Lbs
7162	16' galvanized, 28 spaces	180 Lbs
7162C	16' powder coated, 28 spaces	180 Lbs
7202	20' galvanized, 36 spaces	239 Lbs
7202C	20' powder coated, 36 spaces	239 Lbs
1100	Anchor	3 Lbs



“A” Style Bike Racks

5052	5' galvanized, 8 spaces	83 Lbs
5052C	5' powder coated, 8 spaces	83 Lbs
5082	8' galvanized, 14 spaces	98 Lbs
5082C	8' powder coated, 14 spaces	98 Lbs
5102	10' galvanized, 18 spaces	126 Lbs
5102C	10' powder coated, 18 spaces	126 Lbs
5162	16' galvanized, 28 spaces	182 Lbs
5162C	16' powder coated, 28 spaces	182 Lbs
5202	20' galvanized, 36 spaces	241 Lbs
5202C	20' powder coated, 36 spaces	241 Lbs
1100	Anchor	3 Lbs



Low Profile Style Bike Rack

- 1 1/16" O.D. 14 gauge High Tensile Galvanized Frame
- Anchor bolts sold separately.

	Lgth	Spaces		
4052	5'	6	Double Side	54 Lbs
4052C	5'	6	Double Side	54 Lbs
4102	10'	12	Double Side	107 Lbs
4102C	10'	12	Double Side	107 Lbs
4100	-	-	Anchor Set	3 Lbs



* Quick Ship Galvanized ONLY*

- *Economical*
- *Maintenance-free*

Powder Coat Colors:
Black
Red
Burgundy
Forest Green
Royal Blue
Yellow
White
Tan

Custom color available upon agreed RAL number.

Circle Style Bike Rack

- Circular Wheel Stalls 5/8" Steel Rod
- 2 3/8" O.D. Galvanized Frame ONLY
- 12" High
- Breaks Down to Reduce Freight



3102P Shown

Lgth	Spaces			In Ground	Surface Mount	Portable
5'	4	Single Side	61 Lbs	3051	3051SM	3051P
5'	8	Double Side	87 Lbs	3052	3052SM	3052P
10'	7	Single Side	96 Lbs	3101	3101SM	3101P
10'	14	Double Side	140 Lbs	3102	3102SM	3102P

*Help Make Your Area
Bike Friendly!*

Dugout Benches and Crowd Barricades/Fencing



Double Shelf-Back Players Bench

A frame that is fabricated of 2" x 2" x 3/16" aluminum angle for extra long life and rigidity. The seat is a 2" x 12" wide. The double wide shelf is designed for players who like to sit up on the backrests of benches, as well as providing a place to put gloves, bat bags, etc. up off the ground. Assembly required.

15DSBPBA	15' Double shelf-back bench	196 Lbs
21DSBPBA	21' Double shelf-back bench	275 Lbs
27DSBPBA	27' Double shelf-back bench	357 Lbs



Scorers Table

A frame that is fabricated of 2 3/8" O.D. pipe and hot dip galvanized after fabrication. Center cleat holds top level and the 1 5/16" cross braces stabilize this extra heavy duty frame. Tops and seats are Anodized Aluminum planks close proximity to the action. Available in 6' or 8' lengths. School color powder coated aluminum planks available at additional charge.

6J2GA1S	6' One sided scorer table	152 Lbs
8J2GA1S	8' One sided scorer table	165 Lbs

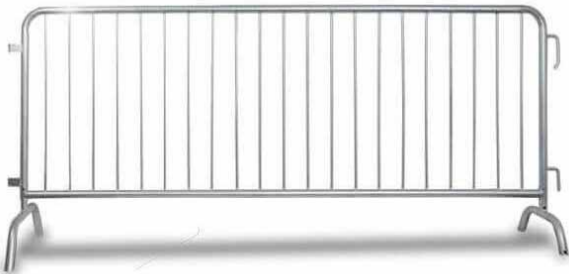

Economy Steel Barricade Fence

- 8.5 ft Economy Steel Barricade
- Lightweight, easy to carry
- Pre-galvanized
- Long term indoor use, limited outdoor use
- Flat or bridge feet
- Removable feet, easy stacking
- Hook and loop fastening system

KPBAR8BF	43" H x 8'4" L Sport barricade- Bridge Feet	44 Lbs
KPBARFF	43" H x 8'4" L Sport barricade- Flat Feet	44 Lbs



Cart

The Barricade Cart provides a safe, easy means of moving and storing up to 30 barricades at a time. Fabricated from heavy gauge steel this is a tough durable cart designed to withstand heavy use. Extending arms will carry up to 15 barricades on each side. (12 recommended for easy use).

KPBARCART	54.75" H x 74"W x 77.5"L	235 Lbs
------------------	--------------------------	---------

Bleacher Sun Shades

Keep patrons at your next event longer by shading them from the baking hot sun! Providing shade can reduce the temperature on the bleacher by nearly 20 degrees Fahrenheit and give fans up to 95% UV protection! Our shade fabric is woven, high-density polyethylene and is warranted for five years against failure due to rot, UV deterioration or faulty workmanship. The framework is top-quality powder coated steel. It comes with embedment poles and easy installation instructions. **(Surface mount poles are optional. Add 'SM' to the model number.)** Note: Shades are not designed for snow loads and must be removed in winter and when forecasted winds are over 75 mph. Standard colors below. Custom colors available.



Shades for 10 Row Bleachers - 15', 21', or 27'

Model	Dim.	Typical Bleacher Dim.	Typical # of Occupants	Weight
BS2218	18' L x 22' D x 12'H	15' L x 20' W	100	480 Lbs
BS2422	24' L x 22' D x 12'H	21' L x 20' W	140	598 Lbs
BS3022	30' L x 22' D x 12'H	27' L x 20' W	180	651 Lbs

95% UV Protection

Shades for 5 Row Bleachers - 15', 21', or 27'

Model	Dim.	Typical Bleacher Dim.	Typical # of Occupants	Weight
BS1812	18' L x 12' D x 9'H	15' L x 9' W	50	355 Lbs
BS2412	24' L x 12' D x 9'H	21' L x 9' W	70	410 Lbs
BS3012	30' L x 12' D x 9'H	27' L x 9' W	90	500 Lbs

Powder Coating Colors:

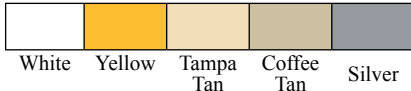

Keep players and guest cool and comfortable!



Shade Covers Colors:

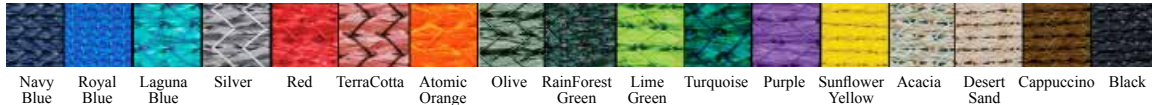

Dugout/Scorers Table Shade Covers

Offered to meet the increasing demand to provide shade to players to give them a break from the baking hot sun! Providing shade reduces the temperature in the dugout, gives them a break from harmful UV rays. Shade fabric is super-tough woven, high density polyethylene and is warranted for five years against failure due to rot, UV deterioration, or faulty workmanship. The framework is top-quality powder coated steel. It comes with poles for in-ground embedding as standard. **(Surface mount plate poles are optional. Add 'SM' to the model number.)** Note: Shades are not designed for snow loads and must be removed in winter and when forecasted winds are over 75 mph. Standard colors below. Custom colors available.

DS1012G	10' W x 12' L x 8' H	232 Lbs
DS1016G	10' W x 16' L x 8' H	260 Lbs
DS1018G	10' W x 18' L x 8' H	275 Lbs
DS1020G	10' W x 20' L x 8' H	295 Lbs



Bleacher Options



Design standards: The bleachers shall be designed to support, in addition to their weight, a uniformly distributed live load of not less than 120 pounds per square foot of gross horizontal projection of the bleachers. All seat and foot plank members shall be designed to support no less than 125 pounds per linear foot, over a 6 foot span, multi-span condition. Bleachers shall be designed to resist, with or without live load, horizontal wind load of 30 pounds per square foot of gross vertical projection. They shall be designed to resist, in addition to the live load, sway forces applied to the seats, in a direction parallel to the direction of the seat plank, 24 pounds per linear foot of seat plank, and separately, in a direction perpendicular to the direction of seats, 10 pounds per linear foot of seat plank.



Kay's Vertical Bar Guard Rails (V4) 4" Spaced

Kay Park's Vertical Bar Guard Rails (Patented #404-141) were introduced to the outdoor portable bleacher industry, an innovation whose time has come. Vertical galvanized steel bars eliminate the "ladder effect" and a possible toe - hold for climbing on the guardrails. The possibility of accidents and serious injury and liability can be reduced by using vertical bar railing. This is part of Kay Park's continuing effort to make good products even better since 1954. We urge you to plan your purchases on the side of safety. Please note that Kay Park's 3 & 4 Row Low Rise Bleachers are EXEMPT from current guard rail rules because they are less than 30" high. Model numbers with 'V4' include Vertical Bar Guard Rails.



Full Width Footboards (F4)

Many of the various recent codes for outdoor bleacher seating require any opening more than 30" above the ground be small enough so that a 4" sphere cannot pass through. Kay Park has designed a system using two footboards and one riser plank. This system fills the space underneath the seats from the 4th row up to meet the 4" sphere guideline. Double footboards add a lot of comfort and peace of mind to the spectators. Model numbers with 'F4' include the double footboards and riser planks.

NEW! Extruded riser provides even more strength and easier aisle assembly!



Custom Bleacher Wrap

Add custom wrap to your new bleachers for the finished look or add to older bleachers to add school spirit.

- Custom Design (Logo)
- Up to 60" Wide Panels Sections
- Direct Print to Mesh
- Full Color Bleed
- Grommets for Easy Assembly
- **Call for Pricing**

BLA Series Aluminum Angle Frame

Aluminum frames fabricated from a combination of 2" x 2" x 3/16" 6061-T6 alloy aluminum angles and channel using a punched and bolted type construction for maximum strength and safety. All main frame components are pre-assembled with large 1/2" diameter bolts, lock washers and nuts. This bolted aluminum frame provides strong joints that will not develop weld cracks. Model number with a 'BLA' are aluminum frames.

BLG Series Galvanized Steel Frame

Steel frames are fabricated from A36 alloy steel angles using full welds at all joints to give added strength. A combination of 2" x 2" x 3/16" and 1 3/4" x 1 3/4" x 3/16" angles are used, as required, for strength throughout each frame. Connecting "X" braces are 1 1/2" wide by 1/4" thick A36 alloy steel. For greatest protection and longest life, all parts are hot-dip galvanized after fabrication. Model numbers with a 'BLG' are galvanized steel frames.

Aisles & Handrails

Your local code may require one or more aisles and handrails. We do custom bleachers but some typical aisles are a 48" wide center aisle with handrail or a 36" wide aisle for an end aisle. Aisles require double footboards and risers and meet 4" opening guidelines. Heavy duty non-slip step up indicator tape is placed on each step for safety. Model numbers with '48AHR' include a 48" wide center aisle with handrail. Model numbers with '36A' include a 36" end aisle. Contact a sales rep for pricing.

Wheelchair Cut Outs

Check with your local code to see if they require wheelchair cut outs. The double wheelchair space allows for two wheelchairs and a companion to sit directly beside each wheelchair. Add 'DWCS' to the model number.

Bleacher Plank Specifications

Aluminum: Seat planks 6063-T6 extruded aluminum which is clear anodized to standard 204-R1 specification. Standard 8" rise per row uses 2" x 10" seats and low rise 6" rise uses 2" x 12" seats. Walk boards are 2" x 10" 6063-T6 extruded mill finish aluminum. End caps (anodized) and hold down clips are also extruded aluminum. Powder coated colors also available. Call for Details. Model numbers with a "Row#A" row number followed by an 'A' are aluminum planks. **Backrests available**. Fully enclosed decking also available.



CALL 1-800-553-2476 FOR A CUSTOMIZED QUOTE TODAY!

Better Bleacher Seat

- Transforms Your Bench Seating Into a Comfortable Stadium Style Chair
- Automatic Tip-Down Back Rest (Our Safety Must-Have)
- Manufactured for Your Code-Compliance for Both Indoor or Outdoor
- Superior Manufacturing Quality and Durability
- Tired of Renting? Purchase Outright or Over Time
- Keep All of Your Revenue
- No More Wet Seats
- Installation is Quick and Easy
- Improve a Row, a Section or Your Complete Facility
- Gray, royal blue, black and navy blue



BBSSEAT Seat 17.82" W x 11.97"D- Total Depth 14.3" 8 Lbs

Elevated Bleachers



Kay Park's Elevated Bleachers are made to the same high standards and have the same superior features as our non-elevated bleachers. They are backed by our 60 plus years of expertise in building commercial outdoor recreation products. They are safety-equipped with vertical bar guardrails (V4)(patent #404-141) and double width footboards with risers beneath the seats (F4), our elevated bleachers meet the 4" sphere guideline in recent building codes. Standard sizes are 5, 8, 10 and 15 rows and come in many different lengths, and seating capacities. Our bleacher specialist can help you determine placement of entrance stairs, wheelchair ramps, wheelchair spaces and aisles ways to best suit your space, needs and code requirement.

Call 1-800-553-2476 to get your custom quote.



Flexible Placement of:

- Entrance Stairs
- Wheelchair Ramps
- Wheelchair Spaces
- Aisles
- Other Custom Options

Standard Elevated Sizes:

5, 8, 10 & 15 Rows

Available in many different lengths & seating capacities.

CALL 1-800-553-2476 FOR A CUSTOMIZED QUOTE TODAY!

ADA Ramps



Add ADA seating to existing Non-compliant bleachers as Featured in: Dec. '14 Athletic Business

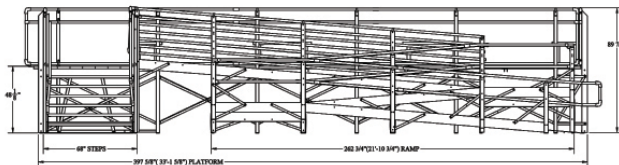

Fully Customizable

Custom ADA ramps. FREE Quotes Call Today.



Companion seats:



Elevated Bleachers

Standard 5, 8, 10 & 15 Rows - Many length, seating capacities & configuration!

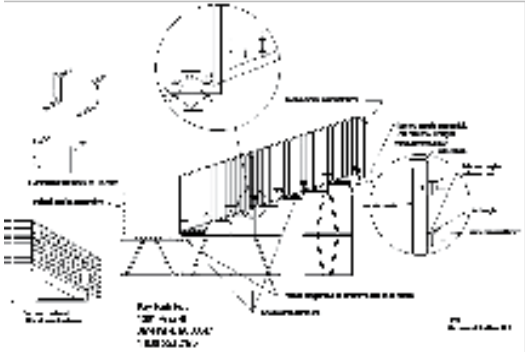
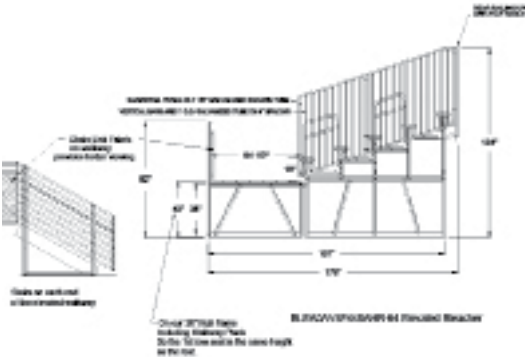

Have unique needs? We can work with you!!

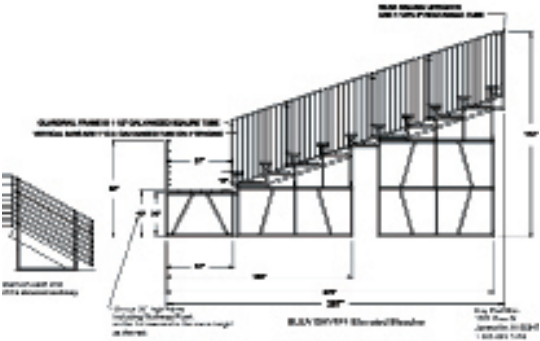

Drawings available. Call Us! 1-800-553-2476

10 Row Bleachers



10 Row Basics:
 Every 10 row includes; Safe Vertical Bar Guard Rails, Double Footboards & Risers that meet the 4" Guidelines.
Local Code May Require:
 -Optional ADA Spaces
 -Optional Aisles

Ask about our Powder Coating Options!
 Custom color coating any or all bleacher parts.

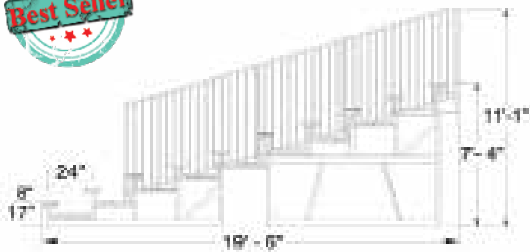

10 Row Standard 8" Rise Bleachers

Aluminum Frame

Strong 2" x 2" x 3/16" Angles & Channels

Model	Seat Plank	Rows	Length	Weight	# Seats
BLA10A15V4F4	Aluminum, 2x10 seat plank	10	15'	2155 Lbs	100
BLA10A21V4F4	Aluminum, 2x10 seat plank	10	21'	2805 Lbs	140
BLA10A27V4F4	Aluminum, 2x10 seat plank	10	27'	3484 Lbs	180
BLA10VP15V4F4	Plastisol, 2x10 seat plank	10	15'	2962 Lbs	100
BLA1015V4	Frame only, incl. hardware	10	15'	1625 Lbs	100

Galvanized Steel Frame

1 3/4" x 1 3/4" x 2" x 2" x 3/16" Angles

Model	Seat Plank	Rows	Length	Weight	# Seats
BLG10A15V4F4	Aluminum, 2x10 seat plank	10	15'	2535 Lbs	100
BLG10A21V4F4	Aluminum, 2x10 seat plank	10	21'	3355 Lbs	140
BLG10A27V4F4	Aluminum, 2x10 seat plank	10	27'	4155 Lbs	180
BLG10VP15V4F4	Plastisol, 2x10 seat plank	10	15'	3185 Lbs	100
BLG1015V4	Frame only, incl. hardware	10	15'	1614 Lbs	100

48AHR	48" Aisle & handrail	120 Lbs
36A	36" Aisle (15' units end only)	75 Lbs

Jiffy Mover For 10 Row

Kay Park's Jiffy Mover "crank-up" unit is fast and easy to use for just one person. Special care has gone into the Jiffy design to reduce tongue weight for easier maneuvering by hand if needed. Primarily designed for transporting 10 row, 15', 21', and 27', long bleachers. Top recommended speed is 5 MPH. Aluminum frame bleachers only.

Complete Systems	-(Permanently stays w/ bleacher.)	
JIF1015	10 Row, 15' long-complete system	665 Lbs
JIF1021	10 Row, 21' long-complete system	722 Lbs
JIF1027	10 Row, 27' long-complete system	777 Lbs





Optional ADA Wheelchair Spaces for any Bleacher.

DWCS Double Space

8 Row Basics:

Every 8 row includes; Safe Vertical Bar Guard Rails, Double Footboards & Risers that meet the 4" Guidelines.

Local Code May Require:

- Optional ADA Spaces
- Optional Aisles



8 Row Standard 8" Rise Bleachers

Aluminum Frame

Strong 2" x 2" x 3/16" Angles & Channels

Model	Seat Plank	Rows	Length	Weight	# Seats
BLA8A15V4F4	Aluminum, 2x10 seat plank	8	15'	1736 Lbs	80
BLA8A21V4F4	Aluminum, 2x10 seat plank	8	21'	2300 Lbs	112
BLA8A27V4F4	Aluminum, 2x10 seat plank	8	27'	2960 Lbs	144
BLA8VP15V4F4	Plastisol, 2x10 seat plank	8	15'	2325 Lbs	80
BLA815V4	Frame only, incl. hardware	8	15'	1159 Lbs	80

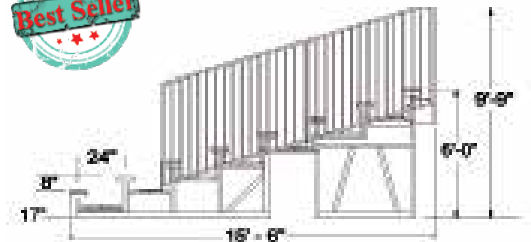

Galvanized Steel Frame

1 3/4" x 1 3/4" x 2" x 2" x 3/16" Angles

Model	Seat Plank	Rows	Length	Weight	# Seats
BLG8A15V4F4	Aluminum, 2x10 seat plank	8	15'	2006 Lbs	80
BLG8A21V4F4	Aluminum, 2x10 seat plank	8	21'	2640 Lbs	112
BLG8A27V4F4	Aluminum, 2x10 seat plank	8	27'	3367 Lbs	144
BLG8VP15V4F4	Plastisol, 2x10 seat plank	8	15'	2601 Lbs	80
BLG815V4	Frame only, incl. hardware	8	15'	1271 Lbs	80

48AHR	48" Aisle & handrail	120 Lbs
36A	36" Aisle (15' units end only)	75 Lbs

Jiffy Mover For 8 Row

Kay Park's Jiffy Mover "crank-up" unit is fast and easy to use for just one person. Special care has gone into the Jiffy design to reduce tongue weight for easier maneuvering by hand if needed. Primarily designed for transporting 8 row, 15', 21', and 27', long bleachers.

Top recommended speed is 5 MPH. Aluminum frame bleachers only.

Complete Systems	(Permanently stays w/ bleacher.)	
JIF815	8 Row, 15' long-complete system	525 Lbs
JIF821	8 Row, 21' long-complete system	582 Lbs
JIF827	8 Row, 27' long-complete system	642 Lbs



When Ordering Bleachers

We advise that you check your local requirements for such things as aisle, guardrails, ADA, or other requirements. Building codes may vary by year written and by group who issues them (IBC, UBC, BOCA, SBC, NFPA, etc.)

5 Row Bleachers



5 Row Basics:
 5 row includes Safe Vertical Bar
 Guard Rails, Double Foot-
 boards & Risers that meet the 4"
 Guidelines.
Local Code May Require:
 -Optional ADA Spaces
 -Optional Aisles

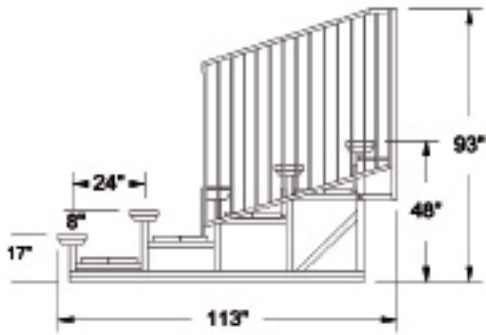

5 Row Standard 8" Rise Bleachers

Aluminum Frame

Model	Seat Plank	Rows	Length	Weight	# Seats
BLA5A15V4F4	Aluminum, 2x10 seat plank	5	15'	1063 Lbs	50
BLA5A21V4F4	Aluminum, 2x10 seat plank	5	21'	1423 Lbs	70
BLA5A27V4F4	Aluminum, 2x10 seat plank	5	27'	1735 Lbs	90
BLA5VP15V4F4	Plastisol, 2x10 seat plank	5	15'	1255 Lbs	50
BLA515V4	Frame only, incl. hardware	5	15'	667 Lbs	50

Strong 2" x 2" x 3/16" Angles & Channels

Galvanized Steel Frame

Model	Seat Plank	Rows	Length	Weight	# Seats
BLG5A15V4F4	Aluminum, 2x10 seat plank	5	15'	1124 Lbs	50
BLG5A21V4F4	Aluminum, 2x10 seat plank	5	21'	1494 Lbs	70
BLG5A27V4F4	Aluminum, 2x10 seat plank	5	27'	1863 Lbs	90
BLG5VP15V4F4	Plastisol, 2x10 seat plank	5	15'	1450 Lbs	50
BLG515V4	Frame only, incl. hardware	5	15'	718 Lbs	50

1 3/4" x 1 3/4" x 2" x 2" x 3/16" Angles

48AHR	48" Aisle & handrail	120 Lbs
36A	36" Aisle (15' units end only)	75 Lbs

5 Row 6" Low Rise Bleachers

Aluminum Frame

Model	Seat Plank	Rows	Length	Weight	# Seats
BLRA5A15V4F4	Aluminum, 2x12 seat plank	5	15'	925 Lbs	50
BLRA5A21V4F4	Aluminum, 2x12 seat plank	5	21'	1273 Lbs	70
BLRA5A27V4F4	Aluminum, 2x12 seat plank	5	27'	1419 Lbs	90
BLRA515V4	Frame only, incl. hardware	5	15'	561 Lbs	50

Strong 2" x 2" x 3/16" Angles & Channels

Galvanized Steel Frame

Model	Seat Plank	Rows	Length	Weight	# Seats
BLRG5A15V4F4	Aluminum, 2x12 seat plank	5	15'	1063 Lbs	50
BLRG5A21V4F4	Aluminum, 2x12 seat plank	5	21'	1456 Lbs	70
BLRG5A27V4F4	Aluminum, 2x12 seat plank	5	27'	1820 Lbs	90
BLRG515V4	Frame only, incl. hardware	5	15'	668 Lbs	50

1 3/4" x 1 3/4" x 2" x 2" x 3/16" Angles

6" Low Rise Bleachers ("LR")

Aisle and handrails NOT required by many codes when: * 11 1/2" Wide seat planks

* Rise to 6" per row

* First row seat is 12" high



Jiffy Mover For 5 Row

Kay Park's Jiffy Mover "crank-up" unit is fast and easy to use for just one person. Special care has gone into the Jiffy design to reduce tongue weight for easier maneuvering by hand if needed. Primarily designed for transporting 5 row 15', 21', and 27', long bleachers. Top recommended speed is 5 MPH. Aluminum frame bleachers only.

Complete Systems	(Permanently stays w/ bleacher.)	Weight
JIF51521	5 Row, 15' & 21' long-complete system	291 Lbs
JIF527	5 Row, 27' long-complete system	395 Lbs

Component Models	- 5 row model only- (Transferable Parts)	Weight
JIF5JACK	5 Row, jack only (1 total)	40 Lbs
JIF5WT1521	5 Row, wheel and tongue (1 total) 15', 21'	175 Lbs
JIF5WT27	5 Row, wheel and tongue (1 total) 27'	205 Lbs
JIF5FRM1521	5 Row, frame parts (1 per bleacher) 15', 21'	70 Lbs
JIF5FRM27	5 Row, frame parts (1 per bleacher) 27'	95 Lbs



Optional ADA Wheelchair Spaces for any Bleacher.

DWCS Double Space

5 Row Basics:

- This page has NO Guardrails
- This page has No Double Footboard & Risers

Local Code May Require:

- Optional ADA Spaces
- Optional Aisles



5 Row 8" Rise Bleachers- No Rails & 1 Footboard

Aluminum Frame

Strong 2" x 2" x 3/16" Angles & Channels

Model	Seat Plank	Rows	Length	Weight	# Seats
BLA5A15	Aluminum, 2x10 seat plank	5	15'	395 Lbs	50
BLA5A21	Aluminum, 2x10 seat plank	5	21'	573 Lbs	70
BLA5A27	Aluminum, 2x10 seat plank	5	27'	708 Lbs	90
BLA5VP15	Plastisol, 2x10 seat plank	5	15'	587 Lbs	50
BLA515	Frame only, incl. hardware	5	15'	166 Lbs	50

Galvanized Steel Frame

1 3/4" x 1 3/4" x 2" x 2" x 3/16" Angles

Model	Seat Plank	Rows	Length	Weight	# Seats
BLG5A15	Aluminum, 2x10 seat plank	5	15'	523 Lbs	50
BLG5A21	Aluminum, 2x10 seat plank	5	21'	756 Lbs	70
BLG5A27	Aluminum, 2x10 seat plank	5	27'	947 Lbs	90
BLG5VP15	Plastisol, 2x10 seat plank	5	15'	704 Lbs	50
BLG515	Frame only, incl. hardware	5	15'	293 Lbs	50

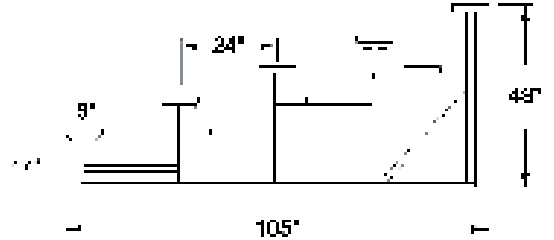

5 Row 6" Low Rise Bleachers- No Rails & 1 Footboard

Aluminum Frame

Strong 2" x 2" x 3/16" Angles & Channels

Model	Seat Plank	Rows	Length	Weight	# Seats
BLRA5A15	Aluminum, 2x12 seat plank	5	15'	395 Lbs	50
BLRA5A21	Aluminum, 2x12 seat plank	5	21'	573 Lbs	70
BLRA5A27	Aluminum, 2x12 seat plank	5	27'	708 Lbs	90
BLRA515	Frame only, incl. hardware	5	15'	166 Lbs	50

Galvanized Steel Frame

1 3/4" x 1 3/4" x 2" x 2" x 3/16" Angles

Model	Seat Plank	Rows	Length	Weight	# Seats
BLRG5A15	Aluminum, 2x12 seat plank	5	15'	533 Lbs	50
BLRG5A21	Aluminum, 2x12 seat plank	5	21'	756 Lbs	70
BLRG5A27	Aluminum, 2x12 seat plank	5	27'	947 Lbs	90
BLRG515	Frame only, incl. hardware	5	15'	273 Lbs	50

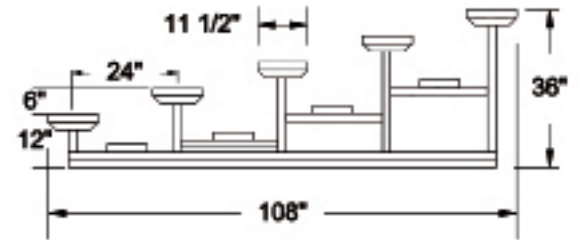

Jiffy Mover For 5 Row

Kay Park's Jiffy Mover "crank-up" unit is fast and easy to use for just one person. Special care has gone into the Jiffy design to reduce tongue weight for easier maneuvering by hand if needed. Primarily designed for transporting 5 row, 15', 21', and 27', long bleachers. Top recommended speed is 5 MPH. Aluminum frame bleachers only.

Complete Systems - (Permanently stays w/ bleacher.)

JIF51521	5 Row, 15' & 21' long-complete system	291 Lbs
JIF527	5 Row, 27' long-complete system	395 Lbs

Component Models - 5 row model only- (Transferable Parts)

JIF5JACK	5 Row, jack only (1 total)	40 Lbs
JIF5WT1521	5 Row, wheel and tongue (1 total) 15', 21'	175 Lbs
JIF5WT27	5 Row, wheel and tongue (1 total) 27'	205 Lbs
JIF5FRM1521	5 Row, frame parts (1 per bleacher) 15', 21'	70 Lbs
JIF5FRM27	5 Row, frame parts (1 per bleacher) 27'	95 Lbs



4 Row Bleachers



4 Row Basics:

Available with or without; Safe Vertical Bar guard Rails, Double Footboards & Risers that meet the 4" Guidelines.

Local Code May Require:

- Optional ADA Spaces
- Optional Aisles

Design Standards:

Please refer to pages 70 & 71 for design standards. Please call 1-800-553-2476 for specification

4 Row Standard 8" Rise

Aluminum Frame

Model	Seat Plank
BLA4A15V4F4	Aluminum, 2x10 seat plank
BLA4A21V4F4	Aluminum, 2x10 seat plank
BLA4A27V4F4	Aluminum, 2x10 seat plank
BLA4VP15V4F4	Plastisol, 2x10 seat plank
BLA415V4	Frame only, incl. hardware

Strong 2" x 2" x 3/16" Angles & Channels

Rows	Length	Weight	# Seats
4	15'	850 Lbs	40
4	21'	1138 Lbs	56
4	27'	1388 Lbs	72
4	15'	1004 Lbs	40
4	15'	553 Lbs	40

Galvanized Steel Frame

Model	Seat Plank
BLG4A15V4F4	Aluminum, 2x10 seat plank
BLG4A21V4F4	Aluminum, 2x10 seat plank
BLG4A27V4F4	Aluminum, 2x10 seat plank
BLG4VP15V4F4	Plastisol, 2x10 seat plank
BLG415V4	Frame only, incl. hardware

1 3/4" x 1 3/4" x 2" x 2" x 3/16" Angles

Rows	Length	Weight	# Seats
4	15'	930 Lbs	40
4	21'	1261 Lbs	56
4	27'	1579 Lbs	72
4	15'	1097 Lbs	40
4	15'	634 Lbs	40

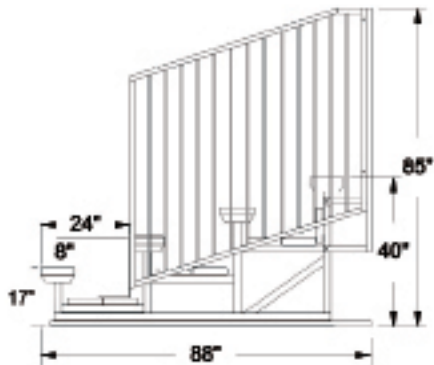

48AHR	48" Aisle & handrail	120 Lbs
36A	36" Aisle (15' units end only)	75 Lbs

4 Row Standard 8" Rise - No Rails & 1 Footboard

Aluminum Frame

Model	Seat Plank
BLA4A7.5	Aluminum, 2x10 seat plank
BLA4A15	Aluminum, 2x10 seat plank
BLA4A21	Aluminum, 2x10 seat plank
BLA4A27	Aluminum, 2x10 seat plank
BLA4VP15	Plastisol, 2x10 seat plank
BLA415	Frame only, incl. hardware

Strong 2" x 2" x 3/16" Angles & Channels

Rows	Length	Weight	# Seats
4	7.5'	189 Lbs	20
4	15'	322 Lbs	40
4	21'	458 Lbs	56
4	27'	571 Lbs	72
4	15'	598 Lbs	40
4	15'	139 Lbs	40

Galvanized Steel Frame

Model	Seat Plank
BLG4A7.5	Aluminum, 2x10 seat plank
BLG4A15	Aluminum, 2x10 seat plank
BLG4A21	Aluminum, 2x10 seat plank
BLG4A27	Aluminum, 2x10 seat plank
BLG4VP15	Plastisol, 2x10 seat plank
BLG415	Frame only, incl. hardware

1 3/4" x 1 3/4" x 2" x 2" x 3/16" Angles

Rows	Length	Weight	# Seats
4	7.5'	240 Lbs	20
4	15'	418 Lbs	40
4	21'	605 Lbs	56
4	27'	758 Lbs	72
4	15'	563 Lbs	40
4	15'	234 Lbs	40

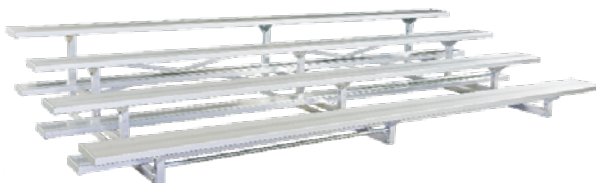
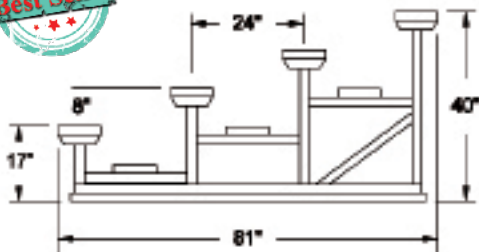

4 Row 6" Rise - No Rails & 1 Footboard

Aluminum Frame

Model	Seat Plank
BLRA4A7.5	Aluminum, 2x12 seat plank
BLRA4A15	Aluminum, 2x12 seat plank
BLRA4A21	Aluminum, 2x12 seat plank
BLRA4A27	Aluminum, 2x12 seat plank
BLRA415	Frame only, incl. hardware

Strong 2" x 2" x 3/16" Angles & Channels

Rows	Length	Weight	# Seats
4	7.5'	198 Lbs	20
4	15'	316 Lbs	40
4	21'	447 Lbs	56
4	27'	563 Lbs	72
4	15'	130 Lbs	40

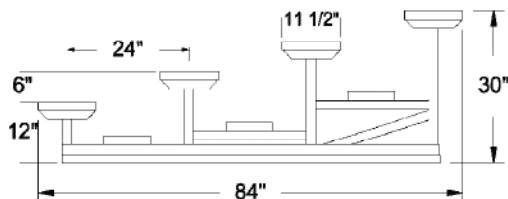

Galvanized Steel Frame

Model	Seat Plank
BLRG4A7.5	Aluminum, 2x12 seat plank
BLRG4A15	Aluminum, 2x12 seat plank
BLRG4A21	Aluminum, 2x12 seat plank
BLRG4A27	Aluminum, 2x12 seat plank
BLRG415	Frame only, incl. hardware

1 3/4" x 1 3/4" x 2" x 2" x 3/16" Angles

Rows	Length	Weight	# Seats
4	7.5'	240 Lbs	20
4	15'	418 Lbs	40
4	21'	605 Lbs	56
4	27'	758 Lbs	72
4	15'	234 Lbs	40

2022

4 Row Basics:

- This page has NO Guardrails
- This page has No Double Footboard & Risers

Local Code May Require:

- Optional ADA Spaces
- Optional Aisles

6" Low Rise Bleachers ("LR")

Aisle and handrails NOT required by many codes when:

- * 11 1/2 Wide seat planks
- * Rise to 6" per row
- * First row seat is 12" high

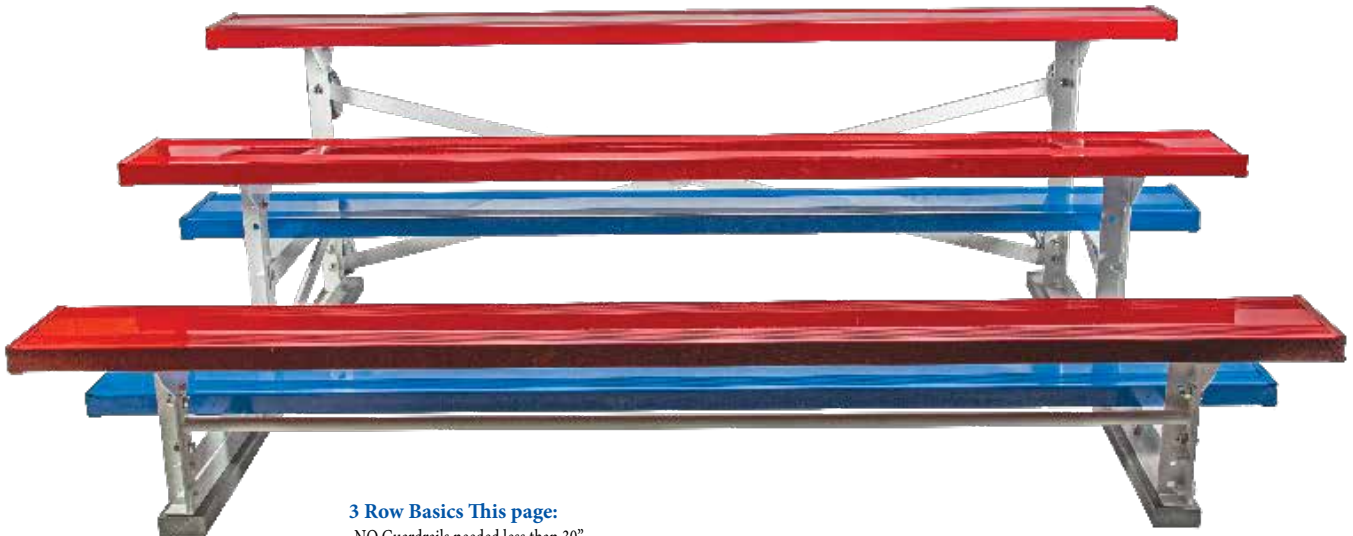

3 Row Basics This page:

- NO Guardrails needed less than 30"
- NO Double footboards
- Check your local codes

Local Code May Require:

- Optional ADA Spaces
- Optional Aisles

Shown Tip & Roll
with custom powder coat.
Call for price quote.
1-800-553-2476



3 Row 7" Rise Aluminum Frame

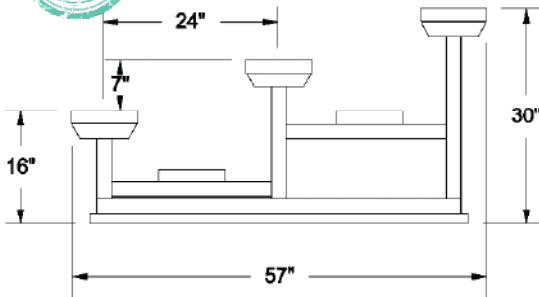

Model	Seat Plank
BLA3A7.5	Aluminum, 2x10 seat plank
BLA3A15	Aluminum, 2x10 seat plank
BLA3A21	Aluminum, 2x10 seat plank
BLA3A27	Aluminum, 2x10 seat plank
BLA3VP15	Plastisol, 2x10 seat plank
BLA315	Frame only, incl. hardware

Strong 2" x 2" x 3/16" Angles & Channels

Rows	Length	Weight	# Seats
3	7.5'	136 Lbs	15
3	15'	223 Lbs	30
3	21'	326 Lbs	42
3	27'	420 Lbs	54
3	15'	342 Lbs	30
3	15'	95 Lbs	30

Galvanized Steel Frame

Model	Seat Plank
BLG3A7.5	Aluminum, 2x10 seat plank
BLG3A15	Aluminum, 2x10 seat plank
BLG3A21	Aluminum, 2x10 seat plank
BLG3A27	Aluminum, 2x10 seat plank
BLG3VP15	Plastisol, 2x10 seat plank
BLG315	Frame only, incl. hardware

1 3/4" x 1 3/4" x 2" x 2" x 3/16" Angles

Rows	Length	Weight	# Seats
3	7.5'	160 Lbs	15
3	15'	277 Lbs	30
3	21'	395 Lbs	42
3	27'	510 Lbs	54
3	15'	385 Lbs	30
3	15'	151 Lbs	30

3 Row 6" Low Rise Aluminum Frame

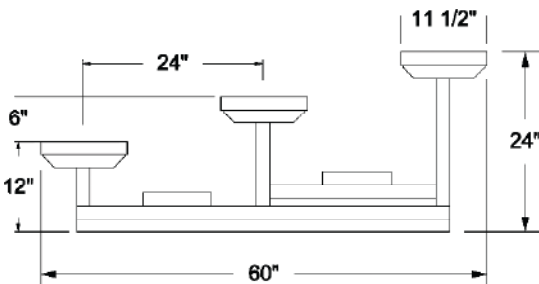

Model	Seat Plank
BLRA3A7.5	Aluminum, 2x12 seat plank
BLRA3A15	Aluminum, 2x12 seat plank
BLRA3A21	Aluminum, 2x12 seat plank
BLRA3A27	Aluminum, 2x12 seat plank
BLRA315	Frame only, incl. hardware

Strong 2" x 2" x 3/16" Angles & Channels

Rows	Length	Weight	# Seats
3	7.5'	136 Lbs	15
3	15'	223 Lbs	30
3	21'	326 Lbs	42
3	27'	420 Lbs	54
3	15'	95 Lbs	30

Galvanized Steel Frame

Model	Seat Plank
BLRG3A7.5	Aluminum, 2x12 seat plank
BLRG3A15	Aluminum, 2x12 seat plank
BLRG3A21	Aluminum, 2x12 seat plank
BLRG3A27	Aluminum, 2x12 seat plank
BLRG315	Frame only, incl. hardware

1 3/4" x 1 3/4" x 2" x 2" x 3/16" Angles

Rows	Length	Weight	# Seats
3	7.5'	160 Lbs	15
3	15'	277 Lbs	30
3	21'	395 Lbs	42
3	27'	510 Lbs	54
3	15'	151 Lbs	30

6" Low Rise Bleachers ("LR")

Aisle and handrails NOT required by many codes when:

- * 11 1/2 Wide seat planks
- * Rise to 6" per row
- * First row seat is 12" high

When Ordering Bleachers

We advise that you check your local requirements for such things as aisle, guardrails, ADA, or other requirements. Building codes may vary by year written and by group who issues them (IBC, UBC, BOCA, SBC, NFPA, etc.)

2 Row, Back2Back & Bleacher Renovation



2 Row 8" Rise Bleachers

Aluminum Frame

Strong 2" x 2" x 3/16" Angles & Channels

Model	Seat Plank	Rows	Length	Weight	# Seats
BLA2A7.5	Aluminum, 2x10 seat plank	2	7.5'	83 Lbs	10
BLA2A15	Aluminum, 2x10 seat plank	2	15'	145 Lbs	20
BLA2A21	Aluminum, 2x10 seat plank	2	21'	225 Lbs	28
BLA2A27	Aluminum, 2x10 seat plank	2	27'	260 Lbs	36
BLA2A15	Frame only, incl. hardware	2	15'	77 Lbs	20

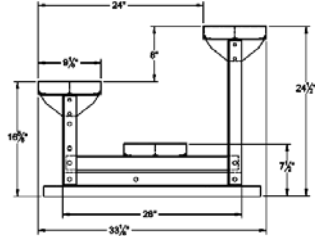

3 Row 7" Rise Back 2 Back Bleachers

Aluminum Frame

Strong 2" x 2" x 3/16" Angles & Channels

Model	Seat Plank	Rows	Length	Weight	# Seats
BLDA3A7.5	Aluminum, 2x10 seat plank	3	7.5'	240 Lbs	25
BLDA3A15	Aluminum, 2x10 seat plank	3	15'	299 Lbs	50
BLDA3A21	Aluminum, 2x10 seat plank	3	21'	561 Lbs	70
BLDA3A27	Aluminum, 2x10 seat plank	3	27'	690 Lbs	90
BLDA315	Frame only, incl. hardware	3	15'	164 Lbs	50

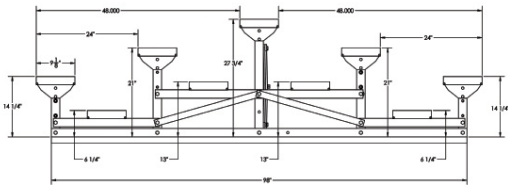

Back 2 Back bleachers are ideal between soccer fields and tennis courts

Bleacher Renovation



*Custom ADA ramps.
FREE Quotes
Call Today.*



*Before
&
After*



*Tired of replacing wood planks?
Switch to Aluminum!*

Jiffy Movers

Kay Park's Jiffy Mover "crank-up" unit is fast and easy to use for just one person. Special care has gone into the Jiffy design to reduce tongue weight for easier maneuvering by hand if needed. Primarily designed for transporting 5 row 15', 21', and 27', long bleachers. Top recommended speed is 5 MPH. Aluminum frame bleachers only.

Complete Systems	- (Permanently stays w/ bleacher.)	
JIF51521	5 Row, 15' & 21' long-complete system	291 Lbs
JIF527	5 Row, 27' long-complete system	395 Lbs
Complete Systems	- (Permanently stays w/ bleacher.)	
JIF815	8 Row, 15' long-complete system	525 Lbs
JIF821	8 Row, 21' long-complete system	582 Lbs
JIF827	8 Row, 27' long-complete system	642 Lbs
Complete Systems	- (Permanently stays w/ bleacher.)	
JIF1015	10 Row, 15' long-complete system	665 Lbs
JIF1021	10 Row, 21' long-complete system	722 Lbs
JIF1027	10 Row, 27' long-complete system	777 Lbs

Designed to move with reinforced infrastructure



No Parts to Lose



**One
Person
Set-Up
10 Min**

Bleacher Stays Intact

**Easy
to
Move**



Tip & Roll System

Kay Park Tip & Roll Bleachers are particularly suitable for your indoor seating that must be moved from one activity to another. Non-marring sills prevent scuffing of floors. Their special length rear extension and clearance above the floor makes tipping either aluminum or galvanized frames in 3, 4, & 5 row models, without railing. Tipping will be easiest with aluminum frames. The set of four 5" casters set contains 2 casters with brakes. **NOT available on 8 & 10 row bleachers**

Length	Rise			3 Row	4 Row	5 Row
15'	8"	4-5" Casters	31 Lbs	BLTR315	BLTR415	BLTR515
21'	8"	4-5" Casters	31 Lbs	BLTR321	BLTR421	BLTR521
27'	8"	6-5" Casters	44 Lbs	BLTR327	BLTR427	BLTR527
15'	6"	4-5" Casters	31 Lbs	BLTRLR315	BLTRLR415	
21'	6"	4-5" Casters	31 Lbs	BLTRLR321	BLTRLR421	
27'	6"	6-5" Casters	44 Lbs	BLTRLR327	BLTRLR427	



Put Safety First! Easy to Move Tip & Roll

Speedy Stage

Easy To Use!

1. Park It!



SPSTG27 Shown

2. Unfold It!

Saves Time and Money



SPSTG27 Shown

3. Use It!

Stretch Budget 1 unit Multiple Locations



Highway Towable Elevated Folding Stage

All-weather construction of Galvanized Steel and Aluminum

Standard Features:

- 12 Volt Hydraulic Operating System
- Push Button Folding
- Adjustable Stabilizing Jacks
- Telescopic Tongue
- LED Lights
- Electric Brakes
- Stairs
- Stationary Safety Rails
- Aluminum Deck
- Outlets
- Tandem Axle
- Optional Spare Tire
- Laminated Plywood Deck



This customer loves his Speedy Stage! He brings his show to life with the Speedy Stage decked out!

Speedy Stage

	Folded	Unfolded	Tow	Weight
SPSTG27	27'L x 8.5'W x 8.6'H	27'L x 16'W x 40"H	30'L x 8.5'W x 8.6'H	4,850 Lbs
SPSTG3020	30'L x 8.5'W x 11.6'H	30'L x 20'W x 48"H	34'L x 8.5'W x 11.6'H	8,950 Lbs



SPSTG3020 Shown

*Call for Price Quote Today!
1-800-553-2476*

Speedy Bleacher - Highway Towable Bleacher

1. Park It!



Standard Features:

- Vertical baluster bar guard rails (deters climbing) Pat. 404-141
- Hot-dip galvanized guard rail
- Heavy I-Beam main frame
- Aluminum seats & walk boards
- Stop, turn & clearance lights
- Electric brakes all four wheels
- 12-Volt hydraulic folding mechanism (self-contained battery & charger)
- Full 24" row spacing for today's taller people
- Telescoping tongue is removable (EZ slide tongue roller system)
- Semi-trailer type stabilizing jacks (high sway-load capacity-35,000 Lbs static load each)

2. Unfold It!

Easy
Push-Button
Operation!



- Lease to Own Options Available
- Share with City, School or Fair
- Rent to Generate Revenue

3. Use It!

Optional Features:

- Full width footboards & risers
- 48" Aisle (reduces capacity by 27 seats)
- Sturdy aisle handrail
- Push button operated hydraulic jacks
- Goose-neck towing hitch (folds flat)
- Storage Basket



Seating for 300
People In Less Than
10 Minutes!

Call for Price Quotes
Today!
1-800-553-2476

Speedy Bleacher - Highway Towable Bleacher

Call for Price Quotes Today!
1-800-553-2476



**Change to 3,000 Seats
In 1 hour!**

**Create A Stadium Anywhere
You Need The Seating!**



**Seating,
Where YOU need it,
When YOU need it,
FAST!**

Great for all of the following:

- Parades
- Baseball/Softball
- Football/Rugby
- Concerts
- Track/Cross Country
- Assemblies
- Graduation
- Tennis
- Soccer
- Tournaments
- Fairs/ Festivals
- Celebrations
- Speakers
- Training
- Arenas
- Golf
- Bands or on the sidelines.

Speedy Bleacher - Highway Towable Bleacher



Invest Thoughtfully

7 Row	Seating Capacity	Row Length	Static Jack Load Cap.	Width	Length	Tow Width	Tow Length	Tow Height	Total Weight	Tongue Weight
SPBL2707	108	27'	30,000#	13'6"	29'3"	102"	32'11"	8'11"	4,100 Lbs	Approx. 550Lbs

Speedy Bleachers can be Parked, Set Up & Ready to use In just 10 Minutes

9 Row	Seating Capacity	Row Length	Static Jack Load Cap.	Width	Length	Tow Width	Tow Length	Tow Height	Total Weight	Tongue Weight
SPBL3009	180	30'	140,000#	17'4"	31'6"	102"	35'1"	10'9"	8,830 - 9,480 Lbs	Approx. 1,270 Lbs
SPBL4009	234	39'	210,000#	17'4"	41'6"	102"	45'1"	10'9"	9,400 - 11,400 Lbs	Approx. 1,600 Lbs
SPBL4509	270	45'	210,000#	17'4"	46'6"	102"	50'1"	10'9"	11,690 - 12,270 Lbs	Approx. 1,750 Lbs

10 Row	Seating Capacity	Row Length	Static Jack Load Cap.	Width	Length	Tow Width	Tow Length	Tow Height	Total Weight	Tongue Weight
SPBL3010	200	30'	140,000#	19'4"	31'6"	102"	35'1"	12'6"	8,730 - 9,470 Lbs	Approx. 1,175 Lbs
SPBL4010	260	39'	210,000#	19'4"	41'6"	102"	45'1"	12'6"	9,400 - 11,900 Lbs	Approx. 1,550 Lbs
SPBL4510	300	45'	210,000#	19'4"	46'6"	102"	50'1"	12'6"	12,020 - 13,170 Lbs	Approx. 1,730 Lbs

Options to fit your needs! CALL TODAY! 1-800-553-2476



Semi-Trailer type stabilizing jacks, 35,000 Lbs each. 4 jacks on 30' Speedy and 6 jacks on 40' & 45' Speedy. Operate from a standing position. Pat. No. 6,499,258



All Jacks are operated from the back side of the SPEEDY BLEACHER while you are in a full-upright standing position. (No stooping or squatting to operate numerous small jacks.) On 9 and 10 row units.

Adding an aisle
10 row deducts 27 seats
9 row deducts 24



A Central Aisle & Sturdy Hand Rail are Good Safety Options. Come standard on 7 and 8 row units.



ADA wheelchair spaces! Includes required companion seats.

Pedal Boats



Special Orders
May Cost Extra.

1,000+ Lbs
Net Flotation

1,500+ Lbs
Net Flotation

PCII 2 Passenger 22.1 cu ft. Flotation

PCII Glitter	9'6" L x 5'3" W x 2'6" H	260 Lbs
PCII	9'6" L x 5'3" W x 2'6" H	260 Lbs

PCIV 4 Passenger 30.4 cu ft. Flotation

PCIV Glitter	10'4" L x 5'3" W x 2'6" H	320 Lbs
PCIV	10'4" L x 5'3" W x 2'6" H	320 Lbs

Reinforced Fiberglass
Finish in bright eye catching colors!
Std: Red, Blue Yellow, Shamrock, Green,
and Forest Green.

Steering Wheel
Is center mounted so either passenger
can operate. (Steers like a car!)
(Not confusing like a handle.)

Direct Drive Paddle Wheel
Is specially designed for greater speed
and easier pedaling!

Built-In Non Skid Surface
on PCIV rear deck!
(Not stick on strips.) Rear
deck has raised perimeter
to help prevent things
from sliding off.

Resilient Vinyl Molding
All around perimeter
helps absorb shocks!

Anodized Aluminum Grab Rails
around rear deck!
(Hand rails also available for sides.)

100% Foam-Filled Pontoons
Boat floats level even if one
pontoon is punctured!
(Very important safety factor!)

**Front Marine-Grade Chromed
Handles & Stainless Mooring Eye**
on each side for convenience!
(Mooring eyes or handles in other
locations also available.)

Four Regreassable Bronze Bearings
With easy-to-reach fittings.
(Cuts downtime and lost profit!)

**Patented, Self-Draining Pedal Wells,
Seats, and Pontoons**
Water automatically drains out!



Kay Park Pedal Boats

Pedal boats by Kay Park Recreation are the best commercial-duty fiberglass pedal boats on the market. These pedal boats feature foam-filled pontoons, re-greasable bearings, and are self-draining, making them a trouble-free pedal boat choice for rental operations in public parks, camps and resorts.



Virtually Maintenance-Free

"We've been buying Kay Park Pedal Cruisers for years. We've tried other pedal boats in the past, but we got tired of pulling them out to drain and repair them. Our Kay Park Pedal Cruisers stay in the water all season without giving us any trouble. We don't buy anything else!"

The Difference is Kay's

- Aluminum Grab Rails**
Placed around rear deck! (Hand rails available for sides)
- **Marine-Grade Chromed Handles**
Available on each side for convenience!
- **Resilient Vinyl Mouldings**
Secured around the perimeter to help absorb shocks!
- **Four Regreasable Bronze Bearings**
(This cuts downtime and lost profit!)
- **Built-in Non-skid Surface**
Only available on PCIV rear deck! (NOT stick-on strips)
- Proven reliability - Safety Engineered**



100% Foam Filled

Virtually Unsinkable. Even a punctured pontoon still floats level. Big safety factor - self draining.

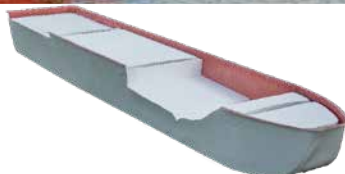

Canopy

This optional pedal boat accessory is perfect to protect riders from the hot sun. 25 Lbs.

Canopy White

Stainless Steel

Optional stainless steel hardware is available. Consider this option if boats will be used in salt water.

SS Stainless steel hardware



Boat Covers

Optional Marine grade boat covers are custom made to fit Kay Park Pedal Cruisers. Great to keep boats clean and prevent fading when not in use. 5 Lbs. Light Gray Color

PCIVCOVER 4 Passenger
PCIICOVER 2 Passenger



Easy Steering

Handy wheel location, steers in direction you turn wheel. New, more responsive rudder design.

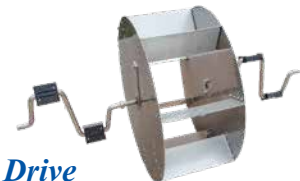

Direct Drive

The direct drive feature and four convenient grease fittings minimize downtime and maintenance cost. Disc paddle wheel made for easier pedaling, greater thrust.



Self Draining

Never have to drain these boats! Any water that gets in automatically drains back into the lake. No drain plugs needed.

Recycled Plastic Message Centers



Recycled Plastic Message Center

Our premium quality message centers are made from 100% recycled plastic. Our recycled plastic is maintenance free! It will never rot, rust, chip, splinter or peel. It is graffiti resistant and has UV inhibitors to prevent color fading. Our message centers are made with crystal clear, high-impact acrylic viewing glass that will not yellow. The glass is 100 times stronger than regular glass. We use zinc coated locks to secure the sliding doors. A high quality cork board display surface is included. Great for indoor or outdoor use! Message centers are offered in three sizes: Small = 20" x 3.5" x 26", Medium = 36" x 3.5" x 26", Large = 51" x 3.5" x 36". Medium and large sizes are offered as two different models: single sided or double sided. Each unit can be purchased as wall mount or with reinforced mounting posts. Now with thicker cork board. Available in green or cedar.

Sliding Doors

JPMCS1W	Sm msg ctr, 1 side, wall mnt.	40 Lbs
JPMCS1P	Sm msg ctr, 1 side w/post	70 Lbs
JPMCM1W	Med msg ctr, 1 side, wall mnt.	60 Lbs
JPMCM1P	Med msg ctr, 1 side w/posts	120 Lbs
JPMCM2P	Med msg ctr, 2 sides w/posts	150 Lbs
JPMCL1W	Lg msg ctr, 1 side, wall mnt.	90 Lbs
JPMCL1P	Lg msg ctr, 1 side w/posts	155 Lbs
JPMCL2P	Lg msg ctr, 2 sides w/posts	190 Lbs

Hinged Doors

JPHMCS1W	Sm msg ctr, 1 side wall mnt.	40 Lbs
JPHMCS1P	Sm msg ctr, 1 side w/posts	70 Lbs
JPHMCM1W	Med msg ctr, 1 side wall mnt.	60 Lbs
JPHMCM1P	Med msg ctr, 1 side w/posts	150 Lbs



Hinged Doors

*Top Quality Marine Grade Cork
and Specially
Coated Locking Mechanisms*



Zig-Zag Message Center

Recycled Plastic message center with six sides with three hinges and shatter resistant doors.

JPMCZZ 6 Sides, 4 Post Hinged 565 Lbs



100% Recycled Plastic

Recycled Colors:



Cedar Green

*Resin-wood Framework
With Shatter Resistance
Clear Plastic Sheet*

Car Stops

Recycled Plastic car stops won't be harmed by snow, sand, salt, or bad drivers. Let gravity hold them in place or pin them with spikes or rebar. Available in grey, blue or yellow.

PRCS6 4" X 6" X 72" 42 Lbs

Colors:





Thousands of products ONLINE!



Color Options

Wood

Our standard wood in 2" x 10" and 2" x 4" is No. 1 Southern Yellow Pine. It is treated with the MCA-Micronized Copper Azole. This pressure treatment process penetrates the woods cellular structure giving it long-lasting resistance to decay and termites. Clean, odorless, non-staining and non-irritating treatment is safe and better for the environment. NAHB Green approved. Other woods are available from time to time please inquire.

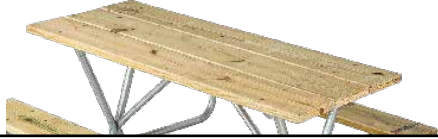

Aluminum Plank

0663-T6 clear anodized to 204-R1, 2" x 10" OR 2" x 4" on benches. Anodized aluminum end caps. Bolts and aluminum clips furnished.



Recycled Plastic

Post consumer waste plastic in 2" x 10", 2" x 4", or 2" x 3" sizes. Will be reinforced with steel ribs or supplied with three legs to prevent sag. Redwood color on windsor.



Cedar Redwood Brown Gray Green

Iron Valley: pg. 59

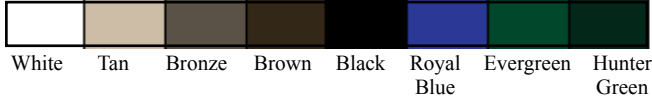

Fountain Colors: pg. 42 to 43

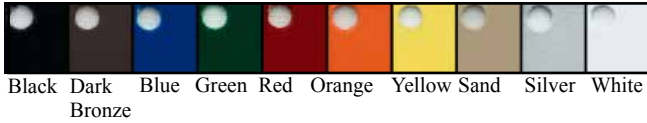

Fiberglass

Bright Ultragel colors in standard white, champagne, yellow, red, blue, stoplight blue, shamrock green, forest green or ask about **custom colors**. Built with reinforcing core type construction. A note about a 10% upcharge for granite or glitter on tables and benches.

Solid Color

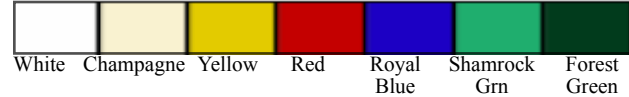

Granite-Look

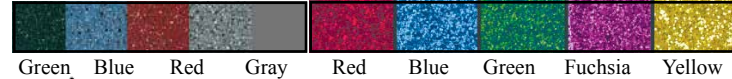

Glitter



WARNING: Cancer and Reproductive Harm www.P65Warnings.com

Vynlast Plastisol (PVC)

Heavy PVC coating on NO. 9 BY 3/4" expanded metal with 2" steel boarder. Plastisol is California compliant with reduced levels of pthalate. Available in assorted colors. Rectangle table tops are 30" wide and second seats are 10" wide, both have 2" vertical border. Standard lengths.

Quality Thick Vinyl Plastisol:

Additional Colors Available
Please Inquire



Black Brown Green Blue Gray



WARNING: Cancer and Reproductive Harm www.P65Warnings.com

Shade Covers: pg. 73

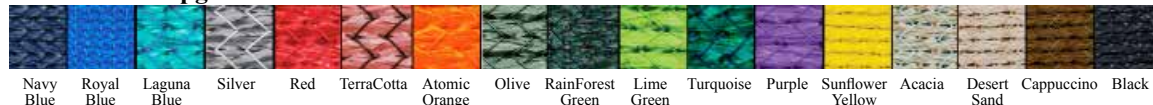

Navy Blue Royal Blue Laguna Blue Silver Red TerraCotta Atomic Orange Olive RainForest Green Lime Green Turquoise Purple Sunflower Yellow Acacia Desert Sand Cappuccino Black

Expanded Thermoplastic Colors:



Special Colors Available at
Additional Charge

Strap Steel: pg. 58



Powder Coating Colors:

White	Yellow	Red	Burgundy	Shamrock Green
ET-1391 White FDA - 09/10126	ET-3394 RAL 1016	ET-5394 RAL 3020	PLX3270-04 RAL 3003 S/G	PLXZ2817-04 RAL 6040
Forest Green ET-6494 RAL 6004	Royal Blue ET-73-40533 RAL 5002	Forest Service Brown ET-73-8691 RAL 8014	Black PLXZ158-80 RAL 9005	

Concrete Options:

Concrete colors and aggregate textures:



Garden Valance: pg. 19

Umbrella Garden Valance **UVFL7-TC** page 19.



Black Teal Beige Red Burgundy Yellow White Pacific Blue Forest Green Navy Blue

Compare Coatings



Vinyl Plastisol Coated Expanded Metal

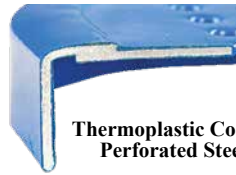

Thermoplastic Coated Perforated Steel



Thermoplastic Coated Economical Flattened Expanded Metal

Comfort	★★★★★	★★★★☆	★★★★☆
Thickness	130 mils	25-30 mils	25-30 mils
Vandal/ Graffiti Resistant	★★★★☆	★★★★★	★★★★★
Material	Vinylast Plastisol	Thermoplastic	Thermoplastic
Design	 Vinyl Plastisol Expanded Metal	 Thermoplastic Perforated Steel	 Thermoplastic Flattened Expanded Metal
Warranty	8 Year Limited Coating Warranty	5 Year Limited Coating Warranty	5 Year Limited Coating Warranty
Customer Comments	“Amazingly soft and durable! Same great “kid-friendly” coating used on the best playground equipment!”	“This glossy finish makes for easy clean up!”	“We could purchase more for our money!”



WARNING: Cancer and Reproductive Harm www.P65Warnings.com

Terms & Conditions:

Terms: Net 30 days from date of invoice to those with approved credit. A 1½% per month finance charge will be applied to payments not made within 60 days from invoice date. Current prices apply at time of shipment. We reserve the right to change specifications and prices without notice. Kay Park Recreation also accepts Visa, MasterCard, and Discover credit cards. Please note that on credit card orders, the credit card will be charged at the time of shipment.

Prices: All prices F.O.B. Factory and most products are shipped knocked down (they will require some assembly), unless quoted otherwise. While we make every effort to keep cost under control, at times market forces beyond our control can result in pricing changes. Therefore we must reserve the right to change pricing without notice.

Cancellations: Due to the possibility that expenses associated with an order may have already been incurred Kay Park Recreation must approve all cancellations of orders. Cancellation fees may apply.

Returns: Returns can be made only with the consent of Kay Park Recreation. Return fees and freight charges may apply.

Freight Charges: Are determined by the carrier. Kay Park Recreation can prepay and add to invoice. Most items are shipped knocked down to reduce freight costs. Typically some assembly may be required. Please see “Delivery” statement below.

Shipments: Made the way considered the most economical and practical unless specified routing instructions are given on the order, in which case we will do our best to follow routing guides. Shipments are also governed by ICC Regulations.

Delay in Transit: Kay Park Recreation is not responsible for delays in transit and such delays do not alter our invoicing terms. If your order does not reach you within a reasonable time after being advised the order has shipped, Kay Park Recreation will track the shipment immediately upon request.

Loss or Damage in Transit: Kay Park Recreation is released of all responsibility for loss or damage in transit by the bill of lading, which is our receipt from the carrier that the shipment was complete and in good condition. This bill of lading is forwarded to you at the time of shipment and should be checked carefully with the shipment when received by the consignee. Any shortage or damage must be noted and signed for by the delivering carrier.

Delivery: Items shipped by common carrier will be delivered curbside at the address specified on the order. The carrier is not responsible for unloading. Your location must be accessible to a large freight truck. Residential delivery, lift gate service, and call-ahead delivery are available at an additional charge and must be specified at the time of the order.

Specifications: Kay Park Recreation has a policy of continuous improvement and reserves the right to discontinue or change specifications without notice.

Weights: All weights are approximate.

Our Guarantee:

Kay Park guarantees all materials and workmanship (except labor and transportation) for one year, excluding vandalism, misuse, and acts of God. Claim for defects must be filed within one year, accompanied by copy of original invoice or invoice number.



Look for this symbol to indicate Quick Ship items. Quick Ship items will ship in 10 business days from receipt of order. For quantities above 4 call for lead-time.



2 Day Shipping

Look for this symbol to indicate 2 day shipping items. For quantities up to approximately 4 only. Inquire about larger quantities.

Customer ID

Promo ID



Please forward to the proper department if this catalog has reached you in error.



Easy Online Ordering
www.kaypark.com
Coupon Code: CAT22



Kay Park Recreation
1301 Pine Street Janesville, IA 50647
1-800-553-2476 ♦ 1-877 (KAY - PARK) ♦ 1-319-987-2900 (Fax)
529 - 7275