



7KP Auto

Operators Manual



Phone (207) 899-1714

Fax (207) 228-1890

www.infinitysolutionsmfg.com

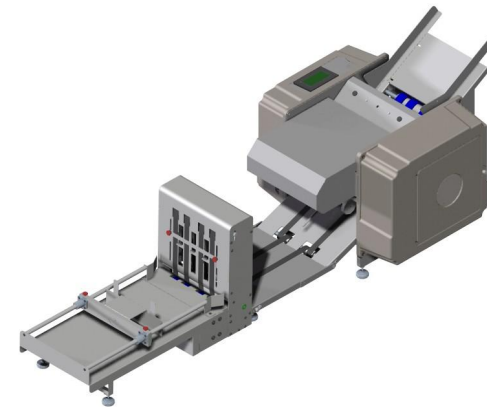

A Message to Our Customers

Thank you for purchasing the **7KPlus Auto**. This **Pressure Seal System** is the result of over 30 years of experience in the document processing industry. Through interfacing with customers like yourself and from hands-on experience in the field our **Research and Development Team** has focused on a solution that provides both the dependability you expect from today's technology while returning operational efficiency to your organization.

The result of our experience and research is a powerful tool to improve your bottom line. We hope that you enjoy the product. User comments and suggestions are always welcomed by our development team.

Operator Safety

Parlez-Vous Francias? Voir page 23

Hablas Espanol? Ver Página 24

- **Please review and follow all the safety precautions to ensure safe equipment operation.** The user is responsible for safe operating conditions. Read all operating instructions prior to operating machine.
- ▲ **Warning:** Do not attempt to handle the equipment alone. It requires two people to handle and lift the equipment out of the packaging.
- ▲ **Warning:** This unit contains moving parts. Watch for **Caution**, **Warning**, and **Electrical** stickers detailing proper operating conditions and user safety.
- **Never remove guards or product safety switches.** Removal of guards or switches will cause the unit to run improperly and can result in personal injury.
- **Keep all hands, fingers and objects away from moving parts.** Never attempt to reach into the machine while the power is on. Turn off the machine and disconnect the power cord before cleaning or servicing the machine, and before removing either fold plate. Injury may occur if proper operating procedure is not followed.
- **Plug the power cord into 115 VAC 60 Hz outlet only.** Voltage up to 120 volts will not damage the machine.
- The Power Cord and Plug must be accessible at all times for disconnection.
- This unit is equipped with a 3-Wire grounded electrical cord. If the cord becomes damaged and needs to be replaced, it must be replaced with an authorized part available through the manufacturer or an authorized service agent.
- All machine maintenance should be performed only by factory authorized service personnel using factory authorized replacement parts. Contact your reseller for more information.
- Keep product away from extreme heat & moisture.
- Never operate Machine while tired, drowsy, or under the influence of medication, drugs, or alcohol. Failure to do so can result in personal injury.
- Never operate unit with loose clothing or jewelry. Contain all long hair and neck ties prior to operating machine. Failure to do so could result in clothing, jewelry, or hair becoming entangled in moving parts.

Table of Contents

A Message to Our Customers	ii
Operator Safety	iii
Table of Contents	iv
Introduction	1
Capabilities.....	2
Setup	3
Step 1: Unpacking.....	3
Step 2: Machine Placement	3
Step 3: Fold Plates	4
Step 4: Power.....	4
Step 5: “Teaching” the Doubles Sensor.....	5
Step 6: Setting the Feed Gauge	6
Step 7: Feed Table Setup	7
Adjusting the Feed Table.....	7
Loading the Feed Table.....	8
Step 8: Identifying Your Fold.....	8
Step 9: Setting the Fold Plates	9
Step 10: Setting the Conveyor Nip Wheel	9
Machine Operation	12
Controls	12
Running the 7KP Auto.....	12
Operating in Manual Mode	12
Operating in Batch Mode.....	14
Maintenance	16
Roll Felt Wiper.....	16
Cleaning the Machine	17
Troubleshooting	18
Machine Will Not Power On	18
Machine Powers On But Will Not Run	18
Machine Stops Running	18
Paper Jams	19

Automatically Clearing a Jam	19
Manually Clearing a Paper Jam	19
Diagnosing the Paper Jam	20
Improper Functioning of the Machine	21
Misaligned Folds	21
Paper Feed Problems	21
Dirty forms	22
Motor Runs only in one direction	22
Excessive Noise	22
Poor Stacking on the Conveyor	22
Sûreté D'Opérateur.....	23
Seguridad Del Operador	24

Introduction

The **7KPlus Auto** is designed to fold and seal up to 12,000 documents per hour. Patented folding & sealing technologies ensure a good seal on every form and a clean fold every time. The adjustable fold plates allow the machine to meet your changing document processing requirements. Below are the detailed machine specs.

Speed	Variable Up to 12,000 Documents Per Hour	
Duty Cycle	200,000 Per Month	
Paper Sizes	Length up to 14", width up to 8.5"	
Counter	Selectable Manual or Batch	
Paper Weight	24Lbs to 90 Lbs	
Drive System	Variable Speed A.C.	
Feed System	Bottom Feed, Friction Belt	
Electrical	115V AC 60 Hz 10A	
Fold Patterns	11" Half (V) 11" Letter (C) 11" Eccentric C 11" Z 11" Eccentric Z	14" Half (V) 14" C 14" Return Envelope 14" Z 14" Eccentric Z (EZ)
Dimensions	Height 17", Length 48", Depth 22"	
Weight	120 Lbs.	

Table 1: 7KP Auto Specifications

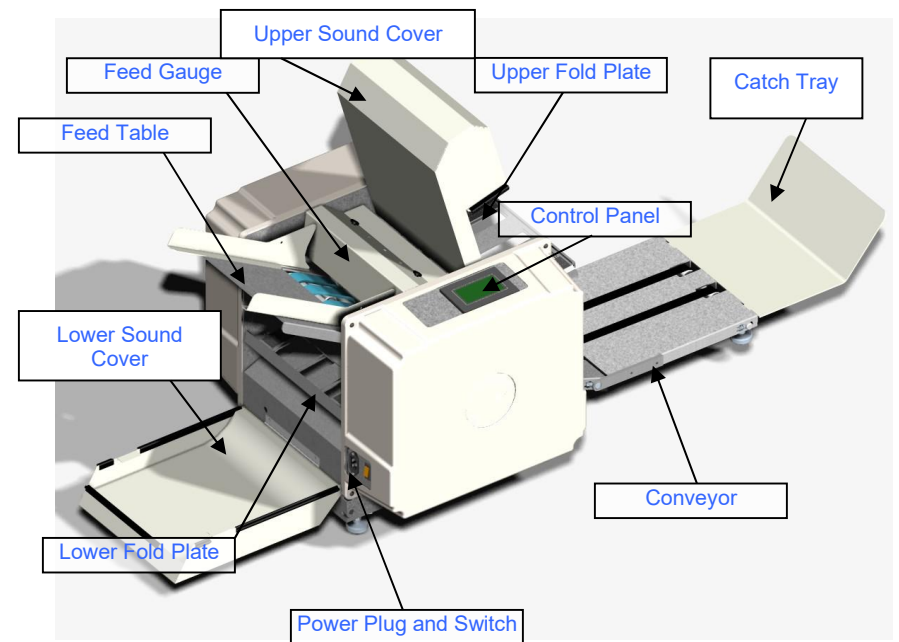

Capabilities

Your **7KPlus Auto** is designed from the ground up to be a versatile folding and sealing machine. Its capabilities include:

- Folding forms from 24lb paper to 90lb stock, contact your dealer for proper set up if running paper heavier than 60lbs
- Folding all standard fold patterns [See Table 2]
- Single fold capability
- Variable sheet size
- True doubles detection for reduced paper jamming
- Manual & Batch mode counter
- Extended conveyor for collecting high volumes of processed forms
- Touch screen controls for easy machine operation
- Jog reverse for automatically removing jammed paper
- Dynamic braking for jam prevention

Unpacking & Setup

Step 1: Unpacking

When opening the **7KPlus Auto** packaging, inspect it for any shipping damage. The shipper should be notified at once and the packing materials saved if there is any serious damage..

Ensure that the following items are present in the packaging:

1. Infinity Solutions® 7K Plus Auto (1)
2. AC Power Cord (1)
3. Upper Fold Plate (1)
4. Lower Fold Plate (1)
5. Catch Tray
6. Tool Kit
 - a. Breaker bar & $\frac{7}{16}$ " Socket
 - b. $\frac{3}{16}$ " T-Handle Hex Driver
 - c. Hesitation Weight

If any items are missing please contact your dealer.

Step 2: Machine Placement

Place the **7KPlus Auto** on the **Infinity Solutions® Cabinet** or equivalent sturdy cabinet or table. Contact your dealer to learn more about the **Infinity Solutions® Cabinet**.



Figure 1: Upper Fold Plate

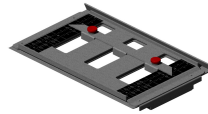

Figure 2: Lower Fold Plate

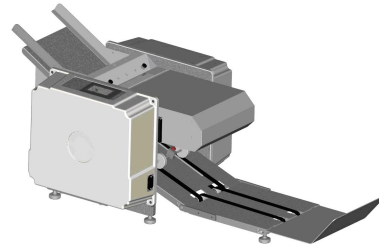

Figure 3: 7KP Auto

Seguridad Del Operador

- **Repase y siga por favor todas las medidas de seguridad para asegurar la operación segura del equipo.** El usuario es responsable de condiciones de funcionamiento seguras.
- ⚠ **Advertencia:** No procure manejar el equipo solamente. Él requiere a dos personas manejar y levantar el equipo del empaquetado.
- ⚠ **Advertencia:** esta unidad contiene piezas móviles de trabajo. Reloj para las etiquetas engomadas de la precaución, de la advertencia, del grado eléctrico para las condiciones de funcionamiento apropiadas y la seguridad del usuario (símbolos enumerados abajo)
- **Nunca quite los protectores o los interruptores de la seguridad del producto.** El retiro de protectores o del interruptor hará la unidad funcionar incorrectamente y podía dar lugar a daños corporales.
- **Tape el cable eléctrico en 115 VAC 60 hertzios de enchufe.** El voltaje hasta 120 voltios puede estar presente dentro de la unidad del sello de presión.
- **El cable eléctrico y el enchufe deben ser accesibles para la desconexión siempre.**
- **Sepa apagar la unidad del sello de presión en caso de que de la emergencia.**
- **Esta unidad se equipa de una cuerda eléctrica puesta a tierra 3 alambres.** Si se daña la cuerda de la fuente, debe ser substituida por una cuerda especial disponible del fabricante o de su agente del servicio.
- **Guarde todas las manos, dedos, y objetos ausentes de piezas móviles.** Nunca procure alcanzar en la máquina con la energía encendido. Dé vuelta a la energía apagado y desconecte el cable eléctrico antes de la limpieza o del mantenimiento del producto. Lesión puede ocurrir si las instrucciones apropiadas no se siguen.
- Todo el mantenimiento en piezas se debe realizar solamente cerca y técnico autorizado del servicio de Infinity Solutions usando solamente piezas de recambio aprobadas Infinity Solutions.
- Mantenga el producto ausente de calor extremo o de condiciones mojadas.
- Alarma de la estancia. Nunca funcione la unidad mientras que está cansado, soñoliento, o bajo influencia de la medicación, de drogas o del alcohol. La falta de seguir estas instrucciones podía causar daños corporales severos.
- Vestido apropiadamente. Nunca funcione la unidad con la ropa floja, joyería, y contenga el pelo largo. Los artículos flojos tales como ropa, joyería, y pelo largo podrían conseguir en las piezas móviles que causaban daños corporales.
- Advertencia: No funcione el sistema del sello de presión mientras que cualquiera cubre o las placas se quita del doblado. Si despejando un atasco de papel, siga por favor terminantemente las líneas de la guía en la sección de la investigación de averías del manual.

- **Passez en revue et veuillez suivre toutes les mesures de sécurité pour assurer l'opération sûre d'équipement.** L'utilisateur est responsable des conditions de fonctionnement sûres.
- ▲ **Avertissement:** N'essayez pas de manipuler seul l'équipement. Il exige de deux personnes de manipuler et soulever l'équipement hors de l'emballage.
- ▲ **Avertissement:** cette unité contient des pièces mobiles fonctionnantes. Montrez des autocollants d'attention, d'avertissement, d'estimation électrique pour des conditions de fonctionnement appropriées et la sûreté d'utilisateur (symboles énumérés ci-dessous)
- **N'enlevez jamais les gardes ou les commutateurs de sécurité du produit.** Le déplacement des gardes ou du commutateur fera fonctionner l'unité incorrectement et a pu avoir comme conséquence des blessures.
- **Branchez le cordon de secteur à des 115 VCA 60 hertz de sortie.** La tension jusqu'à 120 volts peut être présente dans l'unité de joint de pression.
- **Le cordon et la prise de secteur doivent être accessibles pour le débranchage à tout moment.**
- **Savez couper l'unité de joint de pression en cas d'urgence.**
- **Cette unité est équipée d'une corde électrique fondée 3 par fils.** Si la corde d'alimentation est endommagée, elle doit être remplacée par une corde spéciale fournie par le fabricant ou son agent de service.
- **Gardez tous les mains, doigts, et objets partis des pièces mobiles.** N'essayez jamais d'atteindre dans la machine avec la puissance dessus. Coupez le courant et débranchez le cordon de secteur avant le nettoyage ou l'entretien de produit. Les dommages peuvent se produire si des instructions appropriées ne sont pas suivies.
- Tout l'entretien sur des pièces devrait seulement être exécuté près et technicien autorisé de service de Infinity Solutions en utilisant seulement les pièces de rechange approuvées par Infinity Solutions.
- Maintenez le produit parti de la chaleur extrême ou des conditions humides.
- Alerte de séjour. N'actionnez jamais l'unité tandis que fatigué, assoupi, ou sous l'influence du médicament, des drogues ou de l'alcool. Le manque de suivre ces instructions a pu causer des blessures graves.
- Robe convenablement. N'actionnez jamais l'unité avec l'habillement lâche, bijoux, et contenez les longs cheveux. Les articles lâches tels que l'habillement, les bijoux, et les longs cheveux ont pu obtenir dans les pièces mobiles causant des blessures.
- Avertissement : N'actionnez pas le système de joint de pression tandis qu'en couvre ou des plats de pli sont enlevés. Si en dégageant un bourrage papier, suivez svp strictement les lignes de guide dans la section de dépannage du manuel.

Step 3: Fold Plates

Check to verify that both **fold plates** are properly installed [see Figure 4 & 5]. Both **fold plates** should rest snugly on the placement pins.

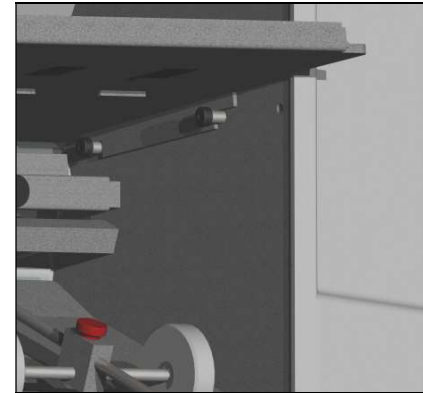

Figure 4: Upper Fold Plate in Proper Position

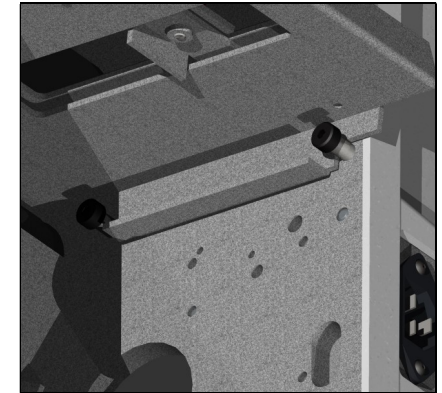

Figure 5: Lower Fold Plate in Proper Position

Step 4: Power

Insert the **power cord** into the machine first, and then into a standard 115V AC 60 Hz outlet. (Acceptable voltage range is 110 volts to 120 volts maximum)

Power the machine on with the power switch. The switch is lit "red" when on.

- ▲ The **power cord** must be accessible for disconnect.
- ▲ **Avertissement:** Le cordon et la prise de secteur doivent être accessibles pour le débranchage à tout moment. Si le cordon de secteur est les dommages sont doivent être remplacés d'approbation de fabricants pour assurer des estimations appropriées de tension.

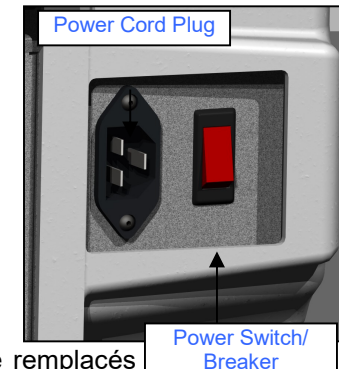



Figure 6: Power Switch

- ▲ **Advertencia:** El cable eléctrico y el enchufe deben ser accesibles para la desconexión siempre. Si es el cable eléctrico el daños es se deben substituir por la cuerda de la aprobación de los fabricantes para asegurar grados apropiados del voltaje.

Step 5: "Teaching" the Doubles Sensor



1. From the main screen, Press  on the touch screen.

2. Press  on the screen.



3. Press  to deactivate the doubles detection.

4. Manually feed your selected form into the machine.
- Place the form on the **feed table** and from under the **feed table** rotate the **feed belts** to feed the form into the machine until it has passed between the **doubles sensor**.
 - If your form has a window ensure that it is not oriented such that it is between the sensors. In the below image the location of the doubles sensor can be seen.



5. Touch the  button once.
- Manually feed a second form under the first sheet

Won't Feed

- Try reducing the size of the paper stack on the **feed table**.
 - Adjust the feed table **paper guides**. [See Setup: Step 7:]
- Try resetting the **feed gauge**. [See section: Step 6:]

Dirty forms

- Clean **rolls** with OOPS or an equivalent cleaning solvent.
 - Spray solvent onto a clean rag and wipe down rolls.
- Inspect felt wiper. [See the **maintenance** section]
 - Replace if dirty or flip over.

Motor Runs only in one direction

- Check the **rear fold plate** and ensure it is properly installed.
- Contact your service provider to correct the issue.

Excessive Noise

- ⚠ Disconnect the **power cord** from the machine
- Check for paper jam or foreign object in rolls.
 - If a paper jam is found see "Paper Jam" section.
 - Contact your service provider if the above steps do not correct the problem.

Poor Stacking on the Conveyor

- Adjust the **nip wheel**. [See Setup: Step 9:]
 - Note:** The **nip wheel** should be adjusted every time a new fold or form is used that yields a different **final** size.
- Check the **conveyor belts** for any damage. Contact your service provider if any damage is noted.
- Contact your service provider if the above steps do not correct the problem.

Improper Functioning of the Machine

Misaligned Folds

If your forms are running through the machine OK but they're folding a little bit crooked or are not folding right on the perforation, you need to tweak the fold plate settings. The location of perforations on forms generally fluctuates by about 1/16" in either direction. Forms manufacturers do this to avoid the forms sticking together. Because of this fluctuation, it is sometimes necessary to fine tune the placement of the paper stop on the fold plates.

The first step is to identify which fold plate is misaligned. Watch the form as it is fed into the machine, and then compare it to the finished form.

Once you've identified which **fold plate** needs to be adjusted, remove it from the machine. If the fold is crooked, check to make sure that the paper stop is parallel to the front edge of the fold plate. Check that the indicator points on the paper stop indicate the same reading on the two scales of the fold plate. Also check the feed table to make sure that **paper guides** are properly set.

If the fold is just a bit off of the perforation, adjust the paper stop by the amount that the fold is off. If the fold is happening early, then move the paper stop away from the open end of the fold plate. If the fold is happening late, then move the paper stop towards the open end of the fold plate.

Paper Feed Problems

Double Feeds

- If you're having problems feeding two forms at a time occasionally, readjust the **feed gauge** [See section: Step 6:]

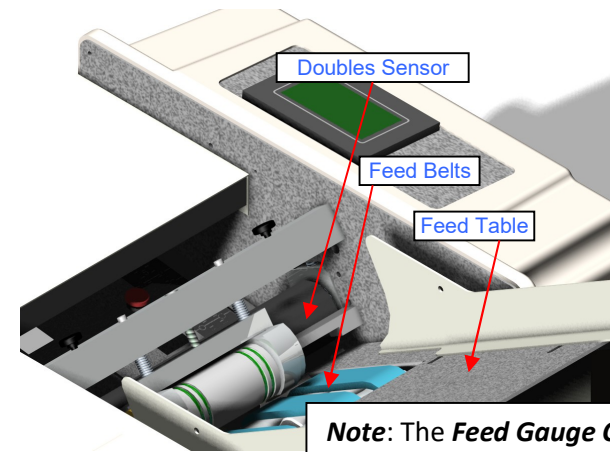
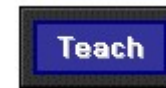



Figure 7



6. Touch the  button again.
7. Remove both forms.



8. Turn the doubles detection on.
9. Touch  button and exit the setup menu.
10. Test that "Teaching" the machine was successful
 - i. Feed a single piece of paper into the machine, no messages should be displayed. If a "Doubles Detection" message is displayed repeat the "Teaching" process.
 - ii. Feed two pieces of paper into the machine so that they cross under the sensor. An error message will be displayed, if the message is not displayed repeat the "Teaching" process.

Step 6: Setting the Feed Gauge

To properly set the **feed gauge system** [see Figure 8]:

- ⚠ Make sure that the **power switch** is in the **off** position.

1. Remove all paper from the feed table.
2. Insert the provided $\frac{3}{16}$ " **T-handle hex driver** into **feed gauge adjustment screw**.
3. Turn the T-Handle $\frac{1}{4}$ turn clockwise to loosen the **feed gauge wheel**.
4. Place 1 form on the **feed table** and hand feed the form about 2" into the machine by moving the **feed belt** with your hand.
5. Turn the T-Handle $\frac{1}{4}$ turn counter-clockwise.
6. Pull the paper out of the machine. You should feel resistance, but not too much. Repeat steps 4-6 until there is a moderate amount of resistance when pulling the form out. If it feels too tight, turn the T-Handle $\frac{1}{4}$ turn clockwise.

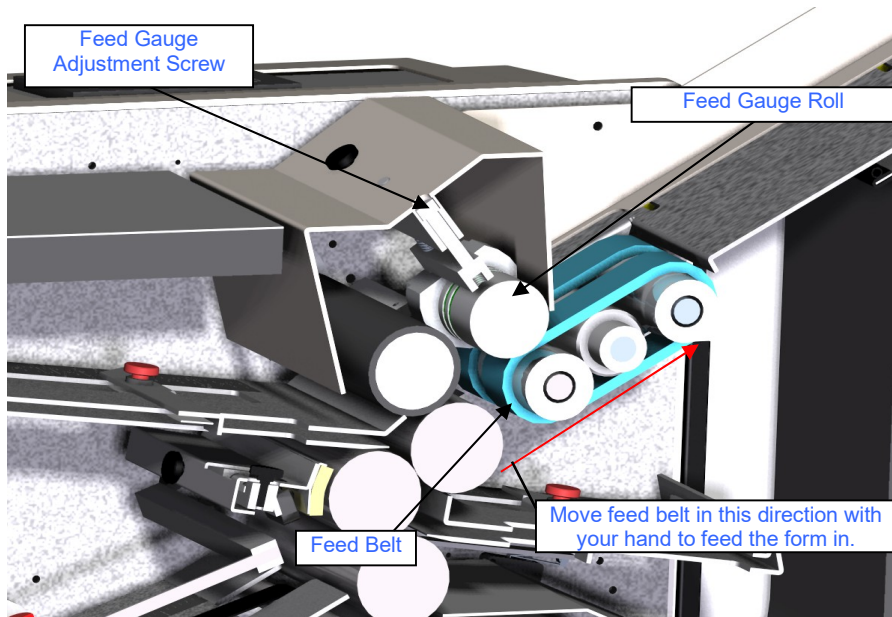
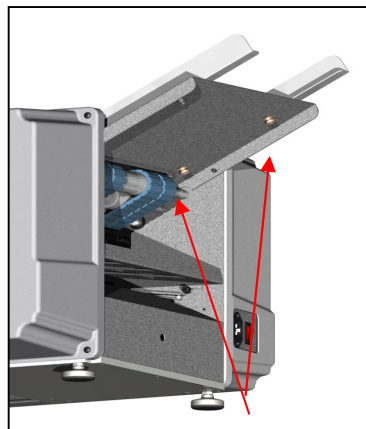

Figure 8: Feed Gauge Cross Section View

Step 7: Feed Table Setup

Adjusting the Feed Table

1. Loosen the brass **paper guide adjustment knobs**. Don't fully remove them. 1-2 turns clockwise will loosen them.
2. Place a $\frac{1}{2}$ " stack of the form to be run on the **feed table**.
3. Line the paper stack up against the stationary paper guide.



Adjustment Knobs 7

3. Remove the **access panel** in the **motor side cover**.
4. Place the breaker bar socket over the shaft with the hex end. [See Figure 13]
5. Rotate the breaker bar clockwise until the jammed form is out of the machine.
6. Replace the **lower fold plate**.
7. Replace the paper on the **feed table**.
8. Replace the **side cover access panel**.
9. Make sure that the **power switch** is in the **off** position.
10. Connect the **power cord** to the machine.

Diagnosing the Paper Jam

Problem	Double Feed	Buckled Form	Bad Fold
Symptom	Unfold the form that caused the jam, you will find that it is actually two forms folded together.	There will be an extra fold in form near the correct fold location.	The form which caused the jam will be folded crooked.
Causes	<ul style="list-style-type: none"> • Bad Feed Gauge Setting • Too much paper on the feed table 	<ul style="list-style-type: none"> • Wrong fold plate setting 	<ul style="list-style-type: none"> • Feed Table Paper Guide set improperly • Fold Plates set improperly • Feed is set too tight
Solution	<ul style="list-style-type: none"> • $\frac{1}{4}$ Turn CCW on feed gauge adjust screw to tighten the feed separator 	<ul style="list-style-type: none"> • Check both fold plates. Make sure they are set to the correct mark on the scale. 	<ul style="list-style-type: none"> • Check both fold plates. Make sure that both paper stops are square. • Turn feed adjust screw $\frac{1}{4}$ turn CW

Table 3: Paper Jam Diagnostics

Table 3 outlines the different problems which cause paper jams and the symptoms which will help you to identify the cause.

Paper Jams

Automatically Clearing a Jam

1. Remove all paper from the **feed table**.
2. If the **breaker power switch** has tripped (light is off) then flip it to the on (lighted) position.
3. Remove both **fold plates**.
4. From the Manual or Batch screen,



press

5. The Jog screen will appear.



6. Press
7. The machine will run forward for 1/2 second. This should cause the form to break free of the nip point in the machine. If it does not break free,



8. Press until it breaks free.



9. Once the form has broken free, press the until the form comes out of the machine.
10. After the form is removed, press esc to return to the previous screen.
11. Replace the **fold plates**.



4. Adjust the guide so there is approximately 1/16" inch gap between the guide and the paper
5. Make sure the guides are parallel and tighten the adjustment knobs.

Figure 9: Feed Table Diagram

Loading the Feed Table

- Place approximately 50-100 forms(1/2"-1") on the belts.
- As the machine starts to process forms, continue to add forms to the stack. Up to approximately 500 forms (3").
- The machine pulls the forms from the bottom of the stack. This allows the operator to continuously load forms while the machine is running!

Step 8: Identifying Your Fold

1. Identify your paper size. 11" forms are the standard letter size; 14" forms are the standard legal size. Measure the form if necessary.
2. Identify the fold shape from Table 1. Note that **Eccentric Z** (EZ) folds are a similar shape as the standard **Z** fold, but the lengths of the folds are not equal.

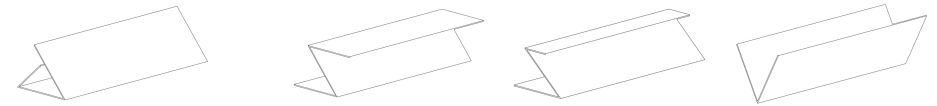

C Fold	Z Fold	EZ Fold	V Fold
--------	--------	---------	--------

Table 2: Fold Types

- Single fold capability: when the bottom fold plate is in the half fold position, the upper fold plate can be set to lengths other than the standard **V Fold** depending on your special needs.

Manually Clearing a Paper Jam

- ⚠ Disconnect the **power cord** from the machine

 1. Remove all paper from the **feed table**.
 2. Remove the **lower fold plate** from the machine.

Step 9: Setting the Fold Plates

The *Infinity Solutions 7KP Auto* is equipped with automatic *fold plates*.

To set up your fold plates, make sure that you are on the Manual Batch Setup screen.

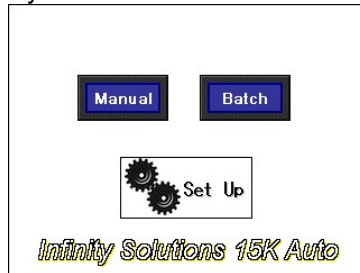

Press the button.

Next, press either the Metric or Inch fold plate button.

From this screen, you may select the appropriate fold pattern for your specific form by scrolling through the selections with the up and down arrow buttons.

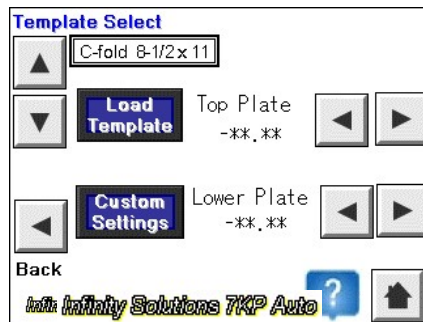

Once you have selected your fold pattern, press the Load Template button.

The fold plates will automatically move to the correct positions.

Once the fold plates are done moving, press the Home button.

Troubleshooting

Machine Will Not Power On

Check that the **power switch / breaker** is in the “on” position, when in the “on” position it will be lit up red.

- Double-check that the **power cord** is properly connected to the machine.
- Confirm the following components are not faulty in the following order
 - **Wall socket**, test by plugging in a known working item such as a lamp.
 - **Power cord**: testing continuity or switching it with a known working one.
 - **Power switch / breaker**: If the power switch will not light up, wait a few minutes and try again. If it will still not work contact your service provider.
- Contact your service provider if the above steps do not correct the problem.

Machine Powers On But Will Not Run

1. Check for a paper jam, See troubleshooting: Paper Jam.
2. Inspect for any foreign objects in the **rolls**.
3. Ensure the **drive train cover** is in place and the **safety switch** is engaged. [See Figure 13]
4. Check the **touch screen display**, if the display reads “Doubles Detection”, double check for a paper jam and if none found see Setup: Step 5:.
5. Contact your service provider if the above steps do not correct the problem.

Machine Stops Running

1. If the machine is still powered on see the above section.
2. If the machine powered off while running check the **power switch / breaker**.
3. If the machine repeatedly shuts off, wait a few minutes and try again. If the problem persists contact your service provider.

Cleaning the Machine

- ⚠ Disconnect the power cord from the machine.
- 1. Remove both fold plates.
- 2. Vacuum any paper dust or toner that has accumulated on the feed table and on the rollers.
- 3. Open the access panel in the side cover opposite the control panel.
- 4. Insert the 7/16" socket at the end of the breaker bar over the **hex end roll** [see Figure 13]. This bar can now be used to rotate the **rolls**.

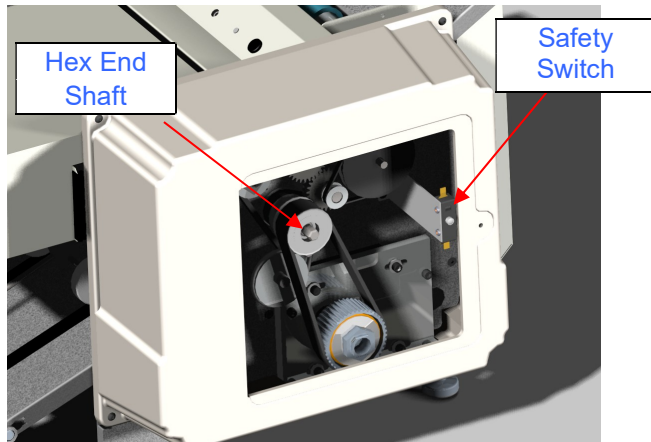

Figure 13: Access Door Open

- 5. Clean the **stainless steel rollers** with a household cleaner such as **Oops** in order to remove any accumulated toner. As you clean, use the breaker bar to rotate the rollers so that the entire roller surfaces are cleaned.
- 6. Clean the **rubber rollers** and the **feed belts** using a **rubber roll rejuvenator** [available at your local office supply store]. Use the breaker bar to rotate the **rolls** and **feed belt** as you clean so that all the rubber surfaces are cleaned.
- 7. Return the breaker bar to the toolkit and replace the access panel.
- 8. Replace the **fold plates**.
- 9. Make sure that the **power switch** is in the **off** position.
- 10. Connect the **power cord** to the machine.

If you wish to setup a custom form, press the Custom Settings button.



You have 5 customizable settings available for your specialized forms. Only Custom 1, Custom 2, AP, Payroll, and W-2 can be adjusted to match your particular forms.

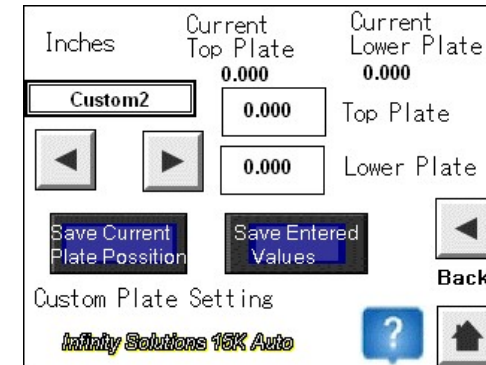

- To set the custom folds, press the square for the Top Plate.
- Enter the desired measurement for the first fold and press ENT.
- Press the square for the Lower Plate.
- Enter the desired measurement for the second fold and press ENT.
- Press Save Entered Values. The fold plates will move to the positions that you have given.

Step 10: Setting the Conveyor Nip Wheel

- ⚠ Make sure that the **power switch** is in the **off** position.

The placement of the **conveyor nip wheel** is important for the proper functioning of the conveyor [see Figure 10]. To set the location:

1. Take a folded form and place it so that one edge is just touching the steel roll.
2. Loosen the red **nip wheel adjustment knob**.
3. Move the **nip wheels** so that they just touch the front edge of the form.

4. Tighten the *nip wheel adjustment knob*.

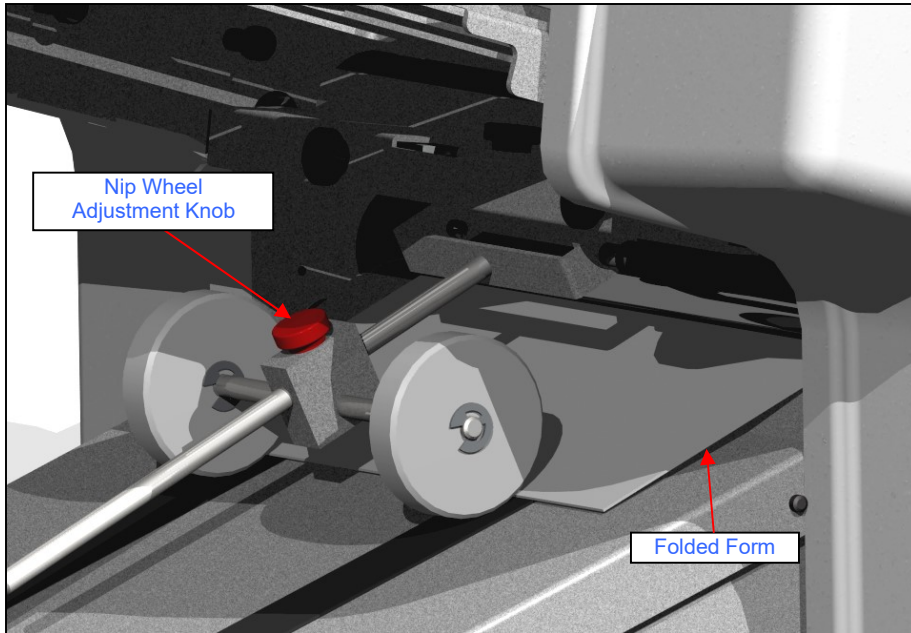

Figure 100: Nip Wheel Adjustment

Note: The scale on the conveyor table can also be used to adjust the nip wheel. To do so adjust the center of the nip wheel so that it matches up with the correct form size and fold type.

Maintenance

Regular maintenance on the **7KP Auto** will ensure that the machine continues to function properly and will extend the life of the machine. Perform the following steps every 100,000 forms or once a month:

Roll Felt Wiper

⚠ Disconnect the power cord from the machine.

1. Remove both fold plates

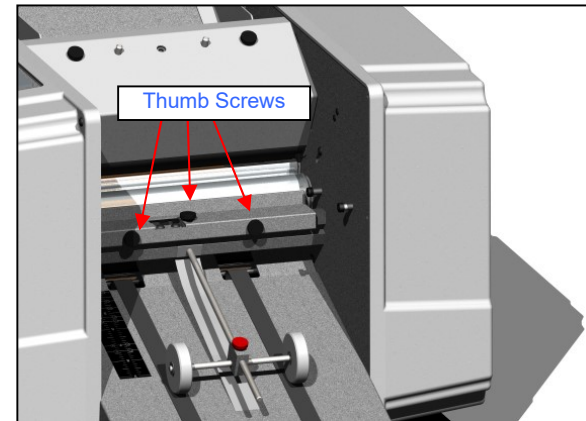
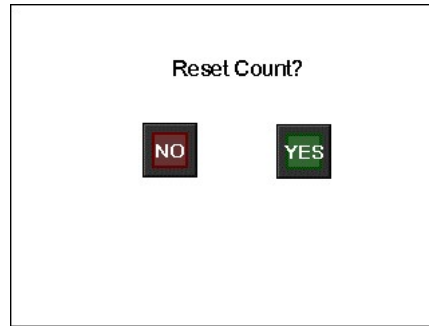

Figure 12: Roll Wiper Assembly

2. Remove the three thumb screws holding the **roll wiper assembly** and remove it from the machine [See Figure 14].
3. Inspect the felt wiper
 - a. Replace if dirty or flip over. For replacement parts contact your dealer
4. Installation is the reverse of removal
 - a. Adjust the pressure on the **roller** so the **felt** is only slightly touching. Check that the **holder** is parallel with the roller. **Note:** If the **felt** is pressing hard on the **roller** it can increase the load on the motor and reduce the performance of the machine. If the felt is not contacting the roller it will not properly clean the rollers and can result in marking up the forms with ink.

Clearing the Counter

- While in the Manual Mode screen, Press the Reset button.
- The machine will ask you to confirm that you want to reset the count.
- Press Yes to reset or No to cancel.



The counter will be reset to 0, and the screen will go back to the previous view.

Machine Operation

Controls

- ⚠ Familiarize yourself with all machine controls prior to operating the machine.

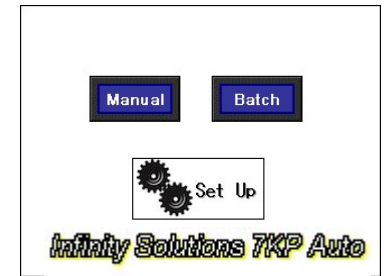

Figure 11: Main Menu

The **7KP Auto control panel** has a touch screen control and a speed adjustment knob. When the machine is turned on, the display looks like. **Manual** mode and **Batch** mode are for running the machine and **Setup** is for setting up the doubles detection, and resetting the counter.

Running the 7KP Auto

The **7KP Auto** can operate in two modes: **Manual** and **Batch**.

- **Manual Mode:** the machine runs forms until all forms in the feed tray have been processed or until stopped by the operator. A running count is kept on the screen.
- **Batch Mode:** the **Batch Total** is set and the machine runs forms until the **Batch Total** is reached, at which point the machine stops.
- **Speed Adjustment:** The speed can be adjusted by pressing the up or down buttons on the touch screen while in Manual or Batch mode.

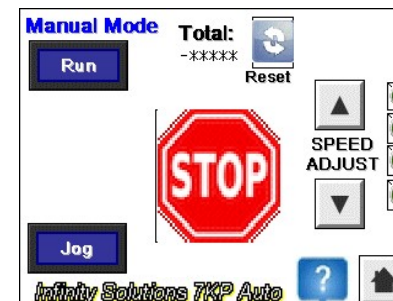

Operating in Manual Mode



- Press the **Manual** button in the *main menu* and the *manual control screen* will be displayed.

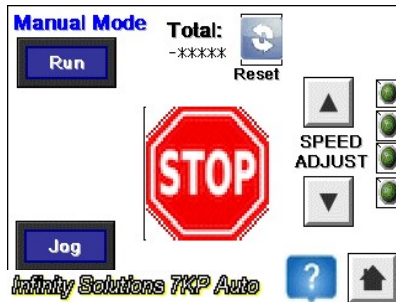

- The machine runs forms until all forms in the feed tray have been processed or until stopped by the operator. A running count is kept on the screen.



stops the machine.



- jogs the machine.
 - **Note:** This function is used when clearing a paper jam. See the Troubleshooting section for details and the correct procedure.



- exits from *manual mode* back into the *main menu*.

Operating in Batch Mode



- To enter Batch Mode, press the **Batch** button once, the below screen is displayed. Touch the “set Batch Preset box” to proceed.

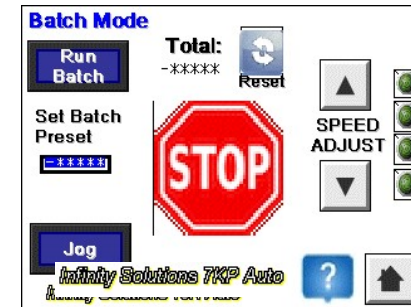

Figure 11: Batch Total

- Enter the desired number of forms to process and press ENT.

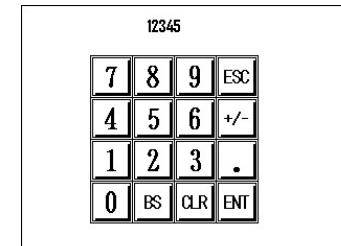

Figure 13: Batch Control control



- starts the machine and will run the specified number of forms.



- stops the machine.