

POLAR KRAFT

BUILDING THE TOUGHEST BOATS SINCE 1951

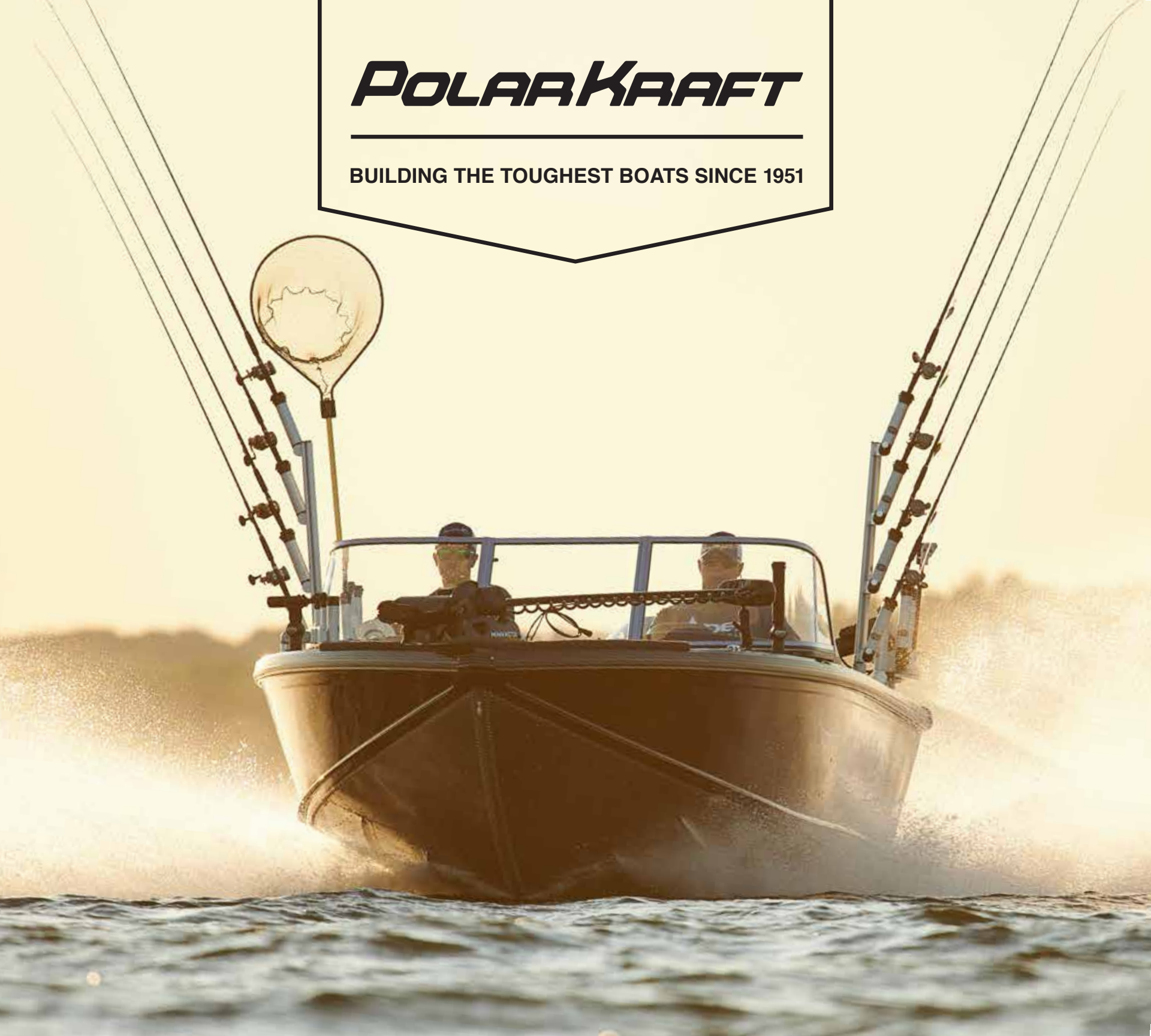

LIFETIME HULL WARRANTY

The choice is always yours with Polar Kraft, so whether you opt for riveted or welded models, we have your back—our hulls are backed by a lifetime warranty. Polar Kraft can make this promise because our large rivets and our hand-crafted welds are administered by aluminum craftsmen and women who have been building boats for decades.

These hulls don't back down from rough lakes or angry seas—they invite such conditions, so our lifetime warranty isn't just a promise, it's the way Polar Kraft ensures that you have a boat that is your lifelong friend to get you on the ducks, snook, bass or crappie without ever having to worry about carrying duct tape.

TABLE OF CONTENTS

FRONTIER.....	3
KODIAK.....	9
OUTLANDER.....	13
SPORTSMAN.....	21
SPORT X.....	27
BAY BOAT.....	31
BASS TX.....	35
VERSATILITY.....	38
WALL COLORS & FLOORING.....	40
WE BUILD RIVETED & WELDED BOATS.....	41
HULL CONSTRUCTION.....	43
TRAILERS.....	44
STRUCTURE.....	45
STANDARDS & OPTIONS.....	46
OUR PARTNERS.....	48



FRONTIER



For boaters and anglers that desire a dual console arrangement, coupled with a wide bodied, stable ride in a compact package—the best option in the industry is the Frontier by Polar Kraft. No other rigs of these lengths boast the beams of this rugged, wide-bodied fishing machine.

It was built to handle all types of water—small enough for your local “secret” 80-acre bass lake all the way to the big waters salmon like to call home. The longitudinal stringer system, tying the transom to the bow of the boat, gives you every confidence that the Frontier will keep you dry and safe, in nearly any situation (make sure you put the plug in).

From keeping fish alive at the tournament, to storing minnows for crappies, huge livewells are handy. Plus, large fore and aft casting decks and ample storage make the Frontier the perfect fishing partner.

POLAR KRAFT

FEATURES: FRONTIER



LIVEWELL AND OPTIONAL BAITWELL



HELM (WALKTHROUGH)



FLOOR ROD LOCKER IN 165 MODELS



CENTER ROD STORAGE IN 179 & 189 MODELS



HELM (SIDE CONSOLE)



TOP SHOT OF 165 SC



PORT SIDE STORAGE



HIDDEN BATTERY STORAGE UNDER CENTER ROD LOCKER

FEATURES: FRONTIER



STORAGE DRAWERS 165 MODEL



JUMP SEAT



BATTERY STORAGE UNDER JUMP SEATS



SIDE STORAGE COMPARTMENT



TOP SHOT 179 WT JUMP



CENTER ROD STORAGE

DIAGRAM KEY

LIVEWELL

ROD LOCKER

STORAGE

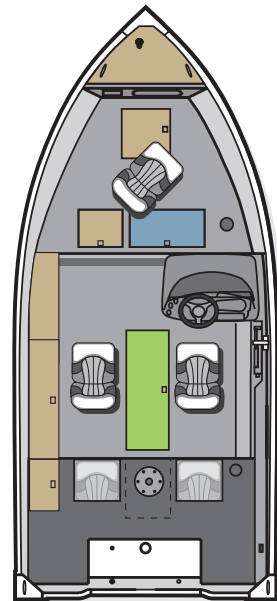

FRONTIER 165 SC SPECIFICATIONS

Overall Length	16' 7"
Beam	88"
Transom Height	20"
Bottom Width	64"
Interior Side Height	23"
Maximum HP	90 HP
Approx. Dry Weight	1025 lbs.
Approx. Package Length with Trailer & Motor	18' 7"
Fuel Capacity	Portable
Passengers	5 (US)
Rod Locker Length	8'
Livewell	19 gal.
Bait Well	NA
Front Dead Rise Angle	15 degrees
Rear Dead Rise Angle	11 degrees

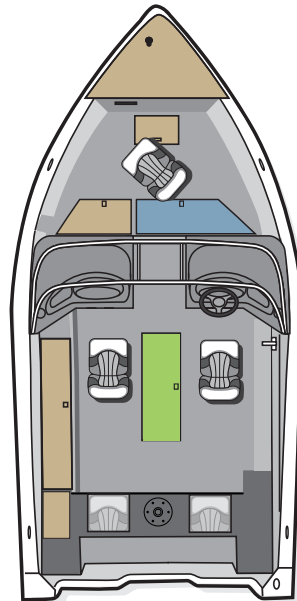

FRONTIER 165 WT SPECIFICATIONS

Overall Length	16' 7"
Beam	88"
Transom Height	20"
Bottom Width	64"
Interior Side Height	23"
Maximum HP	90 HP
Approx. Dry Weight	1025 lbs.
Approx. Package Length with Trailer & Motor	18' 7"
Fuel Capacity	Portable
Passengers	5 (US)
Rod Locker Length	8'
Livewell	19 gal.
Bait Well	NA
Front Dead Rise Angle	15 degrees
Rear Dead Rise Angle	11 degrees

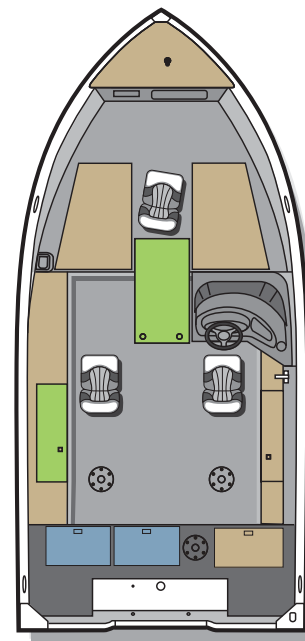

FRONTIER 179 SC SPECIFICATIONS

Overall Length	17' 11"
Beam	99"
Transom Height	20"
Bottom Width	82.5"
Interior Side Height	28"
Maximum HP	150 HP
Approx. Dry Weight	1135 lbs.
Approx. Package Length with Trailer & Motor	19' 11"
Fuel Capacity	23 gal.
Passengers	6 (US)
Rod Locker #1 Length	7'
Rod Locker #2 Length	7.5'
Livewell	32 gal.
Bait Well	Opt.
Front Dead Rise Angle	15 degrees
Rear Dead Rise Angle	11 degrees

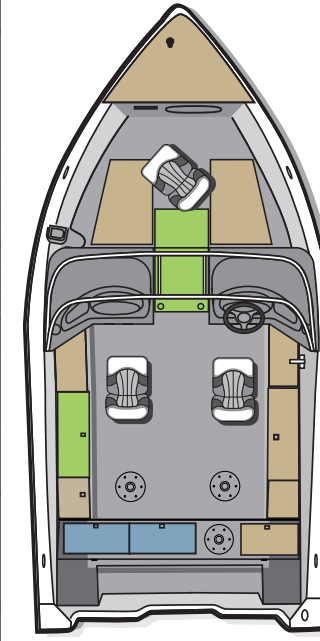

FRONTIER 179 WT SPECIFICATIONS

Overall Length	17' 11"
Beam	99"
Transom Height	20"
Bottom Width	82.5"
Interior Side Height	28"
Maximum HP	150 HP
Approx. Dry Weight	1240 lbs.
Approx. Package Length with Trailer & Motor	19' 11"
Fuel Capacity	23 gal.
Passengers	6 (US)
Rod Locker #1 Length	7'
Rod Locker #2 Length	7.5'
Livewell	32 gal.
Bait Well	Opt.
Front Dead Rise Angle	15 degrees
Rear Dead Rise Angle	11 degrees

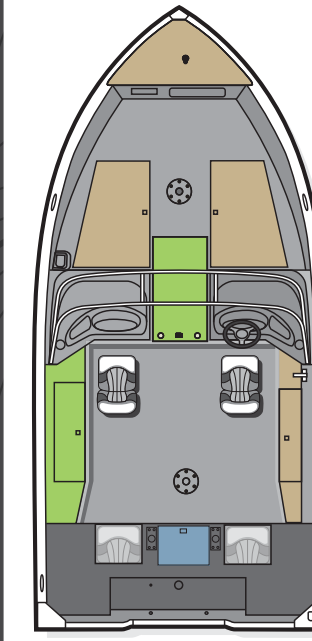

FRONTIER 179 WT JUMP SPECIFICATIONS

Overall Length	17' 11"
Beam	99"
Transom Height	20"
Bottom Width	82.5"
Interior Side Height	28"
Maximum HP	150 HP
Approx. Dry Weight	1240 lbs.
Approx. Package Length with Trailer & Motor	19' 11"
Fuel Capacity	23 gal.
Passengers	6 (US)
Rod Locker #1 Length	7'
Rod Locker #2 Length	7.5'
Livewell	19 gal.
Bait Well	Opt.
Front Dead Rise Angle	15 degrees
Rear Dead Rise Angle	11 degrees

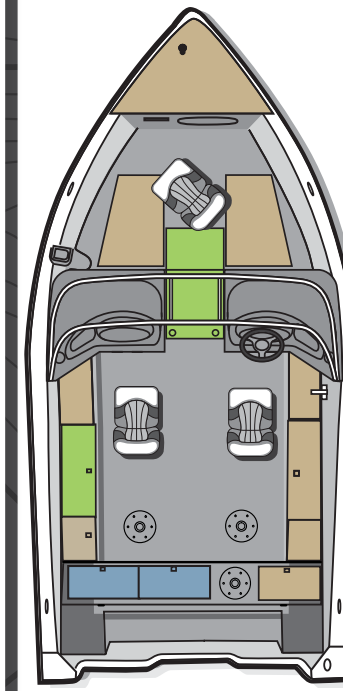

FRONTIER 189 WT SPECIFICATIONS

Overall Length	18' 11"
Beam	99"
Transom Height	25"
Bottom Width	82.5"
Interior Side Height	28"
Maximum HP	150 HP
Approx. Dry Weight	1480 lbs.
Approx. Package Length with Trailer & Motor	19' 11"
Fuel Capacity	23 gal.
Passengers	7 (US)
Rod Locker #1 Length	7'
Rod Locker #2 Length	7.5'
Livewell	32 gal.
Bait Well	Opt.
Front Dead Rise Angle	15 degrees
Rear Dead Rise Angle	11 degrees

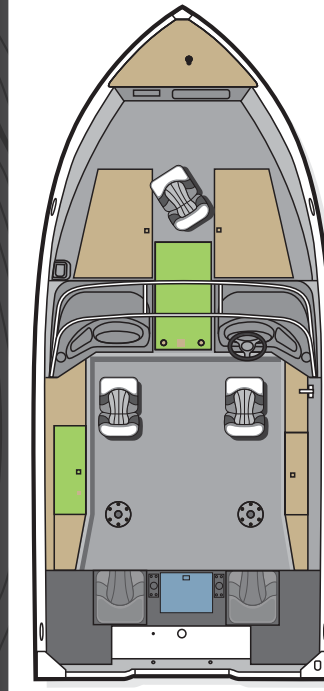

FRONTIER 189 WT JUMP SPECIFICATIONS

Overall Length	18' 11"
Beam	99"
Transom Height	25"
Bottom Width	82.5"
Interior Side Height	28"
Maximum HP	150 HP
Approx. Dry Weight	1480 lbs.
Approx. Package Length with Trailer & Motor	19' 11"
Fuel Capacity	23 gal.
Passengers	7 (US)
Rod Locker #1 Length	7'
Rod Locker #2 Length	7.5'
Livewell	19 gal.
Bait Well	Opt.
Front Dead Rise Angle	15 degrees
Rear Dead Rise Angle	11 degrees



KODIAK



The Kodiak from Polar Kraft is a serious fishing boat built for demanding anglers. Our engineers and builders designed the series to strict specifications for Deep-V Hull enthusiasts who don't mind hitting the lake when the wind blows 20+ miles per hour. Ask any weekend warrior or tournament competitor who has owned, or even just ridden in a Kodiak, and they will tell you it is the most solid Deep-V fishing boat on the market.

The Torque Control Design (TCD) is on full display and provides a rock solid, dry and stable ride built for big and small waters alike. Its maneuverability is unmatched, as is its ability to cut through the chop, thanks to its industry leading dead rise. Featuring increased storage, bigger livewells, and stout construction, the Kodiak is perfect for tackling even the roughest of waters, while going after fish that test your livewell capacity.

POLAR KRAFT

FEATURES: KODIAK



LIVEWELL



STARBOARD BOW STORAGE



CENTER ROD STORAGE



EXTRA WIDE GUNWHALE



STORAGE PORT SIDE



HIDDEN BATTERY STORAGE UNDER CENTER ROD LOCKER



FRONT CASTING DECK



SIDE STORAGE PORT SIDE

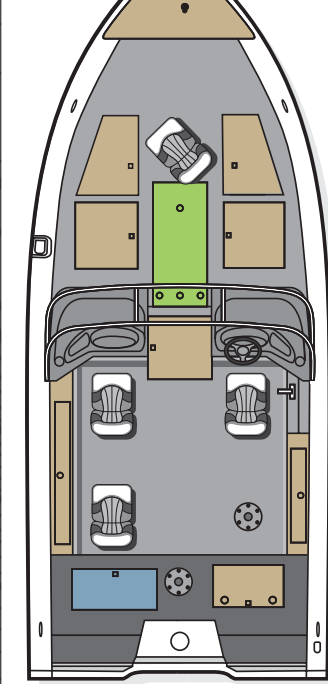
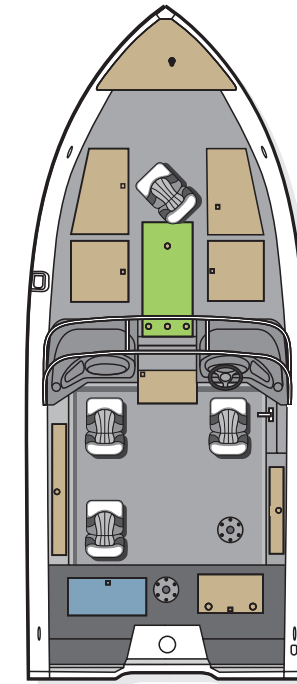
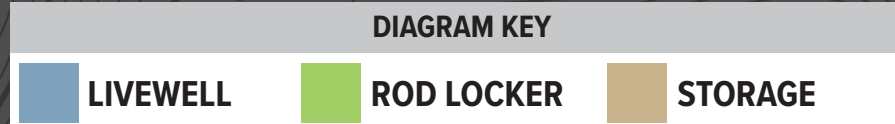

KODIAK 185 PRO SPECIFICATIONS

Overall Length	18' 10"
Beam	99"
Transom Height	25"
Bottom Width	84"
Interior Side Height	32"
Maximum HP	200 HP
Approx. Dry Weight	1580 lbs.
Approx. Package Length with Trailer & Motor	21' 10"
Fuel Capacity	56 gal.
Passengers	6 (US)
Rod Locker Length	8.5'
Livewell	32 gal.
Bait Well Size	Opt.
Front Dead Rise Angle	20 degrees
Rear Dead Rise Angle	20 degrees

KODIAK 200 PRO SPECIFICATIONS

Overall Length	19' 10"
Beam	99"
Transom Height	25"
Bottom Width	84"
Interior Side Height	32"
Maximum HP	225 HP
Approx. Dry Weight	1836 lbs.
Approx. Package Length with Trailer & Motor	22' 10"
Fuel Capacity	56 gal.
Passengers	6 (US)
Rod Locker Length	8.5'
Livewell	32 gal.
Bait Well	Opt.
Front Dead Rise Angle	20 degrees
Rear Dead Rise Angle	20 degrees



OUTLANDER



The Outlander series from Polar Kraft offers all the room you need to get out on the water, even during the nastiest of fronts—right when fish like to bite, or ducks like to fly. The Outlander's storage-friendly size won't take up excessive space or break your bank when it's time to move from one side of the garage to the other. The exclusive Torque Control Design (CTD) provides a smooth ride and also increases overall stability, sharpens maneuverability, and improves hole shot.

New for 2021, we've added a Catfish Edition that offers a 75-gallon livewell, optional washdown system, and plenty of other whisker-friendly features!

The above benefits make the Outlander a perfect family rig, but when you throw in a safe, dry, and comfy ride at any speed your horses max at, the Outlander is an easy choice regardless if you prefer mallards, muskies, or both.

POLAR KRAFT

FEATURES: OUTLANDER 2010 CATFISH



TRAXSTECH ROD ROCK (OPTIONAL)



FLOTATION PODS (OPTIONAL)



CATFISH 75 GAL LIVE WELL



WHEEL UPGRADE (OPTIONAL)



CATFISH HIGH PRESSURE WASH (OPTIONAL)



LARGE BOW STORAGE

FEATURES: OUTLANDER 186 CC



BAITWELL



LIVWELL



LOCKABLE ROD LOCKER



HELM (CENTER CONSOLE)

FEATURES: OUTLANDER 186 SC



HELM



TOP SHOT



IN-FLOOR STORAGE



LIVEWELL



LOCKABLE ROD LOCKER



PORTSIDE STORAGE

FEATURES: OUTLANDER 186 T



TOP SHOT (186 T)



LIVEWELL AND BUILT-IN BAITWELL (186 T)

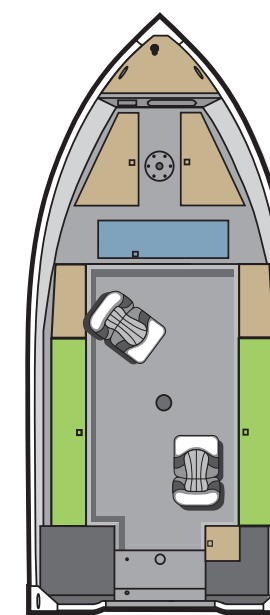

OUTLANDER 146 T SPECIFICATIONS

Overall Length	14'
Beam	70"
Transom Height	20"
Bottom Width	49.75"
Interior Side Height	28"
Maximum HP	25 HP
Approx. Dry Weight	670 lbs.
Approx. Package Length with Trailer & Motor	16'
Fuel Capacity	Portable
Passengers	4 (US)
Rod Locker	5.5'
Livewell Size	25 gal.
Bait Well Size	NA
Front Dead Rise Angle	5.5 degrees
Rear Dead Rise Angle	5.5 degrees

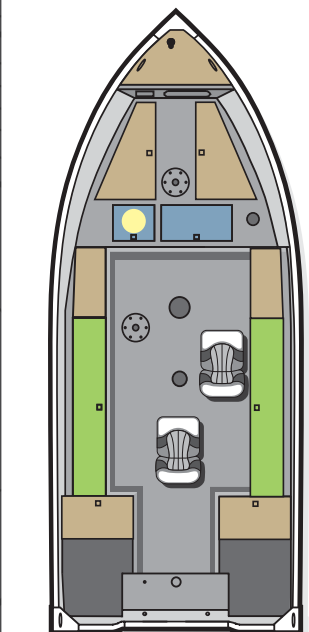

OUTLANDER 156 T SPECIFICATIONS

Overall Length	15' 6"
Beam	81"
Transom Height	20"
Bottom Width	61.5"
Interior Side Height	21"
Maximum HP	50 HP
Approx. Dry Weight	776 lbs.
Approx. Package Length with Trailer & Motor	17' 6"
Fuel Capacity	Portable
Passengers	4 (US)
Rod Locker Length	7'
Livewell Size	25 gal.
Bait Well Size	built-in
Front Dead Rise Angle	15 degrees
Rear Dead Rise Angle	11 degrees

DIAGRAM KEY

LIVEWELL
 ROD LOCKER
 STORAGE

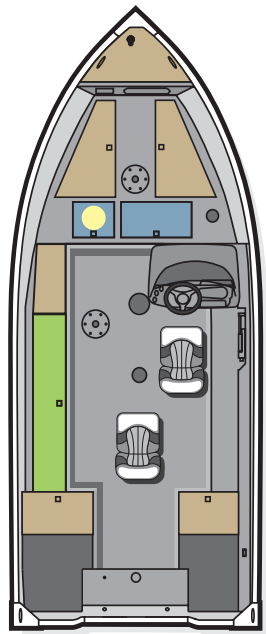

OUTLANDER 156 SC SPECIFICATIONS

Overall Length	15' 6"
Beam	81"
Transom Height	20"
Bottom Width	61.5"
Interior Side Height	21"
Maximum HP	50 HP
Approx. Dry Weight	776 lbs.
Approx. Package Length with Trailer & Motor	17' 6"
Fuel Capacity	Portable
Passengers	4 (US)
Rod Locker	7'
Livewell Size	25 gal.
Bait Well Size	built-in
Front Dead Rise Angle	15 degrees
Rear Dead Rise Angle	11 degrees

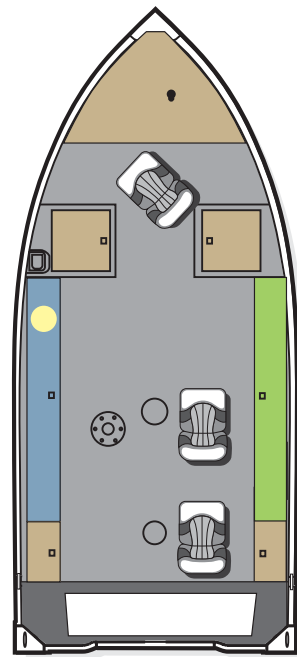

OUTLANDER 165 T SPECIFICATIONS

Overall Length	16' 7"
Beam	88"
Transom Height	20"
Bottom Width	64"
Interior Side Height	23"
Maximum HP	70 HP
Approx. Dry Weight	876 lbs.
Approx. Package Length with Trailer & Motor	18' 7"
Fuel Capacity	16 gal.
Passengers	4 (US)
Rod Locker Length	7'
Livewell Size	25 gal.
Bait Well Size	Built-In.
Front Dead Rise Angle	15 degrees
Rear Dead Rise Angle	11 degrees

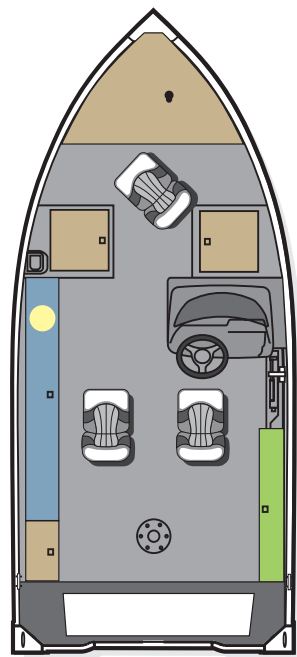

OUTLANDER 165 SC SPECIFICATIONS

Overall Length	16' 7"
Beam	88"
Transom Height	20"
Bottom Width	64"
Interior Side Height	23"
Maximum HP	90 HP
Approx. Dry Weight	876 lbs.
Approx. Package Length with Trailer & Motor	18' 7"
Fuel Capacity	16 gal.
Passengers	4 (US)
Rod Locker Length	7'
Livewell Size	25 gal.
Bait Well Size	Built-In.
Front Dead Rise Angle	15 degrees
Rear Dead Rise Angle	11 degrees

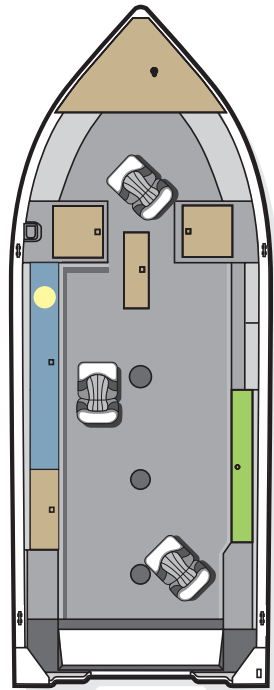

OUTLANDER 186 T SPECIFICATIONS

Overall Length	18' 6"
Beam	92"
Transom Height	20"
Bottom Width	72"
Interior Side Height	27"
Maximum HP	90 HP
Approx. Dry Weight	1124 lbs.
Approx. Package Length with Trailer & Motor	20' 6"
Fuel Capacity	23 gal.
Passengers	7 (US)
Rod Locker Length	9'
Livewell Size	25 gal.
Bait Well Size	Built-In.
Front Dead Rise Angle	15 degrees
Rear Dead Rise Angle	11 degrees

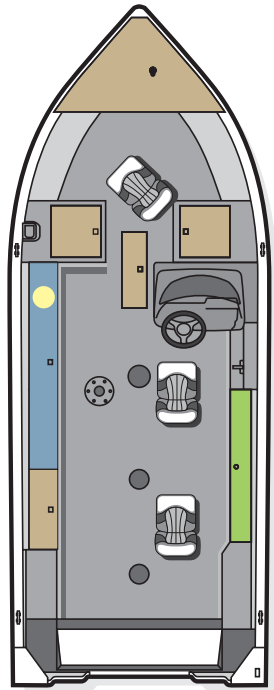

OUTLANDER 186 SC SPECIFICATIONS

Overall Length	18' 6"
Beam	92"
Transom Height	20"
Bottom Width	72"
Interior Side Height	27"
Maximum HP	150 HP
Approx. Dry Weight	1124 lbs.
Approx. Package Length with Trailer & Motor	20' 6"
Fuel Capacity	23 gal.
Passengers	7 (US)
Rod Locker Length	9'
Livewell Size	25 gal.
Bait Well Size	Built-In.
Front Dead Rise Angle	15 degrees
Rear Dead Rise Angle	11 degrees

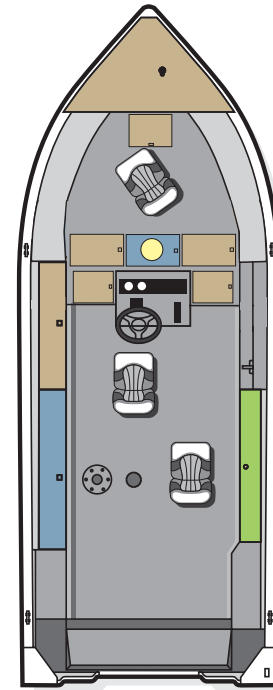

OUTLANDER 186 CC SPECIFICATIONS

Overall Length	18' 6"
Beam	92"
Transom Height	20"
Bottom Width	72"
Interior Side Height	27"
Maximum HP	150 HP
Approx. Dry Weight	1124 lbs.
Approx. Package Length with Trailer & Motor	20' 6"
Fuel Capacity	23 gal.
Passengers	7 (US)
Rod Locker Length	9'
Livewell Size	25 gal.
Bait Well Size	Built-In.
Front Dead Rise Angle	15 degrees
Rear Dead Rise Angle	11 degrees

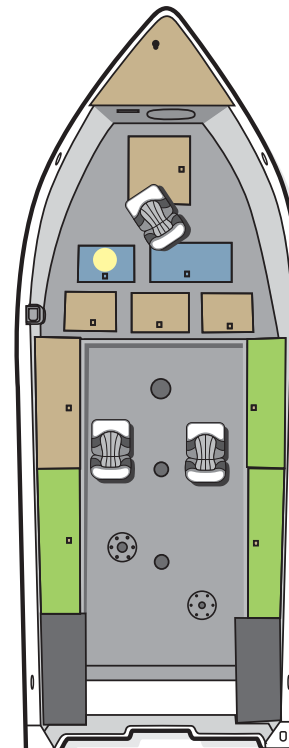

OUTLANDER 2010 T SPECIFICATIONS

Overall Length	20' 11"
Beam	96"
Transom Height	25"
Bottom Width	76"
Interior Side Height	23.5"
Maximum HP	150 HP
Approx. Dry Weight	1274 lbs.
Approx. Package Length with Trailer & Motor	23'
Fuel Capacity	23 gal.
Passengers	6 (US)
Rod Locker Length	7.5'
Livewell Size	35 gal.
Bait Well Size	9 gal.
Front Dead Rise Angle	15 degrees
Rear Dead Rise Angle	11 degrees

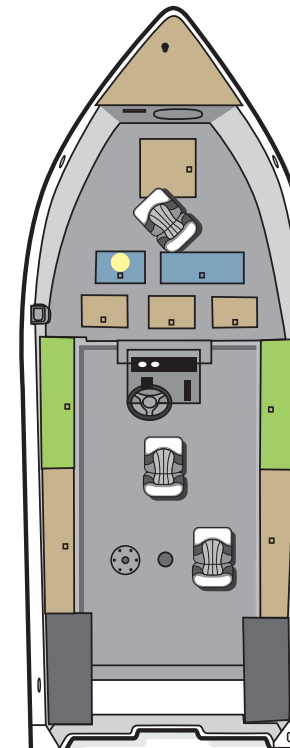

OUTLANDER 2010 CC SPECIFICATIONS

Overall Length	20' 11"
Beam	96"
Transom Height	25"
Bottom Width	76"
Interior Side Height	23.5"
Maximum HP	200 HP
Approx. Dry Weight	1374 lbs.
Approx. Package Length with Trailer & Motor	23'
Fuel Capacity	23 gal.
Passengers (US/CAN)	6/6
Rod Locker Length(ft/m)	8'
Live Well Size (gal/ L)	35/132
Bait Well Size (gal/ L)	9/34
Front Dead Rise Angle	15 degrees
Rear Dead Rise Angle	11 degrees

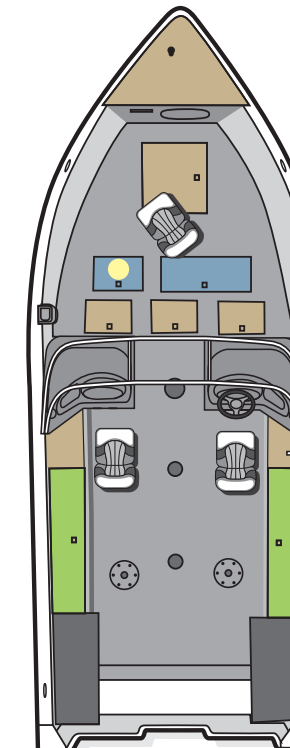

OUTLANDER 2010 WT SPECIFICATIONS

Overall Length	20' 11"
Beam	96"
Transom Height	25"
Bottom Width	76"
Interior Side Height	23.5"
Maximum HP	200 HP
Approx. Dry Weight	1440 lbs.
Approx. Package Length with Trailer & Motor	23'
Fuel Capacity	23 gal.
Passengers	6 (US)
Rod Locker Length	7.5'
Livewell Size	35 gal.
Bait Well Size	9 gal.
Front Dead Rise Angle	15 degrees
Rear Dead Rise Angle	11 degrees

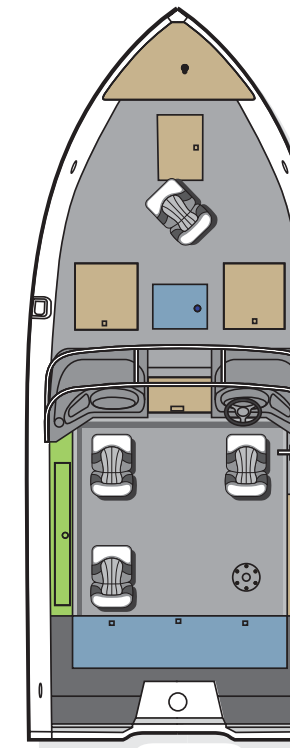

OUTLANDER 2010 CATFISH SPECIFICATIONS

Overall Length	20' 11"
Beam	96"
Transom Height	25"
Bottom Width	76"
Interior Side Height	23.5"
Maximum HP	200 HP
Approx. Dry Weight	1440 lbs.
Approx. Package Length with Trailer & Motor	23'
Fuel Capacity	23 gal.
Passengers	6 (US)
Rod Locker Length	7.5'
Livewell Size	35 gal.
Bait Well Size	9 gal.
Front Dead Rise Angle	15 degrees
Rear Dead Rise Angle	11 degrees



SPORTSMAN



For anglers and hunters who prefer an all-welded fishing and hunting boat—the Sportsman will meet and beat all your needs regardless if you're slipping down a river for ducks or flipping some downed timber on your local flowage.

These rugged, hand-crafted hulls are thoughtfully built and affordable, yet reliable in both fresh and salty water. Both center console and side console models are available, so there's a layout available if you need extra space for your Labrador retriever or your favorite jigging rod.

POLARKRAFT

FEATURES: SPORTSMAN



SPORTSMAN TILLER



HELM (SIDE CONSOLE)



LIVWELL WITH BUILT-IN BAIT BUCKET



ROD LOCKER AND LIGHT STORAGE



BOW STORAGE

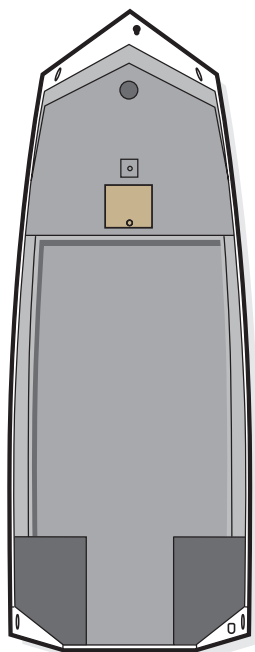

SPORTSMAN 1654 T SPECIFICATIONS

Overall Length	16' 2"
Beam	80"
Transom Height	20"
Bottom Width	54"
Interior Side Height	23"
Maximum HP	40 HP
Approx. Dry Weight	772 lbs.
Approx. Package Length with Trailer & Motor	18'
Fuel Capacity	Portable
Passengers	4 (US)
Rod Locker Length	NA
Livewell Size	NA
Bait Well Size	NA
Front Dead Rise Angle	3 degrees
Rear Dead Rise Angle	6 degrees

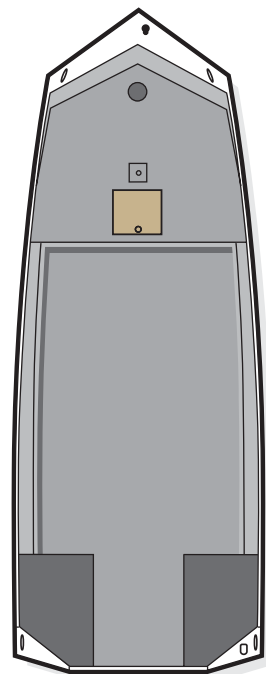

SPORTSMAN 1754 T SPECIFICATIONS

Overall Length	17'
Beam	80"
Transom Height	20"
Bottom Width	54"
Interior Side Height	23"
Maximum HP	60 HP
Approx. Dry Weight	774 lbs.
Approx. Package Length with Trailer & Motor	19'
Fuel Capacity	Portable
Passengers	4 (US)
Rod Locker Length	NA
Livewell Size	NA
Bait Well Size	NA
Front Dead Rise Angle	3 degrees
Rear Dead Rise Angle	6 degrees

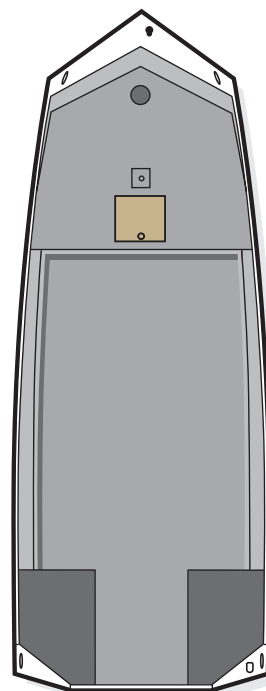

SPORTSMAN 1860 T SPECIFICATIONS

Overall Length	18' 1"
Beam	86"
Transom Height	20"
Bottom Width	60"
Interior Side Height	23"
Maximum HP	60 HP
Approx. Dry Weight	965 lbs.
Approx. Package Length with Trailer & Motor	20'
Fuel Capacity	Portable
Passengers	5 (US)
Rod Locker Length	NA
Livewell Size	NA
Bait Well Size	NA
Front Dead Rise Angle	6 degrees
Rear Dead Rise Angle	6 degrees

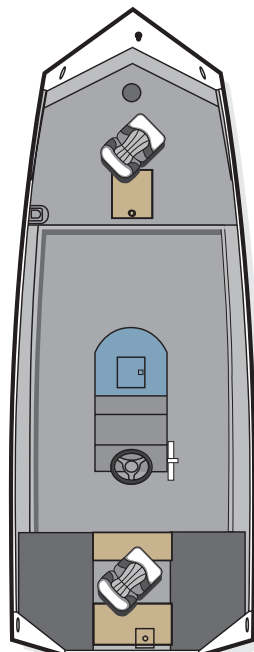

SPORTSMAN 1654 CC SPECIFICATIONS

Overall Length	16' 2"
Beam	80"
Transom Height	20"
Bottom Width	54"
Interior Side Height	23"
Maximum HP	60 HP
Approx. Dry Weight	772 lbs.
Approx. Package Length with Trailer & Motor	18'
Fuel Capacity	Portable
Passengers	4 (US)
Livewell Size	18 gal.
Bait Well Size	NA
Front Dead Rise Angle	3 degrees
Rear Dead Rise Angle	6 degrees

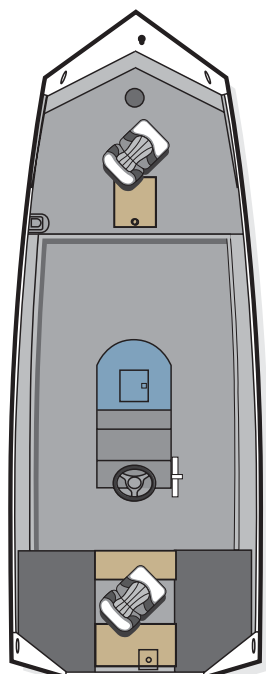

SPORTSMAN 1754 CC SPECIFICATIONS

Overall Length	17'
Beam	80"
Transom Height	20"
Bottom Width	54"
Interior Side Height	23"
Maximum HP	90 HP
Approx. Dry Weight	774 lbs.
Approx. Package Length with Trailer & Motor	19'
Fuel Capacity	Portable
Passengers	4 (US)
Livewell Size	18/68
Front Dead Rise Angle	3 degrees
Rear Dead Rise Angle	6 degrees

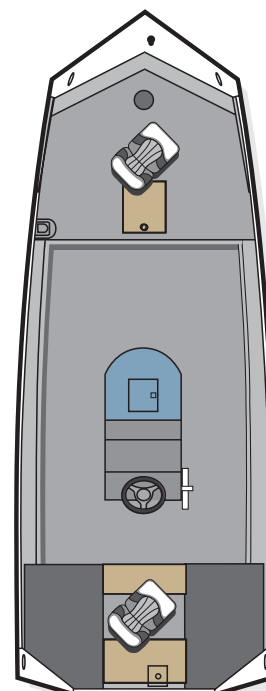

SPORTSMAN 1860 CC SPECIFICATIONS

Overall Length	18' 1"
Beam	86"
Transom Height	20"
Bottom Width	60"
Interior Side Height	23"
Maximum HP	90 HP
Approx. Dry Weight	911 lbs.
Approx. Package Length with Trailer & Motor	20'
Fuel Capacity	Portable
Passengers	5 (US)
Livewell Size	18 gal.
Front Dead Rise Angle	6 degrees
Rear Dead Rise Angle	6 degrees

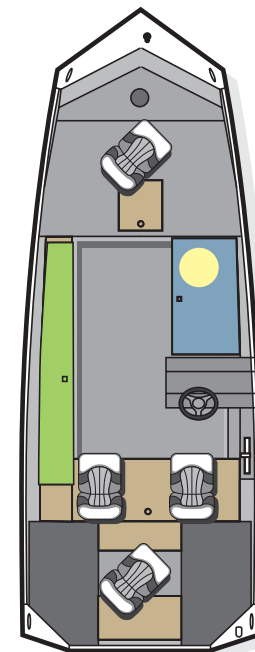

SPORTSMAN 1654 SC SPECIFICATIONS

Overall Length	16' 2"
Beam	80"
Transom Height	20"
Bottom Width	54"
Interior Side Height	23"
Maximum HP	60 HP
Approx. Dry Weight	772 lbs.
Approx. Package Length with Trailer & Motor	18'
Fuel Capacity	Portable
Passengers	4 (US)
Rod Locker Length	10'
Livewell Size	18 gal.
Bait Well Size	built-in
Front Dead Rise Angle	3 degrees
Rear Dead Rise Angle	6 degrees

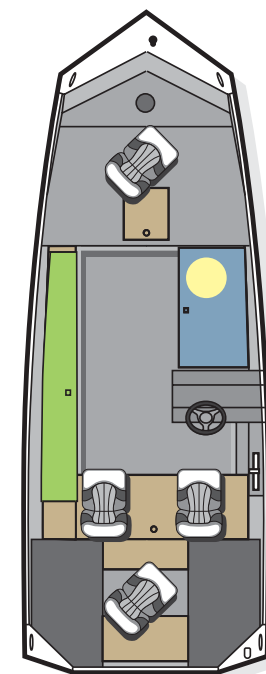

SPORTSMAN 1754 SC SPECIFICATIONS

Overall Length	17'
Beam	80"
Transom Height	20"
Bottom Width	54"
Interior Side Height	23"
Maximum HP	90 HP
Approx. Dry Weight	774 lbs.
Approx. Package Length with Trailer & Motor	19'
Fuel Capacity	Portable
Passengers	4 (US)
Rod Locker	10'
Livewell Size	18 gal.
Bait Well Size	built-in
Front Dead Rise Angle	3 degrees
Rear Dead Rise Angle	6 degrees

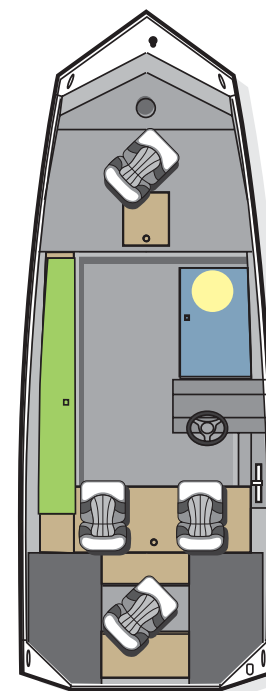

SPORTSMAN 1860 SC SPECIFICATIONS

Overall Length	18' 1"
Beam	86"
Transom Height	20"
Bottom Width	60"
Interior Side Height	23"
Maximum HP	90 HP
Approx. Dry Weight	965 lbs.
Approx. Package Length with Trailer & Motor	20'
Fuel Capacity	Portable
Passengers	5 (US)
Rod Locker Length	10'
Additional Rod Locker	7'
Livewell Size	18 gal.
Front Dead Rise Angle	6 degrees
Rear Dead Rise Angle	6 degrees

DIAGRAM KEY

LIVEWELL

ROD LOCKER

STORAGE



SPORT X



If a person is an angler, a duck hunter, or even carp shooter, the Sport X delivers features that don't compromise. It starts with an all-welded hull built by people who care and know what they are doing. The .125-gauge marine-grade aluminum alloy takes on rocks, stumps, and other debris with no apology—it handles these obstacles that send lesser boats back to the ramp.

Make it your own with custom layouts and paint schemes that are all about YOUR lifestyle whether you desire mallards, bass, or anything else that calls the water their home.

POLAR KRAFT

FEATURES: SPORT X



ENCLOSED ROD STORAGE (SIDE CONSOLE MODELS)



BUILT-IN BAITWELL (SIDE CONSOLE MODELS)



LIVEWELL (210 MODELS)

DIAGRAM KEY

- LIVEWELL
- ROD LOCKER
- STORAGE

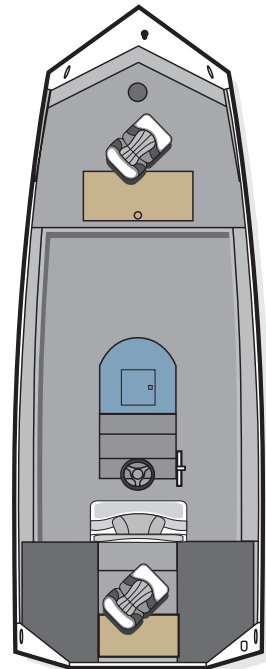

SPORT X 175 CC SPECIFICATIONS

Overall Length	17' 6"
Beam	86"
Transom Height	20"
Bottom Width	60"
Interior Side Height	20"
Maximum HP	90 HP
Approx. Dry Weight	878 lbs.
Approx. Package Length with Trailer & Motor	19'
Fuel Capacity	23 gal.
Passengers	4 (US)
Rod Locker Length	NA
Additional Rod Locker	NA
Livewell Size	18 gal.
Bait Well Size	NA
Front Dead Rise Angle	15 degrees
Rear Dead Rise Angle	11 degrees

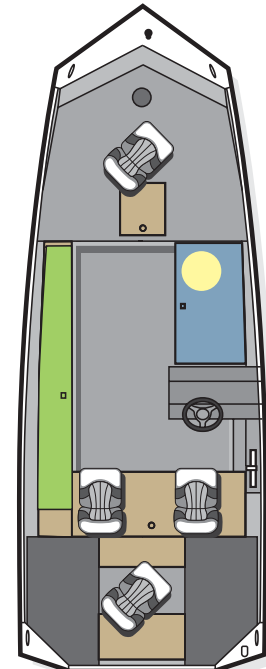

SPORT X 175 SC SPECIFICATIONS

Overall Length	17' 6"
Beam	86"
Transom Height	20"
Bottom Width	60"
Interior Side Height	20"
Maximum HP	90 HP
Approx. Dry Weight	878 lbs.
Approx. Package Length with Trailer & Motor	19'
Fuel Capacity	23 gal.
Passengers	4 (US)
Rod Locker Length	10'
Additional Rod Locker	7'
Livewell Size	18 gal.
Bait Well Size	built-in
Front Dead Rise Angle	15 degrees
Rear Dead Rise Angle	11 degrees

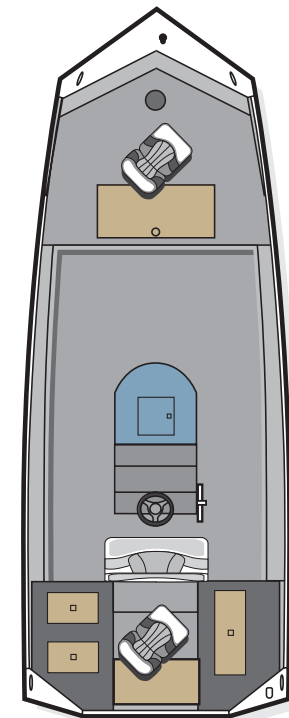

SPORT X 190 CC SPECIFICATIONS

Overall Length	18' 8"
Beam	97"
Transom Height	20"
Bottom Width	69"
Interior Side Height	21"
Maximum HP	115 HP
Approx. Dry Weight	965 lbs
Approx. Package Length with Trailer & Motor	20'
Fuel Capacity	23 gal.
Passengers	5 (US)
Rod Locker Length	NA
Additional Rod Locker	NA
Livewell Size	18 gal.
Bait Well Size	NA
Front Dead Rise Angle	15 degrees
Rear Dead Rise Angle	11 degrees

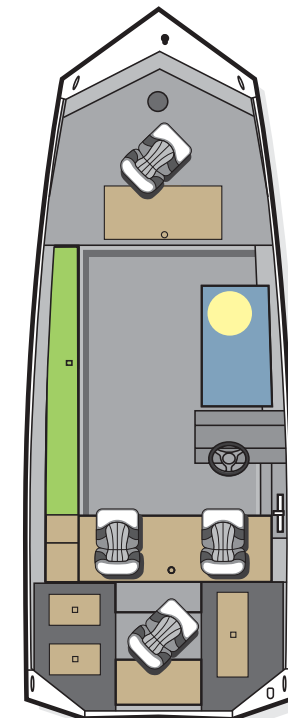

SPORT X 190 SC SPECIFICATIONS

Overall Length	18' 8"
Beam	97"
Transom Height	20"
Bottom Width	69"
Interior Side Height	21"
Maximum HP	115 HP
Approx. Dry Weight	965 lbs.
Approx. Package Length with Trailer & Motor	20'
Fuel Capacity	23 gal.
Passengers	5 (US)
Rod Locker Length	7'
Livewell Size	18 gal.
Bait Well Size	built-in
Front Dead Rise Angle	15 degrees
Rear Dead Rise Angle	11 degrees

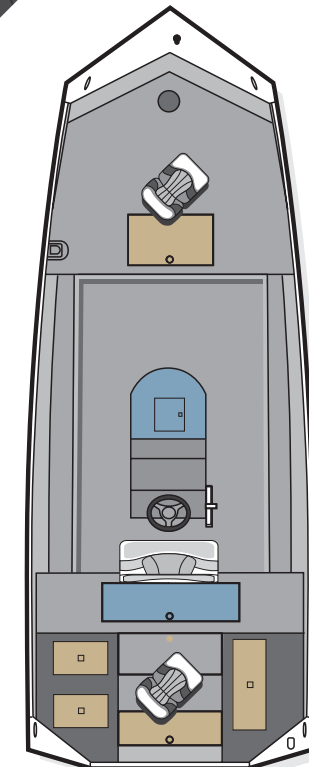

SPORT X 210 CC SPECIFICATIONS

Overall Length	20' 4"
Beam	97"
Transom Height	20"
Bottom Width	72"
Interior Side Height	21"
Maximum HP	150 HP
Approx. Dry Weight	1492 lbs.
Approx. Package Length with Trailer & Motor	22'
Fuel Capacity	23 gal.
Passengers	6 (US)
Rod Locker Length	NA
Livewell #1	75 gal.
Livewell #2	18 gal.
Front Dead Rise Angle	15 degrees
Rear Dead Rise Angle	11 degrees

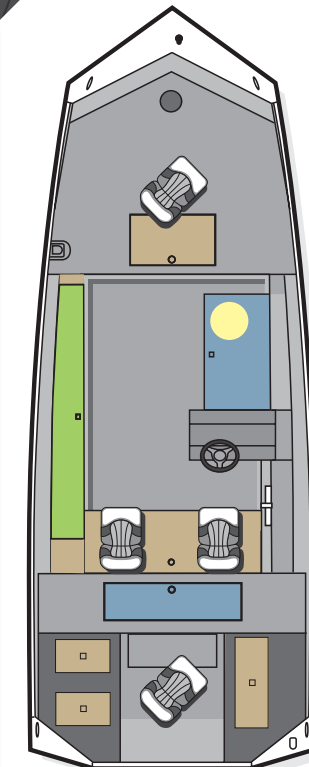

SPORT X 210 SC SPECIFICATIONS

Overall Length	20' 4"
Beam	97"
Transom Height	20"
Bottom Width	72"
Interior Side Height	21"
Maximum HP	150 HP
Approx. Dry Weight	1492 lbs.
Approx. Package Length with Trailer & Motor	22'
Fuel Capacity	23 gal.
Passengers	6 (US)
Rod Locker Length	10'
Livewell #1	75 gal.
Livewell #2	18 gal.
Bait Well Size	built-in
Front Dead Rise Angle	15 degrees
Rear Dead Rise Angle	11 degrees



BAY BOAT



If you are fan of center consoles for inter-coastal waterways, rivers, or skinny lakes, then the Bay Boat series is as sexy as it is functional. Hand-crafted hulls with the toughest marine-grade aluminum alloys mean that durability is there coupled with a ride that won't test out your rain gear.

Snook, reds, bass, or even northern pike on a Mississippi slough will have no place to hide regardless if it's low tide or a flooded stump field. Just go get after it and know that your Bay Boat series, while built for salty water, can be your best friend in freshwater too.

POLAR KRAFT

FEATURES: BAY BOAT

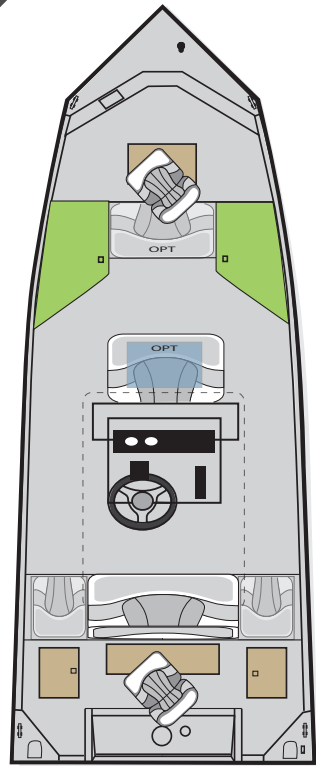
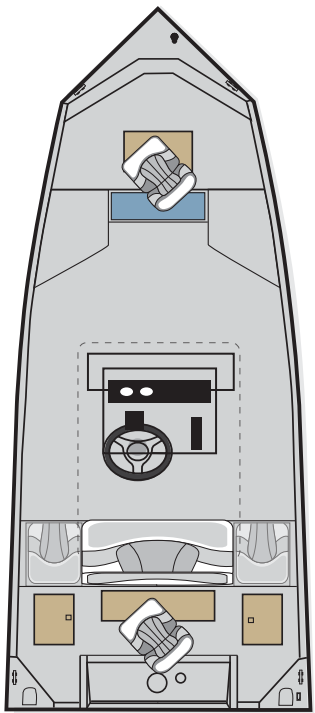

BAY 190 SPECIFICATIONS

Overall Length	18' 8"
Beam	96"
Transom Height	20"
Bottom Width	69"
Interior Side Height	21"
Maximum HP	115 HP
Approx. Dry Weight	911 lbs.
Approx. Package Length with Trailer & Motor	20'
Fuel Capacity	23 gal.
Passengers	5 (US)
Rod Locker Length	NA
Additional Rod Locker	NA
Livewell	18 gal.
Bait Well	NA.
Front Dead Rise Angle	15 degrees
Rear Dead Rise Angle	11 degrees

BAY 210 SPECIFICATIONS

Overall Length	20' 4"
Beam	96"
Transom Height	20"
Bottom Width	69"
Interior Side Height	21"
Maximum HP	200 HP
Approx. Dry Weight	1492 lbs.
Approx. Package Length with Trailer & Motor	22'
Fuel Capacity	23 gal.
Passengers	6 (US)
Rod Locker Length	8.5'
Additional Rod Locker	8.5'
Livewell (optional)	18 gal.
Front Dead Rise Angle	15 degrees
Rear Dead Rise Angle	11 degrees



JUMP SEAT WITH HIDDEN STORAGE



LEANING POST



OPTIONAL LIVEWELL



PORT SIDE ROD STORAGE



TACKLE STORAGE DRAWER UNDER LEANING POST



BOW STORAGE

DIAGRAM KEY

■ LIVEWELL

■ ROD LOCKER

■ STORAGE



BASS TX



More and more anglers are skipping the high cost of glass boats (that cost a fortune to repair if you kiss a stump) and turning towards aluminum rigs. The Bass TX series is a mod-V that has abundant storage, needs less horse power to get on plane, and is cosmetically HOT in a variety of custom colors.

These new generation of boats offer a longer and wider footprint than nearly any boat in their class so they're stable when flipping a dock or working over your favorite crappie hole. As with any Polar Kraft, the hulls are hand-laid with marine-grade aluminum alloys that provide confidence that if you're in a bass tournament or family trip you'll get where you need to be, dry, safe, and in comfort without the hefty price tag of glass.

POLAR KRAFT

FEATURES: BASS TX



CENTER ROD STORAGE



LIVEWELL



OPEN ROD TIE DOWN



SIDE STORAGE

DIAGRAM KEY

■ LIVEWELL

■ ROD LOCKER

■ STORAGE

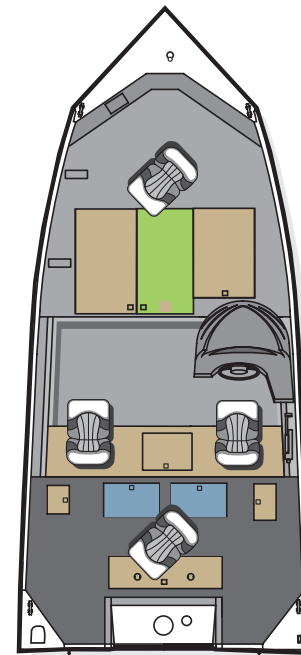

BASS TX 165 SPECIFICATIONS

Overall Length	16' 6"
Beam	84"
Transom Height	20"
Bottom Width	60"
Interior Side Height	20"
Maximum HP	60 HP
Approx. Dry Weight	980 lbs.
Approx. Package Length with Trailer & Motor	18' 6"
Fuel Capacity	11 gal.
Passengers	4 (US)
Rod Locker Length	7.5'
Livewell Size	25 gal.
Bait Well Size	NA
Front Dead Rise Angle	15 degrees
Rear Dead Rise Angle	11 degrees

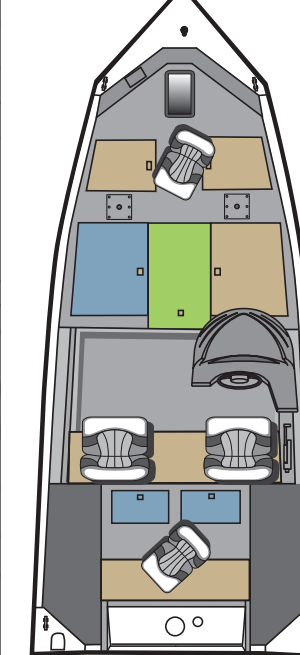

BASS TX 175 C SPECIFICATIONS

Overall Length	17' 6"
Beam	92"
Transom Height	20"
Bottom Width	60"
Interior Side Height	20"
Maximum HP	90 HP
Approx. Dry Weight	1046 lbs.
Approx. Package Length with Trailer & Motor	19' 5"
Fuel Capacity	23 gal.
Passengers	4 (US)
Rod Locker Length	8'
Livewell #1 Size	18 gal.
Livewell #2 Size	25 gal.
Bait Well Size	NA
Front Dead Rise Angle	15 degrees
Rear Dead Rise Angle	11 degrees

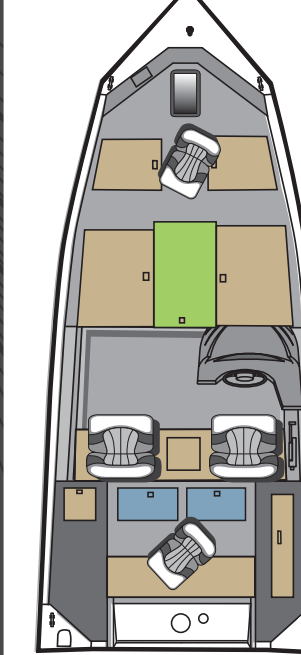

BASS TX 175 PRO SPECIFICATIONS

Overall Length	17' 6"
Beam	92"
Transom Height	20"
Bottom Width	60"
Interior Side Height	20"
Maximum HP	90 HP
Approx. Dry Weight	1046 lbs.
Approx. Package Length with Trailer & Motor	19' 5"
Fuel Capacity	23 gal.
Passengers	4 (US)
Rod Locker Length	8'
Livewell Size	25 gal.
Bait Well Size	NA
Front Dead Rise Angle	15 degrees
Rear Dead Rise Angle	11 degrees

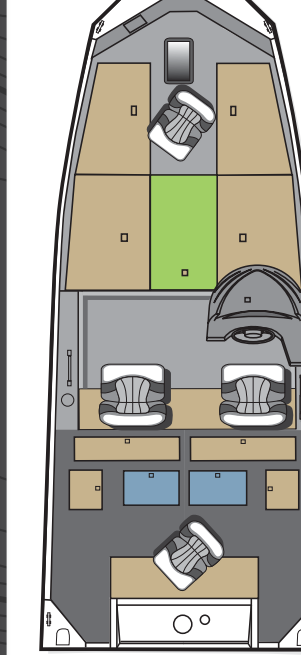

BASS TX 195 PRO SPECIFICATIONS

Overall Length	19' 6"
Beam	97"
Transom Height	20"
Bottom Width	69.25"
Interior Side Height	21"
Maximum HP	200 HP
Approx. Dry Weight	1290 lbs.
Approx. Package Length with Trailer & Motor	21' 6"
Fuel Capacity	23 gal.
Passengers	4 (US)
Rod Locker Length	8.5'
Livewell Size	25 ga.
Bait Well Size	NA
Front Dead Rise Angle	15 degrees
Rear Dead Rise Angle	11 degrees

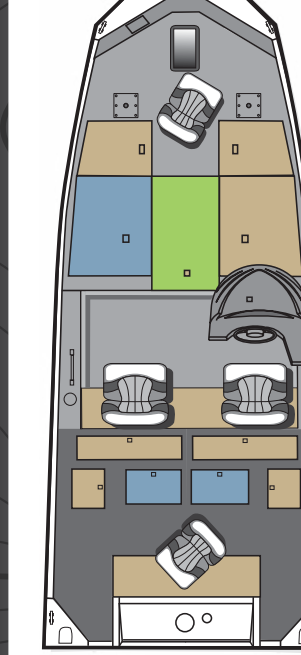

BASS TX 195 C-PRO SPECIFICATIONS

Overall Length	19' 6"
Beam	97"
Transom Height	20"
Bottom Width	69.25"/176
Interior Side Height	21"
Maximum HP	200 HP
Approx. Dry Weight	1290 lbs.
Approx. Package Length with Trailer & Motor	21' 6"
Fuel Capacity	23 gal.
Passengers	4 (US)
Rod Locker Length	8.5'
Livewell #1 Size	25 gal.
Livewell #2 Size	18 gal.
Bait Well Size	NA
Front Dead Rise Angle	15 degrees
Rear Dead Rise Angle	11 degrees

VERSATILITY

If you like to fish, but you LOVE your duck and goose excursions, then the camouflage versions of the Outlander, Sport X, and Sportsman models from Polar Kraft are sure to help you get some banded “memorabilia.”

From the feature-packed Outlander, for big water canvasbacks and bluebills, to the basic functionality of the mod-v Sportsman for mallards and delicious teal in the sloughs, you can hunt deep or skinny water. As with any Polar Kraft, it's your choice to be as luxurious or as basic as you want to be in deep or skinny water.



WALL COLORS & FLOORING

PAINT



BLACK CHARCOAL SILVER WHITE BABY BLUE SEAFOAM BLUE BURGUNDY HOT RED

** ALL COLORS AVAILABLE IN STANDARD OR DIAMOND FLAKE

PAINT



OD GREEN



MOSSY OAK BREAK UP



MOSSY OAK SHADOW GRASS



MOSSY OAK BREAK UP



MOSSY OAK SHADOW GRASS

FLOORING

FLOORING



GREY CARPET



GRAY VINYL



TAN CARPET



TAN VINYL



OD GREEN VINYL

UPHOLSTERY



TAN



GRAY



CAMO

WE BUILD RIVETED & WELDED BOATS

Riveted or welded? The fact is, both have their places in the marsh, river, lake or ocean flat. No need to fight over which is better since Polar Kraft offers both hull types. Get what YOU want, not what your friends, or manufacturers, say is better.

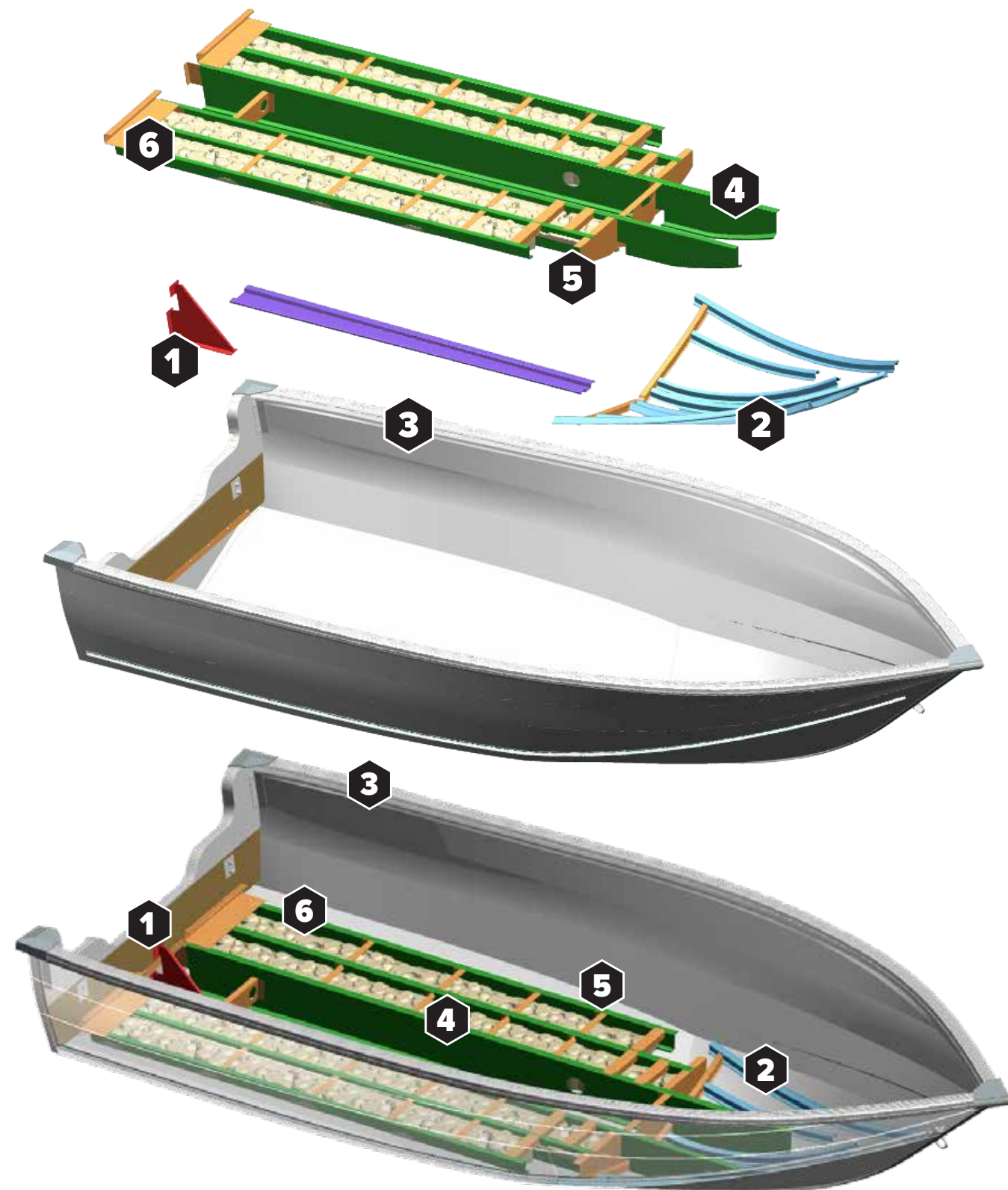

HULL CONSTRUCTION



Angled Power Bars

Counteract the twisting action of the engine's weight and thrust, transferring this torque energy across the boat's entire hull.



Reinforced Bow Support

Provides rigidity, consistency and energy dispersion when hitting a wave.



Extra Thick Hull Design

Polar Kraft boats are hand-formed out of the thickest aluminum on the market — making our boats the toughest in the industry.



6 Sturdy I-Beam Longitudinal Stringers

Run the entire length of the boat and combine with traverse bulkheads to create torque boxes that provide each Polar Kraft boat with exceptional support of the running surface, which translates into a smoother ride.



Torque Boxes

Formed by the I-beam transverse bulkheads that are found throughout the lower hull section — provides superior strength and the smoothest ride on the water.



Urethane Closed Cell Foam

A dentist doesn't fill half a cavity so why do some boat manufacturers? Polar Kraft goes to extreme lengths to fill our hull chambers with urethane closed cell foam which creates more buoyancy for safety and a quieter rig in shallow water to reduce spooking fish.

TRAILERS



Polar Kraft trailers are custom built to our boats, so they fit perfectly, versus other manufacturers that use a “base” trailer for multiple boats and then adjust bunks and rails to fit. Superior paint is standard with each all-steel frame being sandblasted clean prior to priming and painting. A Safe-T Lube system on axles for servicing bearings is handy as is a space-saving Swing Tongue. To help prevent slipping when getting in and out of our boats, fenders are steel, while other companies use plastic fenders that flex. Ratchet straps, a spare tire, Swing Jack and Fulton winch are all standard.

STRUCTURE



REVERSE CHINE

- Increased stability
- Faster on-plane performance
- More responsive turning and handling

EXTRUDED LIFTING STRAKES

- Excellent bow lift at cruising speeds
- Extruded lifting strakes
- Enhanced maneuverability
- Additional reinforcement on hull
- Smoother and drier ride

Polar Kraft Boats are built tough. All Polar Kraft models are constructed of 5052 Marine Grade Aluminum. 17 feet and larger: 0.125" Up to 17 feet: 0.100". A 25-35% increase from previous years!

STANDARDS & OPTIONS

MODEL	BASS			BAY	
	165	175 P/195 P	175 C/195 CP	190	210
Mooring Cover	0	0	0	NA	NA
Aerator/Bilge Pump	S	S	S	S	S
Automatic Bilge Pump	0	0/S	0/S	S	S
Camo: Break Up or Shadow Grass	NA	NA	NA	NA	NA
Hydraulic Steering	NA	0	0	0	0
Tilt Steering	0	0	0	0	0
On-board Battery Charger	0	0	0	0	0
Extra Pedestal Base	NA	NA	NA	NA	NA
Power Pro Pole Seat	0	0	0	0	0

STANDARDS & OPTIONS

MODEL	SPORTSMAN			SPORTSMAN T	SPORT X	
	1654CC/SC	1754CC/SC	1860CC/SC	1654/1754/1760/1860	190	210
Mooring Cover	NA	NA	NA	NA	NA	NA
Aerator/Bilge Pump	S	S	S	0/S	S	S
Automatic Bilge Pump	0	0	0	0	S	S
Camo: Break Up or Shadow Grass	0	0	0	0	0	0
Hydraulic Steering	NA	NA	0	NA	0	0
Tilt Steering	NA	NA	0	NA	0	0
On-board Battery Charger	0	0	0	NA	0	0
Extra Pedestal Base	0	0	0	0	0	0
Power Pro Pole Seat	0	0	0	0	0	0

KODIAK

FRONTIER

MODEL	KODIAK		FRONTIER	
	185	200	165	179/189
Mooring Cover	0	0	0	0
Bimini Top w/Stainless Steel Frame	0	0	0	0
Side Curtains	0	0	0	0
Stern Curtains	0	0	0	0
Tonneau Cover	0	0	0	0
Aerator/Bilge Pump	S	S	S	S
Automatic Bilge Pump	S	S	0	S
Boarding Platform	S	S	0	0
Ski Tow Bar	NA	NA	NA	0
AM/FM Digital CD w/Speakers	0	0	0	0
Camo — Break Up or Shadow Grass	NA	NA	NA	NA
Hydraulic Steering	S	S	0	0
Tilt Steering	S	S	0	0
On-board Battery Charger	0	0	0	0

OUTLANDER

MODEL	OUTLANDER										
	146T	156T	156SC	165T	165SC	186T	186SC	186CC	2010T	2010CC	2010 WT/CAT
Mooring Cover	0	0	0	0	0	0	0	0	0	0	0
Bimini Top w/Stainless Steel Frame	0	0	0	0	0	0	0	0	0	0	0
Side Curtains	NA	NA	NA	NA	NA	NA	NA	NA	NA	NA	0
Stern Curtains	NA	NA	NA	NA	NA	NA	NA	NA	NA	NA	0
Tonneau Cover	NA	NA	NA	NA	NA	NA	NA	NA	NA	NA	0
Aerator/Bilge Pump	S	S	S	S	S	S	S	S	S	S	S
Automatic Bilge Pump	0	0	0	0	0	S	S	S	S	S	S
Boarding Platform	0	0	0	0	0	0	0	0	0	0	0
Ski Tow Bar	NA	NA	NA	NA	NA	NA	NA	NA	NA	NA	NA
AM/FM Digital CD w/Speakers	NA	NA	0	NA	0	NA	0	NA	NA	NA	0
Camo — Break Up or Shadow Grass	0	0	0	0	0	0	0	0	0	0	0
Hydraulic Steering	NA	NA	NA	NA	NA	NA	0	0	NA	0	0
Tilt Steering	NA	NA	0	0	0	NA	0	0	NA	0	0
On-board Battery Charger	0	0	0	0	0	0	0	0	0	0	0

OUR PARTNERS

The choice is yours! Polar Kraft is proud to partner with the following companies: Suzuki, Mercury, Honda, Yamaha, Garmin, Humminbird, Lowrance, and Minn Kota.



PolarKraft • www.PolarKraft.com



Angler Qwest • www.AnglerQwestPontoons.com



Qwest LE • www.QwestPontoons.com

Our Apex Family.

POLARKRAFT



The background of the entire image is a dark gray topographic map with white contour lines. The lines are irregular and wavy, representing terrain elevation. In the center, there is a black rectangular box with slightly rounded corners.

POLARKRAFT

300 E. Chicago Ave., Syracuse, IN 46567 | POLARKRAFT.COM