

# Balboa BP7 SERIES

## Installation/Operation Manual



**BALBOA<sup>®</sup> BP SERIES**  
By **HYDROQUIP<sup>™</sup>**

# Contents

Important Safety Instructions.....	3-4
Electrical Installation.....	5-7
GFCI Wiring Detail.....	7
Power Connection.....	8
Pump Cord Configuration.....	9
Spaside Installation.....	10
Wi-Fi Option Installation.....	11
Circuit Board Configuration.....	12
Circuit Board Wiring Diagram.....	13
System Setup & Connections.....	14-15
TP400/600 Programming.....	16
TP500/TP500S Programming.....	17
TP800/900/spaTouch Programming.....	18
spaTouch (Icon) Programming.....	19
System Start-Up.....	20
Operational Considerations.....	21
System Functions / Features.....	22-23
System Plug Pinouts.....	24
Testing/Replacing Sensors.....	24
Troubleshooting.....	25-26
System Data Label.....	27
Warranty Information.....	27

# IMPORTANT SAFETY INSTRUCTIONS

- ! **DANGER** To reduce the risk of injury, do not permit children to use this product unless they are closely supervised at all times.
  - ! **WARNING - RISK OF CHILD DROWNING.** Extreme caution must be exercised to prevent unauthorized access by children. To avoid accidents, ensure that children cannot use a spa or hot tub unless they are supervised at all times.
  - ! **DANGER** To reduce the risk of injury to persons, do not remove suction fittings.
  - ▶ Spa location must accommodate sufficient drainage of water around the base of the structure, as well as the power source compartment.
  - ▶ Prolonged immersion in water that is warmer than normal body temperature can result in a dangerous condition known as HYPERTHERMIA. The causes, symptoms, and effects of hyperthermia may be described as follows: Hyperthermia occurs when the internal temperature of the body reaches a level several degrees above the normal body temperature of 98.6°F. The symptoms of hyperthermia include dizziness, fainting, drowsiness, lethargy, and an increase in the internal temperature of the body. The effects of hyperthermia include (1) unawareness of impending hazard, (2) failure to perceive heat, (3) failure to recognize the need to exit spa, (4) physical inability to exit spa, (5) fetal damage in pregnant women, (6) unconsciousness resulting in danger of drowning. **WARNING** The use of alcohol, drugs or medication can greatly increase the risk of fatal hyperthermia in hot tubs and spas.
  - ! **DANGER - RISK OF ELECTRICAL SHOCK.**  
A spa may be installed within 5 feet of metal surfaces if each metal surface is permanently connected by a solid copper conductor attached to the wire connector on the terminal box . Refer to NEC and local codes in effect at the time of installation.)
  - ▶ A bonding lug is provided on the control box to permit connection of a solid copper bonding conductor between this point and any equipment, metal enclosures of electrical equipment, metal water pipe, or conduit within 5 feet (1.5m) of the unit as needed to comply with local requirements.
  - ▶ Bond accessible metal to the dedicated connector on the equipment grounding bus, bond the equipment ground bus to the local common bonding grid as part of the installation in the form of (1) a reinforced concrete slab for support, (2) a ground plate provided beneath the hot tub or spa, or (3) a permanent ground connection that is acceptable to the local inspection authority.
  - ! **DANGER RISK OF ELECTRICAL SHOCK.** Do not permit any electrical appliance, such as a light, telephone, radio, or television, within 5 feet (1.5m) of a spa or hot tub.
- To reduce the risk of injury:**
- ▶ The water in a spa or hot tub should never exceed 104°F (40°C). Water temperatures between 100°F (38°C) and 104°F (40°C) are considered safe for a healthy adult. Lower water temperatures are recommended for extended use (exceeding 10-15 minutes) and for young children.
  - ▶ Excessive water temperatures have a high potential for causing fetal damage during the early months of pregnancy, pregnant or possibly pregnant women should limit spa or hot tub water temperatures to 100°F(38°C).
- Before entering the spa or hot tub, the user should measure the water temperature with an accurate thermometer.
- The use of alcohol, drugs, or medication before or during spa or hot tub use may lead to unconsciousness with the possibility of drowning.
- Persons suffering from obesity or with a medical history of heart disease, low or high blood pressure, circulatory system problems, or diabetes should consult a physician before using a spa or hot tub.

# IMPORTANT SAFETY INSTRUCTIONS

Persons using medication should consult a physician before using a spa or hot tub since some medication may affect heart rate, blood pressure, and circulation.

## For Cord and Plug Connected Units

Must be connected to a grounded, grounding type receptacle only. NEVER connect the spa to an extension cord.

Do not bury the cord.

## For Permanently Installed Units

A terminal marked "G" or "ground" is provided in the wiring box located inside the equipment compartment. To reduce the risk of electric shock, connect the terminal or connector to the grounding terminal of your electrical service or supply panel with a continuous green insulated copper wire in accordance with National Electric Code Table 250-95 and any other local codes in effect at the time of the installation.

## For Permanently Installed Units not Provided with an Internal Disconnecting Method

The electrical supply for this product must include a suitably rated switch or circuit breaker to open all ungrounded supply conductors to comply with Section 422-30 of the National Electric Code, ANSI/NFPA 70 1987. The disconnecting means must be readily accessible to the tub occupant but installed at least 5 feet (1.5m) from the tub water.

## For Units with Gas Heaters

**WARNING** - Do not install indoors. This unit uses a gas heater that requires proper ventilation and is intended for outdoor use only.

## High Voltage Warning

**HIGH VOLTAGE CAN SERIOUSLY INJURE OR KILL!**

**ONLY EXPERIENCED TECHNICIANS SHOULD SERVICE THIS EQUIPMENT.**

**DO NOT** remove the protective covers from any electrical enclosure, or attempt to service any related electrical device, unless you are a qualified electrician or service professional.

### **DANGER**

**Risk of electric shock. Before working with any electrical connections, make certain that the Main Power breaker from the house breaker box has been turned off.**

### **WARNING**

**All electrical work must be performed by a qualified electrician and must conform to all local codes.**

### **IMPORTANT**

**Due to the danger of severe electrical shock, locate all power disconnects before servicing a spa. Precautions must be taken whenever working with breaker boxes, G.F.C.I.'s, or service disconnects.**

# Electrical Installation

A licensed electrician must accomplish the electrical installation in accordance with the National Electric Code(NEC) Article 680, and any local codes in effect at the time of installation.

Refer to the System Data Label for equipment voltage and maximum amperage draws.

The GFCI (Ground Fault Circuit Interrupter) is a mandatory electrical safety device required for all portable spas and hot tubs as specified in the National Electrical Code Article 680-42. The GFCI in your particular installation may be installed at the electrical service panel or a separate sub-panel.

Use copper conductors ONLY. The ground must be sized following the National Electric Code, Table 250-122. For Power conductor size, refer to the National Electric Code Table 310-16.

A bonding lug has been provided on the control box to allow connection to local ground points. To reduce the risk of electrical shock, a solid copper bonding wire should be connected from this lug to any metal objects within 5 feet of the spa.

The NEC and most local codes require that a “disconnect” be installed within “line-of-site” of the spa.

Circuit & Breaker Rating	15A	20A	30A	40A	50A	60A
Maximum Amps	12A	16A	24A	32A	40A	48A
Minimum Wire Size	14	12	10	8	6	4

The above table is a wiring chart representation.

**IMPORTANT-** If your electrician is not absolutely sure how to connect your system correctly, call your local dealer. Any mistake may be costly and void your equipment warranty.



**CAUTION:** Do not connect or disconnect any components while the power is on. All connections must be done with the power off as it may cause damage to the system.



**\*\*Any resulting damages are not covered under manufacturer's warranty\*\***



**CAUTION:** Damage may occur to the circuit board and spaside if the spaside plug is not properly aligned to the receptacle on the circuit board or if the spaside plug is connected or disconnected while the power is on.



**\*\*Any resulting damages are not covered under manufacturer's warranty\*\***

# Electrical Installation

## OPTION 1

### GFCI Installed in Main Service Panel

20-60AMP HARDWIRED

#### MAIN BREAKER PANEL

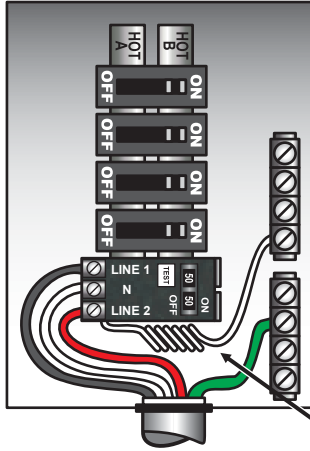

#### INLINE SPA DISCONNECT

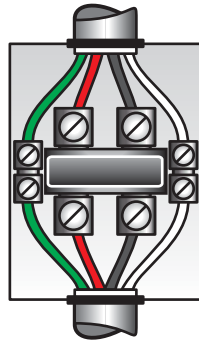

#### PORTABLE SPA

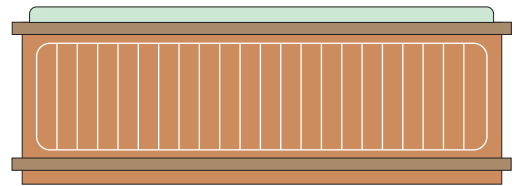

REFER TO GFCI WIRING DETAIL ON PAGE 8

Option 1 shows the power from GFCI breaker installed into main service panel to a service disconnect within line-of-site of the spa. If the manufacturer of your homes main breaker panel makes a GFCI breaker, you may be able to add it to an open slot in the panel.

## OPTION 2

### Subpanel GFCI Installed

20-60AMP HARDWIRED

#### MAIN BREAKER PANEL

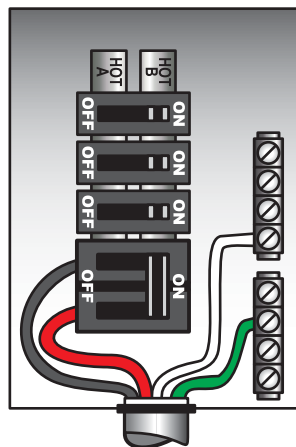

#### GFCI DISCONNECT

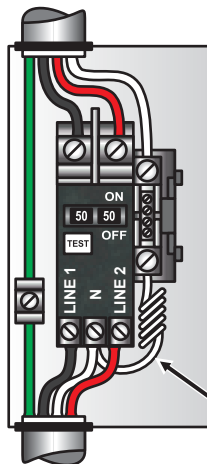

#### INLINE SPA DISCONNECT



#### TO PORTABLE SPA



REFER TO GFCI WIRING DETAIL ON PAGE 8

Option 2 shows the power from main service panel to a GFCI subpanel within line-of-site of the spa. (Note: Most local codes will allow a GFCI subpanel to be a disconnect. If this is not the case in your installation, a disconnect must be provided.)

# Electrical Installation

If your system was configured to include a 120VAC power cord, ensure that the proper receptacle has been installed (a dedicated circuit is required). DO NOT under any circumstances modify a 20 Amp plug to fit into a 15 Amp receptacle or use an extension cord. Doing so will create hazardous conditions and/or invalidate the warranty.

## OPTION 3 Units with 15A / 20A GFCI Plug Connection

15/20AMP CORD END GFCI

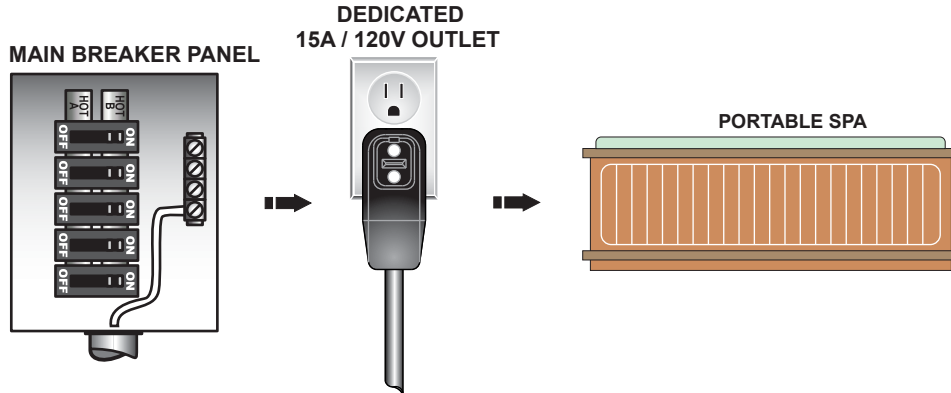

This illustration depicts a typical 15 AMP, cord-end GFCI installation. (The spa must be installed on a dedicated circuit.)

## GFCI Wiring Detail

It is important that the GFCI circuit breaker is installed correctly. Often this component has been improperly installed causing the breaker to instantly trip when the system is turned on. Below is an illustration of a typical GFCI breaker installation.

**WARNING: Refer to the circuit breaker manufacturers installation instructions. This illustration is meant to be a guide for Field Technicians and is not intended to override or substitute the instructions supplied with the circuit breaker.**

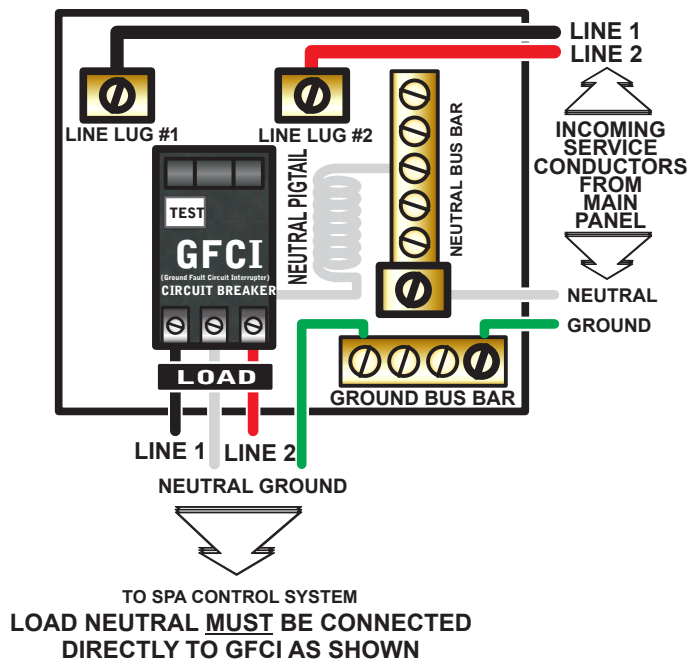

# Power Connection

**IMPORTANT:** Always refer to the product data label (located on top of the control box) for specific electrical information.

- Use copper conductors only as required by the NEC.
- Secure wires as defined by the NEC and in compliance with any local codes in effect at the time of installation.

## 240-VOLT ELECTRICAL SERVICE REQUIREMENTS

**OPTIONAL (N)**  
**L2**  
**L1**  
**GR**

If supply circuit allows move DIP switches A2 & A3 to the on or up position to place the system in high amp mode. High amp mode allows the heater to stay on when high speed pump(s) or blower is turned on.

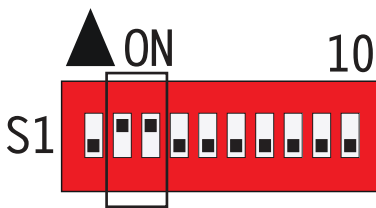

Ground Lug

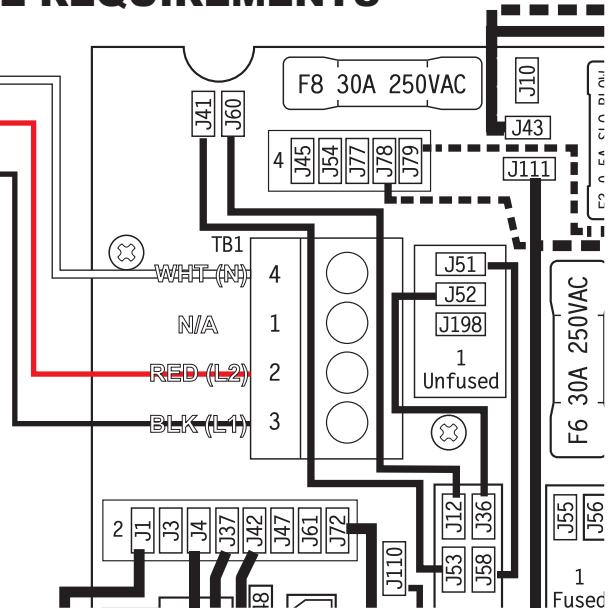

## 120-VOLT ELECTRICAL SERVICE REQUIREMENTS

Step 1: Convert transformer to allow 120V input by installing an additional jumper\*\* (Included with system) at J24 located above the transformer

**\*\*120V JUMPER HQ PT#: 34-20564 (Included)**

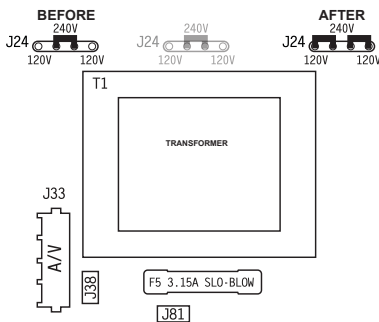

Assure DIP switches A2 & A3 are OFF or in the down position to place the system in low amp mode. Low amp mode disables the heater when high speed pump(s) or blower is turned on to prevent breaker tripping.

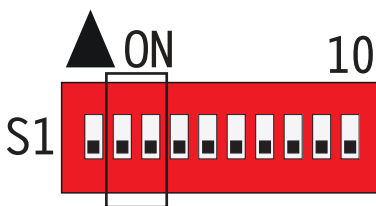

Ground Lug

Step 2: Connect 120V input power as shown

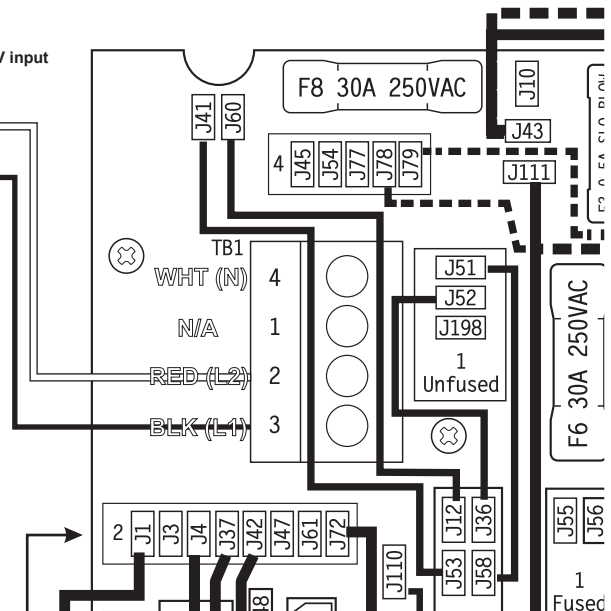

Step 3: Assure all component white wires are connected at Area 2



# Pump Cord Connections

## 2-SPEED PUMP CORD CONFIGURATION

The following wiring configuration is for two-speed pump circuits.

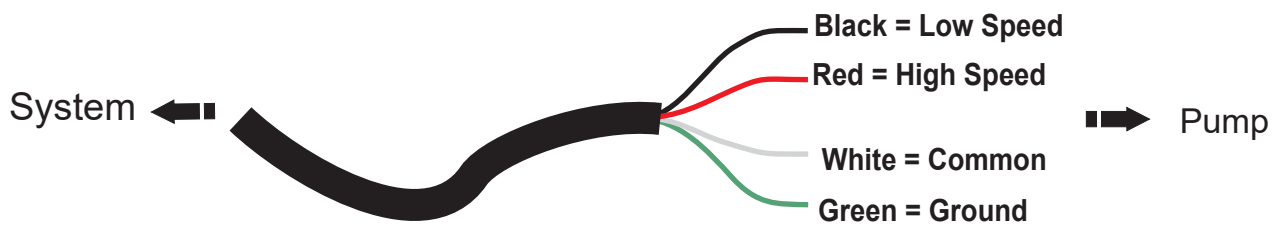

## SINGLE SPEED PUMP / ACCESSORY CORD CONFIGURATION

The following wiring configuration is for single-speed pump circuits, circulation pumps, ozones, blowers and accessories.



# SPASIDE CONTROL INSTALLATION

If required, you may have to cut out a hole in the spa shell to install spaside control.

- The mounting area must be above the maximum water level of the spa and in an area with good drainage to prevent any standing water on or around the spaside.
- The spaside should never be submerged.
- The spaside should be protected from extended periods of exposure to sunlight.

**Step 1** - Clean area and insert spaside control. (Fig.1)

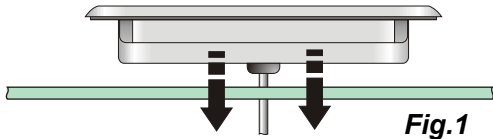

**Step 2** - Remove the double sided adhesive from the back of the spaside. Make certain the spaside is straight and adhere to the spa shell. (Fig.2)

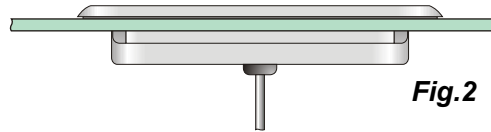

**Step 3** - Remove protective film from display window then clean the face of the spaside.

Now carefully align and apply the label. (Fig.3)



**Step 4** - Connect spaside to an empty connection marked MAIN. (Fig.4)

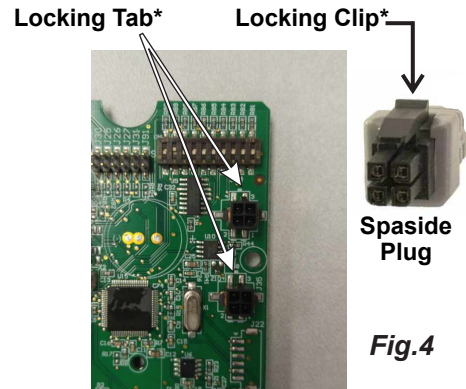

## CONNECTING SPASIDE & EXTENSION

**\*Must align Locking Clip on spaside plug with Locking Tab on circuit board for proper function.**

Cord plugs are labeled to insure proper plug alignment as shown in **Fig.6**

When utilizing a spaside extension cord, the clip and tab must also be aligned at all connections. **Fig.5**

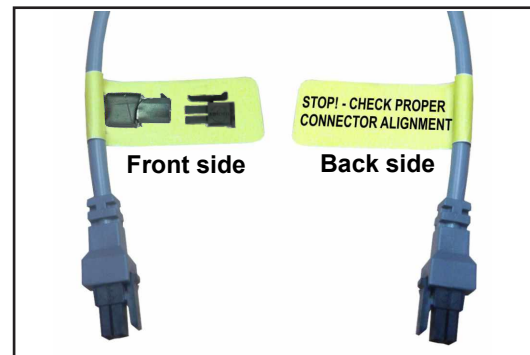

**CAUTION:** Damage may occur to the circuit board and spaside if the spaside plug is not properly aligned to the receptacle on the circuit board or if the spaside plug is connected or disconnected while the power is on.



**\*\*Any resulting damages are not covered under manufacturer's warranty\*\***

## WIFI MODULE INSTALLATION KIT (OPTIONAL)

Your new system has the capability to connect with the internet using a wifi module.

If Provided with your system, please make sure to install the module following these few steps:

Step 1 - Insert wifi cable connector into an empty connection mark “Main”

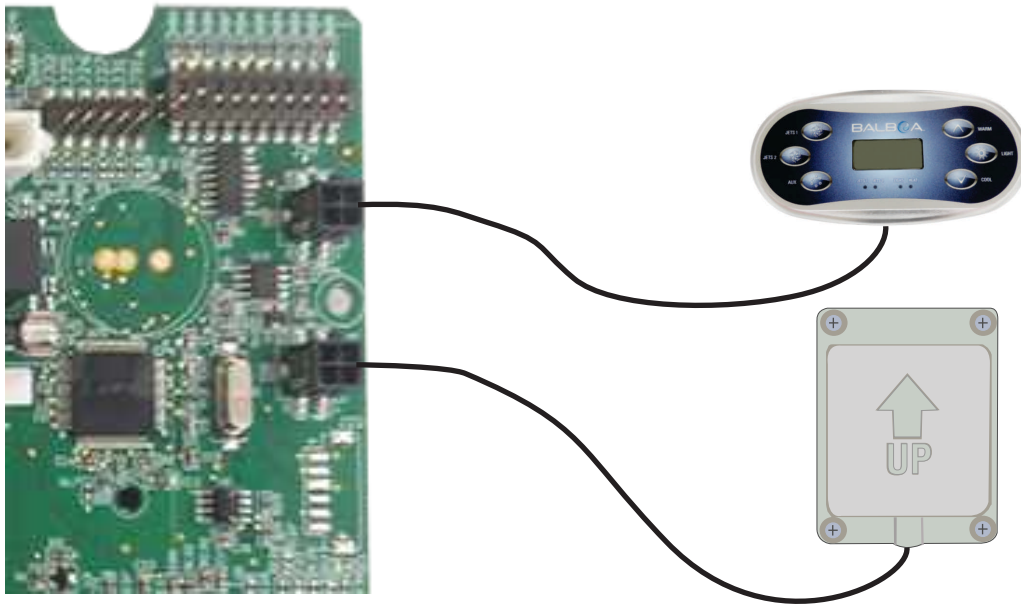

\* If no main connections are available, you may use the “Y” cable provided with the wifi module kit (34-0216E)

Step 2 - You may mount the wifi module inside the lower control system enclosure.

Step 3 - Please follow the instructions provided with the wifi module kit to properly install your BWA App™

Note: If you experience poor operation via the wifi module, it may be necessary to relocate the module closer to your wifi router.

# Circuit Board Configurations



Figure 1

All component outputs are pre-configured for 240V. If 120V output is required, please utilize the illustration below and the wiring diagram that was included with your unit for the correct component location to properly convert to 120V.

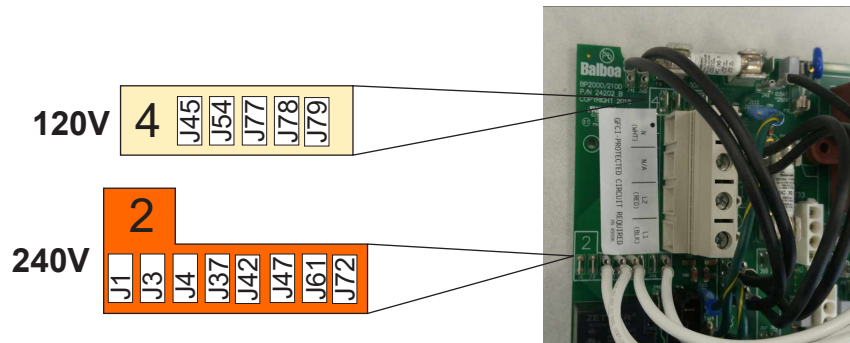

## Voltage Selection Chart for 120V Conversion

Component	Volts	Amps	From	To
P1 1 or 2-spd	120V	12A	Area 2	Area 4
P2,P3,P4,BL	120V	10A	Area 2	Area 4
Ozone	120V	1A	Area 2	Area 4
Circ Pump	120V	2A	Area 2	Area 4
AV	120V	2A	Area 2	Area 4

## Expander Board (Optional)

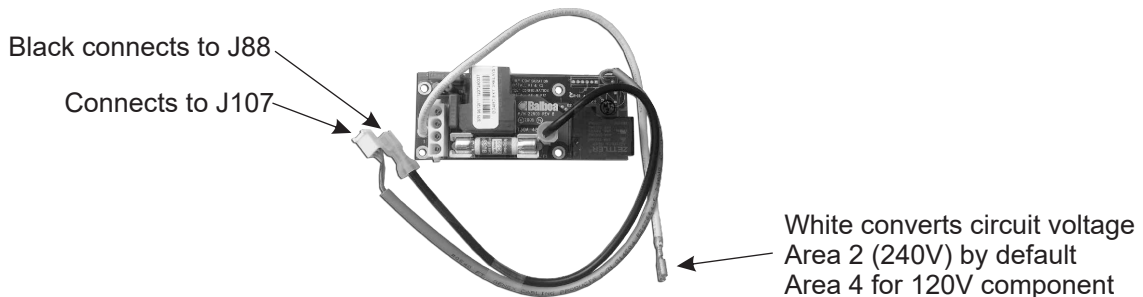

**IMPORTANT- CIRC PUMP & OZONE MUST BE SAME VOLTAGE RATING**

# Wiring Diagram

## HYDROQUIP™

510A N. Sheridan Street · Corona, CA 92880-2024  
 Email: info@hydroquip.com · Internet: http://www.hydroquip.com/  
 Telephone: 951.273.7575 · Fax: 800.332.7190

J43 TO J19 (PUMP 3 OR MICROSILK® ON J14)  
 IN SETUPS 9-11, 17, 18, & 22-32

FOR DEDICATED 240V, DO NOT CONNECT WHT. AND DO NOT CONNECT ANYTHING TO GROUP 4

WHT  
 RED  
 BLK  
 GRN

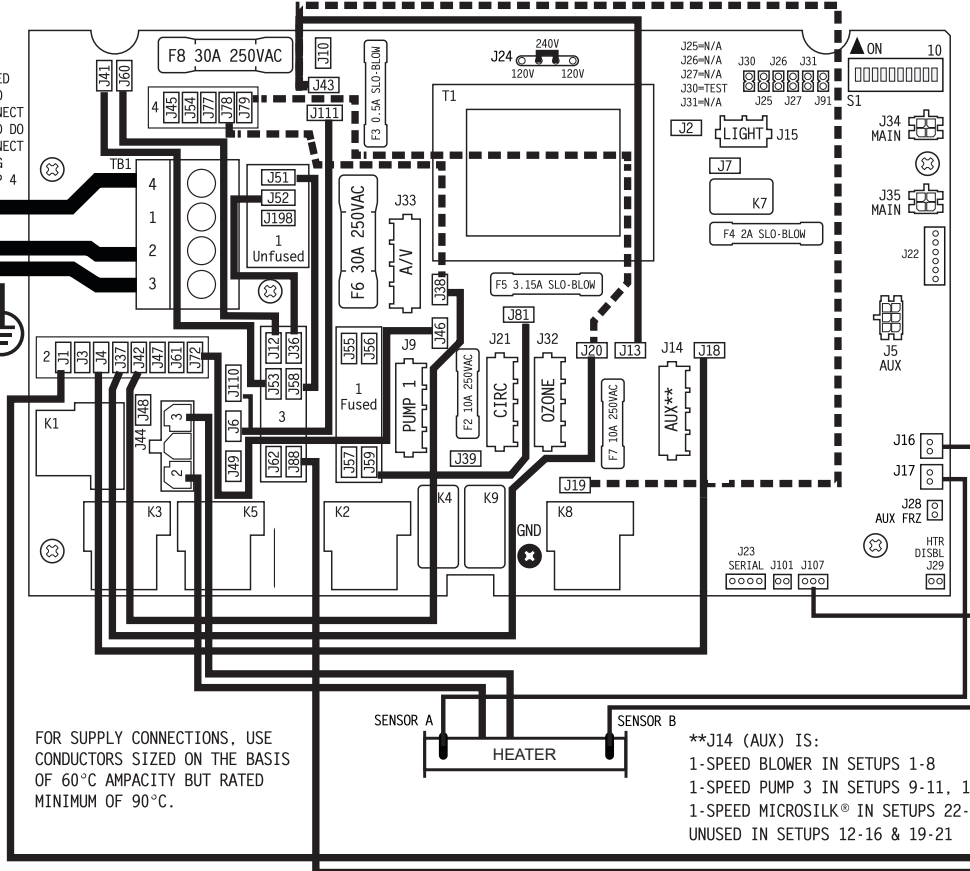

SWITCHBANK S1 OFF

SWITCHBANK S1 ON

TEST MODE OFF	◀ A1	TEST MODE ON
DON'T ADD 1 HS PUMP W/HTR	A2 ▶	ADD 1 HS PUMP WITH HEAT
DON'T ADD 2 HS PUMPS W/HTR	◀ A3	ADD 2 HS PUMPS WITH HEAT
DON'T ADD 4 HS PUMPS W/HTR	◀ A4	ADD 4 HS PUMPS WITH HEAT
SPECIAL AMPERAGE RULE A	◀ A5	SPECIAL AMPERAGE RULE B
STORE SETTINGS**	◀ A6	MEMORY RESET**
1 MIN HTR COOLDOWN (ELEC)	◀ A7	5 MIN HTR COOLDOWN (GAS)
NOT ASSIGNED	◀ A8	NOT ASSIGNED
NOT ASSIGNED	◀ A9	NOT ASSIGNED
NOT ASSIGNED	◀ A10	NOT ASSIGNED

\*\* SWITCH # 6 SHOULD BE SET TO OFF UPON FINAL INSTALLATION.

\*EXPANDER BOARD IS:

2-SPEED PUMP 2 IN SETUPS 1, 6, 9, 12, 17, 19, 22 & 27

1-SPEED PUMP 2 (ONLY) IN SETUPS 2, 3, 7, 10, 11, 13, 14, 18, 20, 23, 24 & 28

1-SPEED PUMP 2 AND 1-SPEED PUMP 4 (WITH SPLITTER†) IN SETUPS 30-32

UNUSED IN SETUPS 4, 5, 8, 15, 16, 21, 25, 26 & 29

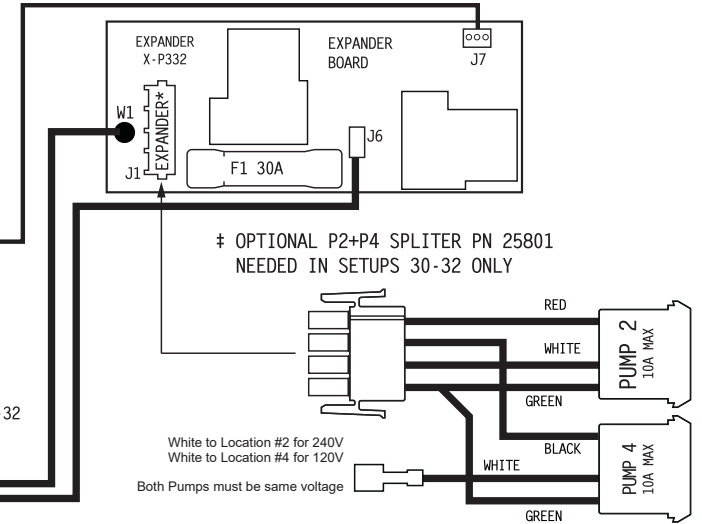

## SYSTEM SETUP & CONNECTION CHART

Setup #	Circ Pump	Pump 1	Pump 2	Pump 3	Pump 4	Blower	MicroSilk®	Temp Scale
1	Yes (J21)	J9 (2-Spd)	J1 (2-Spd)	None	None	J14 (1-Spd)	None	°F
2	Yes (J21)	J9 (2-Spd)	J1 (1-Spd)	None	None	J14 (1-Spd)	None	°F
3	Yes (J21)	J9 (1-Spd)	J1 (1-Spd)	None	None	J14 (1-Spd)	None	°F
4	Yes (J21)	J9 (2-Spd)	None	None	None	J14 (1-Spd)	None	°F
5	Yes (J21)	J9 (1-Spd)	None	None	None	J14 (1-Spd)	None	°F
6	None	J9 (2-Spd)	J1 (2-Spd)	None	None	J14 (1-Spd)	None	°F
7	None	J9 (2-Spd)	J1 (1-Spd)	None	None	J14 (1-Spd)	None	°F
8	None	J9 (2-Spd)	None	None	None	J14 (1-Spd)	None	°F
9	Yes (J21)	J9 (2-Spd)	J1 (2-Spd)	J14 (1-Spd)	None	None	None	°F
10	Yes (J21)	J9 (2-Spd)	J1 (1-Spd)	J14 (1-Spd)	None	None	None	°F
11	Yes (J21)	J9 (1-Spd)	J1 (1-Spd)	J14 (1-Spd)	None	None	None	°F
12	Yes (J21)	J9 (2-Spd)	J1 (2-Spd)	None	None	None	None	°F
13	Yes (J21)	J9 (2-Spd)	J1 (1-Spd)	None	None	None	None	°F
14	Yes (J21)	J9 (1-Spd)	J1 (1-Spd)	None	None	None	None	°F
15	Yes (J21)	J9 (2-Spd)	None	None	None	None	None	°F
16	Yes (J21)	J9 (1-Spd)	None	None	None	None	None	°F

J1 = Receptacle on expander board

NOTE: Component operation dependent on number of pump & accessory buttons on keypad.

**NOTE: \* Wiring change required - Move Black J20 wire from J13 to J12 (Setups: 2, 4, 9, 11, 17 only)**

## SYSTEM SETUP & CONNECTION CHART, CONT'D

DEFAULT >

Setup #	Circ Pump	Pump 1	Pump 2	Pump 3	Pump 4	Blower	MicroSilk®	Temp Scale
17	None	J9 (2-Spd)	J1 (2-Spd)	J14 (1-Spd)	None	None	None	°F
18	None	J9 (2-Spd)	J1 (1-Spd)	J14 (1-Spd)	None	None	None	°F
19	None	J9 (2-Spd)	J1 (2-Spd)	None	None	None	None	°F
20	None	J9 (2-Spd)	J1 (1-Spd)	None	None	None	None	°F
21	None	J9 (2-Spd)	None	None	None	None	None	°F
22	Yes (J21)	J9 (2-Spd)	J1 (2-Spd)	None	None	None	J14 (1-Spd)	°F
23	Yes (J21)	J9 (2-Spd)	J1 (1-Spd)	None	None	None	J14 (1-Spd)	°F
24	Yes (J21)	J9 (1-Spd)	J1 (1-Spd)	None	None	None	J14 (1-Spd)	°F
25	Yes (J21)	J9 (2-Spd)	None	None	None	None	J14 (1-Spd)	°F
26	Yes (J21)	J9 (1-Spd)	None	None	None	None	J14 (1-Spd)	°F
27	None	J9 (2-Spd)	J1 (2-Spd)	None	None	None	J14 (1-Spd)	°F
28	None	J9 (2-Spd)	J1 (1-Spd)	None	None	None	J14 (1-Spd)	°F
29	None	J9 (2-Spd)	None	None	None	None	J14 (1-Spd)	°F
30*	Yes (J21)	J9 (2-Spd)	J1 (1-Spd)	J14 (1-Spd)	J1 (1-Spd)	None	None	°F
31*	Yes (J21)	J9 (1-Spd)	J1 (1-Spd)	J14 (1-Spd)	J1 (1-Spd)	None	None	°F
32*	None	J9 (2-Spd)	J1 (1-Spd)	J14 (1-Spd)	J1 (1-Spd)	None	None	°F

\* = Setups 30-32 require splitter harness PT# 25801 for pumps 2 & 4 @ J1 expander connection

J1 = Receptacle on expander board

NOTE: Component operation dependent on number of pump & accessory buttons on keypad.

# TP600 / TP400 Programming Procedure

## Test Menu Access (S1, Switch 1 ON) *Service Technician ONLY.*

With system on or OFF move DIP Switch 1 (on S1 on the Main circuit board) to ON. The system will enter Test Mode. Moving DIP Switch 1 to OFF will exit Test Mode.

As soon as Switch #1 is placed in the ON position, the temperature will show "T" after it instead of F or C, indicating the System is in Test Mode

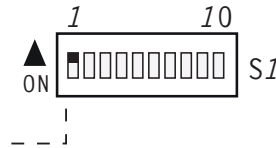

## Software Setups

Under the TEST Menu, the Setup screen will allow changing the Setup from 1 to any number established by the Manufacturer. Changing the Setup may require wiring changes as well.

**You will have 1 minute** to complete the setup change after you manually exit Priming Mode. (Once familiar with the process, the Setup change should take less than 15 seconds.)

Again, **You will have 1 minute** to complete the setup change after you manually exit Priming Mode.

Immediately after exiting Priming Mode, press this sequence of buttons: Warm, Light, Warm, Warm, Warm, Warm. Continue to press Warm until the display shows the Setup Number (S-01, S-02, etc.) you want to switch to. When the correct setup number is showing, press Light once, and the system will reset, using the newly-selected Setup from that point on.

Move DIP Switch 1 to the OFF position to take the spa out of Test Mode. °F or °C will replace °T.

**NOTE:** Changing the Setup may require wiring changes as well - refer to the wiring diagram or wiring diagram addendum.

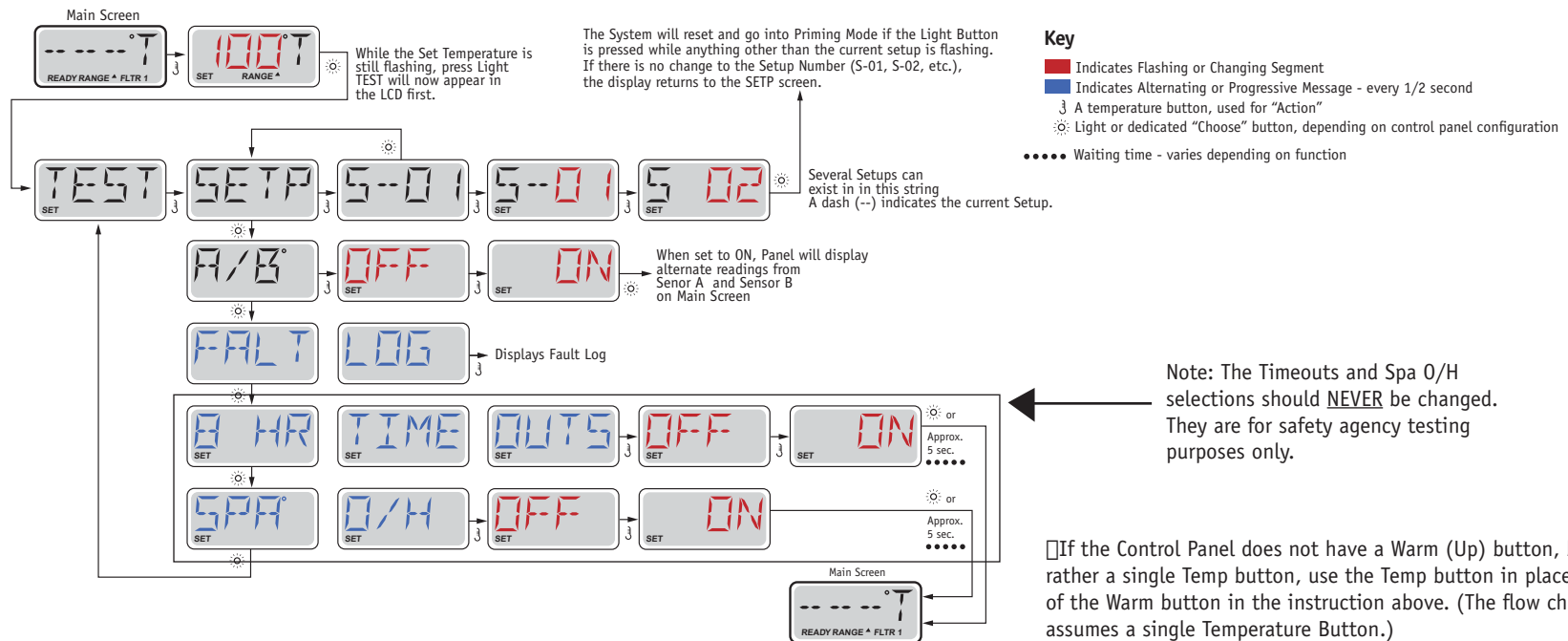



# TP500/TP500S Programming Procedure

## Test Menu Access (S1, Switch 1 ON) *Service Technician ONLY.*

With system on or OFF move DIP Switch 1 (on S1 on the Main circuit board) to ON. The system will enter Test Mode. Moving DIP Switch 1 to OFF will exit Test Mode.

As soon as Switch #1 is placed in the ON position, the temperature will show "T" after it instead of F or C, indicating the System is in Test Mode

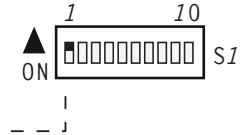

## Software Setups

Under the TEST Menu, the Setup screen will allow changing the Setup from 1 to any number established by the Manufacturer. Changing the Setup may require wiring changes as well.

**You will have 1 minute** to complete the setup change after you manually exit Priming Mode. (Once familiar with the process, the Setup change should take less than 15 seconds.)

**NOTE:** Changing the Setup may require wiring changes as well - refer to the wiring diagram or wiring diagram addendum.

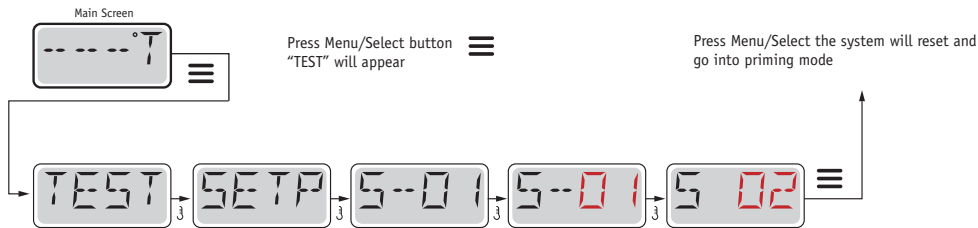

Move DIP Switch 1 to the OFF position to take the spa out of Test Mode. °F or °C will replace °T.

### Key

- Indicates Flashing or Changing Segment
- Indicates Alternating or Progressive Message - every 1/2 second
- ⌋ A temperature button, used for "Action"
- ☰ Menu/Select button, used to enter programming modes
- ..... Waiting time - varies depending on function

If the Control Panel does not have a Warm (Up) button, but rather a single Temp button, use the Temp button in place of the Warm button in the instruction above. (The flow chart assumes a single Temperature Button.)

# TP800 / TP900 / spaTouch™ Menued Panel Programming Procedure

## Test Menu Access (S1, Switch 1 ON) *Service Technician ONLY.*

**DANGER! HIGH VOLTAGE WILL BE ACCESSIBLE! SERVICE TECHNICIAN ONLY!**

While the system is running, move DIP Switch 1 (on S1 on the Main circuit board) to ON.  
The system will enter Test Mode.  
Moving DIP Switch 1 to OFF will exit Test Mode.

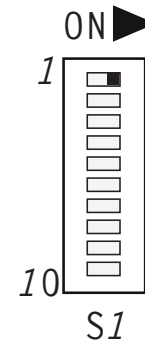

## Software Setups

Under the TEST Menu, the Setup screen will allow changing the Setup from 1 to any number established by the Manufacturer.  
Changing the Setup may require wiring changes as well.

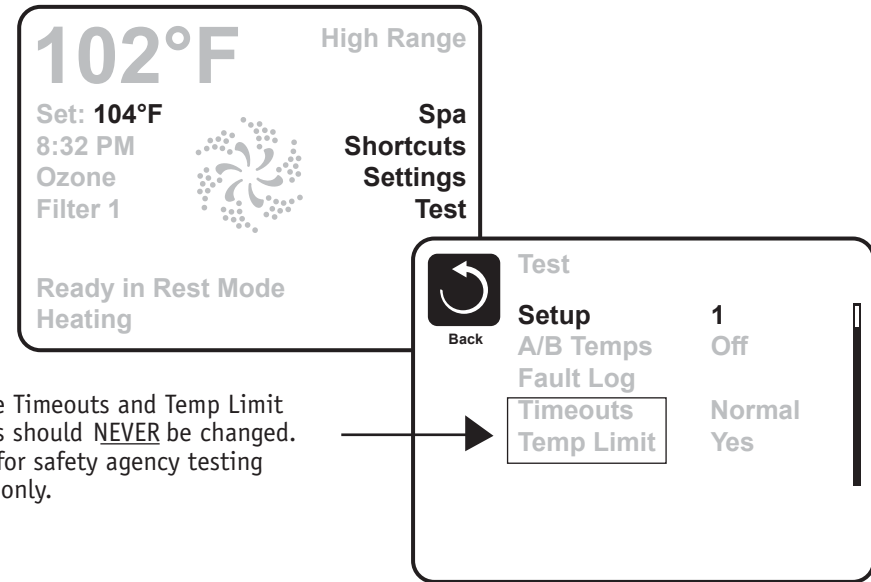

**Note:** The Timeouts and Temp Limit selections should NEVER be changed. They are for safety agency testing purposes only.

# spaTouch™ Icon-Driven Panels Programming Procedure

## Test Menu Access (S1, Switch 1 ON) *Service Technician ONLY.*

**DANGER! HIGH VOLTAGE WILL BE ACCESSIBLE! SERVICE TECHNICIAN ONLY!**

While the system is running, move DIP Switch 1 (on S1 on the Main circuit board) to ON. The system will enter Test Mode.

Moving DIP Switch 1 to OFF will exit Test Mode.

As soon as Switch #1 is placed in the ON position, the temperature will show "T" after it instead of F or C, indicating the System is in Test Mode

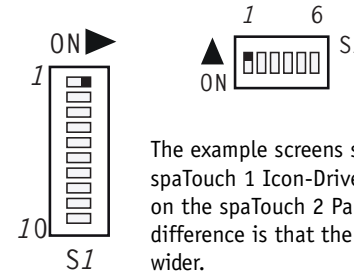

The example screens shown here are from the spaTouch 1 Icon-Driven Panel, but the screens on the spaTouch 2 Panel are similar. The main difference is that the spaTouch 2 display is wider.

## To Change Software Setups:

While in Test Mode, press the indicated icons to move from screen to screen.

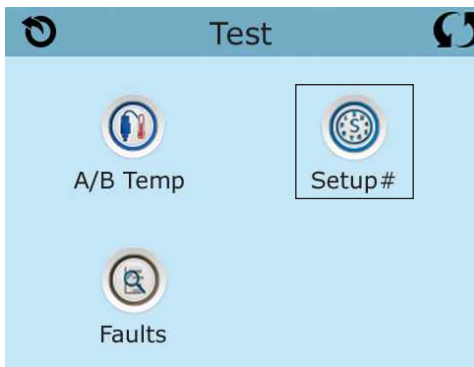
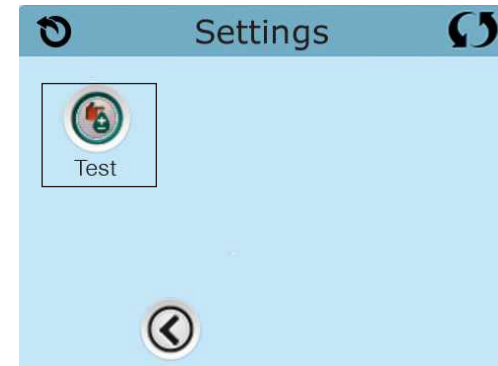
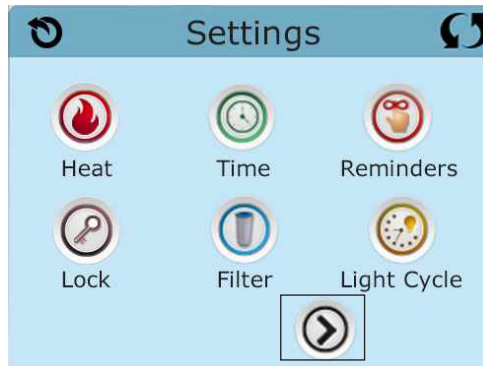
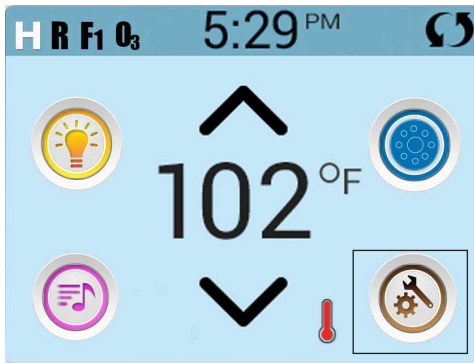

Once on the Setup Selection screen, press the Up or Down icon to select the desired Setup Number, then press the Check Mark icon to confirm and to have the spa restart.



After the system restarts, you may see a message that "The settings have been reset"; this is normal after changing Setups with DIP Switch 6 in the OFF position. Press "Clear" to dismiss this message.

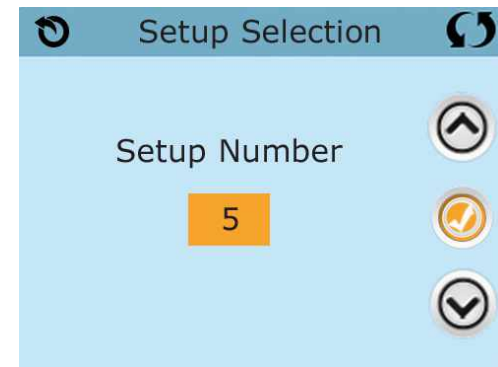

# System Start-Up

## Preparation and Filling

Fill the spa to its correct operating level. Be sure to open all valves and jets in the plumbing system before filling to allow as much air as possible to escape from the plumbing and the control system during the filling process.

After turning the power on at the main power panel, the top-side panel display will go through specific sequences. These sequences are normal and display a variety of information regarding the configuration of the

## Priming Mode

This mode will last for 4-5 minutes or you can manually exit the priming mode after the pump(s) have primed.

Regardless of whether the priming mode ends automatically or you manually exit the priming mode, the system will automatically return to normal heating and filtering at the end of the priming mode. During the priming mode, the heater is disabled to allow the priming process to be completed without the possibility of energizing the heater under low-flow or no-flow conditions. Nothing comes on automatically, but the pump(s) can be energized by pushing the "Jet" buttons.

If the spa has a Circ Pump, it can be activated by pressing the "Light" button during P

## Priming the Pumps

As soon as the priming mode has started, push the "Jet" button once to start Pump 1 in low-speed and then again to switch to high-speed. Also, push the Pump 2 or "Aux" button, if you have a 2nd pump, to turn it on. The pumps will now be running in high-speed to facilitate priming. If the pumps have not primed after 2 minutes, and water is not flowing from the jets in the spa, do not allow the pumps to continue to run. Turn off the pumps and repeat the process. Note: Turning the power off and back on again will initiate a new pump priming session. Sometimes momentarily turning the pump off and on will help it to prime. Do not do this more than 5 times. If the pump(s) will not prime, shut off the power to the spa and call for service.

Important: A pump should not be allowed to run without priming for more than 2 minutes. Under NO circumstances should a pump be allowed to run without priming beyond the end of the 4-5 minute priming mode. Doing so may cause damage to the pump and cause the system to energize the heater and go into an overheat c

## Exiting Priming Mode

You can manually exit Priming Mode by pressing a "Temp" button (Up or Down). Note that if you do not manually exit the priming mode as described above, the priming mode will be automatically terminated after 4-5 minutes. Be sure that the pump(s) have been primed by this time.

Once the system has exited Priming Mode, the top-side panel will momentarily display the set temperature but the display will not show the temperature yet, as shown below. This is because the system requires approximately 1 minute of water flowing through the heater to determine the water temperature and display it.

# Operation Considerations

The following describes situations you may encounter and situations to be aware of.

## Warm Weather Conditions

Since your spa will normally be expected to maintain warm to hot water ready for use, a great deal of attention has been directed to the energy conservation detail of insulation to keep electrical cost down. Energy conservation efficiency may be achieved by extensive insulation of the spa cabinet, plumbing, spa shell and in some climates full foam insulation may have been provided. This energy conservation feature may cause an inconvenience during warmer times of the year. During warm periods of the year, the temperature within the equipment compartment can elevate to a point that the pump will automatically turn off for a short amount of time (15-30 minutes) to allow the pump to cool down before automatically restarting. This cool down feature will not harm your spa, but serves only to protect the pump from damage and as an indicator that it is too hot. To minimize this occurrence, refrain from using your Hydrotherapy Jets for prolonged periods of time during warm seasons. The jet pump chosen for your spa has been specifically sized for maximum performance and your Hydrotherapy enjoyment.

## Filtration System

Please refer to your Spa Manufacturer's Owner's Manual regarding the operation, maintenance and cleaning of your filtration system.

**IMPORTANT - Heater pump must provide a minimum flow of 23 GPM through heater.**

## Winterizing

When freezing weather and/or power losses are expected, contact your local spa dealer for freeze protection or winterizing recommendations for both the spa and the equipment system. Freeze related damage is not covered by the warranty.

## Chemical Water Treatment

Your dealer is familiar with local water conditions and which chemicals are compatible with and designed specifically for your spa. This is the best person to advise you on proper water quality management. The one thing you can do to insure years of trouble free equipment operations is to maintain proper water chemistry.

Two basic goals of the chemical water treatment are sanitizing and balancing the water. Sanitizing simply means keeping the water free from microorganisms including algae, bacteria and viruses. The current most popular chemicals for sanitizing include chlorine, bromine and ozone.

Balancing water means establishing a balance among pH, total alkalinity and total hardness. Water that is unbalanced can corrode the spa and its support equipment or leave deposits of minerals. Properly balanced water is essential to allow the sanitizing chemical to work effectively. There are numerous chemical additives to help you in controlling pH, total hardness and alkalinity. Never use softened water when filling your spa. Softened water is extremely corrosive to the metal parts of the spa equipment and may lead to an unforeseen failure. Sometimes, despite your most diligent efforts, your water may become too far out of balance to be managed chemically. At this point it is probably better to drain and clean the spa and start over with fresh water. Equipment failure caused by improper water chemistry will not be covered under warranty. Saltwater purification systems can potentially damage your equipment. Any related failures will not be covered under warranty.

# System Functions / Features

## Spaside Control



**Pump 1 Key:** Pressing this key when the pump is OFF will turn it ON to Low Speed, a second press switches the pump to High speed, a third press turns the pump OFF. If the pump is ON from manual activation, the pump low speed will time out after 30 minutes and the high speed will time out after 15 minutes. If the pump cannot be turned OFF a filter cycle is active.



**Pump 2 Key:** Press this key to turn Pump 2 ON and OFF. An automatic timer will turn the pump off after 15 minutes of operation. Jet 2 indicator will illuminate when it is active.



**Blower / AUX Key:** Press this key to turn the blower ON and OFF. An automatic timer will turn the blower off after 15 minutes of operation.



**Light Key:** Press this key to turn the light ON and OFF. An automatic timer will turn the light off after 4 hours of operation. The Light indicator will illuminate when it is active.



**Temperature Set Keys:** Press the “Cool/Down” button or “Warm/Up” button to display the current set water temperature. Pressing either button while the set temperature is displayed will increase or decrease the set temperature by 1°F. The temperature is adjustable between 80°F - 104°F / 26°C - 40°C or 50°F - 99°F / 10°C - 37°C. See Dual Temp Range page 19

## Filtration and Ozone\*\*

On non-circ systems, Pump 1 low and the ozone generator will run during filtration. On circ systems, the ozone will run with the circ pump.

The system is factory-programmed with one filter cycle that will run in the evening (assuming the time-of day is properly set) when energy rates are often lower. The filter time and duration are programmable. A second filter cycle can be enabled as needed.

At the start of each filter cycle, the blower (if there is one) or Pump 2 (if there is one) will run briefly to purge its plumbing to maintain good water quality.

## Freeze Protection

If the temperature sensors within the heater detect a low enough temperature (44°F), then the pump(s) and blower automatically activate to provide freeze protection. The pump(s) and blower will run either continuously or periodically depending on conditions.

**\*\*See provided Spaside Control Operation Guide for programming procedures.**

# System Functions / Features

## Dual Temperature Ranges\*\*

---

This system incorporates two temperature range settings with independent set temperatures. The High Range designated in the display by an “up” arrow or “High Range”, and the Low Range designated in the display by a “down” arrow or “Low Range”.

These ranges can be used for various reasons, with a common use being a “ready to use” setting vs. a “vacation” setting. The Ranges are chosen using the menu structure. Each range maintains its own set temperature as programmed by the user. This way, when a range is chosen, the spa will heat to the set temperature associated with that range.

*High Range may be set between 80°F and 104°F*

*Low Range may be set between 50°F and 99°F*

*Freeze Protection is active in either range*

## Mode – Ready and Rest\*\*

---

In order for the spa to heat, a pump needs to circulate water through the heater. The pump that performs this function is known as the “heater pump.”

**READY MODE** - Will circulate water every 1/2 hour, using Pump1 Low, in order to maintain a constant water temperature, heat as needed, and refresh the temperature display. This is known as “polling.” “Ready” will be displayed.

**REST MODE** - Will only allow heating during programmed filter cycles. The temperature display may not show a current temperature until the heater pump had been running for a minute or two. “REST” will be displayed.

**READY-IN-REST MODE** - Appears in the display if the spa is in Rest Mode and Jet 1 is pressed. It is assumed that the spa is being used and will heat to set temperature. While Pump 1 High can be turned ON and OFF, Pump 1 Low will run until set temperature is reached, or 1 hour has passed. After 1 hour, the system will revert to Rest Mode. This mode can also be reset by entering the Mode Menu and changing the Mode.

## Time of Day\*\*

---

Setting the time-of-day can be important in determining filtration times and other background features.

### **NOTE:**

If power is interrupted to the system, Time-of-Day is not stored. The system will still operate and all other user settings will be stored. If filtered cycles are required to run at a particular time of day, resetting the clock will return the filter times to the actual programmed periods.

**\*\*See provided Spaside Control Operation Guide for programming procedures.**

# System Plug Pinouts

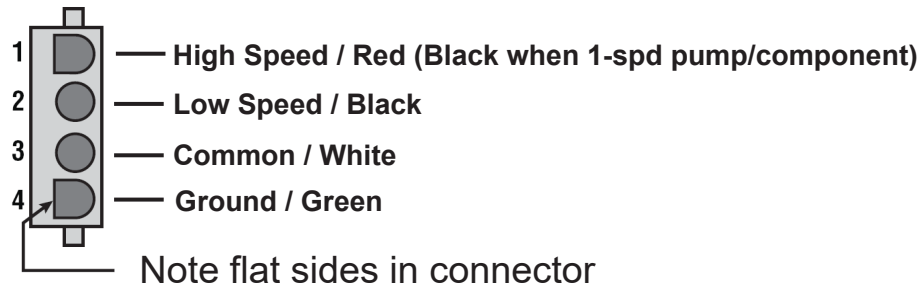

## Testing / Replacing the Sensor Set

**IMPORTANT:** For the following set of instruction, the power must be off when plugging in or unplugging sensors.

- 1) Check sensor wires for cracks or damage that may indicate the presence of a rodent.
- 2) Inspect connections of both sensors on the circuit board. The plugs must be clean.
- 3) If the spaside has the error message of Sa or Sb, this is an indication of a faulty sensor or possibly a faulty circuit board.
- 4) With the power off to the spa, unplug the two sensors from the circuit board and exchange their positions (i.e., plug the one that was in the “Sen. A jack and vice versa).
- 5) Power up the spa, if the error message did not change (i.g. original error message was Sa and still displays Sa) this is an indication of a faulty circuit board. If the error message changed (i.g., original error message was Sa and now displays Sb) replace the sensor in the corresponding plug on the circuit board.
- 6) When replacing sensors, please keep in mind that the heater assembly will contain water pressure even with the spa’s power off. Close available slice valves and proceed with caution not to allow water on the surrounding electronics.

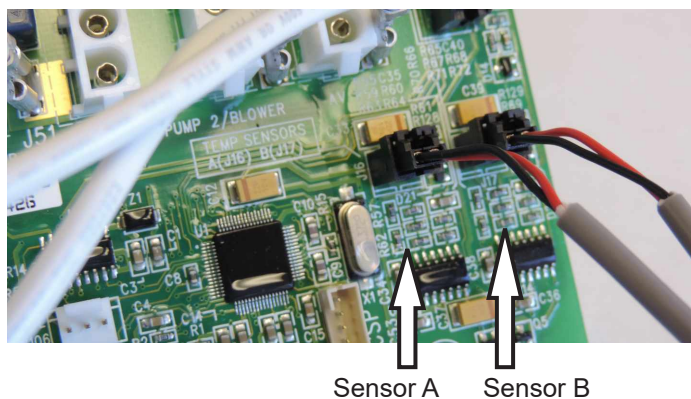



# Troubleshooting

The following describes situations and possible solutions to common problems you may encounter as a spa owner.

## Nothing Operates

- Main Breaker is OFF - *Set to On.*
- Sub-Panel Breaker Off - *Set to On.*
- Equipment GFCI Off - *Set to On.*
- Power switch in Off position - *Set to On.*
- Components not plugged in - *Plug in components.*
- Power cord not plugged in - *Plug in power cord.*
- Over or High Temperature Protection On - *Refer to Spa Side Messages.*

## No, Low or Surging Water Flow

- Air Lock in Plumbing System - *“Bleed” the system.*
- Restricted Flow - *Insure that the water shut-off valves are open and that suction fittings are not blocked by debris.*
- Dirty Filter - *Clean or replace filter.*
- Low Water Level - *Increase water level to recommended level.*

## Low Speed Pump Not Operational

- Circuit board configuration is Incorrect - *Contact your local dealer.*
- Pump Not Plugged-In - *Plug in the Pump.*
- Blown Fuse - *Contact your local dealer.*

## Jets or Blower Not Operational

- Blower or Pump Not Plugged-In - *Plug in the Blower or Pump.*
- Blown Fuse - *Contact your local dealer.*
- Over or High Temperature Protection On - *Refer to Spa Side Messages.*

# Troubleshooting

## Therapy Jet Not Operational

- Water Shut-Off Valves are Closed - *Open Shut-Off valves.*
- Dirty Filter - *Clean or replace filter.*
- Jets Not Properly Adjusted - *Adjust Jets properly.*
- Diverter Valve Not Properly Adjusted - *Adjust diverter valve properly.*
- Thermal Overload Tripping - *Check for restricted flow of water.*

## Water Leaks

- Spa Overfilled - *Adjust water level.*
- Too Many People in the Spa - *Adjust water level.*
- Drain-Valve Left Open - *Close drain valve.*
- Couplings or Unions Loose - *Tighten or contact your local dealer.*
- Pump Seal Leaking - *Contact your local dealer.*
- Plumbing / Connections Leaking - *Contact your local dealer.*
- Water Leaking from Spaside Control - *Contact your local dealer.*
- Water in Air Blower Plumbing - *Contact your local dealer.*

## No Heat

- Temperature Not Set Correctly - *Adjust Set Point.*
- Over or High Temperature Protection On - *Refer to Spa Side Messages*
- Current Limiting On - *120V Systems will not heat if High Speed or Blower is on. Contact your local dealer.*
- No Power - *Reset breaker at service panel.*
- Low Water Flow - *Clean or Replace filter.*
- System is in Rest Mode - *Refer to Modes on page 19.*

## Light Not Operation

- Light Bulb Defective - *Replace bulb or contact your local dealer.*
- Reflector has Fallen Off - *Replace deflector or contact your local dealer.*
- Light Not Plugged-In - *Plug in the Light.*

## High Heat

- Filter Cycles Running Too Long - *Adjust filter cycles down.*
- Temperature Set Too High - *Adjust Set Point.*
- High Ambient Temperature - *Remove spa cover.*

## GFCI Breaker Trips Occasionally

- Lightning / Electrical Storm or Power Surge - *Reset GFCI Breaker.*
- NOTE: The GFCI breaker must be properly installed by a licensed electrician.

## GFCI Breaker Trips Immediately

- Defective Component or Improper GFCI Breaker Installation - *Contact a qualified service technician or the factory for assistance.*

# System Data Label

**Note:** This information will be necessary if you should ever have to request warranty or any other type of service.

The system data label is located on the control box. This label is very important and contains information you will need to establish your electrical service. The voltage and amperage ratings are shown on the bottom of the label. Product, Model, Serial and Code numbers are also shown on the label.



REFER TO NEC FOR  
BREAKER SIZING

ORDER CODE: **CS6200-U**  
MODEL: **Z2EKX0L-0505GE0**  
SERIAL:  
CODE: **HYD0D-6801-**  
VOLTS: **120 240**  
AMPS: **16 40-48**  
PRODUCT: **HQ 7000**  
**1 PHASE - 60Hz**



# Warranty Information

Hydro-Quip warrants its products to the original purchaser to be free from defects in material and workmanship for a period of 1 year (12 months) from the original date of purchase, except as noted below.

Products which become defective within the warranty period will be repaired or replaced (at the option of Hydro-Quip) except for damage due to freezing, water chemistry, negligence, abuse, misuse, misapplication, unauthorized modification, improper installation, normal wear and tear or chemical attack.

This warranty extends only to normal, personal (non-commercial) usage by the original purchaser. Pump seals, o-rings, gaskets, air blower brushes are only covered for 90 days from original date of purchase.

Hydro-Quip will not be responsible for labor incurred in removing, inspecting or reinstalling of warrantable products. Hydro-Quip will not be responsible for any travel related charges or labor costs attributable to disassembly and reassembly of the spa, skirt, decking or any other materials enclosing the product, or attributable to difficulties in gaining access to the product.

Hydro-Quip will not be responsible for labor incurred for routine maintenance, adjustments or alterations to the calibration of electrical devices.

Any products which are claimed to be defective must be shipped freight prepaid to Hydro-Quip and the repaired or replaced product will be returned to the sender freight collect. When sent to Hydro-Quip, the product must be accompanied by the sales receipt or other proof of the purchase date as well as the sender's name, mailing address, daytime phone number and a detailed description of the defect as well as any other information relating to this claim.

Unless state law expressly provides otherwise, Hydro-Quip will only be responsible for repair or replacement of any of its products that are found to be defective as provided above, and will not bear the cost of any consequential damages. This warranty gives you specific legal rights but you may have other rights which vary from state to state.

