

Instruction manual

**AQUACIAT<sup>CALÉO</sup>**

**High-temperature heat pumps**



10198

08 - 2017

# Contents

<b>1 - INTRODUCTION</b> .....	<b>4</b>
1.1 - Check equipment received .....	4
1.2 - Installation safety considerations .....	4
1.3 - Equipment and components under pressure .....	5
1.4 - Maintenance safety considerations.....	5
1.5 - Repair safety considerations.....	6
<b>2 - PRELIMINARY CHECKS</b> .....	<b>8</b>
2.1 - Check equipment received .....	8
2.2 - Moving and siting the unit .....	8
2.3 - Checks before system start-up .....	8
2.4 - Lifting labels.....	9
<b>3 - DIMENSIONS, CLEARANCES</b> .....	<b>10</b>
3.1 - TD 070-100 .....	10
3.2 - TD 120-150.....	11
3.3 - TD 200-300.....	12
3.4 - TD 100 + XtraFan option .....	13
3.5 - TD 120-150 + XtraFan option .....	14
3.6 - TD 200-300 + XtraFan option .....	13
3.7 - Multiple-unit installation .....	13
<b>4 - PHYSICAL DATA</b> .....	<b>14</b>
<b>5 - ELECTRICAL DATA</b> .....	<b>15</b>
5.1 - Compressor usage and electrical data for standard units .....	15
5.2 - Short-circuit stability current (TN system <sup>(1)</sup> ) - standard unit (with main disconnect without fuse).....	15
<b>6 - APPLICATION DATA</b> .....	<b>17</b>
6.1 - Unit operating range .....	17
6.2 - Plate heat exchanger water flow .....	17
6.3 - Minimum water flow rate .....	17
6.4 - Maximum plate heat exchanger water flow rate .....	17
6.5 - Water loop volume .....	18
6.6 - Plate heat exchanger pressure drop curves.....	18
<b>7 - ELECTRICAL CONNECTION</b> .....	<b>19</b>
7.1 - Power supply .....	19
7.2 - Voltage phase imbalance (%) .....	19
7.3 - Recommended wire sections.....	19
7.4 - Field control wiring .....	19
7.5 - Power supply .....	19
7.6 - 24 V user power reserve .....	20
<b>8 - WATER CONNECTIONS</b> .....	<b>21</b>
8.1 - Operating precautions and recommendations .....	21
8.2 - Hydraulic connections.....	21
8.3 - Frost protection.....	21
8.4 - Protection against cavitation .....	23
<b>9 - NOMINAL SYSTEM WATER FLOW CONTROL</b> .....	<b>25</b>
9.1 - General .....	25
9.2 - Water flow control procedure (fixed speed).....	25
9.3 - Water flow control procedure (variable speed) .....	25
9.4 - Available system pressure .....	26
<b>10 - START-UP</b> .....	<b>27</b>
10.1 - Preliminary checks.....	27
10.2 - Actual start-up.....	27
10.3 - Operation of two units in master/slave mode.....	27
10.4 - Supplementary electric resistance heaters .....	28

<b>11 - MAJOR SYSTEM COMPONENTS .....</b>	<b>29</b>
11.1 - Compressors .....	29
11.2 - Lubricant.....	29
11.3 - Air evaporators.....	29
11.4 - Fans.....	29
11.5 - Electronic expansion valve (EXV) of the main circuit.....	29
11.6 - Electronic expansion valve (EXV) of the economised circuit.....	29
11.7 - Four-way valve .....	29
11.8 - Moisture indicator .....	29
11.9 - Filter drier.....	29
11.10 - Condenser.....	29
11.11 - Economiser.....	29
11.12 - Refrigerant .....	30
11.13 - High-pressure safety switch.....	30
<b>12 - OPTIONS AND ACCESSORIES .....</b>	<b>31</b>
<b>13 - UNITS WITH FANS WITH AVAILABLE PRESSURE FOR INDOOR INSTALLATION XTRAFAN .....</b>	<b>32</b>
13.1 - Fan discharge connection .....	32
13.2 - Applicable rules for units incorporated into an air duct system.....	32
13.3 - Electrical data for TD units with XtraFan.....	32
<b>14 - STANDARD MAINTENANCE .....</b>	<b>33</b>
14.1 - Level 1 maintenance .....	33
14.2 - Level 2 maintenance .....	33
14.3 - Level 3 (or higher) maintenance.....	33
14.4 - Tightening torques for the main electrical screw connections .....	34
14.5 - Tightening torques for the main bolts and screws .....	34
14.6 - Evaporator coil.....	34
14.7 - Condenser maintenance.....	34
14.8 - Characteristics of R-407C.....	35
<b>15 - START-UP CHECKLIST FOR TD HEAT PUMPS (USE FOR JOB FILE) .....</b>	<b>36</b>

# 1 - INTRODUCTION

Prior to the initial start-up of the Aquaciat Caléo TD units, the people involved should be thoroughly familiar with these instructions and the specific project data for the installation site.

The Aquaciat Caléo TD heat pumps are designed to provide a very high level of safety and reliability making installation, start-up, operation and maintenance easier and more secure. They will provide safe and reliable service when operated within their application range.

They are designed for an operating life of 15 years by assuming a 75% utilisation factor; that is approximately 100,000 operating hours.

The procedures in this manual are arranged in the sequence required for machine installation, start-up, operation and maintenance.

Be sure you understand and follow the procedures and safety precautions contained in the instructions supplied with the machine, as well as those listed in this guide, such as: protective clothing such as gloves, safety glasses, safety shoes and appropriate tools, and suitable qualifications (electrical, air conditioning, local legislation).

To find out, if these products comply with European directives (machine safety, low voltage, electromagnetic compatibility, equipment under pressure, etc.) check the declarations of conformity for these products.

## 1.1 - Check equipment received

- Inspect the unit for damage or missing parts. If damage is detected, or if shipment is incomplete, immediately file a claim with the shipping company.
- Confirm that the unit received is the one ordered. Compare the name plate data with the order.
- The name plate is attached to the unit in two locations:
  - on the outside on one of the unit sides
  - on the control box door on the inside
- This shows the following information:
  - Model number - size
  - CE marking
  - Serial number
  - Year of manufacture and pressure and leak tightness test date
  - Refrigerant used
  - Refrigerant charge per circuit
  - PS: Min./max. allowable pressure (high and low pressure side)
  - TS: Min./max. allowable temperature (high and low pressure side)
  - Pressure switch cut-out pressure
  - Unit leak test pressure
  - Voltage, frequency, number of phases
  - Maximum current drawn
  - Maximum power input
  - Unit net weight
- Confirm that all accessories ordered for on-site installation have been supplied, are complete and undamaged.

**The unit must be checked periodically, if necessary removing the insulation (thermal, acoustic), during its whole operating life to ensure that no shocks (handling accessories, tools, etc.) have damaged it. If necessary, the damaged parts must be repaired or replaced. See also chapter "Maintenance".**

## 1.2 - Installation safety considerations

After the unit has been received, when it is ready to be installed or reinstalled, and before it is started up, it must be inspected for damage. Check that the refrigerant circuits are intact, especially

that no components or pipes have shifted or been damaged (e.g. following a shock). If in doubt, carry out a leak tightness check. If damage is detected upon receipt, immediately file a claim with the shipping company.

This machine must be installed in a location that is not accessible to the public and protected against access by non-authorized people.

**Do not remove the skid or the packaging until the unit is in its final position. These units can be moved with a fork lift truck, as long as the forks are positioned in the right place and direction on the unit.**

**The units can also be lifted with slings, using only the designated lifting points marked on the unit (labels on the chassis and a label with all unit handling instructions are attached to the unit tank - refer to chapter 2.4).**

**Use slings with the correct capacity, and always follow the lifting instructions on the certified drawings supplied for the unit.**

**Safety is only guaranteed, if these instructions are carefully followed. If this is not the case, there is a risk of material deterioration and injuries to personnel.**

**These units are not designed to be lifted from above.**

**DO NOT COVER ANY PROTECTION DEVICES.**

**This applies to fuse plugs and relief valve (if used) in the refrigerant or heat transfer medium circuits. Check if the original protection plugs are still present at the valve outlets. These plugs are generally made of plastic and should not be used. If they are still present, please remove them. Install devices at the valve outlets or drain piping that prevent the penetration of foreign bodies (dust, building debris, etc.) and atmospheric agents (water can form rust or ice). These devices, as well as the drain piping, must not impair operation and not lead to a pressure drop that is higher than 10% of the control pressure.**

**Ensure that the valves are correctly installed, before operating the unit.**

### Classification and control

**In accordance with the Pressure Equipment Directive and national usage monitoring regulations in the European Union the protection devices for these machines are classified as follows:**

	Safety accessory <sup>(1)</sup>	Over pressure protection in case of an external fire <sup>(2)</sup>
<b>Refrigerant side</b>		
High-pressure switch	x	
External relief valve <sup>(3)</sup>		x
Rupture disk		x
Fuse plug		x
<b>Heat transfer fluid side</b>		
External relief valve	(4)	(4)

- (1) Classified for protection in normal service situations.
- (2) Classified for protection in abnormal service situations. These accessories are sized for fires with a thermal flow of 10kW/m<sup>2</sup>. No combustible matter should be placed within 6.5m of the unit.
- (3) The instantaneous over-pressure limitation to 10% of the operating pressure does not apply to this abnormal service situation. The control pressure can be higher than the service pressure. In this case, either the design temperature or the high-pressure switch ensures that the service pressure is not exceeded in normal service situations.
- (4) The classification of these relief valve must be made by the personnel that completes the whole hydraulic installation.

**Do not remove these valves and fuses, even if the fire risk is under control for a particular installation. There is no guarantee that the accessories are re-installed if the installation is changed or for transport with a gas charge.**

# 1 - INTRODUCTION

When the unit is subjected to fire, safety devices prevent rupture due to over-pressure by releasing the refrigerant. The fluid may then be decomposed into toxic residues when subjected to the flame:

- Stay away from the unit.
- Set up warnings and recommendations for personnel in charge to stop the fire.
- Fire extinguishers appropriate to the system and the refrigerant type must be easily accessible.

All factory-installed relief valve are lead-sealed to prevent any calibration change.

The external relief valve must always be connected to drain pipes for units installed in a closed room. Refer to the installation regulations, for example those of European standard EN 378 and EN 13136.

These pipes must be installed in a way that ensures that people and property are not exposed to refrigerant leaks. As the fluids can be diffused in the air, ensure that the outlet is far away from any building air intake, or that they are discharged in a quantity that is appropriate for a suitably absorbing environment. Relief valve must be checked periodically. See paragraph “Repair safety considerations”.

If the relief valves are installed on a reversing valve (changeover), this is equipped with a relief valve on each of the two outlets. Only one of the two relief valve is in operation, the other one is isolated. Never leave the reversing valve in the intermediate position, i.e. with both ways open (locate the control element in the stop position). If a relief valve is removed for checking or replacement please ensure that there is always an active relief valve on each of the reversing valves installed in the unit.

Provide a drain in the drain pipe, close to each relief valve, to avoid an accumulation of condensate or rain water.

All precautions concerning handling of refrigerant must be observed in accordance with local regulations.

Accumulation of refrigerant in an enclosed space can displace oxygen and cause asphyxiation or explosions.

Inhalation of high concentrations of vapour is harmful and may cause heart irregularities, unconsciousness, or death. Vapour is heavier than air and reduces the amount of oxygen available for breathing. These products cause eye and skin irritation. Decomposition products can be hazardous.

## 1.3 - Equipment and components under pressure

These products incorporate equipment or components under pressure, manufactured by CIAT or other manufacturers. We recommend that you consult your appropriate national trade association or the owner of the equipment or components under pressure (declaration, re-qualification, retesting, etc.). The characteristics of this equipment/these components are given on the nameplate or in the required documentation, supplied with the products.

The units are intended to be stored and operate in an environment where the ambient temperature must not be less than the lowest allowable temperature indicated on the nameplate.

Do not introduce significant static or dynamic pressure with regard to the operating pressures used during operation or for tests in the refrigerant circuit or in the heat exchange circuits.

## 1.4 - Maintenance safety considerations

CIAT recommends the following drafting for a logbook (the table below should not be considered as reference and does not involve CIAT responsibility):

Intervention		Name of the commissioning engineer	Applicable national regulations	Verification Organism
Date	Nature <sup>(1)</sup>			

(1) Maintenance, repairs, regular verifications (EN 378), leakage, etc.

Engineers working on the electric or refrigeration components must be authorized, trained and fully qualified to do so (e.g. electricians trained and qualified in accordance with IEC 60364 Classification BA4).

All refrigerant circuit work must be carried out by a trained person, fully qualified to work on these units. He must have been trained and be familiar with the equipment and the installation. All welding operations must be carried out by qualified specialists.

TD units use refrigerant R-407C. Special equipment must be used when working on the refrigerant circuit (pressure gauge, charge transfer, etc.).

**Any manipulation (opening or closing) of a shut-off valve must be carried out by a qualified and authorised engineer, observing applicable standards (e.g. during draining operations). The unit must be switched off while this is done.**

During any handling, maintenance and service operations the engineers working on the unit must be equipped with safety gloves, glasses, shoes and protective clothing.

Never work on a unit that is still energized. Never work on any of the electrical components, until the general power supply to the unit has been cut.

If any maintenance operations are carried out on the unit, lock the power supply circuit in the open position and secure the machine upstream with a padlock.

If the work is interrupted, always ensure that all circuits are still deenergized before resuming the work.

**ATTENTION:** Even if the unit has been switched off, the power circuit remains energized, unless the unit or circuit disconnect switch is open, and remote start-up is still possible.

Refer to the wiring diagram for further details. Attach appropriate safety labels.

If any work is carried out in the fan area, specifically if the grilles or casings have to be removed, cut the power supply to the fans to prevent their operation. It is also recommended to block the rotation of the blades during the work.

It is recommended to install an indicating device to show if part of the refrigerant has leaked from the valve. The presence of oil at the outlet orifice is a useful indicator that refrigerant has leaked. Keep this orifice clean to ensure that any leaks are obvious. The calibration of a valve that has leaked is generally lower than its original calibration. The new calibration may affect the operating range. To avoid nuisance tripping or leaks, replace or re-calibrate the valve.

# 1 - INTRODUCTION

## OPERATING CHECKS:

### Important information regarding the refrigerant used:

This product contains fluorinated greenhouse gas covered by the Kyoto protocol.

Fluid type: R407C

Global Warming Potential (GWP): 1774



1. Any intervention on the refrigerant circuit of this product should be performed in accordance with the applicable legislation. In the EU, the regulation is called F-Gas, N°517/2014.
2. Ensure that the refrigerant is never released to the atmosphere during installation, maintenance or equipment disposal.
3. The deliberate gas release into the atmosphere is not allowed.
4. If a refrigerant leak is detected, ensure that it is stopped and repaired as quickly as possible.
5. Only a qualified and certified personnel can perform installation operations, maintenance, refrigerant circuit leak test as well as the equipment disposal and the refrigerant recovering.
6. The gas recovery for recycling, regeneration or destruction is at customer charge.
7. Periodic leak tests have to be carried out by the customer or by third parties. The EU regulation set the periodicity here after:

System WITHOUT leakage detection	No Check	12 Months	6 Months	3 Months	
System WITH leakage detection	No Check	24 Months	12 Months	6 Months	
Refrigerant charge/ circuit (CO <sub>2</sub> equivalent)	< 5 Tons	5 ≤ Charge < 50 Tons	50 ≤ Charge < 500 Tons	Charge > 500 Tons <sup>(1)</sup>	
Refrigerant charge/ Circuit (kg)	R134A (GWP 1430)	Charge < 3.5 kg	3.5 ≤ Charge < 34.9 kg	34.9 ≤ Charge < 349.7 kg	Charge > 349.7 kg
	R407C (GWP 1774)	Charge < 2.8 kg	2.8 ≤ Charge < 28.2 kg	28.2 ≤ Charge < 281.9 kg	Charge > 281.9 kg
	R410A (GWP 2088)	Charge < 2.4 kg	2.4 ≤ Charge < 23.9 kg	23.9 ≤ Charge < 239.5 kg	Charge > 239.5 kg
	HFO's: R1234ze	No requirement			

(1) From 01/01/2017, units must be equipped with a leakage detection system



8. A logbook must be established for equipments subject to periodic leak tests. It should contain the quantity and the type of fluid present within the installation (added and recovered), the quantity of recycled fluid, regenerated or destroyed, the date and output of the leak test, the designation of the operator and its belonging company, etc.
9. Contact your local dealer or installer if you have any questions.

### Protection device checks:

- If no national regulations exist, check the protection devices on site in accordance with standard EN378: once a year for the high-pressure switches, every five years for external relief valve.

The company or organisation that conducts a pressure switch test shall establish and implement a detailed procedure to fix:

- Safety measures
- Measuring equipment calibration
- Validating operation of protective devices
- Test protocols
- Recommissioning of the equipment.

Consult CIAT Service for this type of test. CIAT mentions here only the principle of a test without removing the pressure switch:

- Verify and record the set-points of pressure switches and relief devices (valves and possible rupture discs)
- Be ready to switch-off the main disconnect switch of the power supply if the pressure switch does not trigger (avoid over-pressure or excess gas in case of valves on the high-pressure side with the recovery condensers)
- Connect a pressure gauge protected against pulsations (filled with oil with maximum pointer if mechanical), preferably calibrated (the values displayed on the user interface may be inaccurate in an instant reading because of the scanning delay applied in the control)
- Complete an HP Test as provided by the software (refer to the Control IOM for details).

If the machine operates in a corrosive environment, inspect the protection devices more frequently.

Regularly carry out leak tests and immediately repair any leaks.

Ensure regularly that the vibration levels remain acceptable and close to those at the initial unit start-up.

Before opening a refrigerant circuit, transfer the refrigerant to bottles specifically provided for this purpose and consult the pressure gauges.

Change the refrigerant after an equipment failure, following a procedure such as the one described in NF E29-795 or carry out a refrigerant analysis in a specialist laboratory.

If the refrigerant circuit remains open for longer than a day after an intervention (such as a component replacement), the openings must be plugged and the circuit must be charged with nitrogen (inertia principle). The objective is to prevent penetration of atmospheric humidity and the corrosion on the unprotected internal steel walls.

## 1.5 - Repair safety considerations

All installation parts must be maintained by the personnel in charge, in order to avoid deterioration and injury. Faults and leaks must be repaired immediately. The authorized technician must have the responsibility to repair the fault immediately. After each repair of the unit, check the operation of the protection devices and create a report of the parameter operation at 100%.

Comply with the regulations and recommendations in unit and HVAC installation safety standards, such as: EN 378 and ISO 5149.

### RISK OF EXPLOSION



Never use air or a gas containing oxygen during leak tests to purge lines or to pressurise a machine. Pressurised air mixtures or gases containing oxygen can be the cause of an explosion. Oxygen reacts violently with oil and grease.

Only use dry nitrogen for leak tests, possibly with an appropriate tracer gas.

If the recommendations above are not observed, this can have serious or even fatal consequences and damage the installation.

# 1 - INTRODUCTION

---

Never exceed the specified maximum operating pressures. Verify the allowable maximum high- and low-side test pressures by checking the instructions in this manual and the pressures given on the unit name plate.

Do not unweild or flamecut the refrigerant lines or any refrigerant circuit component until all refrigerant (liquid and vapour) as well as the oil have been transferred from the heat pump. Traces of vapour should be displaced with dry air nitrogen. Refrigerant in contact with an open flame can produce toxic gases.

The necessary protection equipment must be available, and appropriate fire extinguishers for the system and the refrigerant type used must be within easy reach.

Do not siphon refrigerant.

Avoid spilling liquid refrigerant on skin or splashing it into the eyes. Use safety goggles and safety gloves. Wash any spills from the skin with soap and water. If liquid refrigerant enters the eyes, immediately and abundantly flush the eyes with water and consult a doctor.

The accidental releases of the refrigerant, due to small leaks or significant discharges following the rupture of a pipe or an unexpected release from a relief valve, can cause frostbites and burns to personnel exposed. Do not ignore such injuries. Installers, owners and especially service engineers for these units must:

- Seek medical attention before treating such injuries.
- Have access to a first-aid kit, especially for treating eye injuries.

We recommend to apply standard EN 378-3 Annex 3.

Never apply an open flame (blowlamp) or overheated steam (high-pressure cleaner) to the refrigerant circuit. Dangerous overpressure can result.

During refrigerant removal and storage operations follow applicable regulations. These regulations, permitting conditioning and recovery of halogenated hydrocarbons under optimum quality conditions for the products and optimum safety conditions for people, property and the environment are described in standard NF E29-795.

Refer to the certified dimensional drawings for the units.

It is dangerous and illegal to re-use disposable (non-returnable) reclaim cylinders or attempt to refill them. When reclaim cylinders are empty, evacuate the remaining gas pressure, and move them to a designated place for recovery. Do not incinerate.

Do not attempt to remove refrigerant circuit components or fittings, while the machine is under pressure or while it is running. Be sure pressure is at 0 kPa and that the unit has been shut-down and de-energised before removing components or opening a circuit.

Do not attempt to repair or recondition any safety devices when corrosion or build-up of foreign material (rust, dirt, scale, etc.) is found within the valve body or mechanism. If necessary, replace the device. Do not install relief valve in series or backwards.

**ATTENTION:** No part of the unit must be used as a walkway, rack or support. Periodically check and repair or if necessary replace any component or piping that shows signs of damage.

Do not step on refrigerant lines. The lines can break under the weight and release refrigerant, causing personal injury. Do not climb on a machine. Use a platform, or staging to work at higher levels.

Use mechanical lifting equipment (crane, hoist, winch, etc.) to lift or move heavy components. For lighter components, use lifting equipment when there is a risk of slipping or losing your balance.

Use only original replacement parts for any repair or component replacement. Consult the list of replacement parts for the specification of the original equipment.

Do not drain water circuits containing industrial brines, without informing the technical service department at the installation site or a competent body first.

Close the entering and leaving water shut-off valves and purge the unit hydraulic circuit, before working on the components installed on the circuit (screen filter, pump, water flow switch, etc.).

Periodically inspect all valves, fittings and pipes of the refrigerant and hydraulic circuits to ensure that they do not show any corrosion or any signs of leaks.

It is recommended to wear ear defenders, when working near the unit and the unit is in operation.

Always ensure you are using the correct refrigerant type before recharging the unit.

Charging any refrigerant other than the original charge type (R-407C) will impair machine operation and can even lead to a destruction of the compressors. The compressors operate with R-407C and are charged with a synthetic polyol-ester oil.

Before any intervention on the refrigerant circuit, the complete refrigerant charge must be recovered.

## 2 - PRELIMINARY CHECKS

### 2.1 - Check equipment received

- Check that the unit has not been damaged during transport and that no parts are missing. If the unit has been damaged or the shipment is incomplete, send a claim to the shipping company.
- Compare the name plate data with the order. The name plate is attached in two places to the unit:
  - On one of the unit sides on the outside
  - On the control box door on the inside.
- The unit name plate must include the following information:
  - Model number - size
  - CE marking
  - Serial number
  - Year of manufacture and pressure and leak tightness test date
  - Fluid being transported
  - Refrigerant used
  - Refrigerant charge per circuit
  - PS: Min./max. allowable pressure (high and low pressure side)
  - TS: Min./max. allowable temperature (high and low pressure side)
  - Pressure switch cut-out pressure
  - Unit leak test pressure
  - Voltage, frequency, number of phases
  - Maximum current drawn
  - Maximum power input
  - Unit net weight
- Confirm that all accessories ordered for on-site installation have been delivered, are complete and undamaged.
- The unit must be checked periodically, if necessary removing the insulation (thermal, acoustic), during its whole operating life to ensure that no shocks (handling accessories, tools, etc.) have damaged it. If necessary, the damaged parts must be repaired or replaced. See also chapter "Maintenance".

### 2.2 - Moving and siting the unit

#### 2.2.1 - Moving

See chapter 1.2 - "Installation safety considerations".

#### 2.2.2 - Siting the unit

The machine must be installed in a place that is not accessible to the public or protected against access by non-authorized persons.

**In case of extra-high units the machine environment must permit easy access for maintenance operations.**

**Always refer to the chapter "Dimensions and clearances" to confirm that there is adequate space for all connections and service operations. For the centre of gravity coordinates, the position of the unit mounting holes, and the weight distribution points, refer to the certified dimensional drawing supplied with the unit.**

**Typical applications of these units do not require earthquake resistance. Earthquake resistance has not been verified and the units are not explosion-proof.**

**CAUTION: Only use slings at the designated lifting points which are marked on the unit.**

Before siting the unit check that:

- the permitted loading at the site is adequate or that appropriate strengthening measures have been taken.
- if the heat pump is required to operate in temperatures below 0°C it must be raised at least 300 mm from the ground. This is necessary to avoid ice build-up on the unit chassis and also to permit correct unit operation in locations where the snow level may reach this height.

- the unit is installed level on an even surface (maximum tolerance is 5 mm in both axes).
- there is adequate space above the unit for air flow and to ensure access to the components (see dimensional drawings).
- the number of support points is adequate and that they are in the right places.
- the location is not subject to flooding.
- Baffles may be necessary to deflect strong winds. They must not restrict air flow into the unit.



**Before lifting the unit, check that all casing panels are securely fixed in place. Lift and set down the unit with great care. Tilting and jarring can damage the unit and impair unit operation.**

If TD units are hoisted with rigging, it is advisable to protect coils against crushing while a unit is being moved. Use struts or a lifting beam to spread the slings above the unit. Do not tilt a unit more than 15°.

**WARNING: Never push or lever on any of the enclosure panels of the unit. Only the base of the unit frame is designed to withstand such stresses.**

### 2.3 - Checks before system start-up

Before the start-up of the refrigeration system, the complete installation, including the refrigeration system must be verified against the installation drawings, dimensional drawings, system piping and instrumentation diagrams and the wiring diagrams.

For these checks national regulations must be followed. If the national regulation does not specify any details, refer to standard EN 378 as follows:

External visual installation checks:

- Ensure that the machine is charged with refrigerant, Verify on the unit nameplate that the 'fluid transported' is R407C and is not nitrogen.
- Compare the complete installation with the refrigeration system and power circuit diagrams.
- Check that all components comply with the design specifications.
- Check that all protection documents and equipment provided by the manufacturer (dimensional drawings, P&ID, declarations etc.) to comply with the regulations are present.
- Verify that the environmental safety and protection and devices and arrangements provided by the manufacturer to comply with the regulations are in place.
- Verify that all documents for pressure containers, certificates, name plates, files, instruction manuals provided by the manufacturer to comply with the regulations are present.
- Verify the free passage of access and safety routes.
- Verify the instructions and directives to prevent the deliberate removal of refrigerant gases.
- Verify the installation of connections.
- Verify the supports and fixing elements (materials, routing and connection).
- Verify the quality of welds and other joints.
- Check the protection against mechanical damage.
- Check the protection against heat.
- Check the protection of moving parts.
- Verify the accessibility for maintenance or repair and to check the piping.
- Verify the status of the valves.
- Verify the quality of the thermal insulation and of the vapour barriers.
- Ensure that the ventilation in the machine room is sufficient.
- Check the refrigerant detectors.



## 2 - PRELIMINARY CHECKS

### 2.4 - Lifting labels

TD 070 to 100

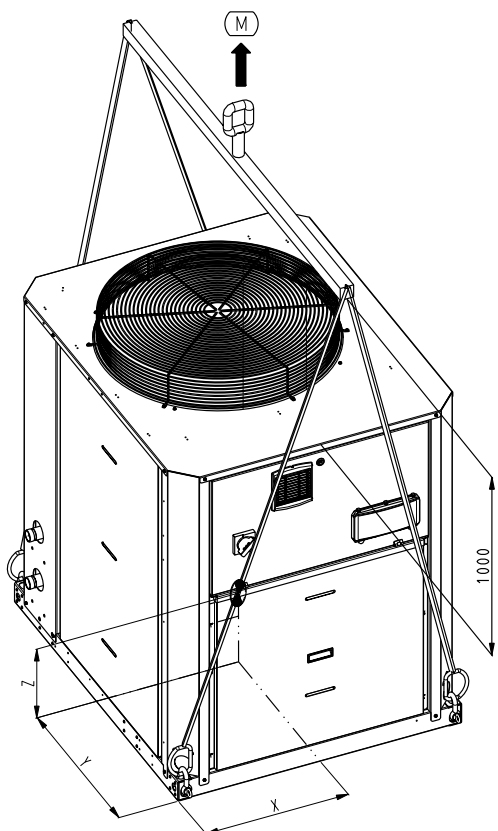

X (mm)	Y (mm)	Z (mm)
536±15	568±22	577±18

TD 120 to 150

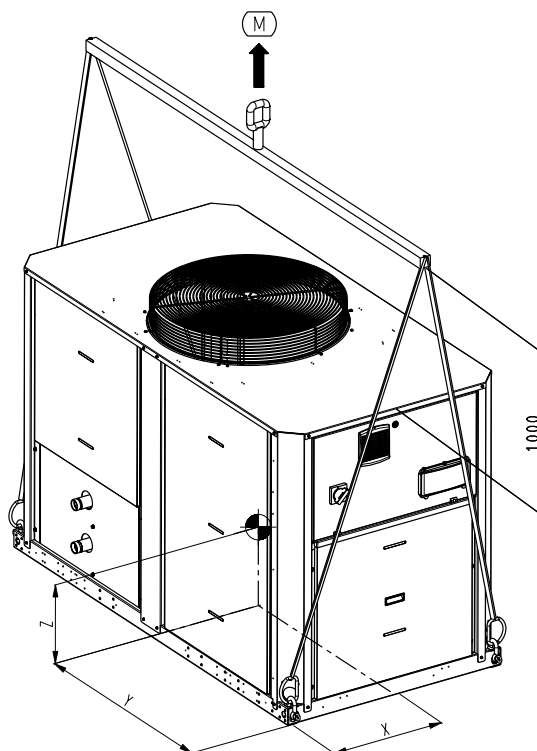

X (mm)	Y (mm)	Z (mm)
841±31	521±7	563±33

TD 200 to 300

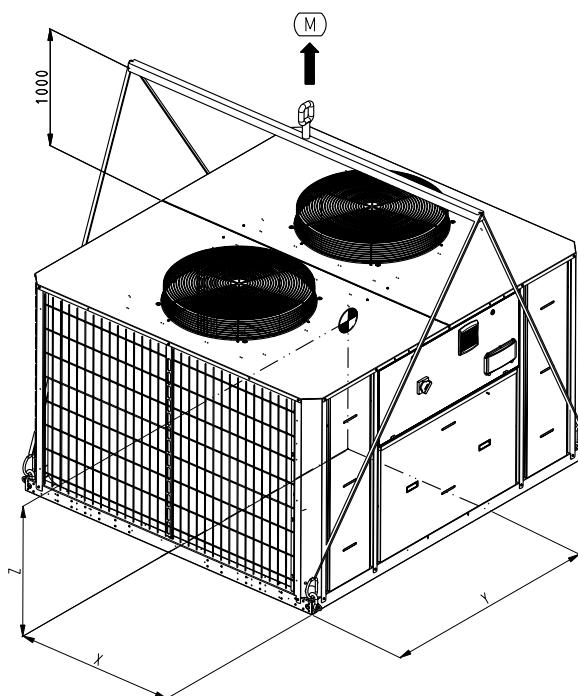

X (mm)	Y (mm)	Z (mm)
798±25	1121±2	538±36

**NOTES:**

1. Material: self-adhesive vinyl 9800
2. The symbols must be centred.
3. The symbols are black on a red background.





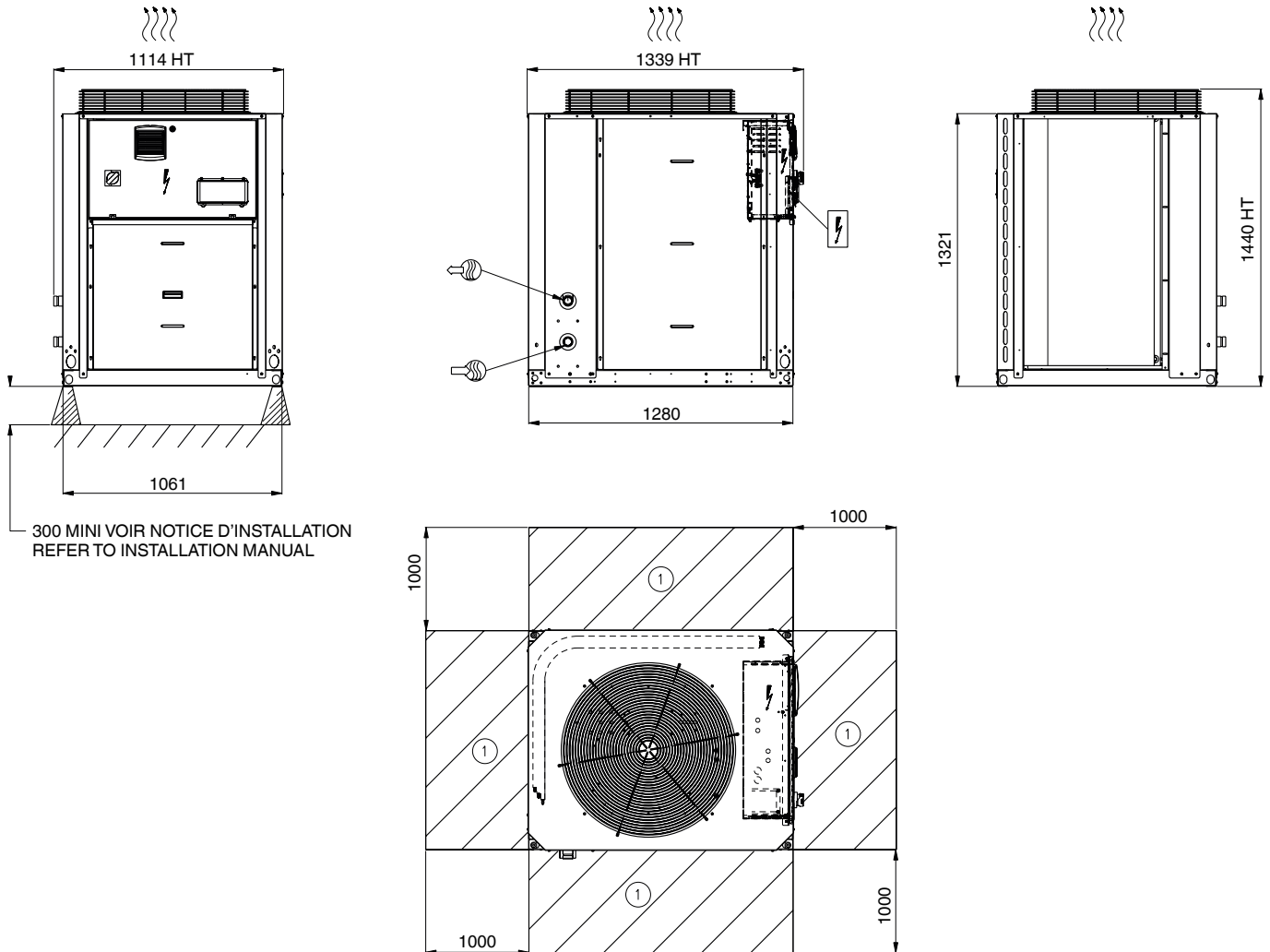

### 3 - DIMENSIONS, CLEARANCES

#### 3.1 - TD 070-100



#### Legend:

All dimensions are given in mm

-  Control box
-  Water inlet
-  Water outlet
-  Required clearances for air flow
-  Recommended clearances for maintenance
-  Air outlet, do not obstruct
-  Power cable entry

#### NOTES:

- A. Non-certified drawings.**  
Refer to the certified dimensional drawings supplied with the unit or available on request, when designing an installation. For the location of fixing points, weight distribution and coordinates of the centre of gravity refer to the certified dimensional drawings.
- B. In multiple-unit installations (maximum four units), the side clearance between the units should be increased from 1000 to 2000 mm.**
- C. The height of the solid surface must not exceed 2 m.**





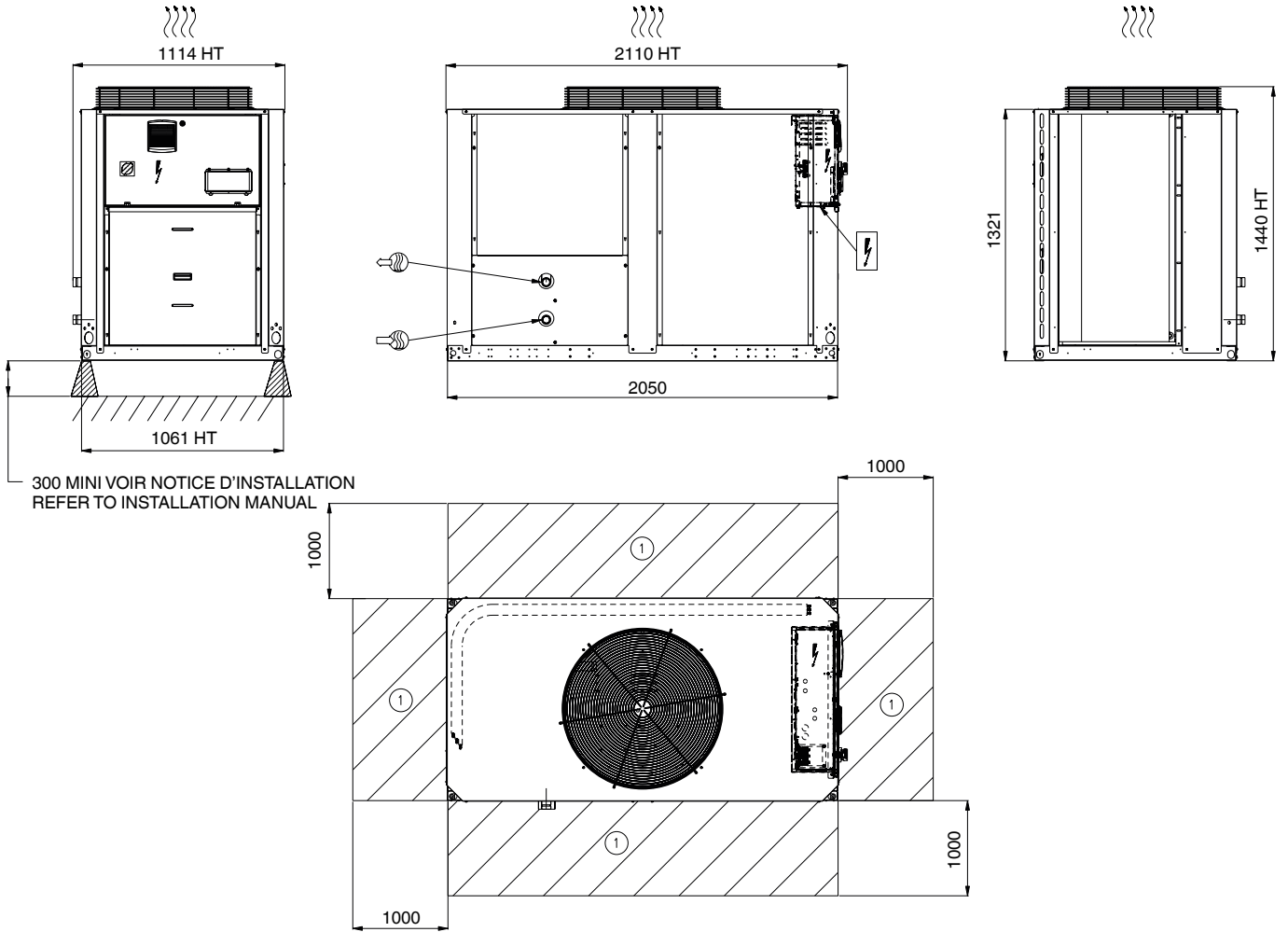

### 3 - DIMENSIONS, CLEARANCES

#### 3.2 - TD 120-150



**Legend:**

All dimensions are given in mm

-  Control box
-  Water inlet
-  Water outlet
-  Required clearances for air flow
-  Recommended clearances for maintenance
-  Air outlet, do not obstruct
-  Power cable entry

**NOTES:**

- A. Non-certified drawings.**  
Refer to the certified dimensional drawings supplied with the unit or available on request, when designing an installation. For the location of fixing points, weight distribution and coordinates of the centre of gravity refer to the certified dimensional drawings.
- B. In multiple-unit installations (maximum four units), the side clearance between the units should be increased from 1000 to 2000 mm.**
- C. The height of the solid surface must not exceed 2 m.**





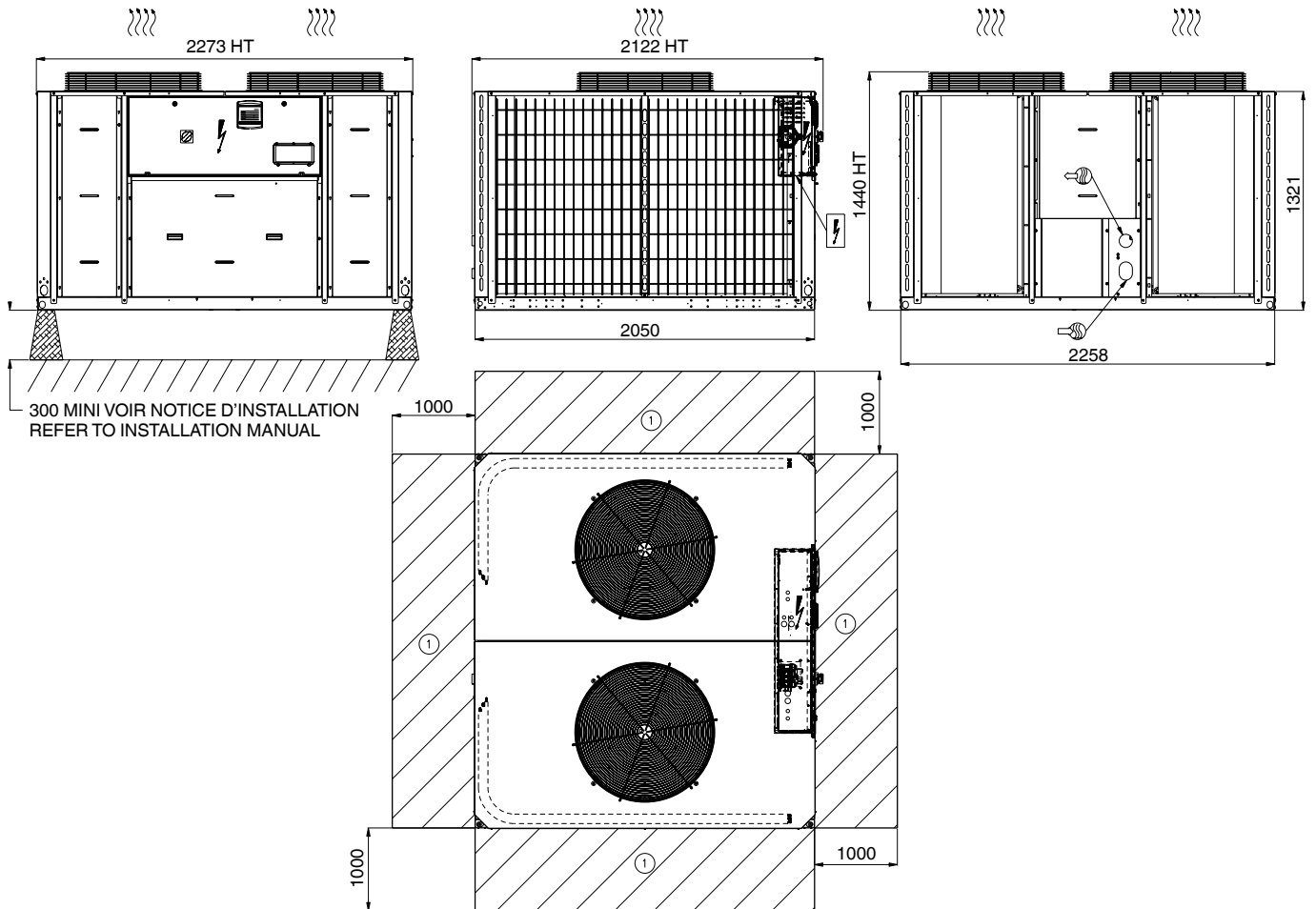

### 3 - DIMENSIONS, CLEARANCES

#### 3.3 - TD 200-300



#### Legend:

All dimensions are given in mm

-  Control box
-  Water inlet
-  Water outlet
-  Required clearances for air flow
-  Recommended clearances for maintenance
-  Air outlet, do not obstruct
-  Power cable entry

#### NOTES:

- A. Non-certified drawings.**  
Refer to the certified dimensional drawings supplied with the unit or available on request, when designing an installation. For the location of fixing points, weight distribution and coordinates of the centre of gravity refer to the certified dimensional drawings.
- B. In multiple-unit installations (maximum four units), the side clearance between the units should be increased from 1000 to 2000 mm.**
- C. The height of the solid surface must not exceed 2 m.**





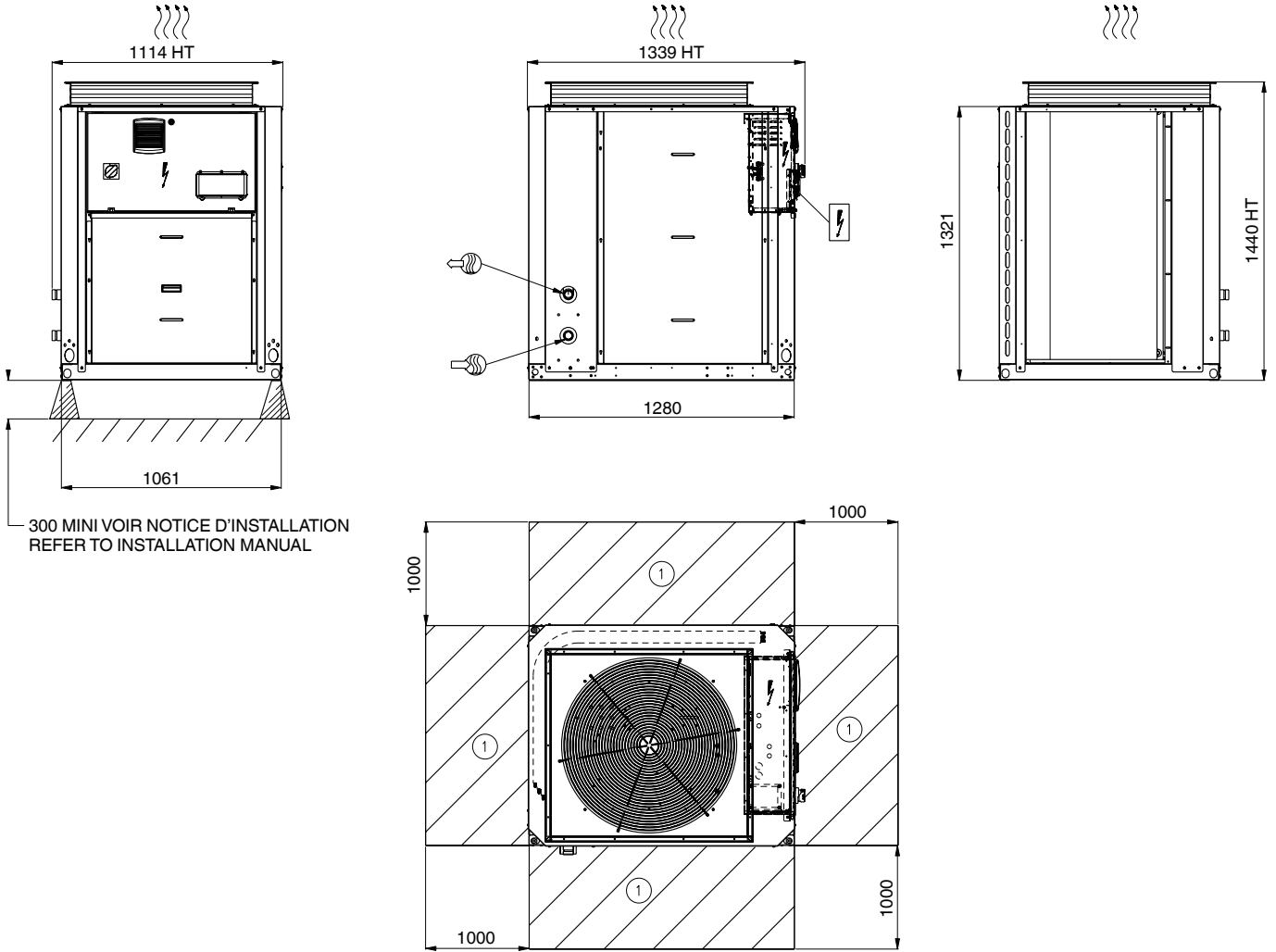

### 3 - DIMENSIONS, CLEARANCES

#### 3.4 - TD 100 + XtraFan option



**Legend:**

All dimensions are given in mm

-  Control box
-  Water inlet
-  Water outlet
-  Required clearances for air flow
-  Recommended clearances for maintenance
-  Air outlet, do not obstruct
-  Power cable entry

**NOTES:**

- A. Non-certified drawings.**  
Refer to the certified dimensional drawings supplied with the unit or available on request, when designing an installation. For the location of fixing points, weight distribution and coordinates of the centre of gravity refer to the certified dimensional drawings.
- B. In multiple-unit installations (maximum four units), the side clearance between the units should be increased from 1000 to 2000 mm.**
- C. The height of the solid surface must not exceed 2 m.**





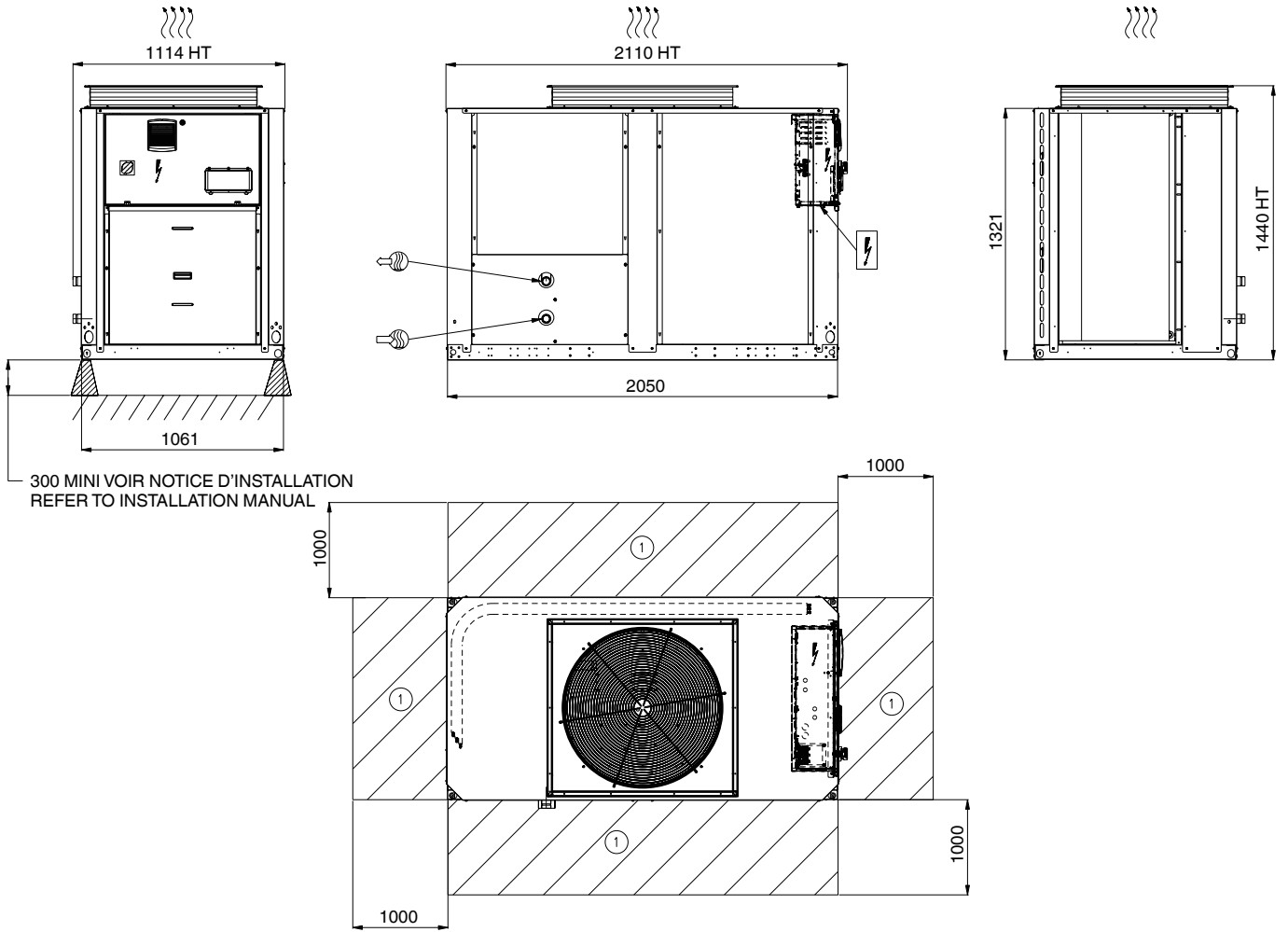

### 3 - DIMENSIONS, CLEARANCES

#### 3.5 - TD 120-150 + XtraFan option



**Legend:**

All dimensions are given in mm

-  Control box
-  Water inlet
-  Water outlet
-  Required clearances for air flow
-  Recommended clearances for maintenance
-  Air outlet, do not obstruct
-  Power cable entry

**NOTES:**

- A. Non-certified drawings.**  
Refer to the certified dimensional drawings supplied with the unit or available on request, when designing an installation. For the location of fixing points, weight distribution and coordinates of the centre of gravity refer to the certified dimensional drawings.
- B. In multiple-unit installations (maximum four units), the side clearance between the units should be increased from 1000 to 2000 mm.**
- C. The height of the solid surface must not exceed 2 m.**





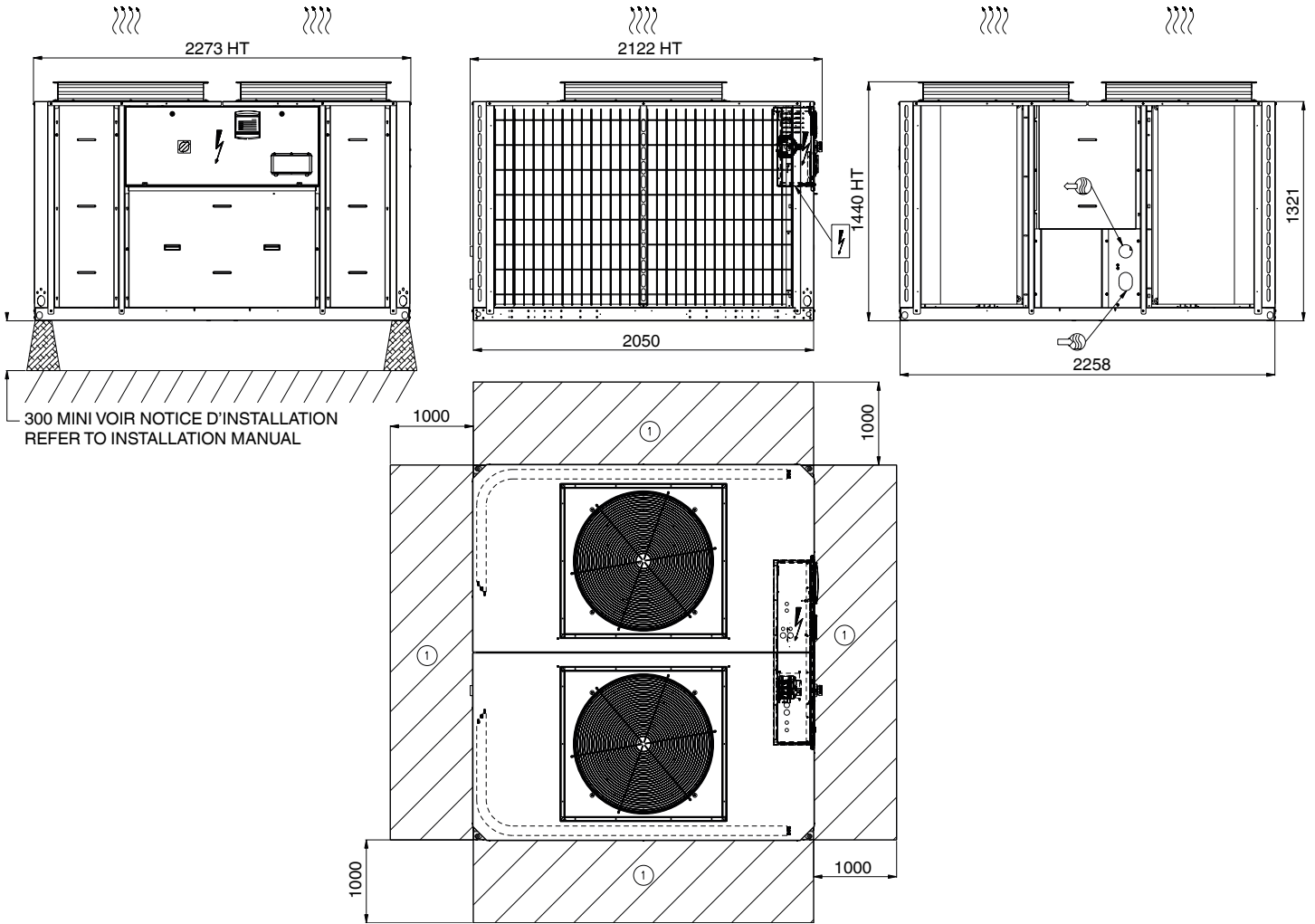

### 3 - DIMENSIONS, CLEARANCES

#### 3.6 - TD 200-300 + XtraFan option



**Legend:**

All dimensions are given in mm

-  Control box
-  Water inlet
-  Water outlet
-  Required clearances for air flow
-  Recommended clearances for maintenance
-  Air outlet, do not obstruct
-  Power cable entry

**NOTES:**

- A. Non-certified drawings.**  
Refer to the certified dimensional drawings supplied with the unit or available on request, when designing an installation. For the location of fixing points, weight distribution and coordinates of the centre of gravity refer to the certified dimensional drawings.
- B. In multiple-unit installations (maximum four units), the side clearance between the units should be increased from 1000 to 2000 mm.**
- C. The height of the solid surface must not exceed 2 m.**

#### 3.7 - Multiple-unit installation

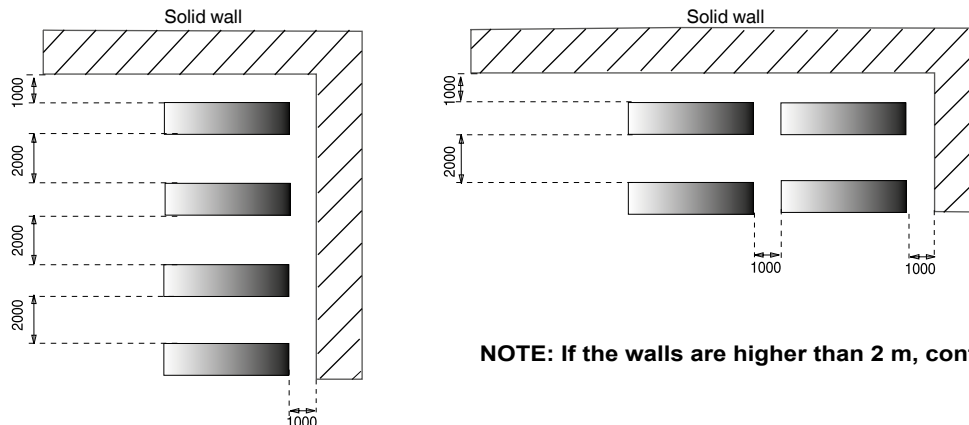

**NOTE: If the walls are higher than 2 m, contact the factory**

## 4 - PHYSICAL DATA

AQUACIAT CALEO TD		70	80	100	120	150	200	300
<b>Operating weigh <sup>(1)</sup></b>								
Standard unit	kg	362	418	435	555	579	919	1039
<b>Sound levels</b>								
Sound power level <sup>(2)</sup>	dB(A)	77	78	83	82	84	84	85
Sound pressure level at 10 m <sup>(3)</sup>	dB(A)	46	46	51	51	53	52	53
<b>Unit + option Low Noise</b>								
Sound power level <sup>(2)</sup>	dB(A)	75	76	80	80	80	82	82
Sound pressure level at 10 m <sup>(3)</sup>	dB(A)	44	44	49	48	49	50	51
<b>Unit + option Xtra Low Noise</b>								
Sound power level <sup>(2)</sup>	dB(A)			76	76	77	79	79
Sound pressure level at 10 m <sup>(3)</sup>	dB(A)			45	45	45	47	47
<b>Dimensions</b>								
Lenght	mm	1110		1114		2273		
Depth	mm	1327		2100		2100		
Height	mm	1440		1440		1440		
<b>Compressor</b>		Hermetic scroll compressors, 48,3 r/s						
Quantity		1	1	1	1	1	2	2
No. of capacity steps		1	1	1	1	1	2	2
<b>Refrigerant</b>		R407C						
Charge	kg	8	8,8	9,7	10	13,2	22	26,5
	teq CO <sub>2</sub>	14,2	15,6	17,2	17,7	23,4	39,0	47,0
<b>Oil</b>		POE - EMKARATE RL32-3 MAF						
Charge	l	1,9	4,1	4,1	4,1	4,1	8,2	8,2
<b>Capacity control</b>		Connect Touch						
Minimum capacity	%	100	100	100	100	100	50	50
<b>Condenser</b>		Direct expansion, plate heat exchanger						
Water volume	l	4,9	6,4	8,2	9,6	12,1	16,4	22,7
Max. water-side operating pressure plus hydraulic module	kPa	400	400	400	400	400	400	400
<b>Fans</b>		Axial Flying Bird IV with rotating shroud						
Quantity		1	1	1	1	1	2	2
Maximum total air flow	l/s	3770	3748	3736	4035	4036	7479	8072
Max speed, standard unit	tr/s	12	12	12	12	12	12	12
Max speed, unit with Xtrafan	tr/s	-	-	16	16	16	16	16
<b>Evaporator</b>		Grooved copper tubes and aluminium fins						
<b>Hydraulic module</b>								
Variable speed pump		Pump, Victaulic screen filter, relief valve, water + air purge valves cavitation pressure sensors						
<b>Water connections</b>		Victaulic						
Connections	inch	1"1/4	1"1/4	1"1/2	1"1/2	1"1/2	2"	2"
Outside tube diameter	mm	42,4	42,4	48,3	48,3	48,3	60,3	60,3
<b>Chassis paint colour</b>		Colour code RAL7035 and RAL7024						

(1) Weight shown is a guideline only. Please refer to the unit nameplate

(2) In dB ref=10<sup>-12</sup> W, (A) weighting. Declared dualnumber noise emission values in accordance with ISO 4871 (with an associated uncertainty of +/-2dB(A)). Measured in accordance with ISO 9614-1 and certified by Eurovent.

(3) In dB ref 20 µPa, (A) weighting. Declared dualnumber noise emission values in accordance with ISO 4871 (with an associated uncertainty of +/-2dB(A)). For information, calculated from the sound power level Lw(A).



## 5 - ELECTRICAL DATA

AQUACIAT CALEO TD		70	80	100	120	150	200	300	
<b>Power circuit</b>									
Nominal power supply	V-ph-Hz	400-3-50							
Voltage range	V	360-440							
<b>Control circuit supply</b>		24 V, via internal transformer							
<b>Maximum start-up current (Un) <sup>(1)</sup></b>									
Standard unit	A	104	102	130	172	203	158	243	
Unit with electronic starter option	A	56	54	69	92	103	97	144	
<b>Unit power factor at maximum capacity <sup>(2)</sup></b>		0,82	0,82	0,83	0,87	0,87	0,83	0,87	
<b>Maximum unit power input <sup>(2)</sup></b>		kW	10	12	16	21	25	32	48
<b>Nominal unit current draw <sup>(3)</sup></b>		A	14	16	20	25	30	42	57
<b>Maximum unit current draw (Un) <sup>(4)</sup></b>		A	17	21	27	35	41	56	79
<b>Maximum unit current draw (Un-10%) <sup>(5)</sup></b>		A	18	22	29	38	45	60	86

- (1) Maximum instantaneous start-up current (maximum operating current of the compressor + fan current + locked rotor current of the compressor).  
(2) Power input, compressor and fan, at the unit operating limits (saturated suction temperature 10°C, saturated condensing temperature 65°C) and nominal voltage of 400V (data given on the unit nameplate).  
(3) Standardised Eurovent conditions: evaporator entering/leaving water temperature 40°C/45°C, outside air temperature db/wb = 7°C/6°C.  
(4) Maximum unit operating current at maximum unit power input and 400V (values given on the unit nameplate).  
(5) Maximum unit operating current at maximum unit power input and 360V.

### 5.1 - Compressor usage and electrical data for standard units

Compressor	I Nom	I Max (Un)	I Max (Un-10%)	LRA <sup>(1)</sup> A	LRA <sup>(2)</sup> A	Cosine phi max.	070	080	100	120	150	200	300
ZH18KVE	10.8	14.0	15.6	101	53	0.84	1	-	-	-	-	-	-
ZH24KVE	13.6	18.3	20.3	99	51	0.85	-	1	-	-	-	-	-
ZH33KVE	17.3	24.2	26.9	127	66	0.85	-	-	1	-	-	2	-
ZH40KVE	20.4	30.0	33.2	167	87	0.89	-	-	-	1	-	-	-
ZH48KVE	24.9	36.0	40.0	198	97	0.89	-	-	-	-	1	-	2

#### Legend

- I Nom Nominal current draw at Eurovent conditions (see definition of conditions under nominal unit current draw), A  
I Max Maximum operating current at 360 V, A  
(1) Locked rotor current at nominal voltage, A  
(2) Locked rotor current at nominal voltage, electronic starter

### 5.2 - Short-circuit stability current (TN system<sup>(1)</sup>) - standard unit (with main disconnect without fuse)

TD		070	080	100	120	150	200	300
<b>Value without upstream protection</b>								
Short-term current at 1s (I <sub>sw</sub> )	kA rms	0.6	0.6	0.6	1.26	1.26	1.26	2
Admissible peak current (I <sub>pk</sub> )	kA pk	4.5	4.5	4.5	6	6	6	10
<b>Maximum value with upstream protection by circuit breaker</b>								
Conditional short-circuit current (I <sub>cc</sub> )	kA rms	5.4	7	7	7.7	7.7	6.1	10
Circuit breaker - Compact range		32	40	40	50	63	80	100
Reference number <sup>(2)</sup>		5SY6332-7	5SY6340-7	5SY6340-7	5SY4350-7	5SY4363-8	5SP4380-7	5SP4391-7
<b>Value with upstream protection (fuses)</b>								
Conditional short-circuit current I <sub>cc</sub> - kA rms	kA rms	17	50	50	50	50	14.5	22
Fuse (gL/gG)		40	40	40	63	63	80	125

- (1) Earthing system type  
(2) If another current limitation protection system is used, its time-current and thermal constraints (I<sup>2</sup>t) trip characteristics must be at least equivalent to those of the recommended circuit breaker.  
The short circuit stability current values above are suitable with TN system.

## 5 - ELECTRICAL DATA

### Electrical data and operating conditions notes:

- TD 070-300 units have a single power connection point located immediately upstream of the main disconnect switch.
- The control box includes the following standard features:
  - a main disconnect switch,
  - starter and motor protection devices for each compressor, the fans and the pump,
  - the control devices.
- **Field connections:**  
All connections to the system and the electrical installations must be in full accordance with all applicable local codes.
- The Aquaciat Caléo TD units are designed and built to ensure conformance with these codes. The recommendations of European standard EN 60204-1 (machine safety - electrical machine components - part 1: general regulations - corresponds to IEC 60204-1) are specifically taken into account, when designing the electrical equipment.

### NOTES:

- Generally the recommendations of IEC 60364 are accepted as compliance with the requirements of the installation directives. Conformance with EN 60204-1 is the best means of ensuring compliance with the Machines Directive § 1.5.1.
- Annex B of EN 60204-1 describes the electrical characteristics used for the operation of the machines.
- The operating environment for the TD units is specified below:

1. Environment<sup>(1)</sup> - Environment as classified in EN 60721 (corresponds to IEC 60721):
  - outdoor installation<sup>(1)</sup>
  - ambient temperature range: -20°C to +40°C, class 4K4H
  - altitude: ≤ 2000 m
  - presence of hard solids, class 4S2 (no significant dust present)
  - presence of corrosive and polluting substances, class 4C2 (negligible)
2. Power supply frequency variation: ± 2 Hz.
3. The neutral (N) conductor must not be connected directly to the unit (if necessary use a transformer).
4. Overcurrent protection of the power supply conductors is not provided with the unit.
5. The factory-installed disconnect switch is of a type suitable for power interruption in accordance with EN 60947.
6. The units are designed for connection to TN networks (IEC 60364). Units delivered with speed drive (options 116) are not compatible with IT network due to speed drive.

**Caution: If particular aspects of an actual installation do not conform to the conditions described above, or if there are other conditions which should be considered, always contact your local CIAT representative.**

- (1) The required protection level for this class is IP43BW (according to reference document IEC 60529). All TD units are protected to IP44CW and fulfil this protection condition.

## 6 - APPLICATION DATA

### 6.1 - Unit operating range

Condenser		Minimum	Maximum
Entering water temperature at start-up	°C	8	57
Leaving water temperature during operation	°C	30	65
Entering/leaving water temperature difference	K	3	(2)
Evaporator		Minimum	Maximum
Entering air temperature, standard unit <sup>(1)</sup>	°C	-20	40
Entering air temperature, unit with XtraFan	°C	-15	40

**Note:** Do not exceed the maximum operating temperature.

- (1) Outside temperature: For transport and storage of the TD units the minimum and maximum allowable temperatures are -20°C and +50°C. It is recommended that these temperatures are used for transport by container.
- (2) Refer to the minimum water flow rate for each machine (see chapter 6.2).

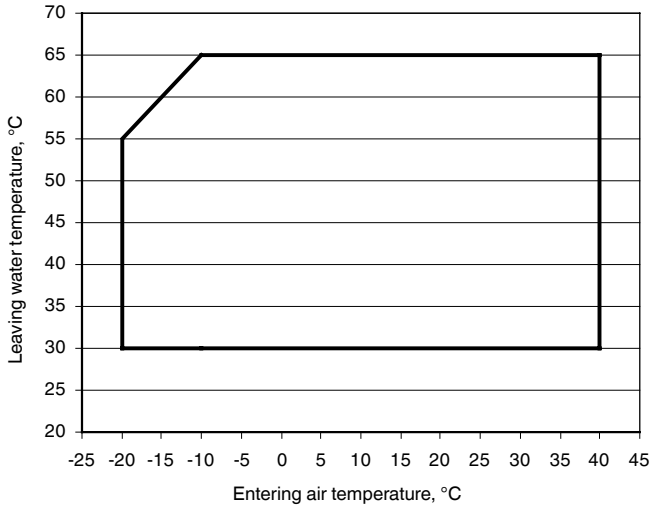

### 6.2 - Plate heat exchanger water flow

TD	Maximum flow rate with hydraulic module <sup>(1)</sup> , l/s	Maximum flow rate without hydraulic module <sup>(2)</sup> , l/s
22	1,8	1,8
30	2,4	2,4
35	2,8	3,1
45	3,8	3,8
55	4,6	4,6
75	5,9	6,4
105	6,1	8,5

- (1) Maximum flow rate at an available pressure of 20 kPa minimum
- (2) Maximum flow rate at a water temperature difference of 3K in the plate heat exchanger

**NOTE:** For a domestic hot water application (leaving water temperature = 65°C), the water temperature difference must be 8 K minimum for operation at 100% capacity.

### 6.3 - Minimum water flow rate

Operation below the minimum flow rate of the machine can cause a risk of freezing and excessive fouling of the condenser.

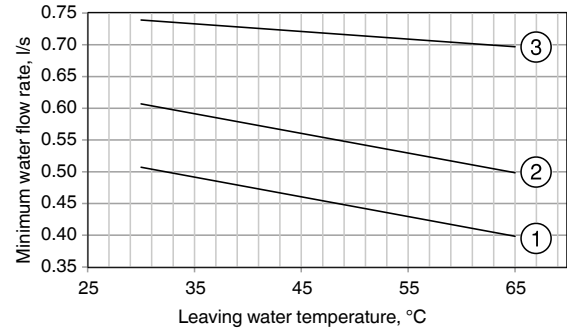

- 1 TD 070
- 2 TD 080
- 3 TD 100

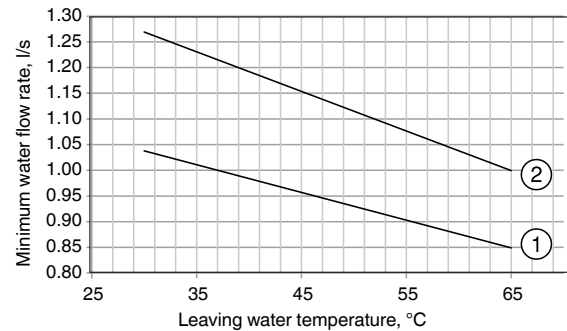

- 1 TD 120
- 2 TD 150

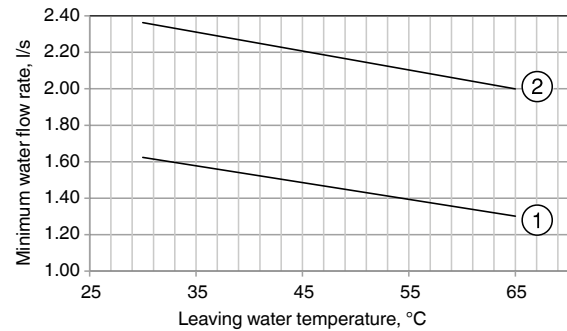

- 1 TD 200
- 2 TD 300

### 6.4 - Maximum plate heat exchanger water flow rate

This is limited by the permitted plate heat exchanger pressure drop. Also, a minimum condenser  $\Delta T$  of 3 K must be guaranteed, which corresponds to a water flow rate of 0.09 l/s per kW.

## 6 - APPLICATION DATA

### 6.5 - Water loop volume

#### 6.5.1 - Minimum water loop volume

The heat pump is used in a domestic hot water application and must heat an intermediate loop that supplies domestic hot water via a heat exchanger. The primary loop is charged with softened water. Regular checks must be carried out on the water system to detect possible scale formation. The heat pump in this type of application must never supply domestic hot water directly.

The minimum water loop volume, in litres, is given by the following formula:

Volume (l) = CAP (kW) x N, where CAP is the nominal heating capacity at nominal operating conditions.

Heating or domestic hot water application	N
TD 070-150	5.0l
TD 200-300	3.0l

This volume is required to obtain temperature stability and precision.

To achieve this volume, it may be necessary to add a storage tank to the circuit. This tank should be equipped with baffles to allow mixing of the fluid (water or brine). Please refer to the examples below.

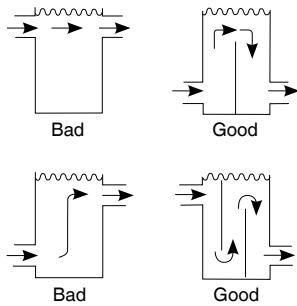

#### 6.5.2 - Expansion tank volume

Units do not incorporate an expansion tank. This must be included in the water loop.

The table below gives the buffer tank volume that must be provided, based on the water loop volume, the fluid used and its concentration.

Expansion tank volume required	% of water loop volume <sup>(1)</sup>
Pure water	3.0
10% ethylene glycol	3.0
20% ethylene glycol	3.5
30% ethylene glycol	3.8
40% ethylene glycol	4.2

(1) Calculation based on a charge temperature of 10°C.

### 6.6 - Plate heat exchanger pressure drop curves

For pure water at 20°C

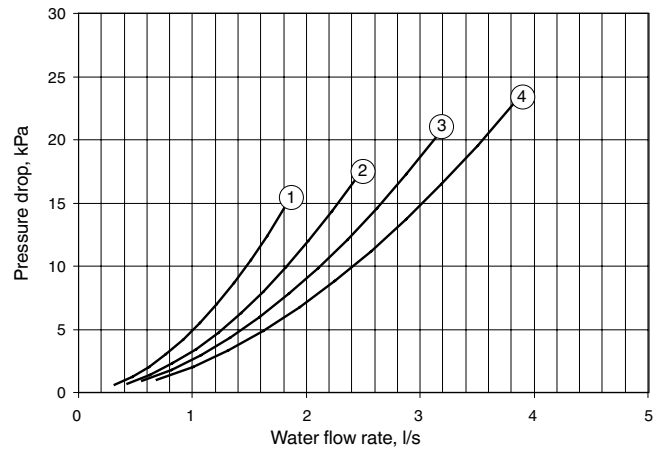

- 1 TD 070
- 2 TD 080
- 3 TD 100
- 4 TD 120

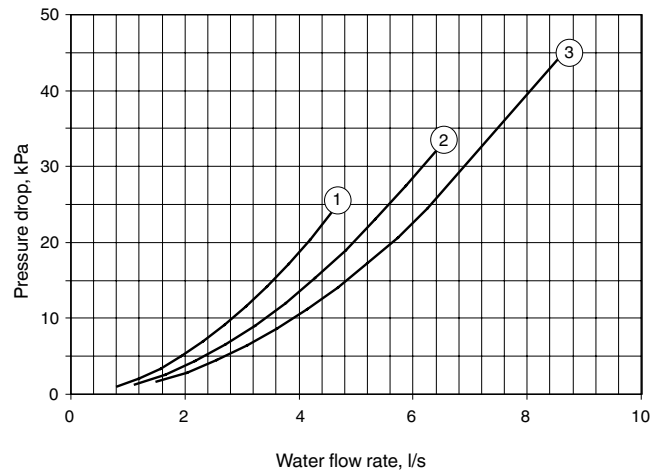

- 1 TD 150
- 2 TD 200
- 3 TD 300

## 7 - ELECTRICAL CONNECTION

Please refer to the certified dimensional drawings, supplied with the unit (also available on the internet).

### 7.1 - Power supply

The power supply must conform to the specification on the unit nameplate. The supply voltage must be within the range specified in the electrical data table. For connections refer to the wiring diagrams and the certified dimensional drawings.

**WARNING: Operation of the unit with an improper supply voltage or excessive phase imbalance constitutes abuse which will invalidate the CIAT warranty. If the phase imbalance exceeds 2% for voltage, or 10% for current, contact your local electricity supply at once and ensure that the heat pump is not switched on until corrective measures have been taken.**

### 7.2 - Voltage phase imbalance (%)

$$100 \times \frac{\text{max. deviation from average voltage}}{\text{Average voltage}}$$

#### Example:

On a 400 V - 3 ph - 50 Hz supply, the individual phase voltages were measured to be:

AB = 406 V; BC = 399 V; AC = 394 V

$$\begin{aligned} \text{Average voltage} &= (406 + 399 + 394)/3 = 1199/3 \\ &= 399.7 \text{ say } 400 \text{ V} \end{aligned}$$

Calculate the maximum deviation from the 400 V average:

$$\begin{aligned} (AB) &= 406 - 400 = 6 \\ (BC) &= 400 - 399 = 1 \\ (CA) &= 400 - 394 = 6 \end{aligned}$$

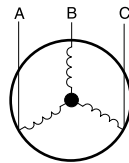

The maximum deviation from the average is 6 V. The greatest percentage deviation is:  $100 \times 6/400 = 1.5\%$

This is less than the permissible 2% and is therefore acceptable.

### 7.3 - Recommended wire sections

Wire sizing is the responsibility of the installer, and depends on the characteristics and regulations applicable to each installation site. **The following is only to be used as a guideline, and does not make CIAT in any way liable.** After wire sizing has been completed, using the certified dimensional drawing, the installer must ensure easy connection and define any modifications necessary on site.

The connections provided as standard for the field-supplied power entry cables to the general disconnect/isolator switch are designed for the number and type of wires, listed in the table below.

The calculations are based on the maximum machine current (see electrical data tables). Standard installation practises for units installed outside have been applied in accordance with IEC 60364, table 52C:

- No. 17: suspended aerial lines,
- No. 61: buried conduit with a derating coefficient of 20.

The calculation is based on PVC or XLPE insulated cables with copper core. A maximum ambient temperature of 40°C has been taken into consideration for TD units. The given wire length limits the voltage drop to < 5%.

**IMPORTANT: Before connection of the main power cables (L1 - L2 - L3) on the terminal block, it is imperative to check the correct order of the 3 phases before proceeding to the connection on the main disconnect/isolator switch.**

### 7.3.1 - Power cable entry

The power cables can enter the TD control box from below or from the side of the unit, at the bottom of the angle iron. Pre-punched holes facilitate the entry. Refer to the certified dimensional drawing for the unit. An opening below the control box allows introduction of the cables.

### 7.4 - Field control wiring

**Important: Field connection of interface circuits may lead to safety risks: any control box modification must maintain equipment conformity with local regulations. Precautions must be taken to prevent accidental electrical contact between circuits supplied by different sources:**

- The routing selection and/or conductor insulation characteristics must ensure dual electric insulation.
- In case of accidental disconnection, conductor fixing between different conductors and/or in the control box prevents any contact between the conductor ends and an active energised part.

Refer to the Aquaciat Caléo TD Connect Touch Control IOM and the certified wiring diagram supplied with the unit for the field control wiring of the following features:

- Condenser pump interlock (mandatory)
- Remote on/off switch
- Demand limit external switch
- Remote dual setpoint switch
- Alarm, alert and operation report

### 7.5 - Power supply

After the unit has been commissioned, the power supply must only be disconnected for quick maintenance operations (one day maximum). For longer maintenance operations or when the unit is taken out of service and stored the power supply must be maintained to ensure supply to the heaters (unit frost protection).

## 7 - ELECTRICAL CONNECTION

### 7.6 - 24 V user power reserve

After all possible options have been connected, the transformer ensures the availability of a usable 24 VA or 1 A power reserve for the control circuit on site. This power reserve can not be used in case of additional electric heaters control.

**Table of minimum and maximum wire sections for connection to TD units**

TD	Disconnect switch	Connectable wire					
	Max. connectable section	Min. wire section			Max. wire section		
	Section (mm <sup>2</sup> )	Section (mm <sup>2</sup> )	Max. length (m)	Wire type	Section (mm <sup>2</sup> )	Max. length (m)	Wire type
<b>070</b>	1 x 10	1 x 6	100	XLPE Cu	1 x 10	210	PVC Cu
<b>080</b>	1 x 10	1 x 6	100	XLPE Cu	1 x 10	245	PVC Cu
<b>100</b>	1 x 10	1 x 10	130	XLPE Cu	1 x 10	245	PVC Cu
<b>120</b>	1 x 16	1 x 10	130	XLPE Cu	1 x 16	245	PVC Cu
<b>150</b>	1 x 16	1 x 10	130	XLPE Cu	1 x 16	245	PVC Cu
<b>200</b>	1 x 16	1 x 16	220	XLPE Cu	1 x 16	245	PVC Cu
<b>300</b>	1 x 35	1 x 35	220	XLPE Cu	1 x 35	220	PVC Cu

**Note:** Power supply cable section (see the diagram in the chapter "Electrical connection").

## 8 - WATER CONNECTIONS

For size and position of the unit water inlet and outlet connections refer to the certified dimensional drawings supplied with the unit. The water pipes must not transmit any radial or axial force to the heat exchangers nor any vibration.

The water supply must be analysed and appropriate desilting, filtering, treatment, control devices, shut-off and bleed valves built in, to prevent corrosion (example: damage to the protection of the tube surface if the fluid is polluted), fouling and deterioration of the water circuit.

Before any start-up verify that the heat exchange fluid is compatible with the materials and the water circuit coating. The use of different metals on hydraulic piping could generate eletrolytic pairs and consequently corrosion. Verify then, the need to install sacrificial anodes.

In case additives or other fluids than those recommended by CIAT are used, ensure that the fluids are not considered as a gas, and that they belong to class 2, as defined in directive 2014/68/EU.

### CIAT recommendations on heat exchange fluids:

- No  $\text{NH}_4^+$  ammonium ions in the water, they are very detrimental for copper. This is one of the most important factors for the operating life of copper piping. A content of several tenths of mg/l will badly corrode the copper over time.
- $\text{Cl}^-$  Chloride ions are detrimental for copper with a risk of perforations by corrosion by puncture. If possible keep below 125 mg/l.
- $\text{SO}_4^{2-}$  sulphate ions can cause perforating corrosion, if their content is above 30 mg/l.
- No fluoride ions (<0.1 mg/l).
- No  $\text{Fe}^{2+}$  and  $\text{Fe}^{3+}$  ions with non negligible levels of dissolved oxygen must be present. Dissolved iron < 5 mg/l with dissolved oxygen < 5 mg/l.
- Dissolved silica: silica is an acid element of water and can also lead to corrosion risks. Content < 1mg/l.
- Water hardness: >0.5 mmol/l. Values between 0.5 and 1.5 mmol/l are recommended. This will facilitate scale deposit that can limit corrosion of copper. Values that are too high can cause piping blockage over time. A total alkalimetric titre (TAC) below 100 is desirable in primary domestic hot water loops and for heating applications.
- Dissolved oxygen: Any sudden change in water oxygenation conditions must be avoided. It is as detrimental to deoxygenate the water by mixing it with inert gas as it is to over-oxygenate it by mixing it with pure oxygen. The disturbance of the oxygenation conditions encourages destabilisation of copper hydroxides and enlargement of particles.
- Electric conductivity 10-600  $\mu\text{S}/\text{cm}$
- pH: Ideal case pH neutral at 20-25°C ( $7.5 < \text{pH} < 9$ ).

**ATTENTION: Charging, adding or draining fluid from the water circuit must be done by qualified personnel, using air vents and materials suitable for the products. The water circuit charging devices are field-supplied.**

**Charging and removing heat exchange fluids should be done with devices that must be included on the water circuit by the installer.**

### 8.1 - Operating precautions and recommendations

The water circuit should be designed to have the least number of elbows and horizontal pipe runs at different levels. Below the main points to be checked for the connection:

- Comply with the water inlet and outlet connections shown on the unit.
- Install manual or automatic air purge valves at all high points in the circuit.
- Use a pressure reducer to maintain pressure in the system and install a relief valve and an expansion tank.
- Units include a relief valve.
- Install thermometers in both the entering and leaving water connections.
- Install drain connections at all low points to allow the whole circuit to be drained.
- Install stop valves, close to the entering and leaving water connections.
- Use flexible connections to reduce vibration transmission.
- Insulate all pipework, after testing for leaks, to prevent heat loss.
- Wrap the insulations with a demisting screen.
- If the external unit water pipes are in an area where the ambient temperature is likely to fall below 0°C, they must be protected against frost (frost protection solution or electric heaters).

**NOTE: A screen filter is installed on the water entering pipes upstream of the pressure gauge at the unit inlet. It is located in a position that is easily accessible for removal and cleaning. The mesh size of the filter is 1.2 mm.**

**The plate heat exchanger can foul up quickly at the initial unit start-up, as it complements the filter function, and the unit operation will be impaired (reduced water flow rate due to increased pressure drop).**

**Do not introduce any significant static or dynamic pressure into the heat exchange circuit (with regard to the design operating pressures).**

**The products that may be added for thermal insulation of the containers during the water piping connection procedure must be chemically neutral in relation to the materials and coatings to which they are applied. This is also the case for the products originally supplied by CIAT.**

### 8.2 - Hydraulic connections

The diagram on the following page shows a typical hydraulic installation. When charging the water circuit use air vents to evacuate any residual air pockets.

### 8.3 - Frost protection

The plate heat exchangers, the piping and the hydraulic module pump can be damaged by frost, despite the built-in anti-freeze protection of the units. Frost protection of the plate heat exchanger and all hydraulic circuit components is guaranteed:

- Down to -10°C by an electric heater on the heat exchanger that has an automatic supply and by pump cycling (standard),
- Down to -20°C by electric heaters (heat exchanger and internal piping) that have an automatic supply and by pump cycling (units with "Reinforced frost protection" option).

Never switch off the plate heat exchanger and hydraulic circuit heaters or the pump, otherwise frost protection cannot be guaranteed. The main unit disconnect switch as well as the heater auxiliary protection switch must always be left closed

## 8 - WATER CONNECTIONS

(for the location of these components see the wiring diagram).

To ensure frost protection of the units with hydraulic module water circulation in the water circuit must be maintained by periodically switching on the pump. If a shut-off valve is installed, a bypass must be included as shown below.

### Winter position

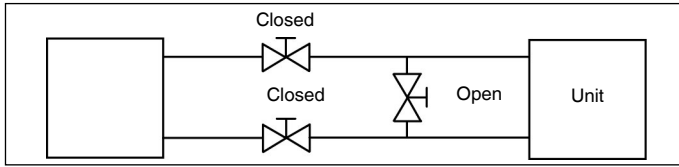

It is recommended to use a primary glycol loop for low-temperature applications, as shown below:

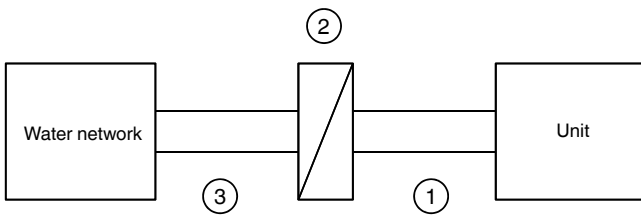

#### Legend

- 1 Primary glycol loop (minimum 10%)
- 2 Intermediate heat exchanger
- 3 Secondary loop

**IMPORTANT:** Depending on the climate conditions in your area do the following when switching the unit off in winter:

- Add ethylene glycol or propylene glycol with an adequate concentration to protect the installation up to a temperature of 10 K below the lowest temperature likely to occur at the installation site. If ethylene glycol or propylene glycol is added, ensure that the unit pump is not used to add pure glycol and to apportion the fluid amount (possible pump damage). Always add a mixture that is measured in advance.
- If the unit is not used for an extended period, it should be drained, and as a safety precaution ethylene glycol or propylene glycol introduced in the heat exchanger, using the water entering purge valve connection.
- At the start of the next season, refill the unit with water and add an inhibitor.
- For the installation of auxiliary equipment, the installer must comply with basic regulations, especially for minimum and maximum flow rates, that must be between the values listed in the operating limit table (application data).
- To prevent corrosion by differential aeration, the complete drained heat transfer circuit must be charged with nitrogen for a period of one month. If the heat transfer fluid does not comply with the CIAT regulations, the nitrogen charge must be added immediately.



## 8 - WATER CONNECTIONS

### 8.4 - Protection against cavitation

To ensure the durability of the pumps in the integrated hydraulic modules, the control algorithm of the TD units incorporates anti-cavitation protection.

It is therefore necessary to ensure a minimum pump entering pressure of 40 kPa (0.4 bar) during operation and at shut-down. A pressure below 40 kPa will prohibit unit start-up or cause an alarm with the unit shutting down. In order to obtain sufficient pressure, it is recommended:

- to pressurise the hydraulic circuit between 1 and 4 bar (maximum),
- to clean the hydraulic circuit before charging water (see chapters 9.2 and 9.3),
- to regularly clean the screen filter,

**ATTENTION: The use of integrated hydraulic kits in the open loop is not permitted.**

Typical hydraulic circuit diagram

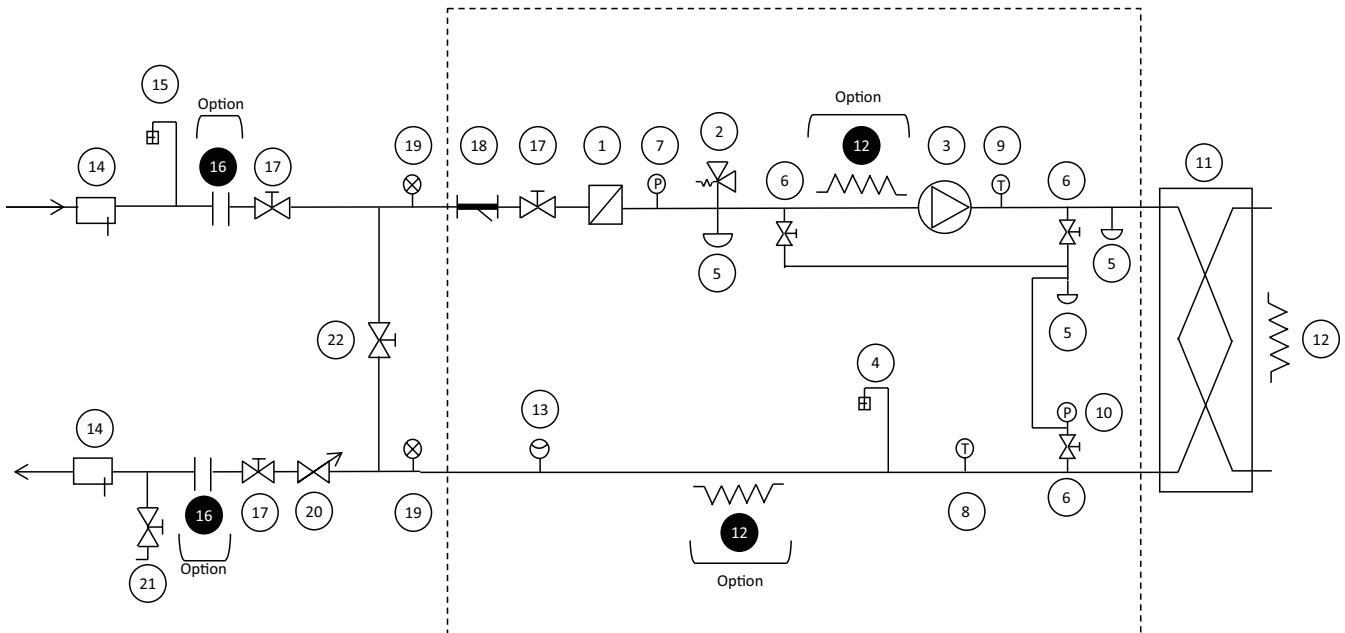

#### Legend

##### Components of the unit and hydraulic module

- 1 Victaulic screen filter
- 2 Pressure sensor  
Note: Gives pump suction pressure information (see installation manual)
- 3 Relief valve
- 4 Water drain valve  
Note: A second valve is located on the heat exchanger leaving piping
- 5 Shut-off valve
- 6 Available pressure pump
- 7 Temperature probe, BPHE inlet  
Note: Gives heat exchanger entering temperature information (see installation manual)
- 8 Pressure gauge  
Note: Allows measuring of the pump suction pressure, the pump leaving pressure and the heat exchanger leaving pressure
- 9 Temperature probe, BPHE outlet  
Note: Gives heat exchanger leaving temperature information (see installation manual)
- 10 Automatic air vent
- 11 Flow switch
- 12 Plate heat exchanger frost protection heater
- 13 Plate heat exchanger

##### Installation components

- 14 Temperature probe well
  - 15 Air vent
  - 16 Flexible connection
  - 17 Shut-off valve
  - 18 Screen filter (obligatory for a unit without hydraulic module)
  - 19 Pressure gauge
  - 20 Water flow control valve (optional with hydraulic module option)
  - 21 Charge valve
  - 22 Frost protection bypass valve (when shut-off valves [17] are closed during winter)
- Hydraulic module (unit with hydraulic module)

##### Notes:

- Units without hydraulic module (standard units) are equipped with a flow switch and two temperature sensors (7 and 9).
- For units equipped with hydraulic module, the pressure sensor located upstream of the pump to prevent cavitation is installed on a connection without Schraeder valves. Depressurise and drain the system before any intervention.

# 8 - WATER CONNECTIONS

## Hydraulic module - TD

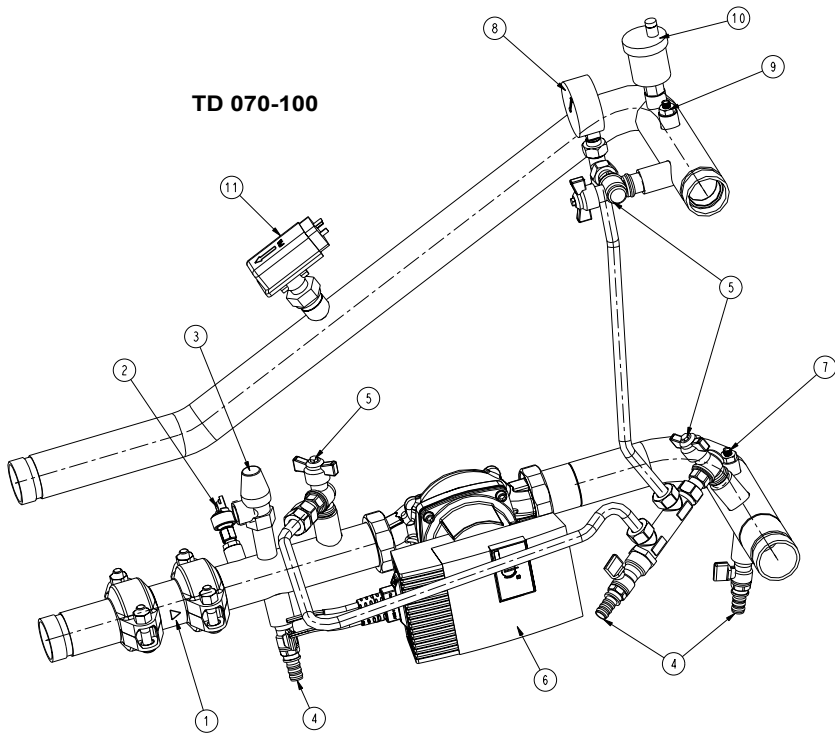

TD 070-100

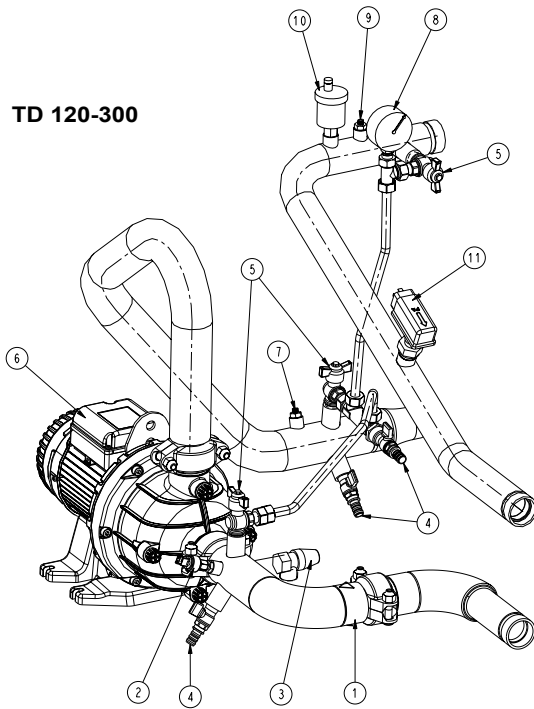

TD 120-300

### Legend

#### Components of the unit and hydraulic module

- 1 Victaulic screen filter
- 2 Pressure sensor  
Note: Gives pump suction pressure information (see installation manual)
- 3 Relief valve
- 4 Water drain valve  
Note: A second valve is located on the heat exchanger leaving piping
- 5 Shut-off valve
- 6 Available pressure pump
- 7 Temperature probe, BPHE inlet  
Note: Gives heat exchanger entering temperature information (see installation manual)
- 8 Pressure gauge  
Note: Allows measuring of the pump suction pressure, the pump leaving pressure and the heat exchanger leaving pressure
- 9 Temperature probe, BPHE outlet  
Note: Gives heat exchanger leaving temperature information (see installation manual)
- 10 Automatic air vent
- 11 Flow switch

## 9 - NOMINAL SYSTEM WATER FLOW CONTROL

### 9.1 - General

The water circulation pumps of the TD units have been sized to allow the hydraulic modules to cover all possible configurations based on the specific installation conditions, i.e. for various temperature differences between the entering and the leaving water ( $\Delta T$ ) at full load, which can vary between 3 and 10 K. This required difference between the entering and leaving water temperature determines the nominal system flow rate.

The pump of the hydraulic module is a variable speed pump. Two different water flow control can be selected:

- fixed speed control
- variable speed control based on constant temperature difference.

Default factory setting is fixed speed. Settings change need to be done by a CIAT Service representant.

For both flow control and for energy saving, the speed of the pump will be reduced to its minimum when unit capacity is 0%.

It is essential to know the nominal system flow rate to be able to control it, using the variable pump speed or a manual valve that must be on the water leaving piping of the system (item 20 in the typical hydraulic circuit diagram).

The flow control with the pump speed or with the valve permits adjustment of the pressure/system flow rate curve in accordance with the pump pressure/flow rate curve to obtain the nominal flow rate at the required operating point (see example for unit size TD 035). The pressure drop reading in the plate heat exchanger is used as means of control and adjustment of the nominal system flow rate. This reading can be taken with a differential pressure gauge that must be installed at the heat exchanger inlet and outlet.

Use the specifications of the unit selection to know the system operating conditions and to deduce the nominal flow rate and the plate heat exchanger pressure drop at the specified conditions. If this information is not available at the system start-up, contact the technical service department responsible for the installation to get it.

These characteristics can be obtained with the Electronic Catalogue selection program for all  $\Delta T$  conditions in the range of 3 to 10 K.

For domestic hot water applications (leaving water temperatures above 60°C) the control cannot be made at a  $\Delta T$  below 8 K at the condenser.

### 9.2 - Water flow control procedure (fixed speed)

#### Hydraulic circuit cleaning procedure

- Open the valve fully (item 20) if present.
- Start-up the system or unit pump (by quick test).
- Read the plate heat exchanger pressure drop by taking the difference of the readings of the pressure gauge connected to the unit inlet and outlet (item 19).
- Let the pump run for two consecutive hours to clean the system hydraulic circuit (presence of solid contaminants).
- Take another reading.
- Compare this value to the initial value.
- If the pressure drop has decreased, this indicates that the screen filter must be removed and cleaned, as the hydraulic circuit contains solid particles. In this case close the shut-off valves at the water inlet and outlet and remove the screen filter after emptying the hydraulic section of the unit.
- Purge the air from the circuit.
- Renew, if necessary, to ensure that the filter is not contaminated.

#### Water flow control procedure

- When the circuit is cleaned, read the pressures at the differential pressure gauge (BPHE leaving water pressure - BPHE entering water pressure), to find out the pressure drop for the plate heat exchanger and the internal piping.
- Compare the value obtained with the theoretical selection value.
- If the pressure drop measured is higher than the value specified this means that the unit flow rate (and thus system flow rate) is too high. The pump supplies an excessive flow rate based on the global pressure drop of the application. In this case close the control valve or reduce the pump speed. Read the new pressure difference.
- Proceed by successively closing the control valve or reducing the pump speed until you obtain the specific pressure drop that corresponds to the nominal flow rate at the required unit operating point.
- Verify the minimum speed pump setting (when unit capacity is 0%) is compatible with the flow switch protection (no flow switch alarm for minimum speed).

**NOTE: If the system has an excessive pressure drop in relation to the available static pressure provided by the system pump the nominal water flow rate cannot be obtained (the resulting flow rate is lower) and the temperature difference between the condenser entering and leaving water will increase.**

To reduce the pressure drops of the hydraulic system, it is necessary:

- to reduce the individual pressure drops as much as possible (bends, level changes, accessories, etc.).
- to use a correctly sized piping diameter.
- to avoid hydraulic system extensions, wherever possible.

#### Example: TD 100 at Eurovent conditions of 1.76 l/s

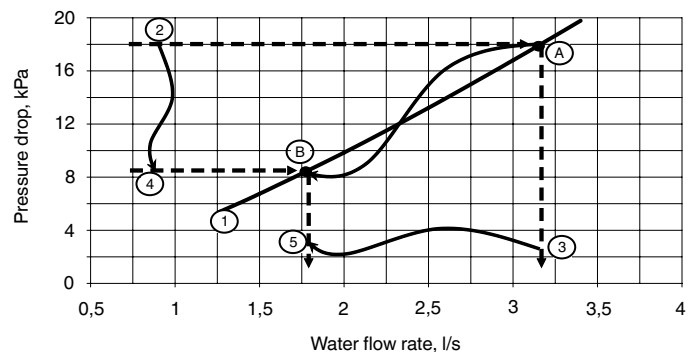

#### Legend

- 1 'BPHE pressure drop/flow rate' curve
- 2 With the valve open or with the maximum pump speed, the pressure drop read (18 kPa) gives point A on the curve.
- 3 The flow rate achieved is 3.4 l/s: this is too high, and the valve must be closed or the pump speed decreased.
- 4 With valve is partially closed or speed decreased, the pressure drop read (6 kPa) gives point B on the curve.
- 5 Operating point reached with the valve partially closed / pump speed reduced. The flow rate achieved is 1.76 l/s: this is the required flow rate and the settings are adequate.

### 9.3 - Water flow control procedure (variable speed)

TD units include a water pump that automatically adjusts the flow to maintain a constant temperature difference.

No control is required at start-up, but the control mode must be selected in the unit control by a CIAT service representant

## 9 - NOMINAL SYSTEM WATER FLOW CONTROL

### 9.4 - Available system pressure

The available pressure curves for the TD units are given for the higher variable speed of the pump (maximum available pressure).

Data applicable for:

- Fresh water 20°C
- In case of use of the glycol, the maximum water flow is reduced.

For pure water at 20°C

TD	Maximum condenser water flow rate, l/s
070	1,8
080	2,4
100	2,8
120	3,8
150	4,6
200	5,9
300	6,1

(1) Maximum flow rate corresponding to an available pressure of 20 kPa minimum.

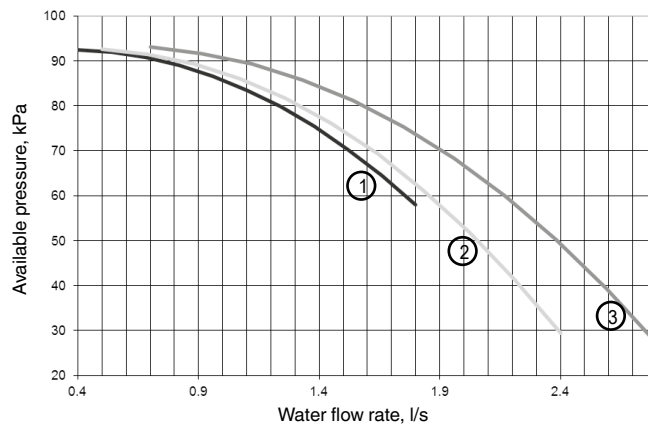

- 1 TD 070
- 2 TD 080
- 3 TD 100

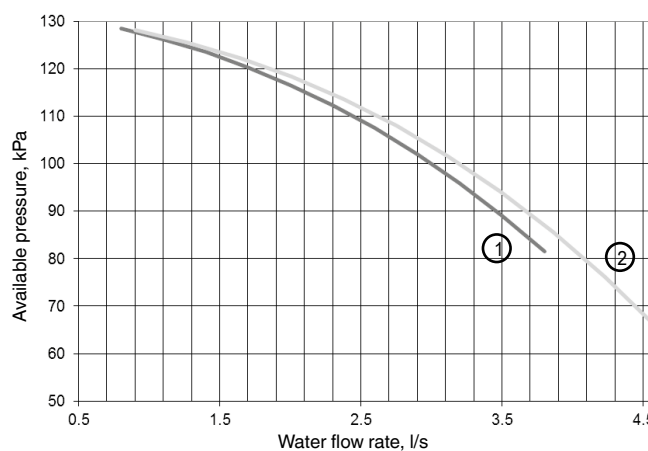

- 1 TD 120
- 2 TD 150

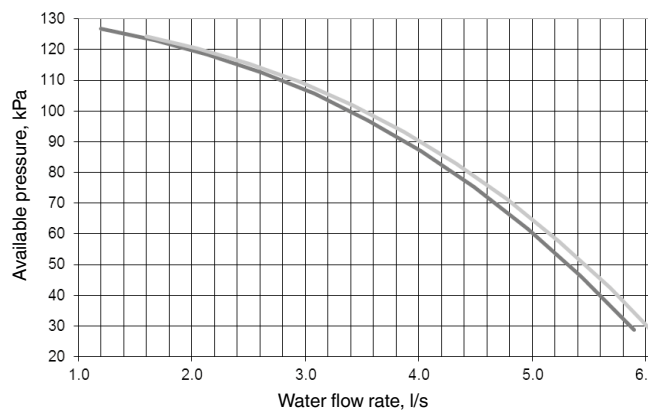

- 1 TD 200
- 2 TD 300

# 10 - START-UP

## 10.1 - Preliminary checks

Never be tempted to start the heat pump without reading fully, and understanding, the operating instructions and without having carried out the following pre-start checks:

- Check the water circulation pumps, air handling units and all other equipment connected to the condenser.
- Refer to the manufacturer's instructions.
- Refer to the wiring diagram supplied with the unit.
- Ensure that there are no refrigerant leaks.
- Confirm that all pipe securing bands are tight.
- Confirm the the electrical connections are secure.

## 10.2 - Actual start-up

**IMPORTANT:**

- **Commissioning and start-up of the chiller must be supervised by a qualified refrigeration engineer.**
- **Start-up and operating tests must be carried out with a thermal load applied and water circulating in the condenser.**
- **All setpoint adjustments and control tests must be carried out before the unit is started up.**
- **Please refer to the Aquaciat Caléo TD Connect Touch control manual.**

The unit should be started up in Local ON mode. Ensure that all safety devices are satisfied, especially the high pressure switches.

## 10.3 - Operation of two units in master/slave mode

The control of a master/slave assembly is in the entering water and does not require any additional sensors (standard configuration). It can also be located in the leaving water. In this case two additional sensors must be added on the common piping.

All parameters, required for the master/slave function must be configured using the Service Configuration menu. All remote controls of the master/slave assembly (start/stop, setpoint, load shedding, etc.) are controlled by the unit configured as master and must only be applied to the master unit.

Depending on the installation and control type, each unit can control its own water pump. Please install check valves in the leaving water piping of each unit, as shown in the following diagrams. If there is only one common pump for the two units, the master unit can control this. In this case shut-off valves must be installed on each unit. They will be activated at the opening and closing by the control of each unit (and the valves will be controlled using the dedicated water pump outputs).

**Standard configuration: return water control**

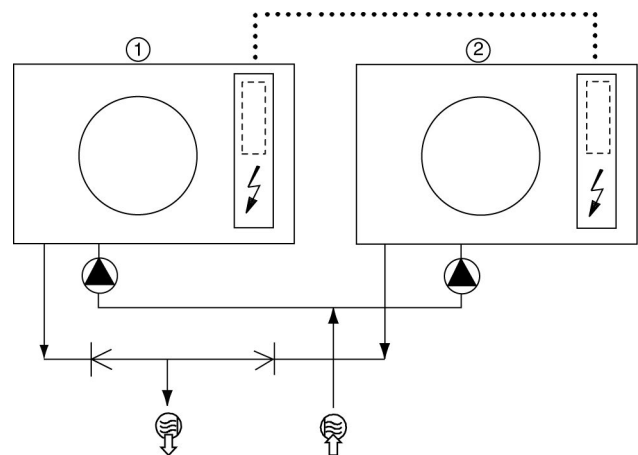

**Configuration: leaving water control**

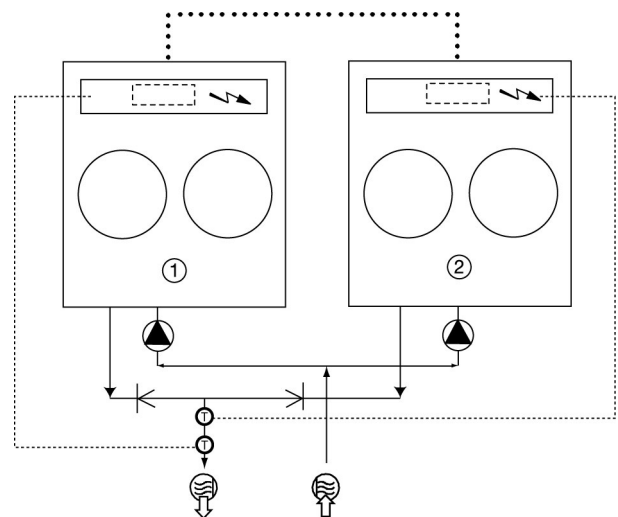

**Legend**

- 1 Master unit
- 2 Slave unit
- Additional CCN board (one per unit, with connection via communication bus)
- ⚡ Control boxes of the master and slave units
- ⊕ Water inlet
- ⊖ Water outlet
- ⚙ Water pumps for each unit (included)
- ⊕ Additional sensors for leaving water control, to be connected to channel 1 of the slave boards of each master and slave unit
- ⋯ CCN communication bus
- ⋯ Connection of two additional sensors
- ⊗ Check valve

## 10 - START-UP

### 10.4 - Supplementary electric resistance heaters

To permit staging of the capacity reduction of the heat pump at low ambient temperatures, as shown in the diagram below, it is possible to install supplementary electric heaters in the leaving water line. Their capacity can compensate for the capacity drop of the heat pump.

These heaters can be controlled via an integrated electronic board.

Four outputs are available to control the heater contactors, permitting gradual compensation of the heat pump capacity reduction.

These outputs are configurable to obtain a choice of two, three or four stages. The last stage will only be activated after a shut-down of the heat pump following a fault condition (safety device). This requires only a 400 V-3 ph-50 Hz power supply source.

For the required configuration of the stages consult the Aquaciat Caléo TD Connect Touch control manual.

#### Example of additional electric heaters

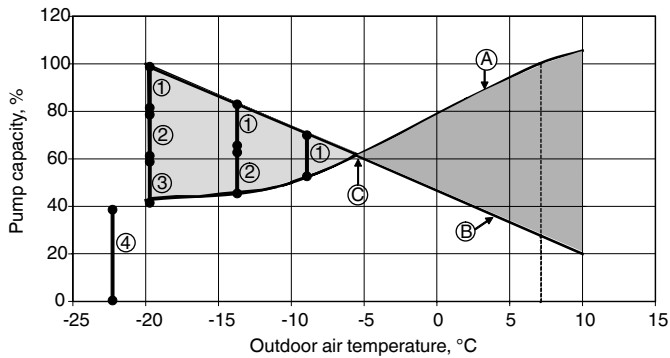

- Operating range, in which the heat pump capacity is lower than the building thermal load
- Operating range, in which the heat pump capacity is higher than the building thermal load

#### Legend

- 1 Stage 1 2 Stage 2 3 Stage 3 4 Stage 4
- A Heat pump capacity variation as a function of the air temperature
- B Building thermal load
- C Balance point between the capacity supplied by the heat pump and the thermal load of the building

# 11 - MAJOR SYSTEM COMPONENTS

## 11.1 - Compressors

TD units use hermetic scroll compressors with vapour injection. Each compressor is equipped with a crankcase oil heater, as standard.

Each compressor function is equipped with:

- Anti-vibration mountings between the unit chassis and the compressor(s).
- A single pressure safety switch at the discharge.

## 11.2 - Lubricant

The compressors installed in these units have a specific oil charge, indicated on the name plate of each compressor.

The oil level check must be done with the unit switched off, when then suction and discharge pressures are equalised. The oil level must be visible and above the middle of the sight-glass in the oil equalisation line. If this is not the case, there may be an oil leak in the circuit. Search and repair the leak, then recharge oil, so that it reaches a level between the middle and three quarters of the sight-glass (unit in vacuum).

**ATTENTION: Too much oil in the circuit can cause a unit defect. Use only oils which have been approved for the compressors. Never use oils which have been exposed to air. R-22 oils are absolutely not compatible with R-407C oils and vice versa.**

## 11.3 - Air evaporators

The TD coils are air evaporators with internally grooved copper tubes with aluminium fins.

## 11.4 - Fans

Axial Flying Bird fans equipped with a rotating shroud and made of composite recyclable material. The motors are three-phase, with permanently lubricated bearings and insulation class F. See table below.

According to the Regulation No. 327/2011 implementing Directive 2009/125/EC with regard to ecodesign requirements for fans driven by motors with an electric input power between 125 W and 500 kW.

Product/ Option	TD Standard	TD Standard with XtraFan
Overall efficiency %	36.6	38.0
Measurement category	A	A
Efficiency category	static	static
Energy efficiency target N(2015)	N(2015) 40	N(2015) 40
Efficiency level at optimum efficiency point	43.3	37.4
Variable speed drive	NO	NO
Year of manufacture	See label on the unit	See label on the unit
Fan manufacturer	Simonin	Simonin
Motor manufacturer	A.O. Smith/Regal Beloit	A.O. Smith/Regal Beloit
Fan PN	00PSG000000100A	00PSG000000100A
Motor PN	00PPG000478400A	00PPG000480800A
Nominal power of the motor kW	0.88	2.09
Flow rate m <sup>3</sup> /s	3.59	4.07
Pressure at optimum energy efficiency Pa	90	195
Nominal speed rpm	710	966
Specific ratio	1.002	1.002
Relevant information to facilitate the disassembly, recycling or removal of the product at the end of life	See service manual	See service manual
Relevant information to minimise impact on the environment	See service manual	See service manual

## 11.5 - Electronic expansion valve (EXV) of the main circuit

The EXV is equipped with a stepper motor that is controlled via the EXV board.

## 11.6 - Electronic expansion valve (EXV) of the economised circuit

The EXV is equipped with a stepper motor that is controlled via the EXV board.

## 11.7 - Four-way valve

The four-way valve allows the reversal of the refrigerant cycle, required during the unit defrost phases.

## 11.8 - Moisture indicator

Located on the liquid line, permits control of the unit charge and indicates moisture in the circuit. The presence of bubbles in the sight-glass indicates an insufficient charge or non-condensables in the system. The presence of moisture changes the colour of the indicator paper in the sight-glass.

## 11.9 - Filter drier

One-piece, brazed filter drier, located in the liquid line. The filter drier keeps the circuit clean and moisture-free. The moisture indicator shows when the filter drier to be changed. A difference in temperature between the filter inlet and outlet shows that the element is dirty.

According to the Regulation No. 640/2009 and amendment 4/2014 implementing Directive 2009/125/EC with regard to ecodesign requirements for electric motors.

Product/ Option	TD Standard	TD Standard with XtraFan
Motor type	Dual-speed asynchronous	Dual-speed asynchronous
Number of poles	8	6
Nominal input frequency Hz	50	50
Nominal voltage V	400	400
Number of phases	3	3
Motor included in the application domain of the regulation 640/2009 and amendment 4/2014	No	No
Sales leaflet for exemption	Article 2.1	Article 2.1
Ambient air temperature for which the motor is specifically designed °C	68.5	68.5

## 11.10 - Condenser

The condenser is a plate heat exchanger. The water connection of the heat exchanger is a Victaulic connection. The condenser has a thermal insulation of 19 mm thick polyurethane foam. As standard the condenser is equipped with frost protection.

## 11.11 - Economiser

The economiser is a plate-type economiser.

## 11 - MAJOR SYSTEM COMPONENTS

---

### 11.12 - Refrigerant

TD units are charged with liquid R-407C refrigerant, a non-azeotropic refrigerant blend consisting of 23% R-32, 25% R-125 and 52% R-134a and characterised by the fact that when there is a change in state, the temperature of the liquid/vapour mixture is not constant, as with azeotropic refrigerants.

All checks must be pressure tests, and the appropriate pressure/temperature ratio table must be used to determine the corresponding saturated temperatures (saturated bubble point curve or saturated dew point curve).

Leak detection is especially important for units charged with refrigerant R-407C. Depending on whether the leak occurs in the liquid or in the vapour phase, the proportion of the different components in the remaining liquid is not the same.

**NOTE: Regularly carry out leak checks and immediately repair any leak found. If there is a leak in the plate heat exchanger, this part must be replaced.**

The refrigerant must always be recharged in the liquid phase into the liquid line.

The refrigerant cylinder must always contain at least 10% of its initial charge.

For the refrigerant quantity per circuit, refer to the data on the unit name plate.

### 11.13 - High-pressure safety switch

TD units are equipped with automatically reset high-pressure safety switches, calibrated to 3130 kPa relative pressure (soft alarm is manually reset).

**NOTES: Monitoring during operation:**

- Follow the regulations on monitoring pressurised equipment.
- It is normally required that the user or operator sets up and maintains a monitoring and maintenance file.
- Follow the control programmes of EN378, annex D.
- If they exist follow local professional recommendations.
- Regularly inspect the condition of the coating (paint) to detect blistering resulting from corrosion.
- Regularly check for possible presence of impurities (e.g. silica grains) in the heat exchange fluids. These impurities maybe the cause of the wear or corrosion by puncture.
- Filter the heat exchange fluid check and carry out internal inspections as described in EN378, annex C.
- The reports of periodical checks by the user or operator must be included in the supervision and maintenance file.

#### REPAIR

Any repair or modification, including the replacement of moving parts:

- must follow local regulations and be made by qualified operators and in accordance with qualified procedures,
- must be made in accordance with the instructions of the original manufacturer. Repair and modification that necessitate permanent assembly (soldering, welding, expanding etc.) must be made using the correct procedures and by qualified operators.

An indication of any modification or repair must be shown in the monitoring and maintenance file.



## 12 - OPTIONS AND ACCESSORIES

Options	Description	Advantages	Use
Corrosion protection, traditional coils	Fins made of pre-treated aluminum (polyurethane and epoxy)	Improved corrosion resistance, recommended for moderate marine and urban environments	•
XtraFan	Fans with 100 Pa maximum available pressure. Each fan equipped with a connection flange & sleeves allowing the connection to the ducting system.	Ducted fan discharge, optimised temperature control, based on the operating conditions and system characteristics	TD 100 to 300
Low noise level	Aesthetic and sound absorbing compressor enclosure	Noise level reduction by 1 to 2 dB(A)	•
Xtra Low Noise	Acoustic compressor enclosure and low-speed fans	Noise emission reduction at reduced fan speed	TD 100 to 300
Soft Starter	Electronic starter on each compressor	Reduced start-up current	•
Hydraulic module frost protection	Electric heater on the hydraulic module	hydraulic module frost protection at low outside temperatures down to -20°C	•
Master/slave operation	Unit equipped with supplementary water outlet temperature sensor kit to be field-installed allowing master/slave operation of two units connected in parallel	Optimised operation of two units connected in parallel operation with operating time equalisation	•
Lon gateway	Two-directional communication board complying with Lon Talk protocol	Connects the unit by communication bus to a building management system	•
Bacnet over IP	Two-directional high-speed communication using BACnet protocol over Ethernet network (IP)	Easy and high-speed connection by ethernet line to a building management system. Allows access to multiple unit parameters	•
Compliance with Russian regulations	EAC certification	Conformance with Russian regulations	•
Condenser screw connection sleeves kit	Condenser inlet/outlet screw connection sleeves	Allows unit connection to a screw connector	•
M2M supervision (accessory)	Monitoring solution which allows customers to track and monitor their equipment remotely in real time	Real-time expert technical support to improve equipment availability and reports at customer hand to monitor and optimize operating equipment.	•
Anti-vibration mounts (kit)	Elastomer antivibratils mounts to be place under the unit (Material classified B2 fire class according to DIN 4102 ).	Isolate unit from the building, avoid transmission of vibration and associate noise to the buiding. Must be associate with flexible connection on water side	•
Condenser flexibles connection (kit)	Flexibles connections on the condenser water side	Easy installation. Limit transmission of vibrations on the water network	•
Set point adjustment by 4-20mA signal	Connections to allow a 4-20mA signal input	Easy energy managment, allow to adjust set point by a 4-20mA external signal	•

## 13 - UNITS WITH FANS WITH AVAILABLE PRESSURE FOR INDOOR INSTALLATION XTRAFAN

This option applies to TD units installed inside the building in a plant room. For this type of installation the cold air leaving the air-cooled evaporators is discharged by the fans to the outside of the building, using a duct system.

The installation of a duct system at the air evaporator discharge line causes a pressure drop due to the resistance caused by the air flow.

Therefore more powerful fan motors than those used for the standard units are installed in the units with this option. For each installation of a unit installed inside a plant room the duct pressure drops differ, depending on the duct length, duct section and direction changes.

TD units equipped with fans with available pressure are designed to operate with air discharge ducts with maximum pressure drops of 100 Pa.

### 13.1 - Fan discharge connection

A square flange is supplied mounted on the unit. An available standard round flange can easily be installed at the fan discharge, if the installer prefers the use of a round connection duct.

The unit is supplied with a grille on the discharge side. This grille has to be removed before connection to the duct system.

It is advisable to make the connection to the duct system with a flexible sleeve. If this recommendation is not observed, a lot of vibration and noise may be transmitted to the building structure.

### 13.2 - Applicable rules for units incorporated into an air duct system

Ensure that the suction or discharge inlets are not accidentally obstructed by the panel positioning (e.g. low return or open doors etc.).

### 13.3 - Electrical data for TD units with XtraFan

TD - unit with XtraFan		100	120	150	200	300	
<b>Power circuit</b>							
Nominal power supply	V-ph-Hz	400-3-50					
Voltage range	V	360-440					
<b>Control circuit supply</b>		24 V, via internal transformer					
<b>Maximum start-up current (Un)<sup>(1)</sup></b>							
Standard unit	A	132	174	205	161	246	
Unit with electronic starter option	A	71	94	105	102	149	
<b>Unit power factor at maximum capacity<sup>(2)</sup></b>		0,83	0,87	0,87	0,83	0,87	
<b>Maximum unit power input<sup>(2)</sup></b>		kW	16	20	24	33	49
<b>Nominal unit current draw<sup>(3)</sup></b>		A	22	25	30	44	59
<b>Maximum unit current draw (Un)<sup>(4)</sup></b>		A	29	34	40	57	81
<b>Maximum unit current draw (Un-10%)†</b>		A	31	37	44	62	87
<b>Customer-side unit power reserve</b>		Customer reserve at the 24 V control power circuit					
<b>Short-circuit stability and protection</b>		See table on page 18					

(1) Maximum instantaneous start-up current (maximum operating current of the compressor + fan current + locked rotor current of the compressor).

(2) Power input, compressor and fan, at the unit operating limits (saturated suction temperature 10°C, saturated condensing temperature 65°C) and nominal voltage of 400 V (data given on the unit nameplate).

(3) Standardised Eurovent conditions: condenser entering/leaving water temperature = 40°C/45°C, outside air temperature db/wb = 7°C/6°C.

(4) Maximum unit operating current at maximum unit power input and 400 V (values given on the unit nameplate).

† Maximum unit operating current at maximum unit power input and 360 V.

## 14 - STANDARD MAINTENANCE

The heat pumps must be maintained by professional technicians, whilst routine checks can be carried out locally by specialised technicians. See the standard EN 378-4.

**All refrigerant charging, removal and draining operations must be carried out by a qualified technician and with the correct material for the unit. Any inappropriate handling can lead to uncontrolled fluid or pressure leaks.**

**WARNING: Before doing any work on the machine ensure that the power is switched off. If a refrigerant circuit is opened, it must be evacuated, recharged and tested for leaks. Before any operation on a refrigerant circuit, it is necessary to remove the complete refrigerant charge from the unit with a refrigerant charge recovery group.**

**Simple preventive maintenance will allow you to get the best performance from your heat pump unit:**

- improved heating performance
- reduced power consumption
- prevention of accidental component failure
- prevention of major time-consuming and costly interventions
- protection of the environment

There are five maintenance levels for the heat pump units, as defined by the AFNOR X60-010 standard.

### 14.1 - Level 1 maintenance

See note on the next page. Simple procedures, can be carried out by the user on a weekly basis:

- Visual inspection for oil traces (sign of a refrigerant leak),
- Air heat exchanger (evaporator) cleaning - see chapter 'Evaporator coil - level 1',
- Check for removed protection devices, and badly closed doors/covers,
- Check the unit alarm report when the unit does not work (see Aquaciat Caléo TD Connect Touch control manual),
- General visual inspection for any signs of deterioration,
- Verify the charge in the sight-glass,
- Check that the temperature difference between the heat exchanger inlet and outlet is correct.

### 14.2 - Level 2 maintenance

This level requires specific know-how in the electrical, hydraulic and mechanical fields. It is possible that these skills are available locally: existence of a maintenance service, industrial site, specialised subcontractor.

The frequency of this maintenance level can be monthly or annually depending on the verification type.

In these conditions, the following maintenance operations are recommended.

Carry out all level 1 operations, then: Electrical checks

- At least once a year tighten the power circuit electrical screw connections (see table with tightening torques).
- Check and retighten all control/command screw connections, if required (see table with tightening torques).
- Remove the dust and clean the interior of the control boxes, if required.
- Check the status of the contactors and disconnect switches.
- Check the presence and the condition of the electrical protection devices.
- Check the correct operation of all heaters.
- Replace the fuses every 3 years or every 15000 hours (age-hardening).
- Check that no water has penetrated into the control box.

### Mechanical checks

- Check the tightening of the fan tower, fan, compressor and control box fixing bolts.

### Water circuit checks

- Check the water connections.
- Purge the water circuit (see chapter 'Water flow control procedure').
- Clean the water filter (see chapter 'Water flow control procedure').
- Check the operation of the flow switch.
- Check the status of the thermal piping insulation.
- Check the concentration of the anti-freeze protection solution (ethylene glycol or polyethylene glycol).

### Refrigerant circuit

- Fully clean the air evaporators with a low-pressure jet and a bio-degradable cleaner (counter-current cleaning - see chapter 'Evaporator coil - level 2').
- Check the unit operating parameters and compare them with previous values.
- Carry out an oil contamination test. Replace the oil, if necessary.
- Check the operation of the high-pressure switches. Replace them if there is a fault.
- Check the fouling of the filter drier. Replace it if necessary.
- Keep and maintain a maintenance sheet, attached to the unit.

**All these operations require strict observation of adequate safety measures: individual protection garments, compliance with all industry regulations, compliance with applicable local regulations and using common sense.**

### 14.3 - Level 3 (or higher) maintenance

The maintenance at this level requires specific skills/approval/tools and know-how and only the manufacturer, his representative or authorised agent are permitted to carry out these operations. These maintenance operations concern for example:

- a major component replacement (compressor, condenser),
- any intervention on the refrigerant circuit (handling refrigerant),
- changing of parameters set at the factory (application change),
- removal or dismantling of the unit,
- any intervention due to a missed established maintenance operation,
- any intervention covered by the warranty.

**To reduce waste, the refrigerant and the oil must be transferred in accordance with applicable regulations, using methods that limit refrigerant leaks and pressure drops and with materials that are suitable for the products.**

**Any detected leaks must be repaired immediately.**

**The compressor oil that is recovered during maintenance contains refrigerant and must be treated accordingly.**

**Refrigerant under pressure must not be purged to the open air.**

**If a refrigerant circuit is opened, plug all openings, if the operation takes up to one day, or for longer periods charge the circuit with nitrogen.**

**NOTE: Any deviation or non-observation of these maintenance criteria will render the guarantee conditions for the unit nul and void, and the manufacturer, CIAT, will no longer be held responsible.**

## 14 - STANDARD MAINTENANCE

### 14.4 - Tightening torques for the main electrical screw connections

Screw type	Designation in the unit	Torque (N·m)
<b>Soldered screw (PE) customer connection</b>		
M8	PE	80
<b>Screw on switch inlet zones</b>		
Switch 3LD2114-0TK51	QS_	2-2.5
Switch 3LD2214-0TK51		2-2.5
Switch 3LD2514-0TK51		2.5-3
Switch 3LD2714-0TK51		2.5-3
<b>Tunnel terminal screw, compressor protection</b>		
Fuse 3NW6120-1	QM <sup>(1)</sup>	1.2
<b>Tunnel terminal screw, compressor contactor</b>		
Contactor 3RT1034-2AB00	KM <sup>(1)</sup>	3-4.5
<b>Tunnel terminal screw, fan, heater, pump protection</b>		
Disconnect switch 3RV1011-1BA10	QM <sup>(1)</sup>	0.8-1.2
<b>Tunnel terminal screw, heater relay</b>		
Relay 3RH1122-2AB00	KM <sup>(1)</sup>	0.8-1.2
<b>Tunnel terminal screw, auxiliary contact</b>		
Auxiliary terminal block 3RH1911-2FA11	-	0.8-1.2
Auxiliary terminal block 3RH1921-2FA22		
<b>Tunnel terminal screw, control power transformer</b>		
Transformer 4AM3496-0FS30-0EN1	TC	0.8-1.2
<b>Compressor earth terminal</b>		
M8	Gnd	12

(1) The spring-loaded terminal connections are designed to ensure permanent affixture on the conductor.

### 14.5 - Tightening torques for the main bolts and screws

Screw type	Used for	Torque (N·m)
Compressor strut	Compressor support	30
M8 nut	BPHE <sup>(1)</sup> fixing	15
M10 nut	Compressor mounting	30
M16 nut	Compressor fixing	30
Oil nut	Oil equalisation line	75
Taptite screw M6	Fan support	7
Taptite screw M8	Fan motor fixing	13
H M8 screw	Fan scroll fixing	18
Metal screw	Sheet metal plates	4.2
H M6 screw	Stauff clamps	10
Earth screw	Compressor	2.8

(1) BPHE = Brazed plate heat exchanger

### 14.6 - Evaporator coil

We recommend, that finned coils are inspected regularly to check the degree of fouling. This depends on the environment where the unit is installed, and will be worse in urban and industrial installations and near trees that shed their leaves.

For coil cleaning, two maintenance levels are used, based on the AFNOR X60-010 standard:

#### Level 1

- If the evaporator coils are fouled, clean them gently in a vertical direction, using a brush.
- Only work on air evaporators with the fans switched off.
- For this type of operation switch off the heat pump if service considerations allow this.
- Clean evaporators guarantee optimal operation of your unit. Cleaning is necessary when the evaporators begin to become fouled. The frequency of cleaning depends on the season and location of the unit (venti-lated, wooded, dusty area, etc.).

#### Level 2

The two cleaning products can be used for any Cu/Al coil with protection.

Clean the coil, using appropriate products.

We recommend TOTALINE products for coil cleaning:

Part No. P902 DT 05EE: traditional cleaning method

Part No. P902 CL 05EE: cleaning and degreasing.

These products have a neutral pH value, do not contain phosphates, are not harmful to the human body, and can be disposed of through the public drainage system.

Depending on the degree of fouling both products can be used diluted or undiluted.

For normal maintenance routines we recommend using 1 kg of the concentrated product, diluted to 10%, to treat a coil surface of 2 m<sup>2</sup>. This process can either be carried out using a high-pressure spray gun in the low-pressure position.

With pressurised cleaning methods care should be taken not to damage the coil fins. The spraying of the coil must be done:

- in the direction of the fins
- in the opposite direction of the air flow direction
- with a large diffuser (25-30°)
- at a minimum distance of 300 mm from the coil.

It is not necessary to rinse the coil, as the products used are pH neutral. To ensure that the coil is perfectly clean, we recommend rinsing with a low water flow rate. The pH value of the water used should be between 7 and 8.

**WARNING: Never use pressurised water without a large diffuser. Do not use high-pressure cleaners for Cu/Al coils.**

**Concentrated and/or rotating water jets are strictly forbidden. Never use a fluid with a temperature above 45°C to clean the air heat exchangers.**

**Correct and frequent cleaning (approximately every three months) will prevent 2/3 of the corrosion problems.**

**Protect the control box during cleaning operations.**

### 14.7 - Condenser maintenance

Check that:

- the insulating foam is intact and securely in place.
- the cooler heaters are operating, secure and correctly positioned.
- the water-side connections are clean and show no sign of leakage.

## 14 - STANDARD MAINTENANCE

### 14.8 - Characteristics of R-407C

Relative pressure, bar	Saturated bubble point temp., °C	Saturated dew point temp., °C	Relative pressure, bar	Saturated bubble point temp., °C	Saturated dew point temp., °C	Relative pressure, bar	Saturated bubble point temp., °C	Saturated dew point temp., °C
1	-28.55	-21.72	10.5	23.74	29.35	20	47.81	52.55
1.25	-25.66	-18.88	10.75	24.54	30.12	20.25	48.32	53.04
1.5	-23.01	-16.29	11	25.32	30.87	20.5	48.83	53.53
1.75	-20.57	-13.88	11.25	26.09	31.62	20.75	49.34	54.01
2	-18.28	-11.65	11.5	26.85	32.35	21	49.84	54.49
2.25	-16.14	-9.55	11.75	27.6	33.08	21.25	50.34	54.96
2.5	-14.12	-7.57	12	28.34	33.79	21.5	50.83	55.43
2.75	-12.21	-5.7	12.25	29.06	34.5	21.75	51.32	55.9
3	-10.4	-3.93	12.5	29.78	35.19	22	51.8	56.36
3.25	-8.67	-2.23	12.75	30.49	35.87	22.25	52.28	56.82
3.5	-7.01	-0.61	13	31.18	36.55	22.5	52.76	57.28
3.75	-5.43	0.93	13.25	31.87	37.21	22.75	53.24	57.73
4	-3.9	2.42	13.5	32.55	37.87	23	53.71	58.18
4.25	-2.44	3.85	13.75	33.22	38.51	23.25	54.17	58.62
4.5	-1.02	5.23	14	33.89	39.16	23.5	54.64	59.07
4.75	0.34	6.57	14.25	34.54	39.79	23.75	55.1	59.5
5	1.66	7.86	14.5	35.19	40.41	24	55.55	59.94
5.25	2.94	9.11	14.75	35.83	41.03	24.25	56.01	60.37
5.5	4.19	10.33	15	36.46	41.64	24.5	56.46	60.8
5.75	5.4	11.5	15.25	37.08	42.24	24.75	56.9	61.22
6	6.57	12.65	15.5	37.7	42.84	25	57.35	61.65
6.25	7.71	13.76	15.75	38.31	43.42	25.25	57.79	62.07
6.5	8.83	14.85	16	38.92	44.01	25.5	58.23	62.48
6.75	9.92	15.91	16.25	39.52	44.58	25.75	58.66	62.9
7	10.98	16.94	16.5	40.11	45.15	26	59.09	63.31
7.25	12.02	17.95	16.75	40.69	45.71	26.25	59.52	63.71
7.5	13.03	18.94	17	41.27	46.27	26.5	59.95	64.12
7.75	14.02	19.9	17.25	41.85	46.82	26.75	60.37	64.52
8	14.99	20.85	17.5	42.41	47.37	27	60.79	64.92
8.25	15.94	21.77	17.75	42.98	47.91	27.25	61.21	65.31
8.5	16.88	22.68	18	43.53	48.44	27.5	61.63	65.71
8.75	17.79	23.57	18.25	44.09	48.97	27.75	62.04	66.1
9	18.69	24.44	18.5	44.63	49.5	28	62.45	66.49
9.25	19.57	25.29	18.75	45.17	50.02	28.25	62.86	66.87
9.5	20.43	26.13	19	45.71	50.53	28.5	63.27	67.26
9.75	21.28	26.96	19.25	46.24	51.04	28.75	63.67	67.64
10	22.12	27.77	19.5	46.77	51.55	29	64.07	68.02
10.25	22.94	28.56	19.75	47.29	52.05	29.25	64.47	68.39

TD units use R-407C refrigerant. Special equipment must be used when working on the refrigerant circuit (pressure gauge, charge transfer, etc.).

# 15 - START-UP CHECKLIST FOR TD HEAT PUMPS (USE FOR JOB FILE)

## Preliminary information

Job name: .....  
Location: .....  
Installing contractor: .....  
Distributor: .....  
Start-up performed by: ..... Date: .....

## Equipment

Model TD: ..... S/N .....

## Compressors

1. Model No. .... 2 Model No. ....  
Serial No. .... Serial No. ....

## Air handling equipment

Manufacturer .....  
Model No. .... Serial No. ....

Additional air handling units and accessories .....

## Preliminary equipment check

Is there any shipping damage? ..... If so, where? .....  
Will this damage prevent unit start-up? .....

- Unit is level in its installation
- Power supply agrees with the unit name plate
- Electrical circuit wiring has been sized and installed properly
- Unit ground wire has been connected
- Electrical circuit protection has been sized and installed properly
- All terminals are tight
- All cables and thermistors have been inspected for crossed wires
- All plug assemblies are tight

## Check air handling systems

- All air handlers are operating
- All water valves are open
- All fluid piping is connected properly
- All air has been vented from the system
- Hot-water pump is operating with the correct rotation. CWP amperage: Rated: ..... Actual: .....

## Unit start-up

- Hot-water pump control has been properly interlocked with the heat pump
- Oil level is correct
- Compressor crankcase heaters have been energised for 12 hours
- Unit has been leak checked (including fittings)
- Locate, repair, and report any refrigerant leaks

Check voltage imbalance: AB ..... AC ..... BC .....  
Average voltage = ..... (see installation instructions)  
Maximum deviation = ..... (see installation instructions)  
Voltage imbalance = ..... (see installation instructions) ...

- Voltage imbalance is less than 2%

**WARNING: Do not start the heat pump if voltage imbalance is greater than 2%. Contact local power company for assistance.**

- All incoming power voltage is within rated voltage range

# 15 - START-UP CHECKLIST FOR TD HEAT PUMPS (USE FOR JOB FILE)

## Check condenser water loop

Water loop volume = ..... (litres)  
Calculated volume = ..... (litres)

- Proper loop volume established
- Proper loop corrosion inhibitor included ..... litres of .....
- Proper loop freeze protection included (if required) ..... litres of .....
- Water piping includes electric tape heater up to the condenser
- Return water piping is equipped with a screen filter with a mesh size of 1.2 mm

## Check the external static pressure

Entering condenser = ..... (kPa)  
Leaving condenser = ..... (kPa)  
External static pressure (leaving - entering) = ..... (kPa)

**A flow rate indication is displayed by the unit control (consult the Aquaciat Caléo TD Connect Touch control manual).**

- Flow rate from unit control, l/s = .....
- Nominal flow rate, l/s = .....
- The flow rate in l/s is higher than the minimum unit flow rate
- The flow rate in l/s corresponds to the specification of ..... (l/s)

**Carry out the QUICK TEST function (see Aquaciat Caléo TD Connect Touch control manual):**

## Check and log on to the user menu configuration

Load sequence selection.....  
Capacity ramp loading selection.....  
Start-up delay .....  
Burner section .....  
Pump control .....  
Setpoint reset mode .....  
Night-time capacity setback.....

**Re-enter the setpoints (see controls section)**

## To start up the heat pump

**WARNING: Be sure that all service valves are open, and that the pump is on before attempting to start this machine. Once all checks have been made, start the unit in the "LOCAL ON" position.**

Unit starts and operates properly

## Temperatures and pressures

**WARNING: Once the machine has been operating for a while and the temperatures and pressures have stabilized, record the following:**

BPHE entering water .....  
BPHE leaving water.....  
Outside air temperature .....  
Suction pressure.....  
Discharge pressure .....  
Suction temperature .....  
Discharge temperature.....  
Liquid line temperature.....  
.....

**NOTES:**.....  
.....



**Head office**

Avenue Jean Falconnier B.P. 14  
01350 Culoz - France  
Tel. : +33 (0)4 79 42 42 42  
Fax : +33 (0)4 79 42 42 10  
[www.ciat.com](http://www.ciat.com)

**Compagnie Industrielle  
d'Applications Thermiques**  
Corporation with a capital of €26,728,480  
R.C.S. Bourg-en-Bresse B 545.620.114



ISO9001 • ISO14001  
OHSAS 18001

**CIAT Service**

Tel. : 08 11 65 98 98 - Fax : 08 26 10 13 63  
(€0.15/min)

Non-contractual document. As part of our continuous drive to improve our products, CIAT reserves the right to make any technical modifications without prior notice.



Avec Ecofolio  
tous les papiers  
se recyclent.