

SCHEMA ELECTRIQUE ELECTRICAL DIAGRAM



				NUMERO DE COMMANDE : ORDER NUMBER :			
				CLIENT : CUSTOMER :			
				APPAREIL OU UNITE : TYPE OF UNIT : DF CLRZ 2000			
				TENSION : SUPPLY : 3 ~ 400V 50Hz + PE			
				REFERENCE : REFERENCE :			
				DESIGNATION : DESIGNATION :			
BFR-AGP	02/04/2021	00	CREATION				
DESS	DATE	IND	MODIFICATION				
N° OMT :		CREATEUR : CREATED BY : BFR-AGP		LEGENDE : LEGEND :	NUMERO DE SCHEMA DIAGRAM NUMBER	INDICE INDEX	FOLIO FOLIO
		DATE : 02/04/2021 DATE :			7590351	00	1 / 8

ALIMENTATION
3 ~ 400V 50Hz + PE
RACCORDEMENT SUR
LE SECTIONNEUR
SUPPLY
3 ~ 400V 50Hz + PE
CONNECTION ON
ISOLATOR

CALIBRES SECTIONNEURS FLOWAY RHEZ
DISCONNECTOR RATINGS FOR FLOWAY RHEZ

	Q1 Sans batterie electrique interne Without internal electric heater	Q1 Avec batterie electrique interne With internal electric heater	Q2 Caisson additionnel batterie electrique Additional box electric heater
CLASSIC RHEZ 2000	OT40 (40A)	OT40 (40A)	OT40 (40A)

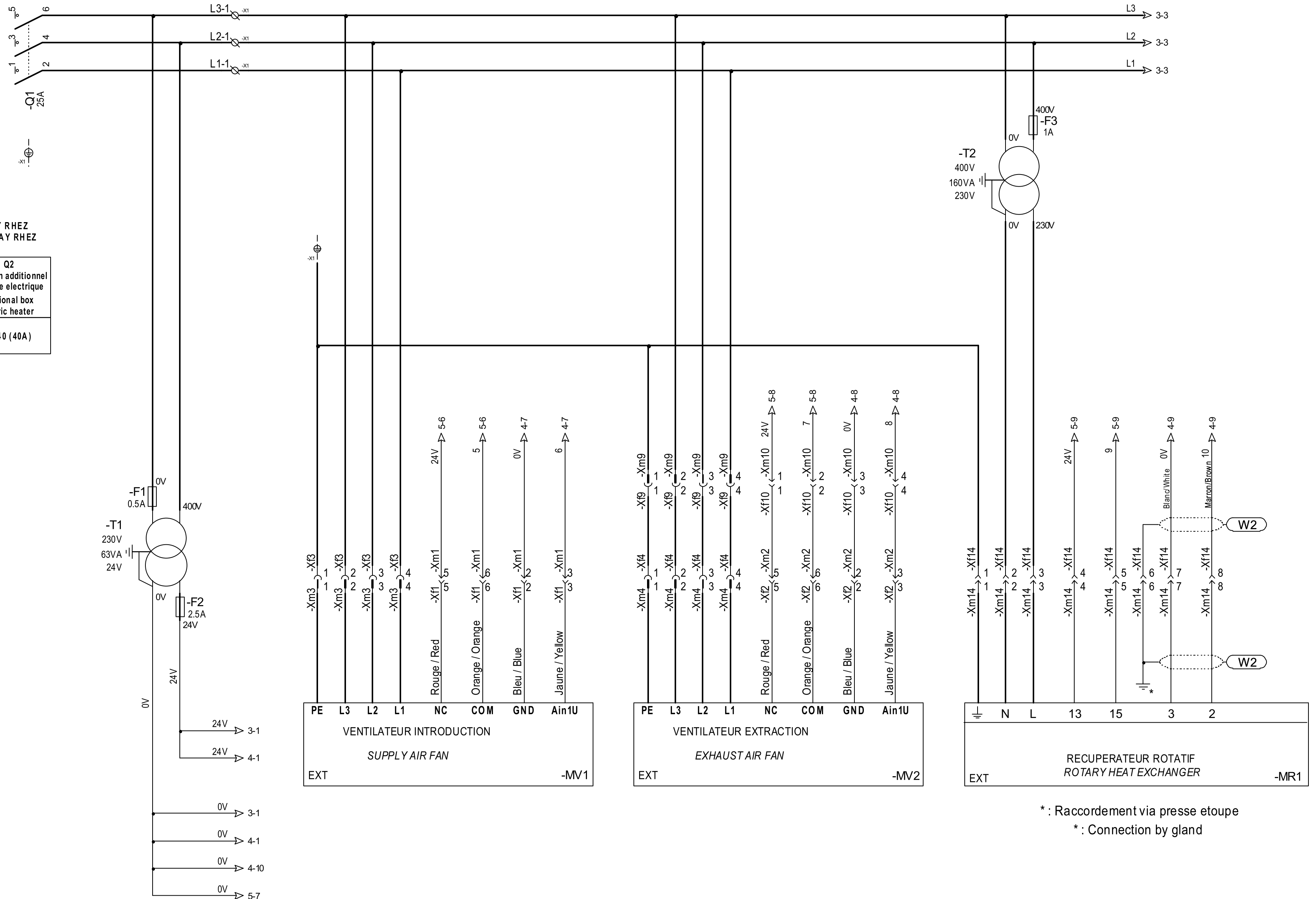

* : Raccordement via presse etoupe
* : Connection by gland

ARM

DESIGNATION :
DESIGNATION :



PUISSANCE
POWER

NUMERO DE SCHEMA
DIAGRAM NUMBER

7590351

INDICE
INDEX

00

FOLIO
FOLIO

2/8

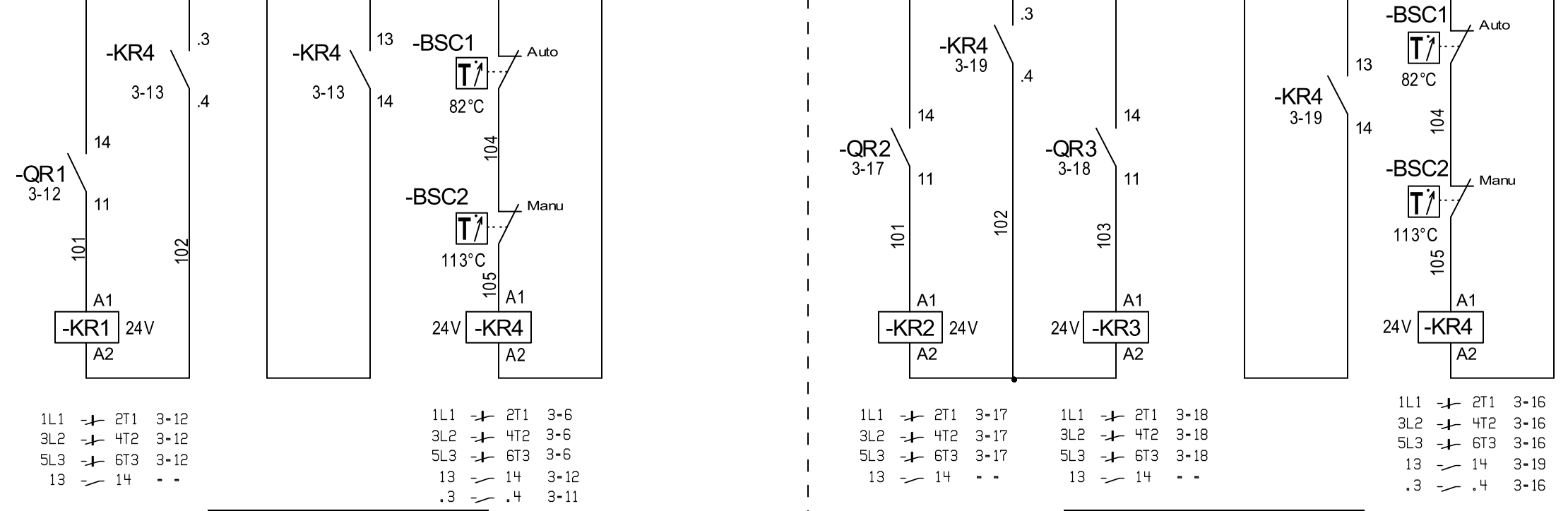
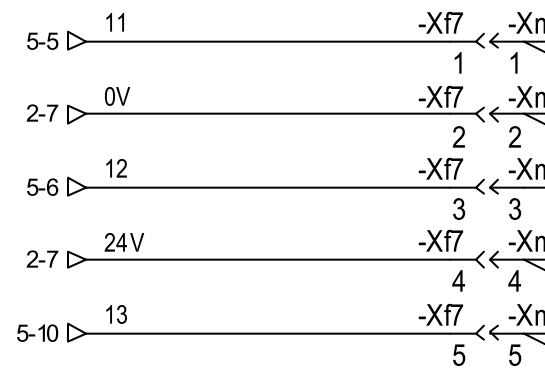
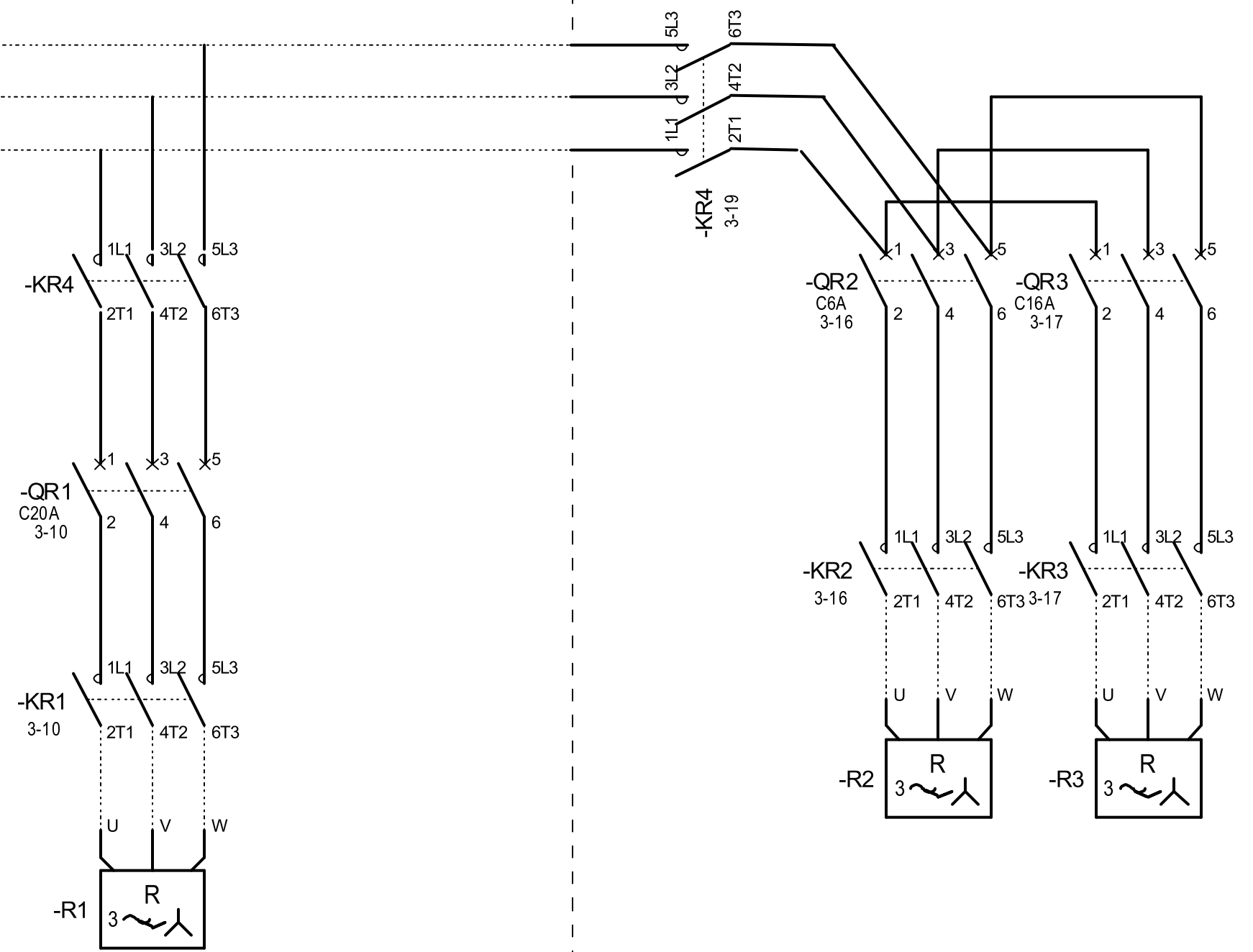
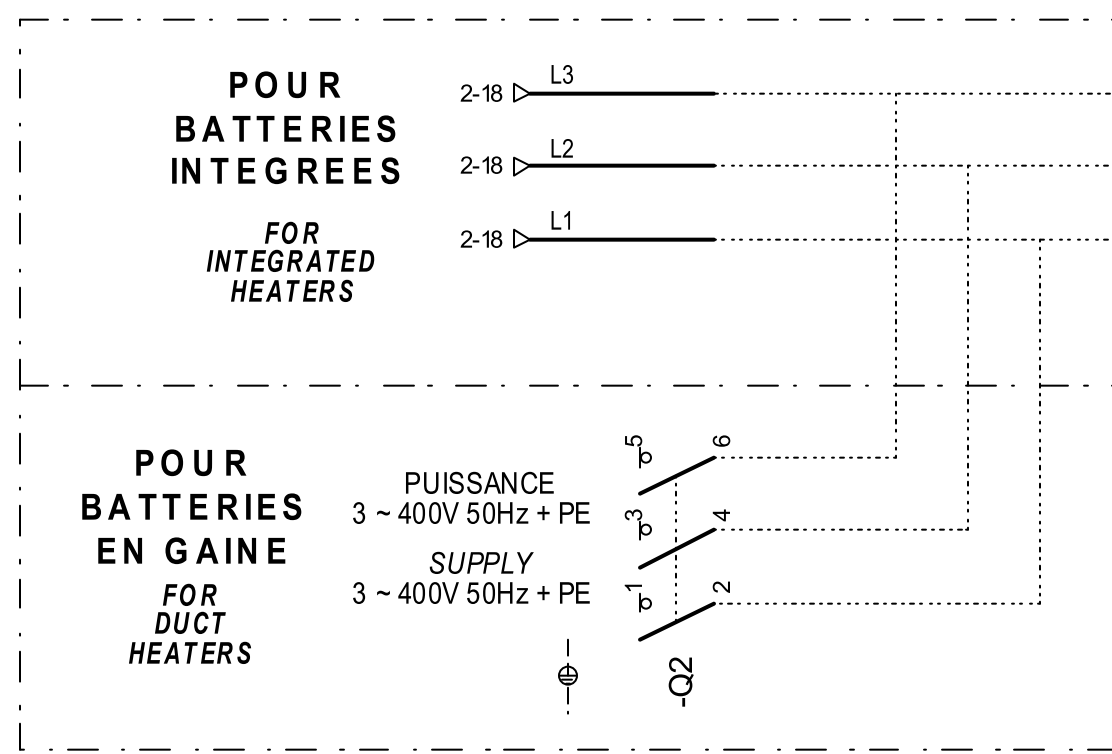

**Batterie 1 étage
Step 1 electric heater**

**Batterie 2 étages
Step 2 electric heater**

DESIGNATION :
DESIGNATION :



**BATTERIES ELECTRIQUES
ELECTRIC HEATER**

NUMERO DE SCHEMA
DIAGRAM NUMBER

7590351

INDICE
INDEX

00

FOLIO
FOLIO

3/8

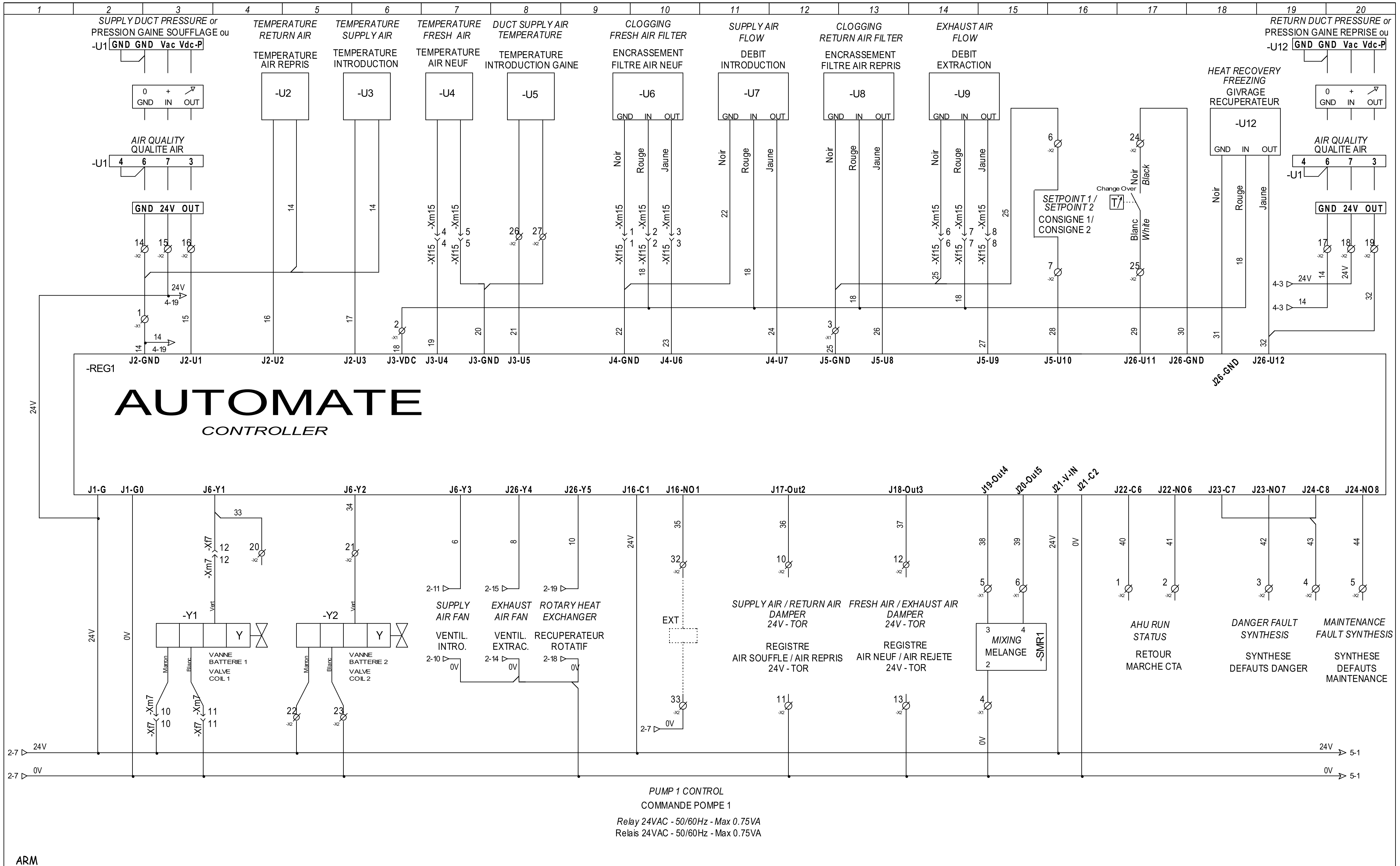

ARM

DESIGNATION :
 DESIGNATION :



COMMANDE CONTROL

NUMERO DE SCHEMA
 DIAGRAM NUMBER
7590351

INDICE
 INDEX
00

FOLIO
 FOLIO
4/8

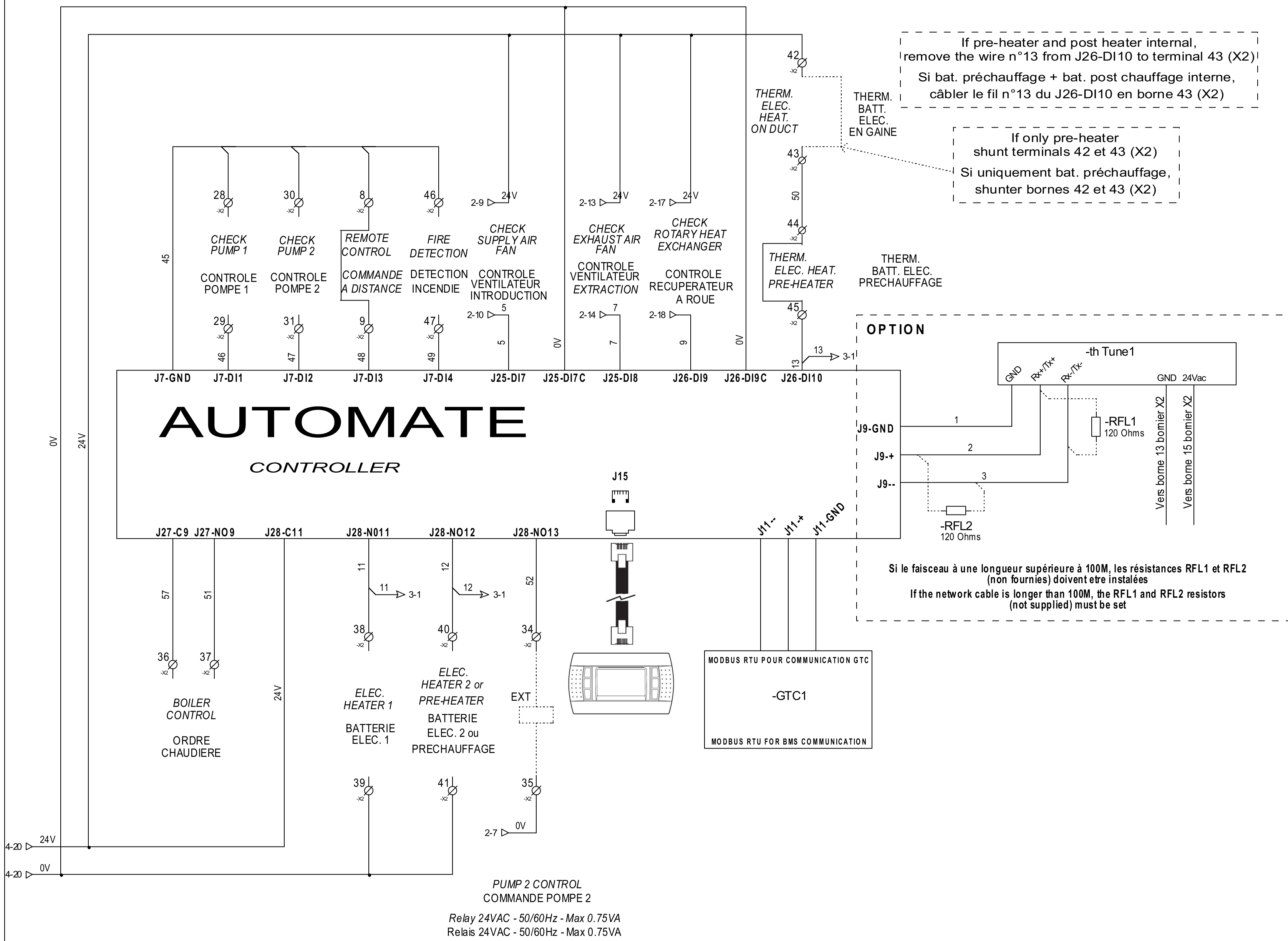

If pre-heater and post heater internal, remove the wire n°13 from J26-DI10 to terminal 43 (X2)
 Si bat. préchauffage + bat. post chauffage interne, câbler le fil n°13 du J26-DI10 en borne 43 (X2)

If only pre-heater shunt terminals 42 et 43 (X2)
 Si uniquement bat. préchauffage, shunter bornes 42 et 43 (X2)

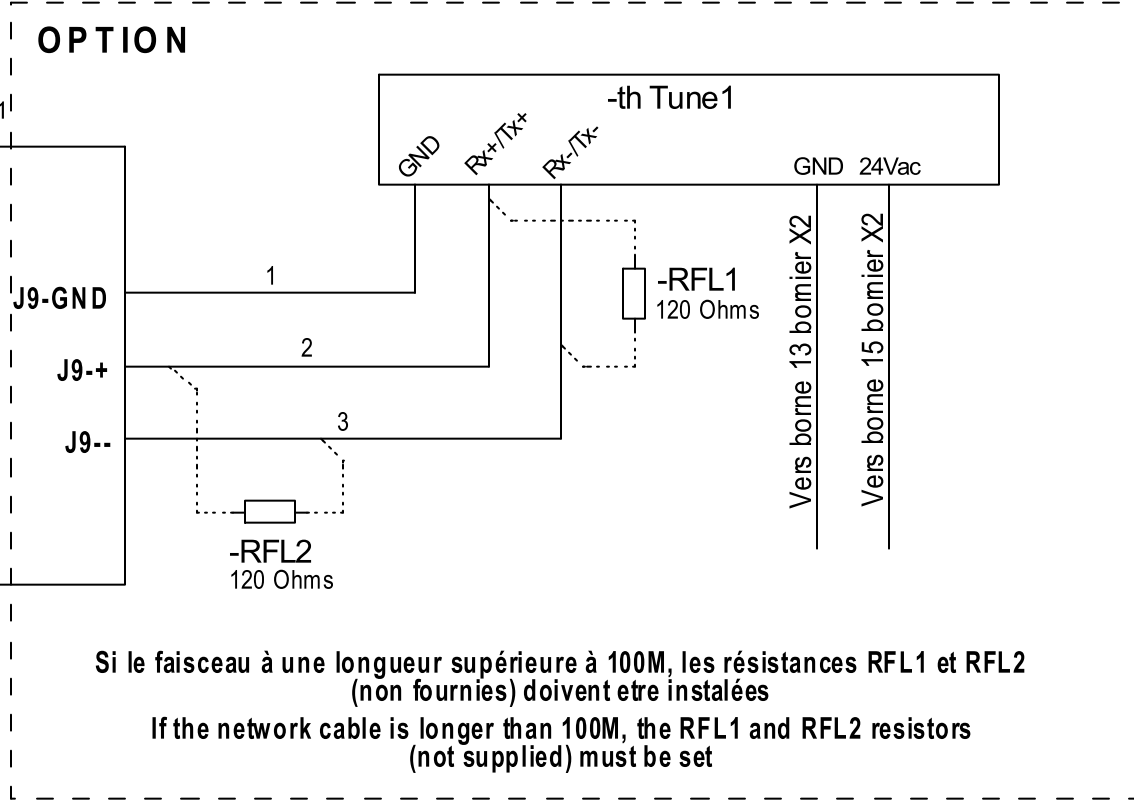

PUMP 2 CONTROL
 COMMANDE POMPE 2
 Relay 24VAC - 50/60Hz - Max 0.75VA
 Relais 24VAC - 50/60Hz - Max 0.75VA

ARM

DESIGNATION :
 DESIGNATION :

Ce document est la propriété de Ciat, il ne peut être utilisé, reproduit ou communiqué sans autorisation écrite



COMMANDE - 2 CONTROL - 2		
NUMERO DE SCHEMA DIAGRAM NUMBER	INDICE INDEX	FOLIO FOLIO
7590351	00	5/8

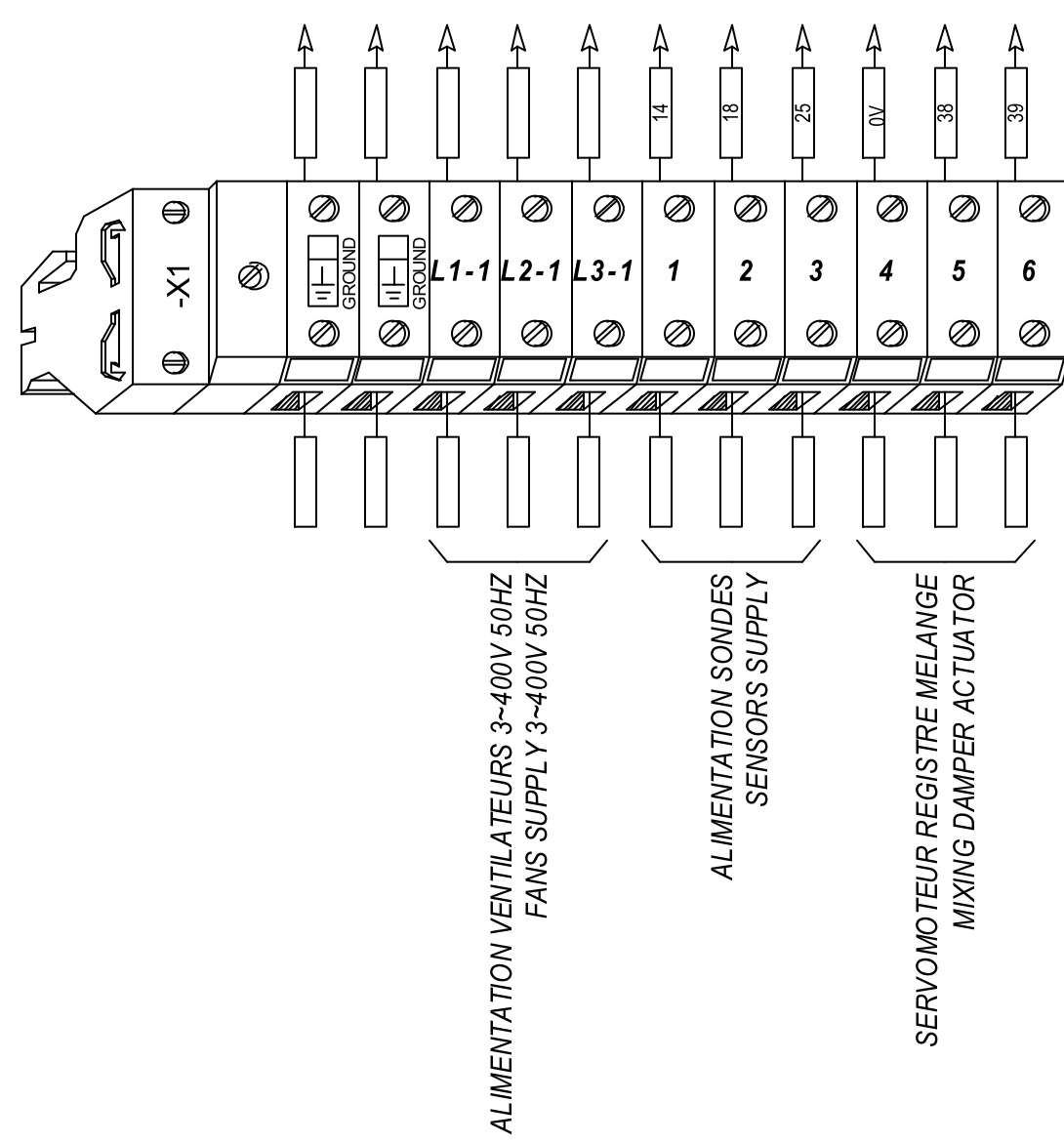

ARM

DESIGNATION :
DESIGNATION :



BORNIER : X1
TERMINAL : X1

NUMERO DE SCHEMA
DIAGRAM NUMBER
7590351

INDICE
INDEX
00

FOLIO
FOLIO
6/8

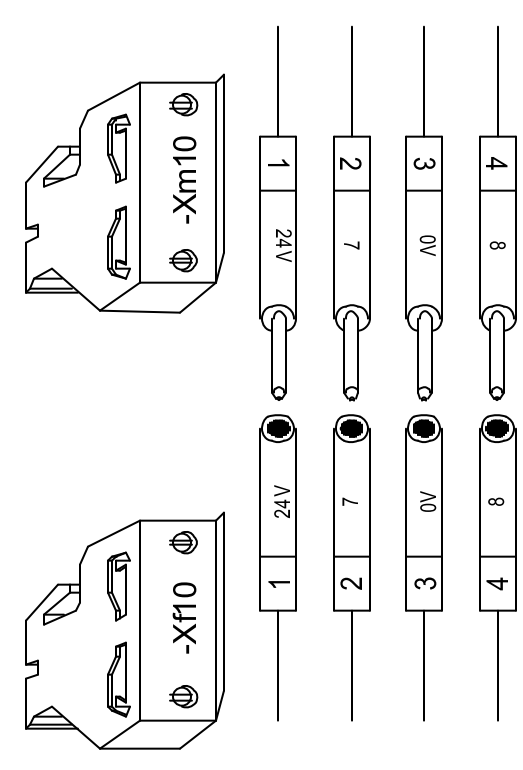
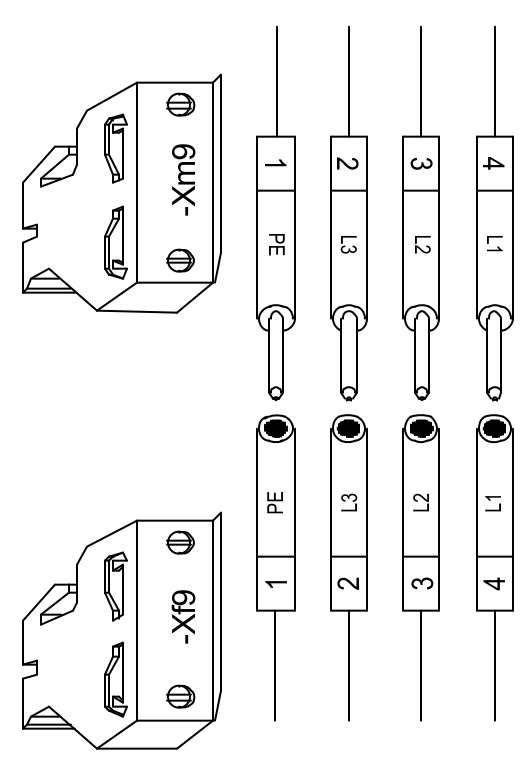
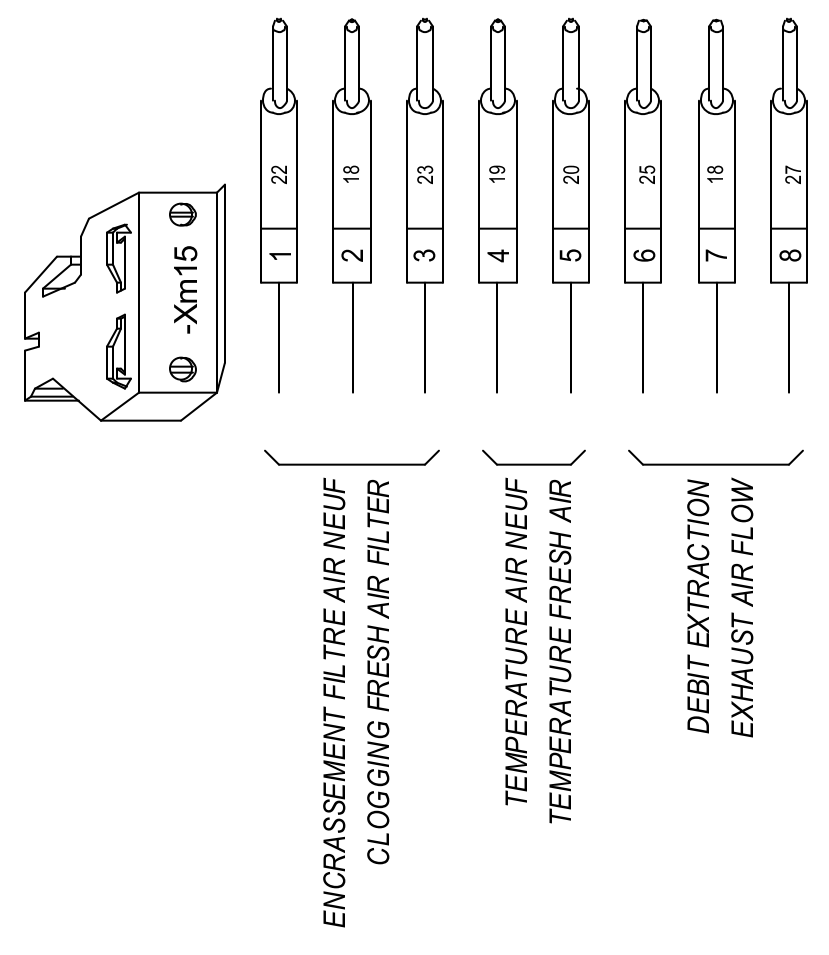
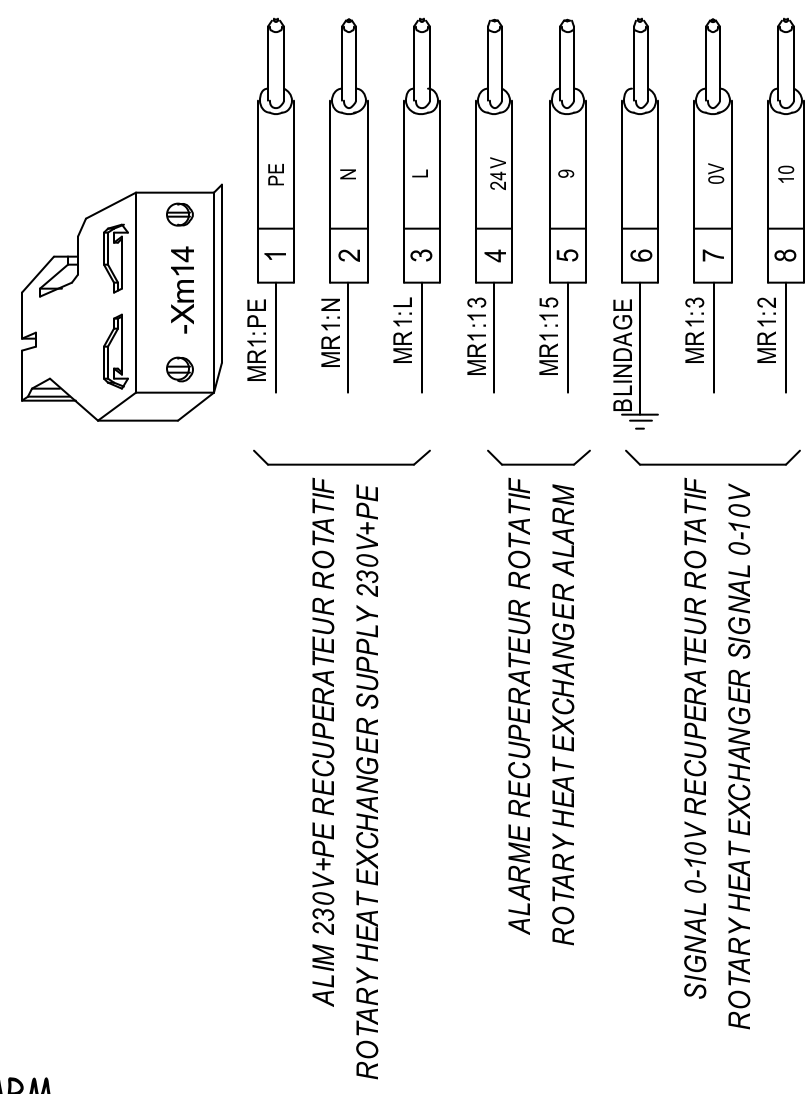
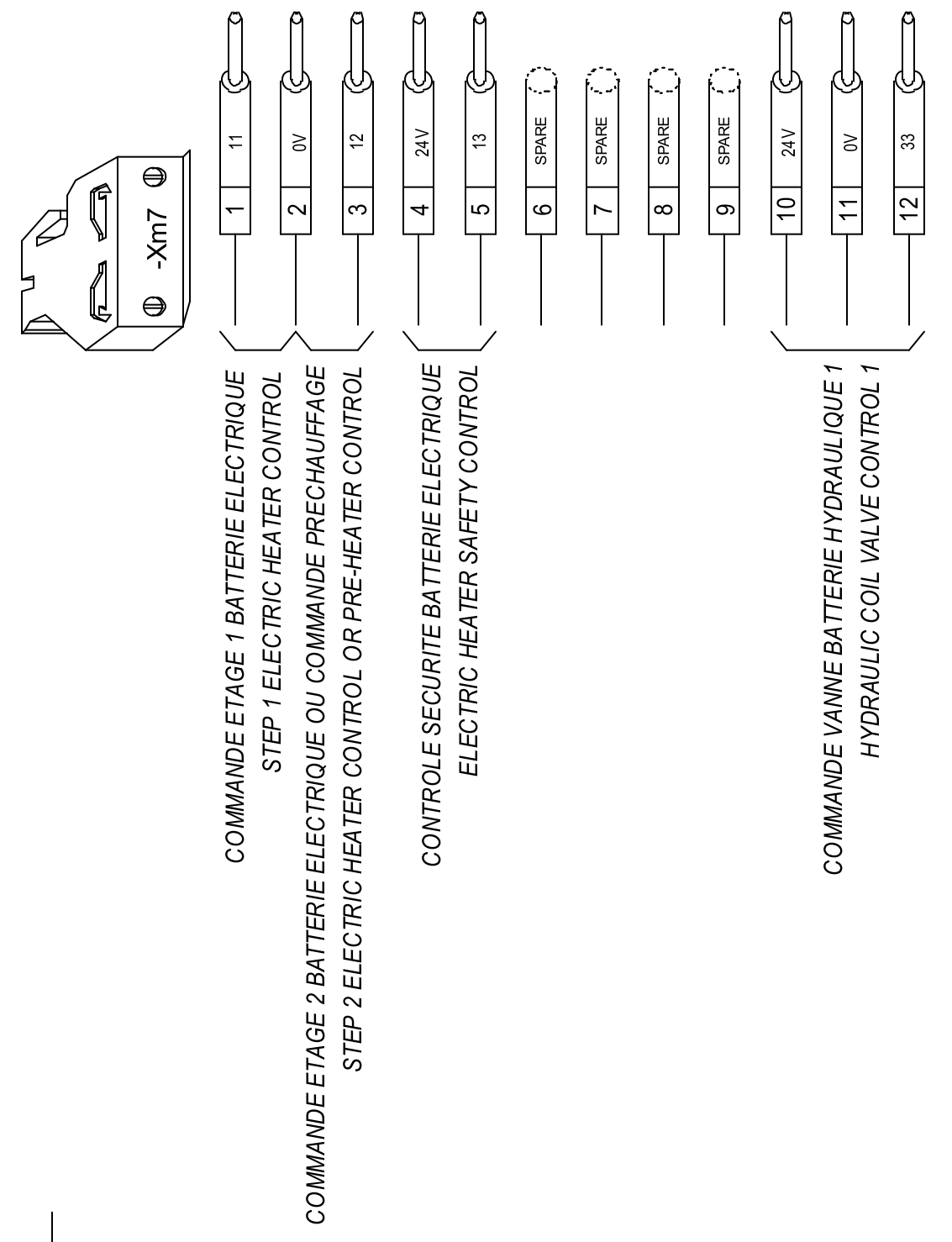
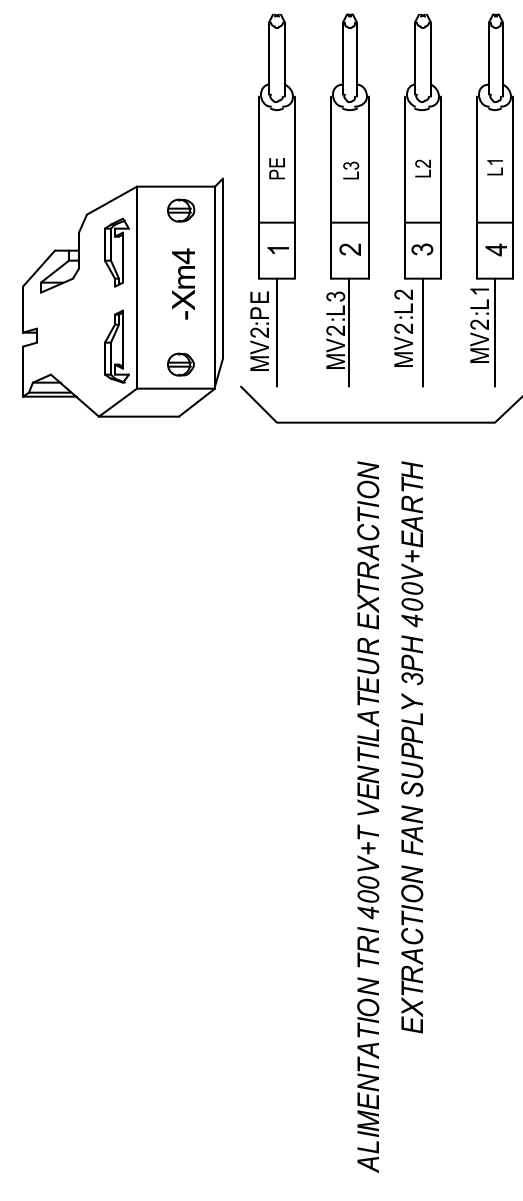
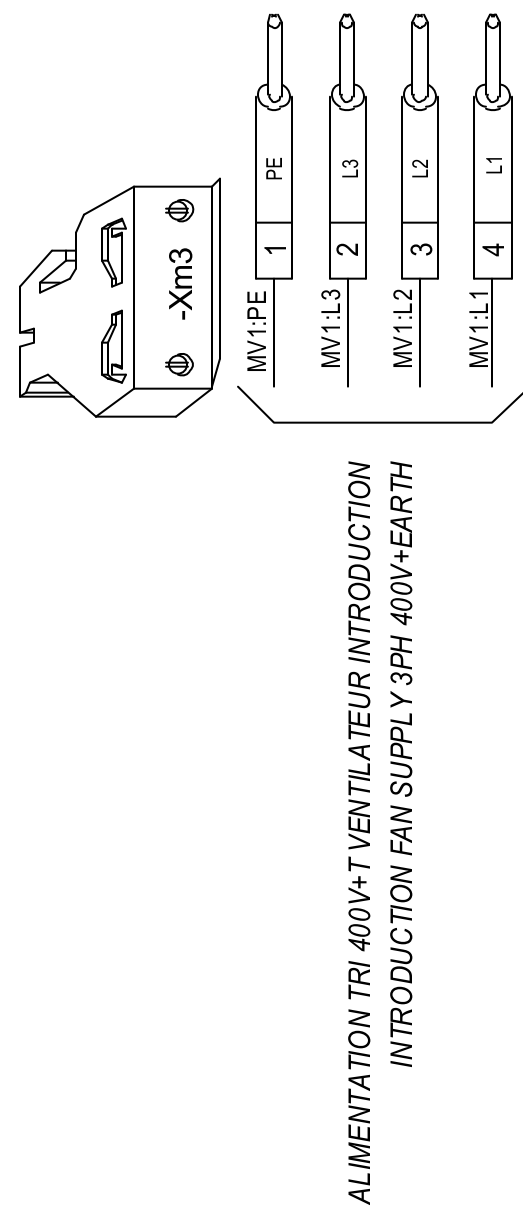
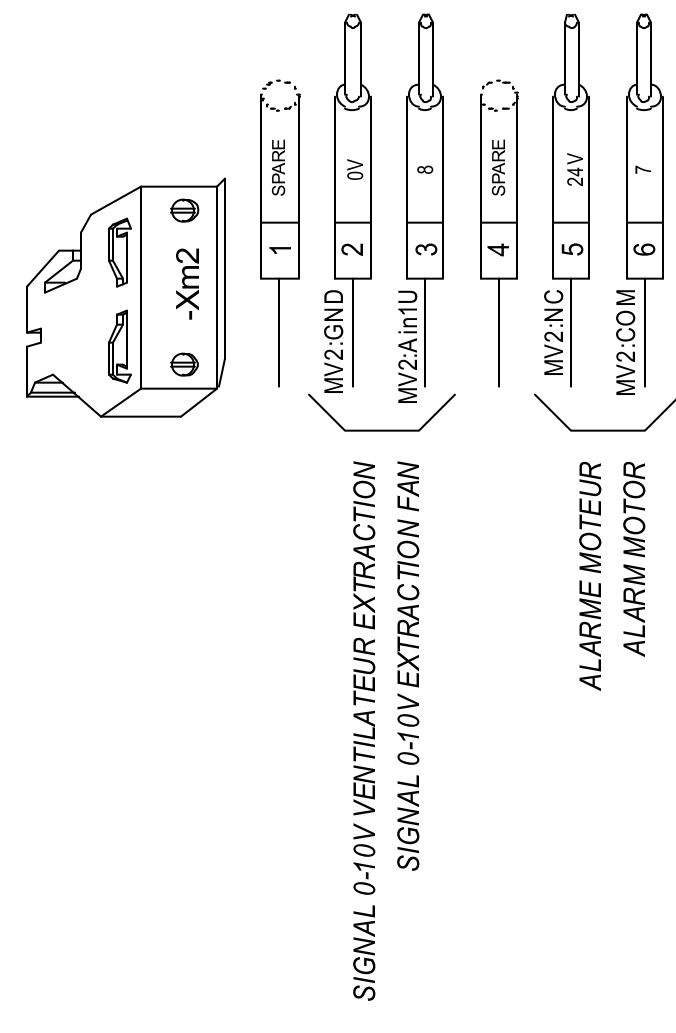
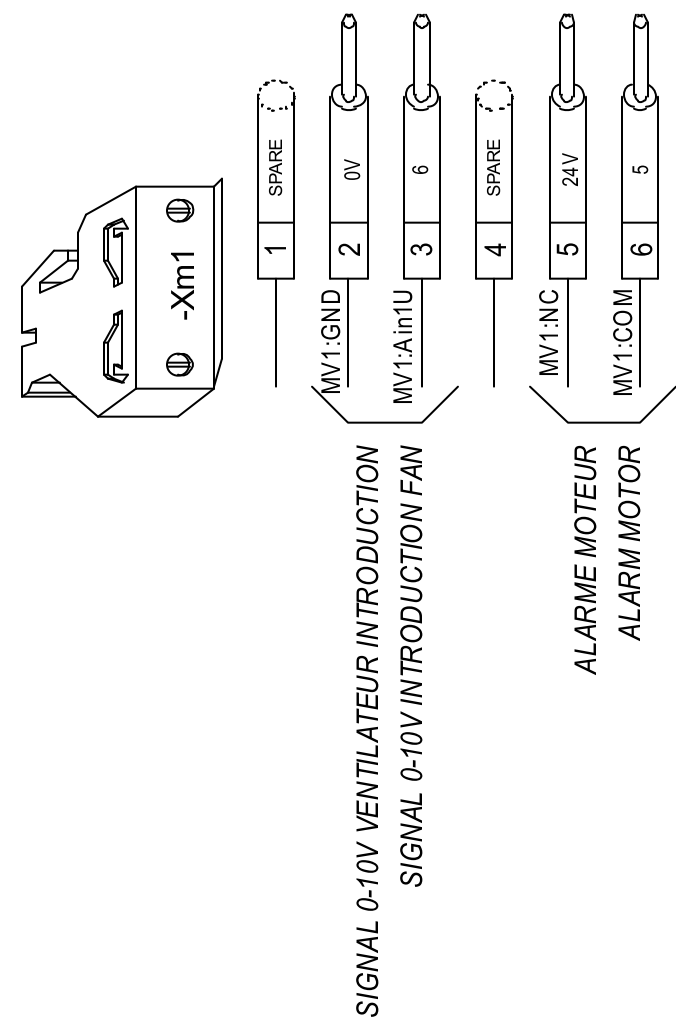

ARM

DESIGNATION :
DESIGNATION :



CONNECTEURS : Xm1, 2, 3, 4, 7, 9, 10, 14 et 15
CONNECTORS : Xm1, 2, 3, 4, 7, 9, 10, 14 and 15

NUMERO DE SCHEMA
DIAGRAM NUMBER

7590351

INDICE
INDEX

00

FOLIO
FOLIO

7/8

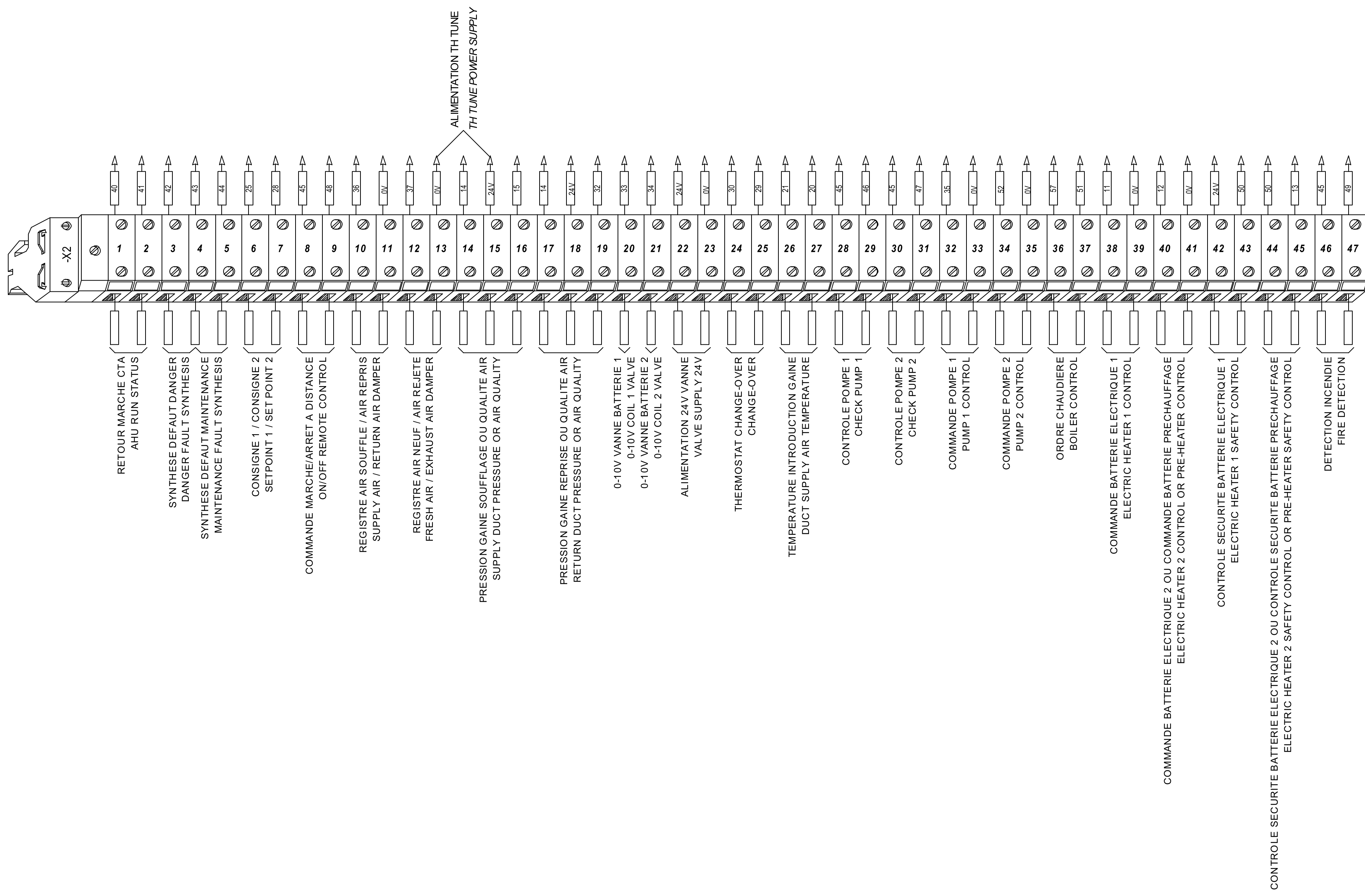

ARM

DESIGNATION :
DESIGNATION :



BORNIER : X2
TERMINAL : X2

NUMERO DE SCHEMA
DIAGRAM NUMBER
7590351

INDICE
INDEX
00

FOLIO
FOLIO
8/8