

Air-air and  
water-air units

CONTROL BROCHURE

NA 14.33 D 06 - 2017

**Electronic control**

**CIATrto**

# Contents

1. General description .....	3	13. Outlet air temperature control.....	26
1.1. Communications .....	4	14. Outdoor air damper .....	27
1.2. Supervision solutions .....	4	14.1. Free-cooling .....	27
2. Set-up .....	5	14.2. Air refreshing.....	28
2.1. µPC MEDIUM control board .....	5	14.3. Overpressure .....	29
2.2. pGD1 graphic terminal .....	5	15. Defrosting function.....	29
2.3. Sensors .....	5	15.1. Defrosting operation.....	29
2.4. TCO user terminal (optional).....	6	16. Anti-freeze safety in water-air.....	30
2.5. pCOe expansion cards (optional).....	6	17. Outdoor T compensation .....	30
2.6. BMS communication card (optional).....	6	18. Schedule programming .....	31
3. User terminals .....	6	18.1. Schedule programming with pGD1 terminal .....	31
3.1. pGD1 terminal (standard) .....	6	18.2. Schedule programming with TCO terminal .....	32
3.2. TCO user terminal (optional).....	7	19. Alarms.....	33
4. Input / output of the main control board.....	8	19.1. Alarm display.....	33
4.1. Location of the sensors on the machine .....	10	19.2. Alarms list.....	34
4.2. Connection of RS485 probes to the control board .....	10	20. Sensors .....	36
4.3. Connection of terminals to the control board .....	11	20.1. Selection of the sensor type.....	36
5. Expansion cards .....	12	20.2. Sensor configuration .....	36
5.1. pCOe expansion card No.1 (unit 4 circuits) .....	12	20.3. Calibration .....	36
5.2. pCOe expansion card No.2 (condensation control of the indoor unit & GREAT COLD).....	13	20.4. Probe filters .....	36
5.3. pCOe expansion card No.3 (zoning into 2 areas and/or variable rotary recovery) .....	14	21. Maintenance .....	36
6. Stopping / starting the unit.....	15	21.1. Time counter setting.....	36
7. Temperature control.....	15	21.2. Input / output test .....	36
8. Operating mode.....	16	22. Description of GENERAL INFORMATION displays.....	37
8.1. COOLING operating mode (summer) .....	17	23. Description of HELP displays .....	38
8.2. HEATING operating mode (winter) .....	17	24. Description of MAIN MENU displays .....	39
8.3. VENTILATION operating mode.....	18	24.1. SETPOINT displays .....	39
8.4. Forced disconnection of stages .....	18	24.2. INPUT/OUTPUT displays.....	40
9. Humidity control.....	19	24.3. Unit OFF / ON displays .....	47
9.1. Dehumidification.....	19	24.4. WINTER/SUMMER displays.....	47
9.2. Humidification.....	19	24.5. SCHEDULE PROGRAMMING displays.....	48
10. Active recovery .....	19	24.6. GAS BURNER displays .....	50
11. Passive recovery .....	20	25. Description of the TECHNICAL MENU displays.....	51
12. Component management.....	20	25.1. USER displays .....	51
12.1. Compressors.....	20	25.2. MANUFACTURER displays .....	58
12.2. Four-way valve.....	21	25.3. MAINTENANCE displays .....	77
12.3. Outdoor circuit fans.....	21	26. Description of ALARM displays .....	93
12.4. Outdoor circuit 3-way valve.....	22	27. List of factory-set parameters .....	108
12.5. Indoor circuit supply fans .....	22	27.1. Parameters of the MAIN MENU .....	108
12.6. Indoor circuit return fans (optional) .....	24	27.2. Parameters of the TECHNICAL MENU .....	110
12.7. Electrical heater (optional) .....	24	28. Technical and electrical characteristics .....	129
12.8. Auxiliary coil (optional) .....	25	28.1. Ambient probe.....	132
12.9. Gas burner (optional).....	25	28.2. Air quality probe 4.. 20 mA.....	134
		29. Troubleshooting .....	135

## 1. GENERAL DESCRIPTION

The **CIATrtrc** control is an electronic module designed for the control and supervision of air-air and water-air units (especially rooftop models) by microprocessors.

This control is basically comprised of a  $\mu$ PC MEDIUM control board, a pGD1 graphic terminal, a TCO user terminal (optional) and sensors.

It has a field-bus RS485 that allows the management of components such as: pCOe expansion modules, plug-fans, probes of temperature or relative humidity of the ambient air, leak detectors, energy meters, variable frequency drives, etc.

The **CIATrtrc** control allows the connection to a centralised technical management system by using a specific BMS card (optional) for the following communication protocols: Carel, Modbus, LonWorks®, BACnet™ MSTP, Konnex, Modbus TCP/IP, BACnet™ Ethernet, TCP/IP, SNMP V1-2-3, FTP and HTTP.

It also manages a local connection between units through a pLAN network ( $\mu$ PC MEDIUM Local Area Network), thus allowing communication of data and information for a maximum of 15 units. This enables the reduction of the number of pGD1 terminals, since a single shared terminal can monitor all  $\mu$ PC MEDIUM boards.

### Main functions:

- Selection of the operating mode: HEATING, COOLING, AUTOMATIC or VENTILATION.
- Selection of the setpoint.
- Permanent control of the operating parameters.
- View of the values measured by the probes.
- Timing of the compressors
- Defrosting management (in air-air heat pump units).
- Refrigerant anti-freeze safety (in water-air heat pump units).
- Operation of all the seasons via the condensation and evaporation pressure control.
- Control of the outlet temperature.
- Compensation of the setpoint based on the outdoor temperature.
- Time (possibility of 3 setpoints) and weekly schedule.
- Anti-fire safety device.
- Failure diagnosis and main alarm.

### Optional functions:

This control allows controlling optional elements such as:

- Electronic outdoor fans.
- Cooling recovery circuit for renewing the air.
- Rotary recovery with on/off control or with variable speed.
- Outdoor air damper for renewing air, depending on the temperature of the mixing air or depending on the air quality probe.
- Mixing box for thermal, enthalpic or thermoenthalpic free-cooling.
- Control of the overpressure.
- Supply and return plug-fans.
- Supply and return centrifugal fan with variable frequency drive (VFD).
- Auxiliary electrical heaters: one or two stages with on/off control or a stage with proportional control.
- Hot water coil with 3-way valve, with proportional or on/off control.
- Gas burner with one or two stages of proportional control.
- Humidifier with proportional or on/off control.
- Air flow controller.
- Clogged filter detector.
- Smoke detection station.
- Refrigerant leak detector.
- Ambient temperature or humidity probe.
- Air quality probe for measuring CO<sub>2</sub> and/or volatile compounds.
- Energy meter and calculation of the cooling and heating capacities.

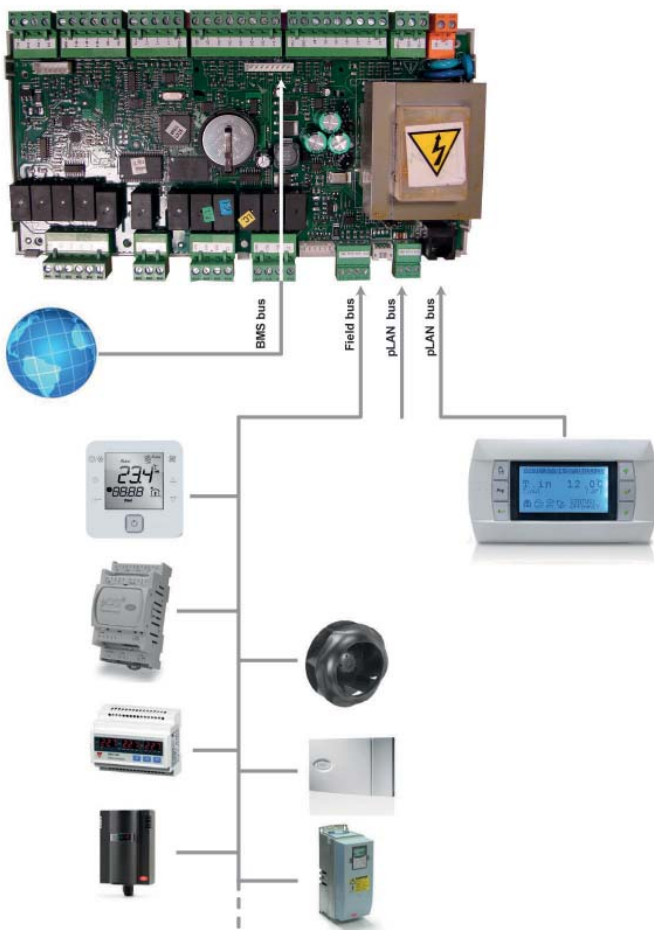

## 1.1. Communications

This control allows the connection to a centralised technical management system by using a specific BMS card (optional) for the following communication protocols:

### Carel and Modbus

One RS485 serial card is connected for the supervisory network with both Carel and Modbus protocol.

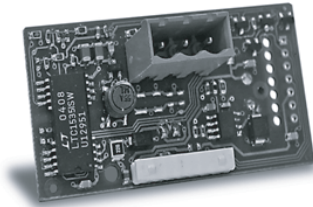

### LonWorks®

To establish communication with a network with the LonWorks® protocol, is needed a FTT RS485 serial card.

The supervisory program is stored in flash memory and can be programmed directly from the LonWorks® network by using tools such as LonMaker®.

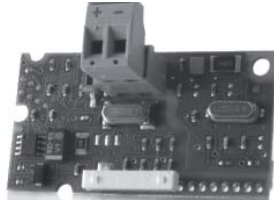

### BACnet™

To establish communication with a network with the BACnet™ MSTP protocol is needed a BACnet™ RS485 serial card.

This open standard, developed by ASHRAE, enables air conditioning and heating systems for homes and buildings to be connected for the sole purpose of performing intelligent energy management.

*Configuration by the integrator.*



### Konnex (KNX)

A network with the Konnex protocol needs a Konnex serial card.

This open standard enables the connection and integration of devices in building automation applications both at the commercial and at the residential level.

*Configuration by the integrator.*

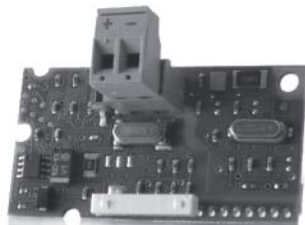

### Ethernet pCO Web

The Ethernet pCO Web card allows the network communication with the protocols Modbus TCP/IP, BACnet™ Ethernet, TCP/IP, SNMP V1-2-3, FTP and HTTP.

BACnet™ Ethernet: *Configuration by the integrator.*



## 1.2. Supervision solutions

### pCO Web

It is the solution for the management and supervision of a single unit if it incorporates the Ethernet pCO Web card.

### PlantWatchPRO3

It is a solution designed for the monitoring of installations of medium - small dimensions, with ability to manage up to 30 units. Suitable for technical environments, it has no parts in movement. It's available in two versions: panel and wall.

Includes: 7 " touch display, buzzer for notifications, 1 USB port and 1 SD card slot for downloading reports, charge devices models and applying service packs. In this case, each unit needs one RS485 Carel / Modbus card.

### PlantVisorPRO2

This is the solution for the management and supervision of air-conditioning installations with up to 300 units. It performs advanced monitoring and maintenance functions and enables creating areas and groups which simplify the management of the installation.

PlantVisorPRO2 is available in two versions:

- **Box:** comprised of the CPU unit and, optionally, by monitor and keyboard.
- **Touch:** this includes the CPU and the touchscreen in the one device.

In this case, each unit needs one RS485 Carel / Modbus card.

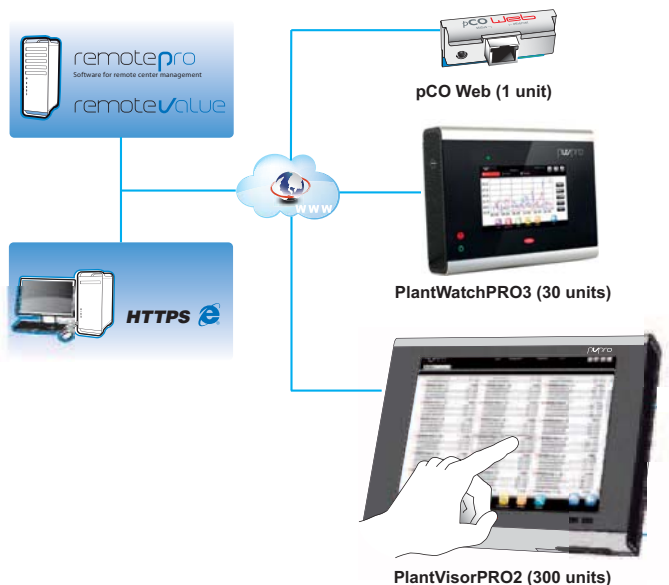

These systems allow the installation in remote management. Through a single connection to the Internet is accessed the information system. The Web interface, which is available for the local user, allows the monitoring and the complete configuration of the installation: from the office or any other user's current location.

For remote control of multiple sites, there are dedicated tools for centralized management as RemotePRO and RemoteValue.

## 2. SET-UP

The **CIATrtrc** control is basically comprised of:

- A  $\mu$ PC MEDIUM control board.
- A pGD1 graphic terminal connected on the pLAN bus.
- Sensors.

The system can be completed with:

- Additional sensors.
- A TCO user terminal connected on the field-bus RS485.
- Elements connected on the field-bus RS485, as the pCOe expansion cards, plug-fans, probes of temperature or relative humidity of the ambient air, leak detectors, energy meters, variable frequency drives, etc.
- A BMS card that allows the connection of the  $\mu$ PC MEDIUM board to a centralised technical management system.

### 2.1. $\mu$ PC MEDIUM control board

Main CPU board installed in the unit's electric panel, which allows data to be input, treated by the microcontroller and the operation of the unit to be managed completely.

The program and the parameters are stored in non-volatile memory, there by ensuring their storage even in the case of a power failure (without needing an auxiliary coil). The program can be loaded through the PC or from a program key.

This board has the following main characteristics:

- Removable connectors.
- Built-in clock.
- Power supply voltage 230 Vac.
- Connection to a TCO user terminal.
- Connection to a pGD1 maintenance terminal.
- RS485 serial supervisory through an optional card.
- Plastic base for installation on a DIN rack.

### 2.2. pGD1 graphic terminal



The pGD1 terminal for the regulation and control of the unit enables:

- The initial programming of the unit.
- The modification of operating parameters.
- The selection of the operating mode.
- Setting the setpoints.

- The display of controlled variables and sensor values.
- On-screen display of alarms.

### 2.3. Sensors

The standard sensors included in the control are:

- Temperature of the return air and temperature of the outlet air.
- Pressure or temperature in the outdoor coils (air-air units) or refrigerant anti-freeze safety (water-air units).
- Outdoor air temperature.
- Mixing air temperature.
- NTC ambient air temperature.

Note: If the unit is integrated in a pLAN network it can read the probes value of the master unit for: ambient temperature and outdoor temperature.

#### Optional probes connected on the $\mu$ PC MEDIUM board:

- Relative humidity of the return air: this probe is used with the optionals of enthalpic or thermoenthalpic free-cooling or humidifier.
- Relative humidity of the outdoor air: this probe is used instead of the one for the outdoor temperature and is used with the optional of enthalpic or thermoenthalpic free-cooling.

If the unit needs this humidity probe, the NTC ambient temperature probe can't be installed on the board. In this case it is necessary to use a RS485 ambient temperature probe connected on the Field-bus.

- Air quality probe: for the free-cooling option, the control can add a probe for measuring the CO<sub>2</sub> and/or volatile compounds. This probe is connected on the board instead of the return air humidity probe, also optional.

Note: If the unit is integrated in a pLAN network it can read the probes value of the master unit for: outdoor humidity, indoor humidity and air quality.

#### Optional probes connected in series on the Field-bus:

- RS485 ambient air temperature probe. If the unit needs the outdoor humidity probe (with enthalpic or thermoenthalpic free-cooling), the NTC ambient temperature probe can't be installed on the board. In this case it is necessary to use a RS485 ambient temperature probe connected on the Field-bus.

Note: An ambient probe with RS485 communication is required for installation to more than 30 metres.

- RS485 ambient air T + RH probe (with enthalpic or thermoenthalpic free-cooling). In this case also added the outdoor air humidity probe.
- Two, three or four RS485 ambient air T or T + RH probes.

Up to four ambient probes can be connected on the Field-bus of the  $\mu$ PC MEDIUM board using RS485 serial cards, configured with different addresses.

- RS485 mixing and outlet enthalpic probes for calculation of the cooling and heating capacities.

## 2.4. TCO user terminal (optional)

The TCO user terminal allows:

- Unit ON / OFF.
- Setting the setpoints.
- Selection of the operating mode: HEATING, COOLING, AUTOMATIC or VENTILATION.
- The display of ambient (or return) temperature, ambient humidity, outdoor temperature, outlet air temperature, CO<sub>2</sub> probe and opening of the outdoor damper.
- On-screen display of alarms codes.



## 2.5. pCOe expansion cards (optional)

### pCOe card No.1 (units with 4 circuits)

The µPC MEDIUM board needs to increase the number of I/Os for the control of units with 4 compressors and 4 circuits. This is resolved by adding a pCOe expansion card connected on the field-bus of the µPC MEDIUM board. This card is also necessary with the optionals: proportional humidifier or overpressure control with extraction damper.

### pCOe card No.2 (condensation control of indoor unit & GREAT COLD)

The µPC MEDIUM board needs to increase the number of I/Os for the control of the condensation and evaporation pressures of the indoor unit. This is resolved by adding a pCOe expansion card connected on the field-bus of the µPC MEDIUM board. This card is also necessary with the optionals: GREAT COLD and mechanical disconnection of stages.

### pCOe card No.3 (zoning into 2 areas with dampers and/or rotary recovery with variable speed)

The µPC MEDIUM board needs to increase the number of I/Os for the control of the zoning into 2 areas with dampers. This is resolved by adding a pCOe expansion card connected on the field-bus of the µPC MEDIUM board.

Note: please, refer to chapter 5 to see the wiring of the cards.

## 2.6. BMS communication card (optional)

The BMS card allows connecting the µPC MEDIUM board to a centralised technical management system.

For the Carel or Modbus communication protocol an RS485 serial card must be installed in each of the units.

For a more detailed description on the available supervision systems please consult the control Communications Brochure.

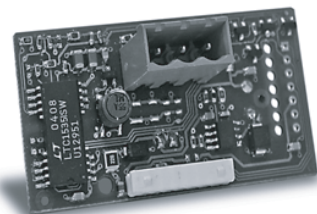

## 3. USER TERMINALS

### 3.1. pGD1 terminal (standard)

#### Keys and combinations (quick guide)

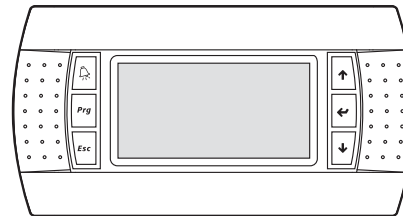

**Important:** All displays available for the pGD1 terminal are described in chapters 22 to 26 of this brochure.

Key	Function
	<b>Alarm</b> There is/are active alarm(s) if the key is illuminated red. By pressing the key once, the description of the first alarm will be shown. By using the up/down keys, the other alarms stored in the memory can be consulted. By pressing this key for a second time, the alarm(s) will be reset. If no alarm is active, the message "No alarm active" appears.
	<b>Prg</b> This allows the MAIN MENU display to be accessed to select the operating mode, setpoints, off/on, inputs/outputs and schedule programming (no password required). The key will light up in orange.
	<b>Esc</b> To exit any display, pressing this key returns the user to the start display of the previous menu. From the main display, if keeping this key pressed for a few seconds, access is given to a group of help displays with information on the key or key combination that enable performing the most important control functions.
	<b>Esc + Down</b> By pressing both keys simultaneously for a few seconds, it's possible to change of unit in the pLAN network.
	<b>Up / Down</b> These keys enable consulting the information displayed on-display by going forward or back. They can also modify values. By pressing both keys at the same time, direct access is gained to the group of input/output displays (belonging to the MAIN MENU).
	<b>Enter</b> This enables confirming the modified values. By pressing the key once, the cursor is placed on the first display parameter. Pressing the key again confirms the adjusted parameter value and it then proceeds to the next parameter.
	<b>Prg + Esc</b> By pressing both keys simultaneously for a few seconds on the main display of the MAIN MENU, access is given to the TECHNICAL MENU for the parametrisation and maintenance displays of the unit, to which only the fitter and/or engineer should have access (password required).
	<b>Prg + Enter</b> The unit is switched off/on by pressing both these keys at the same time for a few seconds. This action is equivalent to off/on from the main menu display.
	<b>Prg + Up</b> HEATING mode (winter) is selected by pressing both these keys at the same time for a few seconds.
	<b>Prg + Down</b> COOLING mode (summer) is selected by pressing both these keys at the same time for a few seconds
	<b>Alarm + Prg</b> The display contrast (LCD with a resolution of 133 x 64 pixels) can be set by pressing these keys at the same time + up or down.
	<b>Alarm + Down</b> The language of the displays is selected by pressing both these keys at the same time for a few seconds
	<b>Alarm + Enter</b> By pressing both keys simultaneously it is possible to access to information about the firmware and software of the board.

### 3.2. TCO user terminal (optional)

#### Features

- LCD display, backlit in blue.
- Ambient temperature probe by standard.
- Clock and daily programming.

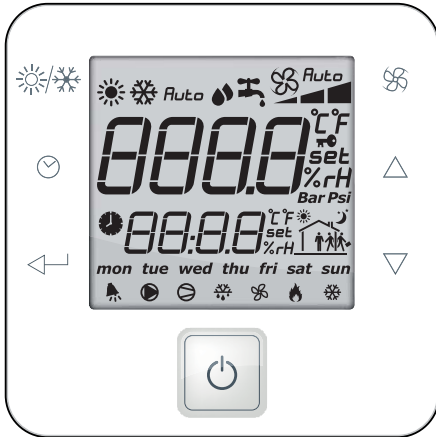

Dimensions:  
 Length: 86 mm  
 Width: 86 mm  
 Depth: 51 mm

#### Display

The TCO terminal has an LCD display to show the information of the unit and to interact with the user.

Symbol	Meaning
	Selection of HEATING mode (winter)
	Selection of COOLING mode (summer)
<i>Auto</i>	Selection of AUTOMATIC mode
	Indoor fan in operation (3 possible speeds in plug-fan)
	Main indicator of: - Temperature (°C or °F) - Activated block key (key) - Setpoint (set) - Relative humidity (%RH)
	Secondary indicator of: - Temperature (°C or °F) - Setpoint (set) - Hour and minute - Relative humidity (%RH)
	Alarm indicator
	Pump of the hot water coil in operation
	Compressor in operation
	Defrosting indicator
	Outdoor fan in operation
	Active support in HEATING mode
	Operation in cooling mode (in AUTO mode it makes known whether the unit is operating in COOLING or HEATING)
	Selection of the type of scheduled programming: 6 possible phases.
	Activation indicator of the timer programming
<i>mon tue wed thu fri sat sun</i>	Indicators of the days of the week (Monday to Sunday)

#### Keys and combinations (quick guide)

Key	Function
	<b>Mode of operation</b> Allows the operating mode to be selected: HEATING, COOLING, (only if selection by panel is activated on the display CU12a)
	<b>Fan</b> Allows to select 3 different flows in plug-fans (display CU12b) V1: minimum flow V2: nominal flow V3: maximum flow
	<b>Programme schedule</b> Short press: allows to activate the programme schedule stored in the TCO terminal Long press (3 secs): allows the time and the programme schedule to be modified.
	<b>Up / down</b> These keys allow the user to go forward and backward to consult the information found on the display. They can also modify values
	<b>Enter</b> This enables confirming the modified values. It also allows the set of values to be seen on the display (temperature, temperature setpoint, humidity, humidity setpoint, outdoor temperature, discharge T, alarm code, CO <sub>2</sub> mesure, outdoor damper opening)
	<b>Off / on</b> Allows the unit to be turned OFF/ON
	<b>Fan + Off / on</b> Long press (3 seconds), to access the internal parameters display

#### View in succession of the values measured

In addition to view in the ambient (or return) air temperature on the main display, it is possible to view other values through the set that is activated by pressing the key.

The following values will be shown with each press:

1) <b>Ambient or return T</b>	2) <b>Setpoint temp.</b>	3) <b>Ambient RH (opt)</b>
4) <b>Setpoint RH (opt)</b>	5) <b>Outdoor temperature</b>	6) <b>Outlet temperature</b>
7) <b>Active alarms</b>	8) <b>CO<sub>2</sub> measure (opt.)</b>	9) <b>Outd. damper (opt)</b>

## 4. INPUT / OUTPUT OF THE MAIN CONTROL BOARD

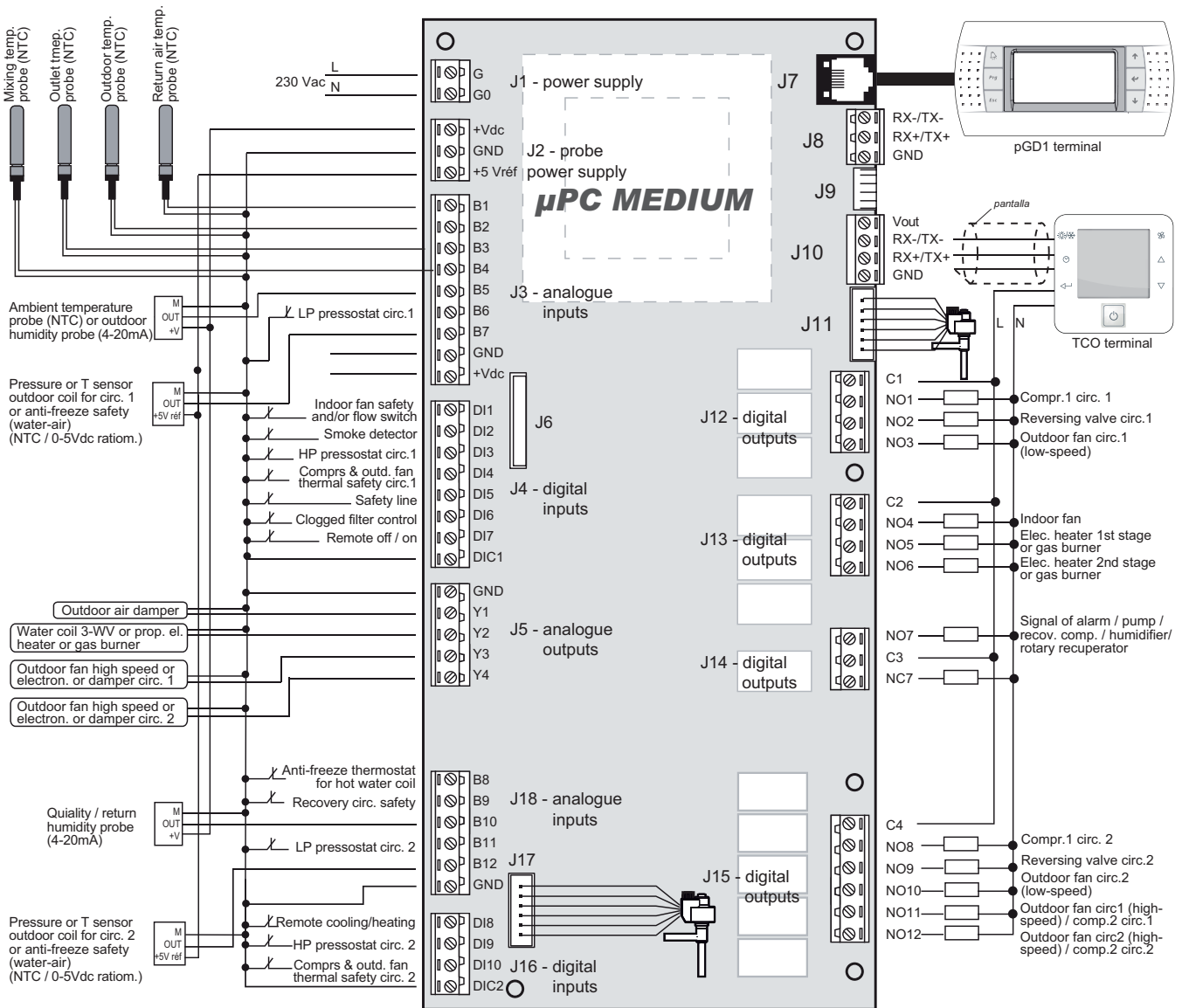

### Air-air unit: description of inputs and outputs

#### Analogue outputs

Proportional control of optional elements:

- Y1: control of the opening of the outdoor air damper.
- Y2: control of the three-way valve on the auxiliary coil for hot water or on the proportional electrical heater or on the gas burner
- Y3: electronic outdoor fan circuit 1 (units with 1 or 2 circuits) / electronic outdoor fans circuits 1 and 2 (units with 4 circuits)  
High-speed outdoor fan circuit 1 (units with 1 or 2 circuits with 2-speed fan) (units with 4 compressors and 2 circuits with 2-speed fan)  
damper for condensation pressure control on centrifugal outdoor fan circuit 1
- Y4: electronic outdoor fan circuit 2 (units with 2 circuits) / electronic outdoor fans circuits 3 and 4 (units with 4 circuits)  
High-speed outdoor fan circuit 2 (units with 2 circuits with 2-speed fan) (units with 4 compressors and 2 circuits with 2-speed fan)  
damper for condensation pressure control on centrifugal outdoor fan circuit 2

### Water-air unit: description of inputs and outputs

#### Analogue outputs

Proportional control of optional elements:

- Y1: control of the opening of the outdoor air damper.
- Y2: control of the three-way valve on the auxiliary coil for hot water or on the proportional electrical heater or on the gas burner
- Y3: control of plates exchanger 3-way valve of circuit 1 (units with 1 or 2 circuits) / plates exchangers 3-way valve of circuits 1 and 2 (units with 4 circuits)
- Y4: control of plates exchanger 3-way valve of circuit 2 (units with 2 circuits) / plates exchangers 3-way valve of circuits 3 and 4 (units with 4 circuits)





## Air-air unit: description of inputs and outputs

### Analogue inputs

Temperature, pressure and humidity reading sensors:

- B1: return air temperature probe
- B2: outdoor air temperature probe
- B3: outlet air temperature probe
- B4: mixing air temperature probe
- B5: NTC ambient air temperature probe (by default) or outdoor air relative humidity probe (optional)
- B7: pressure / temperature sensor for the outdoor coil 1
- B10: air quality probe or return air relative humidity probe (optionals)
- B12: pressure / temperature sensor for the outdoor coil 2

### Digital inputs

Safety devices and failure indication using traditional electromechanical components:

- B6: low pressure pressostat circuit 1
- B8: anti-freeze safety for the hot water coil
- B9: recovery circuit safety device (optional)
- B11: low pressure pressostat circuit 2
- DI1: indoor fan protection and air flow control (optional)
- DI2: smoke detector (optional)
- DI3: high pressure pressostat circuit 1
- DI4: compressor and outdoor fan protection device circuit 1
- DI5: safety thermistor for the electrical heater or gas burner alarm signal (optionals)
- DI6: clogged filter control (optional)
- DI7: remote off / on
- DI8: remote cooling / heating
- DI9: high pressure pressostat circuit 2
- DI10: compressor and outdoor fan protection device circuit 2

### Digital outputs

On/off control of the unit components and optional elements:

- NO1: compressor 1 of circuit 1
- NO2: cycle reversing valve circuit 1
- NO3: outdoor fan circuit 1 (units with 1 or 2 circuits)
  - low-speed outdoor fan circuit 1 (units 1 or 2 circuits with 2-speed fan)
  - outdoor fans circuits 1 and 2 (units with 4 circuits)
  - low-speed outdoor fans circuits 1 & 2 (units 4 circuits with 2-speed fan)
- NO4: indoor fan
- NO5: 1st electrical heater stage or gas burner (optionals)
- NO6: 2nd electrical heater stage or gas burner (optionals)
- NO7: alarm signal or pump in the water auxiliary circuit or compressor in the recovery circuit or on-off humidifier or rotary recovery (optionals)
- NO8: compressor 1 of circuit 2 (units with 2 circuits) or compressor 3 (units with 4 circuits)
- NO9: cycle reversing valve circuit 2
- NO10: outdoor fan circuit 2 (units with 2 circuits)
  - low-speed outdoor fan circuit 2 (units with 2 circuits with 2-speed fan)
  - high-speed outdoor fans circuits 1 & 2 (units 4 circ. with 2-speed fan)
- NO11: compressor 2 of circuit 1 (units with 2 circuits) or compressor 2 (units with 4 circuits) or high-speed outdoor fan circuit 1 (units with 1 circuit or 2 compressors and 2 circuits, with 2-speed fan) (units with 4 compressors and 2 circuits with 2-speed fan)
- NO12: compressor 2 of circuit 2 (units with 2 circuits) or compressor 4 (units with 4 circuits) or high-speed outdoor fan circuit 2 (units with 2 compressors and 2 circuits, with 2-speed fan) (units with 4 compressors and 2 circuits with 2-speed fan)

## Water-air unit: description of inputs and outputs

### Analogue inputs

Temperature, pressure and humidity reading sensors:

- B1: return air temperature probe
- B2: outdoor air temperature probe
- B3: outlet air temperature probe
- B4: mixing air temperature probe
- B5: NTC ambient air temperature probe (by default) or outdoor air relative humidity probe (optional)
- B7: refrigerant anti-freeze safety circuit 1
- B10: air quality probe or return air relative humidity probe (optionals)
- B12: refrigerant anti-freeze safety circuit 2

### Digital inputs

Safety devices and failure indication using traditional electromechanical components:

- B6: low pressure pressostat circuit 1
- B8: anti-freeze safety for the hot water coil
- B9: recovery circuit safety device (optional)
- B11: low pressure pressostat circuit 2
- DI1: indoor fan protection and air flow control (optional)
- DI2: smoke detector (optional)
- DI3: high pressure pressostat circuit 1
- DI4: compressor and outdoor fan protection device circuit 1
- DI5: water flow switch
- DI6: clogged filter control (optional)
- DI7: remote off / on
- DI8: remote cooling / heating
- DI9: high pressure pressostat circuit 2
- DI10: compressor and outdoor fan protection device circuit 2

### Digital outputs

On/off control of the unit components and optional elements:

- NO1: compressor 1 of circuit 1
- NO2: cycle reversing valve circuit 1
- NO3: on-off signal (not used)
- NO4: indoor fan
- NO5: 1st electrical heater stage or gas burner (optionals)
- NO6: 2nd electrical heater stage or gas burner (optionals)
- NO7: alarm signal or pump in the water auxiliary circuit or compressor in the recovery circuit or on-off humidifier or rotary recovery (optionals)
- NO8: compressor 1 of circuit 2 (units with 2 circuits) or compressor 3 (units with 4 circuits)
- NO9: cycle reversing valve circuit 2
- NO10: on-off signal (not used)
- NO11: compressor 2 of circuit 1 (units with 2 circuits) or compressor 2 (units with 4 circuits)
- NO12: compressor 2 of circuit 2 (units with 2 circuits) or compressor 4 (units with 4 circuits)

## 4.1. Location of the sensors on the machine

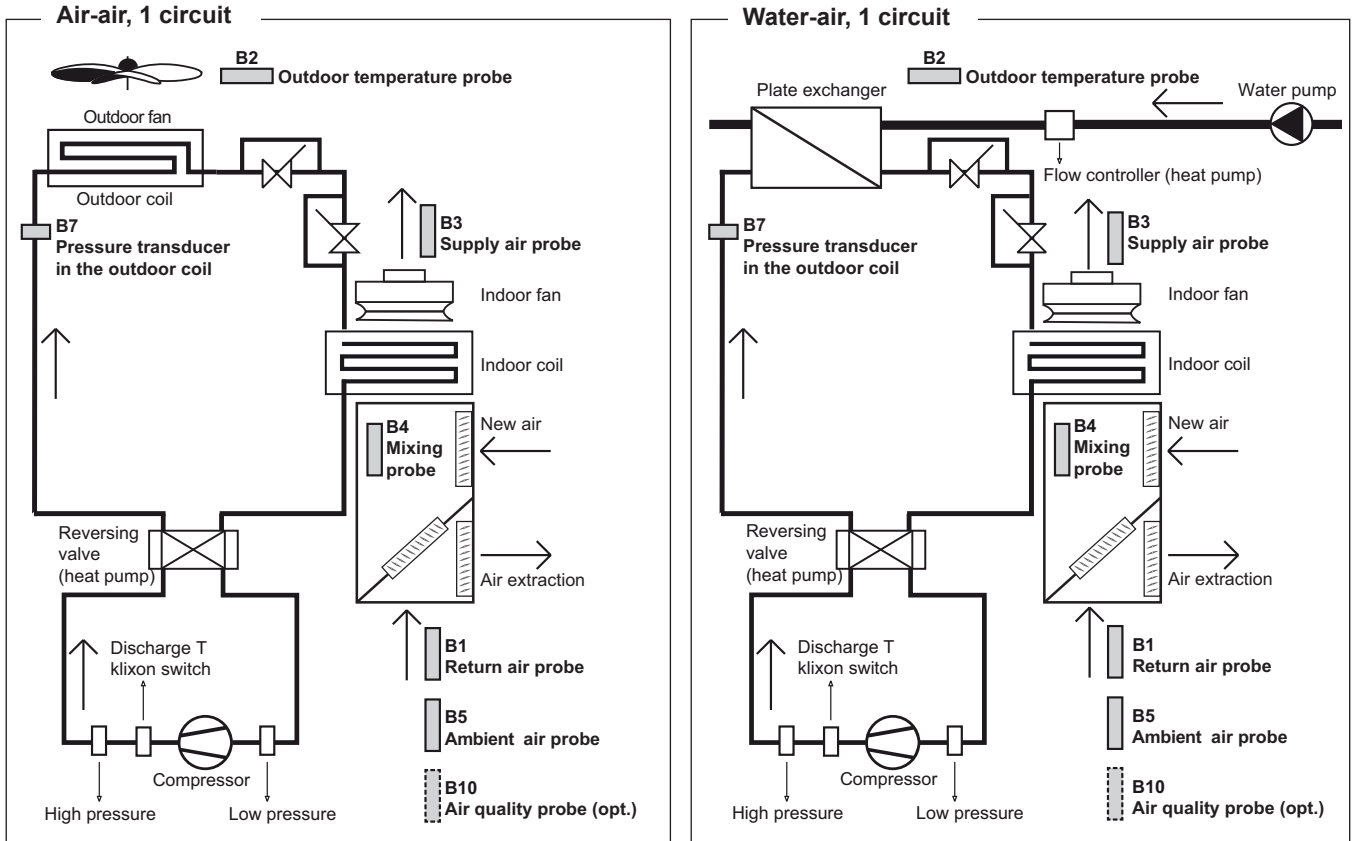

## 4.2. Serial connection of RS485 probes to the control board

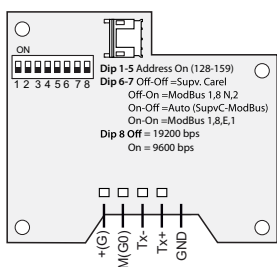
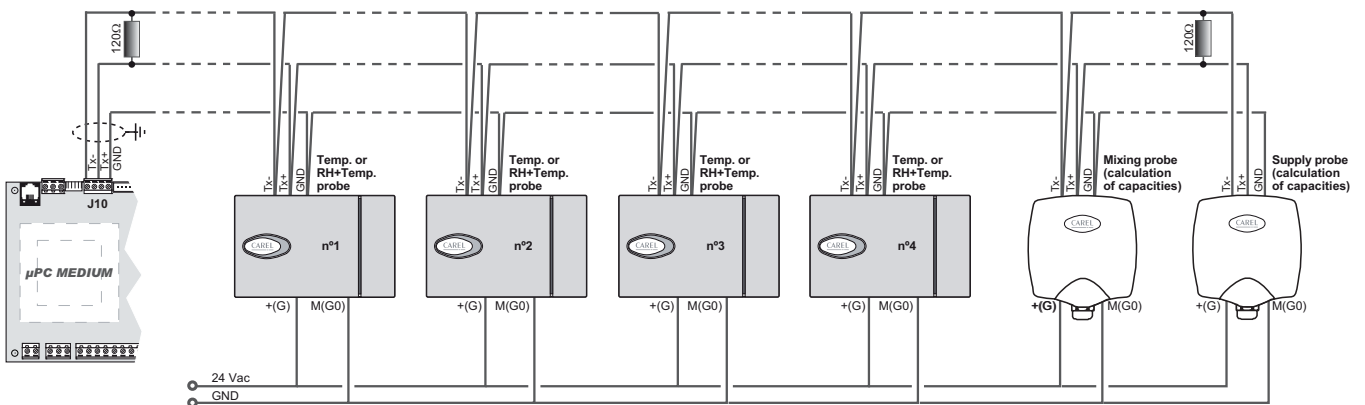

### RS485 probes configuration:

**Ambient probe No.1:**  
Address: 128  
Modbus 1, 8, N, 2  
9600 bps



**Ambient probe No.2:**  
Address: 129  
Modbus 1, 8, N, 2  
9600 bps



**Ambient probe No.3:**  
Address: 130  
Modbus 1, 8, N, 2  
9600 bps



**Ambient probe No.4:**  
Address: 131  
Modbus 1, 8, N, 2  
9600 bps



**Mixing enthalpic probe:**  
Address: 132  
Modbus 1, 8, N, 2  
9600 bps



**Supply enthalpic probe:**  
Address: 133  
Modbus 1, 8, N, 2  
9600 bps



Important: It is recommended to insert an electrical resistance of 120Ω, between connectors TX+ and TX- of the μPC MEDIUM output (connector J10) and on the final component of the RS485 network, to avoid potential problems of communication.

### 4.3. Connection of terminals to the control board

#### Connection of pGD1 terminal (standard)

The terminal can be installed at a maximum distance of 500 metres from the microPC control board.

- Up to 50 metres, it can be connected directly with telephone wire.
- From 50 to 200 metres, it is necessary to use the TCONN bypass cards and AWG 20/22 shielded cable with 2 twisted pairs.

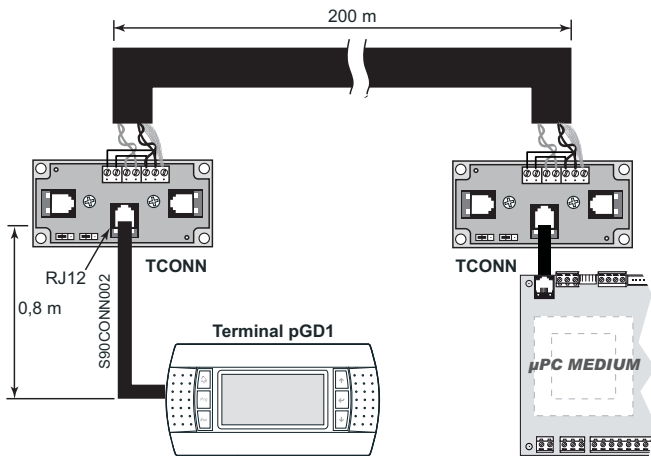

- From 200 to 500 metres, it is necessary to use the TCONN bypass cards, AWG 20/22 shielded cable with 1 twisted pair and external 20...30Vdc (150 mA) power supply.

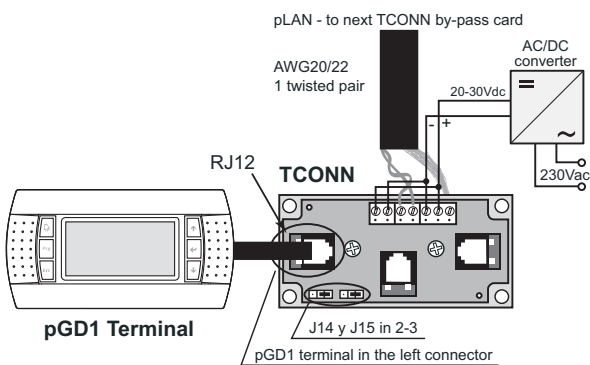

#### Configuration

To ensure communication between the pGD1 terminal and the µPC MEDIUM board, the terminal must be configured with address 16. In the event of a terminal supplied separately, this is not sent addressed and the following procedure must be carried out:

- 1) Simultaneously press the + + keys.
- 2) On the display accessed, set address 16 in "Display address setting".

Note: If the terminal is going to be integrated into the pLAN, refer to the communications brochure of the CIATrtc control, which explains the configuration of the terminals in the network.

#### Connection of TCO terminal (optional)

The terminal can be installed at a maximum distance of 100 metres from the microPC control board. The connection requires the following:

- Power supply (the same as the control board) at 230Vac 50/60Hz (L&N): 2 wires (section 0.5 at 1.5 mm<sup>2</sup>).
- Communication with the board (RX+/TX+ & RX-/TX-): shielded cable type AWG20 or AWG22 with 1 braided pair + drainwire + shielding (e.g., model BELDEN 7703NH).

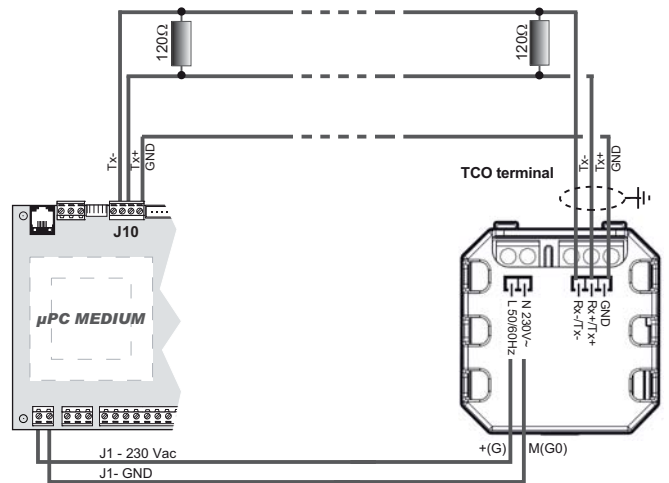
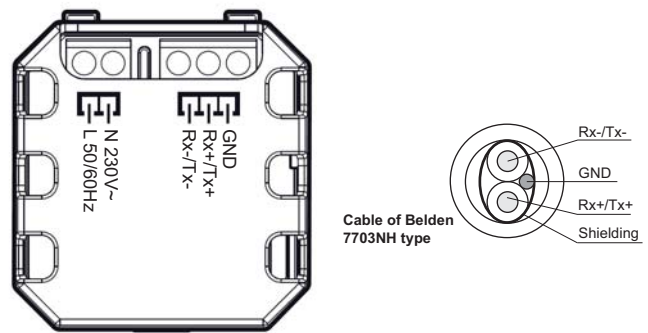

**Important:** It is recommended to insert an electrical resistance of 120Ω, between connectors TX+ and TX- of the µPC MEDIUM output (connector J10) and on the final component of the RS485 network, to avoid potential problems of communication.

#### Configuration:

To ensure communication between the TCO terminal and the µPC MEDIUM board, the terminal must be configured with address 10 and speed 9600 bps.

The terminal is sent addressed, and on the power up, the screen should display the firmware version "1.1" on the power up and, then, the "init." symbol. The terminal will be fully operational after a few seconds.

In the unlikely event of a communications failure the screen will display "Cn". Please make sure to check connections and the firmware version.

## 5. EXPANSION CARDS

### 5.1. pCOe expansion card No.1 (unit 4 circuits)

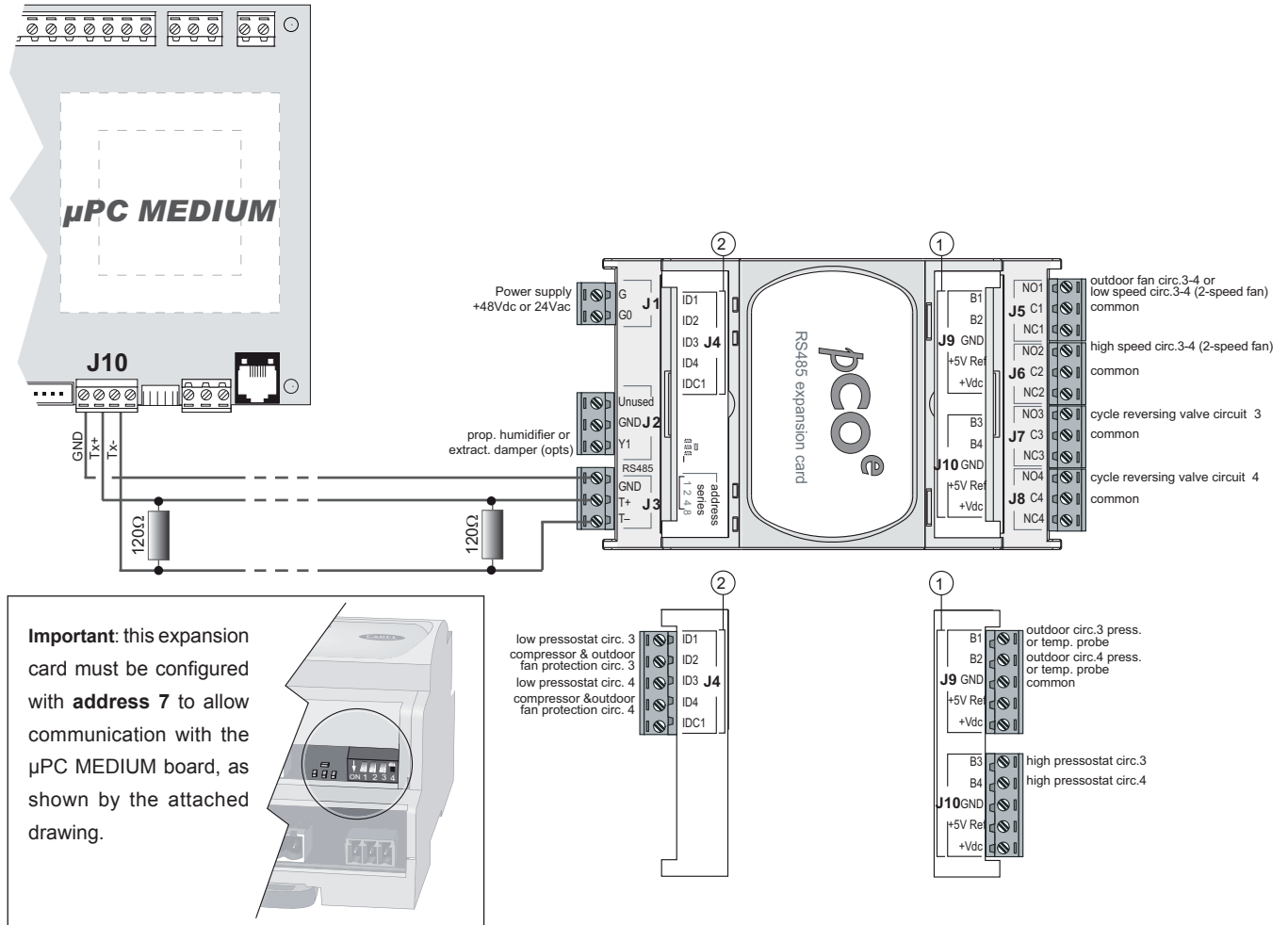

#### Air-air units

##### Analogue inputs

- B1: pressure / temperature sensor for the outdoor coil 3
- B2: pressure / temperature sensor for the outdoor coil 4
- B3: high pressure pressostat circuit 3
- B4: high pressure pressostat circuit 4

##### Digital inputs

- ID1: low pressure pressostat circuit 3
- ID2: compressor and outdoor fan protection device circuit 3
- ID3: low pressure pressostat circuit 4
- ID4: compressor and outdoor fan protection device circuit 4

##### Digital outputs

- NO1: outdoor fans circuits 3 and 4  
low-speed outdoor fans circuits 3 and 4 (units with 2-speed fan)
- NO2: high-speed outdoor fans circuits 3 and 4 (units with 2-speed fan)
- NO3: cycle reversing valve circuit 3
- NO4: cycle reversing valve circuit 4

##### Analogue output

- Y1: proportional humidifier or extraction damper (optionals)

#### Water-air units

##### Analogue inputs

- B1: refrigerant anti-freeze safety circuit 3
- B2: refrigerant anti-freeze safety circuit 4
- B3: high pressure pressostat circuit 3
- B4: high pressure pressostat circuit 4

##### Digital inputs

- ID1: low pressure pressostat circuit 3
- ID2: compressor protection device circuit 3
- ID3: low pressure pressostat circuit 4
- ID4: compressor protection device circuit 4

##### Digital outputs

- NO1: on-off signal (not used)
- NO2: on-off signal (not used)
- NO3: cycle reversing valve circuit 3
- NO4: cycle reversing valve circuit 4

##### Analogue output

- Y1: proportional humidifier or extraction damper (optionals)

## 5.2. pCOe expansion card No.2 (condensation control of the indoor unit & GREAT COLD)

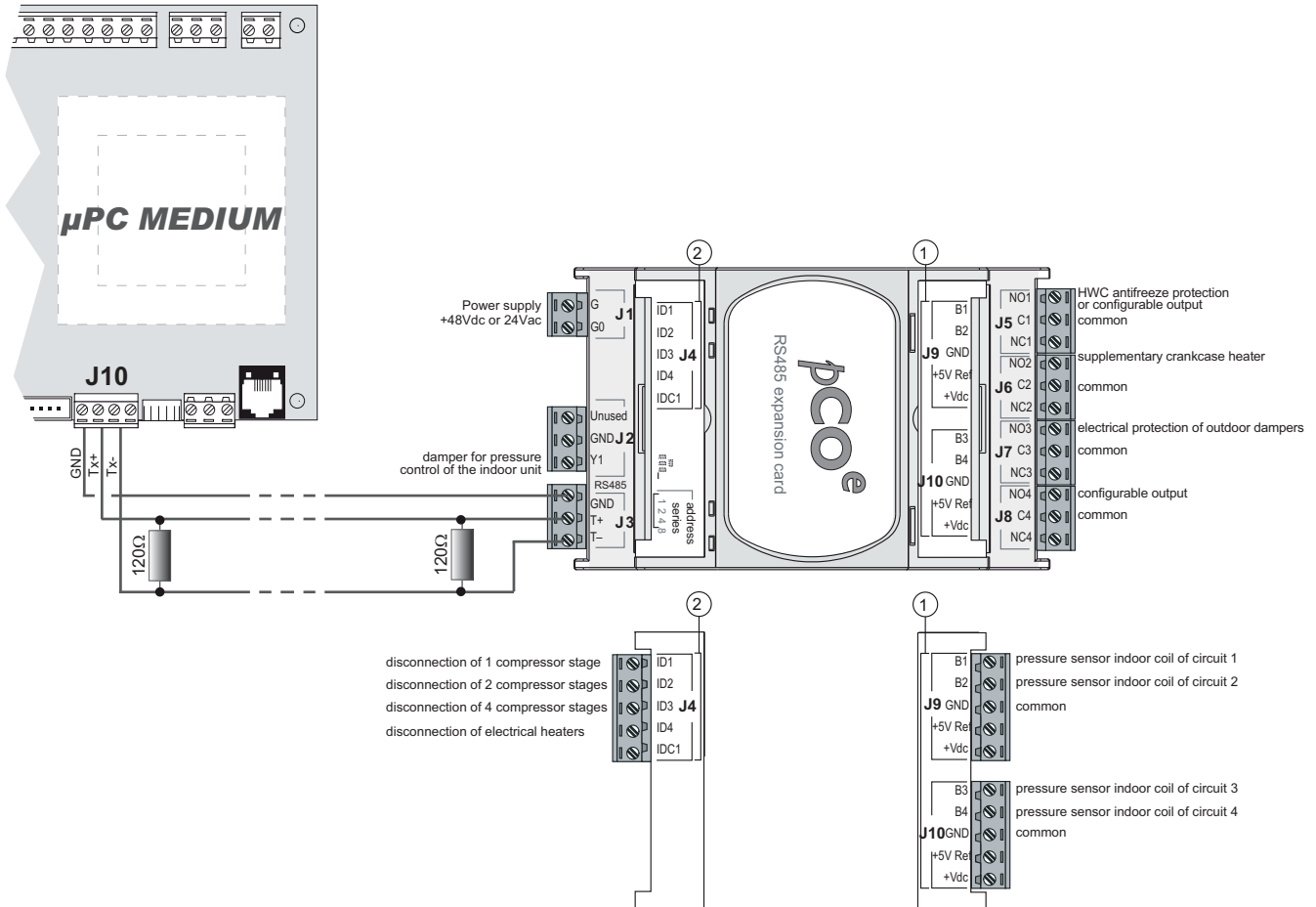

### Air-air and water-air units

#### Analogue inputs

- B1: pressure sensor for the indoor coil of circuit 1
- B2: pressure sensor for the indoor coil of circuit 2
- B3: pressure sensor for the indoor coil of circuit 3 or temperature probe for the inlet of the hot water coil with GREAT COLD option
- B4: pressure sensor for the indoor coil of circuit 4 or temperature probe for the outlet of the hot water coil with GREAT COLD option

#### Digital inputs

- ID1: disconnection of 1 compressor stage
- ID2: disconnection of 2 compressor stages
- ID3: disconnection of 4 compressor stages
- ID4: disconnection of electrical heaters

#### Digital outputs

- NO1: circuit of the hot water coil with antifreeze protection or configurable output (humidificator, HWC pump, general alarm,...)
- NO2: compressor with supplementary crankcase heater
- NO3: electrical heater for protection of outdoor dampers
- NO4: configurable output (humidificator, HWC pump, general alarm,...)

#### Analogue output

- Y1: damper for pressure control of the the indoor unit

**Important:** this expansion card must be configured with **address 8** to allow communication with the μPC MEDIUM board, as shown by the attached drawing.

### 5.3. pCOe expansion card No.3 (zoning into 2 areas and/or variable rotary recovery)

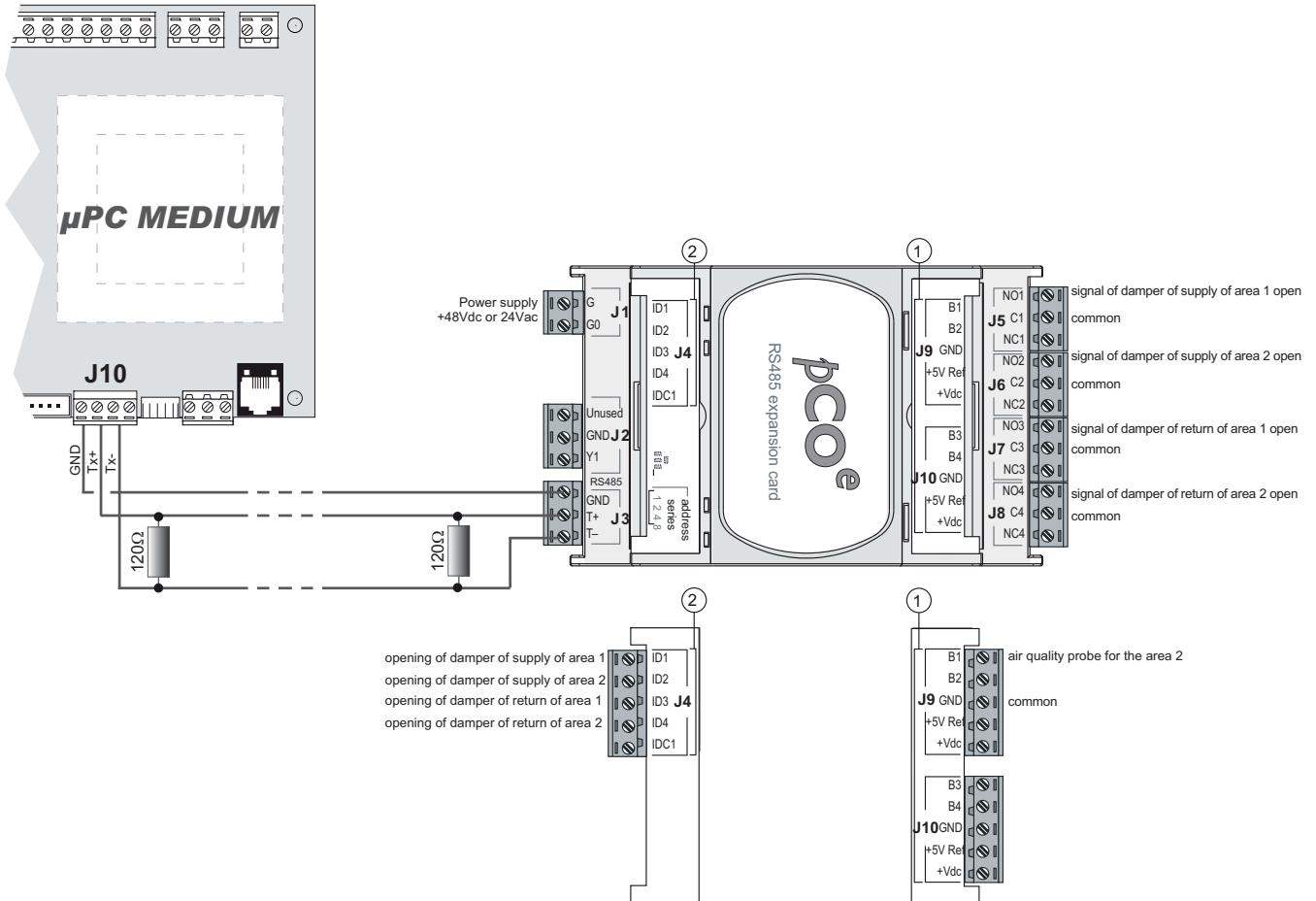

#### Air-air and water-air units

##### Analogue inputs

- B1: 4-20mA air quality probe for the area 2
- B2: unused
- B3: extraction temperature probe (rotary recovery with variable speed)
- B4: recovery temperature probe (rotary recovery with variable speed)

##### Digital inputs

- D1: opening of the supply damper of the area 1 /  
opening of the supply damper (external to the unit)
- D2: opening of the supply damper of the area 2
- D3: opening of the return damper of the area 1  
opening of the return damper (external to the unit)
- D4: opening of the return damper of the area 2

##### Digital outputs

- NO1: signal of the supply damper of the area 1 open  
signal of the supply damper open (external to the unit)
- NO2: signal of the supply damper of the area 2 open
- NO3: signal of the return damper of the area 1 open  
signal of the return damper open (external to the unit)
- NO4: signal of the return damper of the area 2 open

##### Analogue output

- Y1: 0...10Vdc output for wheel control (rotary recovery with variable speed)

**Important:** this expansion card must be configured with **address 9** to allow communication with the μPC MEDIUM board, as shown by the attached drawing.

## 6. STOPPING / STARTING THE UNIT

There are different ON / OFF operations for:

- **By keyboard:**

This operation is always valid. If the unit is stopped from the pGD1 terminal, it cannot be started using any of the other operations.

If the unit has stopped, all the functions and the different variables are disabled.

The ON / OFF function can be carried out:

- \* **On the pGD1 terminal:**

From the PM01 display of the MAIN MENU or by pressing the



keys for a few seconds.

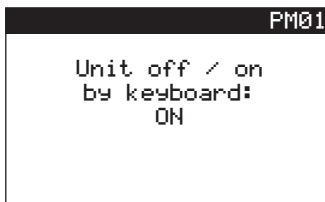
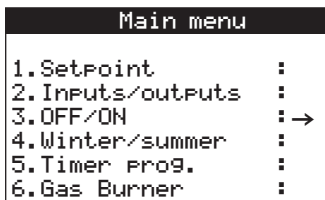

- \* **On the TCO terminal (optional):**

By pressing the key

When the unit is off, the display will only show the date, time and the OFF symbol.



- **Remote ON / OFF:**

This procedure must be enabled on the U18a display (protected by user password). On the display PM01 the "ON" option should be selected.

On the digital input DI7 of connector J4:

- open contact: unit OFF
- closed contact: unit ON

Note: To activate the remote off/on the bridge made in this input must be eliminated (see wiring diagram).

- **By schedule stage:**

With schedule programming, the unit can be stopped outside of the schedule (on the PH03 display of the group of schedule displays) The "ON" option should be selected on the control panel.

Note: If both the remote On/Off and schedule stage procedures are active at the same time, the unit will only start if both conditions coincide.

## 7. TEMPERATURE CONTROL

The control of the ambient temperature is carried out by starting up the unit, compressor and/or the available components (electrical heater, water coil etc.).

To do so, the control analyzes the temperature reading of the ambient air probe (by default) or the return probe (optional) or the TCO thermostat probe (optional).

### Setpoints selection

The program has the possibility of having two setpoints: one for operation in COOLING mode (summer) and another for operation in HEATING mode (winter).

The selection of the setpoint can be carried out:

- \* **On the pGD1 terminal:**

From the S01 display of the MAIN MENU or by pressing the key for a few seconds.

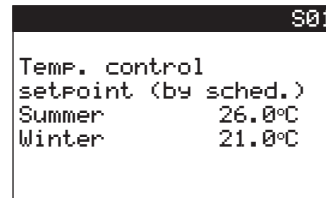
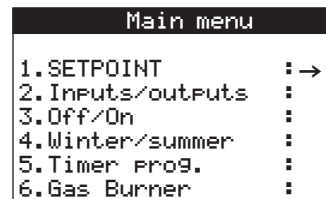

- \* **On the TCO terminal (optional):**

To modify the setpoint, it is necessary to press only the or keys.

At that time, the display will light up and the current setpoint value from active mode

(COOLING or HEATING) will appear next to the text **set**.



### Type of control

The type of control can be selected on the display CR01:

- Proportional control (P): the control will try to take the system as close as possible to the setpoint by acting directly proportionally to the difference with regard to it.
- Proportional - Integral control (P+I): in addition to proportional control a time constant is introduced which characterises the response speed (little time implies high speed). This type of control is very useful for offsetting typical oscillations in the proportional control (by default).

Parameters used	
Control of the setpoint by ambient or return T. probe	CU09
Control of the setpoint by ambient probe of TCO terminal	CU12b
Type of control: P or P+I	CR01

## 8. OPERATING MODE

### Switching of the operating mode

- **On the pGD1 terminal:**

From the FC01 display this switching is carried out.

By pressing the key, access is given to the MAIN MENU:

- **By keyboard:** summer (COOLING) mode and winter (HEATING) mode.

```

Main menu
-----
1. Setpoint          :
2. Inputs/outputs   :
3. Off/On           :
4. WINTER/SUMMER    :→
5. Timer prog.      :
6. Gas Burner       :
    
```

```

FC01
-----
Winter/summer select.
'by keyboard'

          WINTER

Enable lock:  N
    
```

Also by simultaneously pressing the following keys for a few seconds:

- : HEATING mode
- : COOLING mode

- **Only ventilation:** VENTILATION mode.

```

FC01
-----
Winter/summer select.
'only ventilation'

Enable lock:  N
    
```

- **Automatic:** there are 2 options:

- \* *Depending on the outdoor temperature (by default):* The unit changes from operation in COOLING mode to HEATING mode or vice versa depending on the temperature measured by the outdoor air probe.
- \* *Depending on the indoor temperature:* The unit changes from operation in COOLING mode to HEATING mode or vice versa depending on the temperature measured by the ambient (or return) air probe and the active COOLING and HEATING setpoints.

```

FC01
-----
Winter/summer select.
'automat.' +
          by out.T.
          WINTER
SUM. if out.T > 22.0°C
WIN. if out.T < 20.0°C
Enable lock:  N
    
```

If the «Enable lock» parameter is activated, this display is only for information, in order that the final user cannot change it. In this case it has been blocked from the A0 display of "Maintenance" (TECHNICAL MENU).

From any display, by pressing the at the same time for a few seconds, it is possible to access the start display of the TECHNICAL MENU:

```

Technical Menu
-----
User          :
MAINTENANCE  : →
Manufacturer  :
    
```

The TECHNICAL MENU is protected by an access password. If the password has to be known: please consult.

Note: All displays of the TECHNICAL MENU together with an explanation of their meaning are described in the chapter 25 of this brochure.

- **On the TCO terminal (optional):**

By pressing the key, the operating mode of the unit can be selected. With each press, the icon corresponding to the operating mode selected will be lit up.

The available modes are: HEATING - COOLING - AUTO y VENTILATION (without icon).

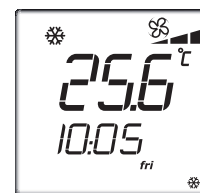

- **By digital input:**

The selection of the operating mode is performed via a switch connected on digital input DI8 of connector J16:

- open contact: COOLING mode
- closed contact: HEATING mode

Note: The selection of the type of switching "by digital input" is carried out on the CU12a display of "Manufacturer" (TECHNICAL MENU).

Parameters used	
Selection of the operating mode: by keyboard, automatic or ventilation	FC01
Selection of the switching mode	CU12a
Stop compressors by switching of the operating mode	CC04c



## 8.1. COOLING operating mode (summer) ❄️

The control will compare the temperature reading of the ambient (or return) air probe with the value set by the COOLING setpoint and with the value of the control band.

The unit will stop when the ambient (or return) temperature drops below the setpoint + one-half of the dead zone value.

The input command of the various stages is the one featured on the chart.

### • 1 compressor

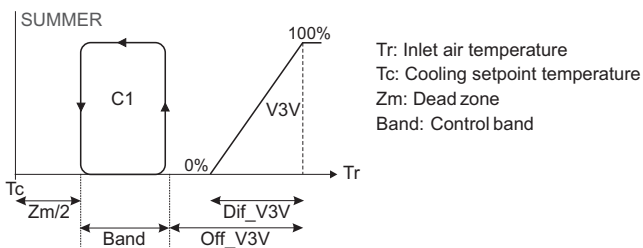

### • 2 compressors

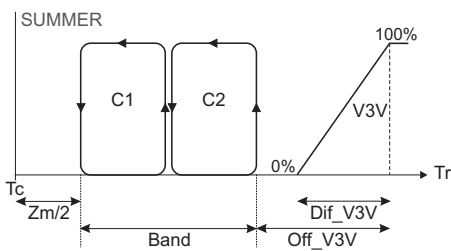

### • 4 compressors

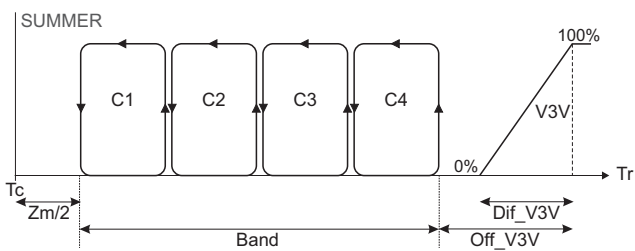

As support in COOLING mode, it is possible to incorporate a cold water coil (V3V). For the regulation of the coil, the control has a proportional or on/off output Y2 which controls the three-way valve.

For the input of the compressor stages, the control will use the control band value, whilst for the water coil (optional), it will take the differential into account.

The input command for the previous chart can be modified using parameters in order to give priority to the hot water coil.

Attention: This cold water coil can operate as support in HEATING mode. To avoid the water inlet with an inadequate temperature for each operating mode, the unit incorporates an external additional thermostat that can cut-off the 0...10Vdc signal of the Y2 analogue output.

### Illustrative example:

- Summer setpoint = 26.0°C
- Differential band = 3.0°C
- Dead zone = 0°C
- Unit without cold water coil.

### • Units 1 compressor:

With the temperature below 26.0°C, the compressor stops. If the temperature starts to rise and exceeds 29.0°C, the compressor starts.

### • Units 2 compressors:

With the temperature below 26.0°C, the compressors stop. If the temperature starts to rise and exceeds 27.5°C, compressor 1 starts. If it continues to rise and exceeds 29.0°C, compressor C2 is also activated.

If the temperature drops below 27.5°C compressor C2 stops. If it continues to drop until reaching a value below 26.0°C, compressor C1 stops (the off and on command for the compressors will depend on whether the rotation is activated or not).

### • Units 4 compressors:

The control band is divided between 4 compressors.

Parameters used	
Control setpoint COOLING mode (summer)	S01
Upper limit of temperature setpoint COOLING mode	U01
Lower limit of temperature setpoint COOLING mode	U01
COOLING mode control band	U02
Temperature dead zone	U03
Number of compressors	CU02
Cold water valve authorisation (3-way valve)	CU08
Open valve temperature offset	U28b
Valve control differential	U28b
Enabling priority water coil with regard to compressors	U28b

Note: In units equipped with tandem compressors, when the outdoor coil pressure of a circuit overcomes a limit value (41,5 bar by default), one of the two compressors will be stopped, thereby avoiding the stop of both compressors due to the high pressure. This compressor will start working again when the pressure drops below 36,5 bar.

## 8.2. HEATING operating mode (winter) ☀️

The control will compare the temperature reading of the ambient (or return) air probe with the value set by the HEATING setpoint and with the value of the control band.

As support for the units, it is possible to incorporate two electrical heater stages (R) and/or a hot water coil (V3V).

A gas burner with one or two stages can also be incorporated which will be managed as an electrical heater (both are not compatible).

For the regulation of the hot water coil, the control has a proportional or on/off output Y2 which controls the three-way valve, and for the regulation of the electrical heaters, there are two on/off outputs NO6- NO7.

The previous configuration is typical for the options however the control can also administer a proportional electrical heater stage in the output Y2 and an on/off water coil in output NO6

For the input of the compressor stages, the control will use the control band value, whilst for the input of heaters and of the water coil (optionals), it will take the respective differentials into account.

An example of input command of the various stages is the one featured on the chart.

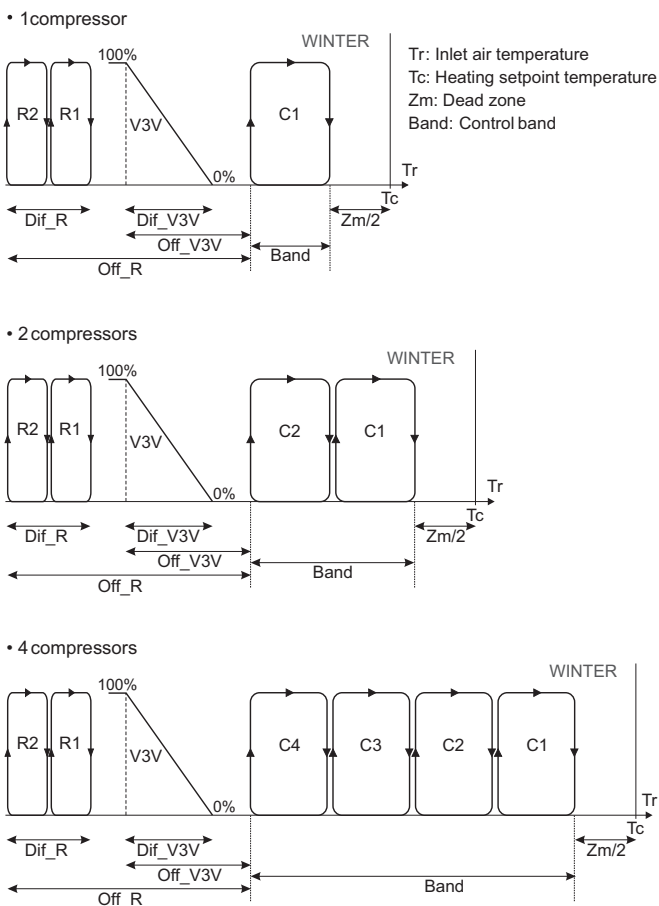

The input command for the previous chart can be modified using parameters in order to:

- give priority to the hot water coil (by default).
- activate the electrical heater stage without activating the compressor(s) for cases of compressor breakdown or blocking due to a low outdoor temperature.

Parameters used	
Temperature setpoint in HEATING mode	S01
Upper limit of temperature setpoint HEATING mode	U01a
Lower limit of temperature setpoint HEATING mode	U01a
Control band in HEATING mode	U02
Temperature dead zone	U03
Number of compressors	CU02
Heat pump	CU01
Hot water coil authorisation (3-way valve)	CU08
Open valve temperature offset	U28
Valve control differential	U28
Enabling priority hot water coil with regard to compressors	U28
Authorisation for electrical heaters	CU07
Activation of electrical heaters without compressor	CU07
Control temperature offset for heaters or burner	U20
Heater or burner control differential	U20
Gas burner authorisation	CU06

### 8.3. VENTILATION operating mode

The VENTILATION mode allows operation for only:

- supply fan,
- return fan (optional),
- free-cooling or free-heating (optional).

All components will work in AUTO mode depending on the indoor temperature.

Parameters used	
Selection of the operating mode: by keyboard, auto or ventilation	FC01

### 8.4. Forced disconnection of stages

It is possible to disconnect compressor or electrical heater stages, by using parameters or mechanically through the digital inputs of the expansion card pCOe No.2 (address 8). This is useful for reducing electric consumption:

- In time bands when the electric price rate is high (U36 display).
- With very low outdoor temperatures, in those cases where the electricity consumption or the section of the electrical outlet are limited (CC06 display).

Parameters used	
To disable the compressors by low outdoor temperature	CC06
Number of stages of compressor to disconnect	U36
Number of stages of electrical heater to disconnect	U36
To enable the stages disconnection by digital input	U36

## 9. HUMIDITY CONTROL

The humidity control of the ambient air (optional) can be carried out during dehumidification and humidification.

### 9.1. Dehumidification

This function is carried out by starting up the compressors in COOLING mode when the relative humidity of the return air is greater than the humidity setpoint established plus the differential. The compressors are stopped when they enter into the dead zone.

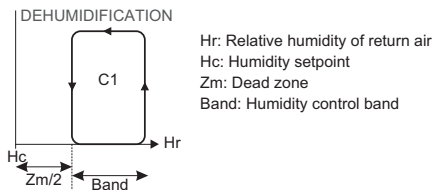

Note: In the event that several compressors have been selected in dehumidification, these will start or stop through the same dehumidification stage.

To ensure that the compressors can control humidity, the return air must have a temperature ranging between the setpoint  $\pm 15\%$  of the temperature differential and the setpoint  $\pm 85\%$  of the temperature differential, as indicated in the following chart.

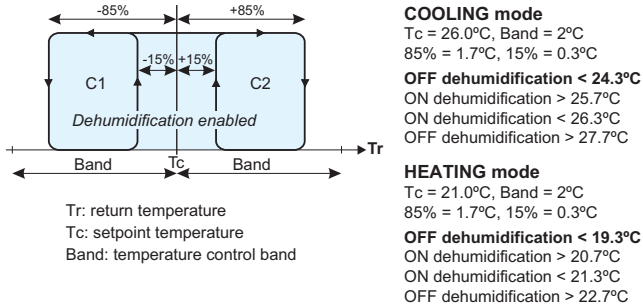

If the value "% return temperature ON dehumidification" is equal to the value "% return temperature OFF dehumidification", this graphic is not taken into account for the dehumidification, and the dehumidification by temperature is not limited.

Note: on the CU10c display, the stages of electrical heaters or the hot water coil can be selected to limit the minimum outlet temperature during dehumidification, limiting this value to 21°C in COOLING mode (summer setpoint) and 26°C in HEATING mode (winter setpoint).

Parameters used	
Selection of indoor humidity probe	CU10
Humidity control authorisation	CU10a
% return temperature dehumidification ON	CU10a
% return temperature dehumidification OFF	CU10a
Outdoor damper OFF depending on the indoor humidity	CU10a
Humidity setpoint	S02
Humidity control band	U05
Humidity regulation dead zone	U05
Number of compressors during dehumidification	U19

### 9.2. Humidification

The control during humidification requires a humidifier (optional). The control has a relay output NO7 in connector J14, an open/closed contact that allows the operation of an on-off humidifier. Also it is possible to connect a proportional humidifier in the Y1 analogue output of the pCOe expansion card No.1 (address 7).

The control of the humidifier safety devices and alarms is carried out by the actual humidifier.

The humidifier operating signal is produced when the relative humidity of the return air is less than the humidity setpoint established minus the differential.

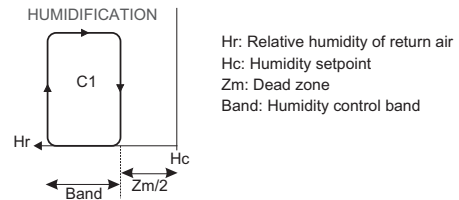

Parameters used	
Configuration of the NO7 output (connector J14)	CU03
Selection of indoor humidity probe	CU10
Humidity control authorisation: on-off or proportional	CU10a
Humidity setpoint	S02
Humidity control band	U05
Humidity regulation dead zone	U05

## 10. ACTIVE RECOVERY

For unit with a cooling recovery circuit, the compressor will function whenever there is demand for COOLING or for HEATING and when the temperature conditions for outlet, return and mixing air allow for an opening of the outdoor air damper of 10% for a period of time greater than 90 seconds (both parameters are set on the CU03 display).

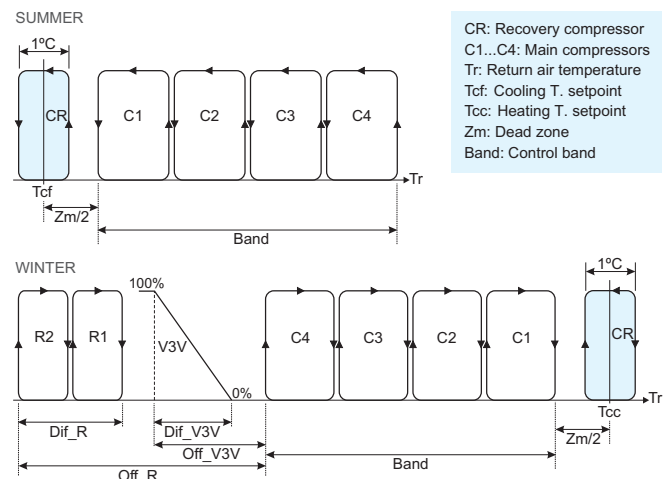

The recovery compressor can function even though there is no demand, depending on the temperature measured by the outlet air probe:

- In COOLING mode: If the outlet air temperature exceeds the value of the setpoint temperature (24°C) (S01 display).
- In HEATING mode: If the outlet air temperature drops below the value of the setpoint temperature (22°C) (S01 display).

Note: in cooling only unit with recovery circuit, it's possible to select the operating of this compressor like heat pump.

Parameters used	
Config. of the NO7 output (connector J16): recovery compressor	CU03
Minimum opening of the outdoor damper	CU03
Minimum opening time for the damper	CU03
Recovery compressor like heat pump	CU03

## 11. PASSIVE RECOVERY

- For unit with an **on-off rotary recovery**, this will function whenever there is demand for COOLING or for HEATING and when the temperature conditions for outlet, return and mixing air allow for an opening of the outdoor air damper of 5% for a period of time greater than 10 seconds (both parameters are set on the CU03 display).
- For unit with a **variable rotary recovery**, the variable wheel speed will depend on the minimum value of the extraction temperature and the recovery temperature on the wheel. If this value is lower to 6°C, the speed of the wheel decreases until reaching a minimum value fixed of 10% when the temperature is lower to 1°C (these parameters are set on the CU03 display).

Parameters used	
Config. of the NO7 output (connector J14): rotary recovery op.	CU03
Minimum opening of the outdoor damper	CU03
Minimum opening time for the damper	CU03
Variable speed (rotary recovery with variable wheel)	CU03

## 12. COMPONENT MANAGEMENT

### 12.1. Compressors

#### Rotation of the compressors

The control allows the rotation of the compressors to equal their number of operating hours. With this function, activated by default, the compressor which starts up first is the one which has the least number of accumulated operating hours.

From this moment, the type of rotation of the circuits will be:

- Grouped: First there connect all the compressors of the same circuit.
- Equalized (by default) : First there connects an alone compressor of every circuit. Once connected all the circuits there connects the second compressor of every circuit.

Note: for units with an active recovery circuit, the operation of the compressor will depend on the position of the outdoor air damper and it will not enter into rotation with the other compressors (see chapter 10).

Parameters used	
Number of compressors selected	CU02
Authorisation for the compressor rotation	CC03
Type of rotation of the compressors	CC03

### Compressor timing

All of the compressors, including the one for the active recovery circuit (optional), shall respect the following timings:

- **Delay of the start-up of the outdoor fan with regard to the indoor fan ( $t_0=30s$ )**

This determines the minimum time that should elapse between the start-up of the indoor fan and the start-up of the the outdoor fan in order to guarantee a stable airflow.

- **Delay of the start-up of the compressor with regard to the outdoor fan ( $t_1=10s$ )**

This determines the minimum time that should elapse between the start-up of the outdoor fan and the start-up of the first compressor to to limit the simultaneous start-up.

Therefore for the start-up of the first compressor it must pass:  $t_0 + t_1$

- **Minimum operation time ( $t_2=120s$ )**

This keeps the compressor in operation during the period selected. It is not allowed to be shut down unless there is a failure in the circuit.

- **Minimum shut-down time ( $t_3=180s$ )**

This determines the time that must elapse from the last shutdown of the compressor before it can start up again.

- **Time between start-ups of the same compressor ( $t_4=300s$ )**

This sets the maximum number of compressor start-ups in one hour.

- **Time between start-ups of several compressors ( $t_5=60s$ )**

This determines the minimum time that should elapse between the start-up of a compressor and the start-up of the following one. It limits the simultaneous start-up and the peaks of starting current of an unit.

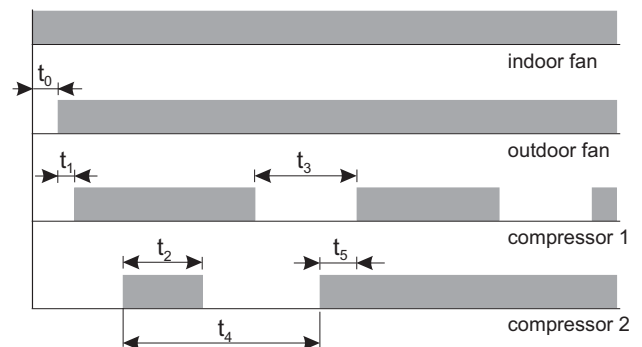

Parameters used	
Compressor start delay (with regard to the outdoor fan)	CR05
Outdoor fan start delay (with regard to the indoor fan)	CR05
Minimum stop time for a compressor	CC01
Minimum start time for a compressor	CC01
Time between compressor starts	CC02
Time between start-ups of various compressors	CC02

## 12.2. Four-way valve

In the heat pump units, there is a four-way valve per circuit which allows the HEATING / COOLING operation mode of the unit to be selected.

- Valve with voltage (N.O.): for operating in COOLING mode and during defrosting (by default).
- Valve without voltage (N.C.): for operating in HEATING mode.

Parameters used	
Selection of the direction of the reversing cycle valve (N.O.)	CU16

## 12.3. Outdoor circuit fans

### Types of fans

The control enables managing various types of outdoor fans provided that the unit is fitted with pressure transducers in the outdoor coils (by default):

- 2-speed axial (by default)
- 1-speed axial / radial
- Electronic
- Centrifugal

Parameters used	
Types of sensor in outdoor coils	CU12
Type of outdoor fan	CU05

### Operating mode

The outdoor fans will be in operation with the manufacturer's settings whenever the compressors are in operation, except in these cases:

- \* Disconnection is timed to the stopping of the compressor in 60 seconds both in COOLING mode (to reduce the condensation pressure) and HEATING mode (to remove ice from the coil).
- \* Disconnection during defrosting, except when the defrosting is started by low pressure, which will operate if the pressure rises over the ON value and will disconnect if the pressure drops below the OFF value.

### Condensation pressure control

When the unit operates in COOLING mode the condensation pressure acting on the outdoor fans can be controlled. To do so pressure transducers have to be fitted to the outdoor coils.

Note: with temperature probes (optional) the control will be made via an on/off pressostat outside the control.

The condensation control type depends on the type of outdoor fans installed in the unit:

#### - Axial / radial fans:

The control will be on/off and will not be taken into account until 120 seconds have elapsed since the operation of the compressor.

In the case of 2-speed fans the switching will be carried out between the disconnection and low speed.

- \* Outdoor fan = OFF, PFE < 19,0 bar (R410A)
- \* Outdoor fan = ON (low speed), PFE > 27,0 bar (R410A)
- \* Outdoor fan = ON (high speed), PFE > 34,0 bar (R410A)
- \* Start-up delay, 120 seconds

#### - Electronic fans:

The control will be proportional. Start-up of the fans will always be performed at maximum speed and will operate at this speed for 30 seconds. As from this moment the speed will be in accordance with the pressure measured by the sensors by the signal 0..10Vdc of the analogue outputs Y3 and Y4 (connector J4).

This function will also be used with non-electronic fans powered through a proportional voltage varistor.

- \* Initial ramp parameter, PFE = 27,0 bar (R410A)
- \* Final ramp parameter, PFE = 37,0 bar (R410A)
- \* Start-up delay to maximum speed, 30 seconds

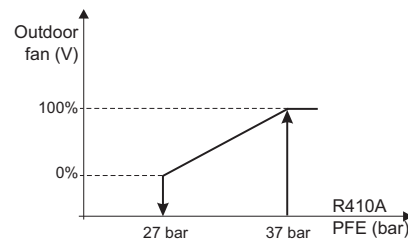

#### - Centrifugal fans:

If the unit has a damper for condensation pressure control, the control will act on the damper servomotor by the signal 0..10Vdc of the analogue outputs Y3 and Y4. This will remain open whilst the compressor is stopped and for the first 30 seconds of compressor operation. Also it will be possible to limit the minimal opening of the outdoor damper.

- \* Initial ramp parameter, PFE = 27,0 bar (R410A)
- \* Final ramp parameter, PFE = 37,0 bar (R410A)
- \* Start-up delay to maximum speed, 30 seconds

Parameters used	
Activation of the condensation control	CR06
Delay in starting the outdoor fans	CR06
Delay in stopping the outdoor fans	CR06
Speed change COOLING mode (2-speed fans)	CU05a
Maximum speed in COOLING mode (electronic fans)	CU05
Minimum speed in COOLING mode (electronic fans)	CU05
Damper for condensation control (centrifugal fans)	CU05b
Maximum opening of damper in COOLING mode (centrif. fans)	CU05b
Minimum opening of damper in COOLING mode (centrif. fans)	CU05b
Setpoint pressure for control activation	CR06a
Differential for condensation control	CR06a

### Control of the evaporation pressure

When the unit operates in HEATING mode, the evaporation pressure acting on the outdoor fans can be controlled. To do so pressure transducers have to be fitted to the outdoor coils.

Note: with temperature probes (optional) this control is not possible.

The evaporation control is the same as the condensation control.

**- Axial / radial fans:**

- \* Outdoor fan = OFF, PFE > 12,0 bar (R410A)
- \* Outdoor fan = ON, (low speed) PFE < 10,0 bar (R410A)
- \* Outdoor fan = ON, (high speed) PFE < 8,0 bar (R410A)
- \* Start-up delay, 120 seconds

**- Electronic or centrifugal fans:**

- \* Initial ramp parameter, PFE = 10 bar (R410A)
- \* Final ramp parameter, PFE = 8 bar (R410A)
- \* Start-up delay to maximum speed, 30 seconds

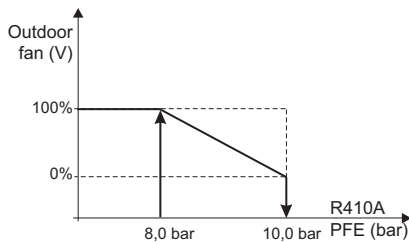

Parameters used	
Activation of the evaporation control	CR07
Delay in starting the outdoor fans	CR07
Speed change HEATING mode (2-speed fan)	CU05a
Maximum speed in HEATING mode (electronic fans)	CU05
Minimum speed in HEATING mode (electronic fans)	CU05
Damper for evaporation control (centrifugal fans)	CU05b
Maximum opening of damper in HEATING mode (centrif. fans)	CU05b
Minimum opening of damper in HEATING mode (centrif. fans)	CU05b
Setpoint pressure for control activation	CR07a
Differential for evaporation control	CR07a

### 12.4. Outdoor circuit 3-way valve

For water-air units, the outdoor circuit uses a 3-way valve that controls the water circulate by the plates exchanger. Its operation is simultaneous to the operation of the compressor, except in the following cases:

- Connection 40 seconds before the compressor.
- Timed disconnection at 300 seconds. With this, heat can be dissipated in COOLING mode and problems with freezing can be avoided in HEATING mode.

### Condensation pressure control

When the unit operates in COOLING mode the condensation pressure acting on the proportional 3-way valve can be controlled.

It will be regulated depending on the pressure measured by the refrigerant anti-freeze sensor by the signal 0..10Vdc of the analogue outputs Y3 and Y4 (J4 connector).

The control is similar to that of the electronic outdoor fans.

- \* Initial ramp parameter, PFE = 27 bar (R410A)
- \* Final ramp parameter, PFE = 34 bar (R410A)
- \* Start-up delay to maximum speed, 30 seconds

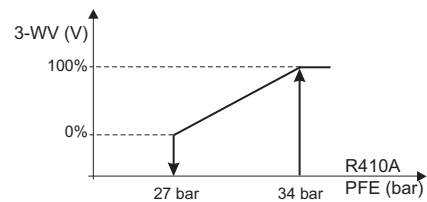

### Condensation pressure control

When the unit operates in HEATING mode the condensation pressure acting on the proportional 3-way valve can be controlled. The control is similar to that of the electronic outdoor fans.

- \* Initial ramp parameter, PFE = 10 bar (R410A)
- \* Final ramp parameter, PFE = 6 bar (R410A)
- \* Start-up delay to maximum speed, 30 seconds

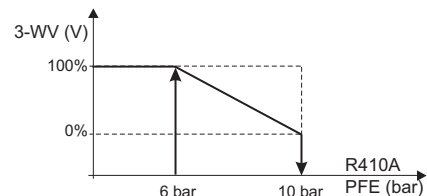

## 12.5. Indoor circuit supply fans

### Types of fans

The indoor circuit includes one or more fans that drive the air-conditioned to the premises through the network of ducts.

The control can managed different types of supply indoor fans:

- Centrifugal.
- Centrifugal with variable frequency drive (VFD). These fans adapted its rotational speed to the needs of the installation.

It is possible to select the type of speed control for supply centrifugal fans + VDF:

- \* Constant flow control (by default): in this case it is possible to fix the setpoint of flow.
- \* PWM control (0...100%): in this case it is possible to fix the percentage of speed modulation in COOLING, HEATING and VENTILATION mode.

Note: The centrifugal fan + VFD will be connected on the Field-bus of the µPC MEDIUM board by means of one card RS485, with address 1 (9600 bps, 8 bits of data, 2 stop bits without parity).



- Radial.
- Radial plug-fan. These electronic variable speed fans adapted its rotational speed to the needs of the installation.

It is possible to select the type of speed control for supply radial plug-fans:

- \* Constant flow control (by default): in this case it is possible to fix the setpoint of flow in COOLING, HEATING and VENTILATION mode.
- \* PWM control (0...100%): in this case it is possible to fix the percentage of speed modulation in COOLING, HEATING and VENTILATION mode.

In units with supply radial plug-fans and tandem compressors it is also possible to reduce the supply air flow rate up to 50% (under certain conditions of power demand).

Note: The plug-fan will be connected on the Field-bus of the  $\mu$ PC MEDIUM board by means of one card RS485, with address 1 (9600 bps, 8 bits of data, 2 stop bits without parity).

Parameters used	
Type of supply indoor fan	CU04
Type of flow control with supply centrifugal fans + VDF	A20
Setpoint of flow and speed range for supply centrifugal fans + VDF with constant control	A20
Speed modulation % for supply centrif. fans + VDF with PWM control	A20
Type of flow control with supply radial plug-fans	A00
Setpoints of flow for plug-fan with constant control	A00
Speed modulation % for plug-fan with PWM control	A00
Enabling zoning (with plug-fan and tandem compressors)	CU14
Flow % with zoning (plug-fan and tandem compressors)	U35a
Flow % without zoning (with plug-fan and tandem compressors)	U35b

### Operating mode

By default, this fan will always be in operation when the unit is ON. It can only be stopped:

- upon stopping the compressor, via the CR03 display. If this option is chosen, an ON and OFF time can be defined for the fan in order to avoid the stratification of warm air masses (CR03a display).
- In units with CO<sub>2</sub> air quality probe, when demand of air refreshing does not exist, neither of temperature nor of humidity (CR03).

Upon stopping the unit, depending on the season of the year, a time can be set during which the fan will stay in operation in order to prevent the appearance of humidity in the coil or to dissipate heat from the heaters. This delay is established in the CR04 display (by default 60s in HEATING and COOLING modes).

During maintenance operations, the indoor fan can be started up from the A09 display if no alarm prevents this.

Parameters used	
Delay in stopping the indoor fan	CR04
Indoor fan shutdown when stopping the compressor	CR03
Indoor fan shutdown without refreshing (with CO <sub>2</sub> probe)	CR03
Anti-stratification	CR03a

### Fabric ducts

For units with centrifugal fan + variable frequency drive (VFD) or plug-fans it is possible to enable an special control of the start-up for facilities with fabric ducts that it prolongs the set time.

By default, the supply flow will remain 35% for 20 seconds, as shown in the attached graphic.

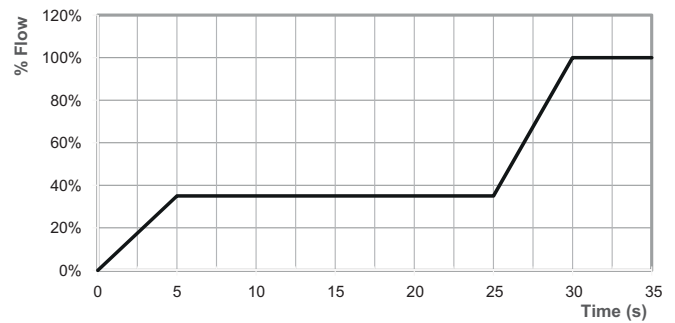

Parameters used	
Enable the reduction of flow to the start-up of the fan	A002b
% of flow for start-up of the fan	A002b
Timing of the flow reduction to the start-up of the fan	A002b

Note: For units without centrifugal fan + VFD or plug-fan it will be necessary to use a softstarter, external to the CIATrtrc control.

### Condensation pressure control

When the unit operates in HEATING mode the condensation pressure acting on the indoor fans can be controlled. To do so pressure transducers have to be fitted to the indoor coils.

The condensation control type depends on the type of indoor fans installed in the unit:

#### - Electronic plug-fans:

The control will be proportional. Start-up of the fans will always be performed at maximum speed and will operate at this speed for 30 seconds. As from this moment the speed will be in accordance with the pressure measured by the sensors. Also it will be possible limit the minimal and minimal rotational speeds.

- \* Initial ramp parameter, PFI = 27,0 bar (R410A)
- \* Final ramp parameter, PFI = 35,0 bar (R410A)
- \* Start-up delay to maximum speed, 30 seconds

#### - Centrifugal fans:

If the unit has a damper for condensation pressure control, the control will act on the damper servomotor by the signal 0..10Vdc of the analogue output Y1 (expansion card pCOe No.2). This will remain open whilst the compressor is stopped and for the first 30 seconds of compressor operation. Also it will be possible limit the minimal opening of the outdoor damper.

- \* Initial ramp parameter, PFI = 27,0 bar (R410A)
- \* Final ramp parameter, PFI = 35,0 bar (R410A)

\* Start-up delay to maximum speed, 30 seconds

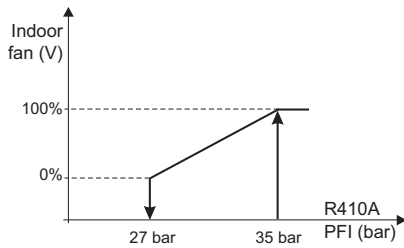

Parameters used	
Pressure transducers fitted to the indoor coil	CU12
Activation of the condensation control	CR07b
Delay in starting the indoor fans	CR07b
Nominal, minimum and maximum flows (plug-fan)	CR04
Damper for condensation control (centrifugal fans)	CU04c
Maximum opening of damper in HEATING mode (centrif. fans)	CU04c
Minimum opening of damper (centrif. fans)	CU04c
Setpoint pressure for control activation	CR07c
Differential for condensation control	CR07c

### Control of the evaporation pressure

When the unit operates in COOLING mode, the evaporation pressure acting on the indoor fans can be controlled. To do so pressure transducers have to be fitted to the indoor coils.

The evaporation control is the same as the condensation control.

#### - Electronic plug-fans or centrifugal fans with damper:

- \* Initial ramp parameter, PFI = 10,5 bar (R410A)
- \* Final ramp parameter, PFI = 9,0 bar (R410A)
- \* Start-up delay to maximum speed, 30 seconds

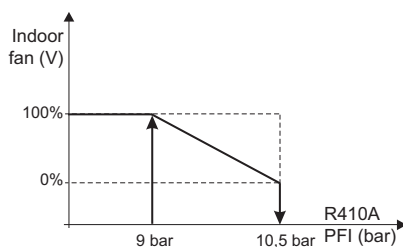

Parameters used	
Pressure transducers fitted to the indoor coil	CU12
Activation of the evaporation control	CR07d
Delay in starting the indoor fans	CR07d
Nominal, minimum and maximum flows (plug-fan)	CR04
Damper for evaporation control (centrifugal fans)	CU04c
Maximum opening of damper in COOLING mode (centrif. fans)	CU04c
Minimum opening of damper (centrif. fans)	CU04c
Setpoint pressure for control activation	CR07e
Differential for evaporation control	CR07e

### 12.6. Indoor circuit return fans (optional)

Units that incorporate a mixing box with motorized damper for extraction of air and inlet of new air can be mounted in the return air a fan of any of the following types:

- Centrifugal.
- Centrifugal fan + variable frequency drive (VFD).
- Radial.
- Radial plug-fan.

It is possible to select the type of speed control for return centrifugal + VFD fans or radial plug-fans, in the same way as for the supply fans.

Note: The centrifugal + VFD fan or radial plug-fan will be connected on the Field-bus of the  $\mu$ PC MEDIUM board by means of one card RS485, with address 2 (9600 bps, 8 bits of data, 2 stop bits without parity).

Parameters used	
Type of return indoor fan	CU041
Type of flow control with return centrifugal fans + VDF	A201
Setpoint of flow and speed range for return centrifugal fans + VDF with constant control	A201
Speed modulation % for return centrifugal fans + VDF with PWM control	A201
Type of flow control with return radial plug-fans	A001
Setpoints of flow for plug-fan with constant control	A001
Speed modulation % for plug-fan with PWM control	A001

### 12.7. Electrical heater (optional)

The control has two on/off outputs (NO5 and NO6) for controlling 2 stages of electrical heaters.

A stage can also be connected in the proportional output 0/10V (Y2 - J5 connector). This output can be used for the control of a hot water coil or a gas burner which means that these support elements are not compatible. In this case, for the control of the auxiliary coil, the off/on output NO6 can be used.

The electrical heater will be activated under the following circumstances:

- As support in HEATING mode, following the input of all the available compressors and the hot water coil (optional).
- In HEATING mode, instead of compressors.
- During the defrosting operation if selected as support.
- As support in COOLING mode in accordance with the return temperature (CR02) when the latter drops below an offset configured in U20b.
- As support in COOLING mode in accordance with the return temperature (CU10b), when the latter drops below a setpoint value configured in U12. The difference between the air outlet temperature and the ambient temperature will be limited to improve the feeling of thermal comfort (see chapter 13).





- As support in HEATING mode, in accordance with the outlet temperature (CU10c), when the latter drops below a return temperature setpoint configured in S01.

Parameters used	
Number of heater stages in HEATING mode	CU07
Activation of electrical heater without compressor	CU07
Enabling heaters during defrosting	CU07
Support heaters in COOLING mode by outlet temperature	CU10b
Limit of minimum outlet T in COOLING mode	U12
Heaters as support in HEATING mode by outlet temperature	CR010c
Heaters as support in COOLING mode by return temperature	CR02
Heaters offset in COOLING by return temperature	U20b

## 12.8. Auxiliary coil (optional)

The control has a proportional or off/on output (Y2 - connector J5) where a three-way valve can be connected (3-WV) to control a water coil.

This output can also be used to control a proportional electrical heater or gas burner which means that these support elements are not compatible.

In this case, for the control of the auxiliary coil, the off/on output NO6 can be used.

### Hot water coil

The hot water coil could be activated under the following circumstances:

- As a support in HEATING mode, as the first stage or subsequently for the input of all the available compressors (according to the display configuration U28).
- During the defrosting operation if selected as support.
- With the unit running or shut down if an anti-freeze alarm is triggered (AL09).
- With the unit stopped when the outdoor temperature drops below the value set on the CU03 display (by default 4°C).
- As support in COOLING mode in accordance with the return temperature (CR02) when the latter drops below an offset configured in U20b.
- As support in COOLING mode in accordance with the outlet temperature (CU10b), when the latter drops below a setpoint value configured in U12. The difference between the air outlet temperature and the ambient temperature will be limited to improve the feeling of thermal comfort (see Chapter 13).
- As support in HEATING mode, in accordance with the outlet temperature (CU10c), when the latter drops below a return temperature setpoint configured in S01.

Note: provided that the three-way valve is activated it will be possible to actuate the circulation pump in the support circuit if output NO7 (CU03 display) is configured as "pump".

### Cold water coil

The cold water coil could be activated as support in COOLING mode, as the first stage or subsequently for the input of all the available compressors (according to the display configuration U28b).

Parameters used	
Autorisation water coil as support in HEATING mode	CU08
Autorisation water coil as support in COOLING mode	CU08
On-off or proportional 3-WV	CU08
Enabling water coil during defrosting	CU08
Priority with regard to the compressor	U28
Pump start-up due to the outdoor T (digital output NO7)	CU03
Water coil as support in COOLING by outlet temperature	CU10b
Limit of minimum outlet temp. in COOLING mode	U12
Water coil as support in HEATING by outlet temperature	CU10c
Water coil as support in COOLING by return temperature	CR02
Offset V3V in COOLING by return temperature	U20b

## 12.9. Gas burner (optional)

The control has a proportional output 0/10V (Y2 - connector J4) where a natural gas or propane gas proportional actuator can be connected.

The CIATrtrc control will manage its connection, in HEATING mode, through an ON/OFF signal in digital output NO5. In the case of a 2nd burner stage, the control will be connected at digital output NO6.

- In cooling-only devices, the control will activate the burner the same way as an electrical heater with one or two stages.
- In heat pump units it is possible to select three different methods for controlling the burner on the G01:
  - Operation after compressors as one or two electrical heater stages (both optional not compatible).
  - Operation instead of the compressors.
  - Operation instead of the compressors if the outdoor temperature is less than the value set (5°C by default).

When the return temperature drops below the value set for the burner connection the burner will start to operate. The control of the power will be carried out in accordance with the air outlet temperature and the return temperature. The control will therefore compare both temperatures and although there is a high burner power demand, if the outlet temperature is excessively high it will limit the power supplied by the burner. This avoids the stratification of the hot air masses and that the outlet air temperature exceeds a maximum safety level, 55°C by default, which will cause the burner to stop (CS03 display).

Moreover, the difference between the air outlet temperature and the ambient temperature will be limited to improve the feeling of thermal comfort.

The gas burner integrates operations control and its safety devices. The control CIATrTc will receive a safety signal from the burner in the event of failure (digital input DI5), which will only serve to indicate the failure.

Parameters used	
Enabling of the gas burner	CU06
Enabling the gas burner in defrosting mode	CU06
Maximum outlet temperature limit	CS03
Temperature offset burner control	U20
Burner control differential	U20
Offset between ambient and outlet T. in HEATING mode	U12c
Minimum setpoint outlet temperature in HEATING mode	U12c
Maximum setpoint outlet temperature in HEATING mode	U12c
Outlet T differential in HEATING mode	U12c

### 13. OUTLET AIR TEMPERATURE CONTROL

The control of outlet is activated when two circumstances are fulfilled:

- The outlet temperature is included between the maximum and minimum values of outlet setpoints.
- The difference between the outlet temperature and the ambient temperature is lower than the offset set. The ambient probe improves the outlet temperature control, limiting the difference between both temperatures. It increases the thermal comfort level of the installation.

This control is performed via a P+I control with an integration time of 120 seconds (set on the CR01a display) in order to counteract oscillations in outlet air temperature and to avoid continuous connection/disconnections of the compressors.

Parameters used	
Type of outlet temperature control	CR01a
Integral time in P+I control	CR01a

#### Control in COOLING mode

The control of the minimum temperature limit in the outlet air prevents excessively significant drops in the ambient temperature.

In COOLING mode, the control is activated when the outlet temperature is included between the maximum and minimum setpoint values fixed in the U12b display, and the difference with the ambient temperature is lower than the offset set in the display. The compressors will gradually disconnect to avoid an excessively low outlet temperature.

The following components could be used as "support" to increase it (in this order): hot water coil (V3V) - compressors in HEATING (C) - mode electrical heaters (R). The authorisation for the operation of these components is established on the CU10b display.

Next, the temperature control band is divided among the authorized "number of components". The hot water coil is equivalent to 2 control stages, the total number of compressors to another 2 and each electrical heater to 1 stage.

#### Control in HEATING mode

The control of the maximum temperature limit in the outlet air avoids the stratification of the hot air masses.

In HEATING mode, the control is activated when the outlet temperature is included between the maximum and minimum setpoint values fixed in the U12c display and the difference with the ambient temperature is higher than the offset set in the display. The support stages and the compressors will be disconnected (always starting with the electric stages) in order to avoid an excessively high temperature.

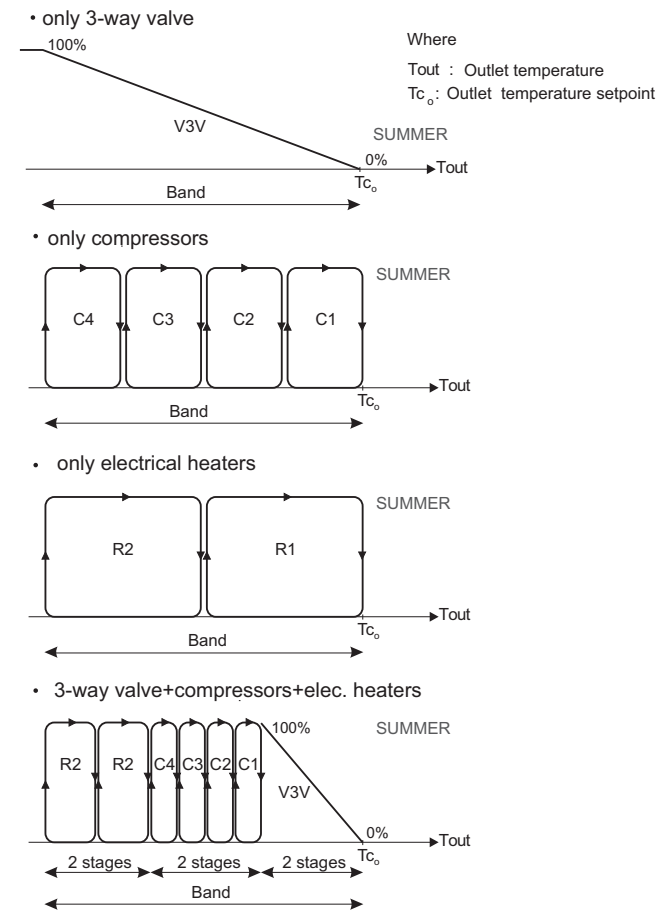

Parameters used	
Enabling ambient T probe(s): NTC, RS485, 4-20mA or pLAN	CU09
Offset between ambient and outlet T in COOLING mode	U12b
Minimum setpoint of outlet T in COOLING mode	U12b
Maximum setpoint of outlet T in COOLING mode	U12b
Outlet T differential in COOLING mode	U12b
Outlet control with heat valve in COOLING mode	CU10b
Outlet control with compressors in COOLING mode	CU10b
Outlet control with electrical heater in COOLING mode	CU10b
Offset between ambient and outlet T in HEATING mode	U12c
Minimum setpoint of outlet T in HEATING mode	U12c
Maximum setpoints of outlet T in HEATING mode	U12c
Outlet T differential in HEATING mode	U12c

Note: when the control of outlet is activated, on the main displays P01 and P02 intermittently appears the text "LIMIT".

## 14. OUTDOOR AIR DAMPER

For control of the outdoor air damper (optional), the control has a proportional output 0/10V (Y1). This will be activated for the following circumstances:

### 14.1. Free-cooling

The operation of the free-cooling, in units with mixing box, allows the outdoor air conditions to be taken advantage of when these are more favourable than those of the return air.

Note: the free-cooling function is not compatible with the activation of the rotary recuperator or the recovery circuit. After free-cooling, the first compressor of the main circuit will enter into operation, if necessary.

To check whether or not the conditions of the outdoor air are more favourable than those for the return air, three procedures can be used:

- For **thermal free-cooling**, the opening of the outdoor air damper is ordered when the temperature of the outdoor air is lower than that of the return air plus a differential. In this case, the control uses the outdoor and return air temperature probes.
- For **enthalpic free-cooling**, the control calculates the enthalpy of the return air and of the outdoor air based on the temperature and relative humidity readings of the return and outdoor air. After calculating the enthalpies, carry out the following comparison:
  - \* Damper closed and  $(\text{Hint-Hext}) > \text{enthalpy diff.}$ , damper opens.
  - \* Damper open and  $(\text{Hint-Hext}) \leq \text{enthalpy diff.}$ , damper closes.
- For **thermoenthalpic free-cooling**, the opening of the outdoor air damper is performed when the enthalpy of the outdoor air is lower than that of the return air plus a differential and it also meets the condition that the outdoor temperature is lower than that of the return air by 1°C, which allows the outdoor conditions to be taken advantage of in a better manner.

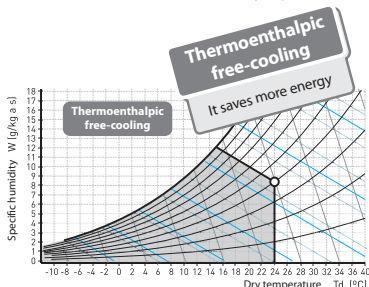
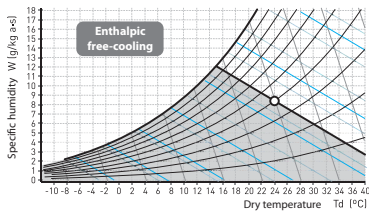
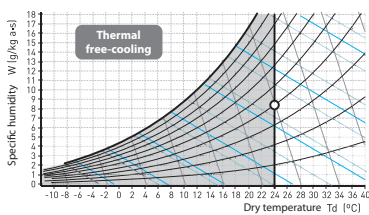

### Free-cooling in summer

The free-cooling will be active when the following conditions are met:

- The unit is operating in COOLING or AUTO mode.
- Free-cooling function summer authorised.
- The outdoor temperature is less than the return temperature minus the free-cooling differential.

Free-cooling function depends on two parameters:

- Offset: this defines the difference between the setpoint and the air return temperature at which the outdoor air damper begins the opening.
- Differential: the opening of the outdoor air damper is carried out in accordance with the return air temperature.

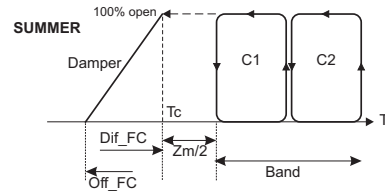

In CC05, it is possible to disable the compressors if it is considered that the difference between the return temperature and the outdoor temperature is sufficient with free-cooling.

### Free-cooling in winter

Free-cooling in winter is useful, for example, in shopping centres, discos etc. where, during operation in winter, due to overheating, the temperature is always greater at the setpoint and cooling has to be initiated instead of heating.

This function will be active provided that the following conditions are met:

- The unit is operating in HEATING mode.
- Free-cooling function winter authorised.
- The outdoor temperature is less than the return temperature minus the free-cooling differential.
- The outlet temperature is above 10°C.

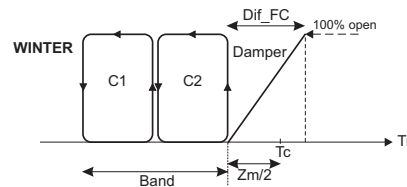

Parameters used	
Configuration of the outdoor temperature probe	CU10
Configuration of the outdoor humidity probe	CU10
Authorisation of the free-cooling function summer / winter	CU14
Control free-cooling summer / winter	CU14a
Summer/winter temperature setpoints	S01
Temperature differential for enabling free-cooling	U07
Humidity setpoint	S02
Differential of enthalpic free-cooling	U08
Maximum opening of the outdoor damper with free-cooling	U07 or U08
Offset and differential of damper with free-cooling summer	U09

## 14.2. Air refreshing

### Units with mixing air probe

When the outdoor conditions do not permit free-cooling, but air refreshing is required, control of the outdoor air damper can be carried out according to 3 parameters:

1. Desired refreshing percentage. This value is established on U011.
2. Outlet - return air temperature. If the outlet and/or return air temperature conditions are very unfavourable, the command is given to close the outdoor damper, ignoring air refreshing, until optimum conditions are reached.
  - In HEATING mode, the minimum outlet and/or return air temperatures are set in the CU15a display.
  - In COOLING mode, the maximum outlet and/or return temperatures are set in the CU15b display.

The following chart shows the logic applied by the control with the value obtained for these temperatures:

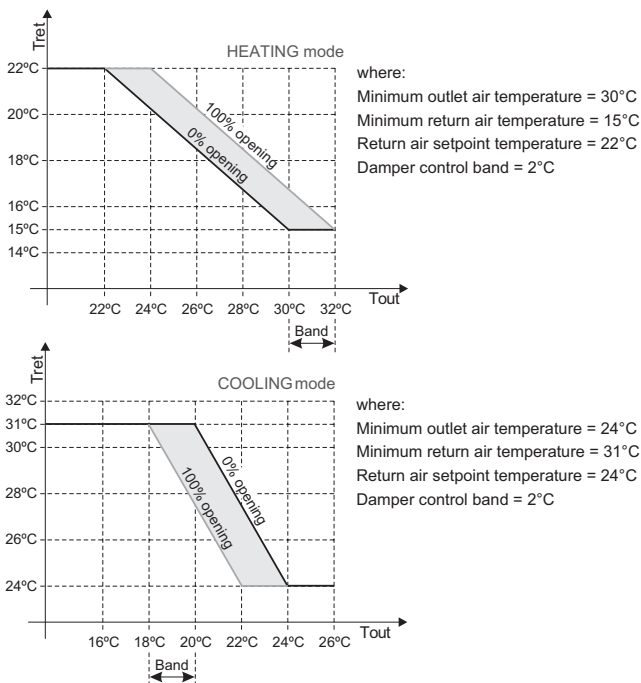

3. Minimum mixing air temperature. This value is established on the CU11a display, on 12°C in HEATING mode and 35°C in COOLING mode.

The control will calculate the refreshing percentage in accordance with the outdoor, return and minimum mixing air temperatures:

$$\% \text{ refreshing} = \frac{\text{Return air } T - \text{mixing air } T (12^\circ\text{C})}{\text{Return } T - \text{outdoor } T} \times 100$$

The control will compare the 3 opening percentages obtained and, with the lowest of these 3 values, will establish the instantaneous opening of the outdoor air damper (can be displayed in A11).

Next, depending on the air refreshing calculated with the following formula, the opening or the closing of the damper will be ordered:

$$\% \text{ refreshing} = \frac{\text{Return air } T - \text{mixing air } T}{\text{Return } T - \text{outdoor } T} \times 100$$

For the opening or closing of the damper, a maximum variation is established of 3% over a period of 60s. Both parameters are established on the A11 display.

Note: the maximum opening value of the damper can also be blocked by parameter and will take priority over the one previously obtained.

If the outdoor conditions change and the unit starts to request free-cooling, the starting position of the damper will be the one that it had for air refreshing at this time.

Parameters used	
Percentage of outdoor air for refreshing	U011
Outdoor damper during start in winter	U011
Mixing temperature for closing the outdoor air damper	CU11a
Outlet T for closing the outdoor air damper in HEATING mode	CU15a
Return T for closing the outdoor air damper in HEATING mode	CU15a
Control band for closing the outdoor damper in HEATING mode	CU15a
Outlet T for closing the outdoor air damper in COOLING mode	CU15b
Return T for closing the outdoor air damper in COOLING mode	CU15b
Control band for closing the outdoor damper in COOLING mode	CU15b
Opening calculation time	A11
% opening damper in calculation time	A11

Note: during defrosting and, with the unit shut down, the outdoor damper will remain closed.

### Units with mixing air probe + quality probe

If the unit has an air quality probe (in the B10 input of the board or in the pLAN network) in addition to the mixing temperature probe.

The control of the damper will be carried out in accordance with the % of volatile particles and/or CO<sub>2</sub> particles measured and the mixing T.

The instantaneous opening percentage will be calculated depending on:

- Outlet temperature - return.
- Measurement of the quality probe (ppm).
- Minimum mixing air temperature.

Using these two probes together improves the management of the air refreshing with low outdoor temperatures.

Parameters used	
Probe type in B10 an.input (CO <sub>2</sub> air quality / return air humidity)	CU11
Activating the air quality control	CU11
Minimum return temperature for damper opening	CU11
Setpoint air quality probe control	U12d
Differential air quality probe control	U12d
Outlet T for closing the outdoor air damper in HEATING mode	CU15a
Return T for closing the outdoor air damper in HEATING mode	CU15a
Control band for closing the outdoor air damper in HEATING mode	CU15a
Outlet T for closing the outdoor air damper in COOLING mode	CU15b
Return T for closing the outdoor air damper in COOLING mode	CU15b
Control band for closing the outdoor air damper in COOLING mode	CU15b
Opening calculation time	A11
% opening damper in calculation time	A11

### 14.3. Overpressure

In installations with different air flow in supply and return (to prevent the entry of outside air or to eliminate odors from inside) the outdoor damper and the extraction damper will be managed independently.

For the regulation of the extraction damper, the control has a proportional output 0/10V (Y2) of the pCOe expansion module No.1 (address 7).

- The percentage of opening of the extraction damper shall be obtained from the following formula:

$$\% \text{ extrac. damper} = \% \text{ outd. damper} - \left[ \left( \frac{\text{return flow}}{\text{supply flow}} - 1 \right) \times 100 \times K \right]$$

where:

K = overpressure constant (this constant allows to adjust the opening of the extraction damper in the site).

- The value calculated for the extraction flow will be:

$$\text{extraction flow} = \text{refreshing flow} - (\text{supply flow} - \text{return flow})$$

Important: this type of control of the dampers penalizes the extraction of air and thereby, the cooling recovery.

Parameters used	
Supply and return flows	A002
Overpressure calculation	A002
Overpressure constant	A002
% of opening of tehe extraction and outdoor dampers	A002
Refreshing and extraction flows	A002a

- The outdoor temperature is lower than 10°C (CD05 display).
- The pressure or temperature measured in the outdoor coil(s) is lower than the initial value for defrosting (set in the CD09 display).
- The time that must elapse from the last defrosting of the affected circuit has been excelled (CD06 display).
- The time that must elapse from the last defrosting of another circuit has been excelled (CD06 display).

Parameters used	
Initial setpoint defrosting by minimum	CD04
Initial setpoint defrosting by difference with outdoor temperature	CD05
Outdoor temperature for defrosting by differ. with outdoor T.	CD05
Time between defrosting of different circuits by difference with outdoor temperature	CD06
Minimum time between defrosting of the same circuit by difference with outdoor temperature	CD06

### 15.1. Defrosting operation

#### Starting defrosting

In order to start, the following conditions must be met:

- Unit operating in HEATING mode.
- Compressors in operation.
- Pressure or temperature measured by the outdoor coil probe must be lower than the defrosting start (by default, set in CD09 to a value of 5,6 bar with pressure probes or to -5°C with temperature probes).

If these conditions are met, once the delay has elapsed at the start of defrosting (CD10), the shut-down of the compressor(s) (CC04a) will be triggered.

30 s after the compressors are stopped, the regimen will be changed, giving power to the 4-way valve (CC04b).

After 15 s, the compressors will be started up so that they can perform the defrosting procedure. During the defrosting operation, the behaviour of the other unit components will be as follows:

- The electrical heaters (optional) can be enabled as back-up in the CU07 display.
- The hot water coil (optional) can be enabled as back-up in the CU08 display.
- The gas burner (optional) can be enabled as back-up in the CU06 display.
- The indoor fan will continue to operate.
- Outdoor fans: when a set pressure (35 bar, by default) is exceeded, if the outdoor temperature is greater than -5°C, the outdoor fans will be connected and will not be disconnected until it drops below the other pressure value (33 bar, by default), the outdoor temperature drops below -6°C, or a maximum connection time elapses.

This action enables prolonging the duration of defrosting and, as such, the ice accumulated on the coil is completely removed.

Note: in the case of temperature probes, the outdoor fans will be connected when the tared pressure from the condensation pressure control pressostat is exceeded.

## 15. DEFROSTING FUNCTION

For air-air unit operating in HEATING mode, the defrosting of the outdoor coils is performed by cycle inversion in order to remove any ice which has accumulated on them.

Defrosting is carried out as a function of pressure (temperature) of evaporation in the following cases:

- Defrosting by minimum pressure or temperature**

If the evaporation pressure or temperature measured by the outdoor coil sensor(s) drops below the setpoint configured on the CD04 display (by default 2.5 bar with pressure transducers or -21°C with temperature probes).

Note: If the unit tries to perform a 4th defrosting operation due to minimum pressure or temperature in less than an hour this could be due to a lack of refrigerant caused by a small leak or failure in the expansion valve which means that the control will trigger a low pressure alarm. This safety device is reset manually.

- Defrosting by difference with the outdoor temperature**

The defrosting function is activated if the difference between the temperature measured by the outdoor probe and the evaporation temperature measured in the outdoor coil(s) exceeds the value set in the CD05 display (by default 16°C).

In addition to this condition, always it is necessary that:

- If it includes an outdoor air damper, this will remain closed.
- If it includes a rotary recovery, in the CS03 display, one can select that the outdoor damper remain open to allow the recovery operation.

### Ending defrosting

The following conditions must be met in order to end:

- By pressure or temperature, when the outdoor coil probe, or the minimum of the two in the case of simultaneous defrosting, is above the end of defrosting setpoint (CD10).
- By maximum time if the above condition has not been met once the set maximum time has elapsed (CD09).
- By opening the high pressure pressostat. This alarm will not be indicated.

When the defrosting operation ends, the compressor(s) (CC04a) will stop, the four-way valve (CC04b) will be reversed again and, once this time has elapsed, it will be possible to restart the compressor(s) by the normal pressure or temperature control.

Parameters used	
Start defrosting setpoint	CD09
End defrosting setpoint	CD09
Delay in defrosting start	CD10
Enabling heaters during defrosting	CU07
Enabling V3V during defrosting	CU08
Enabling burner during defrosting	CU06
Off indoor fan	CD11
Outdoor gate open or closed with rotary recuperator	CU03
Start defrosting procedure setpoint by minimum	CD04
Maximum connection time of outdoor fans minimum	CD04
Pressure ON for outdoor fans	CD07
Pressure OFF for outdoor fans	CD07
Start defrosting procedure setpoint by difference with outdoor T.	CD05
Maximum connection time of outdoor fans by diff. with outdoor T.	CD05
Shutdown compressors when starting/ending defrosting	CC04a
Shut-down time for compressors when starting / ending defrosting	CC04a
4-WV: Shutdown time before/after compressors	CC04b

## 16. ANTI-FREEZE SAFETY IN WATER-AIR

This is done through the analogue inputs on the  $\mu$ PC MEDIUM board: B7 (circuit 1) - B12 (circuit 2) and the pCOe expansion card No.1 (address 7): B1 (circuit 3) - B2 (circuit 4), through the conversion to the measurement temperature taken by the pressure transducer located between the plate exchanger and the cycle reversing valve.

This safety device is started if, after 120 seconds of operation by the compressor working in HEATING mode, the refrigerant temperature is lower than  $-2^{\circ}\text{C}$  (early alarm). If this temperature does not exceed  $-1^{\circ}\text{C}$  after 90 seconds the compressor stops. Once the minimum OFF time of the compressor has elapsed, if the refrigerant temperature is greater

than  $6^{\circ}\text{C}$  ( $-2^{\circ}\text{C} + 8^{\circ}\text{C}$  differential), the compressor can once again be started. Otherwise, the refrigerant anti-freeze alarm is considered and it will be manually reset.

If the refrigerant temperature is less than  $-5^{\circ}\text{C}$  after the compressor has been operating for 120 seconds, the compressor is stopped and directly, and without delay, the refrigerant anti-freeze alarm is considered.

If 10 early anti-freeze alarms ( $T^a < -2^{\circ}\text{C}$ ) are triggered in less than 120 seconds these will also be considered as a refrigerant anti-freeze alarm.

Note: If 10 alarms are triggered in less than 24 hours the water-air unit is blocked by the anti-freeze alarm. In this case, support service (SAT) must be contacted.

Parameters used	
Initial value of the anti-freeze alarm for water-air units	CS02
Differential value of the anti-freeze alarm for water-air units	CS02

## 17. OUTDOOR T COMPENSATION

This function allows the setpoint temperature to vary in accordance with the temperature measured by the outdoor air probe.

The outdoor temperature compensation rules are different for HEATING and COOLING mode operation.

The compensation of the setpoint enables thermal "shock" between the inside and outside of the premises to be prevented whilst at the same time providing significant energy savings when the outdoor temperature values are particularly significant for ambient temperature control.

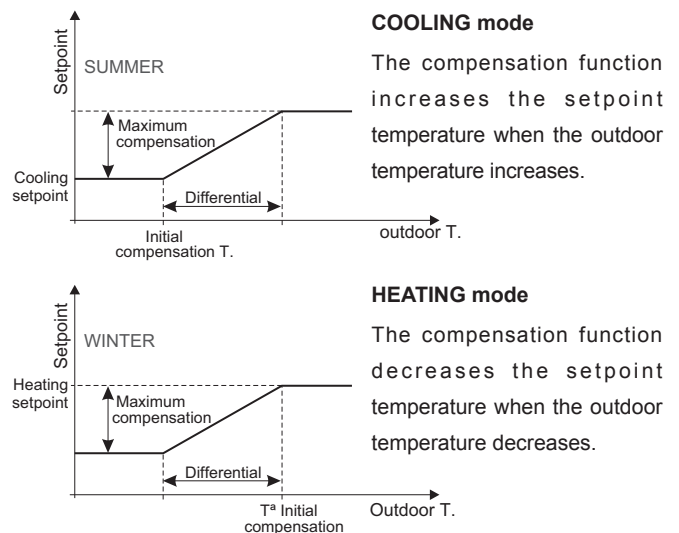

Parameters used	
Compensation authorisation	CU12
Outdoor temperature to start compensation in COOLING mode	U13
Outdoor temperature differential in COOLING mode	U13
Maximum compensation in COOLING mode	U13
Temperature start compensation in HEATING mode	U14
Outdoor temperature differential in HEATING mode	U14
Maximum compensation in HEATING mode	U14

## 18. SCHEDULE PROGRAMMING

### 18.1. Schedule programming with pGD1 terminal

The pGD1 terminal includes up to 3 programs with 3 daily time slots per program and allows the selection of one of these 3 programs for each day of the week (PH01 to PH15 displays).

#### Daily programming

In each of the three daily programs, it is possible to establish a maximum of three time slots during which the unit will be connected.

For example:

- Program 1: morning from 9:00h to 13:30h (1st slot)  
evening from 17:00h to 20:00h (2nd slot)
- Program 2: morning from 8:00h to 15:0h (1st slot)
- Program 3: morning from 10:00h to 14:0h (1st slot)

Parameters used	
Schedule program no. 1 (3 connection slots)	PH04
Schedule program no. 2 (3 connection slots)	PH05
Schedule program no. 3 (3 connection slots)	PH06

```

PH04
-----
SCHEDULE PROGR. N.1
Slot1 > 09:00 to 13:30
Slot2 > 17:00 to 20:00
Slot3 > 00:00 to 00:00
    
```

On this display it is possible to set the time slots for program 1. The number of slots will be comprised between 1 (minimum) and 3 (maximum). Within the slots, the unit will be running with a fixed setpoint. Outside of the slots, the unit will work with a different setpoint from the previous one or shut down, according to the type of start selected on the previous PH03 display.

#### Start type

The start type and the condition of the unit outside of the schedule program will be selected on the PH03 display:

```

PH03
-----
START TYPE
3 setpoints schedule
+ OFF of unit
- ON for SET LIMITE -
Disab. comp. COOL: YES
Dis. air refresh.: YES
    
```

- **ON/OFF schedule:** within the program the unit will operate with the setpoint established on the displays PH07 and PH08, whilst outside the schedule it will be stopped.
- **Schedule only setpoint change:** two control setpoint temperatures will be set on displays PH07 and PH08: one, during the program slots and another outside the program.

- **ON/OFF schedule with ON limit SET:** outside the schedule program the unit is off, however a start safety device is established when the temperature goes above or below the limit setpoints introduced in PH09, PH10 and PH11.
- **3 setpoint schedule + OFF of the unit:** outside the schedule program the unit is off, inside the schedule 3 setpoints can be established: CONFORT: standard setpoint, ECONOMY: setpoint more removed from the comfort point, used at times with low occupancy of the building and PROTECTION: setpoint of building protection, usually used at night, when the building is empty. This schedule is programmed in displays PH13, PH14 and PH15.
- **Forced:** for an occasional start or stop of the unit without modifying the set schedule program. When it ends, the unit goes back to the start-up type that was set.

Parameters used	
Start type	PH03
On time with forced start	PH03
Setpoint during COOLING schedule program	PH07
Setpoint outside COOLING schedule program	PH07
Setpoint during HEATING schedule program	PH08
Setpoint outside HEATING schedule program	PH08
Setpoint due to limit COOLING schedule program	PH09
Setpoint due to limit outside COOLING schedule program	PH09
Setpoint due to limit HEATING schedule program	PH10
Setpoint due to limit outside HEATING schedule program	PH10
Differential due to limit COOLING schedule program	PH11
Differential due to limit HEATING schedule program	PH11
Setpoints CONFORT, ECONOMY, PROTECTION in COOLING	PH14
Differential of PROTECTION mode in COOLING	PH14
Setpoints CONFORT, ECONOMY, PROTECTION in HEATING	PH15
Differential of PROTECTION mode in HEATING	PH15

#### Weekly programming

The control verifies each day of the week during which the operation of the unit is authorised on the PH12 display. If this is the case, the schedule program established for this day will be followed.

```

PH12
-----
Program selection
Daily start
M:1 T:1 W:1 T:1 F:2
S:3 S:0 -Mon- (0=off)
    
```

Parameters used	
Selection of the program each day of the week	PH12

## 18.2. Schedule programming with TCO terminal

With the TCO terminal enabled (optional), the schedule programming of this terminal can be done (PH16 and PH17 displays).

The TCO terminal has a schedule programmer that allows 6 time slots to be chosen for each day of the week.

A change in the setpoint temperature or the disconnection of the unit can be scheduled in these time slots.

### Enter the time for the terminal

By pressing the key for a long time, the terminal changes to the initial clock display (CLOC). From there, by pressing the key, the time update display is accessed.



The current time appears intermittently and can be modified with the help of the keys. The new time can be validated with the key. The minutes appear below intermittently. Its value can also be modified with the keys and validated with the key.



There are two ways of returning to the main display: by repeatedly pressing the key or not acting on the terminal for some seconds.

### Creation of a schedule programme

By pressing the key for a long time, the terminal changes to the initial clock display (CLOC).



Next, by pressing the key, the terminal changes to the initial schedule programming display (TIME BAND).

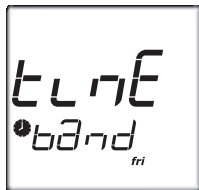

If it desired to abandon the programming, by pressing the key again, the terminal changes to the exit display (ESC), which is exited by pressing .



If it is desired to continue with the scheduled programme, must be pressed with the terminal on the initial programming display (TIME BAND).

The text SEL DAYS will then appear on the display to select the days of the week to which the schedule will apply. With the keys, the following groups can be selected:

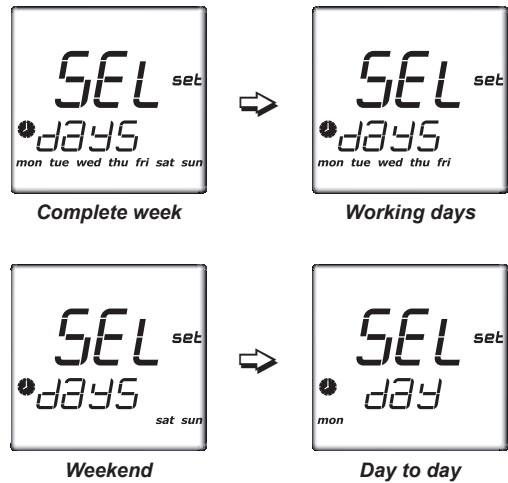

If it desired to abandon the programming, by pressing the key again, the terminal changes to the exit display (ESC), which is exited by pressing .



If it is desired to continue with the scheduled programme, the key must be pressed on the display of the days to which it applies in order to access the first time slot. The sequence of these slots is as follows:



The first time slot will flicker on this display. If it desired to schedule this slot, the key will be pressed and automatically stop flickering, going on to appear as follows:

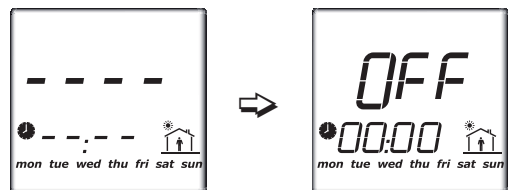

Next, with the key, the activation time of the programming for the selected slot will be set, and then, whether the unit will remain stopped (OFF) or at the setpoint value.



Finally, the schedule slot will cease flickering. By pressing the key, the scheduling created will be saved and the terminal will go on to display the next slot.

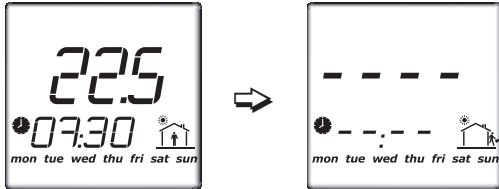

It will be necessary to define a minimum of two slots for each day, since only the initial time is established for each slot, and not the ending time.

To delete the schedule from a time slot, it is necessary to select it with the key, and then, by pressing the keys, the time will be modified until the display returns to show the following:

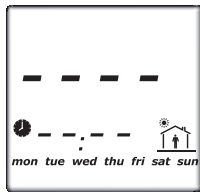

Note: Before making a new schedule, it must be checked whether there is already one defined. If any schedule is made that may affect another that is already stored, the latter will not be saved.

### Activation of the timer programming

By pressing the for a short time, the stored schedule programming corresponding to the activation time is activated.

The symbol and the active scheduling slot will always appear on the main display, both on stopped units and units in operation.

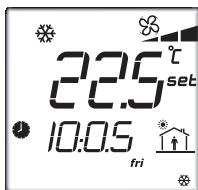
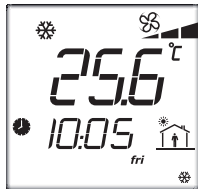
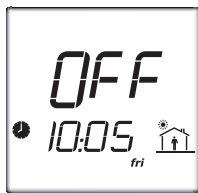

With the unit in operation, by pressing the keys or the setpoint for the time slot will be shown.

Note: The text **set** will appear next to the setpoint value.

To deactivate the scheduled programme, it is necessary only to press the key for a short while.

## 19. ALARMS

### 19.1. Alarm display

The alarms display can be realized:

\* On the pGD1 terminal:

There is/are active alarm(s) if the key is illuminated red. By pressing the key once, the description of the first alarm will be shown.

By using the keys, the other alarms stored in the memory can be consulted. For example:

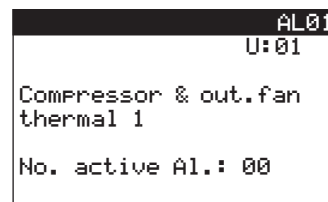

By pressing this key for a second time, the alarm(s) will be reset. If no alarm is active, the message "No alarm active" appears.

The H01 display features the description of the 100 last alarm generated, as well as its date and time, the ambient or return temperature (Tr) and the outdoor temperature existing at the time of the alarm.

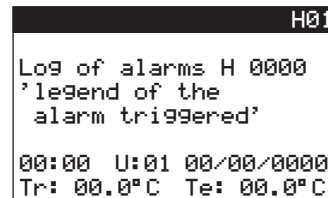

\* On the TCO terminal (optional):

If the icon appears on the TCO terminal display, there is/are active alarm(s).

In addition to view in the ambient (or return) air temperature on the main display, it is possible to view other values through the set that is activated by pressing the key. One of those values may be an alarm code. If there is more than one alarm is indicated the code of the most important alarm, And below the symbol AL.



With the key, It is possible to write on the display the value "0" in the place of the alarm. Pressing the key will reset inactive alarms and will return to the main display.

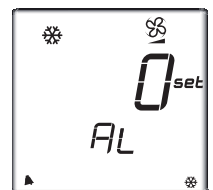

The icon will disappear from the display if there is no active alarm.

## 19.2. Alarms list

Controlled alarms	Shutdown unit	Shutdown affected circ.	Type of reset	Timing	Actuation	pGD1	TCO	Addr.
Thermal protection of compressor(s) and outdoor fan(s) circuit 1	No	Yes	Auto (*)	No	Shutdown circuit 1	AL01	AL1	27
Thermal protection of compressor(s) and outdoor fan(s) circuit 2	No	Yes	Auto (*)	No	Shutdown circuit 2	AL02	AL2	28
Thermal protection of compressor(s) and outdoor fan(s) circuit 3	No	Yes	Auto (*)	No	Shutdown circuit 3	AL01a	AL101	151
Thermal protection of compressor(s) and outdoor fan(s) circuit 4	No	Yes	Auto (*)	No	Shutdown circuit 4	AL02a	AL201	152
High pressure circuit 1	No	Yes	Auto (*)	No	Shutdown circuit 1	AL05	AL5	29
High pressure circuit 2	No	Yes	Auto (*)	No	Shutdown circuit 2	AL06	AL6	30
High pressure circuit 3	No	Yes	Auto (*)	No	Shutdown circuit 3	AL05a	AL501	153
High pressure circuit 4	No	Yes	Auto (*)	No	Shutdown circuit 4	AL06a	AL601	154
High and low pressure recovery circuit	No	No	Auto (*)	No	Shut-down of the recovery compressor	AL07	AL7	118
Maintenance of the recovery compressor	No	No	Manual	No	Only indication	AL08	AL8	119
Anti-freeze alarm of hot water coil	Yes (in COOLING mode)	Yes (in COOLING mode)	Manual	Yes 2 seconds	HEATING mode: this closes outdoor air damper and opens hot water coil valve COOLING mode: this stops compressors and closes outdoor damper	AL09	AL9	31
High return temperature	No	No	Manual	Yes, programm.	Only indication	AL10	AL10	34
Low return temperature	No	No	Manual	Yes, programm.	Only indication	AL11	AL11	35
Low pressure circuit 1	No	Yes	Auto (*)	No	Shutdown circuit 1	AL12	AL12	38
Low pressure circuit 2	No	Yes	Auto (*)	No	Shutdown circuit 2	AL13	AL13	39
Low pressure circuit 3	No	Yes	Auto (*)	No	Shutdown circuit 3	AL12a	AL1201	155
Low pressure circuit 4	No	Yes	Auto (*)	No	Shutdown circuit 4	AL13a	AL1301	156
Low pressure due to continuous defrosting by min. pressure or T circ.1	No	Yes	Auto (*)	No	Shutdown circuit 1	AL12b	AL1202	225
Low pressure due to continuous defrosting by min. pressure or T circ.2	No	Yes	Auto (*)	No	Shutdown circuit 2	AL12c	AL1203	226
Low pressure due to continuous defrosting by min. pressure or T circ.3	No	Yes	Auto (*)	No	Shutdown circuit 3	AL13b	AL1302	227
Low pressure due to continuous defrosting by min. pressure or T circ.4	No	Yes	Auto (*)	No	Shutdown circuit 4	AL13c	AL1303	228
Compressor 1 - circuit 1 maintenance	No	No	Manual	No	Only indication	AL16	AL16	36
Compressor 1 - circuit 2 maintenance	No	No	Manual	No	Only indication	AL17	AL17	37
Compressor 2 - circuit 1 maintenance or compressor 1 - circuit 3 (unit 4 circ.)	No	No	Manual	No	Only indication	AL18	AL18	122
Compressor 2 - circuit 2 maintenance or compressor 1 - circuit 4 (unit 4 circ.)	No	No	Manual	No	Only indication	AL19	AL19	123
Thermal indoor fan and/or air flow switch	Yes	Yes	Manual	0 s (thermal relay) 30 s (flow switch)	Serious alarm, unit shutdown	AL20	AL20	40
Outdoor circuit coil probe 1 (air-air unit)	No	Yes	Manual	No	Shutdown circuit 1	AL21	AL21	41
Outdoor circuit coil probe 2 (air-air unit)	No	Yes	Manual	No	Shutdown circuit 2	AL22	AL22	42
Outdoor circuit coil probe 3 (air-air unit)	No	Yes	Manual	No	Shutdown circuit 3	AL21a	AL2101	157
Outdoor circuit coil probe 4 (air-air unit)	No	Yes	Manual	No	Shutdown circuit 4	AL22a	AL2201	158
Indoor circuit coil probe 1	No	Yes	Auto	No	Shutdown circuit 1	AL21b	AL2102	212
Indoor circuit coil probe 2	No	Yes	Auto	No	Shutdown circuit 2	AL21c	AL2103	213
Indoor circuit coil probe 3	No	Yes	Auto	No	Shutdown circuit 3	AL22b	AL2202	214
Indoor circuit coil probe 4	No	Yes	Auto	No	Shutdown circuit 4	AL22c	AL2203	215
Clogged filters	No	No	Manual	Yes 5 seconds	Only indication or unit shut-down (according to configuration of display CS08b)	AL23	AL23	43
Thermal electrical heaters stages 1 & 2	No	No	Auto (*)	No	Shutdown heater	AL24	AL24	48
Gas Burner	No	No	Manual	No	Only indication (safety in the burner)	AL24	AL24	48
Failure Eprom memory	No	No	Manual	No	Serious alarm, however only indication	AL26	AL26	32
Clock	No	No	Manual	No	Only indication	AL27	AL27	33
Unit maintenance	No	No	Manual	No	Only indication	AL28	AL28	108
Return temperature probe	Yes	Yes	Manual	No	Serious alarm, unit shutdown	AL29	AL29	109
Ambient humidity probe No.1	No	No	Manual	No	Only indication	AL30a	AL3001	165
RS485 probe No.1 without communication	No	No	Auto	No	Only indication	AL30b	AL3002	163
Ambient temperature probe No.1	No	No	Manual	No	Only indication	AL30c	AL3003	164
Ambient humidity probe No.2	No	No	Manual	No	Only indication	AL30d	AL3004	177
RS485 probe No.2 without communication	No	No	Auto	No	Only indication	AL30e	AL3005	175

(\*) It is possible to be defined as manual reset when a number of alarms take place in a period of time (consult CA04, CA05, CA06 and CA07).



Controlled alarms	Shutdown unit	Shutdown affected circ.	Type of reset	Timing	Actuation	Display	TCO	Addr.
Ambient temperature probe No.2	No	No	Manual	No	Only indication	AL30f	AL3006	176
pLAN network probe: T, RH or CO <sub>2</sub> without communication	No	No	Manual	No	Only indication	AL31	AL31	110
Outdoor temperature probe	No	No	Manual	No	Only indication	AL32	AL32	111
Indoor humidity probe	No	No	Manual	No	Only indication	AL33	AL33	112
Outdoor humidity probe	No	No	Manual	No	Only indication	AL34	AL34	113
Outlet temperature probe	No	No	Manual	No	Only indication	AL35	AL35	114
Mixing temperature or air quality probe	No	No	Manual	No	Only indication	AL35a	AL3501	130
COOLING setpoint < HEATING setpoint	Yes	Yes	Manual	No	Serious alarm, unit shut-down	AL36	AL36	115
Compressor(s) discharge T circuit 1	No	Yes	Auto	No	Shutdown circuit 1	AL37	AL37	126
Compressor(s) discharge T circuit 2	No	Yes	Auto	No	Shutdown circuit 2	AL38	AL38	127
Compressor discharge T circuit 3	No	Yes	Auto	No	Shutdown circuit 3	AL37a	AL3701	159
Compressor discharge T circuit 4	No	Yes	Auto	No	Shutdown circuit 4	AL38a	AL3801	160
Anti-fire safety device / smoke detection	Yes	Yes	Manual	No	Serious alarm, shut-down of the unit and open / closed of the outdoor damper (according to configuration of display CS01)	AL39	AL39	136
Outlet temperature limit exceeded	No	No	Manual	No	Shutdown electrical heaters or burner	AL40	AL40	166
Refrigerant anti-freeze safety circuit 1 (water-air)	No	Yes	Auto (**)	Yes (120 sec.)	HEATING mode: Shutdown circuit 1	AL41	AL41	193
Refrigerant anti-freeze safety circuit 2 (water-air)	No	Yes	Auto (**)	Yes (120 sec.)	HEATING mode: Shutdown circuit 2	AL42	AL42	194
Refrigerant anti-freeze safety circuit 3 (water-air)	No	Yes	Auto (**)	Yes (120 sec.)	HEATING mode: Shutdown circuit 3	AL41a	AL4101	195
Refrigerant anti-freeze safety circuit 4 (water-air)	No	Yes	Auto (**)	Yes (120 sec.)	HEATING mode: Shutdown circuit 4	AL42a	AL4201	196
Unit blocking due to anti-freeze alarm (water-air)	Yes	Yes	Manual	No	HEATING mode: unit shutdown	AL43	AL43	197
Water flow switch alarm (water-air)	Yes	Yes	Auto	Yes (30 sec)	HEATING mode: unit shutdown	AL44	AL44	199
Expansion card I/O pCOe No.1 without communication	No	Yes	Auto	No	Shutdown circuits 3 - 4	AL45a	AL4501	162
Expansion card I/O pCOe No.1 fault alarm	No	No	Auto	No	Shutdown circuits 3 - 4	AL45f	AL4506	161
Expansion card I/O pCOe No.2 without communication	No	Yes	Auto	No	Shutdown of evaporation / condensation pressures control	AL45b	AL4502	211
Expansion card I/O pCOe No.2 fault alarm	No	No	Auto	No	Shutdown of evaporation / condensation pressures control	AL45g	AL4507	210
Expansion card I/O pCOe No.3 without communication	No	Yes	Auto	No	Unit shutdown and dampers on the previous position to the alarm	AL45c	AL4503	---
Expansion card I/O pCOe No.3 fault alarm	No	No	Auto	No	Unit shutdown and dampers on the previous position to the alarm	AL45h	AL4508	---
Energy meter without communication	No	No	Auto	No	Only indication	AL46	AL46	192
Supply plug-fan without communication	No	No	Auto	No	Only indication	AL47	AL47	201
Pressure sensor for air flow control (supply plug-fan)	No	No	Auto	No	Only indication	AL48	AL48	202
Return plug-fan without communication	No	No	Auto	No	Only indication	AL49	AL49	205
Pressure sensor for air flow control (return plug-fan)	No	No	Auto	No	Only indication	AL50	AL50	206
Leak detector sensor	Yes	Yes	Manual	Yes (60 sec)	Unit shutdown	AL51a	AL5101	83
Gas leak detected	Yes	Yes	Manual	Yes (60 sec)	Unit shutdown	AL51b	AL5102	82
Leak detector without communication	Yes	Yes	Manual	Yes (30 sec)	Unit shutdown	AL51c	AL5103	81
Variable frequency drive (VFD) of supply fan without communication	Yes	Yes	Manual	No	Unit shutdown	AL61	AL61	51
Variable frequency drive (VFD) of return fan without communication	Yes	Yes	Manual	No	Unit shutdown	AL62	AL62	97
TCO terminal without communication	No	No	Auto	No	Only indication	---	AL6301	---
TCO with failure in the internal temperature sensor	No	No	Auto	No	Only indication	---	AL6302	---
Water inlet T probe on the hot water coil (expansion card I/O pCOe No.2)	No	No	Auto	No	Only indication	AL64	AL64	221
Anti-freeze alarm on the hot water coil (expansion card I/O pCOe No.2)	Yes (in COOLING)	Yes (in COOLING)	Auto	No	The pump is activated and the hot water coil valve open to 100%	AL65	AL64	222
Water outlet T probe on the hot water coil (expansion card I/O pCOe No.2)	Yes (in COOLING)	Yes (in COOLING)	Manual	No	Serious alarm, the pump is activated and the hot water coil valve open to 100%	AL66	AL65	223
Ambient temperature probe NTC	No	No	Auto	No	Only indication	AL67	AL66	224
Probe of recovery temp. on the wheel	No	No	Auto	No	Shutdown of the rotary recovery	AL69	AL69	---
Failure in the supply damper (expansion card I/O pCOe No.3)	Yes	Yes	Auto	Yes (150 sec)	Shutdown of the unit	AL70	AL70	---
Failure in the return damper (expansion card I/O pCOe No.3)	Yes	Yes	Auto	Yes (150 sec)	Shutdown of the unit	AL71	AL71	---

(\*\*) If 10 alarms are triggered in less than 24 hours the water-air unit is blocked by the anti-freeze alarm (manual reset).

## 20. SENSORS

### 20.1. Selection of the sensor type

The type of sensors for the outdoor coils (or anti-freeze safety in water-air units), such as pressure (0/5V) or temperature (NTC), can be selected in the CU12 display.

The type of humidity active probe types (optional) can be selected in the A07a display: 4-20 mA or 0/1V. By default, the humidity probes will be set at 4-20 mA to prevent measuring without voltage from taking place in an open circuit.

On the same display, the type of probe used for measuring the outlet air temperature can be used: NTC, as well as air quality (optional): 0/10Vdc.

Parameters used	
Selection of the type of humidity probe (optional)	A07a

### 20.2. Sensor configuration

A scale is assigned (start of scale - end of scale) on the A07c, A07d and A07e displays related to the maximum and minimum calibration values of the active air quality, humidity and pressure probes for the outdoor coils (or anti-freeze safety in water-air units).

Parameters used	
Configuration of the air quality probe (optional)	A07c
Configuration of the humidity probes (optional)	A07d
Configuration of the pressure transducers in outdoor unit	A07e

### 20.3. Calibration

The calibration of the probe is carried out by giving a value for each probe to the corresponding parameters of displays A04, A04a, A04b, A05, A05a, A05b, A06 and A07.

The value given to the parameter is added to the value read by the probe. This modified value will be the one to appear on the displays and is considered in all the control processes.

Parameters used	
Calibration of the return air temperature probe	A04
Calibration of the outdoor air temperature probe	A04
Calibration of the ambient air temperature probe	A04a
Calibration of the air temp. probe in TCO terminal (optional)	A04b
Calibration of the outlet air probe	A05
Calibration of the mixing air probe	A05
Calibration of the air quality probe (optional)	A05a
Calibration of the input / output T probes with HWC (optional)	A05b
Calibration of the outdoor unit sensors circuit 1 and circuit 2	A06
Calibration of the indoor and outdoor humidity probes (optional)	A07

### 20.4. Probe filters

The probe filter is used to eliminate readings of incorrect values produced by a high electromagnetic noise level.

If this function is authorised, before accepting the probe reading value

as valid, the following is verified:

- The difference between the value of the current and previous reading. If it is less than the differential set, the reading is considered as accepted.
- If the reading carried out is not accepted, the value of the previous reading is kept thus momentarily blocking the reading.
- The blocking is removed when an accepted reading is carried out or when the established blocking time has elapsed.

Parameters used	
Authorisation probe filter, blocking time and reading differential	A07h
Authorisation ambient probe filter (field-bus), blocking time and reading differential	A07i

## 21. MAINTENANCE

### 21.1. Time counter setting

The control has the total hours of operation of the unit for each of the compressors (including the recovery option), the indoor fan, free-cooling and optional support items. These values are stored in the permanent memory (EPROM) and can be seen on the MAINTENANCE menu displays.

When the number of hours of operation reach the value of the setpoint, the corresponding alarm is activated. These alarms are only by way of indication and, in order to reset, it is necessary to access the counter reset of the corresponding display:

Parameters used	
Unit and reset operating hours counter	A01
Operating hours counter of: indoor fan, rotary recuperator, electrical heaters or burner (without reset), water coil, free-cooling	A01a
Operating hours counter compressors and reset	A02, A02a, A03, A03a, A03b
Number of start-ups of the previous elements	A03c, A03d
Minimum ON and OFF times of every compressor	A01b

### 21.2. Input / output test

During maintenance operations, the input/output test allows rapid verification of the status of the input and output signals. In order to carry out this control, the unit must be stopped.

- The A08 and A08a displays allow the inputs to be displayed as read by the control without calibration or conversion.
- The A09, A09a, A09b displays enable verification of the operation of the corresponding digital outputs by manual activation of the output relays.
- The A10 display enables verification of the operation of the analogue outputs by acting on the opening percentage.

Parameters used	
Status of analogue inputs on: µPC MEDIUM board, expansion modules pCOe (opt.) and ambient probe (opt.)	A08, A08a, A08b
Status test of the digital outputs (ON/OFF)	A09, A09a, A09b
Status test of the digital outputs (0/10V)	A10

## 22. DESCRIPTION OF GENERAL INFORMATION DISPLAYS

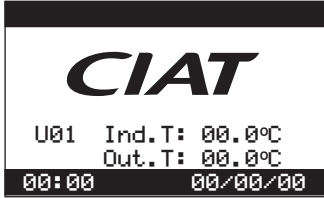



When the pGD1 terminal switches on, the display below appears:

**U01:** This indicates the number of the unit in which the terminal is connected.

**Ind. T:** This indicates the ambient (by default) or return (optional) air temperature.

**Out. T:** Outdoor air temperature. In units with humidity probe, this indicates the relative humidity of the indoor air.

By pressing the  key, access is given to a group of displays featuring the fundamental parameters held by the control. To move from one display to another use the keys  .

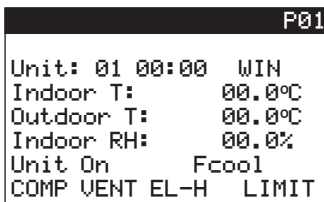

**Unit:** This represents the unit number (by default: 01). If the unit is included in a local pLAN, this number could vary between 1 and 15.

**00:00** Indicates the time.

**WIN / SUM / AL:** This indicates the operating status: WINTER or SUMMER. In the event of alarm, the indication "AL" will appear alternately.

**Indoor T:** This indicates the ambient (by default) or return (optional) air temperature.

**Outdoor T:** This indicates the outdoor air temperature.

**Indoor RH:** This indicates the relative humidity of the indoor air (in units with return or ambient humidity probe, optional).

**Unit:** This indicates the OFF/ON status:

**On** Turned on.

**Off** Turned off.

**Remote Off** If enabled for a remote shutdown.

**Off by Phase** If the unit is shut down by schedule programming.

**Machine status:** Available options status:

**Fcool** Active free-cooling.

**COMP** Active compressors in summer in addition to free-cooling.

**Deum** Dehumidification.

**Gas** Gas burner operating above the minimum.

**COMP VENT EL-H:** The meaning of these texts on the display is: compressor (COMP), supply fan (VENT) and electrical heaters (RES) in operation.

**LIMIT:** This text appears intermittently when the control of the outlet temperature is activated, limiting the capacity of the unit.

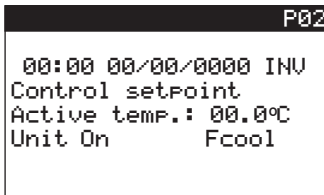

**00:00** and **00/00/0000** This indicates the time and date.

**WIN / SUM / AL:** Operating mode.

**Active temp.:** Setpoint temperature.

**Unit:** This indicates the OFF/ON status.

**Machine status:** Available options status (e.g. Fcool).

**LIMIT:** when the control of the outlet temperature is activated.

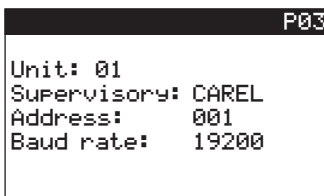

This display will only appear in the event that there is a pLAN network or a supervision network (Carel, Modbus or Lonwork protocols).

**Unit:** Unit No. in the pLAN network.

**Supervisory:** Type of protocol.

**Address:** in the supervision network. This could be different from the board address.

**Baud rate:** Bit rate (19200, 9600, 4800, 2400, 1200).

### 23. DESCRIPTION OF HELP DISPLAYS

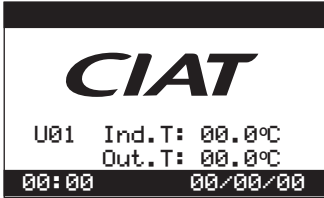

From this display, by pressing the keys for a few seconds, access is given to a group of help displays with information on the terminal key or key combination that enables carrying out the most important control functions.

To move from one display to another, use the keys .

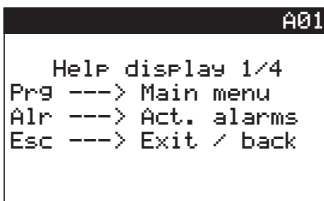

This allows the MAIN MENU display to be accessed in order to select the operating mode, setpoints, off/on, inputs/outputs and schedule programming.

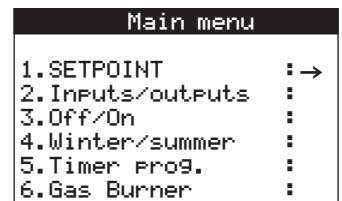

If the key is illuminated in red, the active alarms can be displayed by pressing it.

To exit any display, pressing this key returns the user to the start display of the previous menu.



By pressing both these keys at the same time for a few seconds, the unit off/on procedure is initiated.

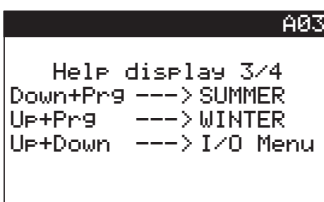

The selection of the COOLING operating mode is carried out by pressing these keys at the same time for a few seconds.

The selection of the HEATING operating mode is carried out by pressing these keys at the same time for a few seconds.

By pressing both keys at the same time, direct access is gained to the group of input/output (I/O) displays from the MAIN MENU.

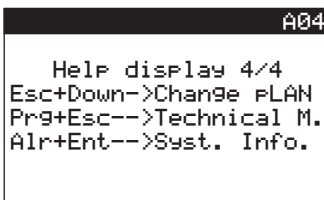

When the unit is included into a fully configured pLAN, the rest of the network units can be supervised by pressing these keys from the common control. For more information, consult the control communications brochure.

By pressing both keys at the same time for a few seconds, access is gained to the TECHNICAL MENU displays for parametrisation and maintenance of the unit. This menu is protected by an access password. If the password has to be known: please consult.



By pressing both keys at the same time, access is gained to the system information display.

## 24. DESCRIPTION OF MAIN MENU DISPLAYS

```

Main menu
1.SETPOINT      :->
2.Inputs/outputs :
3.Off/On        :
4.Winter/summer :
5.Timer prog.   :
6.Gas Burner    :
    
```

By pressing the  key, access is given to this display:

### 24.1. SETPOINT displays

This option provides us with access to the temperature and relative humidity (optional) setpoint values (if these have not be set in the schedule programming).

```

S01
Temp. control
setpoint (by sched.)
Summer      26.0°C
Winter     21.0°C
    
```

**Temperature control setpoint:** on this display it is possible to modify the setpoints in COOLING mode (summer) and HETATING mode (winter).

Note: if the indication appears on the display (by schedule) this means that the setpoints have been set in the timer programming.

```

S02
Humidity control
setpoint
           55.0%
    
```

**Humidity control setpoint:** on this display it is possible to modify the humidity setpoint when its management is enabled (optional).

```

S03
Setpoint calculat.
PS26.0 PW21.0 P21.0
RS00.0 RW00.0 R00.0
US16.0 UW11.0 U11.0
    
```

This display allows the following setpoint calculations to be displayed:

- PS In COOLING mode (summer): Setpoint + Dead Zone / 2
- PW In HEATING mode (winter): Setpoint + Dead Zone / 2
- P Current selection of the setpoint
- RS Setpoint of the electrical heaters in COOLING mode
- RW Setpoint of the electrical heaters in HEATING mode
- R Current selection of the setpoint for the electrical heaters
- US Setpoint of the hot water auxiliary coil in COOLING mode
- UW Setpoint of the hot water auxiliary coil in HEATING mode
- U Current selection of the setpoint for the auxiliary coil

```

S04
Setpoint calculation
outlet limit
SET COOL.: 07.0°C
SET HEAT.: 45.0°C
    
```

**Outlet limit setpoints calculation:** on this display it is possible to display the setpoints for the outlet temperature in COOLING mode (summer) and HEATING mode (winter).



Note: To exit this group of displays, press  and the start display from the MAIN MENU will appear.

## 24.2. INPUT/OUTPUT displays

```

Main menu
1.Setpoint      :
2.INPUTS/OUTPUTS : →
3.Off/On       :
4.Winter/summer :
5.Timer prog.  :
6.Gas Burner   :
    
```

In this group of displays, all the variables controlled by the system are featured, which includes the status of the digital inputs, digital outputs and analogue outputs.



By pressing the keys  , each of the displays can be seen.

```

I01
Return temperature
Probe      16.0°C
Outdoor temperature
Probe      20.0°C
    
```

Return air temperature probe: this indicates the measurement of the return air probe.

Outdoor temperature probe: this indicates the measurement of the outdoor air probe.

Note: Pressing the   keys for a few seconds whilst on any display of the program allows access to this display.

```

I01a
Ambient temperature
Probe      27.0°C
Probe no.1 : 28.0°C
Probe no.2 : 26.0°C
Probe no.3 : 27.5°C
Probe no.4 : 26.5°C
HEAT:AVERAG COLD:AVERA
    
```

Ambient temperature probe: this indicates the measurement of the ambient probe: NTC (standard), 4-20mA (optional) or RS485 (optional). If the unit incorporates more than one RS485 ambient probe, this parameter shows the instantaneous value calculated for the current operating mode.

Probe no.1 / no.2 / no.3 / no.4: If the unit incorporates more than one RS485 ambient probe, the display shows the measurement of all probes.

HEAT and COLD: If the unit incorporates more than one RS485 ambient, in HEATING mode and COOLING mode, the control will use the measured value: MINIMUM, MAXIMUM or AVERAGE.

```

I01b
TCO thermostat
temperat. probe 27.0°C
    
```

TCO thermostat temperature probe: this indicates the measurement of this probe, if the TCO thermostat has been activated on the CU12b display (optional).

```

I02
Indoor humidity
Probe      40.0%
Probe no.1 : 39.0%
Probe no.2 : 41.0%
Probe no.3 : 40.0%
Probe no.4 : 40.0%
    
```

This display can be shown if the unit has a probe to measure the value of the ambient air humidity (optional). If the unit incorporates more than one probe, the display shows the measurement of all probes and the average value.

```

I02a
Outdoor humidity
Probe      50.0%
    
```

This display can be shown if the unit has a probe to measure the value of the outdoor air humidity (optional).

```

I03
Outlet temperature
Probe      39.8°C
Mixed temperature
Probe      08.8°C
    
```

Outlet temperature probe: the value measured by this probe is displayed.

Mixed air temperature probe: the value measured by this probe is displayed.



I03a

```
Air quality
Probe      050.2%

zone 1: 00000 PPM
zone 2: 00000 PPM
```

**Air quality Probe:** the value displayed for this probe is displayed (optional).

In the case of "zoning into 2 areas" will display the value measured by the probe of air quality in each area.

I03b

```
HWC inlet water
temp. Probe 00.0°C
HWC outlet water
temp. Probe 00.0°C
```

This display can be displayed if the unit includes the GREAT COLD option (expansion card pCOe No.2 (address 8)).

**HWC inlet water temp. Probe:** this indicates the water temperature measured by the hot water coil inlet probe (HWC).

**HWC outlet water temp. Probe:** this indicates the water temperature measured by the hot water coil outlet probe (HWC).

I03c

```
WHEEL extraction air
temp. Probe 00.0°C
WHEEL recovery air
temp. Probe 00.0°C
```

This display can be displayed if the unit includes rotary recovery with variable wheel.

**WHEEL extraction air temp. Probe:** this indicates the value measured by the extraction probe.

**WHEEL recovery air temp. Probe:** this indicates the value measured by the recovery probe.

I04a

```
Outdoor unit Probe C1
12.0 bar  15.9°C
Outdoor unit Probe C2
12.0 bar  15.9°C
```

**Outdoor unit Probe C1:** this indicates the pressure value measured by the outdoor coil sensor for circuit 1.

**Outdoor unit Probe C2:** this indicates the pressure value measured by the outdoor coil sensor for circuit 2.

Note: in water-air units, this display indicates the value of refrigerant anti-freeze safety for each circuit.

I04b

```
Outdoor unit Probe C3
12.0 bar  15.9°C
Outdoor unit Probe C4
12.0 bar  15.9°C
```

**Outdoor unit Probe C3:** this indicates the pressure value measured by the outdoor coil sensor for circuit 3.

**Outdoor unit Probe C4:** this indicates the pressure value measured by the outdoor coil sensor for circuit 4.

Note: in water-air units, this display indicates the value of refrigerant anti-freeze safety for each circuit.

I04c

```
Outdoor unit Probe C1
15.9°C
Outdoor unit Probe C2
15.9°C
```

**Outdoor unit Probe C1:** this indicates the temperature value measured by the outdoor coil probe for circuit 1.

**Outdoor unit Probe C2:** this indicates the temperature value measured by the outdoor coil probe for circuit 2.

Note: in water-air units, this display indicates the value of refrigerant anti-freeze safety for each circuit.

I04d

```
Outdoor unit Probe C3
12.9°C
Outdoor unit Probe C4
12.9°C
```

**Outdoor unit Probe C3:** this indicates the temperature value measured by the outdoor coil probe for circuit 3.

**Outdoor unit Probe C4:** this indicates the temperature value measured by the outdoor coil probe for circuit 4.

Note: in water-air units, this display indicates the value of refrigerant anti-freeze safety for each circuit.

I05a

```
Indoor unit Probe C1
12.0 bar  15.9°C
Indoor unit Probe C2
12.0 bar  15.9°C
```

**Indoor unit Probe C1:** this indicates the pressure value measured by the indoor coil sensor for circuit 1.

**Indoor unit Probe C2:** this indicates the pressure value measured by the indoor coil sensor for circuit 2.

Note: these sensors are connected on the expansion card pCOe No.2 (address 8).

I05b

```
Indoor unit probe C3
12.0 bar  15.9°C
Indoor unit probe C4
12.0 bar  15.9°C
```

Indoor unit probe C3: this indicates the pressure value measured by the indoor coil sensor for circuit 3.

Indoor unit probe C4: this indicates the pressure value measured by the indoor coil sensor for circuit 4.

Note: these sensors are connected on the expansion card pCOe No.2 (address 8).

I05c

```
Indoor unit probe C1
15.9°C
Indoor unit probe C2
15.9°C
```

Indoor unit probe C1: this indicates the temperature value measured by the indoor coil probe for circuit 1.

Indoor unit probe C2: this indicates the temperature value measured by the indoor coil probe for circuit 2.

Note: these sensors are connected on the expansion card pCOe No.2 (address 8).

I05d

```
Indoor unit probe C3
12.9°C
Indoor unit probe C4
12.9°C
```

Indoor unit probe C3: this indicates the temperature value measured by the indoor coil probe for circuit 3.

Indoor unit probe C4: this indicates the temperature value measured by the indoor coil probe for circuit 4.

Note: these sensors are connected on the expansion card pCOe No.2 (address 8).

I05

```
Outdoor enthalpy
value  00.000 kc/kg
Outdoor humidity
value  00.0%
```

This display can be displayed if there is enthalpic free-cooling.

Outdoor enthalpy value: this indicates the enthalpy value of the outdoor air.

Outdoor humidity value: this indicates the outdoor value of the air humidity.

I06

```
Indoor enthalpy
value  00.000 kc/kg
Indoor humidity
value  00.0%
```

This display can be displayed if there is enthalpic free-cooling.

Indoor enthalpy value: this displays the enthalpy value of the ambient (or return) air.

Indoor humidity value: this displays the humidity value of the ambient (or return) air.

I07

```
Operating hours
Unit: 00000
Compress. 1-C1: 00000
Compress. 2-C1: 00000
```

The indicates the total operating hours for:

Unit: total hours for the unit.

Compress. 1-C1: Operating hours of compressor 1 circuit 1.

Compress. 2-C1: Operating hours of compressor 2 circuit 1 (units 2 circ.) or compressor2 (units 4 circ.).

Note: the configuration of the circuits and the number of compressors in each circuit is selected from the CU02 display.

I07a

```
Operating hours
Compress. 1-C2: 00000
Compress. 2-C2: 00000
Recovery comp.: 00000
```

The indicates the total operating hours for:

Compress. 1-C2: Operating hours of compressor 1 circuit 2 (units 2 circ.) or compressor 3 (units 4 circ.).

Compress. 2-C2: Operating hours of compressor 2 circuit 2 (units 2 circ.) or compressor 4 (units 4 circ.).

It also indicates the operating hours of the active recovery circuit compressor.

```

I08
Digital input
status (1...14):
CCCCCCCCCCCCCCC
    
```

This indicates the status of the digital inputs (failure indication). The inputs correspond to:

- 1: indoor fan protection and air flow control (optional)
- 2: smoke detector (optional)
- 3: high pressure pressostat circuit 1
- 4: compressor and outdoor fan protection device circuit 1
- 5: safety thermistor for the electrical heater / gas burner alarm signal (optionals for air-air units) or water flow switch (optional for water-air units)
- 6: clogged filter control (optional)
- 7: remote off / on
- 8: remote cooling / heating
- 9: high pressure pressostat circuit 2
- 10: compressor and outdoor fan protection device circuit 2
- 11: low pressure pressostat circuit 1
- 12: low pressure pressostat circuit 2
- 13: anti-freeze safety for hot water coil
- 14: recovery circuit safety device (optional)

Note: C: Closed contact / O: Open contact

```

I08a
EXPANSION MOD. PCOE-7
Digital input
status (1...6):
CCCCCC
    
```

This indicates the status of the digital inputs on the expansion module pCOe No.1 (address 7) for **units with 4 circuits** (failure indication). The inputs correspond to:

- 1: low pressure pressostat circuit 3
- 2: compressor and outdoor fan protection device circuit 3
- 3: low pressure pressostat circuit 4
- 4: compressor and outdoor fan protection device circuit 4
- 5: high pressure pressostat circuit 3
- 6: high pressure pressostat circuit 4

Note: C: Closed contact / O: Open contact

```

I08b
EXPANSION MOD. PCOE-8
Digital input
status (1...4):
CCCC
    
```

This indicates the status of the digital inputs on the expansion module pCOe No.2 (address 8) for **condensation / evaporation control of the indoor unit** (failure indication). The inputs correspond to:

- 1: disconnection of 1 compressor stage
- 2: disconnection of 2 compressor stages
- 3: disconnection of 4 compressor stages
- 4: disconnection of electrical heaters

Note: C: Closed contact / O: Open contact

```

I08c
EXPANSION MOD. PCOE-9
Digital input
status (1...4):
CCCC
    
```

This indicates the status of the digital inputs on the expansion module pCOe No.3 (address 9) for **zoning into 2 areas** (failure indication). The inputs correspond to:

- 1: opening of the damper of supply of the area 1
- 2: opening of the damper of supply of the area 2
- 3: opening of the damper of return of the area 1
- 4: opening of the damper of return of the area 2

Note: C: Closed contact / O: Open contact

```

I09
Compressor 1-C1 OFF
Compressor 2-C1 OFF
Compressor 1-C2 OFF
Compressor 2-C2 OFF
    
```

This indicates the off / on status of each compressor. This display shows the configuration with 4 compressors - 2 circuits (4 compressors in tandem)

Instead of Compressor 2 - C1 and C2, the display will show *Parcializacion C-1 and C-2* when "2 compressors and 1 partialisation" is configured on the CU02 display.

I109a	
Elec.heater 1	OFF
Elec.heater 2	OFF

This indicates the status of the electrical heater option (if the unit has it).

**Elec.heater 1:** status of the 1st electrical heater stage.

**Elec.heater 2:** status of the 2nd electrical heater stage.

I110	
Cycle rev.valv.1	OFF
Cycle rev.valv.2	OFF
Outd.fan 1	OFF
Outd.fan 2	OFF

**Cycle rev.valv.1:** this indicates the status of the cycle reversing valve for circuit 1.

**Cycle rev.valv.2:** this indicates the status of the cycle reversing valve for circuit 2.

**Outd.fan 1:** status of the outdoor air fan for circuit 1 (air-air units 2 circuits) or for circuits 1 - 2 (air-air units 4 circuits).

**Outd.fan 2:** status of the outdoor air fan for circuit 2 (air-air units 2 circuits) or for circuits 3 - 4 (air-air units 4 circuits).

I110a	
Cycle rev.valv.3	OFF
Cycle rev.valv.4	OFF
Outd.fan 3-4	low
Outd.fan 3-4	high

**Cycle rev.valv.3:** this indicates the status of the cycle reversing valve for circuit 3 (units 4 circuits).

**Cycle rev.valv.4:** this indicates the status of the cycle reversing valve for circuit 4 (units 4 circuits).

**Outd.fan 3-4:** status of the outdoor air fan for circuits 3 and 4 (air-air units 4 circuits). In the case of 2-speed fans it informs on the instantaneous operating speed.

I110b	
MOD. EXPANSION PCOE-9	
Digital outputs	
status (1..4) :	
OFF	OFF
OFF	OFF

This indicates the status of the digital outputs on the expansion module pCOe No.3 (address 9) for **zoning into 2 areas**. The outputs correspond respectively to signals of :

- supply damper of the area 1 open,
- supply damper of the area 2 open,
- return damper of the area 1 open,
- return damper of the area 2 open.

I111	
Indoor fan	OFF
Recovery comp.	OFF

**Indoor fan:** status of the indoor air circuit fan.

This display also displays the status of output NO7 where one of the following options can be connected: on-off humidifier, recovery circuit compressor or circuit circulation pump for the hot water auxiliary coil.

I112	
Outdoor damper:	025%
■ ■ ■ ■ ■	
Heat valve	000%

**Outdoor damper:** this provides information on the opening percentage of the outdoor air damper (optional). The range varies from 0% (0V) to 100% (10V).

This display also displays the opening percentage of output Y2 (0-10V) where the following can be connected: hot water coil, proportional electrical heater or gas burner.

I112a	
Outdoor fan 1:	000%
Outdoor fan 2:	000%

**Outdoor fan 1:** % of operation of the outdoor air electronic fans for circuit 1 (units 2 circuits) or circuits 1 - 2 (units 4 circuits) (connected at analogue output Y3 of connector J5).

**Outdoor fan 2:** % of operation of the outdoor air electronic fans for circuit 2 (units 2 circuits) or circuits 3 - 4 (units 4 circuits) (connected at analogue output Y4 of connector J5).

I112b	
Ind. u. control:	100%

**Ind. u. control:** % of opening of the damper for condensation / evaporation pressure control of the indoor unit (connected at analogue output Y1 on the expansion module pCOe No.2).

```

I12c
Rotary recuper.: 100%
    
```

**Rotary recuper.:** This display indicates the status of the digital output for control of the wheel speed (variable rotary recovery).

```

I13
PLAN ROOF-TOP  N:XX
I/O 1.8  ██████████
I/O 9.16  ██████████
    
```

This display displays the number of  $\mu$ PC MEDIUM boards that are connected on the pLAN, as well as the position they occupy. Number 16 is reserved for the common terminal.

**N:XX** Identification number of the unit from which the connection is being performed.

```

I14
PLAN ROOF-TOP  N:XX
I/O 17.24 ██████████
I/O 25.32 ██████████
    
```

This display displays the number of private pGD1 terminals that are connected on the pLAN, as well as the position they occupy. The address of each terminal must coincide with the board to which it is associated +16.

Note: for a more detailed description of the pLAN network please consult the control communications brochure.

```

GAVAZZI I15
Voltages (V)
L1-L2: 00000
L2-L3: 00000
L3-L1: 00000
Neutral 1: 00000
Neutral 2: 00000
Neutral 3: 00000
    
```

This display appears if a energy meter has been connected on the Field-bus of the  $\mu$ PC MEDIUM board. This indicates the measures of the voltages between phases (L1-L2, L2-L3, L3-L1), as well as the measures between phase and neutral (Neutral 1, 2 and 3).

```

GAVAZZI I16
Current (A)
Line 1: 0000.0
Line 2: 0000.0
Line 3: 0000.0

Power factor: 0.00
Frequency: 00.0
    
```

This display appears if a energy meter has been connected on the Field-bus of the  $\mu$ PC MEDIUM board. This indicates the measures of phase current, power factor and frequency.

```

GAVAZZI I17
Reactive power (kVAr)
Phase 1: 0000.0
Phase 2: 0000.0
Phase 3: 0000.0
Total: 0000.0
Reactive energy eq.:
00000 kVArh
    
```

This display appears if a energy meter has been connected on the Field-bus of the  $\mu$ PC MEDIUM board. This indicates the measures of phase reactive power and equivalent reactive energy, as well as the total reactive energy.

```

GAVAZZI I18
Power (kW)
Phase 1: 0000.0
Phase 2: 0000.0
Phase 3: 0000.0
Total: 0000.0
Enegy: 00000 kWh
Hours: 00000 h
    
```

This display appears if a energy meter has been connected on the Field-bus of the  $\mu$ PC MEDIUM board. This indicates the measures of phase power, total power, energy and operating hours.

```

I18a
Gas detector n°001
Concentration
020% 00200PPM

LED Red: O Green: ●
RELAYS Off
    
```

This display reports on the refrigerant leak detector (optional):

- **Concentration:** expressed as a % and ppm.
- **Led:** If the green led is illuminated no leak has been detected..
- **Relays:** indicates the status of a relay which incorporates the detector (unused).

```

Cooling power: I18b
Input enthalpy
value: 00.0 kcal/kg
Input humidity
value: 50.0 %
Input temperature
value: 000.0 °C
    
```

This display can be displayed if there are RS485 mixing and discharge enthalpic probes (CU13 display) for calculation of the cooling and heating capacities (according to the current operation mode).

It shows the values measured by the mixing probe (placed before the indoor coil).

```

Cooling power: I18c
Output enthalpy
value: 00.0 kcal/kg
Output humidity
value: 00.0 %
Output temperature
value: 000.0 °C
    
```

This display can be displayed if there are RS485 mixing and outlet enthalpic probes (CU13 display) for calculation of the cooling and heating capacities (according to the current operation mode).

It shows the values measured by the discharge probe (placed after the indoor coil).

```

Cooling power: I18d
outl. flow: 12000m3/h
ent.dif.: 00.0 kcal/kg
air density: 000009/m3

Total power: 0000.0 kW
    
```

This display can be displayed if there are RS485 mixing and outlet enthalpic probes (CU13 display) for calculation of the cooling and heating capacities (according to the current operation mode).

It shows the supply flow, the difference of enthalpy between input and output, the air density and the total capacity obtained from these values.

Note: in units with centrifugal fan + variable frequency drive, the supply flow will be introduced on this display.

```

Cooling power: I18e
EER calculat.: 00.0
-valid conditions-
COMP00% REN.00%

Tr:28.3°C Te:32.2°C
    
```

This display can be displayed if there is an energy meter, in addition to the enthalpic probes. It shows the value obtained from the calculation of EER (in COOLING mode) and COP (in HEATING mode).

The message `-valid conditions-` or `-check conditions-` will appear below reporting on the validity of the calculated value. For the message `-valid conditions-` it is necessary the operation of compressors to 100%, the outdoor air damper closed and the stages of support disconnected (electrical heaters, gas burner and hot water coil).

The display also shows:

- percentage of compressor stages (COMP).
- percentage of air renewal (REN) indicating if the recovery compressor is working (R.C.) or if the unit is doing free-cooling (FCOOL) or free-heating (FHEAT).
- percentage of electrical heaters (RES) or gas burner (GAS).
- percentage of hot water coil (3-WU).
- control temperature (Tr): ambient or return.
- outdoor temperature (Te).

```

UNIT CONFIG. I19
AIR-AIR rev. heat pump
1 Comp.
Double vol.
Elec.heaters
Refrigerant: R410A
WO No.: 13042422
    
```

This display reports on the selected configuration:

- Type of unit: air-air cooling only, air-air heat pump, water-air cooling only, water-air heat pump.
- Number of compressors and circuits.
- For 2 circuits units: single or double volume of outdoor air.
- Type of support in HEATING mode installed in the unit: electrical heaters, gas burner, heat valve (HWC).
- Type of unit refrigerant: R22, R134A, R404A, R407C, R410A.
- Work order number of the unit.

```



SOFTWARE I20
CIATRTC CONTROL
ROOFTOP_UJC_11_1A_EN

Ver.: 11.1 17/03/17

Bios: 6.40 17/11/15
Boot: 4.05 28/05/09
    
```

**This display provides information on the program installed in the microprocessor (in this case ROOF-TOP) and the version (v11.1).**

The software is installed in English (EN), by default, and in another language requested by the client. The languages available are: Spanish (SP), French (FR), Italian (IT), Turkish (TR) and German (GR).

The change between the two languages that are installed on the pGD1 terminal is done by simultaneously pressing the keys  + 

Also there are visualized the versions of BIOS and BOOT installed in the control.

HARDWARE	I21
Board type:	uPC
Board size:	medium
Total flash:	2048kB
RAM:	1024kB
Built-In type:	
Main cycle:	
50.5 cycle/s	0019ms

This display provides information on the hardware characteristics.



- Type and size of board.
- Size of flash and RAM memories.
- Control built-in type.
- Program cycle.

### 24.3. Unit OFF / ON displays

Main menu	
1. Setpoint	:
2. Inputs/outputs	:
3. OFF/ON	:→
4. Winter/summer	:
5. Timer prog.	:
6. Gas Burner	:

By pressing the  key, access is given to this display:

PM01	
Unit off / on	
by keyboard:	
ON	

This display is where the activation or shutdown of the unit is selected. These operations can be carried out by pressing the keys at the same time for a few seconds  .

Note: For the correct operation of the remote ON / OFF, the option ON must be selected on this display.

### 24.4. WINTER/SUMMER displays

Main menu	
1. Setpoint	:
2. Inputs/outputs	:
3. Off/On	:
4. WINTER/SUMMER	:→
5. Timer prog.	:
6. Gas Burner	:

By pressing the  key, access is given to this display:

FC01	
Winter/summer select.	
'automat.' +	
by out.T.	
WINTER	
SUM. if out.T > 22.0°C	
WIN. if out.T < 20.0°C	
Enable lock: N	

On this display it is visualized the switching mode selected to change the HEATING/COOLING operating mode.

- If the display shows "automat.", there are two possibilities:
  - «by out.T.» (by default) : The unit changes from operation in COOLING mode to HEATING mode or vice versa depending on the temperature measured by the outdoor air probe. In this case, the setpoints of outdoor temperature can be modified in COOLING mode (by default 22°C) or HEATING mode (by default 20°C).
  - «by in.T.» : The unit changes from operation in COOLING mode to HEATING mode or vice versa depending on the temperature measured by the ambient (or return) air probe and the active COOLING and HEATING setpoints (CU12a display).
- If the display shows "by keyboard" it is possible to modify the operating mode of the unit. Nevertheless, these operations can also be carried out using the following key combinations:

  : HEATING mode (winter)

  : COOLING mode (summer)

- If the display shows "only ventilation", this operating mode will be selected. It allows operation for only supply fan, return fan (optional) and free-cooling or free-heating (optional).



When «Enable lock» is selected (YES), this display is only for information, in order that the final user cannot change it. In this case it has been blocked from the A0 display of "Maintenance" (Technical menu).

## 24.5. SCHEDULE PROGRAMMING displays

```

Main menu
1.Setpoint      :
2.Inputs/outputs :
3.Off/On       :
4.Winter/summer :
5.TIMER PROG.  : →
6.Gas Burner   :
    
```

By pressing the  key, access is given to this display. In this group of displays, the time and date can be set, as well as a schedule programming for the start/stop of unit created.

By pressing the   keys, each of the following displays can be seen.

```

PH01
Clock setting
Time: 15:45
Date: 17/12/2007
Day: Monday
    
```

The time and date can be modified on this display. The day of the week will be automatically updated.

```

PH02
DST:          ENABLE
Transition time: 060min
Start: LAST SUNDAY
in MARZO      at 02.00
End:  LAST SUNDAY
in OCTOBER    at 02.00
    
```

On this display it is possible to activate the change of automatic schedule (by default).

In this way, , from LAST SUNDAY IN MARCH at 2.00 hours until LAST SUNDAY IN OCTOBER a at 3.00 hours, to the normal schedule (winter schedule) it is necessary to add 60 minutes, thus obtaining the summer schedule.

These values are adjustable to be adapted to different hourly changes out of the European Union.

```

PH03
START TYPE
3 setpoints schedule
+ OFF of unit
- ON for SET LIMITE -
Disab. comp. COOL: YES
Dis. air refresh.: YES
    
```

On this display, the start type and the condition of the unit outside of the schedule program will be selected:

**Manual:** by selecting this type of start the unit will be on or off without taking into account the schedule programming. In this case, the unit can be switched off/on from this display.

**Schedule only setpoint change:** the unit does not stop. Two setpoint temperatures will be established: one during the program slots and another outside the program.

**ON/OFF schedule:** the unit will stop outside the schedule program slots.

**ON/OFF schedule with ON limit SET:** outside the schedule program the unit is off, however a start safety device is established when the temperature goes above or below the limit setpoints entered. With this type of start-up two new parameters appear on the display:

**Disab.comp.COOL:** when the unit is working with the safety limit setpoint in COOLING mode the compressors can be disabled in order that if the conditions of the outdoor air are favorable, the unit realizes free-cooling.

**Dis.air refresh:** when the unit is working with the safety limit setpoint is disabled the air refreshing.

**3 setpoints schedule + OFF of unit:** outside the schedule program the unit is off, inside the schedule 3 setpoints can be established: CONFORT: standard setpoint, ECONOMY: setpoint more removed from the comfort point, used at times with low occupancy of the building and PROTECTION: setpoint of building protection, usually used at night, when the building is empty. With this type of start-up two new parameters appear on the display:

**Disab.comp.COOL:** when the unit is working with the PROTECTION setpoint in COOLING mode the compressors can be disabled in order that if the conditions of the outdoor air are favorable, the unit realizes free-cooling.

**Dis.air refresh:** when the unit is working with the PROTECTION setpoint is disabled the air refreshing.

**Forced:** this permits an occasional start-up or shutdown of the unit without modifying the set schedule program.

To activate it press the key  for a few seconds. Access is gained to a display on which the forced running time is established. When this period ends, the unit goes back to the start type that was programed.



```

PH04
-----
SCHEDULE PROGR. N.1
Slot1 > 06:30 to 11:00
Slot2 > 11:30 to 13:30
Slot3 > 15:00 to 19:00
    
```

On this display it is possible to set the time slots for program 1. The number of slots will be comprised between 1 (minimum) and 3 (maximum). Within the slots, the unit will be running with a fixed setpoint. Outside of the slots, the unit will work with a different setpoint from the previous one or shut down, according to the type of start selected on the previous PH03 display.

```

PH05
-----
SCHEDULE PROGR. N.2
Slot1 > 08:00 to 14:00
Slot2 > 17:00 to 20:30
Slot3 > 00:00 to 00:00
    
```

On this display, it is possible to set the time slots for program 2.

```

PH06
-----
SCHEDULE PROGR. N.3
Slot1 > 07:00 to 15:00
Slot2 > 00:00 to 00:00
Slot3 > 00:00 to 00:00
    
```

On this display, it is possible to set the time slots for program 3.

```

PH07
-----
Schedule with setpoint
change (summer)
Indoor set. 26.0°C
Outdoor set. 28.0°C
    
```

On this display, the setpoints for operation in COOLING mode (summer) are established.

**Indoor set.:** setpoint for the time slots.

**Outdoor set.:** setpoint outside the schedule when "Schedule only setpoint change" has been selected on the PH03 display.

```

PH08
-----
Schedule with setpoint
change (winter)
Indoor set. 21.0°C
Outdoor set. 19.0°C
    
```

On this display the setpoints for operation in HEATING mode (winter) are set.

**Indoor set.:** setpoint for the time slots.

**Outdoor set.:** setpoint outside the schedule when "Schedule only setpoint change" has been selected on the PH03 display.

```

PH09
-----
Schedule with ON
by limit SP (summ.)
Indoor set. 26.0°C
Limit set. 34.0°C
    
```

On this display, the setpoints for operation in COOLING mode (summer) are set when "Schedule ON-OFF with ON limit SET" has been selected on the PH03 display.

**Indoor set.:** setpoint for the time slots.

**Limit set.:** safety setpoint outside the schedule. The unit will remain shut down until the ambient (or return) air temperature rises to this value. With this setpoint, if it has been selected YES in the Disab.comp.COOL parameter on the PH03 display, the compressors can be disabled in order that if the conditions of the outdoor air are favorable, the unit realizes free-cooling.

```

PH10
-----
Schedule with ON
by limit SP (winter)
Indoor set. 21.0°C
Limit set. 13.0°C
    
```

On this display, the setpoints for operation in HEATING mode (winter) are established when "Schedule ON-OFF with ON limit SET" has been selected on the display PH03.

**Indoor set.:** setpoint for the time slots.

**Limit set.:** safety setpoint outside the schedule. The unit will remain shut down until the ambient (or return) air temperature drops to this value.

```

PH11
-----
Schedule with ON
by limit SP
Win.Lim. Diff. 01.0°C
Sum.Lim. Diff. 02.0°C
    
```

On this display the differentials are established for the limit set. when "Schedule ON-OFF with ON limit SET" has been selected.

**Win.Lim. Diff.:** differential for the limit setpoint in HEATING mode

**Sum.Lim. Diff.:** differential for the limit setpoint in COOLING mode

```

PH12
-----
Program selection
Daily start
M:1 T:1 W:1 T:1 F:2
S:3 S:0 -Mon- (0=off)
    
```

On this display, it is possible to assign a schedule program for each day of the week.

The options are: program No.1 (1), program No.2 (2), program No.3 (3) or no programming (0).

```

PH13
MON copy to TUE: YES
      23:00 a 23:30
00-08:-----
08-16:-----
16-24:-----
    
```

If it has been selected "3 setpoints schedule + OFF the unit " on the PH03 display, on this display there will be assigned, for every day of the week, every 30 minutes, which will be the select setpoint.

The symbol that represents each setpoint is: - OFF, = PROTECTION, ■ ECONOMY, ■ CONFORT.

In the top left zone of the display it is indicated the day of the week to which there is assigned the schedule (in the example: on Monday). When it is created it is possible to copy in any other day of the week. For example: it copies to Tuesday: YES (the Tuesday schedule will be the same that on Monday).

```

PH14
Schedule with setpoint
change (Summer)
CONFORT Set      26.0°C
ECONOMY Set     28.0°C
PROTECTION Set  34.0°C
PROT.Lim.Dif    02.0°C
    
```

On this display, the setpoints for operation in COOLING mode (summer) are established, when it has been selected "3 setpoints schedule + OFF the unit " on the PH03 display.

Set.CONFORT: standard setpoint of the unit.

Set.ECONOMY: setpoint more removed from the comfort point, used at times with low occupancy.

Set.PROTECTION: setpoint of building protection, usually used at night, when the building is empty. With this setpoint, if it has been selected YES in the Disab.comp.COOL parameter on the PH03 display, the compressors can be disabled in order that if the conditions of the outdoor air are favorable, the unit realizes free-cooling.

Dif.lim.PROT: differential for the PROTECTION setpoint. When the temperature drops below the setpoint - differential, the unit will stop.

```

PH15
Schedule with setpoint
change (Winter)
CONFORT Set      21.0°C
ECONOMY Set     19.0°C
PROTECTION Set  13.0°C
PROT.Lim.Dif    01.0°C
    
```

On this display, the setpoints for operation in HEATING mode (winter) are established, when it has been selected "3 setpoints schedule + OFF the unit " on the PH03 display.

Set.CONFORT: standard setpoint of the unit.

Set.ECONOMY: setpoint more removed from the comfort point, used at times with low occupancy of the building.

Set.PROTECTION: setpoint of building protection, usually used at night, when the building is empty.

Dif.lim.PROT: differential for the PROTECTION setpoint. When the temperature rises above the setpoint + differential, the unit will stop.

```

TCO Clock PH16
Time : 00:40
Day  : Friday
    
```

It displays the time and day having the TCO terminal in its internal parameters.

Note: This display only appears if a TCO thermostat has been activated on the CU12b display.

```

TCO scheduler PH17
Scheduler: Off
Current timeband: 0
Temp. setpoint: 26.0°C
    
```

This display shows if the scheduler of this terminal is active, the current timeband and the temperature setpoint.

Note: To leave these displays,  can be pressed, and the start display of the MAIN MENU will appear again.

## 24.6. GAS BURNER displays

```

G01
Gas burner control
by keyboard:

ONLY BURNER WITH
OUTDOOR TEMP. < 05.0°C
    
```

This option only appears in heat pump units with gas burner (optional). On this display it is possible to select 3 different methods in order to control the burner:

- 2nd stage burner: it will operate after the compressors as an electrical heater stage.
- Only burner: the burner will operate instead of the compressors.
- Only burner with outdoor temperature: it operates instead of the compressors if the outdoor temperature is less than the value set on the display (5°C by default).

## 25. DESCRIPTION OF THE TECHNICAL MENU DISPLAYS

From any display, by pressing the at the same time for a few seconds, it is possible to access the start display of the TECHNICAL MENU:



- User** In this group of displays it is possible to display and modify all the control parameters for the different functions and processes managed by the program: setpoint limits, control differential, control dead zone, free-cooling parameters, compensation etc. Only the parameters that have been enabled under the MANUFACTURER level.
- Maintenance** This group of displays is reserved for the technical support service (SAT). It is intended for the management of the compressor and unit counters for the calibration of the connected probes and to force the output of the relays.
- Manufacturer** The unit is configured on these displays with the selection and activation of the devices that have to be controlled. This configuration is factory-set and must not be modified unless there is a change in components.

### 25.1. USER displays

The group of user displays is protected by an access password. If the password has to be known: consult.

By pressing the keys, each of the following displays can be seen.

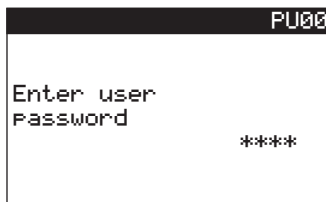

Once the password has been entered, it is possible to access the other user displays by pressing .

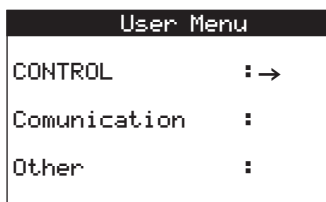

The USER displays are divided into three groups to which access is possible from this display.

### CONTROL group of displays

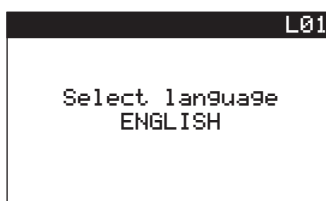

On this display, it is possible to select the language in which the unit pGD1 terminal will operate. The software is installed in English (EN), by default, and in another language requested by the client.

The languages available are: Spanish (SP), French (FR), Italian (IT), Turkish (TR) and German (GR).

The language of the displays is selected by pressing the keys + at the same time.

Note: when changing the language, the program reloads the main display which is the same as appears when switching on the pGD1 terminal.

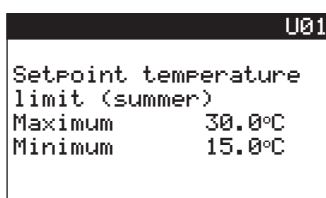

This defines the authorised maximum and minimum values of the temperature setpoint in COOLING mode (summer).

U01a	
Setpoint temperature limit (winter)	
Maximum	30.0°C
Minimum	15.0°C

This defines the authorised maximum and minimum values of the temperature setpoint in HEATING mode (winter).

U02	
Temperature regulat. band	
Summer	01.0°C
Winter	01.0°C

This determines the temperature control differential within which the compressor stages will be successively connected. This band can vary in accordance with the COOLING (summer) or HEATING (winter) operation mode. The value set by default: 2.0°C

U03	
Temperature regulat. dead zone	
	00.0°C

Area around the temperature control setpoint where no compressor is connected.

U04	
Humidity setpoint limit	
Maximum	80.0%
Minimum	25.0%

This display can only be displayed if humidity management is enabled (optional). This defines the authorised maximum and minimum values of the humidity setpoint.

U05	
Humidity control band	
	05.0%
Humidity control dead zone	
	00.0%

This display is shown with the humidity management (optional) activated. This display establishes: Humidity control band: humidity control differential in which all the compressor stages will be connected as the dead zone.

Dead zone humidity control: area around the humidity control setpoint where no compressor is connected.

U07	
Freecooling/heating temperature diff. (delta)	
	03.0°C
Max. opening:	
	100%

This display is only displayed if the thermal free-cooling function has been enabled. It establishes the differential between the outdoor/heating temperature and the return temperature to authorise the free-cooling function.

It's also possible to limit the maximum opening of the outdoor air amper during the free-cooling.

U08	
Freecooling/heating differential in entalphy:	
	01.000 Kc/Kg
Max. opening:	
	100%

This display is only displayed if the enthalpic free-cooling function has been enabled. It establishes the differential between the outdoor and return enthalpy to authorise the free-cooling function.

It's also possible to limit the maximum opening of the outdoor air amper during the free-cooling.

U09	
Summer Fcool damper (summer setpoint)	
Offset	-01.0°C
Different.	01.0°C

This determines the opening and closing of the outdoor air damper in the free-cooling summer function.

Offset: this defines the difference between the setpoint and the air return temperature at which the outdoor air damper is completely closed.

Differential: the opening of the outdoor air damper is carried out in accordance with the return air temperature.

```

U11
% outdoor air for
refreshing      20.0%
    
```

**% Outdoor refreshing air:** in units with mixing air probe (optional) the desired percentage of air refreshing is established (by default: 20%). The actual position of the outdoor air damper will depend on this value and on the temperature measured by the return, outlet and mixing probes.

In units with a recovery circuit, a percentage of 60% will be set.

```

U11b
Outdoor damper
Damper start-up in
winter:         normal
summer:         closed
Min. opening:   000.0%
Max. opening:   100.0%
    
```

**Damper start-up in winter:** this allows selecting the outdoor air position from the start until reaching the temperature control setpoint. By default, the damper is "closed" in summer and "normal" in winter to ensure that the position is assigned in accordance with the previous variables.

**Min. opening outdoor damper:** with this parameter it is possible to select a minimal opening for the damper. This allows, for example, that in units with recovery, activates the compressor of recovery without the conditions of temperature are fulfilled, and that the above mentioned compressor could work without problems for high or low pressure.

**Max. opening outdoor damper:** this parameter allows to block the maximum opening of the outdoor air damper, except if free-cooling is operating. With this limitation it is possible to assure the correct operating of the installation, although the user should wish 100 % of refreshing.

```

U11c
Unit 100% outdoor air
Damper opening
time:           090 s
unit ON in mode
COOLING if Amb.T.<30 °C
HEATING if Amb.T.>17 °C
    
```

This display is only displayed if the "100% outdoor air unit" has been enabled on the CU14 display.

**Damper opening time:** with this parameter, the indoor fan starting is delayed until the full opening of the outdoor damper.

**Unit ON:** the setpoints of ambient temperature for operation "100% outdoor air" are set in COOLING and HEATING mode.

```

U11d
Control of supply and
return damper
Damper opening
time: 150 s
    
```

This display is only displayed if the "control of supply and return dampers" has been enabled on the CU12c display. Note: these dampers are external to the unit.

**Damper opening time:** Timeout for the complete opening of the gate. Otherwise the control will indicate an alarm. The indoor fan will not start until this period has elapsed.

```

U12b
Minimum limit
outlet temp.
with ambient probe
Amb.T offset    15.0°C
Min. setpoint   07.0°C
Max. setpoint   22.0°C
Different.       05.0°C
    
```

A minimum outlet air temperature can be established in COOLING mode to ensure that when this temperature is reached, to raise this temperature the hot water coil, the compressors and the electrical heaters in HEATING mode could be introduced as "support".

**Amb.T offset:** this probe improves the outlet temperature control thanks to the offset established on this display which limits the difference between both temperatures.

**Min. & max. offset:** The control is activated when the outlet temperature is included between the maximum and minimum setpoint values.

**Differential:** No. of support stages will be divided within the differential established on this display.

```

U12c
Maximum limit
outlet temp.
with ambient probe
Amb.T offset    22.0°C
Min. setpoint   30.0°C
Max. setpoint   45.0°C
Different.       05.0°C
    
```

A maximum temperature for the outlet air can be established in HEATING mode that stops the unit, to avoid the stratification of the hot air masses.

**Amb.T offset:** this probe improves the outlet temperature control thanks to the offset established on this display which limits the difference between both temperatures.

**Min. & max. offset:** the control is activated when the outlet temperature is included between the maximum and minimum setpoint values.

**Differential:** No. of compressor stages will be divided within the differential established on this display.

```

U12d
Air quality
Probe
Setpoint        01000 PPM
Different.       00500 PPM
    
```

For units that have an air quality probe connected on input B10 on the board (optional), a value in parts per million of the volatile particles measured by the probe for the opening of the outdoor air damper can be established.

U13

```
Summer compensation
Outdoor T.    30.0°C
Different.    05.0°C
Max. comp.    05.0°C
```

In COOLING mode this function (optional) allows the setpoint temperature to be increased in accordance with the outdoor temperature in order to avoid thermal shock between the external and internal of the premises.

**Outdoor temp.:** minimum outdoor temperature for the start of compensation.

**Different.:** compensation band that determines the variation area of the outdoor temperature.

**Max. comp.:** maximum increase in the authorised setpoint temperature.

U14

```
Winter compensation
Outdoor T.    00.0°C
Different.    05.0°C
Max. comp.    05.0°C
```

In HEATING mode this function (optional) allows the setpoint temperature to be reduced in accordance with the outdoor temperature in order to avoid thermal shock between the external and internal of the premises.

**Outdoor temp.:** maximum outdoor temperature for the start of compensation.

**Differential:** compensation band that determines the variation area of the outdoor temperature.

**Max. compen.:** maximum decrease in the authorised setpoint temperature.

U19

```
Number of compress.
in dehum.:    0
```

This display can only be displayed if humidity management is enabled (optional) and establishes the number of compressors authorised to operate in dehumidification.

U20

```
Elec.heaters control
(winter setpoint)
Different.    02.0°C
Offset        -02.0°C
Enabling electrical
heaters if outdoor
temperature < 20.0°C
```

In units with electrical heater or gas burner, both optional, operating in HEATING mode:

**Differential:** total control band for the connection and disconnection of the stages (1 or 2 stages).

**Offset:** for the connection of the electrical heaters, the control compares the return temperature with the return temperature setpoint minus the compressor control band.

Note: see chart in section 8.2 in which these parameters are featured.

U28

```
Hot water coil
Offset        -2.0°C
Different.    2.0°C
Priority to comp.: NO
```

In units with hot water auxiliary coil (optional) operating in HEATING mode:

**Offset:** for the 100% opening of the valve the control compares the setpoint return temperature minus the compressor control band setpoint temperature.

**Differential:** opening control band 0-10V of the proportional valve.

Note: see chart in section 8.2 in which these parameters are featured.

**Priority to comp.:** enabling of the priority for the operation of the hot water coil as the first stage in HEATING mode.

U28b

```
Cold water coil
Offset        2.0°C
Different.    2.0°C
Priority to comp.: NO
```

In units with hot water auxiliary coil (optional) operating in COOLING mode:

**Offset:** for the 100% opening of the valve the control compares the setpoint return temperature more the compressor control band setpoint temperature.

**Differential:** opening control band 0-10V of the proportional valve.

Note: see chart in section 8.1 in which these parameters are featured.

**Priority to comp.:** enabling of the priority for the operation of the hot water coil as the first stage in COOLING mode.

U28b

```
Elec.heaters offset
in summer    -05.0°C
Heat valve offset
in summer    -02.0°C
```

In units with electrical heater and/or hot water coil (optional) operating in COOLING mode, both components can enter as support to increase the return temperature. On this display the offset values are established for their connection.

```

U35a
TANDEM COMPRESSORS
AND INDOOR PLUG-FAN
WITH ZONING BY VARIABLE
ZONE_1:Y ZONE_2:Y
Active zones: 2 zones
Flow 1 zone: 050.0%
Flow reduc.: DISABLE
    
```

In units with tandem compressors (2 compressors / 1 circuit or 2 compressors / 4 circuits) and supply plug-fans, if permitted power zoning by damper on screen CU12c:

**ZONE\_1 y ZONE\_2:** to enable or disable the two zones manually.

**Active zones:** Number of zones activated (50% or 100% of the power). On having selected 1 zone, an alone compressor will be allowed at the maximum on each circuit, the operation of the recovery compressor or the electrical heaters will not be allowed. Only there will be allowed the hot water coil up to a maximum power of 50 %.

**Flow 1 zone:** percentage of flow with which the unit will work with regard to the setpoint flow.

**Flow reduc.:** indicates whether the reduction of the air flow function is active.

```

U35b
TANDEM COMPRESSORS
AND INDOOR PLUG-FAN
WITHOUT ZONING
Flow AUTO reduction
with tandem 50%: NO
Flow perc.: 050.0%
Flow reduc.: DISABLE
    
```

In units with tandem compressors and supply plug-fans, without zoning:

**AUTO reduction:** the reduction of the air flow rate function is enabled.

**Flow perc.:** percentage of flow with which the unit will work with regard to the setpoint flow in case an alone compressor works at maximum on each circuit (50% - 75%). This reduction of flow is not allowed if the recovery compressor and the electrical heaters are working. It will not also be allowed if the hot water coil is over 50 % of power.

**Flow reduc.:** indicates whether the reduction of the air flow function is active.

```

Disconnecting U36
No. compressor stages
to disconnect: 0
No. el.heaters stages
to disconnect: 0
Enable stages disconn.
for dig.input: NO
    
```

This display allows to disconnect compressor or electrical heater stages. This is useful for reducing electric consumption in time bands when the electric price rate is high.

**Enable stages disconn.for dig.input:** this parameter allows to disconnect compressor and/or electrical heater stages mechanically via the digital inputs of the expansion module pCOe No.2 (address 8) (optional).

```

U37
Enter new
user password
****
    
```

This display allows modifying the access password to the group of USER displays.

## COMMUNICATION group of displays

```

U36a
Type of Protocol
for supervision
network
Carel
    
```

This display is for selecting the protocol type to be used in an installation with centralised technical management.

The available protocols with CIATrtrc are: Carel, Lonworks, Modbus and Modbus extended.

Note: "commissioning" can also be selected to display the variables using the PCO MANAGER software.

```

U36b
Unit address
for supervision
network      001
Baud rate   19200
    
```

**Unit address:** address for centralised control.

**Baud rate:** transmission speed (bit rate) in bps: 19200 (with standard modem), 9600, 4800 (with Lonworks protocol), 2400, 1200.

With Modbus protocol this display also will show the following parameters:

**Stop bit No:** this variable can take value 1 or 2.

**Parity type:** without parity, couple or odd.

Configuration depending on the installed communications card:

**RS485 serial card**

Protocol: CAREL or MODBUS

Address: 1 to 207

Baud rate: 1200, 2400, 4800, 9600, 19200 bps

**LONWORKS FTT serial card**

Protocol: LON

Address: 1 (\*)

Baud rate: 4800 bps

(\*) The address is configured in the communication card.

### KONNEX serial card *(Configuration by the Integrator)*

Protocol: MODBUS  
Address: 1 (\*)  
Baud rate: 9600 bps

### BACNET MSTP RS485 card *(Configuration by the Integrator)*

Protocol: CAREL or MODBUS  
Address: 1 to 207  
Baud rate: 1200, 2400, 4800, 9600, 19200 bps

(\*) The address is configured in the communication card.

### ETHERNET PCOWEB card

Protocol: CAREL  
Address: 1 (\*)  
Baud rate: 19200 bps

### BACNET ETHERNET PCOWEB card

*(Configuration by the Integrator)*  
Protocol: CAREL  
Address: 1 (\*)  
Baud rate: 19200 bps

```

U36c
Enable BMS communicat.
fault detection: N
Time for fault: 15 m

Var.digital BMS fault
detection n. 174: N
BMS commun. fault:N
    
```

**Enable BMS communicat.fault detection:** It enables the activation of parameters by default when a fault occurs in the BMS communication.

**Var.digital BMS fault detection:** for the checking of the loss of communication for more than 15 minutes.

**BMS commun. fault:** this parameter will flash 'Yes' if the failure is detected.

```

U40a
VALUES WITHOUT BMS

Temp. control
setpoint
Summer      26.0 °C
Winter     21.0 °C
    
```

This display allows to select the values by default for setpoints, in the event of a failure in the BMS communication.

```

U40b
VALUES WITHOUT BMS

Unit off/on

OFF
    
```

This display allows to select the value by default for the unit status (ON / OFF), in the event of a failure in the BMS communication.

```

U40c
VALUES WITHOUT BMS

Winter/Summer select.
'by keyboard'y out.t.

WINTER
    
```

This display allows to select the value by default for the operating mode (WINTER or SUMMER), in the event of a failure in the BMS communication.

```

U40d
VALUES WITHOUT BMS

DISCONNECTING
No. compressor stages
to disconnect: 0
No. el.heaters stages
to disconnect: 00 %
    
```

This display allows to configure the disconnection of compressor and/or electrical heater stages, in the event of a failure in the BMS communication.

```

U40e
VALUES WITHOUT BMS

Start type
'ON-OFF schedule'
    
```

This display allows to configure the start type by default, with schedule program, in the event of a failure in the BMS communication.



```

U40f
VALUES WITHOUT BMS

SCHEDULE PROGR. N.1
Slot 1>06:30 a 11:00
Slot 2>11:30 a 13:30
Slot 3>15:00 a 19:00
    
```

This display allows to configure the timetable by default, with schedule program, in the event of a failure in the BMS communication.

```

U40f
VALUES WITHOUT BMS

Program select.
Daily start
M:1 T:1 W:1 T:1 F:1
S:1 Su: -Sun-(0=off)
    
```

This display allows to select the days of the week with schedule program, in the event of a failure in the BMS communication.

## OTHER group of displays

```

U18a
Automatic start
after blocking: YES
Automatic start
after a time of 005 sec
    
```

Automatic start after blocking: after a power cut the unit starts to operate in the status in which it was operating prior to the power cut.

Automatic start after time: this parameter times the start after the power cut. This parameter can be useful for scaling the start of different units in the same installation.

```

U18a1
Enabling remote
On/Off: Y
Remote Off with
PROTECTION mode: Y
Disab.comp.COOL: N
Dis. air refresh.: N
    
```

Enabling remote On/Off: this authorises remote shutdown using a remote control (the terminal always has priority). For maintenance tasks the remote control must be disabled.

Remote Off with PROTECTION mode: enables the BUILDING PROTECTION mode when the remote ON/OFF connected on digital input is OFF.

Disab.comp.COOL: when the unit is working with schedule program and summer limit setpoint the compressors can be disabled (selected in PH03). This night free-cooling gets stored cold in the building overnight, with a setpoint of temperature lower than the normal during the day.

Dis. air refresh.: when the unit is working, during the night-time operation, with schedule program and summer limit setpoint the air refreshing can be disabled (selected in PH03).

```

U18a2
Remote Off with PROTEC
Setpoint - summer
Set.PROTECTION 34.0°C
PROT.Lim.Dif. 02.0°C
Setpoint - winter
Set.PROTECTION 13.0°C
PROT.Lim.Dif. 01.0°C
    
```

This display is for selecting the setpoints and differential of BUILDING PROTECTION in COOLING / HEATING mode.

```

U18b
Display lighting
auto. switch off in:
030 s
(0 = always OFF)
    
```



This display allows the back-lighting time of the thermostat display to be modified.

```

U18c
Enable autom. return
to main menu? NO
After a time of:
120 sec
    
```

Automatic return to the MAIN display is enabled on this display.

## 25.2. MANUFACTURER displays

The group of MANUFACTURER displays is protected by an access password. If the password has to be known: consult. By pressing the   keys, each of the following displays can be seen.

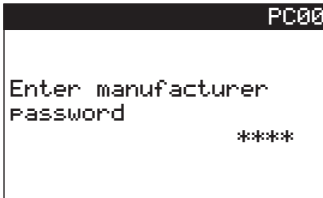

Once the password has been entered, the following display is accessed.

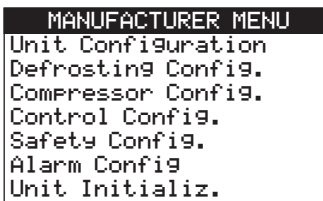

The MANUFACTURER displays are divided into four groups to which access is possible from this display.

### UNIT CONFIGURATION group of displays

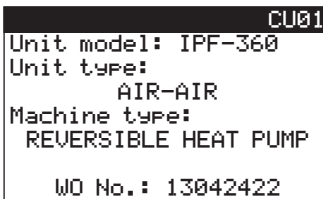

**Unit model:** for units of the series Space PF (the most common with this control), the default values for the displays CU02, CU04 y CU041 may be loaded by selecting the unit model.

**Unit type:** air-air or water-air.

**Machine type:** cooling only or reversible heat pump.

**WO No.:** work order number of the unit.

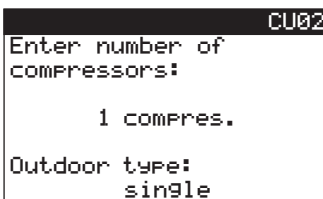

This defines the number of unit compressors (circuits) It is possible to select: 1 compressor (1 circuit), 2 compressors (1 circuit), 2 compressors (2 circuits) + 2 compressors + 1 partition, 2 compressors (3 stages), 4 compressors (2 circuits), 4 compressors (4 circuits).

**Note:** These compressors correspond to the main circuits: If the unit includes a recovery circuit, it is configured on the CU03 display.

**Outdoor type:** in units with 2 circuits: single or double outdoor air volume.

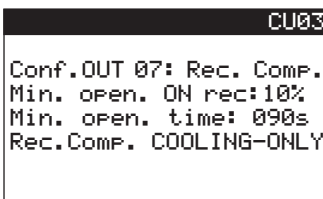

**Conf. OUT 07:** configuration of the NO7 output (connector J14) on the board as output for one of the following options:

**HUMID:** humidifier.

**PUMP:** circulation pump of the hot water auxiliary coil circuit. In this case, the display shows the following parameter:

**Start PUMP by outdoor T:** with the unit stopped, when the temperature drops below 4°C the pump of the water auxiliary circuit will be connected. The unit will operate with 100% opening of 3-way valve in the "OFF" operating mode and with a minimum opening of the 10% (by default) in "ON" mode. The pump switching off will be timed by default in 60 seconds.

**Note:** It is the installer's responsibility to connect the pump to the electronic control, except with the factory-installed GREAT COLD option.

**Rec.comp.:** in this case, the recovery circuit compressor is activated. In this case, the display shows the following parameters:

**Min. open. ON rec.:** the recovery compressor can function when the outdoor air damper is open, as a minimum, to the percentage set on this display. By default: 10%.

**Min. open. time:** the recovery compressor can function when the outdoor air damper is open, as a minimum, to the time set on this display. By default: 90s.

**Rec.comp.:** for cooling-only units with recovery circuit, it's possible to select the operating of this compressor as heat pump.

**Rot. rec.:** in this case, the rotary recovery on-off is activated. In this case, the display shows the following parameters:

**Min. open. ON rec.:** the rotary recovery can function when the outdoor air damper is open, as a minimum, to the percentage set on this display. By default: 5%.

**Min. open. time:** the rotary recovery can function when the outdoor air damper is open, as a minimum, to the time set on this display. By default: 10s.

The two preceding parameters must be met to allow operation of recovery and, in addition, that the free-cooling or free-heating is not active.

**ON in defrost:** the rotary recovery may operate during defrosting, so the outdoor air damper will be open.

**Variable speed:** NO with on/off rotary recovery and YES with variable rotary recovery.

```
CU03a
Mod. PCOE n.8
Conf.OUT 01: Alarm
```

If the unit includes the expansion card pCOe No.2 (address 8), the digital output NO01 can be used as output for the same optional elements that the output NO7 board. This allows to have configured, for example: Recovery compressor (CU03) + Alarm (CU03a).

```
CU03a
Mod. PCOE n.8
Conf.OUT 04: Pump
Start pump by
outdoor T. < 04.0°C
with minimum opening
hot water coil 010%
Delay off pump 060s
```

If the unit includes the expansion card pCOe No.2 (address 8), the digital output NO04 can also be used as output for the same optional elements that the output NO7 board. This allows to have configured, for example: Recovery compressor (CU03) + Alarm (CU03a) + Pump (CU03b).

```
CU03c
Control wheel
speed with temperature
extraction/recovery
Temp.max.speed:06.0°C
Temp.min.speed:01.0°C
Maximum speed: 100%
Minimum speed: 010%
```

If the unit includes a variable rotary recovery, this display allows to configure the setpoints of temperature and speed to control the variable wheel depending on the extraction temperature and/or the recovery temperature in the wheel.

```
CU04
Indoor fan type
radial plug-fan'
Fan No.= 2 K=260
Nom. flow: 12000m3/h
Min. flow: -20%
Max. flow: 20%
```

**Indoor fan-type:** it is possible to select the type of indoor fan (supply fan) installed:

- Centrifugal.
- Centrifugal + VFD (variable frequency drive). In this case also the parameters will appear on the display for the adjustment of the fan operating point to maintain the desired constant flow.
  - **Mot pulley:** diameter of the pulley installed on the indoor motor (mm).
  - **Fan pulley:** diameter of the pulley installed on the indoor fan (mm).
  - **Nom flow:** nominal flow of the indoor fan.
  - **Pda1:** minimum point of differential pressure of the indoor fan.
  - **Vel. F1:** minimum point of rpm of the indoor fan.
  - **Pda2:** maximum point of differential pressure of the indoor fan.
  - **Vel. F2:** maximum point of rpm of the indoor fan.

The variable frequency drive will be connected on the Field-bus of the µPC MEDIUM board by means of one RS485 card, with address 1 (9600 bps, 8 bits of data, 2 stop bits without parity).

- Radial.
- Radial plug-fan. In case of radial plug-fan also the parameters will appear on the display for the selection of: fans number, constant "K" of the fan, nominal flow of the unit and percentages of minimal and maximum flow allowed.

The plug-fan will be connected on the Field-bus of the µPC MEDIUM board by means of one card RS485, with address1 (9600 bps, 8 bits of data, 2 stop bits without parity).

```

CU04a
VDF No.001    MOD=0
Motor Parameters
Volt.:400V cosfi=0.85
Frequency:    50.0Hz
Speed:        1440 rpm
Current:      000.0 A
Current limit: 000.0 A
    
```

This display only will appear if on the previous display it has been selected: indoor centrifugal fan + variable frequency drive (VFD).

All the parameters of the indoor motor that need to know the frequency converter will be introduced therein: type of variable frequency, nominal voltage of the indoor motor, cosine Phi, nominal frequency, nominal speed, nominal current and motor current limit.

```

CU04c
Damper for re9.
condensation and/or
evaporation Pressure
indoor unit: NO
Max.open COOL: 100%
Max.open HEAT: 100%
Minimum open: 000%
    
```

This display only will appear if on the CU04 display it has been selected: indoor centrifugal fan. It allows the activation of the evaporation / condensation control by supply air damper. The control will automatically vary the opening of the damper between the minimum and maximum values selected on this display.

```

CU04i
Return fan type
radial plug-fan
Ena. overpressure: NO
Fan No.= 2 K=260
Nom. flow: 12000m3/h
Min. flow: -30%
Max. flow: 00%
    
```

Return fan-type: it is possible to select the type of return fan installed (optional):

- Centrifugal
- Centrifugal + VFD (variable frequency drive). In this case also the parameters will appear on the display for the adjustment of the fan operating point to maintain the desired constant flow.
  - Mot Pulley: diameter of the pulley installed on the return motor (mm).
  - Fan Pulley: diameter of the pulley installed on the return fan (mm).
  - Nom flow: nominal flow of the return fan.
  - Pda1: minimum point of differential pressure of the return fan.
  - Vel. P1: minimum point of rpm of the return fan.
  - Pda2: maximum point of differential pressure of the return fan.
  - Vel. P2: maximum point of rpm of the return fan.

The variable frequency drive will be connected on the Field-bus of the  $\mu$ PC MEDIUM board by means of one card RS485, with address 2 (9600 bps, 8 bits of data, 2 stop bits without parity).

- Radial
- Radial plug-fan. In case of radial plug-fan also the parameters will appear on the display for the selection of: fans number, constant "K" of the fan, nominal flow of the unit and percentages of minimal and maximum flow allowed.

The plug-fan will be connected on the Field-bus of the  $\mu$ PC MEDIUM board by means of one card RS485, with address 2 (9600 bps, 8 bits of data, 2 stop bits without parity).

Ena. overpressure: this variable enables the control of the overpressure in which the outdoor air damper and the extraction damper are managed independently.

```

CU04b
VDF No.002    MOD=0
Motor Parameters
Volt.:400V cosfi=0.85
Frequency:    50.0Hz
Speed:        1440 rpm
Current:      000.0 A
Current limit: 000.0 A
    
```

This display only will appear if on the previous display it has been selected: return centrifugal fan + variable frequency drive (VFD).

All the parameters of the indoor motor that need to know the frequency converter will be introduced therein: type of variable frequency, nominal voltage of the return motor, cosine Phi, nominal frequency, nominal speed, nominal current and motor current limit.

```

CU05
3-WU / Pump type
Proportional
max.COOL.val.: 100%
max.HEAT.val.: 100%
minimum value: 000%
    
```

3-WU / Pump type: in **water-air** units, it's possible to select:

- On / off: for the connection of a pump or an on-off 3-way valve, in the digital output of the outdoor fan (by the client).
- Proportional: proportional 3-way valve, for the control of evaporation and condensation pressures, connected in the analogue output of the electronic fan. In this case, three parameters will also appear on the display for selecting the maximum opening of the valve in COOLING and HEATING mode, as well as for selecting the minimal opening.

```
CU055
Outdoor fan type
    electronic
max.COOL.val.: 100%
max.HEAT.val.: 100%
minimum value: 000%
```

**Outdoor fan type:** in **air-air** units, it's possible to select the type of outdoor fan installed: 2-speed axial (by default), 1-speed axial / radial, centrifugal or electronic.

In case of an electronic fan three parameters will also appear on the display for selecting the maximum speed in COOLING and HEATING mode, as well as selecting the minimal speed.

```
CU05a
Change speed out. fan
COOLING: 34.0-27.0 bar
HEATING: 09.0-06.0 bar
change time: 02 sec
```

This display is only displayed if the 2-speed outdoor fan (by default) and the pressure sensor in the outdoor coil have been selected.

The pressures are selected for the change in speed as well as the fan disconnection time for said change to be implemented. The fan start is always carried out at high speed.

```
CU05b
Damper for control
condensation and / or
evaporation pressure
in outdoor unit: Y
max.open.COOL: 100%
max.open.HEAT: 100%
minimum open: 000%
```

This display is only displayed if the centrifugal outdoor fan and the pressure sensor in the outdoor coil have been selected. If the unit includes a damper for the control of the condensation / evaporation pressures the value "YES" must be selected.

The damper servomotor is regulated by the signal 0..10Vdc of the analogue outputs Y3 (circuit1) and Y4 (circuit 2). This will remain open whilst the compressor is stopped and for the first 120 seconds of compressor operation.

```
CU06
GAS BURNER
Enable: NO
Burner in defrost: NO
Alarm signal:
    disabled
```

On this display the gas burner (optional) can be enabled and optionally activated as back-up during the defrosting operation.

With the burner enabled, in the event of alarm, the control will only indicate this alarm.

```
CU07
Enter number of
Elec.heaters:
-----
E.heater in def.: NO
No. E.heater def.: 0
Activ. elect. heaters
without compressor:NO
```

With auxiliary electrical heaters (optional) the number of heaters can be selected on this display:

- None
- 1 electrical heater
- 2 electrical heaters
- 2 electrical heaters (3 stages): with two electrical heater stages as 3rd stage the two electrical heaters will enter at the same time.
- proportional: output Y2 is used for the control of the electrical heater. In this case the unit cannot include a proportional hot water coil.

**E.heater in def.:** connection of the electrical heater during defrosting.

**No. E.heater def.:** number of activated electrical heaters in defrosting.

**Activ. elect. heaters without compressor:** in those cases where there is limited the electrical consumption or the section of the electrical power supply, it is possible that the electrical heaters work place of the compressors if they are disabled or with alarm. This prevents the joint operation of compressors and electrical heaters in heating mode.

```
CU08
Heat valve: NO
Cold valve: NO
Control type: PROP
Heat valve defr.: NO
Heat valve defr.: 100%
GC security op.: NO
```

**Heat valve:** 3-way valve to activate the hot water auxiliary coil (optional).

**Cold valve:** 3-way valve to activate the cold water auxiliary coil (optional).

**Attention:** This cold water coil can operate as support in HEATING mode. To avoid the water inlet with an inadequate temperature for each operating mode, the unit incorporates an external additional thermostat that can cut-off the 0...10Vdc signal of the Y2 analogue output.

Enabling on this display "heat valve" or "cool valve", automatically, the digital output NO7 will be configured as "pump" (the circulation pump of the water coil circuit).

**Control type:** the control has a proportional (by default) or off/on output where a three-way valve can be connected on control a hot water coil (with a proportional electrical heater stage it's possible to connect an on/off water coil in digital output NO6).

**Heat valve defr.:** connection of the hot water auxiliary coil during defrosting and opening percentage of the 3-way valve during defrosting.

**GC security op.:** enabling the antifreeze protection of the hot water coil with low outdoor temperatures, GREAT COLD option (so the expansion card pCOe No.2 is necessary).

With GREAT COLD option, analog inputs B3 and B4 of the expansion card pCOe No.2 (address 8) will be used for the reading of the inlet and outlet temperatures of the water coil, respectively.

This option is not compatible with the control of condensation / evaporation pressures of the indoor unit in 4 circuits units, because these analogue inputs are used by the pressure sensors of circuits 3 and 4.

With GREAT COLD option, the setpoints for antifreeze protection of the hot water coil (HWC) are set on this display (CU08 display):

**setpoint:** if the water temperature of the coil falls below this temperature, the control activates the pump and the 3-way valve opens to 100%.

**differential:** the pump stops when 7°C are reached (4°C setpoint + 3°C differential).

With GREAT COLD option, the setpoints for antifreeze protection of the hot water coil (HWC) are set on this display (CU08 display):

If the outdoor temperature drops below 4°C, the control activates the pump and the 3-way valve opens to maintain a water outlet temperature on the HWC of 10°C in ON operating mode and 15°C in OFF operating mode (OFF offset = 5°C).

**Ambient Probe:** the ambient probe improves the outlet temperature control.

**Control by:** with this parameter it is possible to control the setpoint by means of the ambient temperature probe (standard) or the return temperature probe (optional).

**Amb. probe type:** There are different options for the ambient probe:

- NTC (by default): one ambient probe installed on the analogue input B5 (if the unit does not incorporate outdoor humidity probe). The maximum distance of the NTC sensor to the control board can be 30 metres.
- 4-20mA: one ambient probe installed on the analogue input B5 (if the unit does not incorporate outdoor humidity probe).
- RS485: one to four ambient probes connected to the Field-bus on the µPC MEDIUM board using RS485 serial communication card(s).
- pLAN: one ambient probe installed on the master unit of a pLAN network.

Note: the CU12b display allows to select that the control of the ambient temperature will be done by means of the ambient probe installed on the TCO terminal (optional).

**Cal. amb. T. COOL:** if the unit incorporates two ambient probes, in COOLING mode, the display will use the measured value: minimum, maximum, or the average of all values.

**Cal. amb. T. HEAT:** if the unit incorporates two ambient probes, in HEATING mode, the display will use the measured value: minimum, maximum, or the average of all values.

**Outlet air Probe:** Yes/No (this probe is standard).

**Outdoor T. Probe.:** no, actual, pLAN. By default: actual, but there can use the reading of the probe of the master unit in case of breakdown of this probe in some unit of the network pLAN.

**Ind. RH Probe:** This probe is necessary for enthalpic free-cooling and/or humidity control. The installation of this probe in the field-bus RS485 allows the installation of air quality probe in the analogue input B10 (see CU11).

```
CU08a
G.C. HWC security

Antifreeze security
in water circuit
setpoint:    04.0°C
differential: 03.0°C
```

```
CU08b
G.C. HWC security

Temp. minimum security
in water circuit
setpoint:    10.0°C
offset in OFF: 05.0°C
control band: 02.0°C
```

```
CU09
Ambient Probe: YES
Control by ambient T.

Amb. probe type: 2rs485
Cal. amb. T. COLD: AVERAG
Cal. amb. T. HEAT: AVERAG
```

```
CU10
Outlet probe      Y
Outd. T. probe   Actual
Ind. RH probe     N
Outd. RH probe   N
Outd. unit sens. Y
Ind. unit sens.  Y
```

**Outdoor RH Probe:** No, actual, pLAN. This probe is necessary for enthalpic free-cooling and it can be installed in the analogue input B5.

Note: In a pLAN formed by µPC MEDIUM boards, a “master” board can share the following variables with the rest of boards (if they meet the facility’s conditions): outdoor temperature, outdoor relative humidity and outdoor relative humidity.

**Outd.unit sensor:** on this display, the condensation and evaporation control can be enabled via the outdoor coil sensors (air-air) or the refrigerant anti-freeze sensors (water-air). This option is only available if the unit includes pressure transducers (by default). The sensor type is selected on the CU12 display.

**Ind.unit sensor:** on this display, the condensation and evaporation control can be enabled via the indoor coil sensors. This option is only available if the unit includes the expansion card pCOe No.2 (address 8).The sensor type is selected on the CU12 display.

**Control HUM/DESH.:** this authorises the humidity control function (optional).

**Humidificacion:** no, on-off (digital output NO7 of connector J14) or proportional (analogue output Y1 of the pCOe expansion card No.1 (address 7)).

**Deshumidificacion:** no, 1, 2 or 4 compressors.

**% temp. ON dehu. and % temp.OFF desu.:** to ensure that the compressors can control humidity, the return air must have a temperature ranging between the setpoint ±15% of the temperature differential and the setpoint ±85% of the temperature differential.

**OFF Outdoor damper if Ind. RH > 100.0%,** with this parameter there is authorized the closing of the outdoor damper if the indoor humidity is higher than the fixed value. By fault 100 % is established in order that this value is not born in mind.

```
CU10a
Control HUM/DEHU.: NO
Humidification: NO
Dehumidification: NO
% temp. ON dehu.: 015%
% temp.OFF dehu.: 085%
OFF Outdoor damper
if Ind. RH > 100.0%
```

This is applied to avoid excessive ambient temperature drops when, operating in COOLING mode, so that the outlet temperature does not drop below the minimum temperature limit. The following components could enter as support to raise this temperature:

**Heat valve:** activating the hot water auxiliary coil (optional).

**Compressors:** operation in HEATING mode.

**Elec.Heaters:** conection of the electrical heater (optional).

This setting is important for units with automatic switching between COOLING and HEATING mode, with low outdoor temperatures and hot water coil, to avoid the risk of freezing of the coil if the unit starts to operate in COOLING mode.

```
CU10b
Min. outlet control
in summer with
Heat valve: YES
Compressors: YES
Elec.Heaters: NO
```

This is applied when the unit is operating in HEATING mode, so that the outlet temperature does not drop below the supply setpoint (21°C by default). The following components could be activated as support to raise this temperature: compresor in HEATING mode, hot water auxiliary coil and electrical heater (in the order of entry established for HEATING mode).

This setting is important for units with low outdoor temperatures and hot water coil, to avoid the risk of freezing of the coil if the unit starts to operate under the setpoint.

If the unit is working in HEATING mode, when there is demand of free-cooling in winter, the control of minimun outlet temperature will change and it'll begin to be performed as a fonction of the setpoint of minimun outlet temperature in COOLING mode (10°C by default).

```
CU10c
Min. outlet control
in winter with
Heat valve YES
Compressors: YES
Elec.Heaters: NO
```

The probe type for controlling the inlet of air from the outdoor damper (units with mixing boxes) can be selected on this display. There are 3 options:

- Mixed air temperature probe (NTC type).
- Actual air quality probe (4-20mA type): in this case, on the display, it is mandatory to select that the mixing probe is installed in the analogue input B10. If the unit incorporates the probe of indoor humidity (ambient or duct), this will be connected on the RS485 field-bus (selected on CU10).

```
CU11
Probe for refresh.:
Actual Air quality
Activate control: Y
Units:PPm7
Mixing temp. Probe: Y
```

The installation of mixed probe + air quality probe improves the management of the air refreshing with low outdoor temperatures.

- pLAN air quality probe (4-20mA type): if the unit is included in a pLAN network can use the reading of the probe of air quality installed physically in the unit No.1.

With quality probe also these parameters have to be selected:

**Activate control NO/YES** in order to authorise the control of the outdoor air damper in accordance with the air quality probe.

**Units: % /PPM** in order to select the measuring unit that will be used. By default, it will be adjusted in ppm.

```

CU11a
Mixing temperature
OFF set damper in
winter if < 12.0°C
OFF set damper in
summer if > 35.0°C
    
```

If on the previous display is selected "probe type on AI8: mixing temperature", then on this display two setpoint values can be set:

**OFF set damper in winter:** the outdoor air damper closes below this mixing temperature. By default: 12.0°C, and for units with recovery circuit: 5°C.

**OFF set damper in summer:** the outdoor air damper closes above this mixing temperature.

```

CU12
Clock card      YES
Out.unit sensor Pres.
In.unit sensor  Pres.
Refrigerant     R410A
Gas leak det.   NO
    
```

**Clock card:** the µPC MEDIUM includes this card for schedule programming.

**Out.unit sensor:** this enables the type of sensor(s) for the outdoor unit to be selected: pressure (by default) or temperature.

**IN.unit sensor:** this enables the type of sensor(s) for the indoor unit to be selected: pressure (by default) or temperature (this option is only available with de expansion card pCOe No.2).

**Refrigerant:** this allows to select the values of pressure and temperature for each refrigerant used for the control.

**Gas leak det.:** this allows to select a refrigerant leak detector. It will be connected on the Field-bus of the µPC MEDIUM board by means of one card RS485, with address 6 (9600 bps, 8 bits of data, 2 stop bits without parity).

```

CU12a
Summ/Win select.
'automat.'
      by out.T
Compensation set N
Prot. low outd.T. N
TCO Thermostat  Y
    
```

**Sum./win. select:** selection of the switching type of the operating mode:

**by keyboard:** it is possible to modify the operating mode HEATING/COOLING from the pGD1 terminal (on the FC01 display of the MAIN MENU).

**by digital input:** the selection of the operating mode HEATING/COOLING is performed via a switch connected on digital input DI8 of connector J16

**Automat.:** automatic in accordance with the value measured by the probe. Two options:

- **by Out.T:** outdoor temperature (by default).
- **by Out.T:** ambient (or return) temperature.

**only ventilation:** it allows operation for only supply fan, return fan (optional) and free-cooling or free-heating (optional).

**Compensation set:** this authorises the setpoint compensation in accordance with the outdoor temperature.

**Prot. low outd.T:** this authorises the GREAT COLD option for protection to low outdoor temperatures. This optional is managed with the digital outputs of the expansion card pCOe No.2 (address 8).

- Output NO1: pipes of the hot water coil circuit with antifreeze protection.
- Output NO2: compressor with supplementary crankcase heater and electrical heater for protection of the electric panel (1<sup>st</sup> stage)
- Output NO3: electrical heater for protection of outdoor dampers.
- Output NO4: electrical heater for protection of the electric panel (2<sup>nd</sup> stage).

The temperature setpoints for the electrical heaters are set on CS11 display.

**TCO Thermostat:** enabling of the thermostat TCO connected on the Field-Bus of the µPC MEDIUM board by means of one RS485 card (Modbus master), with address 10.



```
TCO Thermostat CU12b
Sensor select.: TCO
Control by ambient T
Lock key: NO
Clock source: uPC
Sched. source: uPC
Speed change : Y V1
```

If on the CU12a display the TCO thermostat has been activated:

**Sensor select.:** selection of the probe to be displayed: TCO, return or ambient.

**Control by:** selection of the control type: By return or ambient temperature.

**Lock key:** The TCO thermostat keypad lock. The thermostat will display the icon .

**Clock source:** selection of clock: μPC MEDIUM board or TCO thermostat.

**Sched. source:** selection of the scheduler: μPC MEDIUM board or TCO thermostat. If the latter is selected, the clock of the TCO thermostat also must be selected.

**Speed change:** this parameter allows to change the flow setpoint with supply plug-fan, by means of the TCO user terminal. 3-speed can be selected by pressing the "VENTILATION" key  (V1: minimum flow, V2: nominal flow and V3: maximum flow).

```
CU12c
Control enable
of supply and return
dampers:
      Y
```

This screen allows the control of supply and return dampers, external to the unit. this option is only available with de expansion card pCOe No.3 (address 9).

```
CU12c
Zoning enabling
by variable: N
Zoning enabling
by dampers: N
```

In units with tandem compressors (2 compr. / 1 circuit or 4 compr. / 2 circuits) and supply plug-fan.

**Zoning enabling by variable:** this authorises the zoning function of power (50%-100%) and air flow of indoor fan.

**Zoning enabling by dampers:** this authorises the zoning into 2 areas with dampers. The expansion card pCOe No.3 (address 9) is necessary for this optional.

- With this type of zoning, the ducts of supply and return are splitted into two branches. In each branche is placed a damper with an on/off servomotor and end of stroke stop. The startup of the unit will not be allowed if the opening of the dampers of supply and return of a same area is not detected. In the case of opening of the two areas will be allowed the operation with 100 % of flow.
- Two ambient temperature probes (T) will be installed (one on each area) to control both the unit and the dampers of supply and return, depending on the temperature setpoint and the operating mode.
- Two air quality probes (CO2) will be installed to control the outdoor air requirement. The renewal of air and the dampers of supply and return will be managed depending on the air quality setpoint. The percentage of opening of the outdoor damper will take place according to the renewal of air required depending on the air quality setpoint and the maximum value of the two probes of CO2.
- The demand of the 2 areas will be very close to 50%, although it can support variations between 40 and 60%.
- In the management of the opening of the dampers, the demand of ventilation due to air quality will always have priority over the temperature.

```
CU13
Electric power
meter N
Cooling/heating
capacity calcul. N
```

**Energy power meter:** it allows to select a energy meter in order that the readings that it realizes are visualized by means of the control μPC MEDIUM. The energy meter will be connected on the Field-bus of the μPC MEDIUM board by means of one RS485 card, with address 5 (9600 bps, 8 bits of data, 2 stop bits without parity).

**Cooling/heating capacity calcul.:** to perform this calculation, it's necessary to connect two RS485 enthalpic probes: one for the mixing air (placed before the indoor coil) and other for the outlet air (placed after the indoor coil). These probes will be connected on the Field-bus of the μPC MEDIUM board by means of RS485 cards, with address 132 for the mixing probe and address 133 for the outlet probe.

```
GAUZZI 005 CU13
System type: 3P
Primary CT: 00000
Primary UT: 00000
Reset counters: NO
```

If on the CU12a display the energy meter has been activated (Gavazzi WM14 DIN model).

**System type:** It shows the suitable electrical system (3P = three-phase)

**Primary CT:** relation of the current transformer.

**Primary UT:** relation of the voltage transformer.

**Reset counters:** for reset all the records stored in the meter.

```

CU14
Supervision      N
Summer fcooling  Y
Winter fheating  N
Winter fcooling  Y
Air refreshing   Y
100% outdoor air N
    
```

**Supervisory:** this authorises the connection of the unit to a supervision network for centralised technical management (Carel, Modbus or Lonworks protocols).

**Summer fcooling:** this authorises the free-cooling function in COOLING mode.

**Winter fheating:** this function is not authorised.

**Winter fcooling:** this authorises the free-cooling function in HEATING mode.

Note: the free-cooling function and the activation of the recovery circuit are not compatible. After free-cooling, the first compressor of the main circuit will enter into operation, if necessary.

**Air refreshing:** if the option NO is selected, the opening of the damper for refreshing is disabled. The damper could only open for free-cooling or free-heating.

**100% outdoor air:** authorizes the opening of the outdoor damper to the 100% with the unit ON and the closing of the damper with the unit OFF. With this setting the ambient temperature probe that improves the outlet temperature control and is mandatory (CU09 display). It is also advisable to control the condensation and evaporation pressures in the indoor unit (expansion card pCOe No.2 (address 8)).

```

CU14a
Summer fcooling and
winter fheating
control: Temperat.
    
```

**Fcooling / fheating control:** this allows selecting the type of free-cooling control in COOLING mode (summer) and HEATING mode (winter):

- Temperat: thermal free-cooling.
- Enthalpy: enthalpic free-cooling.
- Thermoenthal.: thermoenthalpic free-cooling.

```

CU15a
OFF damper in heating
Outl. temp.: < 30.0°C
Ret. temp.: < 15.0°C
Band = 02.0°C
    
```

This display allows controlling the closing of the outdoor air damper in HEATING mode due to low return and/or outlet temperature:

**Outl. temp.:** value of the outlet temperature.

**Ret. temp.:** value of the return temperature.

**Band:** damper control band.

```

CU15b
OFF damper in cooling
Outl. temp.: > 20.0°C
Ret. temp.: > 31.0°C
Band = 02.0°C
    
```

This display allows the closing of the outdoor air damper in COOLING mode due to high return and/or outlet temperature to be controlled:

**Outl. temp.:** value of the outlet temperature.

**Ret. temp.:** value of the return temperature.

**Band:** damper control band.

```

CU16
Config. 4-W val.
4W-val.1:N.O. 2:N.O.
1-2:N.O. 2-2:N.O.
    
```

Selection of the cycle reversing 4-way valve:

**4-way-1 valve:** circuit 1

**4-way-2 valve:** circuit 2 (units with 2 circuits) or circuit 3 (units with 4 circuits)

**4-way-1-2 valve:** circuit 2 (units with 4 circuits)

**4-way-2-2 valve:** circuit 4 (units with 4 circuits)

The direction of activation by default corresponds to COOLING mode (N.O.).

```

Configuration CU17a
Modbus settings
1st Master
Baudrate:      9600
Bit stop:      2
Parity mode:   NO
Timeout:      0300ms
    
```

Settings for the MODBUS MASTER communication of the FIELBUS card, connected on the MPC MEDIUM control.

To return to the main MANUFACTURER display, press . From this display it is possible to access any of the 7 groups of displays in this menu.

## DEFROSTING group of displays

This menu is only available for air-air heat pump units.

```

CD04
Defr. start setpoint
by minimum      2.5b.
Outd.fan ON in defr.
by minimum      240s
    
```

**Defrosting start setpoint by minimum:** setpoint pressure at which the defrosting procedure will be started by minimal pressure. With temperature probe (optional) = -21.0°C

**Out. fan ON in defr. by minimum:** the outdoor fans can be activated on this display during the defrosting procedure if it has been started by minimal pressure or temperature for a maximum period of time set in this parameter.

```

CD05
Defr. by dif. evap.T &
outd.T >=       16°C
If outd.T <=    10°C
Outd.fan ON in defr.
by difer.       120s
    
```

**Defr. by dif. evap.T and outd.T:** difference between the outdoor temperature and the evaporation temperature measured in the outdoor coils so that the defrosting procedure may start whenever the pressure or temperature value has been exceeded (CD09).

**If outd.T <=:** to allow the defrosting by difference between the outdoor temperature and the evaporation temperature, the outdoor temperature should be less than 10°C (by default).

**Out. fan ON in defrosting by diff.:** the outdoor fans can be activated on this display during the defrosting procedure if it has been started by minimum pressure or temperature for a maximum period of time in this parameter.

```

CD06
Defrosting by dif.
Minimum time between
defrost. C1-C2=090 sec
Minimum time between
defrostings= 20 min.
    
```

**Minimum time between defrost. C1-C2:** if the defrosting function is activated if the difference between the temperature measured by the outdoor probe and the evaporation temperature measured in the outdoor coil(s), this is the minimum time between defrosting of different circuits.

**Minimum time between defrostings:** if the defrosting function is activated if the difference between the temperature measured by the outdoor probe and the evaporation temperature measured in the outdoor coil(s), this is the minimum time between defrosting of the same circuit.

```

CD07
Outd. fan ON in defrost.
by min. or by diff.
Out.fan ON set= 35.0b
Out.fan OFF set= 33.0b
OFF if out.T <  -6.0°C
    
```

**Out. fan ON set:** setpoint pressure (or temperature) for connecting the outdoor fans during defrosting.

**Out. fan OFF set:** setpoint pressure (or temperature) for disconnecting the outdoor fans during defrosting.

Note: if the outdoor temperature is less than -6°C it is not permitted to operate the outdoor fans.

```

CD08
Outd.fan ON at defrost
start::         NO
Time outdoor fan ON
                045s
    
```

With these parameters it's possible to adjust the operating of the outdoor fan during the start of the defrosting, in order that during the stop of the compressor in this maneuver, outdoor air continues passing across the coil. This action favors the increase of temperature in the coil, because the outdoor air is to higher temperature.

```

CD09
Defrosting start
setpoint        05.6b.
Defrosting end
setpoint        33.0b.
    
```

**Defrosting start setpoint:** in HEATING mode, this is the evaporation pressure value measured by the outdoor coil probe from which the defrosting function is authorised. With temperature probe (optional) = -5.0°C

**Defrosting end setpoint:** when the temperature measured by the probe reaches this value the defrosting ends. With temperature probe (optional) = 9.0°C

```

CD10
Defrosting times
Initial delay 120 s
Minimum time  001 min
Maximum time  010 min
    
```

**Initial delay:** this is the period that the defrosting demand must remain once the time between defrosting operations has elapsed.

**Minimum time:** minimum duration of defrosting.

**Maximum time:** maximum duration of defrosting.

## COMPRESSORS group of displays

```

CC001
Min. compr. shutdown
time      0180 sec
Min. compr. operation
time      0120 sec
    
```

Min. compr. shutdown time: anti-short-cycle timing of the compressors (by default: 180 seconds).

Min. compr. operation time: the minimum operation time of the compressors must be 120 seconds (not to be modified).

```

CC002
Time between starts
same comp. 0300 sec
Time between starts
diff. comp. 0060 sec
    
```

Time between starts same comp.: this limits the maximum number of starts per hour for each compressor.

Time between starts diff. comp.: this prevents the simultaneous start of the compressors in the unit. This limits the maximum start current of the unit.

```

CC003
Alarm delay low
pressure:  0015 sec
Enabling of the
rotation   YES
Circuits rotation
type:     EQUALIZED
    
```

Alarm delay low pressure: the actuation of the safety of low pressure is not born in mind until they have not passed the time of the starting of the unit or of the opening of the low pressure pressostat (by default 15 seconds).

Enabling of the rotation: this authorises the rotation in the off / on sequence of the compressors in accordance with the number of hours of operating accumulated by each of them.

Circuits rotation type: the type of rotation of the circuits will be:

- Grouped: first there connect all the compressors of the same circuit.
- Equalized (by default): first there connects an alone compressor of every circuit. Once connected all the circuits there connects the second compressor of every circuit.

```

CC004
Low Pres. pressostats
Cancel in wint  NO
Cancel in defr. NO
    
```

This display allows cancelling the low pressure pressostat under the following conditions:

Cancel in WINT.: the low pressure pressostat signal operating in HEATING mode is not taken into account with low outdoor temperatures.

Cancel in DEFROST.: the low pressure pressostat signal during defrosting is not taken into account.

```

CC004a
Compressors
Enable shutdown
before defr.: YES
During:      045 sec
    
```

This display is for authorising the timed shutdown of the compressors at the start and end of the defrosting operation.

```

CC004b
4-way valve
Time before change
and after shutdown
the compr.: 030 sec
    
```

This display is for authorising the timed deactivation of the cycle reversing valve before the shutdown of the compressors. Also after the stop of the unit.

```

CC004c
Compressors
Enable shutdown with
a change W/S: YES
For:          180 sec
    
```

The timed shutdown of compressors is enabled prior to changing the operating mode HEATING (winter) / COOLING (summer). This delay allows to balance pressures in the refrigerating circuit and that do not produce vibrations to themselves in the pipelines.

```

CC05
Disable compr. in
summer fcooling? YES
Outdoor set
Set: 10°C
Set: 80%RH
    
```

With the unit operating in COOLING mode (summer), it is possible to select that the compressor stages are not activated if the free-cooling control is sufficient or in 100% outdoor air units. The following options can be selected on this display:

**Outdoor set:** Setpoint of outdoor temperature, below which the compressors are disabled (by default: 10°C or 80%RH).

**By delta Ref T - Out T:** Ambient T - Outdoor T In units with ambient probe (optional) this difference will be taken into account (14°C by default).

```

CC06
Disable compr. in
winter by outd.T.?
YES
Blocking set: -10.0°C
    
```

**Disable compr. in win. by outd. T?:** if YES is selected, in HEATING mode the compressors will not be activated with a very low outdoor temperature which will save energy.

**Blocking set:** value of the outdoor temperature below which the compressors are disabled. Upon disabling the compressors, both the setpoints and the offset of the support elements will adapt to the absence of the compressors. The recovery compressor is authorized to work.

To return to the main MANUFACTURER display, press . From this display it is possible to access any of the 7 groups of displays in this menu.

## CONTROL CONFIGURATION group of displays

```

CR01
Temperature control
type: P+I
Integration time in
P+I control: 120 sec
    
```

**Temperature control type:**

P = Proportional control.

P+I = Proportional integral control.

**Integration time in P+I control:** time constant for the proportional integral control.

```

CR01a
Type of outlet
control: P+I
Integration time in
P+I control: 120 sec
    
```

**Type of outlet temperature control :**

P = Proportional control.

P+I = Proportional integral control.

**Integration time in control P+I:** time constant for the proportional integral control.

```

CR02
E.heaters, support
in summer? NO
Heat valve, support
in summer? NO
    
```

**Electrical heaters, support in summer?:** authorisation so that the electrical heaters (optional) are activated as support in COOLING mode (summer) to increase the indoor temperature.

**Heat valve, support in summer?:** authorisation to activate the hot water coil as support to increase the indoor temperature.

```

CR03
Indoor fan stop when
stopping the compr.
Summer NO
Winter NO
Without air refreshing
by CO2 probe YES
    
```

**Indoor fan stop when stopping the compr.:** this function allows to select the shutdown of the indoor fan when the setpoint has been reached, in COOLING mode (summer) and HEATING mode (winter).

**Without air refreshing by CO2 sensor:** this function allows to select the shutdown of the indoor fan in units with CO2 probe, when there is no demand of air refreshing, neither of temperature nor of humidity.

```

CR03a
Anti stratification
by indoor fan
On time 000 m
Off time 000 m
    
```

**On time:** this allows selecting the ON time of the indoor fan, when there is no demand of compressor stages, to prevent the stratification of the hot air masses.

**Off time:** this allows selecting the off time of the indoor fan.

```

CR04
Delay shutdown of
indoor fan
Summer:      060 sec
Winter:      060 sec
    
```

Delay shutdown of indoor fan: time during which the indoor fan continues to operate when the unit stops, depending on the season thus preventing moisture in the coil or cooling of the auxiliary heater.

Note: Some sets of units may have electromechanical safety systems built-in that increase the set time by 60 seconds.

```

CR05
Delay of comp. start-up
with ind.fan 030 sec

Delay of comp. start-up
with out.fan 010 sec
    
```

Delay of comp. start-up with ind.fan: minimum time that has to elapse between the start of the indoor fan and the first compressor to guarantee a sufficiently stable flow.

Delay of comp. start-up with out.fan: minimum time that has to elapse between the start of the outdoor fan and the first compressor.

Important: for the start-up of the compressor must join two previous delays (default = 30 + 40 sec.)

```

CR05a
Delay of i.fan start-up
with unit ON 030 sec

Delay of i.fan start-up
with heat mode 000 sec
    
```

Delay of i.fan start-up with unit ON: Delay for the start of the indoor fan in the start up of the unit. In the case of an unit 100% outdoor air, the default value will be 90 seconds to allow the complete opening of the outdoor air damper. In units with plug-fans and TCO terminal, the default value will be 60 seconds to ensure that communication between the two has been established.

Delay of i.fan start-up with heat mode: Delay for the start of the indoor fan in HEATING mode thus preventing currents of cold air. This value must be 0 seconds when there are auxiliary electrical heaters.

```

CR06
Outdoor unit
Condensation control
type:      YES
Times to ON comp.
OFF: 000 s  ON: 120 s
    
```

The condensation control in COOLING mode (summer) is activated on this display for units with axial outdoor fans whether one-speed, two-speed or electronic.

In order for this control to be carried out, the unit must have pressure transducers in the outdoor coils. If the unit includes temperature probes (optional), the condensation pressure control has to be done via on/off pressostats outside of the control.

Times after ON comp.: the control of the fans will not be taken into account until an ON time (120s) of the compressor operation has elapsed.

Note: in water-air unit this realizes the proportional control of the 3-way valve.

```

CR06a
Outdoor unit
Condensation control
Setpoint:  27.0b.
Different.: 08.0b.
Type of control P
Integration time in
P+I control: 120 sec
    
```

If the pressure measured in the outdoor unit is set on the CR06 display for the activation of the condensation control in COOLING mode (summer):

Values by default (bar)	Axial	Centrifugal	Electronic	3-way valve
Setpoint	27	27	27	27
Connection / Disconnection	27 / 19	37 / 27	37 / 27	34 / 27
Differential	8	10	10	7

Also it is possible to select the type of control: proportional (P) or proportional integral (P+I).

```

CR07
Outdoor unit
Evaporation control
type: Fixed
Start time
after ON comp.:120 sec
    
```

The evaporation control in HEATING mode (winter) is activated on this display for units with axial outdoor fans whether one-speed, two-speed or electronic.

In order for this control to be carried out, the unit must have pressure transducers in the outdoor coils.

Times after ON comp.: the control of the fans will not be taken into account until an ON time (120s) of the compressor operation has elapsed.

Note: in water-air unit this realizes the proportional control of the 3-way valve.

```

CR07a
Outdoor unit
Evaporation control
Setpoint: 10.0b.
Different.: 02.0b.
Type of control P
Integration time in
P+I control: 120 sec
    
```

If the pressure measured in the outdoor unit is set on the CR07 display for the activation of the

Values by default (bar)	Axial	Centrifugal	Electronic	3-way valve
Setpoint	10	10	10	10
Connection / Disconnection	10 / 12	8 / 10	8 / 10	6 / 10
Differential	2	2	2	4

Also it is possible to select the type of control: proportional (P) or proportional integral (P+I).

```

CR07b
Indoor unit
Condensation control
type: YES
Times to ON comp.
ON: 030 s
    
```

The condensation control in HEATING mode (winter) is activated on this display for units with indoor fans: electronic plug-fan or centrifugal with damper. In order for this control to be carried out, the unit must have pressure or temperature sensors in the indoor coils (expansion card pCOe No.2)

Times after ON comp.: the control of the fans will not be taken into account until an ON time (30s) of the compressor operation has elapsed.

```

CR07c
Indoor unit
Condensation control
Setpoint: 27.0b.
Different.: 08.0b.
Type of control P
Integration time in
P+I control: 120 sec
    
```

If condensation control in HEATING mode (winter) is activated on the previous display (CR07b), on this display, it is possible to set both the setpoint value and the differential for the activation.

Also it is possible to select the type of control: proportional (P) or proportional integral (P+I).

```

CR07d
Indoor unit
Evaporation control
type: YES
Start time
after ON comp.: 030 sec
    
```

The evaporation control in COOLING mode (summer) is activated on this display for units with indoor fans: electronic plug-fan or centrifugal with damper. In order for this control to be carried out, the unit must have pressure or temperature sensors in the indoor coils (expansion card pCOe No.2)

Start time after ON comp.: the control of the fans will not be taken into account until an ON time (30s) of the compressor operation has elapsed.

```

CR07e
Indoor unit
Evaporation control
Setpoint: 10.5b.
Different.: 01.5b.
Type of control P
Integration time in
P+I control: 120 sec
    
```

If evaporation control in COOLING mode (summer) is activated on the previous display (CR07d), on this display, it is possible to set both the setpoint value and the differential for the activation. Also it is possible to select the type of control: proportional (P) or proportional integral (P+I).

```

CR08
Timing OFF
outdoor fan
COOLING mode: 300 sec
HEATING mode: 300 sec
    
```

On this display, the disconnection of the outdoor fans is timed to the stopping of the compressor in 60 seconds both in COOLING mode (to reduce the condensation pressure) and HEATING mode (to remove ice from the coil).

```

CR09
Enter new
manufacturer password
*****
    
```

This allows modifying the password to the MANUFACTURER group of displays.

To return to the main MANUFACTURER display, press . From this display it is possible to access any of the 7 groups of displays in this menu.

## SAFETY CONFIGURATION group of displays

```

CS01
Anti-fire safety
Set:      60.0°C
Differ.:  20.0°C
Damper status during
failure:  OPEN
    
```

**Anti-fire safety:** when the return air temperature exceeds a safety value the anti-fire safety device will be activated (60°C by default) and the unit will stop. It will not return to operation until the temperature has dropped to below 40°C (60°C setpoint - 20°C differential).

**Damper status during failure:** in units with outdoor air damper it is possible to select the damper position in the event of an anti-fire alarm. This parameter will also be used to determine the damper position if the unit includes a smoke detector (optional).

```

CS01a
Anti-fire safety
french ERP:  N

Damper status during
failure: OPEN
Delay shutdown ind.fan
with resist.:120 se9
    
```

This display allows to select the operating logic to comply with the French regulations on Fire safety (ERP). This regulation obligates the following:

- In case of failure of the thermal protection of the indoor fan, this fan and all components are stopped, the outdoor air damper is open to 100% (return air damper closed). Manual reset.
- In case of failure of the thermal protection of the electrical heaters, all components are stopped and the indoor fan after 120 seconds, the outdoor air damper is open to 100% (return air damper closed). Manual reset.

```

CS02
Anti-freeze safety
in water-air units
initial value:-02.0°C
different.:  08.0°C
    
```

This safety device is started if, after 120 seconds of operation by the compressor working in HEATING mode, the refrigerant temperature is lower than -2°C (early alarm). If this temperature does not exceed -1°C after 90 seconds the compressor stops.

Once the minimum OFF time of the compressor has elapsed, if the refrigerant temperature is greater than 6°C (-2°C + 8°C differential), the compressor can once again be started. Otherwise, the refrigerant anti-freeze alarm is considered and it will be manually reset. If the refrigerant temperature is less than -5°C after the compressor has been operating for 120 seconds, the compressor is stopped and directly, and without delay, the refrigerant anti-freeze alarm is considered.

If 10 early anti-freeze alarms ( $T^a < -2^{\circ}\text{C}$ ) are triggered in less than 120 seconds these will also be considered as a refrigerant anti-freeze alarm.

Note: If 10 alarms are triggered in less than 24 hours the water-air unit is blocked by the anti-freeze alarm.

```

CS03
High outlet temp.
safety

Outlet set:  45.0°C
Offset:      10.0°C
Differ.:     02.0°C
    
```

This display appears if the electrical heater or gas burner has been selected. When the outlet air temperature safety set of 55°C (set outlet + offset) is exceeded this option will be shut down and will not be reconnected until this temperature drops below 53°C (outlet set + offset - differential).

```

CS04
High/low indoor T.
set in summer
High      40.0°C
Low       15.0°C
    
```

Limits of indoor (return or ambient) temperature for indication of alarm due to high or low temperature, in COOLING mode (only indication).

Note: the delay of this alarm is fixed in CS06.

```

CS05
High/low indoor T.
set in winter
High      40.0°C
Low       15.0°C
    
```

Limits of indoor (return or ambient) temperature for indication of alarm due to high or low temperature, in HEATING mode (only indication).

Note: the delay of this alarm is fixed in CS06.



CS06

```
Alarm delay for
low/high indoor
temp.      030 min.
```

Time that must elapse before the signalling of the alarm due to high or low return temperature.

CS07

```
Alarm delay for
connection of the
pLAN T and/or RH probe
          030 sec
```

When reading the temperature or humidity probe through the pLAN, there is a delay due to data transmission. This delay is configured in this parameter to avoid false alarms.

CS08

```
Alarm delay
thermal indoor
fan:      000 sec
Water flow
switch:   030 sec
Enable in HEAT
```

The anti-blocking alarm completely stops the unit.

**Thermal indoor fan:** safety elements such as the thermal relay for the indoor fan (RTVI) and a differential air pressostat (PDA) can be connected into the input of this alarm. Since the indoor fan takes time to start and provide sufficient flow to activate the PDA, a delay is usually assigned to avoid the alarm during the start. When the PDA has been selected (optional), a value of 30 seconds must be selected to avoid the failure of the pressostat during the fan start.

**Water flow switch:** in water-air units, this digital input has been configured to connect the water flow switch. Its actuation is taken into account only when the circulation pump (which will be connected on the output of the outdoor fan) functions for longer than 30 seconds (value modifiable by parameter) and the digital input is open for more than 5 seconds. Its actuation causes the unit to stop. Automatic reset.

**Enable in:** flow switch only in HEATING mode (by default) or in HEATING & COOLING modes.

CS08a

```
Enabling warning high
rpm in plug.fan: Y
delay warning: 030min
(only indication)
Max.speed fan1:1700rpm
Max.speed fan2:1700rpm
```

This display allows to enable that the pGD1 terminal shows a warning message when a plug-fan exceed the maximum permissible speed for a period of time longer than 30 minutes (by default).

It is also possible to select in addition to the warning (indication only) causing the unit to stop (unit OFF).

**Max.speed fan1:** maximum speed of the supply plug-fan.

**Max.speed fan2:** maximum speed of the return plug-fan

CS08b

```
Configuration
Clogged filter alarm
(only indication)
```

This display allows to select the configuration for the clogged filter alarm: only indication or unit off.

CS09

```
Gas Detector No.001
Alarm setP: 00000PPM
Al.set Percent: 000%
Alarm delay: 00min
```

Gas concentration in ppm and % in order that the alarm of the leak detector is activated. This delay is configured on this display to avoid false alarms.

```

CS10
Gas Detector No.001

Disable buzzer during
alarm condition: 05min

Del. MB Offline:00030s
    
```

It is possible to disable the audible alarm (buzzer) of the leak detector when a period of time has elapsed since the activation of the same.

This display also configures a delay in Modbus communication failures to prevent false alarms.

```

CS11
Set Prot. elect. heat.
for low outdoor temp.

H.W.C. Piping: 04.0°C
SUP. comp CH: -08.0°C
Outd. damper: -12.0°C
El.Panel 2st: -16.0°C
    
```

With GREAT COLD option for protection to low outdoor temperatures, the setpoints for activation of the electrical heaters are set on this display:

- H.W.C. Piping: electrical heaters around the pipes of the hot water coil circuit (HWC)
- SUP. comp. CH: supplementary crankcase heater and electrical heater for protection of the electric panel (1<sup>st</sup> stage)
- Outd. damper: electrical heater for protection of outdoor dampers.
- El.Panel 2st: electrical heater for protection of the electric panel (2<sup>nd</sup> stage).

```

CS12
Low Pressure safety
by pressure sensor
initial value:2.0 bar
end value: 4.0 bar
    
```

Additional safety to the low pressostat carried out using the pressure sensor in the outdoor coil and the unit operating in HEATING mode.

```

CS13
Power limitation
tandem comp. by high
pressure: N
init. value: 41.5 bar
end value: 36.5 bar
    
```

In units equipped with tandem compressors, operating in COOLING mode, when the outdoor coil pressure of a circuit overcomes a limit value (41,5 bar by default), one of the two compressors will be stopped, thereby avoiding the stop of both compressors due to the high pressure.

This compressor will start working again when the pressure drops below 36,5 bar.

To return to the main MANUFACTURER display, press . From this display it is possible to access any of the 7 groups of displays in this menu.

## ALARMS CONFIGURATION group of displays

```

CA01
Alarm management
Buzzer siren: 0002 s
Alarm relay: Normal
'PrG'
Management with active
alarm on display: NO
    
```

Buzzer siren: unavailable.

Alarm relay: if the digital output NO7 is used for remote alarm (connector J14). With "normal" value it is activated when there is an alarm and it does not disappear until resetting.

Active alarm on display: this parameter allows to select that the alarm relay stays on while some active alarm exists in the terminal.

'PrG': from this alarm management display when pressing key  access is given to a display with additional information.

```

CA02
Selection of alarms
THE:Y HP:Y LP:Y
DEF:Y HT:Y LT:Y
CON:Y DP:Y 'PrG'
    
```

Selection of alarms: on this display, the alarms that could activate a remote alarm relay can be selected (contact NO7, connector J14):

THE: Thermal                      HP: High pressure                      LP: Low pressure                      DEF: Defrost

HT: High temperature                      LT: Low temperature                      CON: Counters                      DP: Disconnected probes

'PrG': from this alarm selection display when pressing key , access is given to a display with additional information.

```

CA03
Selection of alarms
ICE:Y INT:Y KLD:Y
FIL:Y EPR:Y CLK:Y
SP: Y 'Prg'
    
```

**Selection of alarms:** on this display, the other alarms that could activate a remote alarm relay can be selected (contact NO7, connector J14):

ICE: Anti-freeze HWC    INT: RTVI / flow switch    KLD: Compr. discharge    FIL: Clogged filter  
 EPR: Eprom not OK    CLD: Clock    SP: Setpoint W / S

'Prg': from this alarm selection display when pressing key , access is given to a display with additional information.

```

CA04
Enable manual rearm.
high pressure alarm:
                  YES
04 alarms in 0030 min
for manual rearm.
    
```

This safety has automatic rearmament, but it's possible to be defined as manual rearmament when a number of alarms take place (by default: 4) in a period of time (by default: 30 minutes).

```

CA05
Enable manual rearm.
low pressure alarm:
                  YES
04 alarms in 0030 min
for manual rearm.
    
```

This safety has automatic rearmament, but it's possible to be defined as manual rearmament when a number of alarms take place (by default: 4) in a period of time (by default: 30 minutes).

```

CA06
Enable manual rearm.
thermal comp. and
outdoor fan alarm: YES
04 alarms in 0030 min
for manual rearm.
    
```

This safety has automatic rearmament, but it's possible to be defined as manual rearmament when a number of alarms take place (by default: 4) in a period of time (by default: 30 minutes).

```

CA07
Enable manual rearm.
electrical heating
termistor:          YES
04 alarms in 0030 min
for manual rearm.
    
```

This safety has automatic rearmament, but it's possible to be defined as manual rearmament when a number of alarms take place (by default: 4) in a period of time (by default: 30 minutes).

To return to the main MANUFACTURER display, press . From this display it is possible to access any of the 7 groups of displays in this menu.

## UNIT INITIALISATION group of displays



```

IU01

Select language
ENGLISH
    
```

On this display, it is possible to select the language in which the unit pGD1 terminal will operate. The software is installed in English (EN), by default, and in another language requested by the client.

The languages availables are: Spanish (SP), French (FR), Italian (IT), Turkish (TR) and German (GR).

The change between the two languages is done by simultaneously pressing the keys  + 

```

IU02
LOGOTYPE TYPE
  CIAT
  
```

On this display select the logotype that appears on the terminal start display.

```

Inicialization IU03
DEFAULT INSTALLATION
Erase user settings
and install global: NO
  
```

Selecting «YES» for this values reprograms the board and loads the default values for the configuration parameters. Once this operation has been carried out «NO» must be selected again and it must be verified that these values are acceptable for the unit. If not, they will have to be modified accordingly.

```

Inicialization IU04
Test settings
installation: NO
Normal settings
installation: NO
  
```

Test settings installation: if «YES» is selected, the compressor and defrosting timings for testing the unit are modified:

- Minimum compressor OFF time: it goes from 180 seconds to 18 seconds.
- Minimum time between 2 compressor ONs: it goes from 300 seconds to 30 seconds.
- Minimum compressor ON time: it goes from 120 seconds to 12 seconds.
- Delay time for low pressure failure: it goes from 60 seconds to 0 seconds.
- Maximum time between defrosting operations: it goes from 40 minutes to 5 minutes.
- Minimum time between defrosting operations: it goes from 20 minutes to 5 minutes.
- Time between defrosting operations by differ. between outdoor T & evaporation T: from 10 to 5 min.
- Time between defrosting operations in different circuits: it goes from 90 seconds to 10 seconds.
- Delay in the defrosting start: it goes from 120 seconds to 10 seconds.
- Time with minimum outdoor damper opening to enable the operation of the recovery compressor: it goes from 90 seconds to 10 seconds.
- Min. outdoor damper opening to enable the operation of the recovery compressor: from 10% to 0%.
- Outdoor fan time at maximum speed when starting the compressor with condensation control: from 120 seconds to 30 seconds.
- Outdoor fan time at maximum speed when starting the compressor with evaporation control: from 120 seconds to 30 seconds.
- Setpoint to enable the electrical heaters due to outdoor T: it goes from 20°C to 40°C.

Normal settings installation: selecting «YES» for this value, the normal timing of the unit are restored.

```

Inicialization IU05
Erased of the entire
alarm record? NO
U:01
  
```

From here the alarm log can be deleted.



```

Inicialization IU06
CHANGE PASSWORDS
Manufacturer ****
User ****
Maintenance ****
  
```

On this display it is possible to change the passwords of the three groups of displays in the TECHNICAL MENU which require password access.

## 25.3. MAINTENANCE displays

The group of user displays is protected by an access password. If the password has to be known: consult.

By pressing the   keys, each of the following displays can be seen.

```

PA00
Enter maintenance
password          ****
    
```

Once the password has been entered, it is possible to access the other MAINTENANCE displays by pressing .

```

Maintenance Menu
INPUTS/OUTPUTS:  →
Counters:
Alarm record:
    
```

The MAINTENANCE displays are divided into three groups to which access is possible from this display.

### INPUTS/OUTPUTS group of displays

```

A0
Winter/summer select.
'automat.' +
      by out.T.
      WINTER
SUM. if out.T > 22.0°C
WIN. if out.T < 20.0°C
Enable lock:  N
    
```

This display allows to select the switching mode to change the HEATING/COOLING operating mode just as well as in the FC01 display.

When «Enable lock» is selected (YES), the FC01 display is blocked, in order that the final user cannot change it.

```

Ind Fan Ebmpapst A00
Dev.offline Addr:001
Type speed control
CLOSED LOOP SENSOR CTR
Set HEAT: 12000m3/h
Set COOL: 12000m3/h
Set VENTIL.: 12000m3/h
    
```

On this display, it is possible to select the type of speed control for indoor (supply) radial plug-fans:

- CLOSED LOOP SENSOR CTR (constant flow control, by default): in this case it is possible to fix the setpoint of flow in COOLING, HEATING and VENTILATION mode.
- OPEN LOOP PWM CTR (PWM control 0...100%): in this case it is possible to fix the percentage of speed modulation in COOLING, HEATING and VENTILATION mode.

```

Ind Fan Ebmpapst A00a
Dev.offline Addr:001
Type actual control
CLOSED LOOP SENSOR CTR
Set VENTIL.: 12000m3/h
Current flow: 00000m3/h
Current speed: 0000rpm
    
```

This display shows the current fan speed for supply radial plug-fans.

- With constant flow control (CLOSED LOOP SENSOR CTR) also the selected setpoint (it can be the COOLING, HEATING or VENTILATION setpoint) and the current flow are visualized.
- With PWM control (OPEN LOOP PWM CTR) also the selected percentage of speed modulation (it can be the COOLING, HEATING or VENTILATION percentage) and the current percentage of speed modulation are displayed.

```

Ind Fan Ebmpapst A00f
Dev.offline Addr:001
Max. speed: 0000rpm
Ramp-up time: 00005s
Ramp-down time: 00005s
    
```

This display shows the maximum fan speed allowed for supply radial plug-fans, as well as the ramp-up and ramp down times.

```

Ind Fan Ebmpapst A00e
Dev.offline Addr:001
Pressure diff. probe
Current value: 00.0V

Alarm value: 01.0V
Alarm time: 030s
    
```

This display shows the current value measured by the air pressure differential sensor connected on the fan (0...10dc).

After the start of the outlet plug-fan, if it exceeds a period of time (30 seconds) without the reading of a minimum value of voltage of the differential pressure sensor of air (0.1 V), the control displays flow failure alarm and all the unit stops.

```

Ind Fan Ebmpapst A00g
Dev.offline Addr:001
Pressure diff. probe

Min limit: 00000Pa
Max limit: 01000Pa

Current value: 00000Pa
    
```

This display shows the current value (Pa) measured by the air pressure differential sensor connected on the fan, as well as the maximum and minimum limits of this sensor.

```

Ind Fan Ebmpapst A00h
0..10V OUTPUT Addr:001
Output function: SPEED
Value coord. X1: 003%
Value coord. Y1:00.0V
Value coord. X2: 100%
Value coord. Y2:09.5V
Load: N Reboot: N
    
```

This display allows to configure the analog output of the master plug-fan that provides the 0...10V running signal to the slaves fans. The available parameters are:

Output function: PWM or SPEED (default value that allows the spin of the slave fan at the same speed as the master).

Value coord. X1: 003% (minimum percentage of the master).

Value coord. Y1: 00.0V (minimum output analog to the slave).

Value coord. X2: 100% (maximum percentage of the master).

Value coord. Y2: 09.5V (maximum output analog to the slave that by default is equal to 9.5V to limit the noise level).

Load: N (load of the values modified in the fan).

Reboot: N (restart of the fan to take correctly the modified values).

```

Ret Fan Ebmpapst A00i
Dev.offline Addr:002
Type speed control
CLOSED LOOP SENSOR CTR

Set HEAT: 12000m3/h
Set COOL: 12000m3/h
Set VENTIL.: 12000m3/h
    
```

On this display, it is possible to select the type of speed control for return radial plug-fans (optional):

- CLOSED LOOP SENSOR CTR (constant flow control, by default): in this case it is possible to fix the setpoint of flow in COOLING, HEATING and VENTILATION mode.

- OPEN LOOP PWM CTR (PWM control 0...100%): in this case it is possible to fix the percentage of speed modulation in COOLING, HEATING and VENTILATION mode.

```

Ret Fan Ebmpapst A00ja
Dev.offline Addr:002
Type actual control
CLOSED LOOP SENSOR CTR

Set VENTIL.: 12000m3/h
Current flow: 00000m3/h
Current speed: 0000rpm
    
```

This display shows the current fan speed for return radial plug-fans.

- With constant flow control (CLOSED LOOP SENSOR CTR) also the selected setpoint (it can be the COOLING, HEATING or VENTILATION setpoint) and the current flow are visualized.

- With PWM control (OPEN LOOP PWM CTR) also the selected percentage of speed modulation (it can be the COOLING, HEATING or VENTILATION percentage) and the current percentage of speed modulation.

```

Ret Fan Ebmpapst A00if
Dev.offline Addr:002

Max. speed: 0000rpm

RAMP-up time: 00005s
RAMP-down time: 00005s
    
```

This display shows the maximum fan speed allowed for return radial plug-fans, as well as the ramp-up and ramp down times.

```
Ret. Fan Ebmpapst. A001e
Dev.offline Addr:002
Pressure diff. probe
actual value:: 00.00

Min limit: 00000Pa
Max limit: 01000Pa
Current value: 00000Pa
```

This display shows the current value measured by the air pressure differential sensor connected on the fan (0...10dc), as well as the maximum and minimum limits of this sensor, and the current value (Pa).

```
Ret. Fan Ebmpapst. A001g
Dev.offline Addr:002
Pressure diff. probe

Min limit: 00000Pa
Max limit: 01000Pa

Current value: 00000Pa
```

This display shows the current value (Pa) measured by the air pressure differential sensor connected on the fan, as well as the maximum and minimum limits of this sensor.

```
Ret. Fan Ebmpapst. A001h
0...10V OUTPUT Addr:002
Output function: SPEED
Value coord. X1: 003%
Value coord. Y1: 00.00V
Value coord. X2: 100%
Value coord. Y2: 09.5V
Load: N Reboot: N
```

This display allows to configure the analog output of the master plug-fan that provides the 0...10V running signal to the slaves fans. The available parameters are:

Output function: PWM or SPEED (default value that allows the spin of the slave fan at the same speed as the master).

Value coord. X1: 003% (minimum percentage of the master).

Value coord. Y1: 00.00V (minimum output analog to the slave).

Value coord. X2: 100% (maximum percentage of the master).

Value coord. Y2: 09.5V (maximum output analog to the slave that by default is equal to 9.5V to limit the noise level).

Load: N (load of the values modified in the fan).

Reboot: N (restart of the fan to take correctly the modified values).

```
A20
VFD No.001
Type speed control
CLOSED LOOP SENSOR CTR
--- UDF off ---
Nom. flow: 12000m3/h
Pda1=0125 Vel. p1=0592
Pda2=0600 Vel. p2=0962
```

On this display, it is possible to select the type of speed control for indoor (supply) centrifugal fans + VFD:

- CLOSED LOOP SENSOR CTR (constant flow control, by default): in this case it is possible to fix the flow setpoint, maximum point of differential pressure of the indoor fan (pda1), minimum point of rpm (vel.p1), minimum point of differential pressure (pda2) and maximum point of rpm (vel.p2).

- OPEN LOOP PWM CTR (PWM control 0...100%): in this case it is possible to fix the percentage of speed modulation in COOLING, HEATING and VENTILATION mode.

- PANEL control: Manual control from the panel of the variable frequency drive.

```
A20a
VFD No.001
Type speed control
CLOSED LOOP SENSOR CTR
Nom. flow: 12000m3/h
Air dif.pres: 0000 Pa
Motor speed: 0000rpm
Fan speed: 0000rpm
```

This display shows the type of variable frequency drive and the following parameters:

- CLOSED LOOP SENSOR CTR (constant flow control, by default): flow setpoint, read differential pressure, read speed of the motor fan and calculated speed of the indoor fan.

- OPEN LOOP PWM CTR (PWM control 0...100%): the selected percentage of speed modulation (it can be the COOLING, HEATING or VENTILATION percentage) read frequency of the indoor fan, read speed of the motor fan and calculated speed of the indoor fan.

- PANEL control: read speed of the motor fan and calculated speed of the indoor fan.

```
A20f
VFD No.001
Min sett. AI1: 0125.0
Max sett. AI1: 0600.0
Min frequency: 030.2Hz
Max frequency: 049.1Hz
Accel.time: 0005.0s
Decel.time: 0005.0s
```

This display shows the minimum and maximum settings allowed for the analog input A1, maximum and minimum values of frequency of the drive as well as times of acceleration and deceleration of the same.

```

A20b
UFD No.001
Status:      Not ready
Run:         Stop
Direction:   -->
Alarms:      No alarms
Speed status: -
    
```

This display shows: status, run, direction of rotation, alarms and speed status of the variable frequency drive of the indoor fan.

```

A20c
UFD No.001
Request:     000.0%
Feedback:    00.0Hz
Input AI1:   000.0
Dissip.temp.: 000.0°C
DC voltage:  0000V
    
```

This display shows: request, feedback, analog input AI1, dissipation temperature and DC voltage of the variable frequency drive of the indoor fan.

```

A20d
UFD No.001
Motor data
Speed:       0000rpm
Voltage:     000.0V
Current:     00.0A
Torque:      000.0%
Power:       000.0%
    
```

This display shows the motor data: speed, voltage, current, torque and power.

```

A20e
UFD No.001
Diff. Pressure Probe
Current value: 000.0

Min limit:    00000Pa
Max limit:    01000Pa
Current value: 00000Pa
    
```

This display shows the current value of the differential pressure sensor and it's possible to adjust the minimum and maximum values of the same.

```

A20f
UFD No.002
Type speed control
CLOSED LOOP SENSOR CTR
--- UDF off ---
Nom. flow:    12000m3/h
Pda1=0125 Vel. p1=0592
Pda2=0600 Vel. p2=0962
    
```

On this display, it is possible to select the type of speed control for return centrifugal fans + VFD (optional):

- CLOSED LOOP SENSOR CTR (constant flow control, by default): in this case it is possible to fix the flow setpoint, minimum point of differential pressure of the return fan (pda1), minimum point of rpm (vel.p1), minimum point of differential pressure (pda2) and maximum point of rpm (vel.p2).
- OPEN LOOP PWM CTR (PWM control 0...100%): in this case it is possible to fix the percentage of speed modulation in COOLING, HEATING and VENTILATION mode.
- PANEL control: Manual control from the panel of the variable frequency drive.

```

A201a
UFD No.002
Type speed control
CLOSED LOOP SENSOR CTR
Nom. flow:    12000m3/h
Air dif.pres: 0000 Pa
Motor speed:  0000rpm
Fan speed:    0000rpm
    
```

This display shows the type of variable frequency drive and the following parameters:

- CLOSED LOOP SENSOR CTR (constant flow control, by default): flow setpoint, read differential pressure, read speed of the motor fan and calculated speed of the return fan.
- OPEN LOOP PWM CTR (PWM control 0...100%): the selected percentage of speed modulation (it can be the COOLING, HEATING or VENTILATION percentage) read frequency of the return fan, read speed of the motor fan and calculated speed of the return fan.
- PANEL control: read speed of the motor fan and calculated speed of the return fan.

```

A201f
UFD No.002
Min sett. AI1: 0125.0
Max sett. AI1: 0600.0
Min frequency: 030.2Hz
Max frequency: 049.1Hz
Accel.time:    0005.0s
Decel.time:    0005.0s
    
```

This display shows the minimum and maximum settings allowed for the analog input A1, maximum and minimum values of frequency of the drive as well as times of acceleration and deceleration of the same.



```

A201b
UFD No.002
Status:      Not ready
Run:         Stop
Direction:   -->
Alarms:      No alarms
Speed status: -
    
```

This display shows: status, run, direction of rotation, alarms and speed status of the variable frequency drive of the return fan.

```

A201c
UFD No.002
Request:     000.0%
Feedback:    00.0Hz
Input AI1:   000.0
Dissip.temp.: 000.0°C
DC voltage:  0000V
    
```

This display shows: request, feedback, analog input AI1, dissipation temperature and DC voltage of the variable frequency drive of the return fan.

```

A201d
UFD No.002
Motor data
Speed:       0000rpm
Voltage:     000.0V
Current:     00.0A
Torque:      000.0%
Power:       000.0%
    
```

This display shows the motor data: speed, voltage, current, torque and power.

```

A201e
UFD No.002
Diff. Pressure probe
Current value: 000.0

Min limit:    00000Pa
Max limit:    01000Pa
Current value: 00000Pa
    
```

This display shows the current value of the differential pressure sensor and it's possible to adjust the minimum and maximum values of the same.

```

FABRIC DUCT A002b
Control enabled to
fabric duct: YES

Inflated perc.: 35.0 %
Inflated time:  020 s
    
```

For units with centrifugal fan + variable frequency drive (VFD) or plug-fans is enabled, by default, an special control of the start-up for facilities with fabric ducts that prolongs the set time.

**Inflated perc.:** % of flow for start-up of the fan with fabric ducts.

**Inflated time:** timing of the flow reduction to the start-up of the fan.

```

OVERPRESSURE A002
Out1 flow: 12000m3/h
Ret. flow: 09200m3/h
Overpressure: 23.3%
Cte overpressure:01.0
Outdoor damper: 040.0%
Extrac. damper: 016.7%
    
```

This display shows the next data:

**Out1 flow:** with supply radial plug-fans displays the measured value. With another type of fan, the flow has a fixed value that can be modified on this display.

**Ret. flow:** with return radial plug-fans (optional) displays the measured value. With another type of fan, the the flow has a fixed value that can be modified on this display.

**Overpressure:** value calculated from the supply flow and the return flow.

**Cte overpressure:** parameter that multiplies the value of overpressure, whose result is subtracted to the signal of the outdoor air damper opening. This constant allows to adjust the opening of the extraction damper on site.

Parameter that it multiplies to the value of overpressure, which result is reduced to the sign of opening of the outdoor air damper. This constant allows to fit in the installation the opening of the extraction damper.

**Outdoor damper:** outdoor air damper opening signal (calculated on A11 display).

**Extrac. damper:** extraction air damper opening signal:

$$\text{Extrac. damper opening} = \text{Outdoor damper opening} - (\text{overpressure} * \text{cte overpressure})$$

```

OVERPRESSURE A002a
Outl. flow: 12000m3/h
Ret. flow: 09200m3/h
Cal. refreshing: 40%
Ref. flow: 04800m3/h
Ext. flow: 02000m3/h
    
```

This display shows the next data:

**Outl. flow:** displays the outlet flow.

**Ret. flow:** displays the return flow.

**Cal. refreshing:** value calculated from the outdoor, return and mixing temperatures (this value is also displayed on the A11 display).

**Ref. flow:** value calculated from the outlet flow and the refreshing from the outdoor, return and mixing temperatures.

**Ext. flow:** value calculated for the extraction flow from the outlet, return and refreshing flows, discharge, return and refreshing, being its value equal to:

$$\text{Extraction flow} = \text{refreshing flow} - (\text{outlet flow} - \text{return flow})$$

```

PLUG-FAN FLOW A002c
Outl. flow: 12000m3/h
Ret. flow: 09200m3/h
Cal. refreshing: 40%
Ref. flow: 04800m3/h
Ext. flow: 02000m3/h
    
```

This display shows the next data:

**Outl. flow:** outlet flow (value measured or set by parameter).

**Ret. flow:** return flow (value measured or set by parameter).

**Cal. refreshing:** displays the actual percentage of refreshing.

**Ref. flow:** displays the refreshing flow.

**Ext. flow:** displays the extraction flow.

```

A002d
Air humidity probes
Ind. RH probe N
Outd. RH probe N
    
```

This display allows configuration of humidity probes of the unit as in the CU10 display of the Constructor menu.

**Ind. RH probe:** No, actual, virtual, pLAN, RS485. This probe is necessary for enthalpic free-cooling and/or humidity control. The installation of this probe in the field-bus RS485 allows the installation of air quality probe + mixing probe in units with mixing box (see CU11).

**Outdoor RH probe:** (with enthalpic free-cooling) no, actual, pLAN.

Note: In a pLAN formed by µPC MEDIUM boards, a "master" board can share the outdoor relative humidity of the "master" board (outdoor humidity probe).

```

A002e
Summer fcooling and
winter fheating
control: Temperat.
    
```

This display allows configuration of free-cooling as in the CU14a display of the Constructor menu.

**Fcooling / fheating control:** this allows selecting the type of free-cooling control in COOLING mode (summer) and HEATING mode (winter):

- Temperat: thermal free-cooling.
- Enthalpy: enthalpic free-cooling.
- Thermoenthal.: thermoenthalpic free-cooling.

```

A002f
Ambient Probe: YES
Control by ambient T.
Amb. probe type: 2rs485
Cal. amb. T. COLD: AVERAG
Cal. amb. T. HEAT: AVERAG
    
```

This display allows to configure the ambient probe just as well as in the CU09 display of the Manufacturer Menu.

**Ambient Probe:** the ambient probe improves the outlet temperature control.

**Control by:** with this parameter it is possible to control the setpoint by means of the ambient temperature probe (standard) or the return temperature probe (optional).

**Amb. Probe type:** There are different options for the ambient probe:

- NTC (by default): one ambient probe installed on the analogue input B5 (if the unit does not incorporate outdoor humidity probe). The max. distance of the NTC sensor to the control board can be 30 metres.
- 4-20mA: one ambient probe installed on the analogue input B5 (if the unit does not incorporate outdoor humidity probe).
- RS485: one to four ambient probes connected to the Field-bus on the µPC MEDIUM board using RS485 serial communication card(s).

- pLAN: one ambient probe installed on the master unit of a pLAN network.

Note: the CU12b display allows to select that the control of the ambient temperature will be done by means of the ambient probe installed on the TCO terminal (optional).

Cal. amb. T. COOL/HEAT: if the unit incorporates two ambient probes, in COOLING and HEATING mode, the display will use the measured value: minimum, maximum, or the average of all values.

Displayed if the air quality probe (optional) is enabled on the display CU11. This display allows the probe to be calibrated in the event of a reading error.

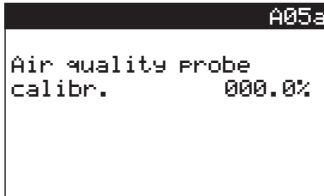

This display allows the return temperature and outdoor air probe to be calibrated in the event of a reading error.

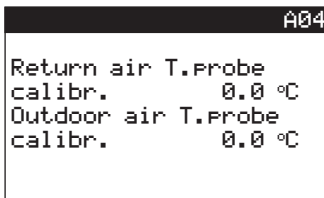

This display allows the ambient temperature probe to be calibrated in the event of a reading error.

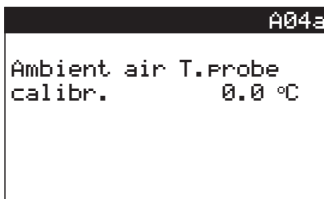

This display allows the TCO thermostat temperature probe to be calibrated (if it has been activated on the CU12b display), in the event of a reading error.

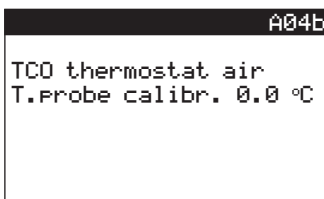

This display allows the outlet temperature probe to be calibrated in the event of a reading error.

If the mixing air probe has been enabled (optional) on the CU11 display, this display could also be used for calibration.

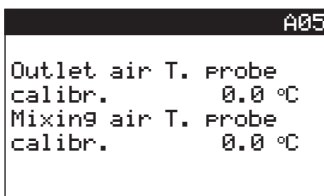

Displayed if the unit is equipped with the GREAT COLD option (expansion card pCOe No.2 (address 8). This display allows calibrating the probes of the hot water coil (optional).

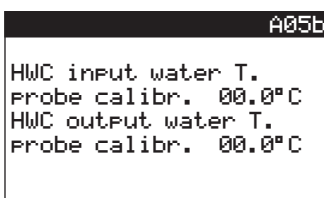

A06

```
Outdoor unit 1 sensor
calibr.      0.0b
Outdoor unit 2 sensor
calibr.      0.0b
```

Displayed if the unit is configured as HEAT PUMP. This display allows calibrating the outdoor coil sensor (or water-air anti-freeze safety) for circuits 1 and 2 in the event of a reading error.

Note: these sensors can be configured in the CU12 display as pressure transducers (by default) or as temperature probes.

A06a

```
Outdoor unit 3 sensor
calibr.      0.0b
Outdoor unit 4 sensor
calibr.      0.0b
```

Displayed if the unit is configured as HEAT PUMP. This display allows calibrating the outdoor coil sensor (or water-air anti-freeze safety) for circuits 3 and 4 in the event of a reading error.

Note: these sensors can be configured in the CU12 display as pressure transducers (by default) or as temperature probes.

A06b

```
Indoor unit 1 sensor
calibr.      0.0b
Indoor unit 2 sensor
calibr.      0.0b
```

This display allows calibrating the indoor coil sensor for circuits 1 and 2 in the event of a reading error (connected in the expansion card pCOe No.2).

Note: these sensors can be configured in the CU12 display as pressure transducers (by default) or as temperature probes.

A06c

```
Indoor unit 3 sensor
calibr.      0.0b
Indoor unit 4 sensor
calibr.      0.0b
```

This display allows calibrating the indoor coil sensor for circuits 3 and 4 in the event of a reading error (connected in the expansion card pCOe No.2).

Note: these sensors can be configured in the CU12 display as pressure transducers (by default) or as temperature probes.

A06d

```
Serial Probe No.01
Temperature
Adj:00.0 Prb: 000.0°C
```

Displayed if a serial probe of temperature is enabled. This display allows calibrating this probe, in the event of a reading error.

A06e

```
Serial Probe No.01
Temperature: 000.0°C
Humidity:    00.0%
Dew Point:   000.0°C
```

Displayed if a serial probe of humidity is enabled. This display allows calibrating this probe, in the event of a reading error.

A06f

```
Serial Probe No.02
Temperature
Adj:00.0 Prb: 000.0°C
```

Displayed if the second serial probe of temperature is enabled. This display allows calibrating this probe, in the event of a reading error.

```

A069
Serial Probe No.02
Temperature: 000.0°C
Humidity: 00.0%
Dew Point: 000.0°C
    
```

Displayed if the second serial probe of humidity is enabled. This display allows calibrating this probe, in the event of a reading error.

```

A07
Humidity air calib.
indoor 0.0 %
Humidity air calib.
outdoor 0.0 %
    
```

Displayed if the humidity management function (optional) is enabled on the display CU12. This display allows the return humidity and outdoor humidity probes to be calibrated in the event of a reading error.

```

A07a
Selection of probe type
Humidity : 4/20 mA
Outlet T. : NTC
Quality : 0/10 Vdc
    
```

On this display, it is possible to select the type of probe used for the humidity probes (optional): 4/20mA or 0/1V, although by default they will be configured as 4-20 mA to prevent a probe in an open circuit from continuing to measure without alarm (cable protection).

The outlet temperature probe (standard) is configured as NTC and the quality probe (optional) as 4/20mA.

```

A07c
Air quality probe
configuration
L.scale: 00800 PPM
U.scale: 02000 PPM
    
```

Only displayed if the air quality probe (optional) has been selected on the CU11 display.

The calibration of the probe is established by virtue of the following parameters:

L. scale: lower threshold (corresponds to the value 4 mA).

U. scale: upper threshold (corresponds to the value 20 mA).

```

A07d
Humidity probes
configuration
Maximum: 090.0%
Minimum: 010.0%
Maximum alarm: 100.0%
Minimum alarm: 000.0%
    
```

The calibration of the humidity probes is established by virtue of these limits. On this display also the maximum and minimum values are established for the alarm signaling.

```

A07e
Pressure sensor
configuration
L.scale: 00.0 bar
U.scale: 45.0 bar
    
```

This display is showed if the outdoor coil sensors (or anti-freeze safety in water-air units) are configured in the CU12 display as pressure transducers (0...5V).

The adjustment of the pressure transducers is done with the parameters:

L. scale: lower threshold (corresponds to the value 0 bar).

U. scale: upper threshold (corresponds to the value 45 bar).

```

A07f
Refrigerant: R410A
Temperature dew
C1: 22.5 bar 38.5°C
C2: 22.5 bar 38.5°C
outdoor unit
    
```

On this display, the conversion to temperature is performed for the pressure measured by the transducers of the outdoor coils (or anti-freeze safety in water-air units) for circuits 1 and 2.

For this conversion, the refrigerant that the unit uses and its steam (default) or bubble temperature have to be taken into account.

```

A079
Refrigerant: R410A
Temperature dew
C3: 22.5 bar 38.5°C
C4: 22.5 bar 38.5°C
outdoor unit
    
```

On this display, the conversion to temperature is performed for the pressure measured by the transducers of the outdoor coils (or water-air anti-freeze safety) for circuits 3 and 4 (units with 4 circuits).

For this conversion, the refrigerant that the unit uses and its steam (default) or bubble temperature have to be taken into account.

```

A07f1
Refrigerant: R410A
Temperature dew
C1: -05.6 bar 00.0°C
C2: -05.6 bar 00.0°C
indoor unit
    
```

On this display, the conversion to temperature is performed for the pressure measured by the transducers of the indoor coils for circuits 1 and 2.

For this conversion, the refrigerant that the unit uses and its steam (default) or bubble temperature have to be taken into account.

```

A0791
Refrigerant: R410A
Temperature dew
C3: -05.6 bar 00.0°C
C4: -05.6 bar 00.0°C
indoor unit
    
```

On this display, the conversion to temperature is performed for the pressure measured by the transducers of the indoor coils for circuits 3 and 4 (units with 4 circuits).

For this conversion, the refrigerant that the unit uses and its steam (default) or bubble temperature have to be taken into account.

```

A07h
Probes filter
Enabling NO
Time 30 sec.
Differ. 10.0°C
    
```

This display allows a filter to be authorised in facilities where oscillations are produced in the probe readings.

**Time:** maximum time of filter operation during which the probe reading is blocked.

**Differen:** maximum authorised difference between two consecutive probe readings.

```

A07i
Calculation filter
Outlet SET by AMB. T.
Enabling YES
Time 60 sec
Differen. 01.0°C
    
```

This display allows a filter to be authorised in facilities where oscillations are produced in the ambient temperature probe reading. This optional probe is connected on the field bus using an RS485 serial communications card.

**Time:** maximum time of filter operation during which the probe reading is blocked.

**Differen:** maximum authorised difference between two consecutive probe readings.

```

A08
Test analogue in. (mV)
1 00000 7 00000
2 00000 8 00000
3 00000 9 00000
4 00000 10 00000
5 00000 11 00000
6 00000 12 00000
    
```

Reading of the analogue inputs (probes) in mV:

- 1: return air temperature probe
- 2: outdoor air temperature probe
- 3: outlet air temperature probe
- 4: mixing air temperature probe
- 5: ambient temperature probe or outdoor air relative humidity probe (optional)
- 7: pressure / temperature sensor for the outdoor coil (or anti-freeze safety in water-air units) of circ.1
- 10: air quality probe or return air relative humidity probe (optionals)
- 12: pressure / temperature sensor for the outdoor coil (or anti-freeze safety in water-air units) of circ.2

```
A08a
Test analogue in. (mV)
13 00000 14 00000
15 00000 16 00000
17 00000 18 00000
```

Reading of the analogue inputs of the expansion module pCOe No.1 (address 7) for 4 circuits:

- 13: temperature/pressure sensor for the outdoor coil (or anti-freeze safety in water-air units) of circ.3
- 14: temperature/pressure sensor for the outdoor coil (or anti-freeze safety in water-air units) of circ.4
- 15: on/off signal high pressure pressostat circuit 3
- 16: on/off signal high pressure pressostat circuit 4

Reading of the analogue inputs in mV of the optional probes connected on the field bus using an RS485 serial communications card:

- 17: ambient air temperature
- 18: relative humidity of the ambient air

```
A08b
Test analogue in. (mV)
19 00000 20 00000
21 00000 22 00000
```

Reading of the analogue inputs of the expansion module pCOe No.2 (address 8) for condensation control of the indoor unit:

- 19: pressure sensor for the indoor coil of circuit 1
- 20: pressure sensor for the indoor coil of circuit 2
- 21: pressure sensor for the indoor coil of circuit 3
- 22: pressure sensor for the indoor coil of circuit 4

```
A09a
Test digital output
Indoor fan NO
Compress. 1-C1 NO
Compress. 2-C1 NO
Compress. 1-C2 NO
Compress. 2-C2 NO
Recovery comp. NO
```

During maintenance operations this allows verifying the operation of the corresponding outputs provided that the unit has stopped.

Indoor fan: indoor fan

Compress. 1-C1: compressor 1 of circuit 1

Compress. 2-C1: compressor 2 of circuit 1 (units 2 circuits) or compressor of circuit 2 (units 4 circuits)

Compress. 1-C2: compressor 1 of circuit 2 (units 2 circuits) or compressor of circuit 3 (units 4 circuits)

Compress. 2-C2: compressor 2 of circuit 2 (units 2 circuits) or compressor of circuit 4 (units 4 circuits)

Recovery comp.: compressor of the active recovery circuit

```
A09b
Test digital output
Cycle rev.valv.1 NO
Cycle rev.valv.2 NO
Elec.heat.1 /HWC NO
Elec. heater 2 NO
```

During maintenance operations this allows verifying the operation of the corresponding outputs. In this case, the cycle reversing valves of circuit 1 and 2, as well as two stages of electrical heaters.

```
A09c
Test digital output
Cycle rev.valv.3 NO
Cycle rev.valv.4 NO
```

During maintenance operations this allows verifying the operation of the corresponding outputs. In this case, the cycle reversing valves of circuit 1 and 2, as well as two stages of electrical heaters.

```
A10
Analogue output test
Output Y1 : 000 %
Output Y2 : 000 %
Output Y3 : 000 %
Output Y4 : 000 %
Output Y5 : 000 %
Output Y6 : 000 %
```

During maintenance operations this allows verifying the operation of the corresponding outputs:

Y1 to Y4: Connector J4 on the µPC MEDIUM board

Y5: Connector J2 on the expansion card pCOe No.1 (address 7) for 4 circuits

Y6: Connector J2 on the expansion card pCOe No.2 (address 8) for condensation control of the indoor unit

```

A10a
Manual defrosting 1
      on rest
Manual defrosting 2
      on rest
    
```

On this display we can force the defrosting of the desired circuit, if the unit is operating in heating mode and compressors working. The timing of start of the defrosting is not taken into account.

```

A10a1
Manual defrosting 3
      on rest
Manual defrosting 4
      on rest
    
```

On this display we can force the defrosting of the desired circuit, if the unit is operating in heating mode and compressors working. The timing of start of the defrosting is not taken into account.

```

A11
Refresh. set      = 33 %
Refresh. cal     = 16 %
DAMP. open.cal   = 06 %
Tcal = 60 s Ccal = 03 %
Dif.temp.r.cal  = 2.0°C
    
```

Refresh. set: in units with mixing air probe, three values are compared and the lowest is shown:

- percentage of air refreshing desired.
- percentage allowed by the outlet and return temperatures measured.
- percentage allowed by the mixing temperature measured.

Refresh. cal: % of air refreshing calculated based on the measurement of the temperature of outdoor, return and mixing air probes.

DAMP. open. cal.: display of the real opening percentage of the outdoor air damper.

Tcal: period of time for the calculation of the opening/closing of the damper.

Ccal: maximum opening/closing of the damper during the "Tcal" period.

Dif.T.r.cal: If the difference between mixing and return temperatures, and between mixing and outdoor temperatures it is minor to 2.0°C, the calculated air refreshing is equal to the calculated opening of damper.

```

A12
Enter new
maintenance password
      ****
    
```

This display allows modifying the password.

## COUNTERS group of displays

```

A01
Unit
Operat. hours  00000
Set hours      20000
Reset counter  NO
    
```

Operat. hours: counter of the number of unit operating hours.

Set hours: number of operating hours necessary to indicate a maintenance requirement.

Reset counter: zero setting the counter.

```

A01a
Unit
Ind. fan        00000h
Freecool-Fheat  00000h
Rot. Recuperat. 00000h
E.Heater 1      00000h
E.Heater 2      00000h
Heat valve      00000h
    
```

Ind. fan: counter for the number of operating hours of the indoor fan (supply) and of the return fan, if this option exists.

Freecool-Fheat: number of operating hours of free-cooling (optional).

Rot. Recuperat.: number of operating hours of the rotary recovery (optional).

E.Heater 1: number of operating hours of the 1st electrical heaters (optional).

E.Heater 2: number of operating hours of the 2nd electrical heaters (optional).

Heat valve: number of operating hours of the auxiliary hot water coil (optional).



TIMING		A01b
	ON	OFF
COMP-1:	000s	000s
COMP-1_2:	000s	000s
COMP-2:	000s	000s
COMP-2_2:	000s	000s
COMP-REC:	000s	000s
Reset_time_comp:	NO	

On this display it is possible to visualize the remaining time to complete the "Minimum operation time" and " Minimum shut-down time " of each compressor.

Reset\_time\_comp: this parameter allows to reset the counters to avoid timeouts during units maintenance actions.

A01c	
Compressor lock reset for heating of the crankcase heater (8h)	
NO	7h 59m 35s

In the event of a power cut-off for a period longer than 2 hours, compressors will be locked. The unit must remain 8 hours consecutively with voltage to unlock the compressors. The display also shows the remaining time until the end of the locking.

This display allows to reset this lock of compressors.

Important: If a reset of this locking is carried out, this shall be recorded in the data register of the control.

A01c1	
Power ON	
Time :	00:00
Date :	00/00/2000
Power OFF	
Time :	00:00
Date :	00/00/2000

This display records time and date of the last power cut-off, as well as the time and date of the voltage supply to the unit.

A01d1	
Device forced	OFF
Compressor 1-C1	NO
Compressor 2-C1	NO
Compressor 2-C2	NO
Compressor 2-C2	NO

This display allows to disable one of the compressors of the unit. This compressor is not started and is not taken into account in the rotation of the compressors.

This parameter can be useful to keep the unit running without alarm while maintenance operations are performed on the compressor.

A02	
Compressor 1-C1	
Operat. hour	00000
Set hours	10000
Reset counter	NO

Operat. hours: counter of the number of operating hours for compressor 1 in circuit 1.

Set hours: number of operating hours necessary to indicate a maintenance requirement.

Reset counter: zero setting the counter.

Note: It is possible to modify the values of the counters by entering a special password of Maintenance.

This allows to re-enter the values prior to a software update.

A02a	
Compressor 2-C1	
Operat. hours	00000
Set hours	10000
Reset counter	NO

Operat. hours: counter of the number of operating hours for compressor 2 in circuit 1 (units with 2 circuits) or for the compressor in circuit 2 (units with 4 circuits).

Set hours: number of operating hours necessary to indicate a maintenance requirement.

Reset counter: zero setting the counter.

Note: It is possible to modify the values of the counters by entering a special password of Maintenance.

This allows to re-enter the values prior to a software update.

A03	
Compressor 1-C2	
Operat. hours	00000
Set hours	10000
Reset counter	NO

Operat. hours: counter of the number of operating hours for compressor 1 in circuit 2 (units with 2 circuits) or for the compressor in circuit 3 (units with 4 circuits).

Set hours: number of operating hours necessary to indicate a maintenance requirement.

Reset counter: zero setting the counter.

Note: It is possible to modify the values of the counters by entering a special password of Maintenance.

This allows to re-enter the values prior to a software update.

```

A03a
Compressor 2-C2
Operat. hours  00000
Set hours     10000
Reset counter  NO
    
```

**Operat. hours:** counter of the number of operating hours for compressor 2 in circuit 2 (units with 2 circuits) or for the compressor in circuit 2 (units with 4 circuits).

**Set hours:** number of operating hours necessary to indicate a maintenance requirement.

**Reset counter:** zero setting the counter.

Note: It is possible to modify the values of the counters by entering a special password of Maintenance. This allows to re-enter the values prior to a software update.

```

A03b
Recovery compressor
Operat. hours  00000
Set horas     10000
Reset contador NO
    
```

**Operat. hours:** counter of the number of operating hours for the compressor in the active recovery circuit (optional).

**Set hours:** number of operating hours necessary to indicate a maintenance requirement.

**Reset counter:** zero setting the counter.

Note: It is possible to modify the values of the counters by entering a special password of Maintenance. This allows to re-enter the values prior to a software update.

```

A03c
Number of start-ups
Indoor fan:    00000
Compressor 1-C1:00000
Compressor 1-C2:00000
Recovery comp.: 00000
    
```

**Indoor fan:** counter of the number of start-ups of the indoor fan (supply) and of the optional return fan.

**Compressor 1-C1:** counter of the number of start-ups for the compressor 1 in circuit 1.

**Compressor 1-C2:** counter of the number of start-ups for the compressor 1 in circuit 2 (units with 2 circuits) or for the compressor in circuit 3 (units with 4 circuits).

**Recovery comp.:** counter of the number of start-ups for the compressor in the recovery circuit.

```

A03d
Number of start-ups
Compressor 2-C1:00000
Compressor 2-C2:00000
E.Heater 1:    00000
E.Heater 2:    00000
    
```

**Compressor 2-C1:** counter of the number of start-ups for compressor 2 in circuit 1 (units with 2 circuits) or for the compressor in circuit 2 (units with 4 circuits).

**Compressor 2-C2:** counter of the number of start-ups for the compressor 2 in circuit 2 (units with 2 circuits) or for the compressor in circuit 4 (units with 4 circuits).

**E.Heater 1:** counter of the number of start-ups of the 1st stage of the electrical heater.

With gas burner the display will display the following text: 'Burner 1stSt'.

**E.Heater 2:** counter of the number of start-ups of the 2nd stage of the electrical heater.

With gas burner the display will display the following text: 'Burner 2ndSt'.

```

A10d
No. of defrosting in
circuit 1:    00000
circuit 2:    00000
    
```

This display provides information on how many defrosting operations have been performed in circuits 1 and 2.

```

A10d1
No. of defrosting in
circuit 3:    00000
circuit 4:    00000
    
```

This display provides information on how many defrosting operations have been performed in circuits 3 and 4.

```

A10e
Duration of the last
defrosting
circuit 1:    000 sec
circuit 2:    000 sec
    
```

This display provides information on the duration of the last defrosting operation in circuits 1 and 2.

```

A10e1
Duration of the last
defrosting
circuit 3:    000 sec
circuit 4:    000 sec
    
```

This display provides information on the duration of the last defrosting operation in circuits 3 and 4.

```

A10f
Time between the
last two defrostings
circuit 1:    00000 min
circuit 2:    00000 min
    
```

This display provides information on the time that has elapsed between the last two defrosting operation in circuits 1 and 2.

```

A10f1
Time between the
last two defrostings
circuit 3:    00000 min
circuit 4:    00000 min
    
```

This display provides information on the time that has elapsed between the last two defrosting operation in circuits 3 and 4.



# Electronic control

No. ALARMS	A12a
High Press. C1:	0000
High Press. C2:	0000
Low Press. C1:	0000
Low Press. C2:	0000
Disch. comp. C1:	0000
Disch. comp. C2:	0000

Number of alarms of high pressure, low pressure and temperature of discharge of compressors:

C1: compressor 1 in circuit 1.

C2: compressor in circuit 2 (units with 4 circuits) or compressor 2 in circuit 1 (units with 2 circuits).

No. ALARMS	A12b
High Press. C3:	0000
High Press. C4:	0000
Low Press. C3:	0000
Low Press. C4:	0000
Disch. comp. C3:	0000
Disch. comp. C4:	0000

Number of alarms of high pressure, low pressure and temperature of discharge of compressors:

C3: compressor in circuit 3 (units with 4 circuits) or compressor 1 in circuit 2 (units with 2 circuits).

C4: compressor in circuit 4 (units with 4 circuits) or compressor 2 in circuit 2 (units with 2 circuits).

No. ALARMS	A12c
T.comp&oud.fan C1:	0000
T.comp&oud.fan C2:	0000
Antifreez.ref. C1:	0000
Antifreez.ref. C1:	0000

Number of alarms of thermal protection of compressors and outdoor fans in circuits 1 and 2.

In water-air units, number of alarms of anti-freeze safety in circuits 1 and 2.

No. ALARMS	A12d
T.comp&oud.fan C3:	0000
T.comp&oud.fan C4:	0000
Antifreez.ref. C3:	0000
Antifreez.ref. C4:	0000

Number of alarms of thermal protection of compressors and outdoor fans in circuits 3 and 4.

In water-air units, number of alarms of anti-freeze safety in circuits 3 and 4.

No. ALARMS	A12e0
Therm. ind.fan:	0000
Therm. E.heater:	0000
HP-LP rec.comp.::	0000
Block antifreeze:	0000
Fail.power supply:	0000

Number of alarms of: thermal protection of indoor fan, thermal protection of electrical heaters, high-low pressure of the recovery circuit.

In water-air units, number of blocking due to anti-freeze alarm. For a description of this alarm consult the display CS02.

On this display also it is possible to visualize the number of failures of power supply.

No. ALARMS	A12e
Flow switch:	0000
Water coil saf.:	0000
Fire safety:	0000

Number of alarms of water flow switch (in water-air units), hot water coil safety and anti-fire safety.

No. PROBES ALARMS	A12f
Indoor humidity:	0000
Outdoor humidity:	0000
Return temp.:	0000
Outdoor temp.:	0000
Outlet temp.:	0000
Mixing temp.:	0000

Number of alarms produced in the probes.

```

No. PROBES ALARMS A1290
Ambient probe 1: 0000
Ambient probe 2: 0000
Outdoor unit C1: 0000
Outdoor unit C2: 0000
    
```

Number of alarms produced in the sensors.

```

No. PROBES ALARMS A1291
Outdoor unit C3: 0000
Outdoor unit C4: 0000
    
```

Number of alarms produced in the sensors.

```

A12h
Gas detector No.001
Running hours 00000h
              00000dd
    
```

Counter of the number of operating hours and days for the refrigerant gas detector (optional).

This information is very important to realize the maintenance works on the leakage detector:

- Annual test: To comply with the requirements of the EN378 and F GAS is necessary to perform a test of the detector every year.
- Every 3 years: a calibration is recommended.
- Every 5/6 years: change the detector element of the sensor and perform a calibration is recommended.

```

A12i
Gas detector No.001
Reset:      No
Date last reset
00/00/0000  00:00
    
```

On this display it is possible to reset the refrigerant gas detector. The display also indicates the date and hour of the last reset.

```

RESET COUNTERS A13
No. of start-ups: NO
No. of def. proc: NO
No. of alarms : NO
    
```

On this display it is possible to reset the counters of number of: start-ups, defrosting procedures and alarms.

### ALARM RECORD group of displays



```

H01
Log of alarms H 0000
'legend of the
alarm triggered'
00:00 U:01 00/00/0000
Tr: 00.0°C Te: 00.0°C
    
```

This display features the e last 100 alarm generated. It shows the alarm description, its date and time as well as the ambient (or return) temperature (Tr) and the outdoor temperature (Te) existing at the moment of this alarm.

The failures of electrical power supply also will remain registered.

## 26. DESCRIPTION OF ALARM DISPLAYS

This group of displays is for indicating and providing information on the alarms in the unit. Only the displays appear that correspond to the alarms residing in the memory. If there are various alarms, moving from one display to the next is carried out by pressing the   keys. If the unit does not have any alarm, the message "NO ACTIVE ALARM" appears.

To cancel an alarm from the memory, once again press the  key on the corresponding display.

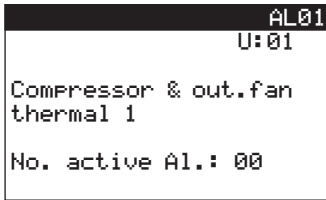

With the intervention of this alarm, circuit 1 stops.

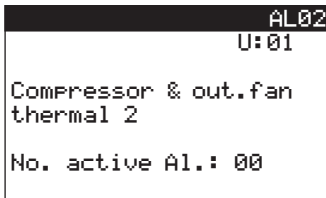

With the intervention of this alarm, circuit 2 stops.

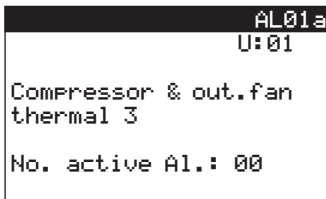

With the intervention of this alarm, circuit 3 stops.

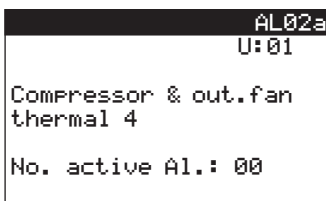

With the intervention of this alarm, circuit 4 stops.

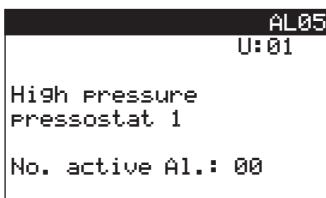

With the intervention of this alarm, the compressor(s) and the indoor fan on circuit 1 stop.

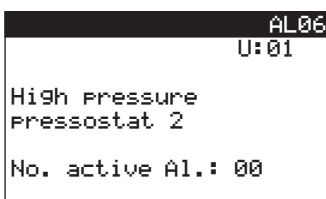

With the intervention of this alarm, the compressor(s) and the indoor fan on circuit 2 stop.

```

AL05a
U:01
High Pressure
Pressostat 3
No. active Al.: 00
    
```

With the intervention of this alarm, the compressor(s) and the indoor fan on circuit 3 stop.

```

AL06a
U:01
High Pressure
Pressostat 4
No. active Al.: 00
    
```

With the intervention of this alarm, the compressor(s) and the indoor fan on circuit 4 stop.

```

AL07
U:01
Recovery c. low and
high Pressostat
No. active Al.: 00
    
```

With the intervention of this alarm, the compressor(s) of the active recovery circuit (optional) stop(s).

```

AL08
U:01
Maintenance
recovery comp.
(only indication)
No. active Al.: 00
    
```

This alarm only serves as an indication.

```

AL09
U:01
Serious alarm
anti-freeze actuation
No. active Al.: 00
    
```

With the intervention of this alarm the unit stops in COOLING mode.

```

AL10
U:01
Set exceeded
high temperature
ambient air
No. active Al.: 00
    
```

This alarm only serves as an indication and delays the start of the unit.

```

AL11
U:01
Set exceeded
low temperature
ambient air
No. active Al.: 00
    
```

This alarm only serves as an indication and delays the start of the unit.

```
AL12
U:01
Low Pressure
Pressostat 1
No. active Al.: 00
```

With the triggering of this alarm, the compressor(s) in circuit 1 stop(s).

```
AL13
U:01
Low Pressure
Pressostat 2
No. active Al.: 00
```

With the triggering of this alarm, the compressor(s) in circuit 2 stop(s).

```
AL12a
U:01
Low Pressure
Pressostat 3
No. active Al.: 00
```

With the triggering of this alarm, the compressor in circuit 3 stops.

```
AL13a
U:01
Low Pressure
Pressostat 4
No. active Al.: 00
```

With the triggering of this alarm, the compressor in circuit 4 stops.

```
AL12b
U:01
Continuous defrost
by minimum Pressure
in circuit 1
No. active Al.: 00
```

This display advises if the alarm of low pressure in circuit 1 was caused due to continuous defrosting by minimum pressure (4 defrosting in less than 60 minutes).

```
AL12c
U:01
Continuous defrost
by minimum Pressure
in circuit 2
No. active Al.: 00
```

This display advises if the alarm of low pressure in circuit 2 was caused due to continuous defrosting by minimum pressure (4 defrosting in less than 60 minutes).

```
AL13b
U:01
Continuous defrost
by minimum Pressure
in circuit 3
No. active Al.: 00
```

This display advises if the alarm of low pressure in circuit 3 was caused due to continuous defrosting by minimum pressure (4 defrosting in less than 60 minutes).

```

AL13c
U:01
Continuous defrost
by minimum pressure
in circuit 3

No. active Al.: 00
    
```

This display advises if the alarm of low pressure in circuit 3 was caused due to continuous defrosting by minimum pressure (4 defrosting in less than 60 minutes).

```

AL16
U:01
Maintenance
compressor 1-C1
(only indication)

No. active Al.: 00
    
```

This alarm is purely for indicating that maintenance must be performed on the compressor 1 in circuit 1.

```

AL17
U:01
Maintenance
compressor 1-C2
(only indication)

No. active Al.: 00
    
```

This alarm is purely for indicating that maintenance must be performed on compressor 1 in circuit 2 (unit with 2 circuits) or on the compressor in circuit 3 (unit with 4 circuits).

```

AL18
U:01
Maintenance
compressor 2-C1
(only indication)

No. active Al.: 00
    
```

This alarm is purely for indicating that maintenance must be performed on compressor 2 in circuit 1 (unit with 2 circuits) or on the compressor in circuit 2 (unit with 4 circuits).

```

AL19
U:01
Maintenance
compressor 2-C2
(only indication)

No. active Al.: 00
    
```

This alarm is purely for indicating that maintenance must be performed on compressor 2 in circuit 2 (unit with 2 circuits) or on the compressor in circuit 4 (unit with 4 circuits).

```

AL20
U:01
Thermal indoor
fan and/or
flow switch

No. active Al.: 00
    
```

With the intervention of this alarm the unit comes to a complete stop.

```

AL21
U:01
Outd.unit 1 sensor
broken down

No. active Al.: 00
    
```

With the intervention of this alarm circuit 1 stops.





## Electronic control

```
AL22
U:01
Outd.unit 2 sensor
broken down
No. active Al.: 00
```

With the intervention of this alarm circuit 2 stops.

```
AL21a
U:01
Outd.unit 3 sensor
broken down
No. active Al.: 00
```

With the intervention of this alarm circuit 3 stops.

```
AL22a
U:01
Outd.unit 4 sensor
broken down
No. active Al.: 00
```

With the intervention of this alarm circuit 4 stops.

```
AL21b
U:01
Ind.unit 1 sensor
broken down
No. active Al.: 00
```

With the intervention of this alarm circuit 1 stops.

```
AL21c
U:01
Ind.unit 2 sensor
broken down
No. active Al.: 00
```

With the intervention of this alarm circuit 2 stops.

```
AL22b
U:01
Ind.unit 3 sensor
broken down
No. active Al.: 00
```

With the intervention of this alarm circuit 3 stops.

```
AL22c
U:01
Ind.unit 4 sensor
broken down
No. active Al.: 00
```

With the intervention of this alarm circuit 4 stops.

```

AL23
U:01
Clogged filter
alarm
(only indication)
No. active Al.: 00
    
```

This alarm only serves as an indication (by default) or unit shut-down, according to configuration of display CS08b).

```

AL24
U:01
Thermistor
heaters 1 and 2
No. active Al.:
    
```

This display is shown if the unit includes electrical heaters: the safety thermistors directly cut off the outlet to the electrical heaters independently of the control.

```

AL24
U:01
Gas burner
failure
No. active Al.: 00
    
```

This display is shown if the unit includes gas burner: its own control manages the safeties. The CIATrtc control only indicates the failure.

```

AL26
U:01
Serious alarm
Permanent memory
broken down (indication)
No. active Al.: 00
    
```

Serious system alarm. Support service (SAT) must be contacted.

```

AL27
U:01
Clock absent or
broken down
No. active Al.: 00
    
```

This alarm only serves as an indication.

```

AL28
U:01
Unit
maintenance
(only indication)
No. active Al.: 00
    
```

This alarm only serves as an indication.

```

AL29
U:01
Probe alarm
broken or disconn.
return temperature
No. active Al.: 00
    
```

With the intervention of this alarm the unit comes to a complete stop.



## Electronic control

```
AL30a
U:01
Serial Probe No.01
Humidity probe
broken
No. active Al.: 00
```

This alarm only serves as an indication.

```
AL30b
U:01
Serial Probe No.01
Probe Offline
No. active Al.: 00
```

This alarm only serves as an indication.

```
AL30c
U:01
Serial Probe No.01
Temperature probe
broken
No. active Al.: 00
```

This alarm only serves as an indication.

```
AL30d
U:01
Serial Probe No.02
Humidity probe
broken
No. active Al.: 00
```

This alarm only serves as an indication.

```
AL30e
U:01
Serial Probe No.02
Probe Offline
No. active Al.: 00
```

This alarm only serves as an indication.

```
AL30f
U:01
Serial Probe No.02
Temperature probe
broken
No. active Al.: 00
```

This alarm only serves as an indication.

```
AL31
U:01
T, RH, CO2 PLAN
probe disconn.
(check PLAN)
No. active Al.: 00
```

This alarm only serves as an indication.

```
AL32
U:01
Probe alarm
broken or disconn.
outdoor temperature
No. active Al.: 00
```

This alarm only serves as an indication.

```
AL33
U:01
Probe alarm
broken or disconn.
indoor humidity
No. active Al.: 00
```

This alarm only serves as an indication.

```
AL34
U:01
Probe alarm
broken or disconn.
outdoor humidity
No. active Al.: 00
```

This alarm only serves as an indication.

```
AL35
U:01
Probe alarm
broken or disconn.
outlet temperature
No. active Al.: 00
```

This alarm only serves as an indication.

```
AL35a
U:01
Probe alarm
broken or disconn.
mixing temperature
No. active Al.: 00
```

This alarm indicates the failure of the mixing air probe or the air quality probe, both optional, depending on the configuration of the B8 input.

```
AL36
U:01
Serious alarm
Summer setpoint
is less than
winter setpoint
No. active Al.: 00
```

With the intervention of this alarm the unit comes to a complete stop. This alarm concerns all the setpoints, included those of schedule programming.

```
AL37
U:01
Limit exceeded
compr. discharge
circuit 1
No. active Al.: 00
```

When the safety temperature limit is exceeded for discharge of the compressor(s), circuit 1 stops.



## Electronic control

```
AL38
U:01
Limit exceeded
comer. discharge
circuit 2
No. active Al.: 00
```

When the safety temperature limit is exceeded for discharge of the compressor(s), circuit 2 stops.

```
AL37a
U:01
Limit exceeded
comer. discharge
circuit 3
No. active Al.: 00
```

When the safety temperature limit is exceeded for discharge of the compressor(s), circuit 3 stops.

```
AL38a
U:01
Limit exceeded
comer. discharge
circuit 4
No. active Al.: 00
```

When the safety temperature limit is exceeded for discharge of the compressor(s), circuit 4 stops.

```
AL39
U:01
Serious alarm
Anti-fire thermostat
or smoke detector
No. active Al.: 00
```

This alarm will be triggered if the return temperature set for anti-fire safety purposes is exceeded, or if smoke is detected in the station that can be connected at digital input DI2 (connector J4).

In case of alarm, the unit will stop and, if it includes an outdoor air damper, this will open completely.

```
AL40
U:01
Limit exceeded
high temperature
outlet air
No. active Al.: 00
```

This display appears if the electrical heater or gas burner has been selected. When the set safety limit is exceeded this option is shut down.

```
AL41
U:01
Refri9. anti-freeze
alarm circ.1
No. active Al.: 00
```

With the intervention of this alarm circuit 1 stops (water-air units).

```
AL42
U:01
Refri9. anti-freeze
alarm circ.2
No. active Al.: 00
```

With the intervention of this alarm circuit 2 stops (water-air units).

```

AL41a
U:01

Refrig. anti-freeze
alarm circ.3

No. active Al.: 00
    
```

With the intervention of this alarm circuit 3 stops (water-air units).

```

AL42a
U:01

Refrig. anti-freeze
alarm circ.4

No. active Al.: 00
    
```

With the intervention of this alarm circuit 4 stops (water-air units).

```

AL43
U:01

Blocked unit by
anti-freeze alarm

No. active Al.: 00
    
```

With the intervention of this alarm the unit comes to a complete stop (water-air units).

```

AL44
U:01

Open flow
switch alarm

No. active Al.: 00
    
```

With the intervention of this alarm the unit comes to a complete stop (water-air units).

```

AL45a
U:01

pCOe number: 001
pCOe offline

No. active Al.: 00
    
```

Communication fault with the pCOe expansion module I/O No.1 (address 7) (required for units with 4 compressors and 4 circuits).

```

AL45f
U:01

pCOe number: 001
I/O mismatch alarm
(no confirmation of
out pattern for 10s)

No. active Al.: 00
    
```

Mismatch of the inputs/outputs with the pCOe expansion module I/O No.1 (address 7) (required for units with 4 compressors and 4 circuits).

```

AL45b
U:01

pCOe number: 002
pCOe offline

No. active Al.: 00
    
```

Communication fault with the pCOe expansion module I/O No.1 (address 7) (required for units with 4 compressors and 4 circuits).



## Electronic control

```
AL45a
U:01
pCOe number: 003
I/O mismatch alarm
(no confirmation of
out Pattern for 10s)
No. active Al.: 00
```

Mismatch of the inputs/outputs with the pCOe expansion module I/O No.2 (address 8) (required for condensation control of the indoor unit).

```
AL45c
U:01
pCOe number: 003
pCOe offline
No. active Al.: 00
```

Communication fault with the pCOe expansion module I/O No.3 (address 9) (required for zoning into two areas and/or a variable rotary recovery).

```
AL45h
U:01
pCOe number: 003
I/O mismatch alarm
(no confirmation of
out Pattern for 10s)
No. active Al.: 00
```

Mismatch of the inputs/outputs with the pCOe expansion module I/O No.3 (address 9) (required for zoning into two areas and/or a variable rotary recovery).

```
AL46
U:01
Device offline
GAVAZZI 000
No. active Al.: 00
```

Communication fault with the energy meter. Only indication.

```
AL47
U:01
Indoor fan
offline Dir: 001
No. active Al.: 00
```

Communication fault with the indoor circuit supply plug-fan configured with address 001. Only indication.

```
AL48
U:01
Pressure sensor alarm
broken or disconn.
airflow control
indoor fan
No. active Al.: 00
```

Communication fault with the pressure sensor for air flow control with the indoor circuit supply plug-fan. Only indication.

```
AL49
U:01
Return fan
offline Dir: 001
No. active Al.: 00
```

Communication fault with the return plug-fan configured with address 002. Only indication.

```

AL50
U:01
Pressure sensor alarm
broken or disconn.
airflow control
return fan
No. active Al.: 00
    
```

Communication fault with the pressure sensor for air flow control with return plug-fan. Only indication.

```

AL51a
U:01
Gas detector No.001
Sensor fault
gas detection
No. active Al.: 00
    
```

Communication fault with the leak detector sensor. With the intervention of this alarm the unit comes to a complete stop.

```

AL51b
U:01
Gas detector No.001
Gas leak detection
Disable Buzzer
for min? No
No. active Al.: 00
    
```

Refrigerant leak alarm. With the intervention of this alarm the unit comes to a complete stop.

```

AL51c
U:01
Gas detector No.001
Gas leakage detector
offline in Modbus line
No. active Al.: 00
    
```

Communication fault with the leak detector. With the intervention of this alarm the unit comes to a complete stop.

```

AL51d
U:01
Gas detector No.001
Sensor operating for
more than 1 year
Need for service
No. active Al.: 00
    
```

Indication of maintenance of the refrigerant leak detector.

```

AL61
UFD No.001

Device offline
No. active Al.: 00
    
```

Communication fault with the variable frequency drive of the indoor fan (VFD No.001). With the intervention of this alarm the unit comes to a complete stop.

```

AL62
UFD No.002

Device offline
No. active Al.: 00
    
```

Communication fault with the variable frequency drive of the return fan (VFD No.002). With the intervention of this alarm the unit comes to a complete stop.





# Electronic control

```

Alarms
VFD No.001

#01:Over Current      □
#02:Over Voltage     □
#03:Ground Fault     □
#05:Charge Contact   □
#08:System Fault     □

```

This display indicates that there has been any of these failures on the variable frequency drive of the indoor fan (VFD No.001) or return fan (VFD No.002).

```

Alarms
VFD No.001

#09:Low Voltage      □
#11:No Phase Current □
#13:Low Temperature □
#14:High Temperature □
#15:Motor Block      □

```

This display indicates that there has been any of these failures on the variable frequency drive of the indoor fan (VFD No.001) or return fan (VFD No.002).

```

Alarms
VFD No.001

#16:High Motor Temp  □
#17:Low Motor Load  □
#22:Eeprom Error     □
#25:Watchdog Fault   □
#29:Motor Overload   □

```

This display indicates that there has been any of these failures on the variable frequency drive of the indoor fan (VFD No.001) or return fan (VFD No.002).

```

Alarms
VFD No.001

#34:Internal Bus     □
#35:Appl. Fault     □
#40:Unknown Device  □
#41:IGBT Temperature □
#50:AIN Fault        □
#51:External Fault  □

```

This display indicates that there has been any of these failures on the variable frequency drive of the indoor fan (VFD No.001) or return fan (VFD No.002).

```

Alarms
VFD No.001

#52:Panel Comm.     □
#53:Fieldbus Fault  □
#54:Slot Fault      □
#55:Spv.value fault □

```

This display indicates that there has been any of these failures on the variable frequency drive of the indoor fan (VFD No.001) or return fan (VFD No.002).

```

AL63a

Th.TCO 00 offline

No. active Al.: 00

```

Communication fault with the TCO thermostat (optional).

```

AL63b

Th.TCO n. 00

Temperature probe
broken or not working
No. active Al.: 00

```

Communication fault with the temperature probe of the TCO thermostat (optional).

**AL63c**

Th.TCO n. 00  
 Humidity probe  
 broken or not working  
 No. active Al.: 00

Communication fault with the humidity probe of the TCO thermostat (optional).

**AL63d**

Th.TCO n. 00  
 Clock board fault  
 No. active Al.: 00

Communication fault with the clock board of the TCO thermostat (optional).

**AL64**

Temp. probe alarm  
 broken or disconn.  
 H.W.C. inlet water  
 No. active Al.: 00

Communication fault with the temperature probe for the inlet of the hot water coil with GREAT COLD option (expansion card pCOe No.2 (address 8)).

**AL65**

Temp. probe alarm  
 broken or disconn.  
 H.W.C. outlet water  
 No. active Al.: 00

Communication fault with the temperature probe for the outlet of the hot water coil with GREAT COLD option (expansion card pCOe No.2 (address 8)).

**AL66**

Serious alarm  
 temperature low  
 H.W.C. outlet water  
 No. active Al.: 00

Serious alarm for low temperature of the water in the outlet of the hot water coil with GREAT COLD option (expansion card pCOe No.2 (address 8)).

**AL67**

Probe alarm  
 broken or disconn.  
 room temperature  
 No. active Al.: 00

Communication fault with the ambient temperature probe NTC installed on the analogue input B5 (by default).

Important: The maximum distance of the NTC probe to the control board can be 30 metres.

**AL69**

Temp. probe alarm  
 broken or disconn.  
 WHEEL recovery air  
 No. active Al.: 00

Communication fault with the probe of recovery temperature on the wheel (rotary recovery).



## Electronic control

```
AL70
Off unit by
supply damper
unopened
No. active Al.: 00
```

This alarm indicates that the unit has stopped because it does not detect that the supply damper is open (digital input DI1 of the pCOe expansion module I/O No.3 (addresss 9)).

```
AL71
Off unit by
return damper
unopened
No. active Al.: 00
```

This alarm indicates that the unit has stopped because it does not detect that the return damper is open (digital input DI1 of the pCOe expansion module I/O No.3 (addresss 9)).

```
Warning AU01
Compressor lock
for heating of the
crankcase heater (8h)
7h 59m 35s
Active warning: 00
```

In the event of a power cut-off for a period longer than 2 hours, this warning display will appear and the compressors will be locked. The unit must remain 8 hours consecutively with voltage to unlock the compressors.

The display also shows the remaining time until the end of the locking.

Note: The A01c display of the Maintenance menu allows to reset this lock of compressors, but this shall be recorded in the data register of the control.

```
Warning AU02
High rpm warning
Fan Addr: 001
(only indication)
maxim. speed: 0000 rpm
Active warning: 00
```

This warning display will appear when the outlet plug-fan (001) exceed the maximum permissible speed for a period of time longer than 30 minutes (by default).

It also advises if warning is "indication only", or is "unit OFF".

These parameters are selected on the CS08a display.

```
Warning AU03
High rpm warning
Fan Addr: 002
(only indication)
maxim. speed: 0000 rpm
Active warning: 00
```

This warning display will appear when the return plug-fan (002) exceed the maximum permissible speed for a period of time longer than 30 minutes (by default).

It also advises if warning is "indication only", or is "unit OFF".

These parameters are selected on the CS08a display.

## 27. LIST OF FACTORY-SET PARAMETERS

### 27.1. Parameters of the MAIN MENU

Display	Parameter	Description of the parameter	Value	Maximum	Minimum	Unit	Type	R/W	Address
<b>SETPOINTS</b>									
S01	SET_POINT_TEMP_FRIO	Summer air setpoint	26.0	LIM_INF_TEMP	LIM_SUP_TEMP	°C	Analog	R/W	15
S01	SET_POINT_TEMP_CALOR	Winter air setpoint	21.0	LIM_INF_TEMP	LIM_SUP_TEMP	°C	Analog	R/W	16
S02	SET_POINT_HUM	Humidity setpoint	55.0	LIM_INF_HUM	LIM_SUP_HUM	%rH	Analog	R/W	18
<b>INPUTS/OUTPUTS</b>									
I20	VER_SOFT	Current version of the program	11.1	0	99.9	---	Analog	R	75
<b>OFF/ON</b>									
PM01	SYS_ON	OFF/ ON of the unit via the keyboard	0	0: off / 1: on			Digital	R/W	65
<b>WINTER/SUMMER</b>									
FC01	SEL_FRIO_CALOR	Selection of winter/summer mode	2: auto	0: by keyboard 1: by digital input (remote) 2: auto 3: only ventilation			Integer	R/W	59
FC01	MODO_FRIO_CALOR_AUTO	Mode of winter/summer selection in automatic	1: by outd. T	0: by indoor temperature 1: by outdoor temperature			Digital	R/W	232
FC01	EST_INV_PAN	Winter / summer by keyboard	1	0: winter 1: summer			Digital	R/W	66
FC01	SET_TEMP_EXT_CAMBIO_FRIO	Outdoor temperature setpoint for change to COOLING mode	22,0	-99,9	99,9	°C	A	R/W	223
FC01	SET_TEMP_EXT_CAMBIO_CALOR	Outdoor temperature setpoint for change to HEATING mode	20,0	-99,9	99,9	°C	A	R/W	224
<b>SCHEDULE PROGRAMMING</b>									
PH03	TIPO_ARR	Start type	3: Manual	0: ON/OFF program 1: Program with setpoint change 2: ON/OFF program (set ON limit) 3: Manual 4: 3 setpoints schedule + OFF unit 5: Forced		---	Integer	R/W	71
PH03	TIME_F_MAN	On time with forced start	2	1	999	h	Integer	R/W	73
PH03	HAB_BLOQ_COMP_ON_FASE_LIM_FRIO	Disable compressors in summer with scheduling and setpoint limit in summer (night freecooling)	0: no	0: no 1: yes		---	Digital	R/W	72
PH03	HAB_BLOQ_RENOVACION_ON_FASE_LIM	Disable the outdoor air exchange and scheduling limit setpoint (night)	0: no	0: no 1: yes		---	Digital	R/W	73
PH04	H_ARR_1A	Start-up hour of slot 1- program 1	6	0	23	h	Integer	R/W	74
PH04	M_ARR_1A	Start-up minute of slot 1-program 1	30	0	59	min	Integer	R/W	75
PH04	H_PAR_1A	Stop hour of slot 1 - program 1	11	0	23	h	Integer	R/W	76
PH04	M_PAR_1A	Stop minute of slot 1 - program 1	0	0	59	min	Integer	R/W	77
PH04	H_ARR_1B	Start-up hour of slot 2 - program 1	11	0	23	h	Integer	R/W	78
PH04	M_ARR_1B	Start-up minute of slot 2 - program 1	30	0	59	min	Integer	R/W	79
PH04	H_PAR_1B	Stop hour of slot 2 - program 1	13	0	23	h	Integer	R/W	80
PH04	M_PAR_1B	Stop minute of slot 2 - program 1	30	0	59	min	Integer	R/W	81
PH04	H_ARR_1C	Start-up hour of slot 3 - program 1	15	0	23	h	Integer	R/W	82
PH04	M_ARR_1C	Start-up minute of slot 3 - program 1	0	0	59	min	Integer	R/W	83
PH04	H_PAR_1C	Stop hour of slot 3 - program 1	19	0	23	h	Integer	R/W	84
PH04	M_PAR_1C	Stop minute of slot 3 - program 1	0	0	59	min	Integer	R/W	85
PH05	H_ARR_2A	Start-up hour of slot1 - program 2	8	0	23	h	Integer	R/W	86
PH05	M_ARR_2A	Start-up minute of slot 1 - program 2	0	0	59	min	Integer	R/W	87
PH05	H_PAR_2A	Stop hour of slot 1 - program 2	14	0	23	h	Integer	R/W	88
PH05	M_PAR_2A	Stop minute of slot 1 - program 2	0	0	59	min	Integer	R/W	89
PH05	H_ARR_2B	Start-up hour of slot 2 - program 2	17	0	23	h	Integer	R/W	90
PH05	M_ARR_2B	Start-up minute of slot 2 - program 2	0	0	59	min	Integer	R/W	91



## Parameters of the MAIN MENU

Display	Parameter	Description of the parameter	Value	Maximum	Minimum	Unit	Type	R/W	Address
<b>SCHEDULE PROGRAMMING (...continued)</b>									
PH05	H_PAR_2B	Stop hour of slot 2 - program 2	20	0	23	h	Integer	R/W	92
PH05	M_PAR_2B	Stop minute of slot 2 - program 2	30	0	59	min	Integer	R/W	93
PH05	H_ARR_2C	Start-up hour of slot 3 - program 2	0	0	23	h	Integer	R/W	94
PH05	M_ARR_2C	Start-up minute of slot 3 - program 2	0	0	59	min	Integer	R/W	95
PH05	H_PAR_2C	Stop hour of slot 3 - program 2	0	0	23	h	Integer	R/W	96
PH05	M_PAR_2C	Stop minute of slot 3 - program 2	0	0	59	min	Integer	R/W	97
PH06	H_ARR_3A	Start-up hour of slot 1 - program 3	7	0	23	h	Integer	R/W	98
PH06	M_ARR_3A	Start-up minute of slot 1 - program 3	0	0	59	min	Integer	R/W	99
PH06	H_PAR_3A	Stop hour of slot 1 - program 3	15	0	23	h	Integer	R/W	100
PH06	M_PAR_3A	Stop minute of slot 1 - program 3	0	0	59	min	Integer	R/W	101
PH06	H_ARR_3B	Start-up hour of slot 2 - program 3	0	0	23	h	Integer	R/W	102
PH06	M_ARR_3B	Start-up minute of slot 2 - program 3	0	0	59	min	Integer	R/W	103
PH06	H_PAR_3B	Stop hour of slot 2 - program 3	0	0	23	h	Integer	R/W	104
PH06	M_PAR_3B	Stop minute of slot 2 - program 3	0	0	59	min	Integer	R/W	105
PH06	H_ARR_3C	Start-up hour of slot 3 - program 3	0	0	23	h	Integer	R/W	106
PH06	M_ARR_3C	Start-up minute of slot 3 - program 3	0	0	59	min	Integer	R/W	107
PH06	H_PAR_3C	Stop hour of slot 3 - program 3	0	0	23	h	Integer	R/W	108
PH06	M_PAR_3C	Stop minute of slot 3 - program 3	0	0	59	min	Integer	R/W	109
PH07	SET_INT_FRIO	Setpoint for time slots in summer	26	-99,9	99,9	°C	Analog	R/W	61
PH07	SET_EXT_FRIO	Setpoint out of time slots in summer	28	-99,9	99,9	°C	Analog	R/W	59
PH08	SET_INT_CALOR	Setpoint for time slots in winter	21	-99,9	99,9	°C	Analog	R/W	60
PH08	SET_EXT_CALOR	Setpoint out of time slots in winter	19	-99,9	99,9	°C	Analog	R/W	58
PH09	SET_INT_LIM_FRIO	Setpoint for time slots in summer with "ON-OFF with SET limit of ON"	26	-99,9	99,9	°C	Analog	R/W	79
PH09	SET_EXT_LIM_FRIO	Safety setpoint out of time slots in summer	34	-99,9	99,9	°C	Analog	R/W	77
PH10	SET_INT_LIM_CALOR	Setpoint for time slots in winter with "ON-OFF with SET limit of ON"	21	-99,9	99,9	°C	Analog	R/W	78
PH10	SET_EXT_LIM_CALOR	Safety setpoint out of time slots in winter	13	-99,9	99,9	°C	Analog	R/W	76
PH11	DIF_LIM_CALOR	Differential for Set.Limit in winter with "ON-OFF with SET limit of ON"	1	0	99,9	°C	Analog	R/W	81
PH11	DIF_LIM_FRIO	Differential for Set.Limit in summer with "ON-OFF with SET limit of ON"	2	0	99,9	°C	Analog	R/W	80
PH12	LUN_A	Monday schedule (0=off; 1=program1; 2=program2; 3=program3)	1	0	3	---	Integer	R/W	110
PH12	MAR_A	Tuesday schedule (0=off; 1=program1; 2=program2; 3=program3)	1	0	3	---	Integer	R/W	111
PH12	MIE_A	Wednesday schedule (0=off; 1=program1; 2=program2; 3=program3)	1	0	3	---	Integer	R/W	112
PH12	JUE_A	Thursday schedule (0=off; 1=program1; 2=program2; 3=program3)	1	0	3	---	Integer	R/W	113
PH12	VIE_A	Friday schedule (0=off; 1=program1; 2=program2; 3=program3)	3	0	3	---	Integer	R/W	114
PH12	SAB_A	Saturday schedule (0=off; 1=program1; 2=program2; 3=program3)	0	0	3	---	Integer	R/W	115
PH12	DOM_A	Sunday schedule (0=off; 1=program1; 2=program2; 3=program3)	0	0	3	---	Integer	R/W	116
PH13	MOD_SCHED_GRAHP_CIAT	Selection for each day of the week of setpoint CONFORT, ECONOMY, BUILDING PROTECTION and OFF mode for each half-hour.	---	---	---	---	---	---	---
PH14	SET_INT_FRIO	Setpoint for CONFORT time slots in summer	26	°C	-99,9	99,9	Analog	R/W	61
PH14	SET_EXT_FRIO	Setpoint for ECONOMY time slots in summer	28	°C	-99,9	99,9	Analog	R/W	59
PH14	SET_EXT_LIM_FRIO	Setpoint for BUILDING PROTECTION time slots in summer	34	°C	-99,9	99,9	Analog	R/W	77
PH14	DIF_LIM_FRIO	Differential for the setpoint of BUILDING PROTECTION in summer	2	°C	0	99,9	Analog	R/W	80
PH15	SET_INT_CALOR	Setpoint for CONFORT time slots in winter	21	°C	-99,9	99,9	Analog	R/W	60
PH15	SET_EXT_CALOR	Setpoint for ECONOMY time slots in winter	19	°C	-99,9	99,9	Analog	R/W	58
PH15	SET_EXT_LIM_CALOR	Setpoint for BUILDING PROTECTION time slots in winter	13	°C	-99,9	99,9	Analog	R/W	76
PH15	DIF_LIM_CALOR	Differential for the setpoint of BUILDING PROTECTION in winter	1	°C	0	99,9	Analog	R/W	81

## 27.2. Parameters of the TECHNICAL MENU

### USER displays

Display	Parameter	Description of the parameter	Value	Minimum	Maximum	Unit	Type	R/W	Add.
<b>USER: CONTROL</b>									
L01	LANGUAGE	Selection of language	0: Spanish	0: Spanish 1: French 2: English 3: Italian 4: Turkish 5: German		---	Integer	R/W	63
U01	LIM_SUP_TEMP	Upper limit of temperature setpoint in COOLING mode (summer)	30,0	20	50	°C	Analog	R/W	19
U01	LIM_INF_TEMP	Lower limit of temperature setpoint in COOLING mode (summer)	15,0	0	30	°C	Analog	R/W	20
U01a	LIM_SUP_TEMP_CALOR	Upper limit of temperature setpoint in HEATING mode (winter)	30,0	20	50	°C	Analog	R/W	148
U01a	LIM_INF_TEMP_CALOR	Lower limit of temperature setpoint in HEATING mode (winter)	15,0	0	30	°C	Analog	R/W	149
U02	BANDA_TEMP_FRIO	Control band of temperature in COOLING mode (summer)	2°C	0	15	°C	Analog	R/W	21
U02	BANDA_TEMP_CALOR	Control band of temperature in HEATING mode (winter)	2°C	0	15	°C	Analog	R/W	22
U03	ZONA_MUERTA_TEMP	Dead zone of temperature control	0,0	0	3	°C	Analog	R/W	39
U04	LIM_INF_HUM	Lower limit of humidity setpoint	25,0	0	LIM_SUP_HUM	%rH	Analog	R/W	24
U04	LIM_SUP_HUM	Upper limit of humidity setpoint	80,0	LIM_INF_HUM	99,9	%rH	Analog	R/W	23
U05	BANDA_HUMEDAD	Humidity control band	5,0	0	99,9	%rH	Analog	R/W	17
U05	ZONA_MUERTA_HUM	Dead zone of humidity control	4,0	0	50	%rH	Analog	R/W	40
U07	DELTA_FREE_COOL	Delta of temperature to enable freecooling	3,0	-5	5	°C	Analog	R/W	27
U07	MAX_APERTURA_COMPUERTA_FREE	Maximum opening of the outdoor air damper with freecooling or freeheating	100 (*)	0	100	%	Integer	R/W	208
U08	PR_ENT_DIF	Delta of enthalpy to enable freecooling (whole part)	1	0	99	kc/kg	Integer	R/W	20
U08	SEC_ENT_DIF	Delta of enthalpy to enable freecooling (decimal part)	0	0	999	kc/kg	Integer	R/W	21
U08	MAX_APERTURA_COMPUERTA_FREE	Maximum opening of the outdoor air damper with freecooling or freeheating	100 (*)	0	100	%	Integer	R/W	208
U09	OFFSET_FCOOL	Offset of freecooling damper according to summer setpoint	-1,0	-5	5	°C	Analog	R/W	28
U09	DIF_FCOOL	Differential of freecooling damper according to the previous offset	1,0	0	5	°C	Analog	R/W	29
U10	OFFSET_FHEAT	Offset of freeheating damper according to winter setpoint	-2,0	-5	5	°C	Analog	R/W	30
U10	BANDA_FHEAT	Differential of freeheating damper according to the previous offset	2,0	0	5	°C	Analog	R/W	31
U11	SET_RENOVACION	% Outdoor air for refreshing	20% 60%(recovery)	0	99	%	Integer	R/W	36
U11b	POS_COMPUERTA_CALOR_AL_INICIO	Outdoor damper in the start-up in winter	1: Closed	0: Normal 1: Closed		---	Digital	R/W	54
U11b	POS_COMPUERTA_FRIO_AL_INICIO	Outdoor damper in the start-up in summer	0: Normal	0: Normal 1: Closed		---	Digital	R/W	243
U11b	MIN_APERTURA_COMPUERTA	Minimum opening of the outdoor air damper	0	0	100	%	Integer	R/W	165
U11b	MAX_APERTURA_COMPUERTA	Maximum opening of the outdoor air damper	100 (*)	0	100	%	Integer	R/W	131
U11c	TIME_APERTURA_COMPUERTA	Opening time of the outdoor air damper	90	0	999	s	Integer		
U11c	SET_POINT_FRIO_ON_EQUIPO	Temperature setpoint in COOLING for unit ON with 100% outside air	30.0	-99,9	99,9	°C	Analog		
U11c	SET_POINT_CALOR_ON_EQUIPO	Temperature setpoint in HEATING for unit ON with 100% outside air	17.0	-99,9	99,9	°C	Analog		
U11d	TIME_RET_ON_VINT	Opening time of supply and return dampers	150	0	999	s	Integer	R/W	216
U12b	OFFSET_CAL_IMP_FRIO	Compensation of the ambient temperature in order to calculate the outlet setpoint (SET) in COOLING mode	17,0	0	30	°C	Analog	R/W	114
U12 U12b	SET_IMPULSION_FRIO_MIN	Minimum outlet temperature limit setpoint	10,0	0	SET_IMPULSION_FRIO_MAX	°C	Analog	R/W	32

(\*) Maximum opening of the outdoor damper of 75% in Space PF 650 to 1200



## USER displays

Display	Parameter	Description of the parameter	Value	Minimum	Maximum	Unit	Type	R/W	Addr.
<b>USER: CONTROL (...continued)</b>									
U12b	SET_IMPULSION_FRIO_MAX	Maximum outlet temperature limit setpoint	22,0	SET_IMPULSION_FRIO_MIN	30	°C	Analog	R/W	115
U12 U12b	BANDA_IMP_FRIO	Limit of differential of minimum discharge temperature	5,0	0	20	°C	Analog	R/W	33
U12c	OFFSET_CAL_IMP_CALOR	Compensation of the ambient temperature in order to calculate the outlet setpoint (SET) in HEATING mode	25,0	0	30	°C	Analog	R/W	112
U12c	SET_IMPULSION_CALOR_MIN	Minimum outlet temperature limit setpoint	30,0	25	SET_IMPULSION_CALOR_MAX	°C	Analog	R/W	113
U12a U12c	SET_IMPULSION_CALOR_MAX	Maximum outlet temperature limit setpoint	45,0	SET_IMPULSION_CALOR_MIN	55	°C	Analog	R/W	83
U12a U12c	BANDA_IMP_CALOR	Limit of differential of maximum discharge temperature	5,0	0	20	°C	Analog	R/W	84
U12d	SP_CO2	Setpoint of air quality control	1000	-32767	32767	ppm	Integer	R/W	4
U12d	DIF_CO2	Differential of air quality control	500	-32767	32767	ppm	Integer	R/W	5
U13	SET_COMP_EXT_FRIO	Temperature offset of set in summer	30,0	-99,9	99,9	°C	Analog	R/W	34
U13	VAL_DIF_COMP_EXT_FRIO	Differential offset of set in summer	5,0	-99,9	99,9	°C	Analog	R/W	35
U13	MAX_COMP_EXT_FRIO	Maximum offset of set in summer	5,0	0	99,9	°C	Analog	R/W	36
U14	SET_COMP_EXT_CALOR	Temperature offset of set in winter	0,0	-99,9	99,9	°C	Analog	R/W	64
U14	VAL_DIF_COMP_EXT_CALOR	Differential offset of set in winter	5,0	-99,9	99,9	°C	Analog	R/W	65
U14	MAX_COMP_EXT_CALOR	Maximum offset of set in winter	5,0	0	99,9	°C	Analog	R/W	66
U19	NUM_COMP_DESHUM	Number of compressors in dehumidification	0	0	NUM_COMPRESORES	---	Integer	R/W	22
U20	BANDA_RES	Differential of electrical heaters control or gas burner in winter	2,0	0	5	°C	Analog	R/W	53
U20	OFFSET_RES	Offset of electrical heaters control or gas burner in winter	-2,0	-5	5	°C	Analog	R/W	52
U20	SET_HAB_RES_TEMP_EXT	Setpoint for enabling the electrical heaters by the outdoor temperature	20,0	-20	40	°C	Analog	R/W	129
U28	OFFSET_VALV_CALOR	Setpoint of 3-way valve control in winter	-2,0	-10	0	°C	Analog	R/W	62
U28	BANDA_VALV_CALOR	Offset of 3-way valve control in winter	2,0	0	5	°C	Analog	R/W	63
U28	HAB_PRIORIDAD_BAC	Priority of 3-way valve control to the compressor	0: no	0: no 1: yes		---	Digital	R/W	132
U28b	OFFSET_VALV_FRIO	Setpoint of 3-way valve control in cooling	2,0	0	10	°C	Analog	R/W	220
U28b	BANDA_VALV_FRIO	Offset of 3-way valve control in cooling	2,0	0	5	°C	Analog	R/W	221
U28b	HAB_PRIORIDAD_BAC_FRIO	Priority to the compressor of 3-way valve control in cooling	0: no	0: no 1: yes		---	Digital	R/W	209
U20b	OFFRESVER	Offset of elec. heaters control in summer	-7,0	-99,9	0	°C	Analog	R/W	73
U20b	OFFVLVVER	Offset of 3 ways valve control in summer	-5,0	-99,9	0	°C	Analog	R/W	74
U35a	HAB_ZONIFICACION_1_ZONA_POR_VAR	Enable power and flow reduction for the zoning of the unit	0: no	0: no 1: yes		---	Digital	R/W	68
U35a	POR_CAUDAL_50_PORC_COMP_TANDEM	% flow of fan with selection of automatic flow reduction	50,0	50	75	%	Analog	R/W	150
U35a	HAB_ZONA1_PARA_ZONIF_COMPUERTAS	Enabling of zone 1 with the optional of zoning by damper	0: no	0: no 1: yes		---	Digital	R/W	248
U35a	HAB_ZONA2_PARA_ZONIF_COMPUERTAS	Enabling of zone 2 with the optional of zoning by damper	0: no	0: no 1: yes		---	Digital	R/W	249
U35b	HAB_RED_CAUDAL_CON_COMP_TANDEM	Enable the automatic reduction of flow with 50% power in tandem compressors	0: no	0: no 1: yes		---	Digital	R/W	207
U35b	POR_CAUDAL_50_PORC_COMP_TANDEM	% flow of fan with selection of automatic flow reduction	50,0	50	75	%	Analog	R/W	150
U36	DESCONEXION_NUM_COMPRESORES	Number of compressor stages to disconnect	0	0	NUM_ETAPAS_COMPRESOR	---	Integer	R/W	128
U36	DESCONEXION_NUM_RESISTENCIAS	Number of elec. heaters stages to disconnect	0	0	NUM_RES	---	Integer	R/W	129
U36	HAB_OFF_ETAPAS_POR_DIN	Enabling OFF of compressor stages or resistances stages by digital inputs of expansion module	0: no	0: no 1: yes		---	Digital		
U37	NEW_PASS_UT	New password of USER	****	0	9999	---	Integer	R/W	28

## USER displays

Display	Parameter	Description of the parameter	Value	Minimum	Maximum	Unit	Type	R/W	Addr.
<b>USER: COMUNICACION</b>									
U36a	TIPO_PROT_COM	Type of protocol in supervision network	0: Carel	0: Carel 1: LonWorks 2: Modbus 3: Commissioning 4: Modbus extended		---	Integer		
U36b	BMS_ADDRESS	Address of supervisory network	1	0	207	---	Integer		
U36b	BAUD_RATE	Baudrate for the supervisory connection	4: 19200	0: 1200 1: 2400 2: 4800 3: 9600 4: 19200		---	Integer		
U36b	Stop_bits_Number_MB	Number of stop bits for the MODBUS protocol	0: 2 bits	0: 2 bits 1: 1 btis		---	Digital		
U36b	Parity_Type_MB	Type of parity for the MODBUS protocol	0: no	0: no 1: couple 2: odd		---	Integer		
U36c	HAB_DETECCION_FALLO_COM_BMS	Enabling BMS communication failure detection	0: NO	0: no 1: sí		---	Digital	R/W	173
U36c	TIME_PERDIDA_COMUNICACION_BMS	Time to enable the load of default parameters for loss of communication.	15	0	99	min	Integer		
U36c	VAR_DETECCION_FALLO_BMS	Variable to change by the BMS for not to produce communication loss (1 -> 0)	0: NO	0: no 1: sí		---	Digital	R/W	174
U36c	PERDIDA_COMUNICACION_BMS	Variable of the signaling BMS communication loss	0: NO	0: no 1: sí		---	Digital		
U40a	SET_POINT_TEMP_FRIO_BMS	Summer air setpoint	26,0	LIM_INF_TEMP	LIM_SUP_TEMP	°C	Analog		
U40a	SET_POINT_TEMP_CALOR_BMS	Winter air setpoint	21,0	LIM_INF_TEMP	LIM_SUP_TEMP	°C	Analog		
U40b	SYS_ON_BMS	OFF/ ON of the unit via the keyboard	1: on	0: off 1: on		---	Digital		
U40c	SEL_FRIO_CALOR_BMS	Selection of winter/summer mode	2: auto	0: by keyboard 1: by digital input (remote) 2: auto		---	Integer		
U40c	MODO_FRIO_CALOR_AUTO_BMS	Mode of winter/summer selection in automatic	0: indoor T.	0: by indoor temperature 1: by outdoor temperature		---	Digital		
U40c	CALOR_FRIO_PANEL_BMS	Winter / summer by keyboard	1: summer	0: winter 1: summer		---	Digital		
U40d	DESCONEXION_NUM_COMPRESORES_BMS	Number of compressor stages to disconnect.	0	0	NUM_ETAPAS_COMPRESOR	---	Integer		
U40d	DESCONEXION_NUM_RESISTENCIAS_BMS	Number of elec. heaters stages to disconnect	0	0	NUM_RES	---	Integer		
U40e	TIPO_PROG_HORARIA_BMS	Type of start-up	0: ON/OFF program	0: ON/OFF program		---	Integer		
U40f	H_ARR_1A_BMS	Start-up hour of slot 1- program 1	9	0	23	h	Integer		
U40f	M_ARR_1A_BMS	Start-up minute of slot 1-program 1	0	0	59	min	Integer		
U40f	H_PAR_1A_BMS	Stop hour of slot 1 - program 1	21	0	23	h	Integer		
U40f	M_PAR_1A_BMS	Stop minute of slot 1 - program 1	0	0	59	min	Integer		
U40f	H_ARR_1B_BMS	Start-up hour of slot 2 - program 1	0	0	23	h	Integer		
U40f	M_ARR_1B_BMS	Start-up minute of slot 2 - program 1	0	0	59	min	Integer		
U40f	H_PAR_1B_BMS	Stop hour of slot 2 - program 1	0	0	23	h	Integer		
U40f	M_PAR_1B_BMS	Stop minute of slot 2 - program 1	0	0	59	min	Integer		
U40f	H_ARR_1C_BMS	Start-up hour of slot 3 - program 1	0	0	23	h	Integer		
U40f	M_ARR_1C_BMS	Start-up minute of slot 3 - program 1	0	0	59	min	Integer		
U40f	H_PAR_1C_BMS	Stop hour of slot 3 - program 1	0	0	23	h	Integer		





## USER displays

Display	Parameter	Description of the parameter	Value	Minimum	Maximum	Unit	Type	R/W	Address
<b>USER: COMUNICACION ( ...continued)</b>									
U40f	M_PAR_1C_BMS	Stop minute of slot 3 - program 1	0	0	59	min	Integer		
U40g	LUN_A_BMS	Monday schedule (0=off; 1=program1; 2=program2; 3=program3)	1	0	3	---	Integer		
U40g	MAR_A_BMS	Tuesday schedule (0=off; 1=program1; 2=program2; 3=program3)	1	0	3	---	Integer		
U40g	MIE_A_BMS	Wednesday schedule (0=off; 1=program1; 2=program2; 3=program3)	1	0	3	---	Integer		
U40g	JUE_A_BMS	Thursday schedule (0=off; 1=program1; 2=program2; 3=program3)	1	0	3	---	Integer		
U40g	VIE_A_BMS	Friday schedule (0=off; 1=program1; 2=program2; 3=program3)	1	0	3	---	Integer		
U40g	SAB_A_BMS	Saturday schedule (0=off; 1=program1; 2=program2; 3=program3)	1	0	3	---	Integer		
U40g	DOM_A_BMS	Sunday schedule (0=off; 1=program1; 2=program2; 3=program3)	1	0	3	---	Integer		
<b>USER: OTHER</b>									
U18a	AUTOSTART	Automatic start after blocking	1: yes	0: no 1: yes		---	Digital	R/W	58
U18a	TIME_ON_AUTOSTART	Timing for the automatic start after a power failure	5	5	999	sec	Integer	R/W	166
U18a1	HAB_ONOFF_REMOTO	Enabling of remote ON/OFF	1: yes	0: no 1: yes		---	Digital	R/W	59
U18a1	HAB_OFF_REMOTO_CON_PROTECCION	Enabling of building protection when the unit is turned OFF by the remote input ON / OFF.	0: no	0: no 1: yes		---	Digital		
U18a1	HAB_BLOQ_COMP_ON_FASE_LIM_FRIO	Disable the compressors in summer with scheduling and setpoint limit in summer (freecooling night)	0: no	0: no 1: yes		---	Digital	R/W	72
U18a1	HAB_BLOQ_RENOVACION_ON_FASE_LIM	Disable the outdoor air exchange and scheduling limit setpoint (night)	0: no	0: no 1: yes		---	Digital	R/W	73
U18a2	SET_EXT_LIM_FRIO	Setpoint for BUILDING PROTECTION time slots in summer	34	-99,9	99,9	°C	Analog	R/W	77
U18a2	DIF_LIM_FRIO	Differential for the setpoint of BUILDING PROTECTION in summer	2	0	99,9	°C	Analog	R/W	80
U18a2	SET_EXT_LIM_CALOR	Setpoint for BUILDING PROTECTION time slots in winter	13	-99,9	99,9	°C	Analog	R/W	76
U18a2	DIF_LIM_CALOR	Differential for the setpoint of BUILDING PROTECTION in winter	1	0	99,9	°C	Analog	R/W	81
U18b	TIME_PANT	pGD1 control led switch on time	30	0	999	sec	Integer		
U18c	HAB_G_PRINC	Enable automatic back function to menu page	0: no	0: no 1: yes		---	Digital		
U18c	TIME_RETURN_MENU	Time without operation on the terminal for automatic return	120	0	999	sec	Integer		

## MANUFACTURER displays

Display	Parameter	Description of the parameter	Value	Minimum	Maximum	Unit	Type	R/W	Addr.
<b>MANUFACTURER: UNIT CONFIGURATION</b>									
CU01	MODELO_EQUIPO	Unit model (only PF series)	0: -----	0...44 (only PF series)		---	Integer	R/W	58
CU01	TIPO_EQUIPO	Unit type	0: air-air	0: air-air 1: water-air		---	Integer	R/W	182
CU01	HAB_BOMBA_CALOR	Heat pump	1: heat pump	0: cooling only 1: heat pump		---	Digital	R/W	45
CU01	NUM_WO_DIG_1	Work Order Number of unit - DIGIT 1	0	0	9	---	Analog	R/W	185
CU01	NUM_WO_DIG_2	Work Order Number of unit - DIGIT 2	0	0	9	---	Analog	R/W	186
CU01	NUM_WO_DIG_3	Work Order Number of unit - DIGIT 3	0	0	9	---	Analog	R/W	187
CU01	NUM_WO_DIG_4	Work Order Number of unit - DIGIT 4	0	0	9	---	Analog	R/W	188
CU01	NUM_WO_DIG_5	Work Order Number of unit - DIGIT 5	0	0	9	---	Analog	R/W	189
CU01	NUM_WO_DIG_6	Work Order Number of unit - DIGIT 6	0	0	9	---	Analog	R/W	190
CU01	NUM_WO_DIG_7	Work Order Number of unit - DIGIT 7	0	0	9	---	Analog	R/W	191
CU01	NUM_WO_DIG_8	Work Order Number of unit - DIGIT 8	0	0	9	---	Analog	R/W	192
CU02	NUM_COMP_CIRC	Number of compressors	1: 1 compr./ 1 circuit	0: No compressor 1: 1 compr./ 1 circuit 2: 2 compr./ 1 circuit 3: 2 compr./ 2 circuits 4: 2 compr. + 1 part. 5: 2 compr. (3 stages) 6: 4 compr./ 2 circuits 7: 4 compr./ 4 circuits		---	Integer	R/W	60
CU02	HAB_UNICO_VOL_AIRE_EXT	Enabling a single volume of outdoor air	0: no	0: no 1: yes		---	Digital	R/W	57
CU03	CONF_OUT07	Digital output configuration OUT07	3: alarm	0: humidifier 1: pump in HWC circuit 2: recovery compressor 3: alarm 4: --- 5: rotary recovery oper.		---	Integer	R/W	117
CU03	SET_ON_VALV_CALOR_POR_BAJA_TEXT	Setpoint by start-up pump and heat valve of H.W.C. for low outdoor temperature	4,0	-10	10	°C	Analog	R/W	82
CU03	MIN_APERTURA_VALV_CALOR	Minimum opening of heat valve with low outdoor temperature and unit ON	10	0	100	%	Integer	R/W	211
CU03	TIME_RET_OFF_BOMBA_BAC	Delay time to stop of the H.W.C. pump	60	0	999	s	Integer	R/W	210
CU03	MIN_APERTURA_ON_REC	Minimum opening of outdoor damper for ON recovery compressor	10	0	99	%	Integer	R/W	68
CU03	TIME_MIN_APERTURA_ON_REC	Time with minimum opening of outdoor damper for ON recovery compressor	90	0	999	sec	Integer	R/W	9
CU03	HAB_BOMBA_CALOR_COMP_REC	Recovery compressor - Heat pump	1: rec. comp heat pump	0: rec. comp cooling only 1: rec. comp heat pump		---	Digital	R/W	203
CU03	HAB_COMPUERTA_CON_DESESCARCHE	Enabling the opening of outdoor air damper door during the defrost with the selection passive recuperation by wheel	0: no	0: no 1: yes		---	Digital		
CU03	HAB_REC_ROTATIVO_VARIABLE	Enabling of rotary recovery with variable wheel	0: no	0: no 1: yes		---	Digital	R/W	247
CU03a	CONF_OUT01_MOD_N8	Configuración salida digital OUT01 del modulo de expansión PCOE n°8	6: -----	0: humidifier 1: pump in HWC circuit 2: recovery compressor 3: alarm 4: --- 5: rotary recovery oper. 6: -----		---	Integer	R/W	218
CU03b	CONF_OUT04_MOD_N8	Configuración salida digital OUT04 del modulo de expansión PCOE n°8	6: -----	0: humidifier 1: pump in HWC circuit 2: recovery compressor 3: alarm 4: --- 5: rotary recovery oper. 6: -----		---	Integer	R/W	219
CU03c	SET_TEMP_MAX_AOUT_REC_ROT_VAR	Temperature setpoint for maximum output of the variable rotary recovery	6,0	0,0	20,0	°C	Integer	R/W	
CU03c	SET_TEMP_MIN_AOUT_REC_ROT_VAR	Temperature setpoint for minimum output of the variable rotary recovery	1,0	0,0	20,0	°C	Integer	R/W	
CU03c	MAX_AOUT_REC_ROT_VARIABLE	Maximum analog output for variable rotary recovery	100	30	100	%	Integer	R/W	
CU03c	MIN_AOUT_REC_ROT_VARIABLE	Minimum analog output for variable rotary recovery	10	0	100	%	Integer	R/W	



## MANUFACTURER displays

Display	Parameter	Description of the parameter	Value	Minimum	Maximum	Unit	Type	R/W	Addr.
<b>MANUFACTURER: UNIT CONFIGURATION (...continued)</b>									
CU04	TIPO_VENT_INT	Type of indoor circuit supply fan	1: centrif. 2: radial 3: radial plug-fan 4: centrifugal + VFD	---	---	---	Integer	R/W	196
CU04	NUM_VINT_PLUG_FAN	Number of indoor circuit supply plug-fan	2	0	9	---	Integer		
CU04	CTE_CALCULO_CAUDAL_VINT	Constant calculation for supply plug-fan	260	0	999	---	Integer		
CU04	CAUDAL_VINT_NOMINAL	Nominal flow for supply plug-fan	1200	0	9999	x10 m3/h	Integer		
CU04	PORC_CAUDAL_VINT_MIN	Minimum flow rate for supply plug-fan	-20	-99	0	%	Integer		
CU04	PORC_CAUDAL_VINT_MAX	Maximum flow rate for supply plug-fan	20	0	99	%	Integer		
CU04	Polea_MOTOR_INT	Diameter in mm of the pulley installed on the indoor motor	170	0	999	---	Integer		
CU04	Polea_VENT_INT	Diameter in mm of the pulley installed on the indoor fan	260	0	999	---	Integer		
CU04	Pda_VENT_INT_min	Point differential pressure minimum of indoor fan	125	0	9999	Pa	Integer		
CU04	Rpm_VENT_INT_min	Point rpm minimum of indoor fan	592	0	9999	rpm	Integer		
CU04	Pda_VENT_INT_max	Point differential pressure maximum of indoor fan	600	0	9999	Pa	Integer		
CU04	Rpm_VENT_INT_max	Point rpm maximum of indoor fan	962	0	9999	rpm	Integer		
CU04a	MOD_MB_VFD_CIAT_1.Sel_Scale_Current	Frequency inverter type for indoor motor	0	0	1	---	Digital		
CU04a	MOD_MB_VFD_CIAT_1.Nominal_Volt	Nominal voltage of indoor motor	400	180	690	V	Integer		
CU04a	MOD_MB_VFD_CIAT_1.Motor_Cosfi	Cos phi of indoor motor	85	30	99	---	Integer		
CU04a	MOD_MB_VFD_CIAT_1.Nominal_Frequency	Nominal frequency of indoor motor	50.0	30.0	320.0	Hz	Analog		
CU04a	MOD_MB_VFD_CIAT_1.Nominal_Speed	Nominal speed of indoor motor	1440	300	20000	rpm	Integer		
CU04a	MOD_MB_VFD_CIAT_1.Nominal_Current	Nominal current of indoor motor	0	0	999.9	A	Analog		
CU04a	MOD_MB_VFD_CIAT_1.Current_Limit	Current limit of indoor motor	0	0	999.9	A	Analog		
CU04c	HAB_COMP_REG_PRES_U_INT	Enabling of the damper for control of the indoor unit pressure	0: no 1: yes	---	---	---	Digital		
CU04c	MAX_AOUT_VENT_INT_FRIO	Max. analogue output for the indoor fan in COOLING mode	100	30	100	%	Integer		
CU04c	MAX_AOUT_VENT_INT_CALOR	Max. analogue output for the indoor fan in HEATING mode	100	30	100	%	Integer		
CU04c	MIN_AOUT_VENT_INT	Min. analogue output for the indoor fan	0	0	100	%	Integer		
CU041	TIPO_VENT_RET	Type of indoor circuit return fan	0: none 1: centrifugal 2: radial 3: radial plug-fan 4: centrifugal + VFD	---	---	---	Integer	R/W	202
CU041	NUM_VRET_PLUG_FAN	Number of indoor circuit return plug-fan	2	0	9	---	Integer		
CU041	CTE_CALCULO_CAUDAL_VRET	Constant calculation for return plug-fan	260	0	999	---	Integer		
CU041	CAUDAL_VRET_NOMINAL	Nominal flow for return plug-fan	1200	0	9999	x10 m3/h	Integer		
CU041	PORC_CAUDAL_VRET_MIN	Minimum flow rate for return plug-fan	-30	-99	0	%	Integer		
CU041	PORC_CAUDAL_VRET_MAX	Maximum flow rate for return plug-fan	00	0	99	%	Integer		
CU041	HAB_CONTROL_SOBREPRESION	Enable the overpressure control	no	0: no 1: yes	---	---	Digital	R/W	71
CU041	Polea_MOTOR_RET	Diameter in mm of the pulley installed on the return motor	170	0	999	---	Integer		
CU041	Polea_VENT_RET	Diameter in mm of the pulley installed on the return fan	260	0	999	---	Integer		
CU041	Pda_VENT_RET_min	Point differential pressure minimum of return fan	125	0	9999	Pa	Integer		
CU041	Rpm_VENT_RET_min	Point rpm minimum of return fan	592	0	9999	rpm	Integer		
CU041	Pda_VENT_RET_max	Point differential pressure maximum of return fan	600	0	9999	Pa	Integer		
CU041	Rpm_VENT_RET_max	Point rpm maximum of return fan	962	0	9999	rpm	Integer		
CU04b	MOD_MB_VFD_CIAT_2.Sel_Scale_Current	Frequency inverter type for return motor	0	0	1	---	Digital		
CU04b	MOD_MB_VFD_CIAT_2.Nominal_Volt	Nominal voltage of return motor	400	180	690	V	Integer		

## MANUFACTURER displays

Display	Parameter	Description of the parameter	Value	Minimum	Maximum	Unit	Type	R/W	Address
<b>MANUFACTURER: UNIT CONFIGURATION (...continued)</b>									
CU04b	MOD_MB_VFD_CIAT_2.Motor_Cosfi	Cos phi of return motor	85	30	99	---	Integer		
CU04b	MOD_MB_VFD_CIAT_2.Nominal_Frequency	Nominal frequency of return motor	50.0	30.0	320.0	Hz	Analog		
CU04b	MOD_MB_VFD_CIAT_2.Nominal_Speed	Nominal speed of return motor	1440	300	20000	rpm	Integer		
CU04b	MOD_MB_VFD_CIAT_2.Nominal_Current	Nominal current of return motor	0	0	999.9	A	Analog		
CU04b	MOD_MB_VFD_CIAT_2.Current_Limit	Current limit of return motor	0	0	999.9	A	Analog		
CU05	TIPO_VENT_EXT	Type of outdoor fan	3: 2-speed axial				1: centrifugal 2: axial / radial 3: 2-speed axial 4: electronic	---	Integer R/W 1
CU05	MAX_AOUT_VENT_EXT_FRIO	Maximum analogue output for the outdoor fan in COOLING mode	100	30	100	%	Integer		
CU05	MAX_AOUT_VENT_EXT_CALOR	Maximum analogue output for the outdoor fan in HEATING mode	100	30	100	%	Integer		
CU05	MIN_AOUT_VENT_EXT	Minimum analogue output for the outdoor fan	0	0	100	%	Integer	R/W	184
CU05a	VAL_INI_VEXT_ALTA_VEL_COND	Final value of the outdoor fan at high speed in condensation	R410A - 34.0 bar R407C - 22.5 bar	0	60	bar	Analog	R/W	68
CU05a	VAL_FIN_VEXT_ALTA_VEL_COND	Initial value of the outdoor fan at high speed in condensation	R410A - 27.0 bar R407C - 17.0 bar	0	60	bar	Analog	R/W	70
CU05a	VAL_FIN_VEXT_ALTA_VEL_EVAP	Final value of the outdoor fan at high speed in evaporation	R410A - 10.0 bar R407C - 5,7 bar	0	60	bar	Analog	R/W	101
CU05a	VAL_INI_VEXT_ALTA_VEL_EVAP	Initial value of the outdoor fan at high speed in evaporation	R410A - 8.0 bar R407C - 4.6 bar	0	60	bar	Analog	R/W	103
CU05a	TIME_CAMBIO_VEL_VEXT	Timing for changing the speed of the outdoor fan	2	1	10	sec	Integer		
CU05b	HAB_COMP_REG_PRES_U_EXT	Enable damper for controlling the pressure of the outdoor unit	0: no	0: no 1: yes			---	Digital	R/W 169
CU06	HAB_QUEMADOR_GAS	Gas burner activation	0: no	0: no 1: yes			---	Digital	R/W 86
CU07	HAB_RES_DESESCARCHE	Enable elec. heaters or gas burner in defrostings	0: no	0: no 1: yes			---	Digital	R/W 99
CU07	NUM_RES	Number of elec. heaters	0: -----				0: ----- 1: 1 electrical heater 2: 2 electrical heaters 3: 2 el. heaters (3 st.) 4: proportional	---	Integer R/W 41
CU07	NUM_RES_DES	Number of elec. heaters during defrosting	0	0	NUM_RES	---	Integer	R/W	61
CU07	VAL_BAC_DESESCARCHE	% elec. heating in defrostings	100	0	100	%	Integer		
CU07	HAB_RES_SIN_COMPRESOR	Enabling electric heater only for replacing the compressor	0: no	0: no 1: yes			---	Digital	R/W 181
CU08	HAB_VALVULA_CALOR	Heating valve	0: no	0: no 1: yes			---	Digital	R/W 103
CU08	HAB_VALVULA_FRIO	Cooling valve	0: no	0: no 1: yes			---	Digital	R/W
CU08	HAB_VALVULA_CALOR_ON_OFF	Enable hot water coil valve on-off	0: proportional	0: proportional 1: on-off			---	Digital	R/W
CU08	HAB_BAC_DESESCARCHE	Enable heating valve in defrostings	0: no	0: no 1: yes			---	Digital	R/W 129
CU08	VAL_BAC_DESESCARCHE	% heating valve in defrostings	100	0	100	%	Integer		
CU08	HAB_PROT_ANTIHIELO_BAC_GF	Enabling the antifreeze protection of the hot water coil with low outdoor temperatures	0: no	0: no 1: yes			---	Digital	R/W 128
CU08a	SET_ANTIHIELO_AGUA_BAC	Antifreeze protection setpoint of the hot water coil with low outdoor temperatures	4,0	-20,0	10,0	°C	Analog	R/W	229
CU08a	DIF_ANTIHIELO_AGUA_BAC	Differential for reset of the antifreeze protection of the hot water coil	3,0	0,0	10,0	°C	Analog	R/W	230

## MANUFACTURER displays

Display	Parameter	Description of the parameter	Value	Minimum	Maximum	Unit	Type	R/W	Addr.
<b>MANUFACTURER: UNIT CONFIGURATION (...continued)</b>									
CU08b	SET_TEMP_AGUA_BAC	Water temperature setpoint of the hot water coil	10,0	0,0	20,0	°C	Analog	R/W	56
CU08b	OFFSET_TEMP_AGUA_BAC	Water temperature offset of the hot water coil with OFF unit	5,0	0,0	10,0	°C	Analog	R/W	51
CU08b	BANDA_TEMP_AGUA_BAC	Band of the water temperature setpoint of the hot water coil	2,0	0,0	5,0	°C	Analog	R/W	57
CU09	HAB_MB_SOND_AMB	Enable Ambient probe	1: yes	0: no 1: yes		---	Digital	R/W	167
CU09	CONTROL_SOND_AMB	Ambient temperature control	1: ambient T	0: return T 1: ambient T		---	Digital	R/W	189
CU09	TIPO_SONDA_AMB	Type of ambient probe	4: 1 probe NTC	1: 1 probe RS485 2: 2 probes RS485 3: shared in pLAN 4: 1 probes NTC 5: 3 probes RS485 6: 4 probes RS485 7: probe 4-20 mA					
CU09	SEL_TEMP_2_SOND_AMB_FRIO	Selection of temperature value with ambient probes in COOLING mode	0: average	0: average 1: minimum 2: maximum		---	Integer		
CU09	SEL_TEMP_2_SOND_AMB_CALOR	Selection of temperature value with ambient probes in HEATING mode	0: average	0: average 1: minimum 2: maximum		---	Integer		
CU10	HAB_SONDA_TEMP_IMP	Discharge probe	1: yes	0: no 1: yes		---	Digital	R/W	48
CU10	TIPO_TEMP_EXT	Outdoor temperature probe	1: actual	0: no 1: actual 2: pLAN		---	Integer	R/W	54
CU10	TIPO_SONDA_HUM_INT	Internal relative humidity probe	no (enable with enthalpic FC)	0: no 1: actual 2: virtual 3: pLAN 4: RS485		---	Integer	R/W	56
CU10	TIPO_SONDA_HUM_EXT	Outdoor humidity probe	no (enable with enthalpic FC)	0: no 1: actual 2: pLAN		---	Integer	R/W	55
CU10	HAB_SONDA_BAT_EXT	Enabling the outdoor coil sensor	1: yes	0: no 1: yes		---	Digital	W	78
CU10	HAB_SONDA_BAT_INT	Enabling the indoor coil sensor	0: no	0: no 1: yes		---	Digital	W	79
CU10a	HAB_CONTROL_HUM_DESHUM	Humidity management	0: no	0: no 1: yes		---	Digital	R/W	47
CU10a	HAB_HUMIDIFICA	Enabling humidification function	0: on-off	0: no 1: on-off 2: proportional		---	Integer	R/W	190
CU10a	NUM_COMP_DESHUM	Number of compressors in dehumidification	0	0	NUM_COMPRESORES	---	Integer	R/W	22
CU10a	PORCEN_TEMP_ON_DESH	% Indoor temperature for dehumidification compressor ON	15	0	100	%	Integer	R/W	189
CU10a	PORCEN_TEMP_OFF_DESH	% Indoor temperature for dehumidification compressor OFF	85	0	100	%	Integer	R/W	188
CU10a	SET_HUM_OFF_COMPUERTA	Setpoint for closing the outer gate by high indoor humidity	100	0	100	%rH	Analog	R/W	130
CU10b	HAB_VALV_CALOR_POR_IMP_MIN_FRIO	Control of minimal outlet T with hot water coil in COOLING mode	0: no	0: no 1: yes		---	Digital	R/W	100
CU10b	HAB_COMP_CALOR_POR_IMP_MIN_FRIO	Control of minimal outlet T with compressors in COOLING mode	0: no	0: no 1: yes		---	Digital	R/W	101
CU10b	HAB_RES_POR_IMP_MIN_FRIO	Control of minimal outlet T with electrical heaters in COOLING mode	0: no	0: no 1: yes		---	Digital	R/W	102
CU10c	HAB_VALV_CALOR_POR_IMP_MIN_CALOR	Control of minimal outlet T with hot water coil with unit in HEATING mode	1: yes	0: no 1: yes		---	Digital		
CU10c	HAB_COMP_CALOR_POR_IMP_MIN_CALOR	Control of minimal outlet T with compressors in heating with unit in HEATING mode	1: yes	0: no 1: yes		---	Digital		
CU10c	HAB_RES_POR_IMP_MIN_CALOR	Control of minimal outlet T with electrical heaters with unit in HEATING mode	1: yes	0: no 1: yes		---	Digital		
CU11	TIPO_SONDA_RENOVACION	Tipe of refreshing probe	1: mixed T	0: None 1: Mixed air temperature 2: Actual air quality probe 3: pLAN air quality probe		---	Integer	R/W	127

## MANUFACTURER displays

Display	Parameter	Description of the parameter	Value	Min.	Max.	Unit	Type	R/W	Addr.
<b>MANUFACTURER: UNIT CONFIGURATION (...continued)</b>									
CU11	HAB_LIM_CO2	Activate air quality control	1: yes	0: no 1: yes		---	Digital	R/W	84
CU11	TIPO_CO2	CO2 control type	1: ppm	0: % 1: ppm		---	Digital		
CU11	SET_TEMP_MEZ	Set mixing air temperature to close the outdoor air damper in HEATING mode (winter)	12.0°C 5.0°C (recovery comp.& refr.motor)	10,0	20,0	°C	Analog	R/W	91
CU11	HAB_SONDA_MEZCLA_CON_CO2	Enabling mixing air probe with CO2 probe (input B4)	0: no	0: no 1: yes		---	Digital	R/W	85
CU11	SET_TEMP_CO2_CALOR	Set mixing air T to close the outdoor air damper in HEATING mode (winter) with CO2 control	17,0	10,0	20,0	°C	Analog	R/W	99
CU11	SET_TEMP_CO2_FRIO	Set mixing air T to close the outdoor air damper in COOLING mode (summer) with CO2 control	30,0	20,0	50,0	°C	Analog	R/W	225
CU11a	SET_TEMP_MEZCLA_CALOR	Set mixing air temperature to close the outdoor air damper in HEATING mode (winter)	12.0°C 5.0°C (recovery comp.& refr.motor)	0,0	20,0	°C	Analog	R/W	91
CU11a	SET_TEMP_MEZCLA_FRIO	Set mixing air temperature to close the outdoor air damper in COOLING mode (summer)	35.0°C 42.0°C (recovery comp. & refr.motor)	20,0	50,0	°C	Analog	R/W	224
CU12	HAB_MB_ENERGY_METER	Enabling power meter	0: no	0: no 1: yes		---	Digital	R/W	190
CU12	HAB_MB_GAS_LEAKAGE_DETECTOR	Enabling gas leakage detector	0: no	0: no 1: yes		---	Digital	R/W	80
CU12	TIPO_RELOJ	Clock card	1: yes	0: no 1: yes		---	Integer	R/W	57
CU12	HAB_PRES_BEXT	Outdoor coil probe type	1: pressure	0: temperature 1: pressure		---	Digital	R/W	134
CU12	TIPO_REFRIGERANTE	Type of refrigerant	4:R410A	0: R22 1: R134A 2: R404A 3: R407C 4: R410A		---	Integer		
CU12a	SEL_FRIO_CALOR	Selection of winter/summer mode	0: panel	0: panel 1: remote 2: auto 3: only ventilation		---	Integer	R/W	59
CU12a	MODO_FRIO_CALOR_AUTO	Selection of winter/summer in automatic mode	1: by outdoor T.	0: by indoor T. 1: by outdoor T.			D	R/W	232
CU12a	HAB_COMPENSACION	Compensation set by outdoor temperature	0: no	0: no 1: yes		---	Digital	R/W	55
CU12a	HAB_PROT_BAJA_TEMP_EXTERIOR	Enabling the protection of outdoor temperature low by digital outputs of expansion module	0: no	0: no 1: yes		---	Digital		
CU12a	HAB_MB_TERMOSTATO_TCO	Enabling of the TCO thermostat by MODBUS	1: yes	0: no 1: yes		---	Digital	R/W	229
CU12b	CONTROL_TCO_SONDA	Selection of the control probe with TCO thermostat (0=TCO, 1=ambient, 2=return)	0: TCO	0: TCO 1: ambient 2: return		---	Integer	R/W	217
CU12b	CONTROL_SONDA_AMB	Ambient temperature control	0: ambient T.	0: return T 1: ambient T		---	Digital	R/W	189
CU12b	ThTune_bloqueado	Keypad lock of the TCO thermostat	0: no	0: no 1: yes		---	Digital	R/W	230
CU12b	Clock_Source_ThTune_or_Pco	Selection of clock source for TCO thermostat or µPC	1: mPC	0: TCO 1: mPC		---	Digital		
CU12b	pCO_ThTune_Scheduler	Selection of scheduler for Pco or TCO thermostat	0: mPC	0: mPC 1: TCO		---	Digital		
CU12b	HAB_CAMBIO_CAUDAL_POR_TCO	Enabling of the flow change by TCO thermostat (Plug-fan supply fan)	0: no	0: no 1: yes		---	Digital		
CU12c	HAB_CONTROL_COMPUERTA_IMP_RET	Enabling of dampers control for supply and return of unit	0: no	0: no 1: yes		---	Digital	R/W	250
CU12d	HAB_ZONIFICACION_POR_VARIABLE	Enabling of the zoning by supervision variable	0: no	0: no 1: yes		---	Digital	R/W	67
CU12d	HAB_ZONIFICACION_POR_COMPUERTAS	Enabling of the zoning by dampers (expansion module I/O)	0: no	0: no 1: yes		---	Digital	R/W	239
CU13	HAB_MB_ENERGY_METER	Enabling electric energy meter	0: no	0: no 1: yes		---	Digital	R/W	190
CU13	HAB_MB_THERMAL_ENERGY_METER	Enabling COOLING / HEATING energy meter	0: no	0: no 1: yes		---	Digital	R/W	237
CU14	HAB_SUPERVISION	Supervisor	1: yes	0: no 1: yes		---	Digital	W	50
CU14	HAB_FREECOOL_VER	Summer freecooling	1: yes	0: no 1: yes		---	Digital	R/W	52



## MANUFACTURER displays

Display	Parameter	Description of the parameter	Value	Minimum	Maximum	Unit	Type	R/W	Addr.
<b>MANUFACTURER: UNIT CONFIGURATION (...continued)</b>									
CU14	HAB_FREEHEAT	Winter freeheating	0: no	0: no 1: yes			---	Digital	R/W 53
CU14	HAB_FREECOOL_INV	Winter freecooling	1: yes	0: no 1: yes			---	Digital	R/W 62
CU14	EQUIPO_100_AIRE_EXTERIOR	Enabling unit with 100% outdoor air operation	0: no	0: no 1: yes			---	Digital	
CU14a	TIPO_FREECOOLING	Winter/ summer freecooling control	0: Thermal	0: Thermal 1: Enthalpic 2: Thermoenthalpic			---	Integer	W 118
CU15a	SET_IMPULSION_CALOR_FC	Set discharge air temperature to close the outdoor air damper in HEATING mode (winter)	30,0	0,0	50,0	°C	Analog	R/W	85
CU15a	SET_TEMP_OFF_FC_CALOR	Set return air temperature to close the outdoor air damper in HEATING mode (winter)	15,0	0,0	50,0	°C	Analog	R/W	86
CU15a	BANDA_TEMP_OFF_FC_CALOR	Control band of temperature to close the outdoor air damper in HEATING mode (winter)	2,0	0,0	5,0	°C	Analog	R/W	87
CU15b	SET_IMPULSION_FRIO_FC	Set discharge air temperature to close the outdoor air damper in COOLING mode (summer)	20,0	0,0	50,0	°C	Analog	R/W	88
CU15b	SET_TEMP_OFF_FC_FRIO	Set return air temperature to close the outdoor air damper in COOLING mode (summer)	31,0	0,0	50,0	°C	Analog	R/W	89
CU15b	BANDA_TEMP_OFF_FC_FRIO	Control band of temperature to close the outdoor air damper in COOLING mode (summer)	2,0	0,0	5,0	°C	Analog	R/W	90
CU16	MAN_VIC_C1	4-way valve circuit 1	0: N.Open	0: N.Open 1: N.Closed			---	Digital	
CU16	MAN_VIC_C2	4-way valve circuit 2 (units 2 circuits) or circuit 3 (units 4 circuits)	0: N.Open	0: N.Open 1: N.Closed			---	Digital	
CU16	MAN_VIC_C1_2	4-way valve circuit 2 (units 4 circuits)	0: N.Open	0: N.Open 1: N.Closed			---	Digital	
CU16	MAN_VIC_C2_2	4-way valve circuit 4 (units 4 circuits)	0: N.Open	0: N.Open 1: N.Closed			---	Digital	
<b>MANUFACTURER: DEFROSTING CONFIGURATION</b>									
CD04	VAL_DES_MIN	Setpoint for start of defrosting by minimal pressure	-21°C (T) 2.5 bar (R410A) 1,0 bar (R407C)	-25	10	bar	Analog	R/W	104
CD04	TIME_MAX_DUR_DES_MIN	Outdoor fans connection during the defrosting procedure by minimal pressure	240	0	600	sec	Integer		
CD05	VAL_DES_DIF	Difference between the outdoor temperature and the evaporation temperature measured to start the defrosting procedure	16	5	20	°C	Analog	R/W	105
CD05	SET_TEMP_EXT_DES	Outdoor temperature setpoint to allow the defrosting by difference	10	0	50	°C	Analog	R/W	226
CD05	TIME_MAX_DUR_DES_DIF	Outdoor fans connection during the defrosting procedure by difference	120	0	600	sec	Integer		
CD06	TIME_DES_C1_2	Time between defrosting of different circuits by difference with outdoor temperature	90	0	999	sec	Integer		
CD06	TIME_ENTRE_DES_DIF	Minimum time between defrosting of the same circuit by difference with outdoor temperature	20	0	99	min	Integer		
CD07	VAL_ON_VEXT_DES_OBL	Pressure ON for outdoor fans	35.0 bar (R410A) 22.0 bar (R407C)	10	45	bar	Analog	R/W	95
CD07	VAL_OFF_VEXT_DES_OBL	Pressure OFF for outdoor fans	33.0 bar (R410A) 20.0 bar (R407C)	10	45	bar	Analog	R/W	96
CD07	SET_TEXT_VEXT_OFF_DES	Outdoor temperature setpoint below which there is not allowed to operate the outdoor fans	-6,0	-9,9	0	°C	Analog	R/W	111
CD08	HAB_ON_VEXT_INI_DES	Enabling outdoor fan operation at the beginning of the defrosting	1: yes	0: no 1: yes			---	Digital	R/W 200
CD08	TIME_ON_VEXT_INI_DES	Running time outdoor fan at the start of the defrosting	45	0	120	sec	Integer	R/W	185
CD09	VAL_INI_DES	Defrosting start setpoint	-5°C (T) 5.6 bar (R410A) 2,7 bar (R407C)	-10	10	bar	Analog	R/W	37
CD09	VAL_FIN_DES	Defrosting end setpoint	9°C (T) 33,0 bar (R410A) 21,0 bar (R407C)	0	50	bar	Analog	R/W	38
CD10	TIME_RET_INICIO_DES	Defrosting start delay	120	0	999	sec	Integer	R/W	34
CD10	TIME_MIN_DUR_DES	Minimum time of defrosting duration	1	0	999	min	Integer	R/W	64
CD10	TIME_MAX_DUR_DES	Maximum time of defrosting duration	10	0	999	min	Integer	R/W	35

## MANUFACTURER displays

Display	Parameter	Description of the parameter	Value	Minimum	Maximum	Unit	Type	R/W	Address
<b>MANUFACTURER: COMPRESSORS CONFIGURATION</b>									
CC01	TIME_MIN_OFF_COMP	Minimum compressor stop time	180	0	9999	sec	Integer	R/W	27
CC01	TIME_MIN_ON_COMP	Minimum compressor operating time	120	0	9999	sec	Integer	R/W	33
CC02	TIME_MIN_ON_ON_COMP	Time between start-ups of the same compressor	300	0	9999	sec	Integer	R/W	31
CC02	TIME_MIN_ON_ON_COMP_DIST	Time between start-ups of different compressors	60	0	9999	sec	Integer	R/W	32
CC03	TIME_RET_AL_BP	Low pressure alarm delay	15	0	9999	sec	Integer	R/W	19
CC03	HAB_ROT_COMP	Compressors rotation enabling	1: yes	0: no 1: yes		---	Digital	W	64
CC03	EQUALIZED_CIRC_POWER	Type of rotation of the compressors	1	0: grouped 1: equalized		---	Digital		
CC04	DESHAB_AL_BP_CALOR	Cancel LP pressostats in winter	0: no	0: no 1: yes		---	Digital	R/W	87
CC04	DESHAB_AL_BP_DES	Cancel LP pressostats in defrosting	0: no	0: no 1: yes		---	Digital	R/W	88
CC04a	HAB_OFF_COMP_DES	Compressors stop before defrosting	1: yes	0: no 1: yes		---	Digital	R/W	90
CC04a	TIME_OFF_COMP_DES	Compressor stop time before defrosting	45	0	9999	sec	Integer		
CC04b	TIME_CAMBIO_V4V	4-way valve: time before change and after compressor stop	30	0	9999	sec	Integer		
CC04c	HAB_OFF_COMP_CAMBIO_F_C	Compressors stop in change summer / winter	1: yes	0: no 1: yes		---	Digital	R/W	91
CC04c	TIME_OFF_COMP_AMBIO_F_C	Compressors stop time in change summer / winter	180	0	9999	sec	Integer		
CC05	TIPO_BLOQ_COMP_FRIO_FC	Disable compressors during summer freecooling	2	0: no 1: Δ amb. T - outd. T 2: outdoor set		---	Integer	R/W	72
CC05	SET_BLOQ_COMP_FRIO_FC	Block compressor setpoint in summer with free-cooling with low outdoor temperature	10,0	-99,9	99,9	°C	Analog	R/W	92
CC05	VAL_DIF_BLOQ_COMP_FRIO_FC	Differential between outdoor and return air temps. for blocking compressor in summer by free-cooling	14,0	-99,9	99,9	°C	Analog	R/W	93
CC05	SET_HUM_BLOQ_COMP_FRIO_FC	Block compressor setpoint in summer with free-cooling due to the high outdoor humidity	80,0	0,0	100,0	%HR	Analog	R/W	154
CC06	TIPO_BLOQ_COMP_CALOR	Disable compressors in winter according to outdoor T	0: no	0: no 1: yes		---	Digital	R/W	131
CC06	SET_BLOQ_COMP_CALOR	Block set in °C	-10,0	-99,9	99,9	°C	Analog	R/W	94
<b>MANUFACTURER: CONTROL CONFIGURATION</b>									
CR01	CONTROL_P_PI	Temperature control type	1: P+I	0: P 1: P+I		---	Digital	R/W	63
CR01	TIME_INTEGRACION	Integral time in PI control	120	0	999	sec	Integer	R/W	42
CR01a	CONTROL_P_PI_IMP	Temperature control type of discharge	1: P+I	0: P 1: P+I		---	Digital		
CR01a	TIME_INTEGRACION_IMP	Integral time in PI control for discharge	120	0	999	sec	Integer		
CR02	RES_VER	Optional electrical heaters in summer	1: yes	0: no 1: yes		---	Digital	R/W	92
CR02	VLV_VER	Optional hot water coil in summer	1: yes	0: no 1: yes		---	Digital	R/W	93
CR03	HAB_OFF_VINT_FRIO	Indoor fan stop at summer compressor stop	0: no	0: no 1: yes		---	Digital	R/W	94
CR03	HAB_OFF_VINT_CALOR	Indoor fan stop at winter compressor stop	0: no	0: no 1: yes		---	Digital	R/W	95
CR03	HAB_OFF_VINT_POR_CO2	Indoor fan stop when compressor stops if there is not demand for air exchange of CO2 sensor	0: no	0: no 1: yes		---	Digital	R/W	204
CR03a	TIME_VINT_ON_ANTIESTRATIF	Antistratification: start time	0	0	999	min	Integer	R/W	186
CR03a	TIME_VINT_OFF_ANTIESTRATIF	Antistratification: stop time	0	0	999	min	Integer	R/W	187
CR04	TIME_RET_OFF_VINT_FRIO	Summer internal fan stop delay	60	0	999	sec	Integer	R/W	23
CR04	TIME_RET_OFF_VINT_CALOR	Winter internal fan stop delay	60	0	999	sec	Integer	R/W	24
CR05	TIME_RET_ON_VINT_CALOR	Delay start-up indoor fan in heating mode	0	0	999	sec	Integer		
CR05	TIME_RET_ON_COMP_ON_VINT	Delay start-up of compressors on regard to the indoor fan	30	0	999	sec	Integer	R/W	25





## MANUFACTURER displays

Display	Parameter	Description of the parameter	Value	Minimum	Maximum	Unit	Type	R/W	Address
<b>MANUFACTURER: CONTROL CONFIGURATION (...continued)</b>									
CR05	TIME_RET_ON_COMP_ON_VEXT	Delay start-up of compressors on regard to the outdoor fan	10	10	120	sec	Integer		
CR05a	TIME_RET_ON_VINT	Indoor fan start delay with unit "ON"	30	0	999	s	Integer	RW	216
CR05a	TIME_RET_ON_VINT_CALOR	Indoor fan start delay with heating mode	0	0	999	s	Integer		
CR06	HAB_C_COND_VENT_EXT	Condensation control	1: yes	0: no 1: yes			---	Digital	R/W 171
CR06	TIME_VEXT_OFF_MAX_COND	Compressor ON delay: OFF	0	0	999	sec	Integer		
CR06	TIME_VEXT_ON_MAX_COND	Compressor ON delay: ON	120 sec 30 sec (electronic or damper)	0	999	sec	Integer		
CR06a	SET_C_COND_VEXT	Condensation control: setpoint (by default: axial fan) (see display)	27.0 bar (R410A) 17.0 bar (R407C)	0	60	bar	Analog	R/W	67
CR06a	BANDA_C_COND_VEXT	Condensation control: differential (by default: axial fan) (see display)	8.0 bar (R410A) 5.5 bar (R407C)	0	10	bar	Analog	R/W	69
CR06a	CONTROL_P_PI_C_COND_VEXT	Type of control: proportional or proportional + integral for outdoor unit condensation control	0: P	0: P 1: P+I			---	Digital	R/W 179
CR06a	TIME_INT_C_COND_VEXT	Integration time for P+I control for outdoor unit condensation control	120	0	999	sec	Integer	R/W	133
CR07	HAB_C_EVAP_VENT_EXT	Evaporation control	1: yes	0: no 1: yes			---	Digital	R/W 172
CR07	TIME_VEXT_ON_MAX_EVAP	Compressor ON start time	120 sec 30 sec (electronic or damper)	0	999	sec	Integer		
CR07a	SET_C_EVAP_VEXT	Evaporation control: setpoint (by default: axial fan) (see display)	10.0 bar (R410A) 5.7 bar (R407C)	0	60	bar	Analog	R/W	100
CR07a	BANDA_C_EVAP_VEXT	Evaporation control: differential (by default: axial fan) (see display)	2.0 bar (R410A) 1.1 bar (R407C)	0	10	bar	Analog	R/W	102
CR07a	CONTROL_P_PI_C_EVAP_VEXT	Type of control: proportional or proportional + integral for outdoor unit evaporation control	0: P	0: P 1: P+I			---	Digital	R/W 178
CR07a	TIME_INT_C_EVAP_VEXT	Integration time for P+I control for outdoor unit evaporation control	120	0	999	sec	Integer	R/W	132
CR07b	HAB_C_COND_VENT_INT	Indoor unit condensation control	1: yes	0: no 1: yes			---	Digital	
CR07b	TIME_VINT_ON_MAX_COND	Compressor ON delay: ON	120 s 30 s (electronic or damper)	0	999	s	Integer		
CR07c	SET_C_COND_VINT	Indoor unit condensation control: setpoint	R410A - 27.0 bar R407C - 17.0 bar	0	60	bar	Analog		
CR07c	BANDA_C_COND_VINT	Indoor unit condensation control: differential	R410A - 8.0 bar R407C - 5.5 bar	0	10	bar	Analog		
CR07c	CONTROL_P_PI_C_COND_VINT	Type of control: proportional or proportional + integral for indoor unit condensation control	0: P	0: P 1: P+I			---	Digital	
CR07c	TIME_INT_C_COND_VINT	Integration time for P+I control for indoor unit condensation control	120	0	999	s	Integer		
CR07d	HAB_C_EVAP_VENT_INT	Indoor unit evaporation control	1: yes	0: no 1: yes			---	Digital	
CR07d	TIME_VINT_ON_MAX_EVAP	Compressor ON start time	120 s 30 s (electronic or damper)	0	999	s	Integer		
CR07e	SET_C_EVAP_VINT	Indoor unit evaporation control: setpoint	R410A - 10.5 bar R407C - 5.7 bar	0	60	bar	Analog		
CR07e	BANDA_C_EVAP_VINT	Indoor unit evaporation control: differential	R410A - 1.5 bar R407C - 1.1 bar	0	10	bar	Analog		
CR07e	CONTROL_P_PI_C_EVAP_VINT	Type of control: proportional or proportional + integral for indoor unit evaporation control	0: P	0: P 1: P+I			---	Digital	
CR07e	TIME_INT_C_EVAP_VINT	Integration time for P+I control for indoor unit evaporation control	120	0	999	s	Integer		
CR08	TIME_OFF_VEXT_FRIO	Time for STOPPING outdoor fan in COOLING mode	60	0	999	sec	Integer		
CR08	TIME_OFF_VEXT_CALOR	Time for STOPPING outdoor fan in HEATING mode	60	0	999	sec	Integer		
CR09	NEW_PASS_COS	New MANUFACTURER password	*****	0	9999	---	Integer	R/W	30

## MANUFACTURER displays

Display	Parameter	Description of the parameter	Value	Minimum	Maximum	Unit	Type	R/W	Addr.
<b>MANUFACTURER: SAFETY CONFIGURATION</b>									
CS01	SET_AL_INCENDIO	Fire alarm setpoint (with probe of return)	60,0	40	80	°C	Analog	R/W	116
CS01	DIF_AL_INCENDIO	Fire alarm differential (with probe of return)	20,0	10	50	°C	Analog	R/W	117
CS01	COMP_OFF_ALL_INCENDIO	Damper status during the fire alarm	0: open	0: open 1: closed		---	Digital	R/W	170
CS01a	REG_ANTI_INCENDIO_FRA_ERP	Enabling ERP French fire safety	0: no	0: no 1: yes		---	Digital	R/W	234
CS01a	TIME_RET_OFF_VINT_REG_INC_ERP	Delay off of the supply fan with electric heating in case of the ERP French fire safety	120	0	999	s	Integer		
CS02	VAL_INI_AL_ANTIHIELO	Initial value of the anti-freeze alarm for water-air units	-2,0	VAL_INI_FORCE_AL_ANTIHIELO	50	°C	Analog	R/W	143
CS02	VAL_DIF_AL_ANTIHIELO	Differential value of the anti-freeze alarm for water-air units	8,0	0	50	°C	Analog	R/W	144
CS03	OFFSET_AL_IMPULSION_ALTA	Offset for activation of the high outlet temperature safety device in winter	10,0	0	20	°C	Analog	R/W	118
CS03	DIF_AL_IMPULSION_ALTA	Differential for deactivation of the high outlet temperature alarm	2,0	1	10	°C	Analog	R/W	119
CS04	SET_ALTA_TEMP_FRIO	Set high return temperature in summer	50,0	0	60	°C	Analog	R/W	41
CS04	SET_BAJA_TEMP_FRIO	Set low return temperature in summer	10,0	0	60	°C	Analog	R/W	42
CS05	SET_ALTA_TEMP_CALOR	Set high return temperature in winter	50,0	0	60	°C	Analog	R/W	43
CS05	SET_BAJA_TEMP_CALOR	Set low return temperature in winter	10,0	0	60	°C	Analog	R/W	44
CS06	TIME_RET_AL_TEMP	High/low return T alarm delay	30	0	999	min	Integer	R/W	18
CS07	TIME_AL_VIRT	pLAN and/or RH probe disconnection alarm delay	30	0	9999	sec	Integer	R	65
CS08	TIME_RET_AL_TERM_VENT_INT	Time delay for alarm for indoor fan thermal	0 sec 30 sec (air flow switch)	0	999	sec	Integer	R/W	26
CS08	TIME_RET_AL_CAUDAL	Time delay for the water flow alarm (water-air)	30	0	120	sec	Integer	R/W	183
CS08	HAB_AL_CAUDAL_FRIO_CALOR	flow switch only in HEATING mode (by default) or in HEATING & COOLING modes (water-air)	0: Heating	0: Heating 1: Cooling-heating		---	Digital		
CS08a	HAB_AVISO_ALTA_RPM_PLUG_FAN	Enabling of the warning of the high RPM plug-fan	1: yes	0: no 1: yes		---	Digital		
CS08a	TIME_RET_ALTA_RPM_PLUG_FAN	Time delay of the warning of the high RPM plug-fan	30	0	999	min	Integer		
CS08a	HAB_OFF_POR_AVISO_ALTA_RPM	Enabling of the unit stop by the warning of the high RPM plug-fan	0: Only indication	0: Only indication 1: unit off		---	Digital		
CS08b	HAB_OFF_POR_AL_FILTRO_SUCIO	Enabling of the unit stop by the clogged filter alarm	0: Only indication	0: Only indication 1: unit off		---	Digital		
CS09	GAS_LEAKAGE_ALARM_SETP_PPM	Alarm limit in ppm for gas leakage detector	200	0	32767	ppm	Integer		
CS09	GAS_LEAKAGE_AL_GAS_LEAKAGE_DELAY	Alarm gas leakage delay	1	0	59	min	Integer		
CS10	GAS_LEAKAGE_BUZZER_DELAY	Buzzer delay during gas leakage detection	5	0	59	min	Integer		
CS10	GAS_LEAKAGE_DEL_AL_OFFLINE	Alarm delay due to gas leakage detector disconnected	30	0	300	s	Integer		
CS11	SET_RES_CALEFACTORA_TUBERIA_BAC	Activation setpoint of electrical heating in hot water coil pipe	4,0	-10,0	10,0	°C	Analog		
CS11	SET_RES_CARTER_DOBLE_COMPRESOR	Activation setpoint of dual compressor crankcase and the first stage of electrical heating in electrical box	-8,0	-20,0	0,0	°C	Analog		
CS11	SET_RES_CALEFACTORA_COMPUERTA	Activation setpoint of electrical heating in outdoor dampers	-12,0	-20,0	0,0	°C	Analog		
CS11	SET_RES_CALEFACTORA_CUADRO_2	Activation setpoint of the second stage of electrical heating in electrical box	-16,0	-20,0	0,0	°C	Analog		
CS12	VAL_INI_AL_BP	Start value of low pressure alarm	2,0	0,0	9,9	Bar	Analog		
CS12	VAL_FIN_AL_BP	End value of low pressure alarm	4,0	0,0	9,9	Bar	Analog		
CS13	HAB_LIM_POT_COMP_TANDEM_POR_AP	Enabling power limitation in tandem compressor by high pressure	1: yes	0: no 1: yes		---	Digital	R/W	241
CS13	VAL_INI_AL_AP	Start value of high pressure alarm	41,5	0,0	45,0	Bar	Analog		
CS13	VAL_FIN_AL_AP	End value of high pressure alarm	36,5	0,0	45,0	Bar	Analog		



## MANUFACTURER displays

Display	Parameter	Description of the parameter	Value	Minimum	Maximum	Unit	Type	R/W	Address
<b>MANUFACTURER: ALARM</b>									
CA01	TIME_RS_SIR	Alarm management: audio alarm reset	2	0	9999	sec	Integer		
CA01	RL_AL	Alarm relay	0: normal	0: normal	1: buzzer	---	Digital		
CA01	SEL_ALARMA_POR_MASK	Relay activation with selected active alarm in display	1: yes	0: no # 1: yes		---	Digital	R/W	180
CA02	HAB_TER	For remote output, selection of thermal prot. alarm	1: yes	0: no # 1: yes		---	Digital		
CA02	HAB_HP	For remote output, selection of high pressure alarm	1: yes	0: no # 1: yes		---	Digital		
CA02	HAB_LP	For remote output, selection of low pressure alarm	1: yes	0: no # 1: yes		---	Digital		
CA02	HAB_DES	For remote output, selection of defrosting alarm	1: yes	0: no # 1: yes		---	Digital		
CA02	HAB_HT	For remote output, selection of high temperature alarm	1: yes	0: no # 1: yes		---	Digital		
CA02	HAB_LT	For remote output, selection of low temperature alarm	1: yes	0: no # 1: yes		---	Digital		
CA02	HAB_CON	For remote output, selection of counter alarm	1: yes	0: no # 1: yes		---	Digital		
CA02	HAB_SD	For remote output, selection of alarm by disconnected probes	1: yes	0: no # 1: yes		---	Digital		
CA03	HAB_HIE	For remote output, selection of antifrost alarm	1: yes	0: no # 1: yes		---	Digital		
CA03	HAB_INT	For remote output, selection of interlock alarm	1: yes	0: no # 1: yes		---	Digital		
CA03	HAB_FIL	For remote output, selection of compressor discharge alarm	1: yes	0: no # 1: yes		---	Digital		
CA03	HAB_EPR	For remote output, selection of fouled filter alarm	1: yes	0: no # 1: yes		---	Digital		
CA03	HAB_KLD	For remote output, selection of EPROM failure alarm	1: yes	0: no # 1: yes		---	Digital		
CA03	HAB_REL	For remote output, selection of clock alarm	1: yes	0: no # 1: yes		---	Digital		
CA03	HAB_SP	For remote output, selection of W/Sec setpoint alarm	1: yes	0: no # 1: yes		---	Digital		
CA04	HAB_BQ_AL_AP	Enable high pressure alarm blocking	1: yes	0: no # 1: yes		---	Digital		
CA04	NUM_VECES_BQ_AL_AP	Number of times to block the unit due to high pressure alarm	4	0	20	---	Integer		
CA04	TIME_BQ_AL_AP	Time in minutes to count the number of times an alarm occurs for blocking due to high pressure	30	0	1440	min	Integer		
CA05	HAB_BQ_AL_BP	Enable low pressure alarm blocking	1: yes	0: no # 1: yes		---	Digital		
CA05	NUM_VECES_BQ_AL_BP	Number of times to block the unit due to low pressure alarm	4	0	20	---	Integer		
CA05	TIME_BQ_AL_BP	Time in minutes to count the number of times an alarm occurs for blocking due to low pressure	30	0	1440	min	Integer		
CA06	HAB_BQ_AL_TERM	Enable alarm blocking of compressors and outdoor fans thermal	1: yes	0: no # 1: yes		---	Digital		
CA06	NUM_VECES_BQ_AL_TERM	Number of times to block the unit due to thermal alarm	4	0	20	---	Integer		
CA06	TIME_BQ_AL_TERM	Time in minutes to count the number of times an alarm occurs for blocking due to thermal	30	0	1440	min	Integer		
CA07	HAB_BQ_AL_TERM_RES	Enable electrical heaters thermal alarm blocking	1: sí	0: no # 1: sí		---	Digital		
CA07	NUM_VECES_BQ_AL_TERM_RES	Number of times to block the unit due to electrical heaters thermal alarm	4	0	20	---	Integer		
CA07	TIME_BQ_AL_TERM_RES	Time in minutes to count the number of times an alarm occurs for blocking due to electrical heating thermal	30	0	1440	min	Integer		
<b>MANUFACTURER: UNIT INITIALISATION</b>									
IU01	LANGUAGE	Selection of language	0: Spanish	0: Spanish	1: French 2: English 3: Italian 4: Turkish 5: German	---	Integer	R/W	63
IU02	logo_bool	Logo on the first display: CIAT or CARRIER	0: CIAT	0: CIAT	1: CARRIER	---	Digital		
IU03	Msk_Default_Init	Manual activation by loading the default values	0: no	0: no # 1: yes		---	Integer		
IU04	VIRT_VAL_ENSAYO	Manual activation by loading the default test values	0: no	0: no # 1: yes		---	Digital		
IU04	VIRT_VAL_NORMAL	Manual activation by loading the normal values	0: no	0: no # 1: yes		---	Digital		
IU05	RESET_EVENTS	Reset the alarms log	0: no	0: no # 1: yes		---	Digital		
IU06	NEW_PASS_UT	New USER password	*****	0	9999	---	Integer	R/W	28
IU06	NEW_PASS_ASS	New MAINTENANCE password	*****	0	9999	---	Integer	R/W	29
IU06	NEW_PASS_COS	New MANUFACTURER password	*****	0	9999	---	Integer	R/W	30

## MANUFACTURER displays

Display	Parameter	Description of the parameter	Value	Minimum	Maximum	Unit	Type	R/W	Addr.
<b>MAINTENANCE: INPUTS / OUTPUTS</b>									
A0	SEL_FRIO_CALOR	Selection of winter/summer mode	2: auto	0: by keyboard 1: by digital input (remote) 2: auto 3: only ventilation		---	Integer	R/W	59
A0	MODO_FRIO_CALOR_AUTO	Mode of winter/summer selection in automatic	1: by outd. T	0: by indoor T 1: by outdoor T		---	Digital	R/W	232
A0	CALOR_FRIO_PANEL	Winter / summer by keyboard	1: summer	0: winter 1: summer		---	Digital	R/W	66
A0	SET_TEMP_EXT_CAMBIO_FRIO	Outdoor temperature setpoint for change to COOLING mode.	22,0	-99,9	99,9	°C	Analog	R/W	223
A0	SET_TEMP_EXT_CAMBIO_CALOR	Outdoor temperature setpoint for change to HEATING mode.	20,0	-99,9	99,9	°C	Analog	R/W	224
A0	PGD1_bloqueado_SEL_FRIO_CALOR	Enabling of the blocking of summer / winter selection in the PGD1	0: no	0: no # 1: yes		---	Digital	R/W	240
A00	Control_mode_SET1	Type of flow control with supply plug-fan	1: closed loop sensor ctr	1: closed loop sensor ctr 2: open loop pwm ctr		---	Integer	R/W	
A00	SET_CAUDAL_VINT_VENTILACION	Setpoint of flow in VENTILATION mode with supply plug-fan	1200	CAUDAL_VINT_NOMINAL_MIN	CAUDAL_VINT_NOMINAL_MIN	x10 m3/h	Integer	R/W	197
A00	SET_CAUDAL_VINT_FRIO	Setpoint of flow in COOLING mode with supply plug-fan	1200	CAUDAL_VINT_NOMINAL_MIN	CAUDAL_VINT_NOMINAL_MIN	x10 m3/h	Integer	R/W	200
A00	SET_CAUDAL_VINT_CALOR	Setpoint of flow in HEATING mode with supply plug-fan	1200	CAUDAL_VINT_NOMINAL_MIN	CAUDAL_VINT_NOMINAL_MIN	x10 m3/h	Integer	R/W	201
A00	Speed_Input_perc_VENTILACION	Percentage of speed modulation in VENTILATION mode with supply plug-fan	50	0	100	%	Integer	R/W	
A00	Speed_Input_perc_FRIO	Percentage of speed modulation in COOLING mode with supply plug-fan	50	0	100	%	Integer	R/W	
A00	Speed_Input_perc_CALOR	Percentage of speed modulation in HEATING mode with supply plug-fan	50	0	100	%	Integer	R/W	
A00a	SET_CAUDAL_VINT	Setpoint of flow selected with supply plug-fan (it can be the COOLING, HEATING or VENTILATION setpoint)	1200	0	9999	x10 m3/h	Integer	R	
A00a	Speed_Input_perc	% of speed modulation selected with supply plug-fan (it can be COOLING, HEATING or VENTILATION setpoint)	50	0	100	%	Integer	R	
A00a	CAUDAL_VINT_MEDIDO_AJUSTE	Current flow with supply plug-fan		0	9999	x10 m3/h	Integer	R	198
A00a	CurrModLev_msk_Fan1	Current % of speed modulation with supply plug-fan		0	9999	%	Integer	R	206
A00a	actual_speed_msk_Fan1	Current speed with supply plug-fan	0	0	9999	rpm	Integer	R	199
A00f	Maximal_Speed_Fan1	Maximum speed allowed with supply plug-fan	0	0	9999	rpm	Integer		
A00f	Ramp_up_TIME_Fan1	Ramp-up time with supply plug-fan	5	0	625	sec	Integer		
A00f	Ramp_dwn_TIME_Fan1	Ramp down time with supply plug-fan	5	0	625	sec	Integer		
A00e	VALUE_AI_sensor_pda_Fan1	Voltage minimum value of the air pressure differential sensor to signal its alarm.	0.1	0.0	10.0	V	Integer		
A00e	TIME_RET_AI_sensor_pda_Fan1	Delay time to start the fan for alarm signaling of the air pressure differential sensor	30	10	120	s	Integer		
A00g	AIN2_Min_Value_Ebm_Fan1	Minimum limit of the air pressure differential sensor with supply plug-fan	0	0	5000	Pa	Integer		
A00g	AIN2_Max_Value_Ebm_Fan1	Maximum limit of the air pressure differential sensor with supply plug-fan	1000	0	5000	Pa	Integer		
A00h	Output_function_caracteristic_F1	Setting the analog output of master indoor plug-fan	1: speed	0: PWM; 1: speed		---	Integer		
A00h	Output_caracteristic_X1_Fan1	X1 value of the analog output of master indoor plug-fan	3	0	100	%	Integer		
A00h	Output_caracteristic_Y1_Fan1	Y1 value of the analog output of master indoor plug-fan	0,0	0,0	10,0	V	Analog		
A00h	Output_caracteristic_X2_Fan1	X2 value of the analog output of master indoor plug-fan	100	0	100	%	Integer		
A00h	Output_caracteristic_Y2_Fan1	Y2 value of the analog output of master indoor plug-fan	9,5	0,0	10,0	V	Analog		
A20	MOD_MB_VFD_CIAT_1_Type_Require_IO	Control type of frequency inverter of indoor motor	1: closed loop sensor ctr	1: closed loop sensor ctr 2: panel control 3: open loop pwm ctr		---	Integer		
A20	Pda_VENT_INT_min	Point differential pressure minimum of indoor fan	125	0	9999	Pa	Integer	R/W	155
A20	Rpm_VENT_INT_min	Point rpm minimum of indoor fan	592	0	9999	rpm	Integer	R/W	156
A20	Pda_VENT_INT_max	Point differential pressure maximum of indoor fan	600	0	9999	Pa	Integer	R/W	157
A20	Rpm_VENT_INT_max	Point rpm maximum of indoor fan	962	0	9999	rpm	Integer	R/W	158
A20	Speed_Input_perc_VENTILACION_Fan1	Percentage of speed modulation in VENTILATION mode with indoor fan	50	0	100	%	Integer	R/W	159
A20	Speed_Input_perc_FRIO_Fan1	Percentage of speed modulation in COOLING mode with indoor fan	50	0	100	%	Integer	R/W	160



## MANUFACTURER displays

Display	Parameter	Description of the parameter	Value	Minimum	Maximum	Unit	Type	R/W	Addr.
<b>MAINTENANCE: INPUTS / OUTPUTS (...continued)</b>									
A20	Speed_Input_perc_CALOR_Fan1	Percentage of speed modulation in HEATING mode with indoor fan	50	0	100	%	Integer	R/W	161
A20a	Speed_Input_perc_Fan1	Percentage of speed modulation with indoor fan	50	0	100	%	Integer		
A20a	Speed_Hz_VFD_INT	Frequency read on the indoor motor	---	0	99.9	Hz	Analog	R	162
A20a	Analog_IN1_Ebm_Fan1	Pressure differential read on the indoor fan	---	0	32767	Pa	Integer	R	163
A20a	Speed_rpm_VFD_INT	Speed read on the indoor motor	---	0	9999	rpm	Integer	R	164
A20a	Rpm_VENT_INT_calculado	Speed calculated on the indoor fan	---	0	32767	rpm	Integer	R	165
A20f	MOD_MB_VFD_CIAT_1.Min_Setting_A1	Minimum value of the analog input A1 of indoor motor VFD	0	0	1000.0	%	Analog	R	166
A20f	MOD_MB_VFD_CIAT_1.Max_Setting_A1	Maximum value of the analog input A1 of indoor motor VFD	1000.0	0	1000.0	%	Analog	R	167
A20f	MOD_MB_VFD_CIAT_1.Min_Frequency	Minimum frequency value of indoor motor VFD	25.0	0	320.0	Hz	Analog	R	168
A20f	MOD_MB_VFD_CIAT_1.Max_Frequency	Maximum frequency value of indoor motor VFD	50.0	0	320.0	Hz	Analog	R	169
A20f	MOD_MB_VFD_CIAT_1.Acceler_Time	Ramp-up time with frequency inverter of indoor motor	5	0	3000	s	Analog		
A20f	MOD_MB_VFD_CIAT_1.Deceler_Time	Ramp down time with frequency inverter of indoor motor	5	0	3000	s	Analog		
A20e	VALUE_AI_sensor_pda_Fan1	Voltage minimum value of the air pressure differential sensor to signal its alarm.	0.1	0.0	10.0	V	Integer		
A20e	TIME_RET_AI_sensor_pda_Fan1	Delay time to start the fan for alarm signaling of the air pressure differential sensor	30	10	120	s	Integer		
A20g	AIN2_Min_Value_Ebm_Fan1	Minimum limit of the air pressure differential sensor with indoor fan	0	0	5000	Pa	Integer		
A20g	AIN2_Max_Value_Ebm_Fan1	Maximum limit of the air pressure differential sensor with indoor fan	1000	0	5000	Pa	Integer		
A001	Control_mode_SET1_Fan2	Type of flow control with return plug-fan	1:constant flow control	1: constant flow control 2: PWM control		---	Integer		
A001	SET_CAUDAL_VRET_VENTILACION	Setpoint of flow in VENTILATION mode with return plug-fan	1200	CAUDAL_VRET_NOMINAL_MIN	CAUDAL_VRET_NOMINAL_MIN	x10 m3/h	Integer	R/W	203
A001	SET_CAUDAL_VRET_FRIO	Setpoint of flow in COOLING mode with return plug-fan	1200	CAUDAL_VRET_NOMINAL_MIN	CAUDAL_VRET_NOMINAL_MIN	x10 m3/h	Integer	R/W	206
A001	SET_CAUDAL_VRET_CALOR	Setpoint of flow in HEATING mode with return plug-fan	1200	CAUDAL_VRET_NOMINAL_MIN	CAUDAL_VRET_NOMINAL_MIN	x10 m3/h	Integer	R/W	207
A001	Speed_Input_perc_VENTILACION_Fan2	Percentage of speed modulation in VENTILATION mode with return plug-fan	50	0	100	%	Integer		
A001	Speed_Input_perc_FRIO_Fan2	Percentage of speed modulation in COOLING mode with return plug-fan	50	0	100	%	Integer		
A001	Speed_Input_perc_CALOR_Fan2	Percentage of speed modulation in HEATING mode with return plug-fan	50	0	100	%	Integer		
A001a	SET_CAUDAL_VRET	Setpoint of flow selected with return plug-fan (it can be the COOLING, HEATING or VENTILATION setpoint)	1200	0	9999	x10 m3/h	Integer		
A001a	Speed_Input_perc_Fan2	Percentage of speed modulation selected with return plug-fan (it can be the COOLING, HEATING or VENTILATION setpoint)	50	0	100	%	Integer		
A001a	CAUDAL_VRET_MEDIDO_AJUSTE	Current flow with return plug-fan		0	9999	x10 m3/h	Integer		204
A001a	CurrModLev_msk_Fan2	Current percentage of speed modulation with return plug-fan		0	9999	%	Integer		
A001a	actual_speed_msk_Fan2	Current speed with return plug-fan	0	0	9999	rpm	Integer	R	205
A001f	Maximal_Speed_Fan2	Maximum speed allowed with return plug-fan	0	0	9999	rpm	Integer		
A001f	Ramp_up_TIME_Fan2	Ramp-up time with return plug-fan	5	0	625	s	Integer		
A001f	Ramp_dwn_TIME_Fan2	Ramp down time with return plug-fan	5	0	625	s	Integer		
A001e	VALUE_AI_sensor_pda_Fan2	Voltage minimum value of the air pressure differential sensor to signal its alarm.	0.1	0.0	10.0	V	Integer		
A001e	TIME_RET_AI_sensor_pda_Fan2	Delay time to start the fan for alarm signaling of the air pressure differential sensor	30	10	120	s	Integer		
A001g	AIN2_Min_Value_Ebm_Fan2	Minimum limit of the air pressure differential sensor with return plug-fan	0	0	5000	Pa	Integer		
A001g	AIN2_Max_Value_Ebm_Fan2	Maximum limit of the air pressure differential sensor with return plug-fan	1000	0	5000	Pa	Integer		
A001h	Output_function_characteristic_F2	Setting the analog output of master return plug-fan	1: speed	0: PWM; 1: speed		---	Integer		
A001h	Output_characteristic_X1_Fan2	X1 value of the analog output of master return plug-fan	3	0	100	%	Integer		
A001h	Output_characteristic_Y1_Fan2	Y1 value of the analog output of master return plug-fan	0,0	0,0	10,0	V	Analog		

## MANUFACTURER displays

Display	Parameter	Description of the parameter	Value	Min.	Max.	Unit	Type	R/W	Addr.
<b>MAINTENANCE: INPUTS / OUTPUTS (...continued)</b>									
A001h	Output_caracteristic_X2_Fan2	X2 value of the analog output of master return plug-fan	100	0	100	%	Integer		
A001h	Output_caracteristic_Y2_Fan2	Y2 value of the analog output of master return plug-fan	9,5	0,0	10,0	V	Analog		
A201	MOD_MB_VFD_CIAT_2.Type_Require_IO	Control type of frequency inverter of return motor	1: closed loop ctr				---	Integer	
A201	Pda_VENT_RET_min	Point differential pressure minimum of return fan	125	0	9999	Pa	Integer	R/W	170
A201	Rpm_VENT_RET_min	Point of minimum rpm of return fan	592	0	9999	rpm	Integer	R/W	171
A201	Pda_VENT_RET_max	Point differential pressure maximum of return fan	600	0	9999	Pa	Integer	R/W	172
A201	Rpm_VENT_RET_max	Point of maximum rpm of return fan	962	0	9999	rpm	Integer	R/W	173
A201	Speed_Input_perc_VENTILACION_Fan2	% of speed modulation in VENTILATION mode with return fan	50	0	100	%	Integer	R/W	174
A201	Speed_Input_perc_FRIO_Fan2	% of speed modulation in COOLING mode with return fan	50	0	100	%	Integer	R/W	175
A201	Speed_Input_perc_CALOR_Fan2	% of speed modulation in HEATING mode with return fan	50	0	100	%	Integer	R/W	176
A201a	Speed_Input_perc_Fan2	Percentage of speed modulation with return fan	50	0	100	%	Integer		
A201a	Speed_Hz_VFD_RET	Frequency read on the return motor	---	0	99.9	Hz	Analog	R	177
A201a	Analog_IN1_Ebm_Fan2	Pressure differential read on the return fan	---	0	32767	Pa	Integer	R	178
A201a	Speed_rpm_VFD_RET	Speed read on the return motor	---	0	9999	rpm	Integer	R	179
A201a	Rpm_VENT_RET_calculado	Speed calculated on the return fan	---	0	32767	rpm	Integer	R	180
A201f	MOD_MB_VFD_CIAT_2.Min_Setting_A1	Minimum value of the analog input A1 of return motor VFD	0	0	1000.0	%	Analog	R	181
A201f	MOD_MB_VFD_CIAT_2.Max_Setting_A1	Maximum value of the analog input A1 of return motor VFD	1000.0	0	1000.0	%	Analog	R	182
A201f	MOD_MB_VFD_CIAT_2.Min_Frequency	Minimum frequency value of return motor VFD	25.0	0	320.0	Hz	Analog	R	183
A201f	MOD_MB_VFD_CIAT_2.Max_Frequency	Maximum frequency value of return motor VFD	50.0	0	320.0	Hz	Analog	R	184
A201f	MOD_MB_VFD_CIAT_2.Acceler_Time	Ramp-up time with frequency inverter of return motor	5	0	3000	s	Analog		
A201f	MOD_MB_VFD_CIAT_2.Deceler_Time	Ramp down time with frequency inverter of return motor	5	0	3000	s	Analog		
A201e	VALUE_AI_sensor_pda_Fan2	Voltage minimum value of the air pressure differential sensor to signal its alarm	0.1	0.0	10.0	V	Integer		
A201e	TIME_RET_AI_sensor_pda_Fan2	Delay time to start the fan for alarm signaling of the air pressure differential sensor	30	10	120	s	Integer		
A201g	AIN2_Min_Value_Ebm_Fan2	Minimum limit of the air pressure diff. sensor with return fan	0	0	5000	Pa	Integer		
A201g	AIN2_Max_Value_Ebm_Fan2	Maximum limit of the air pressure diff. sensor with return fan	1000	0	5000	Pa	Integer		
A002b	HAB_RED_CAUDAL_CONDUCTO_TEXTIL	Enable flow reduction to fan start with fabric duct	1: yes	0: no 1: yes			---	Digital	
A002b	PORC_CAUDAL_CONDUCTO_TEXTIL	Percentage of flow to fan start with fabric duct	35.0	20.0	75.0	%	Analog		
A002b	TIME_RED_CAUDAL_CONDUCTO_TEXTIL	Reduced flow timing to fan start with fabric duct	20	0	999	s	Integer		
A002	CAUDAL_IMPULSION_MSK	Supply flow (measured value or value set by parameter)	0	0	9999	x10 m3/h	Integer		
A002	CAUDAL_RETORNO_MSK	Return flow (measured value or value set by parameter)	0	0	9999	x10 m3/h	Integer		
A002	Sobrepresion	Calculation of the OVERPRESSURE	0	0	99,9	%	Analog	R	151
A002	Cte_Ajuste_Sobrepresion	Constant of adjustment of the calculation of the overpressure	1	0	10	%	Analog	R/W	152
A002	AOUT_COMPUERTA	Output outdoor air damper	0	0	999,9	%	Analog	R	10
A002	AOUT_COMPUERTA_EXTRACCION	Output extraction air damper	0	0	999,9	%	Analog	R	153
A002a	CAUDAL_IMPULSION_MSK	Supply flow (measured value or value set by parameter)	0	0	9999	x10 m3/h	Integer		
A002a	CAUDAL_RETORNO_MSK	Return flow (measured value or value set by parameter)	0	0	9999	x10 m3/h	Integer		
A002a	RENOVACION_CAL	% air refreshing with mixing probe	0	0	0	%	Integer	R	124
A002a	CAUDAL_RENOVACION_MSK	Refreshing flow	0	0	9999	x10 m3/h	Integer		
A002a	CAUDAL_EXTRACCION_MSK	Extraction flow	0	0	9999	x10 m3/h	Integer		
A002d	TIPO_SONDA_HUM_INT	Internal relative humidity probe	0: no (enabling with enth. FC)	0: no 1: actual 2: virtual 3: pLAN 4: RS485			---	Integer	R/W 56



## MANUFACTURER displays

Display	Parameter	Description of the parameter	Value	Minimum	Maximum	Unit	Type	R/W	Addr.
<b>MAINTENANCE: INPUTS / OUTPUTS (...continued)</b>									
A002d	TIPO_SONDA_HUM_EXT	Outdoor humidity probe	0: no (enabling with enth. FC)	0: no 1: actual 2: pLAN		---	Integer	R/W	55
A002e	TIPO_FREECOOLING	Winter/ summer freecooling control	0: Thermal	0: Thermal 1: Enthalpic 2: Thermoenthalpic		---	Integer	R/W	118
A002f	HAB_SONDA_AMB	Enable Ambient probe	1: yes	0: no / 1: yes		---	Digital	R/W	167
A002f	CONTROL_SONDA_AMB	Ambient temperature control	0: ambient T	0: return T 1: ambient T		---	Digital	R/W	189
A002f	TIPO_SONDA_AMB	Type of ambient probe	4: 1 probe NTC	1: 1 probe RS485 2: 2 probes RS485 3: shared in pLAN 4: 1 probe NTC 5: 3 probes RS485 6: 4 probes RS485 7: probe 4-20 mA		---	Integer	R/W	46
A002f	SEL_TEMP_2_SOND_AMB_FRIO	Selection of temperature value with ambient probes in COOLING mode	0: average	0: average 1: minimum 2: maximum		---	Analog	R/W	199
A002f	SEL_TEMP_2_SOND_AMB_CALOR	Selection of temperature value with ambient probes in HEATING mode	0: average	0: average 1: minimum 2: maximum		---	Analog	R/W	200
A04	TAR_TEMP_RET	Return air temperature set	0,0	-9,9	9,9	°C	Analog	R/W	45
A04	TAR_TEMP_EXT	Outdoor air temperature set	0,0	-9,9	9,9	°C	Analog	R/W	46
A04a	TAR_TEMP_AMB	Ambient air temperature set	0,0	-9,9	9,9	°C	Analog	R/W	108
A04a	TAR_TEMP_TCO	Air temperature set of TCO thermostat	0,0	-9,9	9,9	°C	Analog		
A05	TAR_TEMP_IMP	Discharge air temperature set	0,0	-9,9	9,9	°C	Analog	R/W	47
A05	TAR_TEMP_MEZCLA	Mixing air temperature set	0,0	-9,9	9,9	°C	Analog	R/W	50
A05a	TAR_CO2	Air quality probe set	0,0	-999	999	°C	Integer	R/W	215
A05b	TAR_TEMP_ENTRADA_BAC	Adjust of water inlet temperature of the hot water coil	0,0	-9,9	9,9	°C	Analog		
A05b	TAR_TEMP_SALIDA_BAC	Adjust of water outlet temperature of the hot water coil	0,0	-9,9	9,9	°C	Analog		
A05c	TAR_TEMP_EXTRACCION_RUEDA	Calibration of the sensor of extraction air temperature on the wheel	0,0	-9,9	9,9	°C	Analog	R/W	248
A05c	TAR_TEMP_RECUPERACION_RUEDA	Calibration of the sensor of recovery air temperature on the wheel	0,0	-9,9	9,9	°C	Analog	R/W	250
A06	TAR_T_P_BEXT_C1	Adjust outdoor unit sensor circuit 1	0,0	-9,9	9,9	bar	Analog	R/W	48
A06	TAR_T_P_BEXT_C1_2	Adjust outdoor unit sensor circuit 2 (units 4 circuits)	0,0	-9,9	9,9	bar	Analog	R/W	109
A06a	TAR_T_P_BEXT_C2	Adjust outdoor unit sensor circuit 2 (units 2 circuits) or circuits 3 (units 4 circuits)	0,0	-9,9	9,9	bar	Analog	R/W	49
A06a	TAR_T_P_BEXT_C2_2	Adjust outdoor unit sensor circuit 4 (units 4 circuits)	0,0	-9,9	9,9	bar	Analog	R/W	110
A06b	TAR_T_P_BINT_C1	Adjust indoor unit sensor circuit 1	0,0	-9,9	9,9	bar	Analog	R/W	212
A06b	TAR_T_P_BINT_C1_2	Adjust indoor unit sensor circuit 2 (units 4 circuits)	0,0	-9,9	9,9	bar	Analog	R/W	213
A06c	TAR_T_P_BINT_C2	Adjust indoor unit sensor circuit 2 (units 2 circuits) or circuits 3 (units 4 circuits)	0,0	-9,9	9,9	bar	Analog	R/W	214
A06c	TAR_T_P_BINT_C2_2	Adjust indoor unit sensor circuit 4 (units 4 circuits)	0,0	-9,9	9,9	bar	Analog	R/W	215
A06d	MOD_MB_SERIAL_PROBE_C1AT2_1. Offset_Temp	Adjust ambiente air temperature with serial probe No.1	0,0	Min_Diff_Temp_AAA	Max_Diff_Temp_AAA	°C	Analog		
A06d	MOD_MB_SERIAL_PROBE_C1AT2_1. Offset_Humi	Adjust ambiente air humidity with serial probe No.1	0,0	-10	10	%rH	Analog		
A06e	MOD_MB_SERIAL_PROBE_C2AT2_2. Offset_Temp	Adjust ambiente air temperature with serial probe No.2	0,0	Min_Diff_Temp_AAA	Max_Diff_Temp_AAA	°C	Analog		
A06e	MOD_MB_SERIAL_PROBE_C2AT2_2. Offset_Humi	Adjust ambiente air humidity with serial probe No.2	0,0	-10	10	%rH	Analog		
A07	TAR_HUM_AMB	Return air humidity set	0,0	-9,9	9,9	%rH	Analog	R/W	54
A07	TAR_HUM_EXT	Outdoor air humidity set	0,0	-9,9	9,9	%rH	Analog	R/W	55
A07a	SONDA_HUM_4_20	Type of humidity probe	1: 4-20 mA	0: 0-1V / 1: 4-20 mA		---	Digital	R/W	96
A07a	SONDA_CO2_4_20	Type of air quality probe	1: 4-20 mA	0: 0-1V / 1: 4-20 mA		---	Digital		
A07b	IS_SONDA_IMP	Lower threshold of discharge probe scale	0,0	-99,9	99,9	°C	Analog		
A07b	FS_SONDA_IMP	Upper threshold of discharge probe scale	50,0	-99,9	99,9	°C	Analog		
A07c	IS_CO2	Lower threshold of air quality probe	0	-32767	32767	ppm	Integer		

## MANUFACTURER displays

Display	Parameter	Description of the parameter	Value	Min.	Max.	Unit	Type	R/W	Addr.
<b>MAINTENANCE: INPUTS / OUTPUTS (...continued)</b>									
A07c	FS_CO2	Upper threshold of air quality probe	2000	-32767	32767	ppm	Integer		
A07d	LIM_MAX_HUM	Maximum limit of the humidity probe	90	0	100	%rH	Analog	R/W	71
A07d	LIM_MIN_HUM	Minimum limit of the humidity probe	10	0	100	%rH	Analog	R/W	72
A07d	LIM_MAX_HUM_ALARMA	Maximum limit indicated by the humidity probe alarm	100	0	110	%rH	Analog	R/W	147
A07d	LIM_MIN_HUM_ALARMA	Minimum limit indicated by the humidity probe alarm	0	0	110	%rH	Analog	R/W	146
A07e	IS_PRESION	Lower threshold of pressure probe	0	-2	50	bar	Analog	R/W	97
A07e	FS_PRESION	Upper threshold of pressure probe	45	0	50	bar	Analog	R/W	98
A07f	TIPO_REFRIGERANTE	Type of refrigerant	4:R410A			0: R22 1: R134A 2: R404A 3: R407C 4: R410A	---	Integer	
A07h	HAB_FILTRO1	Enabling of probe software filter	0: no	0: no	# 1: yes	---	Digital	R/W	98
A07h	TIME_FILTRO1	Filter time	30	0	99	sec	Integer		
A07h	GRADI_FILTRO1	Filter differential	10,0	0	99,9	°C	Analog		
A07i	HAB_FILTRO_CAL_IMP	Enabling of filter	1: yes	0: no	# 1: yes	---	Digital	R/W	168
A07i	TIME_FILTRO_CAL_IMP	Filter time	60	0	99	sec	Integer		
A07i	GRADI_FILTRO_CAL_IMP	Filter differential	1,0	0	99,9	°C	Analog		
A11	SET_RENOVACION_CAL	% Outdoor air for refreshing	displayed	0	0	%	Integer	R	126
A11	RENOVACION_CAL	% air refreshing with mixing probe	displayed	0	0	%	Integer	R	124
A11	CAL_APER_RENOV_2	% real opening of outdoor damper	displayed	0	0	%	Integer	R	125
A11	TIME_CAL	Calculation time	60	0	99	sec	Integer	R/W	194
A11	V_CAL	Calculation constant	3	0	99	%	Integer	R/W	195
A11	DIF_TEMP_RENOVACION_CAL	Difference between mixing and return T, and between mixing temperature and exterior for refreshing calculation	3,0	0	9,9	°C	Analog	R/W	145
A12	NEW_PASS_ASS	New MAINTENANCE password	*****	0	9999	---	Integer	R/W	29
<b>MAINTENANCE: COUNTERS</b>									
A01	SET_HOR_ON_EQUIPO	Unit time set for alarm	20000	0	32000	h	Integer	R/W	37
A01	RESET_ON_HORAS_MAQUINA	Reset the counter for number of hours of unit operation	0: no	0: no	# 1: yes	---	Digital	R/W	107
A01b	RESET_TIME_COMPRESOR	Reset the timings of compressors for maintenance	0: no	0: no	# 1: yes	---	Digital	R/W	182
A01c	RESET_BLOQUEO_COMP_TENSION	Reset of compressor lock by heating of the crankcase heater	0: no	0: no	# 1: yes	---	Digital		
A01d	DISABLE_COMP1	Disable compressor No.1 of circuit 1	0: no	0: no	# 1: yes	---	Digital		
A01d	DISABLE_COMP1_2	Disable compressor No.2 of circuit 1	0: no	0: no	# 1: yes	---	Digital		
A01d	DISABLE_COMP2	Disable compressor No.1 of circuit 2	0: no	0: no	# 1: yes	---	Digital		
A01d	DISABLE_COMP2_2	Disable compressor No.2 of circuit 2	0: no	0: no	# 1: yes	---	Digital		
A02	SET_HOR_COMP1	Compressor 1 / circuit 1 time set for alarm	10000	0	32000	h	Integer	R/W	38
A02	RESET_ON_HORAS_COMP1	Reset counter for No. of hours of compressor 1 / circuit 1	0: no	0: no	# 1: yes	---	Digital	R/W	105
A02a	SET_HOR_COMP1_2	Compressor 2 / circuit 1 time set for alarm	10000	0	32000	h	Integer	R/W	67
A02a	RESET_ON_HORAS_COMP1_2	Reset counter for No. of hours of compressor 2 / circuit 1	0: no	0: no	# 1: yes	---	Digital	R/W	124
A03	SET_HOR_COMP2	Compressor 1 / circuit 2 time set for alarm	10000	0	32000	h	Integer	R/W	39
A03	RESET_ON_HORAS_COMP2	Reset counter for No. of hours of compressor 1 / circuit 2	0: no	0: no	# 1: yes	---	Digital	R/W	106
A03a	SET_HOR_COMP2_2	Compressor 2 / circuit 2 time set for alarm	10000	0	32000	h	Integer	R/W	70
A03a	RESET_ON_HORAS_COMP2_2	Reset counter for No. of hours of compressor 2 / circuit 2	0: no	0: no	# 1: yes	---	Digital	R/W	125
A03b	SET_HOR_CR	Recovery compressor time set for alarm	10000	0	32000	h	Integer	R/W	13
A03b	RESET_ON_HORAS_CR	Reset counter for No. of hours of rec. compressor operation	0: no	0: no	# 1: yes	---	Digital	R/W	133
A12i	GAS_LEAKAGE RESET_HOURS_COUNTER	Reset sensor timer of gas leakage detector	0: no	0: no	# 1: yes	---	Digital		
A13	RESET_ON_CONT	Reset the counter of starts of motors and heaters	0: no	0: no	# 1: yes	---	Digital		
A13	RESET_DES_CONT	Reset the counter of defrosting operations	0: no	0: no	# 1: yes	---	Digital		
A13	RESET_ON_CONT_AL	Reset the counter of alarms	0: no	0: no	# 1: yes	---	Digital		



## 28. TECHNICAL AND ELECTRICAL CHARACTERISTICS

<b>microPC board</b>	
<b>ELECTRICAL FEATURES</b>	
Power supply (controller with terminal connected)	230 Vac +10/-15% (by default) 24 Vac +10/-15% 50/60 Hz and 28 to 36 Vdc +10/-20% (optional)
Maximum current with the connected terminal	25 VA (Vac)
Terminal strip	with removable male/female connectors (250 Vac max.) connectors set with screws
Isolation between the power supply line and the control	double
Data memory	13 kB at 8 bits (max. limit: 400,000 writes per memory location)
Working cycle with applications of average complexity	0.2 s
<b>Analogue inputs</b>	
Analogue conversion	A/D converter to 10-bit integrated in CPU
Maximum number	7 in SMALL boards and 12 in MEDIUM boards
Input type: B1, B2, B3, B4, B8 and B9	low temperature NTC: 10kΩ ± 0.1% to 25°C; -50/90°C high temperature NTC: 50kΩ to 25°C; 0/150°C input: 0/1 Vdc
Input type: B5 and B10	low temperature NTC: 10kΩ to 25°C; -50/90°C high temperature NTC: 50kΩ to 25°C; 0/150°C input: 0/1 Vdc and 4/20 mA
Input type: B6, B7, B11 and B12	low temperature NTC: 10kΩ to 25°C; -50/90°C high temperature NTC: 50kΩ to 25°C; 0/150°C input: 0/1 Vdc radiometric pressure probe
Time constant for each input	0.5 s
Input precision	± 0.3% of the complete scale
Classification of the average circuits (IEC EN 61010-1)	Category I
<b>Digital inputs</b>	
No. of inputs on SMALL boards	7
No. of inputs on MEDIUM boards	10
<b>Analogue outputs</b>	
Maximum number	3 in SMALL boards and 4 in MEDIUM boards
Type	0 to 10Vdc
Precision	± 3% of the complete scale or ± 5% of the complete scale (maximum load 5mA)
Resolution	8-bit
Maximum charge	2 kΩ (5 mA)
<b>Digital outputs</b>	
Composition of groups	SMALL board: Group 1 (1 to 6); Group 2 (7)
	MEDIUM board: Group 1 (1 to 6); Group 2 (7); Group 3 (8 to 12)
Electrical contacts	SMALL board (relays 1 to 7): EN60730-1: NO 1(1)A 250Vac cos φ =0.4; 100,000 χψχλεσ UL-873: NO 1 A resistive 24 Vac, 30 Vdc; 100,000 cycles Test capacity: 24Vac; pulse 15A; continuous 1A 30,000 cycles
	MEDIUM board (relays 1 to 12): EN60730-1: NO 1(1)A 250Vac cos φ =0.4; 100,000 χψχλεσ UL-873: NO 1 A resistive 24 Vac, 30 Vdc; 100,000 cycles Test capacity: 24Vac; pulse 15A; continuous 1A 30,000 cycles
	Note: relays of the same group with basic isolation must have the same power supply (24 Vdc or 230 Vac). Relays of the same group have basic isolation among themselves. The isolation between the various groups is double.

<b>microPC board</b>	
<b>TECHNICAL CHARACTERISTICS</b>	
Storage conditions	-20T70 °C; %RH 90 non-condensation
Operating conditions	-10T60 °C; %RH 90 non-condensation
Protection index	IP00
Environmental pollution	normal
Classification according to protection against electric shocks	To be incorporated in class I and/or II appliances
PTI of the insulating materials	250V
Period of electric stress across the insulating parts	Long
Type of relay action	1C
Type of disconnection or microswitching	Micro-switch for all of the relay outlets
Category of resistance to heat and fire	Category D (UL94 - V0)
Immunity from voltage surge	Category 1
Ageing specifications (operating hours)	80.000
Number of automatic operating cycles	100,000 (EN 60730-1); 30,000 (UL 873)
Software class and structure	Class A
Category of protection against discharges (IEC EN 61000-4-5)	Category III
Dimensions: Length x Height x Depth	SMALL board: 175 x 113 x 55 mm (10 DIN modules) MEDIUM board: 228 x 113 x 55 mm (13 DIN modules)

<b>pGD1 Terminal</b>	
<b>TECHNICAL CHARACTERISTICS OF THE DISPLAY</b>	
Type	FSTN graphic
Back-lighting	Blue LED (controlled using software)
Resolution	132 x 64 pixel
<b>TECHNICAL CHARACTERISTICS OF THE POWER SUPPLY</b>	
Voltage	Power supply through the telephone cable or external source 18/30 Vdc protected by an external 250 mA fuse
Maximum power input	1.2 W
<b>CONNECTION WITH THE microPC BOARD</b>	
Type	asynchronous half duplex, 2 dedicated wires
Connector for the terminal	6-way telephone plug
Driver	CMR 7 V (type RS485) balanced differential
<b>GENERAL FEATURES</b>	
Protection index	IP65 for assembly in panel
	IP40 for wall assembly
UL	type 1
Operating conditions	-20T60 °C, 90% RH non-condensing
Storage conditions	-20T70 °C, 90% RH non-condensing
Software class and structure	A
Classification according to protection against electric shocks	To be incorporated in class I or II appliances
PTI of the insulating material	250V
Dimensions: Length x Height x Depth	156 x 82 x 31 mm

<b>pCOe expansion module</b>	
<b>GENERAL FEATURES</b>	
Storage conditions	-40T70 °C; %RH 90 non-condensing
Operating conditions	-20T70 °C; %RH 90 non-condensing
Protection index	IP40 only on the front panel
Environmental pollution	2
Classification according to protection against electric shocks	To be incorporated in class I and/or II appliances
Period of electric stress across the insulating parts	Long
Type of relay action	1C
Type of disconnection or microswitching	Micro-switch for all of the relay outlets
Category of resistance to heat and fire	Category D
Immunity from voltage surge	Category III
Ageing specifications (operating hours)	80.000
Number of automatic operating cycles	100,000 (EN 60730-1); 30,000 (UL 873)
Software class and structure	Class A
Dimensions: Length x height x width	110 x 70 x 60 mm (4 DIN modules)
<b>CONNECTION WITH <math>\mu</math>PC MEDIUM</b>	
Type	Asynchronous half duplex, 2 dedicated wires
Connector	Removable 3-way connector
Driver	Balanced differential MCR 7V
Maximum distance to $\mu$ PC MEDIUM	With telephone cable: - cable resistance $\leq 0.14 \Omega/m$ : 600 metros - cable resistance $\leq 0.25 \Omega/m$ : 400 metros With shielded cable AWG24 - cable resistance $\leq 0.078 \Omega/m$ : 600 metros
<b>ELECTRICAL FEATURES</b>	
Power supply	24 Vac +10/-15% 50/60 Hz and 48 Vdc (36 to 72 V); P = 6 W (9 VA)
Terminal strip	with removable male/female connectors (250 Vac max.; 8 A max.)
CPU	at 8 bits and 4.91 MHz
Operation delay	0.5s
Maximum transmission speed	19200 bps
<b>Analogue inputs</b>	
Analogue conversion	A/D converter to 10-bit integrated in CPU
Maximum number	4 (B1 to B4)
Type (this can be selected via software)	NTC Carel (-50/90°C; R/T 10k $\Omega$ $\pm$ 1% to 25°C) Voltage: 0/1 Vdc, 0/5 Vdc radiometric or 0/10 Vdc current: 0/20 mA or 4/20 mA. Input resistance: 100k $\Omega$
NTC input type precision	$\pm 0.3$ complete scale
<b>Digital inputs</b>	
Number and type	4, contact voltage-free, 5 mA, inputs not optically isolated, internal power supply
<b>Analogue outputs</b>	
Number and type	1 (Y1) optically isolated 0/10 Vdc
Precision	$\pm 1\%$
Resolution	8-bit
Maximum charge	1 k $\Omega$ (10 mA)
<b>Digital outputs</b>	
Number and type	4, relays with switched contacts (2000 VA, 250 Vac, 8 A resistive)
Characteristics (EN 60730-1)	2 A resistive, 2 A inductive, $\cos \varphi = 0.4$ , 2(2)A (100.000 cycles)

TCO Terminal	
TECHNICAL CHARACTERISTICS OF THE POWER SUPPLY	
Voltage	Power supply 230Vac(+10/-15) 50/60Hz
Maximum power	1 VA
CONNECTION WITH THE microPC BOARD	
Type	AGW20 or AGW22 with 1 braided pair + drainwire + shielding
GENERAL FEATURES	
Protection index	IP20
Operating conditions	-10T60 °C, 10 to 90% RH non-condensing
Storage conditions	-20T70 °C, 10 to 90% RH non-condensing
Software class and structure	A
Environmental pollution	2
Category of resistance to heat and fire	Category D
Immunity from voltage surge	Category 2
Classification according to protection against electric shocks	To be incorporated in class I and/or II appliances
Electric safety	IEC EN 60730-1, IEC EN 60730-2-9
Electromagnetic compatibility	IEC EN 61000-6-1, IEC 61000-6-3, IEC EN 61000-6-2, IEC EN 61000-6-4
PTI of the insulating material	275 V
Precision of the temperature measurement	0T40 °C ± 1%
Dimensions: Length x Height x Depth	Model to fit: 86 x 86 x 51 mm Surface model: 86 x 142 x 23 mm or 142 x 86 x 23 mm

## 28.1. Ambient probe

### Wall version (DPW)

Case index of protection: IP30 / Sensor index of protection: IP30.

#### Assembly and setting instructions

- This probe must be fixed to the panel or the wall of the room to be conditioned, at ca. 1.5 m height.
- Open the case using a flathead screwdriver in the slot, paying extra care not to damage the electronic parts.
- Fasten the rear of the sensor case to the panel or the wall (for fastening the case, use the screws supplied with the fastening kit, paying attention to use the proper spacers, to not damage the sensor's electronics).
- The electrical connection must be carried out depending on the unit setting:
  - NTC (B3 - connector J3) : with 2 x 1,5 mm<sup>2</sup> section cable, within a maximum distance of 30 metres.
  - RS485 (connector J10): with AWG20 section cable, single braided pair preferably shielded with drain wire + Power supply 24 Vac (2 wires).
- Close the sensor with the top cover by pressing lightly.

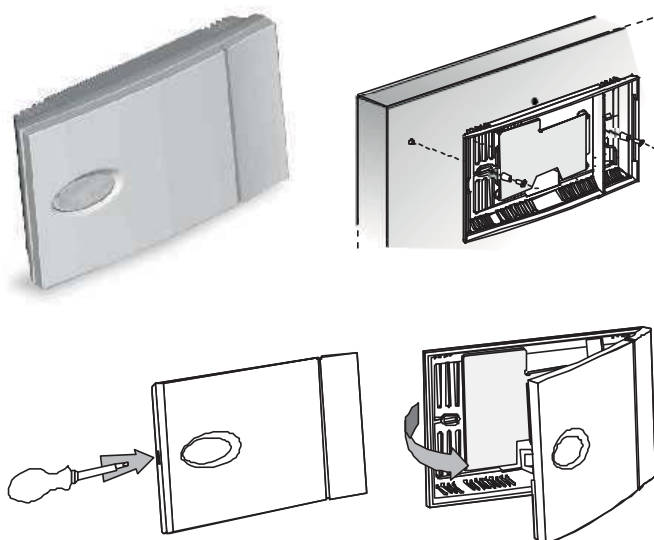

Inside view, bottom shell



Inside view, top shell

## Duct version (DPD)

Case index of protection: IP55 / Sensor index of protection: IP40.

### Assembly and setting instructions

- The duct version is connected to the air duct using the special fastening bracket.
- Fasten the bracket to the air duct.
- Insert the rod on the bracket to the required depth.
- Tighten the screw on the bracket to fasten.

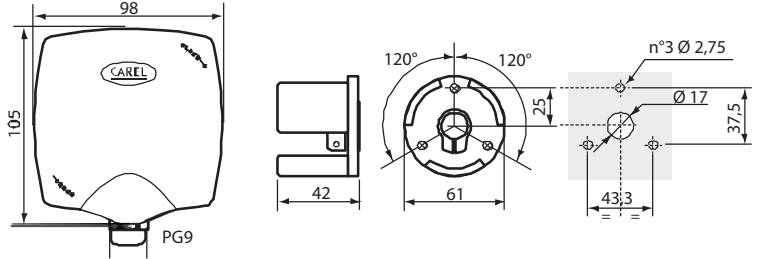

For the electrical connections, remove the top cover of the sensor. Remove the cover by rotating it anticlockwise



## Industrial environment version (DPP)

Case index of protection: IP55 / Sensor index of protection: IP54.

### Assembly and setting instructions

- The industrial environment version is wall or panel mounted.
- Open the case by turning the top cover anticlockwise (fig.1).
- Fasten the rear of the sensor case to the panel or the wall (use the screws supplied together with the sensor) placing the screws in the holes provided (fig.2).
- Make sure that the screws that hold the board protective cover are fastened tightly (fig.3).
- Close the sensor by turning the cover clockwise (fig.4).

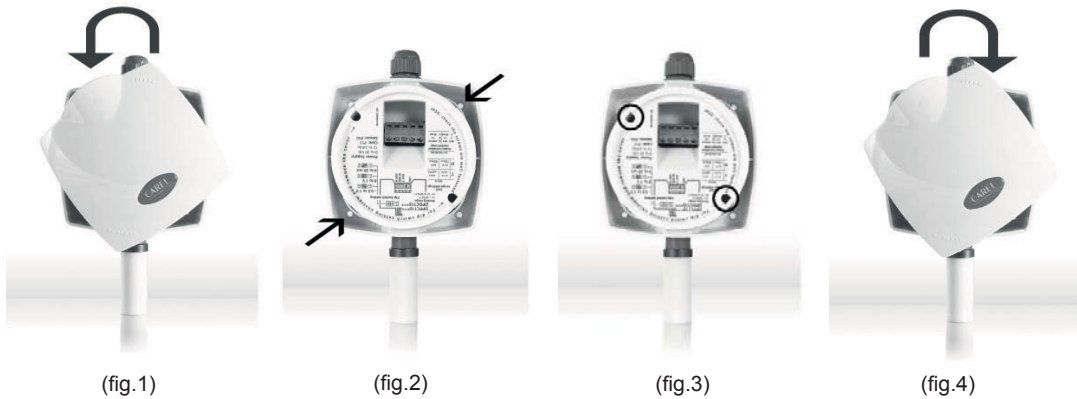
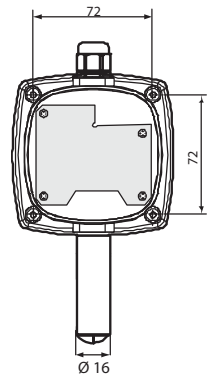

## Cleaning and maintenance

When cleaning the instrument do not use ethyl alcohol, hydrocarbons (petrol), ammonia and derivatives. Use neutral detergents and water. Periodically check the aeration slits on the sensor to make sure that air can flow freely through, without obstructions due to impurities or dust in the site of installation.

## 28.2. Air quality probe 4.. 20 mA

### Installation in the environment

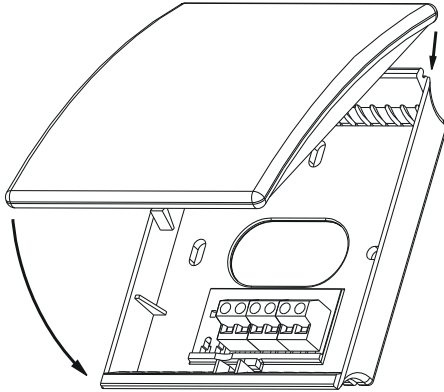

- This probe must be fixed to the interior wall of the room to be conditioned, at ca. 1.5 m height in the room and at least 50 cm from the next wall.
- It should never be mounted:
  - On outside walls.
  - In niches or behind curtains.
  - Above or near heat sources or shelves.
  - On walls covering heat sources such as a chimney.
  - In the radiation range of heat sources and lighting bodies e.g. spotlights.
  - In areas exposed to direct solar radiation.

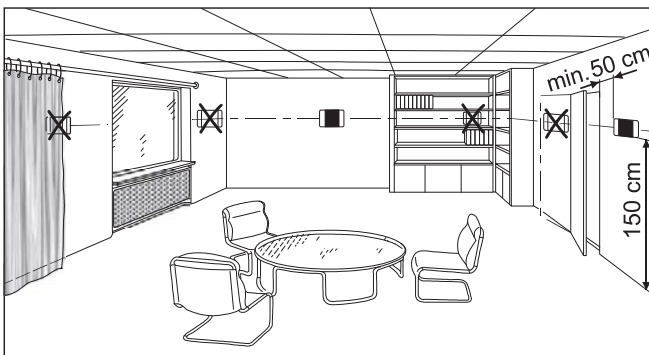

### Duct-mounted

This version can be connected to the air duct in these two ways:

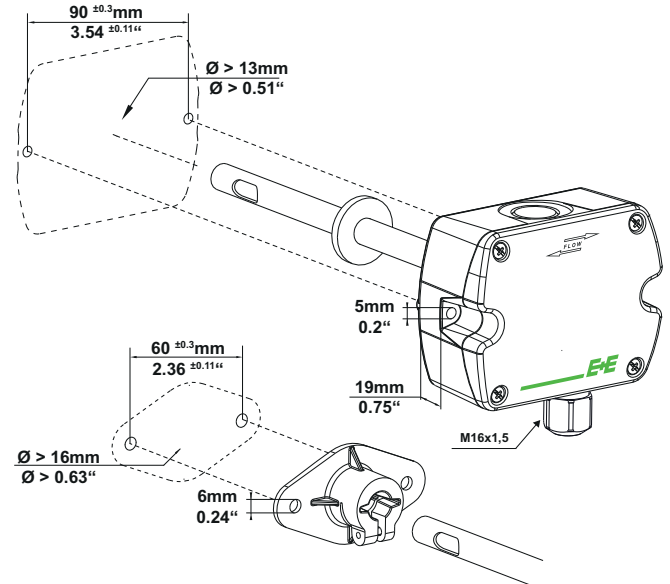

### Electrical connection

This probe (S10) is configured by analogue output 4...20 mA (0..2000 ppm), in the analogue input B10 of the control board (connector J18).  
Recommended cable section : 1,5 mm<sup>2</sup>.

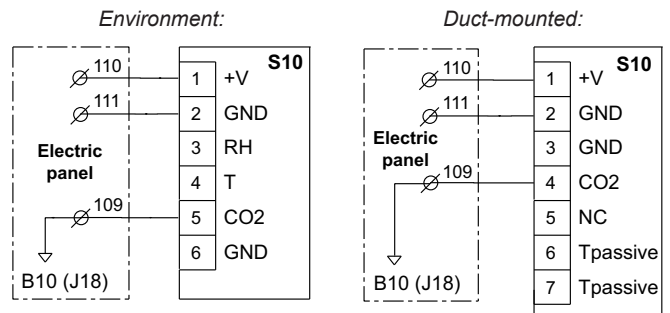

## 29. TROUBLESHOOTING

- The unit does not switch on (the power LED on the main board is switched off).

Check:

1. the presence of main power;
2. that the transformer output voltage is 24 Vac/Vdc;
3. that the power supply connector at 24 Vac/Vdc is correctly inserted;
4. that the overload fuse is intact.

- When switching on, there are general problems with the LCD (strange characters, blank display).

Check:

1. that the software in the flash is correct;
2. the pLAN address of the pCOc and on the terminal (check that they comply with the requirements of the current application);
3. the connection between the pGD1 terminal and the μPC MEDIUM board.

- Erroneous readings of the input signals.

Check:

1. the correct power supply to the μPC MEDIUM board and probes;
2. the separation between the power supply of the digital inputs and that of the μPC MEDIUM board. A 24 Vac/24 Vac, 5 VA transformer can be used.
3. that the cables from the probes are connected according to the instructions;
4. that the probe cables are located far enough away from possible sources of magnetic interference (power cables, contactors, high voltage cables or cables connected to units with high current peaks);
5. that there is not a high level of heat resistance between the probe and the sensor cap (if present). If necessary, apply conductive paste or oil into the caps to ensure good temperature transfer.
6. If there is a probe error or μPC MEDIUM board conversion error, the checks to be carried out would vary depending on the type of probe:

### Active temperature/humidity probes with 0/1V signal:

using a voltmeter, measure the probe signal between the Bn and GND terminals and check that the voltage corresponds to the temperature/humidity value: 1 mVdc corresponds to 0.1% HR.

Example: reading 200 mVdc (0.2 Vdc), the probe sends a signal which corresponds to 20%RH; applying the same logic, 0 mVdc corresponds to 0°C/0% RH;

### Pressure probes:

if there are errors when reading these probes, check that:

- the analogue inputs of these sensors are set to receive 4/20 mA signals;

- check that the probe capillary is not blocked.
- the full scale set by the software corresponds to that used by the sensors.

Using a voltmeter to measure the voltage between the Bn and GND terminals, an indication is obtained of the current probe signal, considering that the input has an impedance of 100Ω, by applying the formula  $I = V/R$ .

The pressure value "Ps" sent by the probe could be calculated as follows (FS = full scale):

$$Ps = (Vmed/100 - 0.004) \times (FSmax - FSmin) / 0.016 + FSmin$$

*Example:* the probe used has  $FSmin = -0.5$  bar,  $FSmax = 7$  bar; the voltage read is equal to  $Vmed = 1.0$  Vdc.

The pressure Ps that the probe is measuring is thus:

$$Ps = (1.0/100 - 0.004) \times [7 - (-0.5)] / 0.016 + (-0.5) = 2.3 \text{ bar}$$

### NTC probes:

The probe signal is a resistive value which depends on the temperature.

The following table indicates some of the resistance values for different temperatures. By disconnecting the input probe and measuring the resistance with a multimeter, the table can be consulted for the corresponding temperature value.

°C	kΩ	°C	kΩ	°C	kΩ
-20	67,7	0	27,2	20	12,0
-15	53,3	5	22,0	25	10,0
-10	42,2	17	17,9	30	8,3
-5	33,8	15	14,6	35	6,9

- To check the setting of the probe inputs.

Switch off the μPC MEDIUM board and perform the following measurements with a tester between the Bn and AVSS probe inputs:

probe type	voltage measured
NTC	2.5 V
4/20mA	0 V
0/1V; 0/5V; 0/10V	0 V

- Unusual alarm signal from the digital input.

Check whether the alarm signal is present in the input, measure the voltage between the "IDC" common terminal and the digital input terminal which indicates the alarm "IDn":

- if voltage is present (24 Vac or Vdc, depending on the power supply used for the digital inputs), the contact of the connected alarm device is closed;
- if the voltage is near 10 Vac or 10 Vdc (see above) the contact is open.

Unless otherwise expressly stated, the control generates an alarm when detecting open contacts.

