

SCHEMA ELECTRIQUE ELECTRICAL DIAGRAM

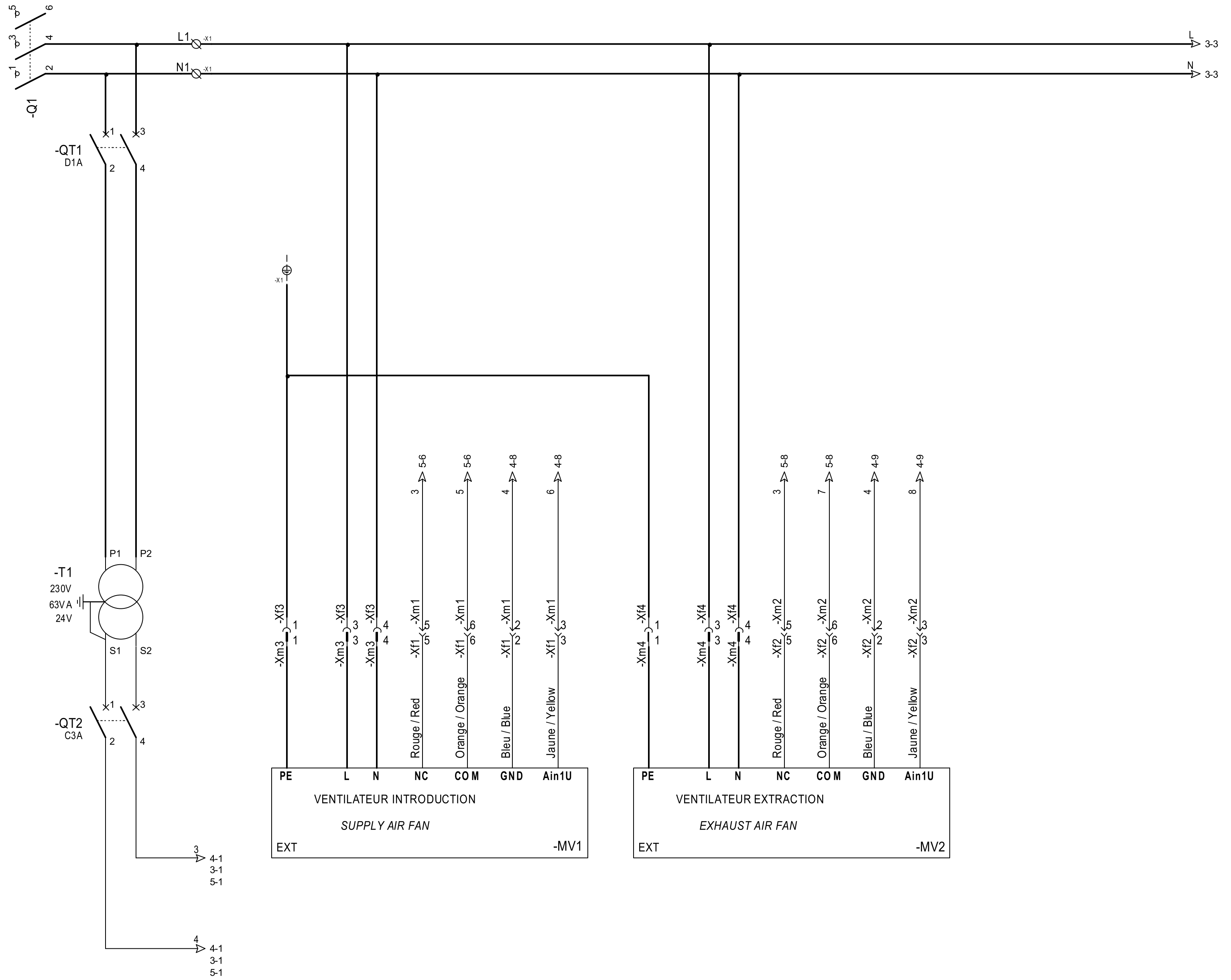

				NUMERO DE COMMANDE : ORDER NUMBER :			
				CLIENT : CUSTOMER :			
				APPAREIL OU UNITE : TYPE OF UNIT : CLASSIC VERTICAL 700			
				TENSION : SUPPLY : 1~ 230V 50Hz			
				REFERENCE : REFERENCE :			
				DESIGNATION : DESIGNATION :			
NS-AGP	09/03/2020	01	MaJ Raccordement SMR1				
NS-AGP	28/06/2019	00	Capture				
DESS	DATE	IND	MODIFICATION				
N° OMT :			CREATEUR : CREATED BY : NS-AGP	LEGENDE : LEGEND :	NUMERO DE SCHEMA DIAGRAM NUMBER 7561782	INDICE INDEX 01	FOLIO FOLIO 1/9
			DATE : 28/06/2019 DATE :				

ALIMENTATION 1 ~ 230V 50Hz
 RACCORDEMENT SUR
 LE SECTIONNEUR
 SUPPLY 1 ~ 230V 50Hz
 CONNECTION ON
 ISOLATOR



ARM

DESIGNATION :
 DESIGNATION :



PUISSANCE
 POWER

NUMERO DE SCHEMA
 DIAGRAM NUMBER

7561782

INDICE
 INDEX

01

FOLIO
 FOLIO

2/9

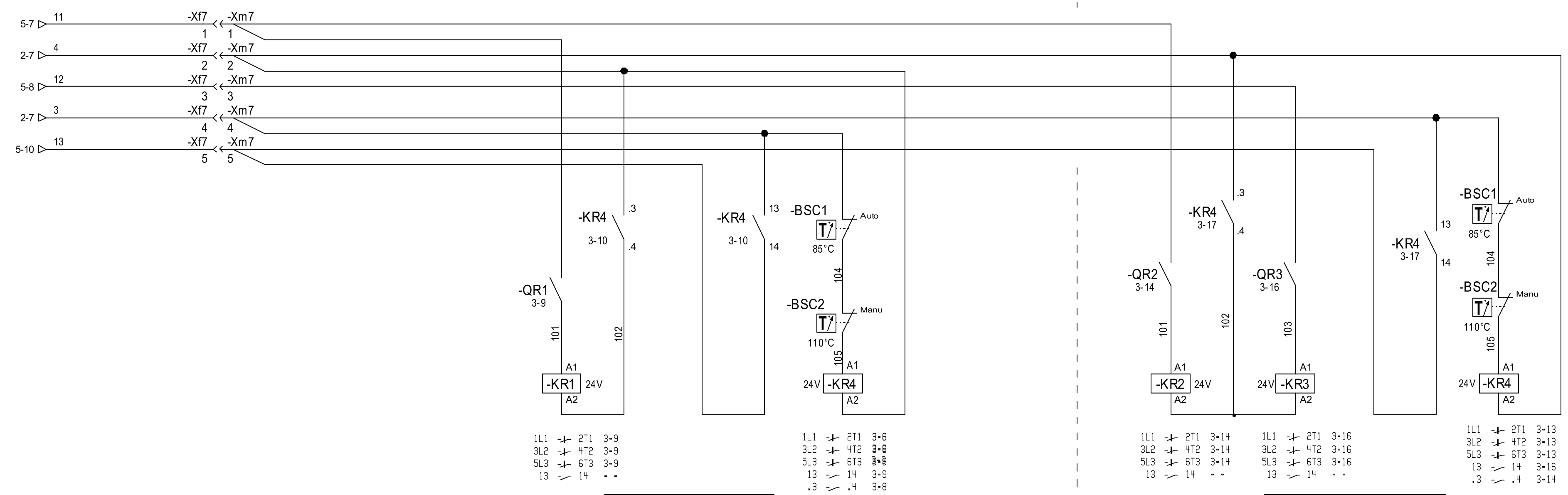
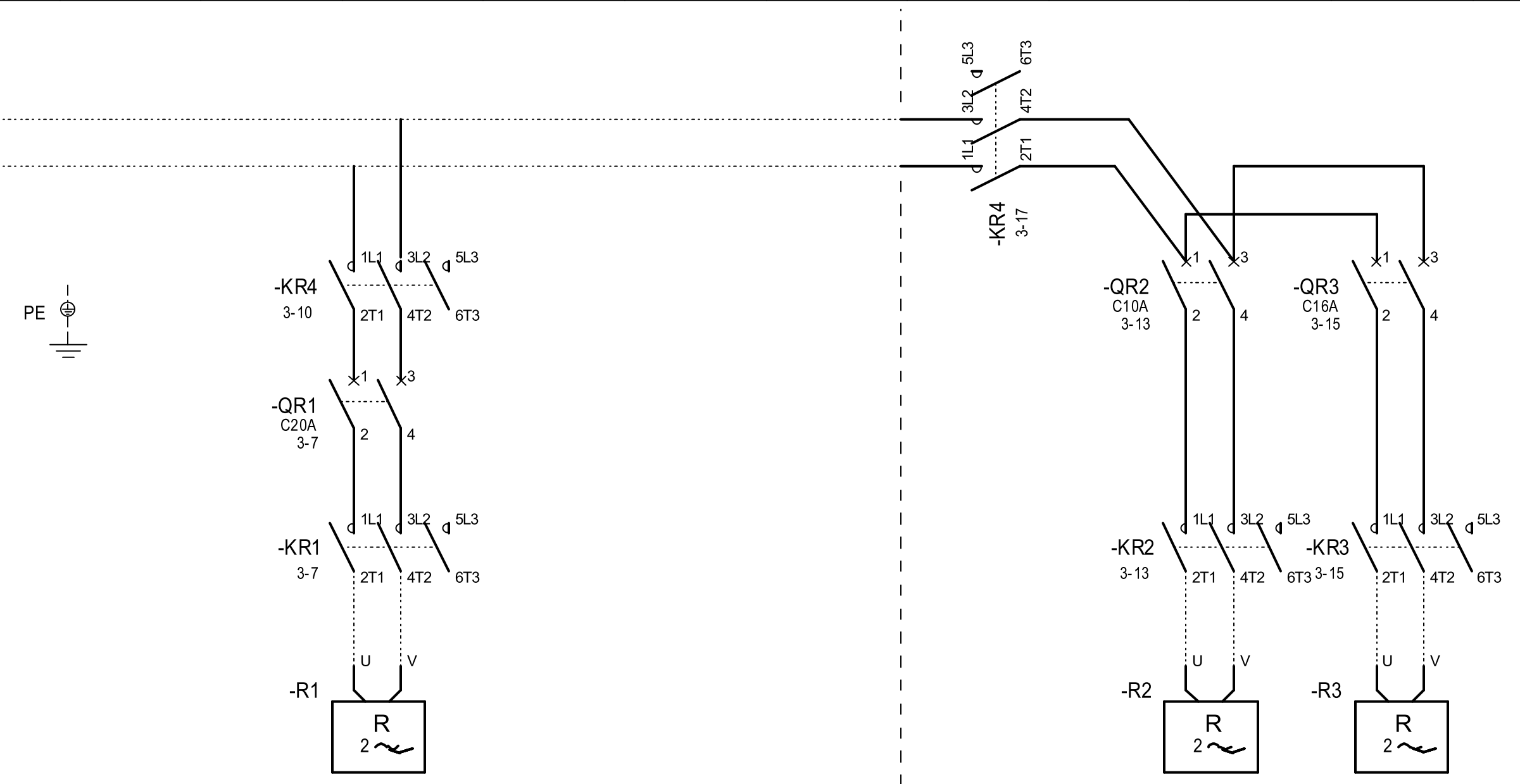
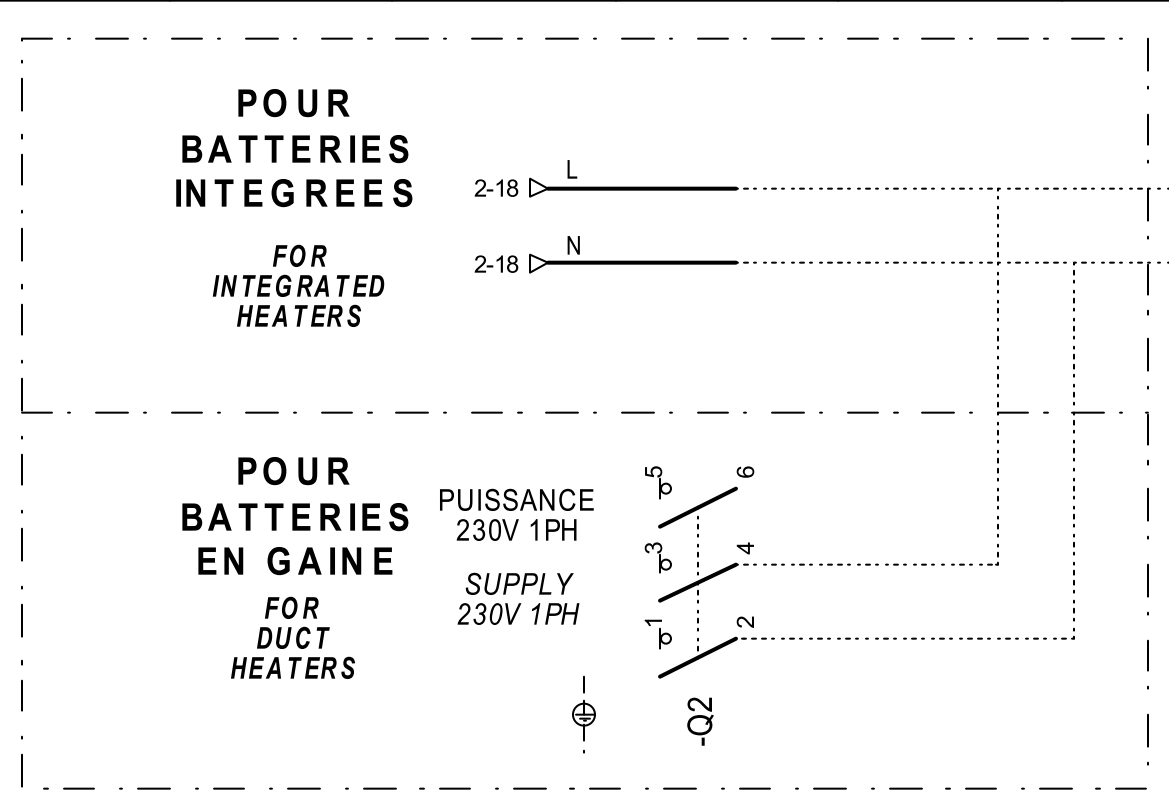

**Batterie 1 étage
Step 1 electric heater**

**Batterie 2 étages
Step 2 electric heater**

DESIGNATION :
DESIGNATION :



**BATTERIES ELECTRIQUES
ELECTRIC HEATER**

NUMERO DE SCHEMA
DIAGRAM NUMBER
7561782

INDICE
INDEX
01

FOLIO
FOLIO
3/9

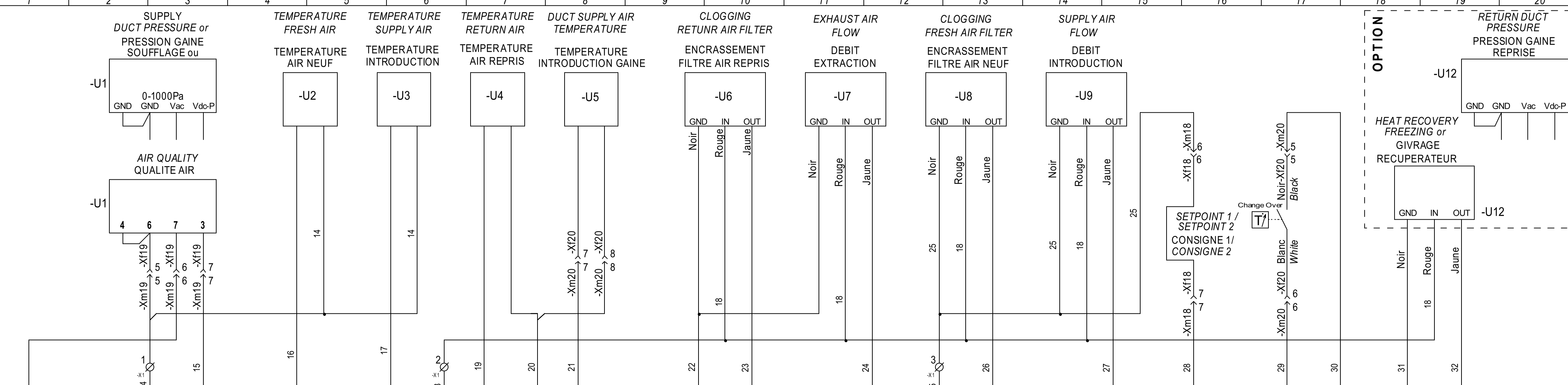

AUTOMATE

CONTROLLER

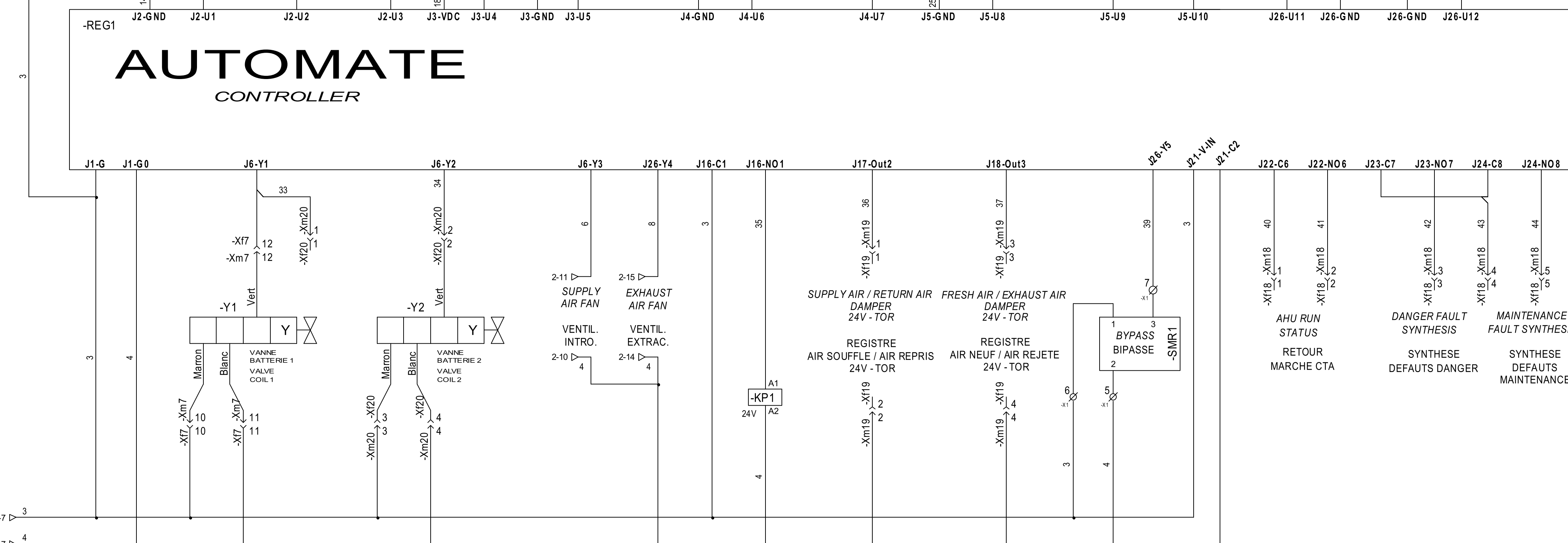

PUMP 1 CONTROL
COMMANDE POMPE 1

14 12 11 5-16
24 22 21 - -

ARM

DESIGNATION :
DESIGNATION :



COMMANDE
CONTROL

NUMERO DE SCHEMA
DIAGRAM NUMBER

7561782

INDICE
INDEX

01

FOLIO
FOLIO

4/9

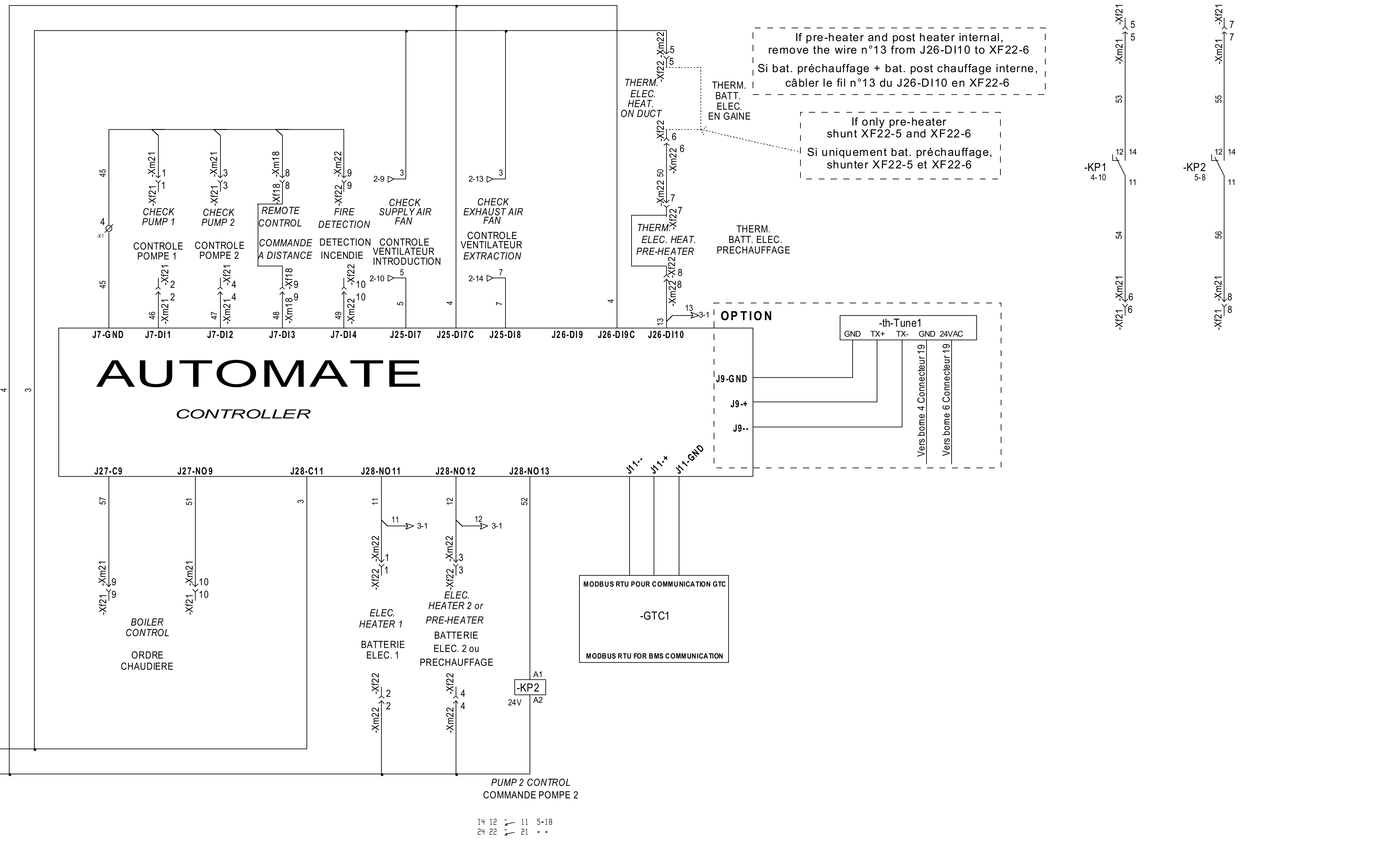

ARM

DESIGNATION :
DESIGNATION :



COMMANDE -2
CONTROL -2

NUMERO DE SCHEMA
DIAGRAM NUMBER
7561782

INDICE
INDEX
01

FOLIO
FOLIO
5/9

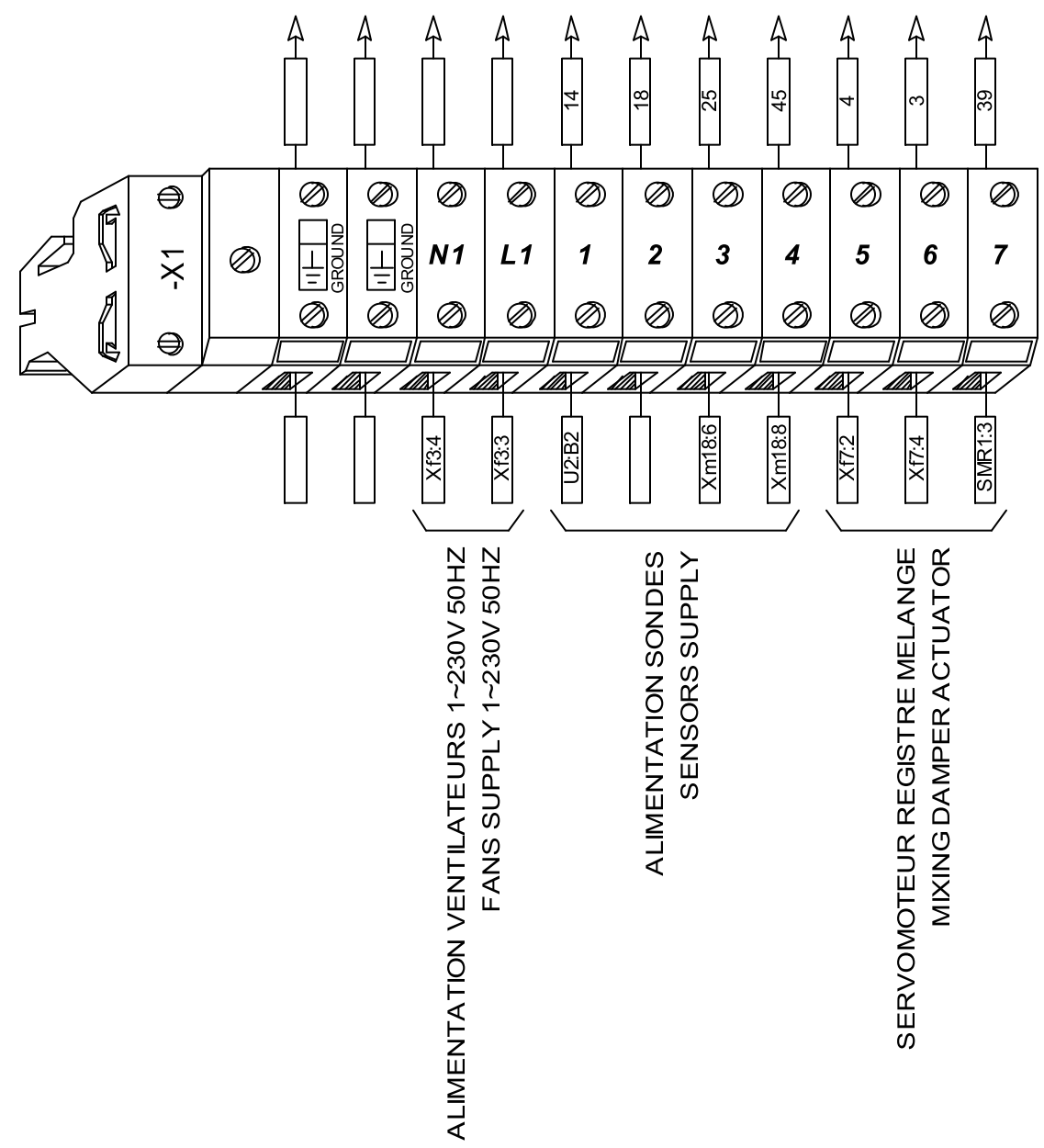

ARM

DESIGNATION :
DESIGNATION :

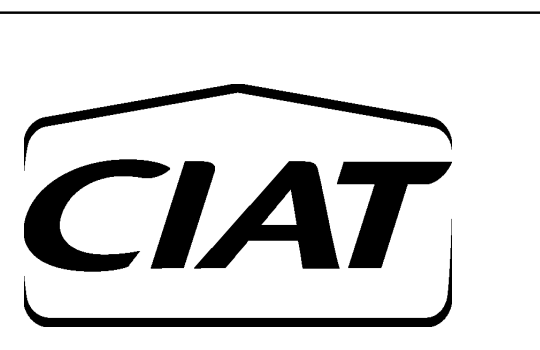

Bornier : X1		
X1 - 1/1		
NUMERO DE SCHEMA DIAGRAM NUMBER	INDICE INDEX	FOLIO FOLIO
7561782	01	6/9

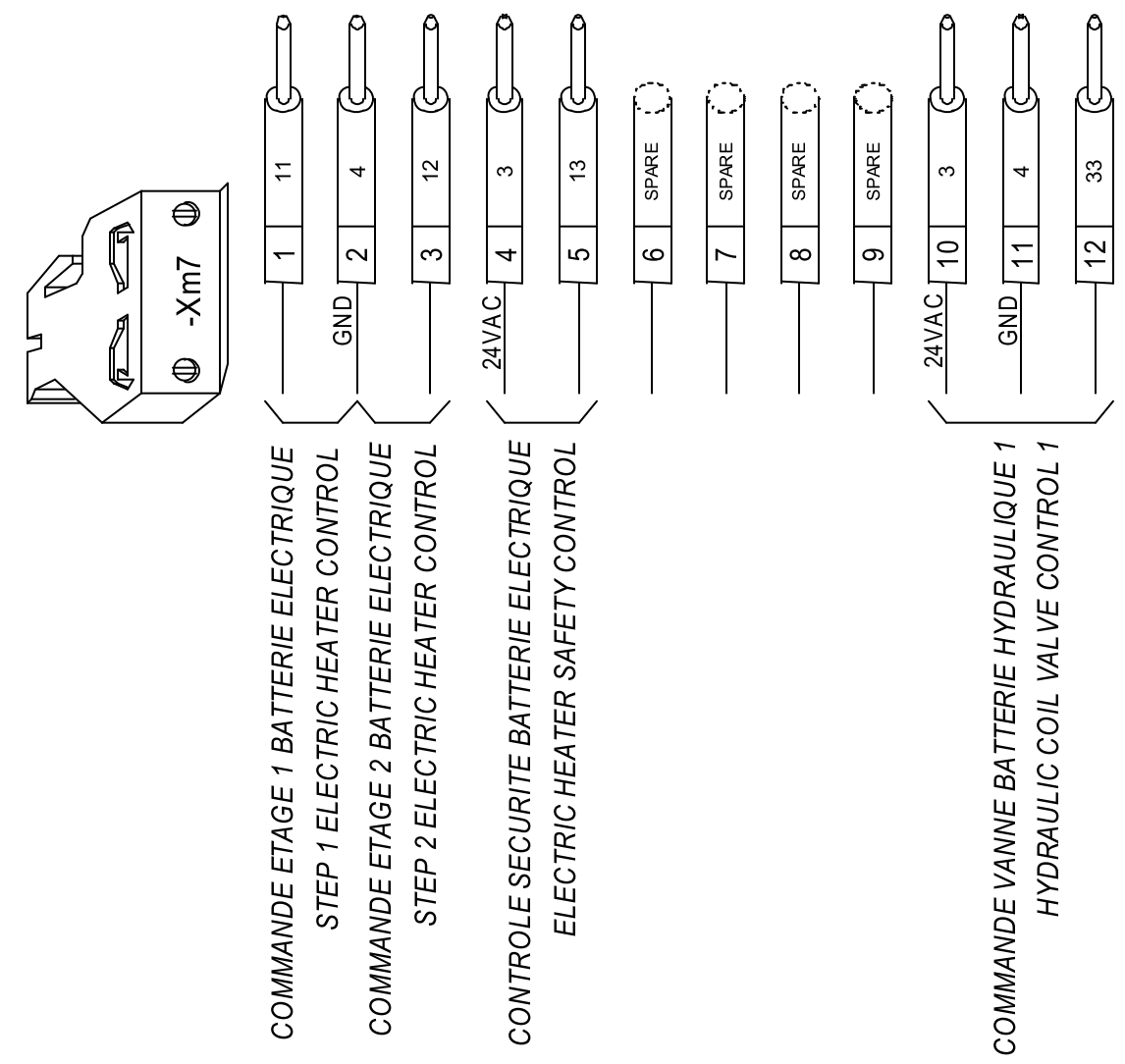
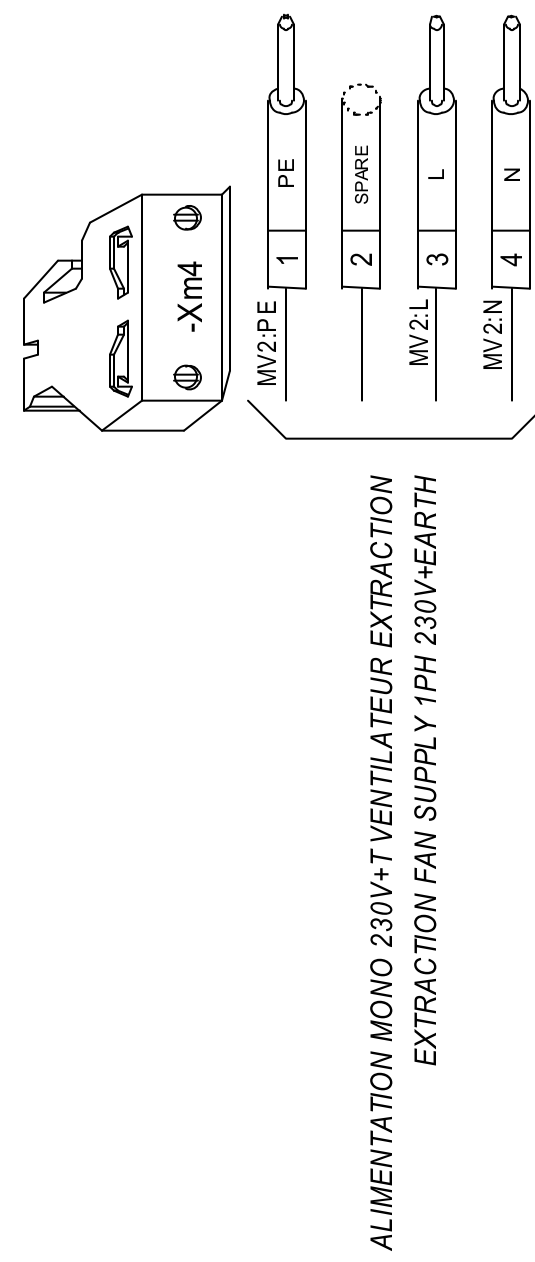
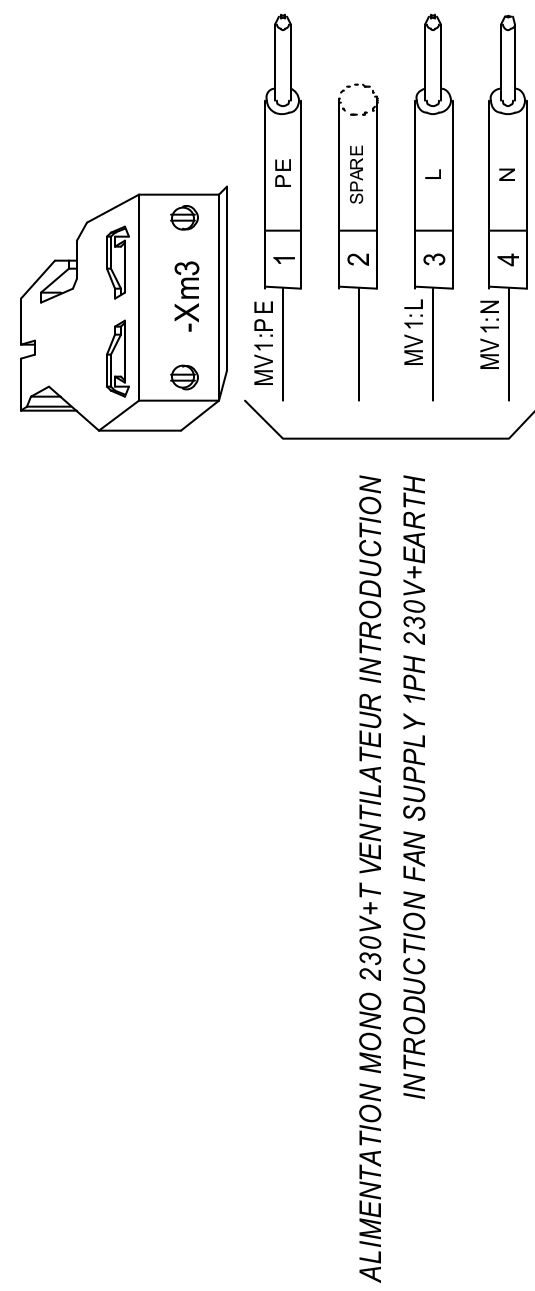
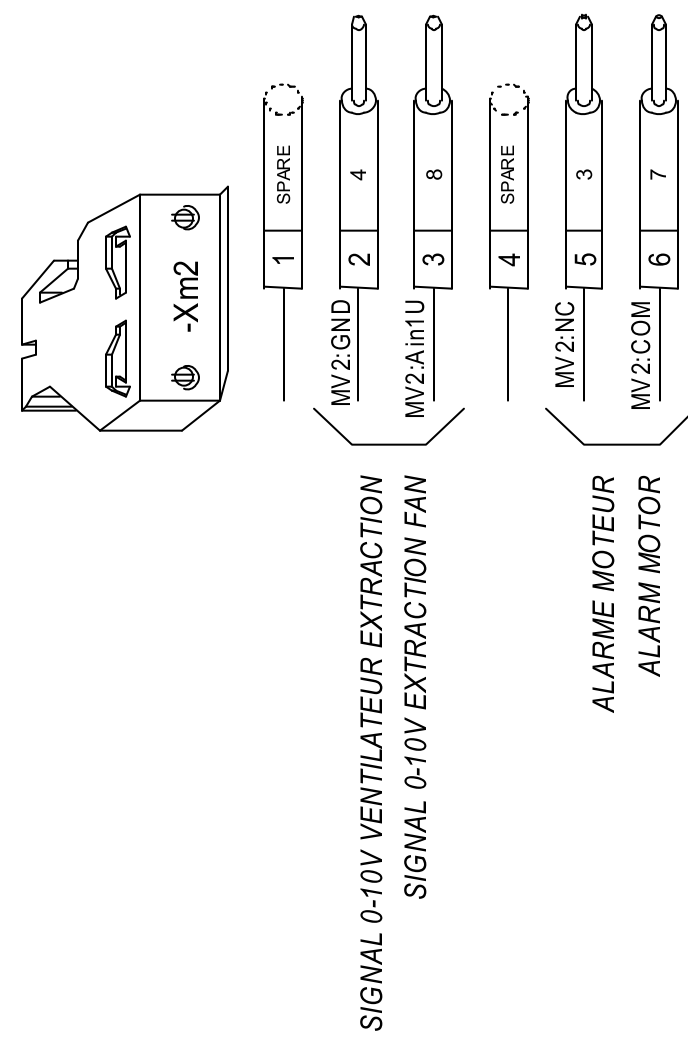
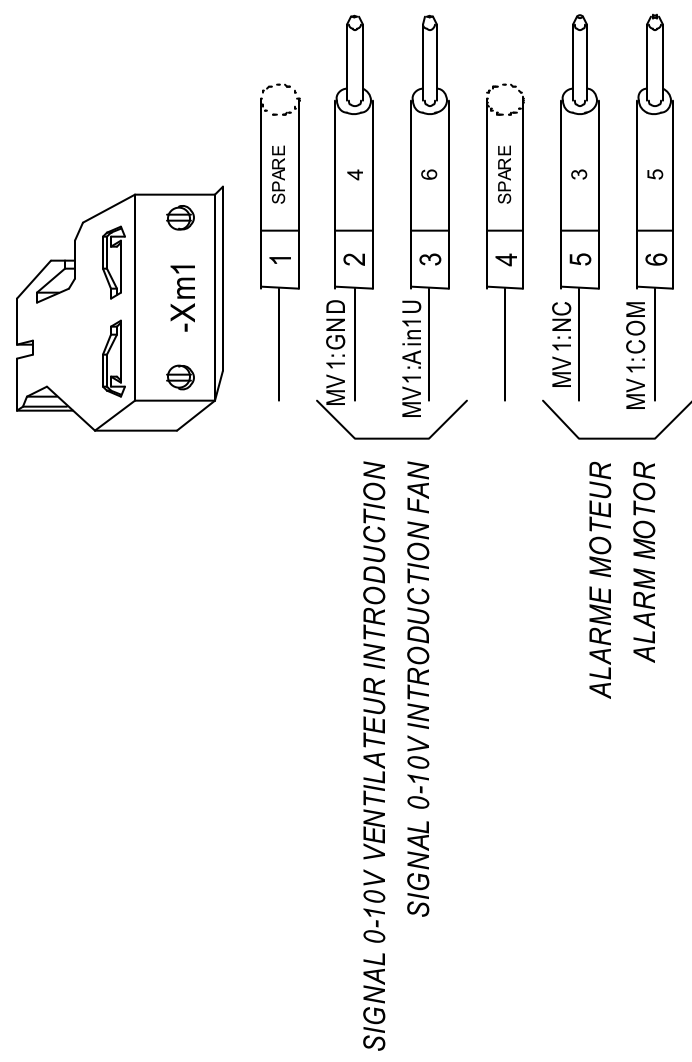

ARM

DESIGNATION :
DESIGNATION :



Connecteurs: Xm1, 2, 3, 4 et 7

Connectors: Xm1, 2, 3, 4 and 7

NUMERO DE SCHEMA
DIAGRAM NUMBER

7561782

INDICE
INDEX

01

FOLIO
FOLIO

7/9

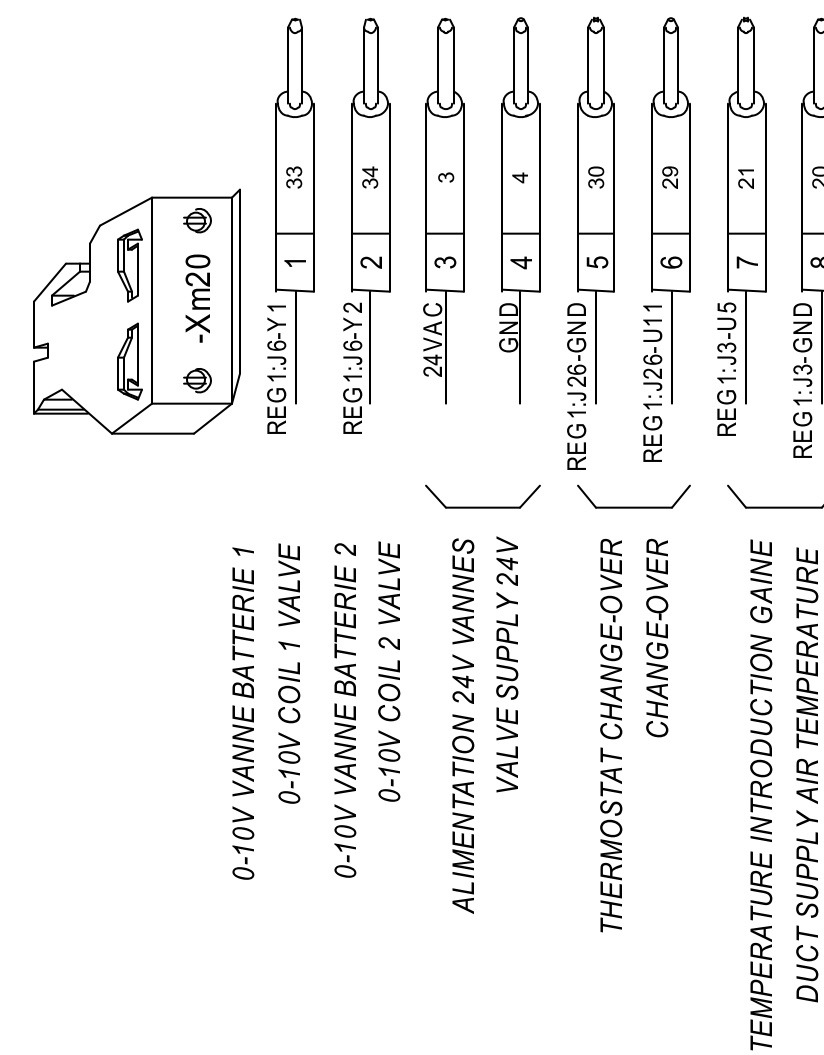
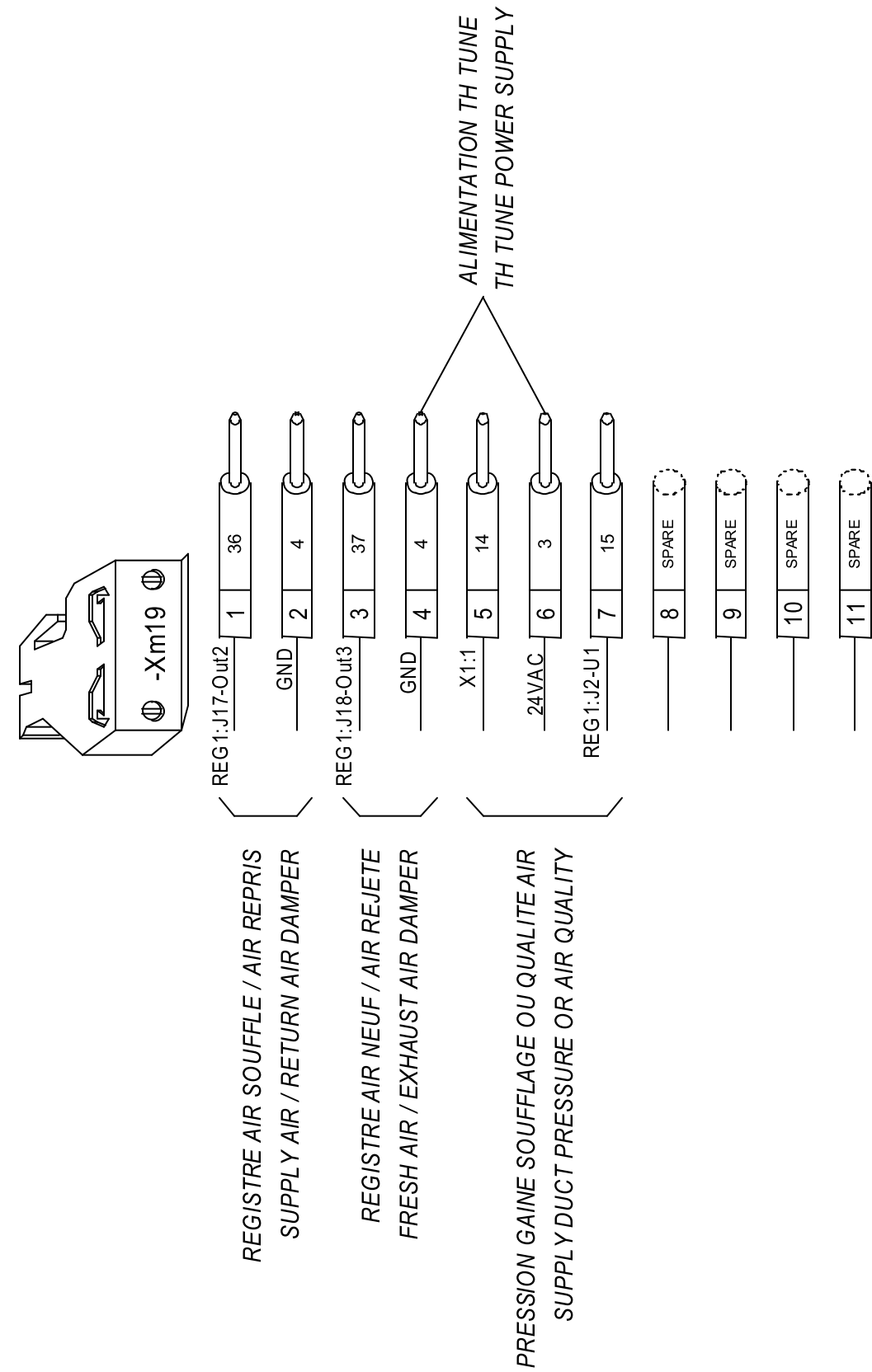
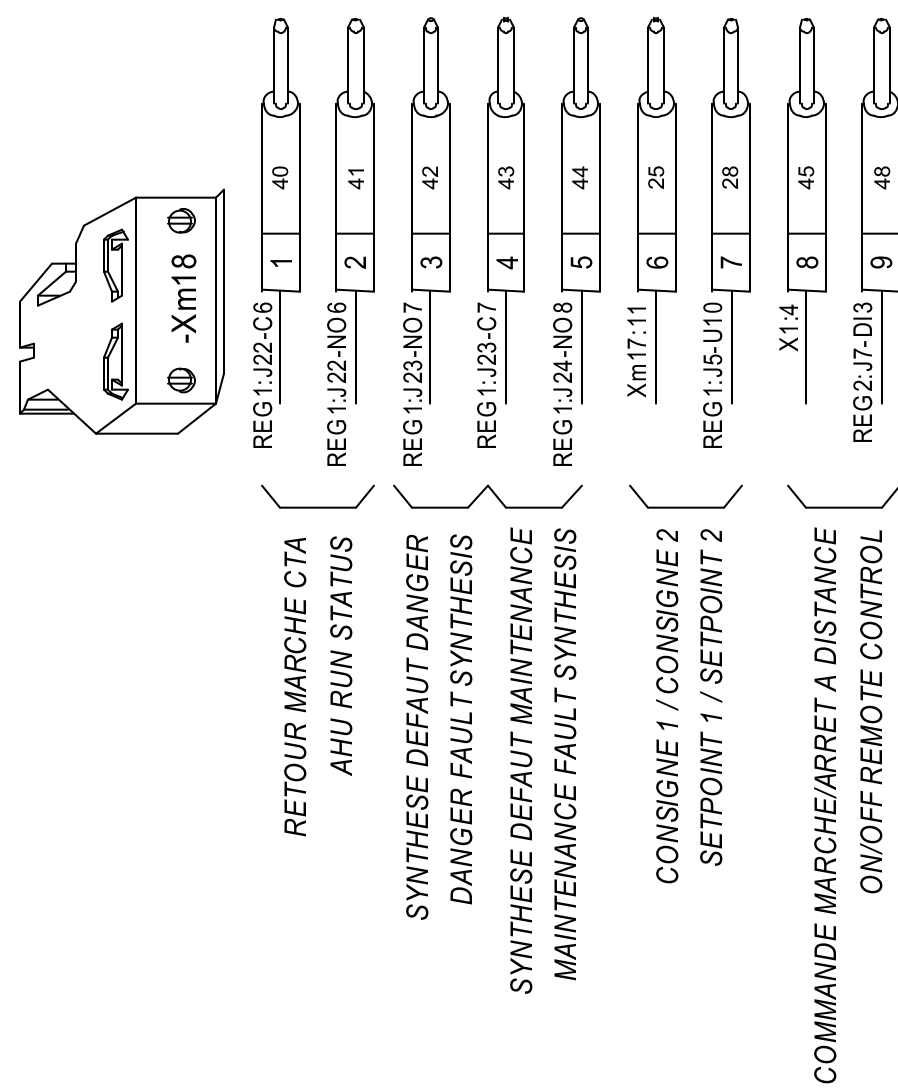

ARM

DESIGNATION :
DESIGNATION :



Connecteurs: Xm18, 19 et 20 (OPTIONS CLIENT)
Connectors: Xm18, 19 et 20 (CUSTOMER OPTIONS)

NUMERO DE SCHEMA
DIAGRAM NUMBER

7561782

INDICE
INDEX

01

FOLIO
FOLIO

8/9

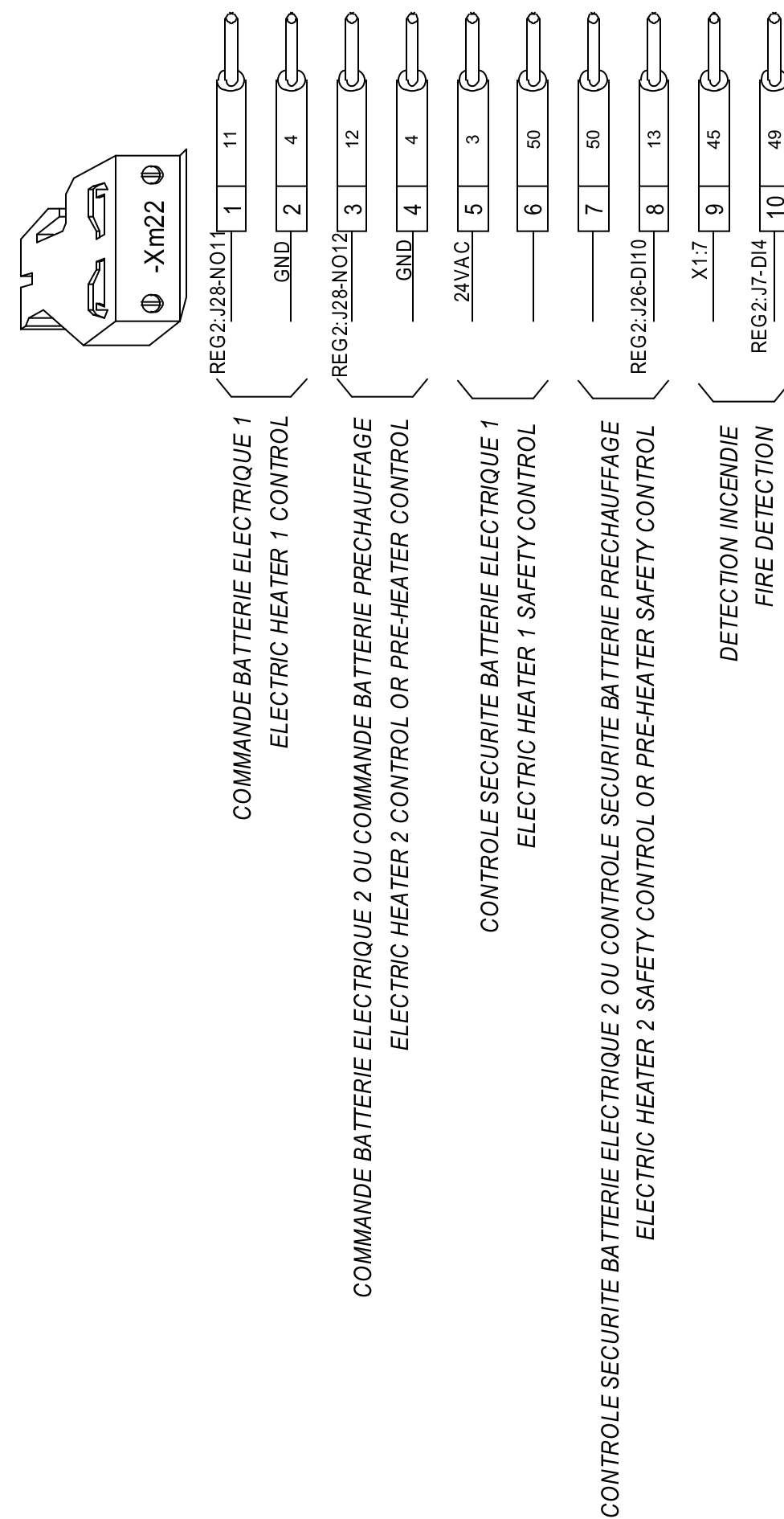
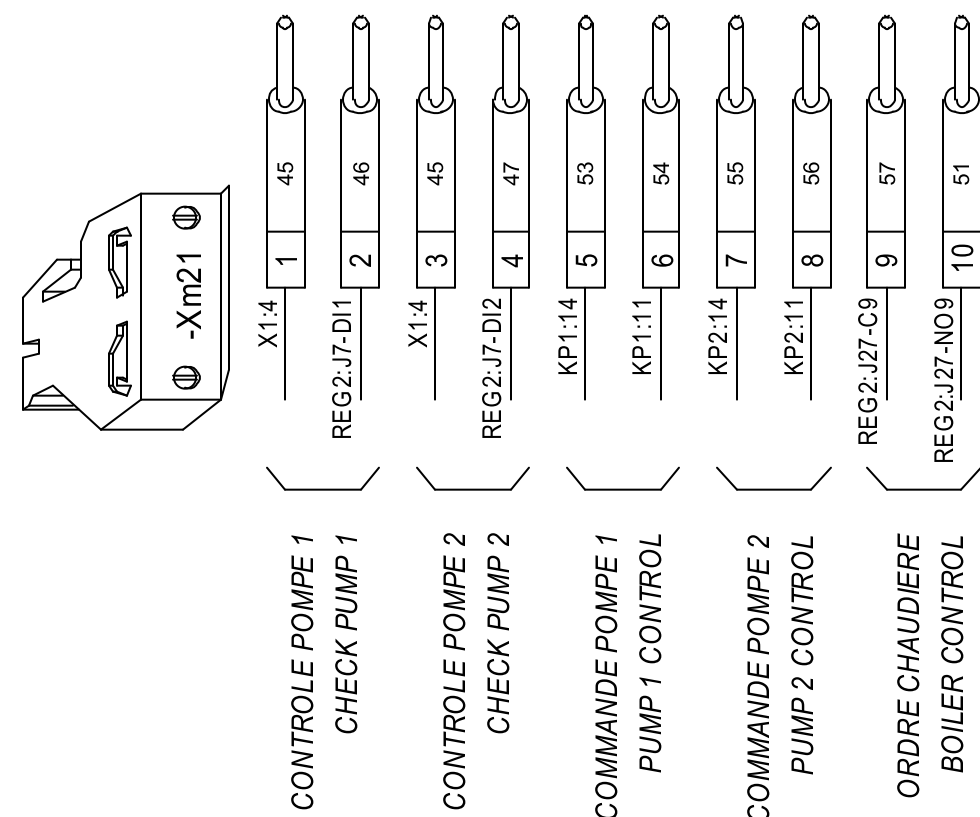

ARM

DESIGNATION :
DESIGNATION :



Connecteurs: Xm21 et 22 (OPTIONS CLIENT)
Connectors: Xm21 and 22 (CUSTOMER OPTIONS)

NUMERO DE SCHEMA
DIAGRAM NUMBER

7561782

INDICE
INDEX

01

FOLIO
FOLIO

9/9