



 2024

**FAMILY AND FISHING BOATS**  
FULLY-PRICED BUYING GUIDE



# Our Story

In 1968, two young friends, Vic Duhamel and Carl Dewar decided to start a business. Over the years, they sold products ranging from tires to RVs before realizing how much they loved helping people onto the water and into the boating lifestyle. There were two big issues that they found. Buying a boat was much too difficult, and there really wasn't a boat designed for the Canadian environment.

In 1986, with the goal of simplifying the ownership experience and offering a boat designed by Canadians and built for Canadians, Legend Boats was born. Vic and Carl started by creating affordable and complete boat, motor and trailer packages. They beefed up their boats with thicker aluminum and made full stand-up tops available on every full windshield model. This ensured that every Legend boat could handle the rugged Canadian climate while keeping boaters safe and comfortable.

Seven children and fifteen grandchildren later, Legend is proud to have the same owners and same focus on family values as it did over 38 years ago when Vic and Carl decided to dedicate their lives to making it easier and more affordable to get on the water. We can't wait to welcome you to the Legend Family so that you can start creating your memories!





## A MESSAGE FROM OUR CEOs

As the CEOs of Legend Boats, we are thrilled to introduce you to our 2024 Family and Fishing Boats Fully-Priced Buying Guide. At Legend Boats, we have always strived to set new standards in the boating industry, and this catalogue is no exception. Since 1987 we have produced Canada's only fully-priced boating catalogue. We take great pride in knowing that after 38 years, we remain the only company to produce a fully-priced catalogue in Canada. This innovative approach reflects our commitment to transparency, honesty, and our unwavering dedication to providing you with the best boating experience possible.

Our team has poured their heart and soul into creating this comprehensive catalogue, meticulously detailing every boat model and accessory we offer. We understand that choosing the perfect boat is a significant decision, and we want

to make the process as straightforward and transparent as possible for you. This catalogue serves not only as a valuable buying tool but also as a takeaway for our customers visiting our retail stores, dealerships, and boat shows across Canada. It's a testament to our passion for boating and our desire to make your boating dreams come true.

As Canadians designing and manufacturing boats for Canadians, we are proud to offer products that are tailored to meet the unique needs and preferences of our fellow boating enthusiasts. We hope this catalogue will help you find the perfect Legend Boat that suits your lifestyle and allows you to create unforgettable memories on the water. Thank you for choosing Legend Boats, and we look forward to serving you in the upcoming boating season.

*To another year of Creating Memories that last a lifetime.*

A handwritten signature in black ink, appearing to read 'Marc Duhamel'.

Marc Duhamel | Co-CEO & President

A handwritten signature in black ink, appearing to read 'Jamie Dewar'.

Jamie Dewar | Co-CEO





## IN MEMORIAM

*October 5th, 2023*

---

### ***Victor Duhamel, A Pioneer of the Canadian Boating Industry***

We regretfully announce the passing of Victor Duhamel, the co-founder of Legend Boats and a luminary in the Canadian boating realm. Born in Lively, Ontario on February 15th, 1941, Victor's journey from selling tires at Duhamel & Dewar to his induction into the Canadian Boating Industry Hall of Fame is nothing short of extraordinary.

As a visionary in the marine industry, Victor reshaped the Canadian boating landscape, introducing pioneering concepts like the first fully-priced boat catalogue in 1987 and innovative boat features. Beyond his professional achievements, he was known for his warmth and genuine interest in others.

Victor Duhamel's legacy extends beyond the industry; it's a testament to his love for family and the great outdoors. His love for RV travels and adventure, along with his profound impact on family and friends, will always be cherished. With his sons, Marc and Jeff, and the next generation of Duhamels continuing his legacy, Victor's influence is set to endure.

Victor's passing is an immeasurable loss to the Legend Boats family, the boating community, and all of Canada. His legacy, filled with innovations and cherished memories, will remain a source of inspiration for generations to come.







## Our mission is to Create Memories.

Whether we are working on a cool new design, adding an innovative feature, or squeezing in that extra bit of value, all we're thinking about is providing you with the ultimate boating experience and creating memories that will last a lifetime.

---

Did you know that the Legend headquarters is in Whitefish, Ontario? We have knowledgeable representatives available to answer your questions and direct you to your nearest Dealer. Call our toll-free number, 1.800.461.4050 and start on the path to finding your new boat.



**Visit our website, chat  
live or find your dealer:**  
[legendboats.com](https://www.legendboats.com)





# Table of Contents



## X-SERIES

Page 12



## XTE-SERIES

Page 52



## XTR-SERIES

Page 22



## R-SERIES

Page 66



## F-SERIES

Page 36



## R-SERIES

ULTRALITE, WIDEBODY

Page 74

### General Content:

All-In Pricing .....	08
The Legend Difference (FAQs).....	09
The Legend Showroom .....	10
Construction .....	80
Trailers and Accessories.....	82

Find Your Dealer .....	96
Choose Your Power .....	97
WOWranty .....	98
The Legend Time Capsule .....	99

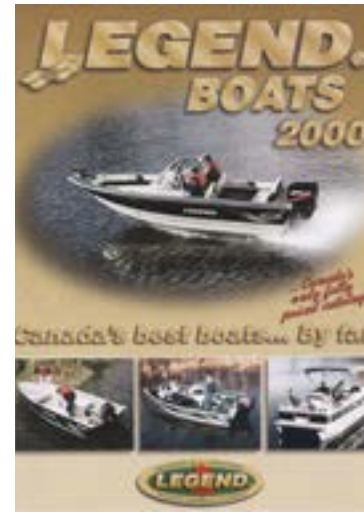
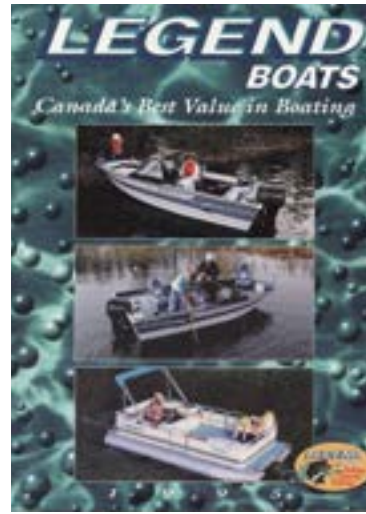
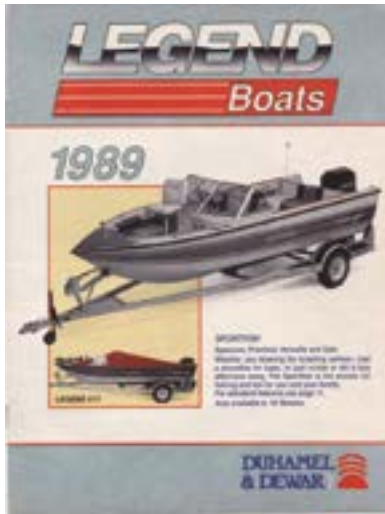

## Are You All-In? CANADA'S ONLY FULLY-PRICED CATALOGUE, SINCE '87.



In a world where we are bombarded with fees, surcharges and extras, wouldn't it be nice if a company would just tell us what it's going to cost up front? Legend Boats is that company. Our prices are All-In!

That's right! No administration fees. No hidden freight fees. No rigging fees. Since 1987, our customers have enjoyed having full package pricing at their fingertips so

they could figure out what their perfect boat or pontoon boat was going to cost right down to the penny. Now, there's no more figuring out. With one simple up-front price, you choose your motor and any options you want, then simply add the taxes. We would have gotten rid of those too but we thought it may have been frowned upon. It really couldn't get any more simple, open, honest or transparent, and we feel that you will appreciate our All-In Pricing.

\*We only print one version of our catalogue for all of Canada. Customers outside of Ontario and Quebec will have a small fee for freight. For details, visit us at [legendboats.com](http://legendboats.com) for your local, ALL-IN, No-Fee Price including current promotions.



# We do things a little differently.

## Is Legend Canadian?

Yes. We are a Canadian company. We live and play where you do. We understand boating in the unique Canadian wilderness. It's different here, and that's why each and every model is designed by Canadians and built for Canadians. From thicker aluminum to full stand-up tops, we make sure that Mother Nature is no match for your Legend.

## Are Legend boats built in Canada?

Yes and No. Our product developers seek out quality manufacturers throughout North America who can produce in the most cost effective way. By outsourcing component manufacturing and then performing all final assembly, sales, service, and warranty right here in Canada, we ensure that the end product is fit for the Great Canadian outdoors.

## Are the printed catalogue prices MSRP?

No. The printed price is our hassle-free, lowest price. We provide it up front, so there's no need for uncomfortable negotiations. To top it off, aside from a small variance in freight, our low prices are the same across Canada. Now you can make an informed, easy, and no-pressure decision in the comfort of your own home.

## It seems like everyone's warranty is pretty much the same. Is that the case?

Well, at first glance it appears that most companies are offering some sort of lifetime warranty, and it's easy to assume that all warranties are the same, but the devil is in the details. By details, we're talking about the fine print. Our 6 year WOWranty combined with our Lifetime hull warranties give you the absolute best warranty coverage, bar none. Not only do we cover more stuff for longer, but the best part is that everything is taken care of right here in Canada.

## Someone told me Legend boats are underpowered. Is that true?

No. You can actually power your boat with the engine of your choice. Each Legend boat model is designed and packaged with a Mercury motor large enough to get you and a friend on the water to experience the boating lifestyle with minimal investment. We understand that everyone's boating needs are different, and that the packaged motor may not suit your needs. That's why we make it easy to choose the perfect Mercury outboard to power all of your on-water activities. So, whether you want to troll all day, bring the kids tubing, cruise with your family or pull two water skiers, we'll help you select the engine that's just right.

## Why do you only package your boats with Mercury outboards?

We partner exclusively with Mercury because of their proven quality, value, reliability, service and features. With the large number of clients we help onto the water each year in Canada, other outboard manufacturers would love us to package with their brand. Mercury appreciates our business so much, they offer us exclusive savings that we simply pass on to you. That's how we package with the oldest, largest, number one outboard engine brand at such an incredible price. On top of a great price, by purchasing a complete custom package you'll enjoy consistent performance and one-location servicing.

## We give you the most standard equipment.

We've outfitted our boats with more equipment for less. Things that you would have to pay thousands of dollars extra for with other brands are simply part of our value-packed models. Many of our Legend packages have standard features like Dura-deck vinyl floors, automatic bilge pumps, and a bunch of other great stuff that is optional in other brands. When it comes to value, we're proud to say that nobody compares. We have more equipment for less than any other brand!

## You claim your quality is good but your prices are affordable. How is that possible?

You get what you pay for right? Well in most cases, yes. But at Legend, we never sacrifice quality in order to reduce cost. Our use of quality brand name products in our packages such as Shoreland'r trailers, Minn Kota and Garmin trolling motors and Mercury outboards - the largest brands in boating - speak for themselves. To keep prices low, we build fewer models in higher volumes and package each model with the same popular features. By purchasing thousands of each component, such as full stand-up tops, fish finders and GPS', we can offer you unbelievably high quality at affordable prices. That's how we do it.

## Why doesn't everyone put pricing in their catalogues?

That's a great question. We don't know. It could be because it takes a lot more work and effort to include all of the details required when you're sharing a price. Or, perhaps nobody else does it because they have something to hide. But we're only guessing. All we know is that we're so confident that we offer the absolute best value in Canada that we publish our complete, hassle-free, all-In pricing for all to see. You can find our prices in our full line brochure, on our extensive website and in all of our advertisements. We even print the pricing of our most popular options so you can "build" your own Legend. Nothing is hidden and it's all in Canadian dollars. We've done the work for you and given you our lowest price right up front.



# The Legend Showroom Canada's Best Boats

Showroom Key	Boat Model
\$	weekly payment
\$	full price

X-SERIES



XTR-SERIES



F-SERIES



\* We only print one version of our catalogue for all of Canada. Customers outside of Ontario and Quebec will have a small fee for freight. For details, visit us at [legendboats.com](http://legendboats.com) for your local, ALL-IN, No-Fee Price including current promotions.



**XTE-SERIES**

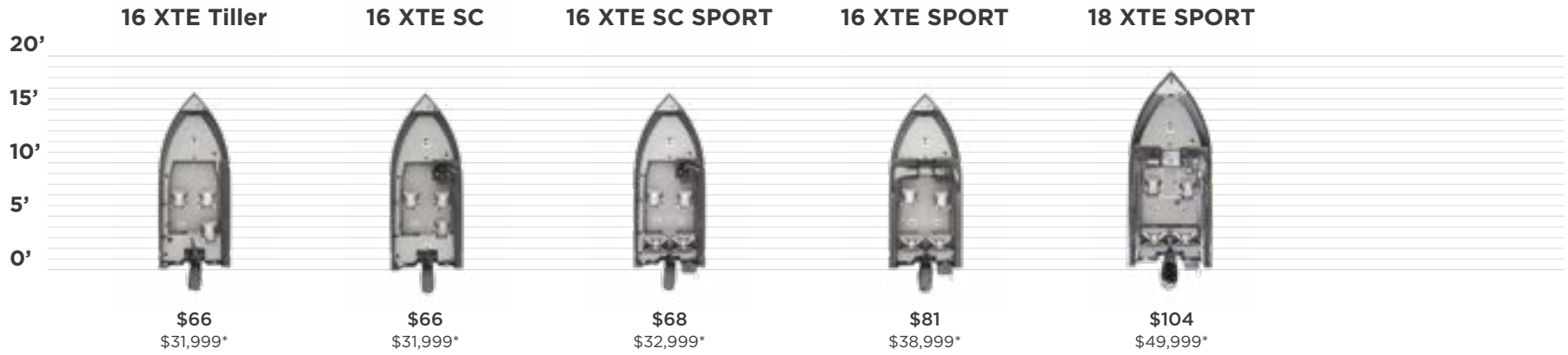

**R-SERIES**



**R-SERIES**



\*Licenses and taxes are extra on all prices. Delivery is available at an additional cost. Payments are calculated with licenses, bank registration charges, and taxes as your downpayments at 8.99% over 1,040 weeks for amounts \$23,000 and higher, 9.99% over 780 weeks for amounts between \$10,000 and \$22,999 and 9.99% over 364 weeks for amount lower than \$10,000 (at time of printing). All financing is OAC. Payments will vary by province. Premium Packages are model specific and are only available with the purchase of a boat package. Prices, rates and specifications are subject to change or error. Pictures may show options. Ask for complete details.

# X-SERIES

X16 | X18 | X20

Enjoy your family time on the water however you like to spend it.

Fish, ski, cruise, relax, get in touch with nature, reconnect with your loved ones or take time for yourself. Whatever you want to do, you can do it with the X-Series.



---

**LENGTH:**

16' - 20'

**HORSEPOWER:**

60HP - 175HP

**HULL WEIGHT:**

1045-1500 lbs



# X-SERIES



# Key Series Features



**1** Bow Rider Seating and Storage

**3** All-Weather Full Stand-Up Top

**2** Aluminum Ski Pole

**4** Passenger Console with CoolBox™

 **The Iconic Legend**  
EXTENDA-DECK  
CONVERTA-BENCH™



The Extenda-Deck Converta-Bench™ allows you to sit 3 extra people, waterski with the removable ski pylon, or sit 2 fishing chairs for the ultimate aft casting deck.





**LEGEND**

16

## X-SERIES

### X16



Dual safe lockable side storage for your rods and gear.



Full Stand-Up All-Weather Top. Included



Huge casting deck includes an oversized aerated livewell, bait bucket, and extra storage.



CoolBox™ keeps up to 12 drinks cold at a time.



Solid aluminum removable ski pole.



Gauges, Bluetooth stereo, switches, and RAM-mounted GPS fish finder.

## Always Included

### CONSTRUCTION

- 10° deep-v hull with hard chines • .100 gauge super-thick two-piece alum. Hull construction • Treated 7-ply marine-grade plywood floor and decks • Torsion beam energy transfer system • Stainless steel transom and bow eyes • Rear safety splash pan • Multiple .100 gauge bow ribs for maximum strength • Large and practical slip-resistant side decks • Injected and level foam floatation • Cast aluminum corner caps • All-welded hull construction • 3M highly reflective safety striping on Legend name • High-gloss oven-cured urethane exterior paint

### CONSOLE

- Speedometer, voltmeter, fuel gauge, tachometer • High profile clear-curved walk-through windshield • Deluxe passenger console with integrated CoolBox™ • Deluxe command-vu console with integrated drink holder • Illuminated switches and gauges • Horn • Ez reset circuit breakers

### LIVEWELLS

- Threaded sure-lock stand pipe with overflow protection • Integrated bait bucket

### SEATING

- 2 removable ErgoMax™ swivel chairs • EZ-Fold Extenda-Deck Converta-Bench™

### DECKS AND STORAGE

- 7' port and starboard integral lockable rod boxes • Rear battery storage area • Perko T-Handle flush locks • Large rear casting deck with seat mount and storage • Large front casting deck with oversized storage

### ADDITIONAL

- 42 L built-in under-floor fuel tank • Pre-wired for electric trolling motor • Removable navigation and anchor lights • Automatic bilge pump • Ez-clean dura-deck vinyl floor and marine carpet



# Great things come to those who board the X-Series.



## EZ-FLIP 50/50 SPLIT CONVERTA BENCH



The EZ-Flip 50/50 Split Extenda-Deck Converta-Bench allows you to sit 3 extra people, waterski with the removable ski pole, or sit 2 fishing chairs for the ultimate aft casting deck.

## SPECIFICATIONS

Length	<b>16'6"</b>	Hull Weight (lbs)	<b>1045</b>
Beam	<b>82"</b>	Bottom Width	<b>69"</b>
Hull Depth	<b>37"</b>	Package Length	<b>18'4"</b>
Inside Depth	<b>25"</b>	Package Width	<b>82"</b>
Aluminum Thickness	<b>0.100</b>	Towing Weight (lbs)	<b>2190</b>
Maximum Horsepower	<b>90</b>	Gas Tank	<b>42 L (11 US gal)</b>
Maximum Capacity (lbs)	<b>1393</b>		

## X16

**\$96** Per Week

**\$46,499\***

ALL-IN PRICE  
NO EXTRA FEES\*



Build me!

With Mercury 60 ELPT 4S and Glide-On Trailer

### Choose Your Power

Fish/Cruise  Tube  Ski

MERCURY 60 ELPT 4S	INCLUDED	+ \$0
MERCURY 60 ELPT 4S CT	MOST POPULAR	+ \$599
MERCURY 75 ELPT 4S		+ \$3,099
MERCURY 90 ELPT 4S		+ \$3,799

MPH 20 25 30 35 40 45 50 55

### Preferred Equipment Package

	VALUE:
<input checked="" type="checkbox"/> FULL STAND-UP ALL-WEATHER TOP	\$2,399
<input checked="" type="checkbox"/> BOW CUSHIONS WITH CONTOURED BACKRESTS	\$1,599
<input checked="" type="checkbox"/> RAM MOUNTED 5" GPS FISH/DEPTH FINDER	\$799
<input checked="" type="checkbox"/> REMOVABLE SOLID BRUSHED ALUMINUM SKI POLE	\$599
<input checked="" type="checkbox"/> LEGEND QUICK LATCH TIE DOWNS	\$59
<input checked="" type="checkbox"/> 12 VOLT POWER OUTLET	\$139
<input checked="" type="checkbox"/> TILT STEERING	\$599
<input checked="" type="checkbox"/> BIG WHEEL BACKSAVER JACK AND DOLLY	\$119
<input checked="" type="checkbox"/> SWIM PLATFORM WITH FOLD DOWN STEP(S)	\$399
<input checked="" type="checkbox"/> DRIVER'S SEAT SLIDER	\$299
<input checked="" type="checkbox"/> EZ-LOAD TRAILER GUIDES	\$299
<input checked="" type="checkbox"/> SPACE-SAVING TRAILER SWING TONGUE	\$499
<input checked="" type="checkbox"/> INTERIOR LED AMBIENT LIGHTING	\$699
<input checked="" type="checkbox"/> BLUETOOTH AM/FM STEREO WITH MP3 PORT AND 2 SPEAKERS	\$799

Total Value: \$9,306. You Pay: \$0.

The Legend Advantage: It's all included in your X16 Package.

WE'VE GOT YOU COVERED

<b>.100 Gauge</b> Perfect-Flex Aluminum	<b>All-Welded</b> Aluminum Hull	<b>Leakproof + 6 Year</b> For Life Warranty	<b>6YR</b> WOWranty
--	------------------------------------	--	------------------------

# X-SERIES X18



## Always Included

### CONSTRUCTION

- High-gloss oven-cured urethane exterior paint•3m highly reflective safety striping on Legend name
- All-welded hull construction•Cast aluminum corner caps•Injected and level foam floatation•Large and practical slip-resistant side decks•Multiple .100 gauge bow ribs for maximum strength•Rear safety splash pan•Stainless steel transom and bow eyes•Torsion beam energy transfer system
- Treated 7-ply marine-grade plywood floor and decks•.100 gauge super-thick two-piece alum. Hull construction•17° deep-v hull w/ hard chines•5 chrome mooring cleats

### CONSOLE

- Ez reset circuit breakers•Horn•Illuminated switches and gauges•Deluxe command-vu console w/ integrated drink holder•Deluxe passenger console w/ integrated cool box•High profile clear-curved walk-through windshield•Speedometer, voltmeter, fuel gauge, tachometer

### LIVEWELLS

- Threaded sure-lock stand pipe w/ overflow protection•Bow livewell - aerated - 72 L•Stern livewell - aerated - 45 L



Keep 6 rods out of the way with lockable in-floor rod storage.



Full Stand-Up All-Weather Top. **Included**



Remove the bow cushions to reveal an aerated 72 L livewell and tons of storage.



CoolBox™ keeps up to 12 drinks cold at a time.



Solid aluminum removable ski pole.



Gauges, Bluetooth stereo, switches, and RAM-mounted GPS fish finder.

### SEATING

- 4 seat configurations•Removable ergomax swivel chairs - 2•Ez-fold extend-a-deck convert-a-bench

### DECKS AND STORAGE

- In-floor rod locker•Large front casting deck w/ oversized storage•Large rear casting deck w/ seat mount and storage•Perko t-handle flush locks•Rear battery storage area•Drink holders - 6
- Lockable in-floor rod locker w/ tube holders for 6 rods•Port and starboard integral lockable rod boxes - 7'

### ADDITIONAL

- Automatic bilge pump•Removable navigation and anchor lights•Pre-wired for electric trolling motor
- Removable solid brushed alum. ski pole•Built-in fuel tank - 95 L•Ez-clean dura-deck vinyl floor and marine carpet

# Great things come to those who board the X-Series.



## EZ-FLIP EXTENDA-DECK CONVERTA BENCH



The Extenda-Deck Converta-Bench allows you to sit 3 extra people, waterski with the removable ski pole, or sit 2 fishing chairs for the ultimate aft casting deck.

## SPECIFICATIONS

Length	17'6"	Hull Weight (lbs)	1345
Beam	90"	Bottom Width	76"
Hull Depth	41"	Package Length	19'9"
Inside Depth	26"	Package Width	92"
Aluminum Thickness	0.100	Towing Weight (lbs)	2553
Maximum Horsepower	150	Gas Tank	95 L (25 US gal)
Maximum Capacity (lbs)	1744		

X18

**\$116** Per Week

**\$55,999\***

ALL-IN PRICE  
NO EXTRA FEES\*



Build me!

With Mercury 90 ELPT 4S and Glide-On Trailer

## Choose Your Power

Fish/Cruise  Tube  Ski

MERCURY 90 ELPT 4S	INCLUDED	+ \$0
MERCURY 90 ELPT 4S CT		+ \$599
MERCURY 115 ELPT 4S		+ \$2,599
MERCURY 115 ELPT PRO XS CT	MOST POPULAR	+ \$3,699

MPH: 20 25 30 35 40 45 50 55

## Preferred Equipment Package

	VALUE:
<input checked="" type="checkbox"/> FULL STAND-UP ALL-WEATHER TOP	\$2,399
<input checked="" type="checkbox"/> BOW CUSHIONS WITH CONTOURED BACKRESTS	\$1,599
<input checked="" type="checkbox"/> RAM MOUNTED 5" GPS FISH/DEPTH FINDER	\$799
<input checked="" type="checkbox"/> BLUETOOTH AM/FM STEREO WITH MP3 PORT AND 2 SPEAKERS	\$799
<input checked="" type="checkbox"/> INTERIOR LED AMBIENT LIGHTING	\$699
<input checked="" type="checkbox"/> REMOVABLE SOLID BRUSHED ALUMINUM SKI POLE	\$599
<input checked="" type="checkbox"/> TILT STEERING	\$599
<input checked="" type="checkbox"/> SPACE-SAVING TRAILER SWING TONGUE	\$499
<input checked="" type="checkbox"/> SWIM PLATFORM WITH FOLD DOWN STEP(S)	\$399
<input checked="" type="checkbox"/> DRIVER'S SEAT SLIDER	\$299
<input checked="" type="checkbox"/> EZ-LOAD TRAILER GUIDES	\$299
<input checked="" type="checkbox"/> 12 VOLT POWER OUTLET	\$139
<input checked="" type="checkbox"/> BIG WHEEL BACKSAVER JACK AND DOLLY	\$119
<input checked="" type="checkbox"/> TOWBETTER AUTO RETRACTABLE TIE DOWNS	\$95

Total Value: \$9,342. You Pay: \$0.

The Legend Advantage: It's all included in your X18 Package.

WE'VE GOT YOU COVERED

<b>.100 Gauge</b> Perfect-Flex Aluminum	<b>All-Welded</b> Aluminum Hull	<b>Leakproof + 6 Year</b> For Life Warranty
		<b>WOWranty</b>



# X-SERIES X20



## Always Included

### CONSTRUCTION

- High-gloss oven-cured urethane exterior paint•3m highly reflective safety striping on Legend name
- All-welded hull construction•Cast aluminum corner caps•Injected and level foam floatation•Large and practical slip-resistant side decks•Stainless steel transom and bow eyes•.100 gauge super-thick two-piece alum. Hull construction•Multiple .100 gauge bow ribs for maximum strength•Rear safety splash pan•Torsion beam energy transfer system•Treated 7-ply marine-grade plywood floor and decks•17° deep-v hull w/ hard chines•4 deck mounted mooring cleats

### CONSOLE

- Horn•Ez reset circuit breakers•Illuminated switches and gauges•Deluxe command-vu console w/ integrated drink holder•Deluxe passenger console w/ integrated cool box•High profile clear-curved walk-through windshield•Speedometer, voltmeter, fuel gauge, tachometer

### LIVEWELLS

- Bow livewell - aerated - 57 L•Stern livewell - aerated - 57 L•Threaded sure-lock stand pipe w/ overflow protection



Keep 6 rods out of the way with lockable in-floor rod storage.



Full Stand-Up All-Weather Top. Included



Bow rider seating and storage.



CoolBox™ keeps up to 12 drinks cold at a time.



Solid aluminum removable ski pole.



Gauges, Bluetooth stereo, switches, and RAM-mounted GPS fish finder.

### SEATING

- 4 seat configurations•Removable ergomax swivel chairs - 2•Legend ez-flip extenda-deck converta-bench

### DECKS AND STORAGE

- Large front casting deck w/ oversized storage•Large rear casting deck w/ seat mount and storage
- Perko t-handle flush locks•Rear battery storage area•Lockable in-floor rod locker w/ tube holders for 6 rods•Drink holders - 7•Port and starboard integral lockable rod boxes - 9'

### ADDITIONAL

- Automatic bilge pump•Ez-clean dura-deck vinyl floor and marine carpet•Removable navigation and anchor lights•Built-in under-floor fuel tank - 132 L•Pre-wired for electric trolling motor

# Great things come to those who board the X-Series.



## EZ-FLIP EXTENDA-DECK CONVERTA BENCH



The Extenda-Deck Converta-Bench allows you to sit 3 extra people, waterski with the removable ski pole, or sit 2 fishing chairs for the ultimate aft casting deck.

## SPECIFICATIONS

Length	<b>19'6"</b>	Hull Weight (lbs)	<b>1604</b>
Beam	<b>97"</b>	Bottom Width	<b>76"</b>
Hull Depth	<b>45"</b>	Package Length	<b>21'1"</b>
Inside Depth	<b>31"</b>	Package Width	<b>100"</b>
Aluminum Thickness	<b>0.100</b>	Towing Weight (lbs)	<b>2980</b>
Maximum Horsepower	<b>175</b>	Gas Tank	<b>35 US gal / 132 L</b>
Maximum Capacity (lbs)	<b>1949</b>		

## X20

**\$145** Per Week

**\$69,999\***

ALL-IN PRICE  
NO EXTRA FEES\*



Build me!

With Mercury 115 EXLPT 4S and Glide-On Trailer

### Choose Your Power

Fish/Cruise  Tube  Ski

MERCURY 115 EXLPT 4S	INCLUDED	+ \$0
MERCURY 115 EXLPT PRO XS CT		+ \$1,099
MERCURY 150 XL 4S	<b>MOST POPULAR</b>	+ \$6,499
MERCURY 150 XL PRO XS 4S**		+ \$13,599

MPH 20 25 30 35 40 45 50 55

\*\* With Hydraulic Steering and Stainless Steel Propeller

### Preferred Equipment Package

	VALUE:
<input checked="" type="checkbox"/> FULL STAND-UP ALL-WEATHER TOP	\$2,399
<input checked="" type="checkbox"/> BOW CUSHIONS WITH CONTOURED BACKRESTS	\$1,599
<input checked="" type="checkbox"/> DELUXE RECLINING ERGOMAX™ CAPTAIN'S CHAIR WITH HEADREST	\$1,599
<input checked="" type="checkbox"/> RAM MOUNTED 5" GPS FISH/DEPTH FINDER	\$799
<input checked="" type="checkbox"/> BLUETOOTH AM/FM STEREO WITH MP3 PORT AND 2 SPEAKERS	\$799
<input checked="" type="checkbox"/> INTERIOR LED AMBIENT LIGHTING	\$699
<input checked="" type="checkbox"/> REMOVABLE SOLID BRUSHED ALUMINUM SKI POLE	\$599
<input checked="" type="checkbox"/> TILT STEERING	\$599
<input checked="" type="checkbox"/> SPACE-SAVING TRAILER SWING TONGUE	\$499
<input checked="" type="checkbox"/> SWIM PLATFORM WITH FOLD DOWN STEP(S)	\$399
<input checked="" type="checkbox"/> EZ-LOAD TRAILER GUIDES	\$299
<input checked="" type="checkbox"/> DRIVER'S SEAT SLIDER	\$299
<input checked="" type="checkbox"/> 12 VOLT POWER OUTLET	\$139
<input checked="" type="checkbox"/> BIG WHEEL BACKSAVER JACK AND DOLLY	\$119
<input checked="" type="checkbox"/> TOWBETTER AUTO RETRACTABLE TIE DOWNS	\$95

Total Value: \$10,941. You Pay: \$0.

The Legend Advantage: It's all included in your X20 Package.

WE'VE GOT YOU COVERED

**.100 Gauge**  
Perfect-Flex Aluminum

**All-Welded**  
Aluminum Hull

**Leakproof + 6 Year**  
For Life Warranty  
WOWranty

# XTR-SERIES

## The water won't know what hit it.

Huge casting decks, massive livewells, all vinyl floors and enough room for your friends, family and all their gear! If you routinely hit the water for some fish, but you've got a whole family to keep comfortable too, this is the boat for you! The only tough decision you'll have to make is which lake to hit first.

16 XTR | 16 XTR SC Sport  
18 XTR | 18 XTR Troller  
20 XTR Troller



---

### LENGTH:

16' - 20'

### HORSEPOWER:

40HP - 175HP

### HULL WEIGHT:

865-1530 lbs





# XTR-SERIES



# Key Series Features



**The Iconic Legend**  
EZ-FOLD / EZ-FLIP 50/50  
EXTENDA-DECK  
CONVERTA-BENCH



**One series, two styles.**



Choose All-purpose  
Family Fishing or Deep  
Water Trolling.

**1** All Vinyl Flooring

---

**3** Swim Platform

---

**2** In-Dash Helix 5

---

**4** Interior LED Lighting

---





MERCURY  
**PRO XS**

**LEGEND**

**XTR 18**

In the business of  
Creating Moments.



## XTR-SERIES

# 16 XTR SC SPORT



Integrated swim platform makes it easy to jump in and out of the water.



Enjoy a tournament-sized livewell with separate bait bucket.



Safe lockable side storage for rods and gear.



Fully illuminated console gauges and switches.



GPS Fish and Depth Finder.



Room for the whole gang.

## Always Included

### CONSTRUCTION

• Intelliflex™ hull construction • Torsion beam energy transfer system • 3M highly reflective safety striping on Legend name • Large and practical slip-resistant side decks • Treated 7-ply marine-grade plywood floor and decks • Stainless steel transom and bow eyes • Injected and level foam flotation • 10° deep-v hull with reverse chines • .100 gauge super-thick two-piece alum. Hull construction

### CONSOLE

• Horn • Ez-reset circuit breakers, switches and gauges • Chrome-bezeled multi-function tachometer with fuel gauge • Navigator console with built-in 5" GPS fishfinder

### LIVEWELLS

• Threaded sure-lock stand pipe with overflow protection • Integrated bait bucket • 114 L aerated bow livewell

### SEATING

• EZ-Fold Extenda-Deck Converta-Bench™ • 2 removable ErgoMax™ swivel chairs • 4 on the floor seat base configuration

### DECKS AND STORAGE

• 5 drink holders • Rear battery storage area • Perko T-Handle flush locks • 7' port and starboard integral lockable rod boxes • Large rear casting deck with seat mount and storage • Large front casting deck with oversized storage

### ADDITIONAL

• EZ-clean dura-deck vinyl floor • Automatic bilge pump • 42 L built-in under-floor fuel tank • Pre-wired for 12v electric trolling motor • Removable navigation and anchor lights • 6 mooring cleats or handles

# XTRemely awesome.

## 16 XTR SC SPORT

**\$79** Per Week

**\$37,999\***

**ALL-IN PRICE**  
NO EXTRA FEES\*



Build me!

With Mercury 40 ELPT 4S and Glide-On Trailer

### Choose Your Power

Fish/Cruise  Tube  Ski

Power	Package	Price
MERCURY 40 ELPT 4S	INCLUDED	+\$0
MERCURY 60 ELPT 4S CT	MOST POPULAR	+\$3,799
MERCURY 75 ELPT 4S		+\$6,299
MERCURY 90 ELPT 4S		+\$6,999

MPH 20 25 30 35 40 45 50 55

### Preferred Equipment Package

Equipment	VALUE:
<input checked="" type="checkbox"/> BLUETOOTH AM/FM STEREO WITH MP3 PORT AND 2 SPEAKERS	\$799
<input checked="" type="checkbox"/> IN-DASH HUMMINBIRD HELIX 5 GPS FISH/DEPTH FINDER	\$749
<input checked="" type="checkbox"/> INTERIOR LED AMBIENT LIGHTING	\$699
<input checked="" type="checkbox"/> TILT STEERING	\$599
<input checked="" type="checkbox"/> SPACE-SAVING TRAILER SWING TONGUE	\$499
<input checked="" type="checkbox"/> SWIM PLATFORM WITH FOLD DOWN STEP(S)	\$399
<input checked="" type="checkbox"/> DRIVER'S SEAT SLIDER	\$299
<input checked="" type="checkbox"/> EZ-LOAD TRAILER GUIDES	\$299
<input checked="" type="checkbox"/> 12 VOLT POWER OUTLET	\$139
<input checked="" type="checkbox"/> BIG WHEEL BACKSAVER JACK AND DOLLY	\$119
<input checked="" type="checkbox"/> LEGEND QUICK LATCH TIE DOWNS	\$59

Total Value: \$4,659. You Pay: \$0.



### The Legend Advantage:

It's all included in your 16 XTR SC Sport Package.



### EZ-FLIP 50/50 SPLIT CONVERTA BENCH



The EZ-Flip 50/50 Split Extenda-Deck Converta-Bench provides ample seating. It flips easily in seconds into a large rear casting deck for optimal space.

### SPECIFICATIONS

Length	<b>16'6"</b>	Hull Weight (lbs)	<b>995</b>
Beam	<b>82"</b>	Bottom Width	<b>69"</b>
Hull Depth	<b>37"</b>	Package Length	<b>18'4"</b>
Inside Depth	<b>25"</b>	Package Width	<b>82"</b>
Aluminum Thickness	<b>0.100</b>	Towing Weight (lbs)	<b>1890</b>
Maximum Horsepower	<b>90</b>	Gas Tank	<b>42 L (11 US gal)</b>
Maximum Capacity (lbs)	<b>1393</b>		

### WE'VE GOT YOU COVERED

**.100 Gauge**  
Perfect-Flex Aluminum

**All-Welded**  
Aluminum Hull

**Leakproof + 6 Year**  
For Life Warranty

**6YR**  
WOWranty

# XTR-SERIES 16 XTR



Bimini, full stand-up top and bow cover provide all-weather protection. **Included**



Add **optional** bow cushions for the ultimate crossover (#BC-16XTR).



Pre-wired for a 12v electric trolling motor.



Bow casting deck with tournament-sized livewell and hidden storage.















Bluetooth stereo, GPS fish/depth finder, and illuminated gauges and switches.



Lockable side storage.

## SPECIFICATIONS

 Length	<b>16'6"</b>	 Hull Weight (lbs)	<b>1045</b>
 Beam	<b>82"</b>	 Bottom Width	<b>69"</b>
 Hull Depth	<b>37"</b>	 Package Length	<b>18'4"</b>
 Inside Depth	<b>25"</b>	 Package Width	<b>82"</b>
 Aluminum Thickness	<b>0.100</b>	 Towing Weight (lbs)	<b>2190</b>
 Maximum Horsepower	<b>90</b>	 Gas Tank	<b>42 L (11 US gal)</b>
 Maximum Capacity (lbs)	<b>1393</b>		



## Always Included

### CONSTRUCTION

• Intelliflex™ hull construction • Torsion beam energy transfer system • 3M highly reflective safety striping on Legend name • Large and practical slip-resistant side decks • Treated 7-ply marine-grade plywood floor and decks • Stainless steel transom and bow eyes • Injected and level foam floatation • 10° deep-v hull with reverse chines • .100 gauge super-thick two-piece alum. Hull construction

### CONSOLE

• Horn • High profile clear-curved walk-through windshield • Ez-reset circuit breakers, switches and gauges • Chrome-bezeled multi-function tachometer with fuel gauge • Deluxe passenger console with extra-large glove box • Navigator console with built-in 5" GPS fishfinder

### LIVEWELLS

• Threaded sure-lock stand pipe with overflow protection • Integrated bait bucket • 114 L aerated bow livewell

### SEATING

• EZ-Fold Extenda-Deck Converta-Bench™ • 2 removable ErgoMax™ swivel chairs • 4 on the floor seat base configuration

### DECKS AND STORAGE

• 6 drink holders • Rear battery storage area • Perko T-Handle flush locks • 7' port and starboard integral lockable rod boxes • Large rear casting deck with dual seat mounts and storage • Large front casting deck with oversized storage

### ADDITIONAL

• EZ-clean dura-deck vinyl floor • Automatic bilge pump • 42 L built-in under-floor fuel tank • Pre-wired for 12v electric trolling motor • Removable navigation and anchor lights • 6 mooring cleats or handles





**ALL-IN PRICE**  
NO EXTRA FEES\*

## 16 XTR

**\$94** Per Week | **\$45,499\***



Build me!

With Mercury 60 ELPT 4S and Glide-On Trailer

### Choose Your Power

Fish/Cruise  Tube  Ski

Power Option	Included	Price
MERCURY 60 ELPT 4S	INCLUDED	+ \$0
MERCURY 60 ELPT 4S CT	MOST POPULAR	+ \$599
MERCURY 90 ELPT 4S		+ \$3,799

MPH: 20 25 30 35 40 45 50 55

### Preferred Equipment Package

Item	Value
<input checked="" type="checkbox"/> FULL STAND-UP ALL-WEATHER TOP	\$2,399
<input checked="" type="checkbox"/> BOW CONTOURED BACKRESTS	\$849
<input checked="" type="checkbox"/> BLUETOOTH AM/FM STEREO WITH MP3 PORT AND 2 SPEAKERS	\$799
<input checked="" type="checkbox"/> IN-DASH HUMMINBIRD HELIX 5 GPS FISH/DEPTH FINDER	\$749
<input checked="" type="checkbox"/> INTERIOR LED AMBIENT LIGHTING	\$699
<input checked="" type="checkbox"/> TILT STEERING	\$599
<input checked="" type="checkbox"/> SPACE-SAVING TRAILER SWING TONGUE	\$499
<input checked="" type="checkbox"/> SWIM PLATFORM WITH FOLD DOWN STEP(S)	\$399
<input checked="" type="checkbox"/> DRIVER'S SEAT SLIDER	\$299
<input checked="" type="checkbox"/> EZ-LOAD TRAILER GUIDES	\$299
<input checked="" type="checkbox"/> 12 VOLT POWER OUTLET	\$139
<input checked="" type="checkbox"/> BIG WHEEL BACKSAVER JACK AND DOLLY	\$119
<input checked="" type="checkbox"/> LEGEND QUICK LATCH TIE DOWNS	\$59

Total Value: \$7,907. You Pay: \$0.

**The Legend Advantage:** It's all included in your 16 XTR Package.



**ALL-IN PRICE**  
NO EXTRA FEES\*

## 16 XTR ULTIMATE

**\$110** Per Week | **\$52,999\***



Build me!

With Mercury 75 ELPT 4S and Glide-On Trailer

### Ultimate Power Upgrade Included

Fish/Cruise  Tube  Ski

Power Option	Included	Price
MERCURY 75 ELPT 4S	INCLUDED	+ \$0

MPH: 20 25 30 35 40 45 50 55

### The 16 XTR Ultimate Package which Includes:

Everything in the 16 XTR Preferred Equipment Package +

Item	Value
<input checked="" type="checkbox"/> MERCURY 75 ELPT 4-STROKE	\$3,099
<input checked="" type="checkbox"/> POWERDRIVE 55/DSC/MR WITH MK BRACKET AND 60A CIRCUIT BREAKER	\$2,069
<input checked="" type="checkbox"/> BOW TO STERN COVER	\$1,199
<input checked="" type="checkbox"/> HELIX 5 CHIRP GPS G3 WITH NAVIONICS+	\$479
<input checked="" type="checkbox"/> PRO SEAT KIT	\$299
<input checked="" type="checkbox"/> 1 DEEP CYCLE BATTERY - GROUP 27	\$259
<input checked="" type="checkbox"/> TRANSOM SAVER	\$159
<input checked="" type="checkbox"/> RAM MOUNT	\$107
<input checked="" type="checkbox"/> UPGRADE TO TOW BETTER AUTO RETRACTABLE TIE DOWNS	\$36
<input checked="" type="checkbox"/> INSTALLATION OF ALL ULTIMATE PACKAGE ITEMS IF PURCHASED SEPARATELY	\$999

Total value of Ultimate Package items **\$8,705**..... You Save **\$1,205!**

**WE'VE GOT YOU COVERED**

- .100 Gauge** Perfect-Flex Aluminum
- All-Welded** Aluminum Hull
- Leakproof + 6 Year** For Life Warranty
- 6YR** WOWranty

# XTR-SERIES 18 XTR



Bimini, full stand-up top and bow cover provide all-weather protection. **Included**



Add an **optional** removable solid brushed-aluminum ski pole (#30900430).



Bluetooth stereo, GPS fish/depth finder, and illuminated gauges and switches.



Add **optional** bow cushions for the ultimate crossover (#BC-18XTR).



Tournament-sized livewell with separate bait bucket.



Keep your fishing rods safe in this lockable side storage.

## SPECIFICATIONS

Length	<b>17'6"</b>	Hull Weight (lbs)	<b>1396</b>
Beam	<b>90"</b>	Bottom Width	<b>76"</b>
Hull Depth	<b>41"</b>	Package Length	<b>19'9"</b>
Inside Depth	<b>26"</b>	Package Width	<b>92"</b>
Aluminum Thickness	<b>0.100</b>	Towing Weight (lbs)	<b>2654</b>
Maximum Horsepower	<b>150</b>	Gas Tank	<b>95 L (25 US gal)</b>
Maximum Capacity (lbs)	<b>1744</b>		



## Always Included

### CONSTRUCTION

• Intelliflex™ hull construction • Torsion beam energy transfer system • 3M highly reflective safety striping on Legend name • Large and practical slip-resistant side decks • Treated 7-ply marine-grade plywood floor and decks • Stainless steel transom and bow eyes • Injected and level foam floatation • 17° deep-v hull with reverse chines • .100 gauge aluminum hull and bow rib construction

### CONSOLE

• Horn • High profile clear-curved walk-through windshield • Ez-reset circuit breakers, switches and gauges • Chrome-bezeled multi-function tachometer with fuel gauge • Deluxe passenger console with extra-large glove box • Navigator console with built-in 5" GPS fishfinder

### LIVEWELLS

• Threaded sure-lock stand pipe with overflow protection • Integrated bait bucket • 45 L aerated stern livewell • 114 L aerated bow livewell

### SEATING

• 2 removable ErgoMax™ swivel chairs • 4 on the floor seat base configuration • EZ-Fold Extenda-Deck Converta-Bench™

### DECKS AND STORAGE

• Lockable in-floor rod locker with tube holders for 6 rods • 6 drink holders • Rear battery storage area • Perko T-Handle flush locks and under rear seat storage • 7' port and starboard integral lockable rod boxes • Large rear casting deck with dual seat mounts and storage • Large front casting deck with oversized storage

### ADDITIONAL

• EZ-clean dura-deck vinyl floor • Automatic bilge pump • 95 L built-in under-floor fuel tank • Pre-wired for 12/24v electric trolling motor • Removable navigation and anchor lights • 6 mooring cleats or handles



**ALL-IN PRICE**  
NO EXTRA FEES\*

## 18 XTR

**\$114** Per Week | **\$54,999\***



Build me!

With Mercury 90 ELPT 4S and Glide-On Trailer

### Choose Your Power

Fish/Cruise  Tube  Ski

Power Option	Status	Price
MERCURY 90 ELPT 4S	INCLUDED	+ \$0
MERCURY 115 ELPT 4S	MOST POPULAR	+ \$2,599
MERCURY 115 ELPT PRO XS CT		+ \$3,699

MPH: 20 25 30 35 40 45 50 55

### Preferred Equipment Package

Item	VALUE:
<input checked="" type="checkbox"/> FULL STAND-UP ALL-WEATHER TOP	\$2,399
<input checked="" type="checkbox"/> BOW CONTOURED BACKRESTS	\$849
<input checked="" type="checkbox"/> BLUETOOTH AM/FM STEREO WITH MP3 PORT AND 2 SPEAKERS	\$799
<input checked="" type="checkbox"/> IN-DASH HUMMINBIRD HELIX 5 GPS FISH/DEPTH FINDER	\$749
<input checked="" type="checkbox"/> INTERIOR LED AMBIENT LIGHTING	\$699
<input checked="" type="checkbox"/> TILT STEERING	\$599
<input checked="" type="checkbox"/> SPACE-SAVING TRAILER SWING TONGUE	\$499
<input checked="" type="checkbox"/> SWIM PLATFORM WITH FOLD DOWN STEP(S)	\$399
<input checked="" type="checkbox"/> DRIVER'S SEAT SLIDER	\$299
<input checked="" type="checkbox"/> EZ-LOAD TRAILER GUIDES	\$299
<input checked="" type="checkbox"/> 12 VOLT POWER OUTLET	\$139
<input checked="" type="checkbox"/> BIG WHEEL BACKSAVER JACK AND DOLLY	\$119
<input checked="" type="checkbox"/> LEGEND QUICK LATCH TIE DOWNS	\$59

Total Value: \$7,907. You Pay: \$0.

**The Legend Advantage: It's all included in your 18 XTR Package.**



**ALL-IN PRICE**  
NO EXTRA FEES\*

## 18 XTR ULTIMATE

**\$133** Per Week | **\$63,999\***



Build me!

With Mercury 115 ELPT Pro XS CT and Glide-On Trailer

### Ultimate Power Upgrade Included

Fish/Cruise  Tube  Ski

Power Option	Status	Price
MERCURY 115 ELPT PRO XS CT	INCLUDED	+ \$0

MPH: 20 25 30 35 40 45 50 55

### The 18 XTR Ultimate Package which Includes:

Everything in the 18 XTR Preferred Equipment Package +

Item	VALUE:
<input checked="" type="checkbox"/> MERCURY 115 ELPT PRO XS CT 4-STROKE	\$3,699
<input checked="" type="checkbox"/> TERROVA 80/US2/IP_BT WITH MK BRACKET AND X2 60A CIRCUIT BREAKERS	\$3,049
<input checked="" type="checkbox"/> BOW TO STERN COVER	\$1,299
<input checked="" type="checkbox"/> HELIX 7 CHIRP GPS G4N WITH NAVIONICS+	\$1,049
<input checked="" type="checkbox"/> 2 DEEP CYCLE BATTERIES - GROUP 27	\$518
<input checked="" type="checkbox"/> PRO SEAT KIT	\$299
<input checked="" type="checkbox"/> MK-210D AC DUAL BANK CHARGER	\$259
<input checked="" type="checkbox"/> TRANSOM SAVER	\$159
<input checked="" type="checkbox"/> RAM MOUNT	\$107
<input checked="" type="checkbox"/> UNIVERSAL SONAR ADAPTER FOR HUMMINBIRD	\$49
<input checked="" type="checkbox"/> UPGRADE TO TOW BETTER AUTO RETRACTABLE TIE DOWNS	\$36
<input checked="" type="checkbox"/> MKR-21 AC POWER PORT (BLACK)	\$24
<input checked="" type="checkbox"/> INSTALLATION OF ALL ULTIMATE PACKAGE ITEMS IF PURCHASED SEPARATELY	\$1,490

Total value of Ultimate Package items **\$12,037.....You Save \$3,037!**

**WE'VE GOT YOU COVERED**

<b>.100</b> Perfect-Flex Aluminum	<b>All-Welded</b> Aluminum Hull	<b>Leakproof + 6 Year</b> For Life Warranty WOWranty	<b>6YR</b>
--------------------------------------	------------------------------------	--	------------



# XTR-SERIES

## 18 XTR TROLLER



Rear fishing area features rod holders, plenty of storage for your gear, and space for two optional downriggers.



Add **optional** bow cushions for the ultimate crossover. (#BC-18XTR)



Keep 6 rods out of the way with lockable in-floor rod storage.



Bluetooth stereo, GPS fish/depth finder, and illuminated gauges and switches.



Enjoy a massive tournament sized livewell and all-vinyl floors.



Bimini, full stand-up top and bow cover provide all-weather protection. **Included**

### Always Included

#### CONSTRUCTION

- .100 gauge super-thick two-piece alum. Hull construction • 5 chrome mooring cleats • 17° deep-v hull with reverse chines • Solid locking extrusions • Intelliflex™ hull construction • Lap-straked sidewalls • Internal lateral support ribs spaced 9" apart • Interlocking bow ribs • 7 layer, individually treated plywood floor • Injected level floatation • Torsion beam hull construction • H34 PerfectFlex™ aluminum • 2-piece hull with no side seams

#### CONSOLE

- Illuminated switches and gauges • Speedometer • Voltmeter • High profile clear-curved walk-through windshield • Horn • Ez reset circuit breakers • Chrome-bezeled multi-function tachometer with fuel gauge • Deluxe passenger console with extra-large glove box • Navigator console with built-in 5" GPS fishfinder

#### LIVEWELLS

- Threaded sure-lock stand pipe with overflow protection • Integrated bait bucket • 114 L aerated bow livewell

#### SEATING

- 4 on the floor seat base configuration • 2 removable ErgoMax™ swivel chairs

#### DECKS AND STORAGE

- Lockable in-floor rod locker with tube holders for 6 rods • Rear battery storage area • 7' port and starboard integral lockable rod boxes • Perko T-Handle flush locks • Large front casting deck with oversized storage

#### ADDITIONAL

- Removable navigation and anchor lights • Pre-wired for 12/24v electric trolling motor • EZ-clean dura-deck vinyl floor • 95 L built-in under-floor fuel tank • Automatic bilge pump

# Built for a fun-filled big water adventure.



## BUILT FOR BIG WATER ADVENTURE



Rear fishing area features rod holders and ample storage for all of your gear. (Shown with optional downriggers)



Remove the rear jump seats for a comfortable walk-in downrigging area.

## SPECIFICATIONS

Length	17'6"	Hull Weight (lbs)	1345
Beam	90"	Bottom Width	76"
Hull Depth	41"	Package Length	19'9"
Inside Depth	26"	Package Width	92"
Aluminum Thickness	0.100	Towing Weight (lbs)	2553
Maximum Horsepower	150	Gas Tank	95 L (25 US gal)
Maximum Capacity (lbs)	1744		

## 18 XTR TROLLER

**\$116** Per Week

**\$55,999\***

ALL-IN PRICE  
NO EXTRA FEES



Build me!

With Mercury 90 EXLPT 4S and Glide-On Trailer

### Choose Your Power

Fish/Cruise  Tube  Ski

MERCURY 90 EXLPT 4S	INCLUDED	+ \$0
MERCURY 90 EXLPT 4S CT		+ \$599
MERCURY 115 EXLPT 4S		+ \$2,599
MERCURY 115 EXLPT PRO XS CT	<b>MOST POPULAR</b>	+ \$3,699

MPH: 20 25 30 35 40 45 50 55

### Preferred Equipment Package

	VALUE:
<input checked="" type="checkbox"/> FULL STAND-UP ALL-WEATHER TOP	\$2,399
<input checked="" type="checkbox"/> BOW CONTOURED BACKRESTS	\$849
<input checked="" type="checkbox"/> BLUETOOTH AM/FM STEREO WITH MP3 PORT AND 2 SPEAKERS	\$799
<input checked="" type="checkbox"/> IN-DASH HUMMINBIRD HELIX 5 GPS FISH/DEPTH FINDER	\$749
<input checked="" type="checkbox"/> INTERIOR LED AMBIENT LIGHTING	\$699
<input checked="" type="checkbox"/> TILT STEERING	\$599
<input checked="" type="checkbox"/> SPACE-SAVING TRAILER SWING TONGUE	\$499
<input checked="" type="checkbox"/> SWIM PLATFORM WITH FOLD DOWN STEP(S)	\$399
<input checked="" type="checkbox"/> EZ-LOAD TRAILER GUIDES	\$299
<input checked="" type="checkbox"/> DRIVER'S SEAT SLIDER	\$299
<input checked="" type="checkbox"/> 12 VOLT POWER OUTLET	\$139
<input checked="" type="checkbox"/> BIG WHEEL BACKSAVER JACK AND DOLLY	\$119
<input checked="" type="checkbox"/> LEGEND QUICK LATCH TIE DOWNS	\$59

**Total Value: \$7,907 You Pay: \$0.**



### The Legend Advantage:

It's all included in your 18 XTR Troller Package.

**WE'VE GOT YOU COVERED**

<b>.100 Gauge</b> Perfect-Flex Aluminum	<b>All-Welded</b> Aluminum Hull	<b>Leakproof + 6 Year</b> For Life Warranty	<b>6YR</b> WOWranty
--	------------------------------------	--	------------------------

# XTR-SERIES

## 20 XTR TROLLER



The Troller's stern is as sturdy as it is wide.



Keep all your rods ready to go with port and starboard rod storage.



Keep 6 rods out of the way with lockable in-floor rod storage.



Keep your boat clean with the EZ-clean washdown system.



Enjoy a massive tournament sized livewell and all-vinyl floors.



Bimini, full stand-up top and bow cover provide all-weather protection. **Included**

### Always Included

#### CONSTRUCTION

- Intelliflex™ hull construction • Torsion beam energy transfer system • 3M highly reflective safety striping on Legend name • Large and practical slip-resistant side decks • Treated 7-ply marine-grade plywood floor and decks • Stainless steel transom and bow eyes • Injected and level foam floatation • 17° deep-v hull with reverse chines • .100 gauge super-thick two-piece alum. Hull construction

#### CONSOLE

- Horn • High profile clear-curved walk-through windshield • Ez-reset circuit breakers, switches and gauges • Chrome-bezeled multi-function tachometer with fuel gauge • Deluxe passenger console with extra-large glove box • Navigator console with built-in 5" GPS fishfinder

#### LIVEWELLS

- Threaded sure-lock stand pipe with overflow protection • 140 L Aerated bow livewell

#### SEATING

- 2 removable ErgoMax™ swivel chairs • 4 on the floor seat base configuration

#### DECKS AND STORAGE

- Lockable in-floor rod locker with tube holders for 6 rods • 6 drink holders • Rear battery storage area • Perko T-Handle flush locks and under rear seat storage • Large front casting deck with oversized storage

#### ADDITIONAL

- EZ-clean dura-deck vinyl floor • Automatic bilge pump • 132 L built-in under-floor fuel tank • Pre-wired for 12/24v electric trolling motor • Removable navigation and anchor lights • 6 mooring cleats or handles



# Built for a fun-filled big water adventure.



## BUILT FOR BIG WATER ADVENTURE



Rear fishing area features rod holders and ample storage for all of your gear. (Shown with optional downriggers)



Remove the rear jump seats for a comfortable walk-in downrigging area.

## SPECIFICATIONS

Length	19'6"	Hull Weight (lbs)	1530
Beam	97"	Bottom Width	76"
Hull Depth	45"	Package Length	21'1"
Inside Depth	31"	Package Width	100"
Aluminum Thickness	0.100	Towing Weight (lbs)	2996
Maximum Horsepower	175	Gas Tank	132 L (35 US gal)
Maximum Capacity (lbs)	1949		

## 20 XTR TROLLER

**\$139** Per Week

**\$66,999\***

ALL-IN PRICE  
NO EXTRA FEES\*



Build me!

With Mercury 115 EXLPT 4S and Glide-On Trailer

### Choose Your Power

Fish/Cruise  Tube  Ski

MERCURY 115 EXLPT 4S	INCLUDED	+ \$0
MERCURY 115 EXLPT PRO XS CT		+ \$1,099
MERCURY 150 XL 4S	<b>MOST POPULAR</b>	+ \$6,499
MERCURY 150 XL PRO XS 4S**		+ \$13,599

MPH 20 25 30 35 40 45 50 55

\*\* With Hydraulic Steering and Stainless Steel Propeller

### Preferred Equipment Package

	VALUE:
<input checked="" type="checkbox"/> FULL STAND-UP ALL-WEATHER TOP	\$2,399
<input checked="" type="checkbox"/> DELUXE RECLINING ERGOMAX™ CAPTAIN'S CHAIR WITH HEADREST	\$1,599
<input checked="" type="checkbox"/> EZ-CLEAN WASHDOWN SYSTEM	\$999
<input checked="" type="checkbox"/> BOW CONTOURED BACKRESTS	\$849
<input checked="" type="checkbox"/> BLUETOOTH AM/FM STEREO WITH MP3 PORT AND 2 SPEAKERS	\$799
<input checked="" type="checkbox"/> IN-DASH HUMMINBIRD HELIX 5 GPS FISH/DEPTH FINDER	\$749
<input checked="" type="checkbox"/> INTERIOR LED AMBIENT LIGHTING	\$699
<input checked="" type="checkbox"/> TILT STEERING	\$599
<input checked="" type="checkbox"/> SPACE-SAVING TRAILER SWING TONGUE	\$499
<input checked="" type="checkbox"/> SWIM PLATFORM WITH FOLD DOWN STEP(S)	\$399
<input checked="" type="checkbox"/> DRIVER'S SEAT SLIDER	\$299
<input checked="" type="checkbox"/> EZ-LOAD TRAILER GUIDES	\$299
<input checked="" type="checkbox"/> 12 VOLT POWER OUTLET	\$139
<input checked="" type="checkbox"/> BIG WHEEL BACKSAVER JACK AND DOLLY	\$119
<input checked="" type="checkbox"/> LEGEND QUICK LATCH TIE DOWNS	\$59

Total Value: \$10,505. You Pay: \$0.



### The Legend Advantage:

It's all included in your 20 XTR Troller Package.

WE'VE GOT YOU COVERED

<b>.100 Gauge</b> Perfect-Flex Aluminum	<b>All-Welded</b> Aluminum Hull	<b>Leakproof + 6 Year</b> For Life Warranty	<b>6YR</b> WOWranty
--	------------------------------------	--	------------------------

# F-SERIES

A fishing machine with more than enough family flare.

The F-Series has amazing performance on the water, making for a smooth ride with friends and family. Call dibs on your favourite casting deck and everyone will have a great day on the water. It's just part of the package.

F17 | F17 Pro | F17 Pro Tiller

F19 | F19 Pro | F19 Pro Tiller



---

**LENGTH:**

17' - 19'

**HORSEPOWER:**

90HP - 150HP

**HULL WEIGHT:**

1345-1435 lbs







# Key Series Features



 **The Iconic Legend**  
EZ-FOLD  
EXTENDA-DECK  
CONVERTA-BENCH™



**1**  EZ-Fold Extenda-Deck Converta-Bench™

**3** Dual Livewell

**2** Configurable Seating

**4** Bow Cushions\*

\*Not available on F-Series Pro models.



# F-SERIES F17



## Always Included

### CONSTRUCTION

• Intelliflex™ hull construction • Torsion beam energy transfer system • Large and practical slip-resistant side decks • Treated 7-ply marine-grade plywood floor and decks • Stainless steel transom and bow eyes • Injected and level foam floatation • 17° deep-v hull with hard chines • .100 gauge super-thick two-piece alum. Hull construction

### CONSOLE

• Horn • High profile clear-curved walk-through windshield • Ez-reset circuit breakers, switches and gauges • Speedometer, voltmeter, fuel gauge, tachometer • Deluxe passenger console with integrated CoolBox™ • Deluxe command-vu console with integrated drink holder

### LIVEWELLS

• Threaded sure-lock stand pipe with overflow protection • Integrated bait bucket • 45 L aerated stern livewell • 114 L aerated bow livewell



Remove the cushions to reveal a tournament-sized livewell, separate bait bucket, and lots of storage.



Keep 6 rods out of the way with lockable in-floor rod storage.



Add an **optional** removable solid brushed-aluminum ski pole. (#30900430)



Passenger console features a CoolBox™ to keep 12 drinks cool.



Bluetooth stereo, GPS fish/depth finder, and illuminated gauges and switches.



Comes with a full stand-up top to extend your boating season.

### SEATING

• EZ-Fold Extenda-Deck Converta-Bench™ • 2 removable ErgoMax™ swivel chairs • 4 on the floor seat base configuration

### DECKS AND STORAGE

• Lockable in-floor rod locker with tube holders for 6 rods • 6 drink holders • Rear battery storage area • Perko T-Handle flush locks and under rear seat storage • 7' port and starboard integral lockable rod boxes • Large rear casting deck with seat mount and storage • Large front casting deck with oversized storage

### ADDITIONAL

• EZ-clean dura-deck vinyl floor • Automatic bilge pump • 95 L built-in under-floor fuel tank • Pre-wired for 12v electric trolling motor • Removable navigation and anchor lights • 6 mooring cleats or handles



# Turn heads, drop jaws and make waves!



## EZ-FLIP 50/50 SPLIT CONVERTA BENCH



The EZ-Flip 50/50 Split Extenda-Deck Converta-Bench provides ample seating. It flips easily in seconds into a large rear casting deck for optimal space.

## SPECIFICATIONS

Length	<b>16'7"</b>	Hull Weight (lbs)	<b>1345</b>
Beam	<b>90"</b>	Bottom Width	<b>76"</b>
Hull Depth	<b>41"</b>	Package Length	<b>19'9"</b>
Inside Depth	<b>26"</b>	Package Width	<b>92"</b>
Aluminum Thickness	<b>0.100</b>	Towing Weight (lbs)	<b>2566</b>
Maximum Horsepower	<b>115</b>	Gas Tank	<b>95 L (25 US gal)</b>
Maximum Capacity (lbs)	<b>1631</b>		

## F17

**\$106** Per Week

**\$50,999\***

ALL-IN PRICE  
NO EXTRA FEES



With Mercury 90 ELPT 4S and Glide-On Trailer

Build me!

### Choose Your Power

Fish/Cruise  Tube  Ski

MERCURY 90 ELPT 4S	INCLUDED	+ \$0
MERCURY 90 ELPT 4S CT	MOST POPULAR	+ \$599
MERCURY 115 ELPT 4S		+ \$2,599
MERCURY 115 ELPT PRO XS CT		+ \$3,699

MPH 20 25 30 35 40 45 50 55

### Preferred Equipment Package

	VALUE:
<input checked="" type="checkbox"/> FULL STAND-UP ALL-WEATHER TOP	\$2,399
<input checked="" type="checkbox"/> BOW CUSHIONS WITH CONTOURED BACKRESTS	\$1,599
<input checked="" type="checkbox"/> RAM MOUNTED 5" GPS FISH/DEPTH FINDER	\$799
<input checked="" type="checkbox"/> BLUETOOTH AM/FM STEREO WITH MP3 PORT AND 2 SPEAKERS TILT	\$799
<input checked="" type="checkbox"/> STEERING	\$599
<input checked="" type="checkbox"/> SPACE-SAVING TRAILER SWING TONGUE	\$499
<input checked="" type="checkbox"/> SWIM PLATFORM WITH FOLD DOWN STEP(S)	\$399
<input checked="" type="checkbox"/> EZ-LOAD TRAILER GUIDES	\$299
<input checked="" type="checkbox"/> DRIVER'S SEAT SLIDER	\$299
<input checked="" type="checkbox"/> 12 VOLT POWER OUTLET	\$139
<input checked="" type="checkbox"/> BIG WHEEL BACKSAVER JACK AND DOLLY	\$119
<input checked="" type="checkbox"/> LEGEND QUICK LATCH TIE DOWNS	\$59

Total Value: \$8,008. You Pay: \$0.

The Legend Advantage: It's all included in your F17 Package.

WE'VE GOT YOU COVERED

<b>.100 Gauge</b> Perfect-Flex Aluminum	<b>All-Welded</b> Aluminum Hull	<b>Leakproof + 6 Year</b> For Life Warranty	<b>6YR</b> WOWranty
--	------------------------------------	--	------------------------

# F-SERIES F17 PRO



Keep over 6 fishing rods safely locked away in one of two in-floor rod lockers.



In-Dash Helix 7" GPS Fish / Depth Finder Upgrade. **Included**



Massive bow casting deck with tons of storage for all your gear and more.



Enjoy a tournament sized livewell with separate bait bucket.



Side lockable storage for all of your fishing gear.



Full stand-up all-weather top extends your boating season. **Included**

## Always Included

### CONSTRUCTION

- Intelliflex™ hull construction • Torsion beam energy transfer system • Large and practical slip-resistant side decks • Treated 7-ply marine-grade plywood floor and decks • Stainless steel transom and bow eyes • Injected and level foam floatation • 17° deep-v hull with reverse chines • .100 gauge aluminum hull and bow rib construction

### CONSOLE

- Horn • High profile clear-curved walk-through windshield • Ez-reset circuit breakers, switches and gauges • Speedometer, voltmeter, fuel gauge, tachometer • Deluxe passenger console with integrated CoolBox™ • Deluxe command-vu console with integrated drink holder

### LIVEWELLS

- 75 L aerated stern livewell • 45 L aerated bow livewell • Threaded sure-lock stand pipe with overflow protection • Integrated bait bucket

### SEATING

- EZ-Fold Extenda-Deck Converta-Bench™ • 2 removable ErgoMax™ swivel chairs • 4 on the floor seat base configuration

### DECKS AND STORAGE

- Lockable in-floor rod locker with tube holders for 6 rods • 6 drink holders • Rear battery storage area • Perko T-Handle flush locks and under rear seat storage • 7' port and starboard integral lockable rod boxes • Large rear casting deck with seat mount and storage • Large front casting deck with oversized storage

### ADDITIONAL

- EZ-clean dura-deck vinyl floor • Automatic bilge pump • 95 L built-in under-floor fuel tank • Pre-wired for 12v electric trolling motor • Removable navigation and anchor lights • 6 mooring cleats or handles

# Tournament ready.



EZ-FLIP 50/50 SPLIT CONVERTA BENCH



The EZ-Flip 50/50 Split Extenda-Deck Converta-Bench provides ample seating. It flips easily in seconds into a large rear casting deck for optimal space.

## SPECIFICATIONS

Length	<b>16'7"</b>	Bottom Width	<b>76"</b>
Beam	<b>90"</b>	Package Length	<b>19'9"</b>
Hull Depth	<b>41"</b>	Package Width	<b>92"</b>
Inside Depth	<b>26"</b>	Towing Weight (lbs)	<b>2566</b>
Aluminum Thickness	<b>0.100</b>	Gas Tank	<b>95 L (25 US gal)</b>
Maximum Horsepower	<b>115</b>	Maximum Capacity (lbs)	<b>1631</b>
Hull Weight (lbs)	<b>1345</b>		

## F17 PRO

**\$112** Per Week

**\$53,999\***

ALL-IN PRICE  
NO EXTRA FEES



With Mercury 90 ELPT 4S and Glide-On Trailer

Build me!

### Choose Your Power

Fish/Cruise  Tube  Ski

MERCURY 90 ELPT 4S	INCLUDED	+ \$0
MERCURY 90 ELPT 4S CT	MOST POPULAR	+ \$599
MERCURY 115 ELPT 4S		+ \$2,599
MERCURY 115 ELPT PRO XS CT		+ \$3,699

MPH 20 25 30 35 40 45 50 55

### Preferred Equipment Package

	VALUE:
<input checked="" type="checkbox"/> FULL STAND-UP ALL-WEATHER TOP	\$2,399
<input checked="" type="checkbox"/> IN-DASH HUMMINBIRD HELIX 7 GPS FISH/DEPTH FINDER	\$1,349
<input checked="" type="checkbox"/> BLUETOOTH AM/FM STEREO WITH MP3 PORT AND 2 SPEAKERS	\$799
<input checked="" type="checkbox"/> TILT STEERING	\$599
<input checked="" type="checkbox"/> SPACE-SAVING TRAILER SWING TONGUE	\$499
<input checked="" type="checkbox"/> SWIM PLATFORM WITH FOLD DOWN STEP(S)	\$399
<input checked="" type="checkbox"/> DUAL USB POWER OUTLET	\$299
<input checked="" type="checkbox"/> EZ-LOAD TRAILER GUIDES	\$299
<input checked="" type="checkbox"/> DRIVER'S SEAT SLIDER	\$299
<input checked="" type="checkbox"/> BIG WHEEL BACKSAVER JACK AND DOLLY	\$119
<input checked="" type="checkbox"/> LEGEND QUICK LATCH TIE DOWNS	\$59

Total Value: \$7,119. You Pay: \$0.

**The Legend Advantage: It's all included in your F17 Pro Package.**

**WE'VE GOT YOU COVERED**

**.100 Gauge**  
Perfect-Flex Aluminum

**All-Welded**  
Aluminum Hull

**Leakproof + 6 Year**  
For Life Warranty

**6YR**  
WOWranty



# F-SERIES F19



Bow casting deck with integrated tournament-sized livewell and lots of storage.



Bluetooth stereo, GPS fish/depth finder, and illuminated console.



The passenger console features a CoolBox™ to keep 12 drinks cool.



Keep 6 rods safe with an in-floor rod locker and 2 lockable side ride compartments.



Add an **optional** removable solid brushed-aluminum ski pole. (#30900430)



Full stand-up all-weather top extends your boating season. **Included**

## Always Included

### CONSTRUCTION

• Intelliflex™ hull construction • Torsion beam energy transfer system • Large and practical slip-resistant side decks • Treated 7-ply marine-grade plywood floor and decks • Stainless steel transom and bow eyes • Injected and level foam floatation • 17° deep-v hull with reverse chines • .100 gauge super-thick two-piece alum. Hull construction

### CONSOLE

• Horn • High profile clear-curved walk-through windshield • Ez-reset circuit breakers, switches and gauges • Speedometer, voltmeter, fuel gauge, tachometer • Deluxe passenger console with integrated CoolBox™ • Deluxe command-vu console with integrated drink holder

### LIVEWELLS

• Threaded sure-lock stand pipe with overflow protection • Integrated bait bucket • 45 L aerated stern livewell • 114 L aerated bow livewell

### SEATING

• EZ-Fold Extenda-Deck Converta-Bench™ • 2 removable ErgoMax™ swivel chairs • 4 on the floor seat base configuration

### DECKS AND STORAGE

• Lockable in-floor rod locker with tube holders for 6 rods • 6 drink holders • Rear battery storage area • Perko T-Handle flush locks and under rear seat storage • 7' port and starboard integral lockable rod boxes • Large rear casting deck with seat mount and storage • Large front casting deck with oversized storage

### ADDITIONAL

• EZ-clean dura-deck vinyl floor • Automatic bilge pump • 132 L built-in under-floor fuel tank • Pre-wired for 12/24v electric trolling motor • Removable navigation and anchor lights • 6 mooring cleats or handles

# Turn heads, drop jaws and make waves!



## EZ-FLIP 50/50 SPLIT CONVERTA BENCH



The EZ-Flip 50/50 Split Extenda-Deck Converta-Bench provides ample seating. It flips easily in seconds into a large rear casting deck for optimal space.

## SPECIFICATIONS

Length	<b>18'6"</b>	Hull Weight (lbs)	<b>1435</b>
Beam	<b>94"</b>	Bottom Width	<b>76"</b>
Hull Depth	<b>42"</b>	Package Length	<b>20'9"</b>
Inside Depth	<b>28"</b>	Package Width	<b>96"</b>
Aluminum Thickness	<b>0.100</b>	Towing Weight (lbs)	<b>2937</b>
Maximum Horsepower	<b>150</b>	Gas Tank	<b>132 L (35 US gal)</b>
Maximum Capacity (lbs)	<b>1744</b>		

## F19

**\$122** Per Week

**\$58,999\***

ALL-IN PRICE  
NO EXTRA FEES



Build me!

Mercury 90 ELPT 4S and Glide-On Trailer

### Choose Your Power

Fish/Cruise  Tube  Ski

MERCURY 90 ELPT 4S	INCLUDED	+ \$0
MERCURY 115 ELPT PRO XS CT	MOST POPULAR	+ \$3,699
MERCURY 150L 4S		+ \$9,099
MERCURY 150 L PRO XS 4S**		+ \$16,199

MPH 20 25 30 35 40 45 50 55

\*\* With Hydraulic Steering and Stainless Steel Propeller

### Preferred Equipment Package

	VALUE:
<input checked="" type="checkbox"/> FULL STAND-UP ALL-WEATHER TOP	\$2,399
<input checked="" type="checkbox"/> BOW CUSHIONS WITH CONTOURED BACKRESTS	\$1,599
<input checked="" type="checkbox"/> RAM MOUNTED 5" GPS FISH/DEPTH FINDER	\$799
<input checked="" type="checkbox"/> BLUETOOTH AM/FM STEREO WITH MP3 PORT AND 2 SPEAKERS	\$799
<input checked="" type="checkbox"/> TILT STEERING	\$599
<input checked="" type="checkbox"/> SPACE-SAVING TRAILER SWING TONGUE	\$499
<input checked="" type="checkbox"/> SWIM PLATFORM WITH FOLD DOWN STEP(S)	\$399
<input checked="" type="checkbox"/> EZ-LOAD TRAILER GUIDES	\$299
<input checked="" type="checkbox"/> DRIVER'S SEAT SLIDER	\$299
<input checked="" type="checkbox"/> 12 VOLT POWER OUTLET	\$139
<input checked="" type="checkbox"/> BIG WHEEL BACKSAVER JACK AND DOLLY	\$119
<input checked="" type="checkbox"/> LEGEND QUICK LATCH TIE DOWNS	\$59

Total Value: \$8,008. You Pay: \$0.

The Legend Advantage: It's all included in your F19 Package.

WE'VE GOT YOU COVERED

<b>.100 Gauge</b> Perfect-Flex Aluminum	<b>All-Welded</b> Aluminum Hull	<b>Leakproof + 6 Year</b> For Life Warranty
<small>WOWranty</small>		<small>WOWranty</small>

# F-SERIES F19 PRO



Bluetooth stereo, GPS fish/depth finder, and illuminated gauges and switches.



Keep 8 rods safe with a large rod storage locker. Additional hidden and lockable storage underneath.



Enjoy a tournament-sized livewell with separate bait bucket.



Easily move the ErgoMax™ swivel seats for ultimate fishing comfort.



Pre-wired for **optional** trolling motor.



Full stand-up all-weather top extends your boating season. **Included**

## Always Included

### CONSTRUCTION

- Intelliflex™ hull construction • Torsion beam energy transfer system • Large and practical slip-resistant side decks • Treated 7-ply marine-grade plywood floor and decks • Stainless steel transom and bow eyes • Injected and level foam floatation • 17° deep-v hull with reverse chines • .100 gauge aluminum hull and bow rib construction

### CONSOLE

- Horn • High profile clear-curved walk-through windshield • Ez-reset circuit breakers, switches and gauges • Speedometer, voltmeter, fuel gauge, tachometer • Deluxe passenger console with integrated CoolBox™ • Deluxe command-vu console with integrated drink holder

### LIVEWELLS

- 95 L aerated stern livewell • Threaded sure-lock stand pipe with overflow protection • Integrated bait bucket

### SEATING

- EZ-Fold Extenda-Deck Converta-Bench™ • 2 removable ErgoMax™ swivel chairs • 4 on the floor seat base configuration

### DECKS AND STORAGE

- Lockable in-floor rod locker with tube holders for 6 rods • 6 drink holders • Rear battery storage area • Perko T-Handle flush locks and under rear seat storage • 7' port and starboard integral lockable rod boxes • Large rear casting deck with seat mount and storage • Large front casting deck with oversized storage

### ADDITIONAL

- EZ-clean dura-deck vinyl floor • 6 mooring cleats or handles • Automatic bilge pump • 132 L built-in under-floor fuel tank • Pre-wired for 12/24v electric trolling motor • Removable navigation and anchor lights



# The Tournament King.



EZ-FLIP 50/50 SPLIT CONVERTA BENCH



The EZ-Flip 50/50 Split Extenda-Deck Converta-Bench provides ample seating. It flips easily in seconds into a large rear casting deck for optimal space.

## SPECIFICATIONS

Length	<b>18'6"</b>	Bottom Width	<b>76"</b>
Beam	<b>94"</b>	Package Length	<b>20'9"</b>
Hull Depth	<b>42"</b>	Package Width	<b>96"</b>
Inside Depth	<b>28"</b>	Towing Weight (lbs)	<b>2937</b>
Aluminum Thickness	<b>0.100</b>	Gas Tank	<b>132 L (35 US gal)</b>
Maximum Horsepower	<b>150</b>	Maximum Capacity (lbs)	<b>1744</b>
Hull Weight (lbs)	<b>1435</b>		

## F19 PRO

**\$131** Per Week

**\$62,999\***

ALL-IN PRICE  
NO EXTRA FEES



Build me!

Mercury 90 EXLPT 4S and Glide-On Trailer

### Choose Your Power

Fish/Cruise  Tube  Ski

MERCURY 90 EXLPT 4S	INCLUDED	+ \$0
MERCURY 115 ELPT PRO XS CT		+ \$3,699
MERCURY 150 XL 4S	MOST POPULAR	+ \$9,099
MERCURY 150 L PRO XS 4S**		+ \$16,199

MPH 20 25 30 35 40 45 50 55

\*\* With Hydraulic Steering and Stainless Steel Propeller

### Preferred Equipment Package

	VALUE:
<input checked="" type="checkbox"/> FULL STAND-UP ALL-WEATHER TOP	\$2,399
<input checked="" type="checkbox"/> IN-DASH HUMMINBIRD HELIX 7 GPS FISH/DEPTH FINDER	\$1,349
<input checked="" type="checkbox"/> BLUETOOTH AM/FM STEREO WITH MP3 PORT AND 2 SPEAKERS	\$799
<input checked="" type="checkbox"/> TILT STEERING	\$599
<input checked="" type="checkbox"/> SPACE-SAVING TRAILER SWING TONGUE	\$499
<input checked="" type="checkbox"/> SWIM PLATFORM WITH FOLD DOWN STEP(S)	\$399
<input checked="" type="checkbox"/> DUAL USB POWER OUTLET	\$299
<input checked="" type="checkbox"/> EZ-LOAD TRAILER GUIDES	\$299
<input checked="" type="checkbox"/> DRIVER'S SEAT SLIDER	\$299
<input checked="" type="checkbox"/> BIG WHEEL BACKSAVER JACK AND DOLLY	\$119
<input checked="" type="checkbox"/> LEGEND QUICK LATCH TIE DOWNS	\$59

Total Value: \$7,119. You Pay: \$0.

**The Legend Advantage: It's all included in your F19 Pro Package.**

WE'VE GOT YOU COVERED

 <b>.100 Gauge</b> <small>Perfect-Flex Aluminum</small>	 <b>All-Welded</b> <small>Aluminum Hull</small>	 <b>Leakproof + 6 Year</b> <small>For Life Warranty</small>	 <b>6YR</b> <small>WOWranty</small>
---	---	---	---

# F-SERIES F17 PRO TILLER



## Always Included

### CONSTRUCTION

• Intelliflex™ hull construction • Torsion beam energy transfer system • Large and practical slip-resistant side decks • Treated 7-ply marine-grade plywood floor and decks • Stainless steel transom and bow eyes • Injected and level foam floatation • 17° deep-v hull with reverse chines • .100 gauge aluminum hull and bow rib construction

### LIVEWELLS

• 45 L aerated bow livewell • 75 L aerated stern livewell • Threaded sure-lock stand pipe with overflow protection • Integrated bait bucket

### SEATING

• 3 removable ErgoMax™ swivel chairs • 4 on the floor seat base configuration



RAM-mounted Colour GPS/fish finder with Navigation.

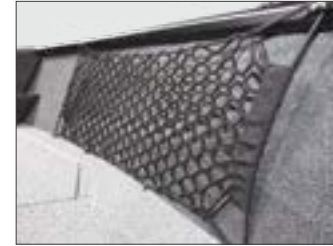

Side Cargo Netting.



Enjoy a tournament-sized livewell with separate bait bucket.



Keep 5 rods safe with a large rod storage locker. Additional lockable storage underneath.



Pre-wired for **optional** trolling motor.



Side lockable storage for all of your fishing gear.

### DECKS AND STORAGE

• Lockable in-floor rod locker with tube holders for 5 rods • 6 drink holders • Rear battery storage area • Perko T-Handle flush locks and under rear seat storage • 7' port and starboard integral lockable rod boxes • Large rear casting deck with seat mount and storage • Large front casting deck with oversized storage

### ADDITIONAL

• EZ-clean dura-deck vinyl floor • 6 mooring cleats or handles • Automatic bilge pump • 95 L built-in under-floor fuel tank • Pre-wired for 12v electric trolling motor • Removable navigation and anchor lights

# More control and even more fishing space.



## BUILT FOR BIG WATER ADVENTURE



Massive bow deck with lockable rod storage and tons of room for your gear.



Spacious open interior and aft casting deck with room for all your fishing buddies.

## SPECIFICATIONS

Length	<b>16'7"</b>	Bottom Width	<b>76"</b>
Beam	<b>90"</b>	Package Length	<b>19'9"</b>
Hull Depth	<b>41"</b>	Package Width	<b>92"</b>
Inside Depth	<b>26"</b>	Towing Weight (lbs)	<b>2566</b>
Aluminum Thickness	<b>0.100</b>	Gas Tank	<b>95 L (25 US gal)</b>
Maximum Horsepower	<b>75</b>	Maximum Capacity (lbs)	<b>1631</b>
Hull Weight (lbs)	<b>1345</b>		

## F17 PRO TILLER

**\$95** Per Week

**\$45,999\***

ALL-IN PRICE  
NO EXTRA FEES



Build me!

With Mercury 40 ELHPT 4S Tiller (with new advanced tiller) and Glide-On Trailer

### Choose Your Power

Fish/Cruise  Tube  Ski

MERCURY 40 ELHPT 4S TILLER (WITH NEW ADVANCED TILLER) INCLUDED	+ \$0
MERCURY 50 ELHPT 4S CT TILLER	+ \$1,499
MERCURY 60 ELHPT 4S CT TILLER	+ \$2,499
MERCURY 75 ELPT 4S W/ BIG TILLER HANDLE	+ \$5,999

MPH 20 25 30 35 40 45 50 55

### Preferred Equipment Package

	VALUE:
<input checked="" type="checkbox"/> RAM MOUNTED 7" GPS FISH/DEPTH FINDER	\$1,349
<input checked="" type="checkbox"/> SPACE-SAVING TRAILER SWING TONGUE	\$499
<input checked="" type="checkbox"/> DUAL USB POWER OUTLET	\$299
<input checked="" type="checkbox"/> EZ-LOAD TRAILER GUIDES	\$299
<input checked="" type="checkbox"/> DRIVER'S SEAT SLIDER	\$299
<input checked="" type="checkbox"/> BIG WHEEL BACKSAVER JACK AND DOLLY	\$119
<input checked="" type="checkbox"/> LEGEND QUICK LATCH TIE DOWNS	\$59

Total Value: \$2,923. You Pay: \$0.

**The Legend Advantage: It's all included in your F17 Pro Tiller Package.**

WE'VE GOT YOU COVERED

<b>.100 Gauge</b> Perfect-Flex Aluminum	<b>All-Welded</b> Aluminum Hull	<b>Leakproof + 6 Year</b> For Life Warranty
<small>WOWranty</small>	<small>WOWranty</small>	<small>WOWranty</small>



# F-SERIES F19 PRO TILLER



## Always Included

### CONSTRUCTION

• Intelliflex™ hull construction • Torsion beam energy transfer system • Large and practical slip-resistant side decks • Treated 7-ply marine-grade plywood floor and decks • Stainless steel transom and bow eyes • Injected and level foam floatation • 17° deep-v hull with reverse chines • .100 gauge aluminum hull and bow rib construction

### LIVEWELLS

• 95 L aerated stern livewell • Threaded sure-lock stand pipe with overflow protection • Integrated bait bucket

### SEATING

• 3 removable ErgoMax™ swivel chairs • 4 on the floor seat base configuration



RAM-mounted Colour GPS/fish finder with Navigation.



Side Cargo Netting.



Enjoy a tournament-sized livewell with separate bait bucket.



Keep 8 rods safe with a massive rod locker and additional lockable storage underneath.



Pre-wired for **optional** trolling motor.



Side lockable storage for all of your fishing gear.

### DECKS AND STORAGE

• Lockable in-floor rod locker with tube holders for 6 rods • 6 drink holders • Rear battery storage area • Perko T-Handle flush locks and under rear seat storage • 7' port and starboard integral lockable rod boxes • Large rear casting deck with seat mount and storage • Large front casting deck with oversized storage

### ADDITIONAL

• EZ-clean dura-deck vinyl floor • Automatic bilge pump • 132 L built-in under-floor fuel tank • Pre-wired for 12/24v electric trolling motor • Removable navigation and anchor lights • 6 mooring cleats or handles

# The Pro Anglers' Boat.



## THE PRO ANGLERS' BOAT



The F19 Pro Tiller is a fisherman's dream. Direct control of your motor, loads of fishing space.



## TAKE CONTROL



Comfortably steer your tiller motor and monitor your fish and depth finder

## SPECIFICATIONS

Length	18'6"	Bottom Width	76"
Beam	94"	Package Length	20'9"
Hull Depth	42"	Package Width	96"
Inside Depth	28"	Towing Weight (lbs)	2937
Aluminum Thickness	0.100	Gas Tank	132 L (35 US gal)
Maximum Horsepower	90	Maximum Capacity (lbs)	1744
Hull Weight (lbs)	1435		

## F19 PRO TILLER

**\$124** Per Week

**\$59,999\***

ALL-IN PRICE  
NO EXTRA FEES



Build me!

With Mercury 90 EXLPT 4S with Big Tiller Handle and Glide-On Trailer

### Choose Your Power

Fish/Cruise  Tube  Ski

MERCURY 90 EXLPT 4S WITH BIG TILLER HANDLE INCLUDED + \$0

MERCURY 90 EXLPT CT 4S WITH BIG TILLER HANDLE MOST POPULAR + \$599

MPH 20 25 30 35 40 45 50 55

### Preferred Equipment Package

	VALUE:
<input checked="" type="checkbox"/> RAM MOUNTED 7" GPS FISH/DEPTH FINDER	\$1,349
<input checked="" type="checkbox"/> SPACE-SAVING TRAILER SWING TONGUE	\$499
<input checked="" type="checkbox"/> EZ-LOAD TRAILER GUIDES	\$299
<input checked="" type="checkbox"/> DUAL USB POWER OUTLET	\$299
<input checked="" type="checkbox"/> DRIVER'S SEAT SLIDER	\$299
<input checked="" type="checkbox"/> BIG WHEEL BACKSAVER JACK AND DOLLY	\$119
<input checked="" type="checkbox"/> LEGEND QUICK LATCH TIE DOWNS	\$59

Total Value: \$2,923. You Pay: \$0.

**The Legend Advantage: It's all included in your F19 Pro Tiller Package.**

### WE'VE GOT YOU COVERED

**.100 Gauge**  
Perfect-Flex Aluminum

**All-Welded**  
Aluminum Hull

**Leakproof + 6 Year**  
For Life Warranty  
WOWranty

# XTE-SERIES

Exciting memories are waiting.

The XTE series offers a bold look and all the features you need in 5 exciting models. Whether you want the protection of a full windshield or the room of a side console, the utility of a tiller or need the extra seating and family features of a sport model, we have the XTE for you!

16 XTE | SC, SC SPORT, Sport, Tiller

18 XTE | Sport



**LENGTH:**

16' - 18'

**HORSEPOWER:**

40HP - 115HP

**HULL WEIGHT:**

675 - 1015 lbs





# XTE-SERIES



# Key Series Features



**1** Oversized Casting Deck

---

**3** Lockable Storage

---

**2** Full-Vu Console

---

**4** Extenda-Deck Converta-Bench

---







# XTE-SERIES

## 16 XTE TILLER



Bimini top available (#BTB-90).  
**Optional**



Lockable side storage fits rods up to 7'.



Enjoy a tournament-sized livewell with separate bait bucket.



Illuminated switches are visible and always within reach.



Pre-wired for **optional** trolling motor.



Find the best fishing spots with your fish and depth finder.

### Always Included

#### CONSTRUCTION

• Intelliflex™ hull construction • Torsion beam energy transfer system • 3M highly reflective safety striping on Legend name • Large and practical slip-resistant side decks • Treated 7-ply marine-grade plywood floor and decks • Stainless steel transom and bow eyes • Injected and level foam flotation • 10° deep-v hull with reverse chines • .100 gauge super-thick two-piece alum. Hull construction

#### LIVEWELLS

• Threaded sure-lock stand pipe with overflow protection • Integrated bait bucket • 114 L aerated bow livewell

#### SEATING

• 3 removable ErgoMax™ swivel chairs • 4 on the floor seat base configuration

#### DECKS AND STORAGE

• 5 drink holders • Rear battery storage area • Perko T-Handle flush locks and under rear seat storage • 7' starboard integral lockable rod box • Large rear casting deck with seat mount and storage • Large front casting deck with oversized storage

#### ADDITIONAL

• EZ-clean dura-deck vinyl floor • Automatic bilge pump • Portable fuel tank • Pre-wired for 12v electric trolling motor • Removable navigation and anchor lights • 6 mooring cleats or handles

# Always ready to take you out for a day of serious fishing.



## 16 XTE TILLER

**\$66** Per Week | **\$31,999\***



Build me!

With Mercury 40 ELHPT 4S Tiller (with new advanced tiller) and Glide-On Trailer

### Choose Your Power

Fish/Cruise  Tube  Ski

MERCURY 40 ELHPT 4S TILLER (WITH NEW ADVANCED TILLER)	+ \$0
MERCURY 50 ELHPT CT 4S TILLER	+ \$1,499
MERCURY 60 ELHPT CT 4S TILLER	+ \$2,499

MOST POPULAR

MPH 20 25 30 35 40 45 50 55

### Preferred Equipment Package

	VALUE:
<input checked="" type="checkbox"/> SPACE-SAVING TRAILER SWING TONGUE	\$499
<input checked="" type="checkbox"/> EZ-LOAD TRAILER GUIDES	\$299
<input checked="" type="checkbox"/> 4" FISH/DEPTH FINDER	\$299
<input checked="" type="checkbox"/> BIG WHEEL BACKSAVER JACK AND DOLLY	\$119
<input checked="" type="checkbox"/> 2 DELUXE ROD HOLDERS	\$79
<input checked="" type="checkbox"/> LEGEND QUICK LATCH TIE DOWNS	\$59

Total Value: \$1,354 You Pay: \$0.

**The Legend Advantage: It's all included in your 16 XTE Tiller Package.**

## SPECIFICATIONS

Length	<b>16'6"</b>	Hull Weight (lbs)	<b>675</b>
Beam	<b>82"</b>	Bottom Width	<b>69"</b>
Hull Depth	<b>37"</b>	Package Length	<b>18'4"</b>
Inside Depth	<b>25"</b>	Package Width	<b>82"</b>
Aluminum Thickness	<b>0.100</b>	Towing Weight (lbs)	<b>1580</b>
Maximum Horsepower	<b>60</b>	Gas Tank	<b>Portable</b>
Maximum Capacity (lbs)	<b>1393</b>		

WE'VE GOT YOU COVERED

<b>.100 Gauge</b> Perfect-Flex Aluminum	<b>All-Welded</b> Aluminum Hull	<b>Leakproof + 6 Year</b> For Life Warranty	<b>6YR</b> WOWranty
--	------------------------------------	--	------------------------

# XTE-SERIES 16 XTE SC



Bimini top available (#BTB-90).  
**Optional**



Massive bow casting deck with tons of storage for all your gear and more.



Enjoy a tournament-sized livewell with separate bait bucket.



Fish/depth finder, and illuminated gauges and switches.



Lockable side storage fits rods up to 7'



Significant storage throughout, including bow, stern, and side storage.

## Always Included

### CONSTRUCTION

- Intelliflex™ hull construction • Torsion beam energy transfer system • 3M highly reflective safety striping on Legend name • Large and practical slip-resistant side decks • Treated 7-ply marine-grade plywood floor and decks • Stainless steel transom and bow eyes • Injected and level foam floatation • 10° deep-v hull with reverse chines • .100 gauge super-thick two-piece alum. Hull construction

### CONSOLE

- Ez-reset circuit breakers, switches and gauges • Chrome-bezeled and backlit speedometer and tachometer • Deluxe Full-Vu™ console with woodgrain dash panels

### LIVEWELLS

- Threaded sure-lock stand pipe with overflow protection • Integrated bait bucket • 114 L aerated bow livewell

### SEATING

- 3 removable ErgoMax™ swivel chairs • 4 on the floor seat base configuration

### DECKS AND STORAGE

- 5 drink holders • Rear battery storage area • Perko T-Handle flush locks and under rear seat storage • 7' starboard integral lockable rod box • Large rear casting deck with seat mount and storage • Large front casting deck with oversized storage

### ADDITIONAL

- EZ-clean dura-deck vinyl floor • Automatic bilge pump • Portable fuel tank • Pre-wired for 12v electric trolling motor • Removable navigation and anchor lights • 6 mooring cleats or handles



# A fishing dream.



## 16 XTE SC

**\$66** Per Week

**\$31,999\***

ALL-IN PRICE  
NO EXTRA FEES



Build me!

With Mercury 40 ELPT 4S and Glide-On Trailer

### Choose Your Power

Fish/Cruise  Tube  Ski

MERCURY 40 ELPT 4S	INCLUDED	+ \$0
MERCURY 40 ELPT 4S CT		+ \$599
MERCURY 60 ELPT 4S CT	MOST POPULAR	+ \$3,799
MERCURY 90 ELPT 4S		+ \$6,999

MPH 20 25 30 35 40 45 50 55

### Preferred Equipment Package

	VALUE:
<input checked="" type="checkbox"/> SPACE-SAVING TRAILER SWING TONGUE	\$499
<input checked="" type="checkbox"/> DRIVER'S SEAT SLIDER	\$299
<input checked="" type="checkbox"/> EZ-LOAD TRAILER GUIDES	\$299
<input checked="" type="checkbox"/> 4" FISH/DEPTH FINDER	\$299
<input checked="" type="checkbox"/> 12 VOLT POWER OUTLET	\$139
<input checked="" type="checkbox"/> BIG WHEEL BACKSAVER JACK AND DOLLY	\$119
<input checked="" type="checkbox"/> 2 DELUXE ROD HOLDERS	\$79
<input checked="" type="checkbox"/> LEGEND QUICK LATCH TIE DOWNS	\$59

Total Value: \$1,792. You Pay: \$0.

**The Legend Advantage:** It's all included in your 16 XTE SC Sport Package.

## SPECIFICATIONS

Length	16'6"	Hull Weight (lbs)	790
Beam	82"	Bottom Width	69"
Hull Depth	37"	Package Length	18'4"
Inside Depth	25"	Package Width	82"
Aluminum Thickness	0.100	Towing Weight (lbs)	1690
Maximum Horsepower	90	Gas Tank	Portable
Maximum Capacity (lbs)	1393		

WE'VE GOT YOU COVERED

<b>.100 Gauge</b> Perfect-Flex Aluminum	<b>All-Welded</b> Aluminum Hull	<b>Leakproof + 6 Year</b> For Life Warranty	<b>6YR</b> WOWranty
--	------------------------------------	--	------------------------

## XTE-SERIES

# 16 XTE SC SPORT



Bimini top available (#BTB-90).  
**Optional**



Fish/depth finder, and illuminated gauges and switches.



Enjoy a tournament-sized livewell with separate bait bucket.



Aft swim platform for easy boarding.



Convenient rod holders at the bow and stern.



Pre-wired for **optional** trolling motor.

## Always Included

### CONSTRUCTION

• Intelliflex™ hull construction • Torsion beam energy transfer system • 3M highly reflective safety striping on Legend name • Large and practical slip-resistant side decks • Treated 7-ply marine-grade plywood floor and decks • Stainless steel transom and bow eyes • Injected and level foam flotation • 10° deep-v hull with reverse chines • .100 gauge super-thick two-piece alum. Hull construction

### CONSOLE

• Ez-reset circuit breakers, switches and gauges • Chrome-bezeled and backlit speedometer and tachometer • Deluxe Full-Vu™ console with woodgrain dash panels

### LIVEWELLS

• Threaded sure-lock stand pipe with overflow protection • Integrated bait bucket • 114 L aerated bow livewell

### SEATING

• 2 removable ErgoMax™ swivel chairs • 4 on the floor seat base configuration • EZ-Flip 50/50 split extenda-deck ConvertaBench

### DECKS AND STORAGE

• 5 drink holders • Rear battery storage area • Perko T-Handle flush locks and under rear seat storage • 7' starboard integral lockable rod box • Large rear casting deck with seat mount and storage • Large front casting deck with oversized storage

### ADDITIONAL

• EZ-clean dura-deck vinyl floor • Automatic bilge pump • Portable fuel tank • Pre-wired for 12v electric trolling motor • Removable navigation and anchor lights • 6 mooring cleats or handles

# Fishing upgraded.



## EZ-FLIP 50/50 SPLIT CONVERTA BENCH



The EZ-Flip 50/50 Split Extenda-Deck Converta-Bench provides ample seating. It flips easily in seconds into a large rear casting deck for optimal space.

## SPECIFICATIONS

Length	<b>16'6"</b>	Hull Weight (lbs)	<b>830</b>
Beam	<b>82"</b>	Bottom Width	<b>69"</b>
Hull Depth	<b>37"</b>	Package Length	<b>18'4"</b>
Inside Depth	<b>25"</b>	Package Width	<b>82"</b>
Aluminum Thickness	<b>0.100</b>	Towing Weight (lbs)	<b>1730</b>
Maximum Horsepower	<b>90</b>	Gas Tank	<b>Portable</b>
Maximum Capacity (lbs)	<b>1393</b>		

## 16 XTE SC SPORT

**\$68** Per Week

**\$32,999\***

ALL-IN PRICE  
NO EXTRA FEES



Build me!

With Mercury 40 ELPT 4S and Glide-On Trailer

### Choose Your Power

Fish/Cruise  Tube  Ski

MERCURY 40 ELPT 4S	INCLUDED	+ \$0
MERCURY 40 ELPT 4S CT		+ \$599
MERCURY 60 ELPT 4S CT	MOST POPULAR	+ \$3,799
MERCURY 90 ELPT 4S		+ \$6,999

MPH: 20 25 30 35 40 45 50 55

### Preferred Equipment Package

	VALUE:
<input checked="" type="checkbox"/> SPACE-SAVING TRAILER SWING TONGUE	\$499
<input checked="" type="checkbox"/> SWIM PLATFORM WITH FOLD DOWN STEP(S)	\$399
<input checked="" type="checkbox"/> DRIVER'S SEAT SLIDER	\$299
<input checked="" type="checkbox"/> EZ-LOAD TRAILER GUIDES	\$299
<input checked="" type="checkbox"/> 4" FISH/DEPTH FINDER	\$299
<input checked="" type="checkbox"/> 12 VOLT POWER OUTLET	\$139
<input checked="" type="checkbox"/> BIG WHEEL BACKSAVER JACK AND DOLLY	\$119
<input checked="" type="checkbox"/> 2 DELUXE ROD HOLDERS	\$79
<input checked="" type="checkbox"/> LEGEND QUICK LATCH TIE DOWNS	\$59

Total Value: \$2,191. You Pay: \$0.

**The Legend Advantage:** It's all included in your 16 XTE SC Sport Package.

WE'VE GOT YOU COVERED

<b>.100 Gauge</b> Perfect-Flex Aluminum	<b>All-Welded</b> Aluminum Hull	<b>Leakproof + 6 Year</b> For Life Warranty	<b>6YR</b> WOWranty
--	------------------------------------	--	------------------------



# XTE-SERIES 16 XTE SPORT

## EZ-FLIP 50/50 SPLIT CONVERTA BENCH



The EZ-Flip 50/50 Split Extenda-Deck Converta-Bench provides ample seating. It flips easily in seconds into a large rear casting deck for optimal space.



Pre-wired for optional trolling motor.

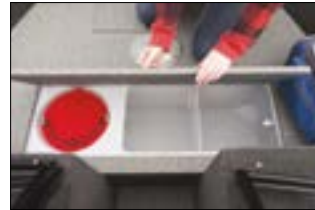

Enjoy a tournament-sized livewell with separate bait bucket.



Aft swim platform for easy boarding.



Lockable side storage fits rods up to 7'.



GPS fish/depth finder, and illuminated gauges and switches.



Bow storage. More at the stern, and throughout.

## SPECIFICATIONS

Length	<b>16'6"</b>	Hull Weight (lbs)	<b>1015</b>
Beam	<b>82"</b>	Bottom Width	<b>69"</b>
Hull Depth	<b>37"</b>	Package Length	<b>18'4"</b>
Inside Depth	<b>25"</b>	Package Width	<b>82"</b>
Aluminum Thickness	<b>0.100</b>	Towing Weight (lbs)	<b>1920</b>
Maximum Horsepower	<b>90</b>	Gas Tank	<b>Portable</b>
Maximum Capacity (lbs)	<b>1393</b>		



## Always Included

### CONSTRUCTION

- Intelliflex™ hull construction • Torsion beam energy transfer system • 3M highly reflective safety striping on Legend name • Large and practical slip-resistant side decks • Treated 7-ply marine-grade plywood floor and decks • Stainless steel transom and bow eyes • Injected and level foam floatation • 10° deep-v hull with reverse chines • .100 gauge super-thick two-piece alum. Hull construction

### CONSOLE

- High profile clear-curved walk-through windshield • Ez-reset circuit breakers, switches and gauges • Chrome-bezeled and backlit speedometer and tachometer • Deluxe passenger console with extra-large glove box • Deluxe Full-Vu™ console with woodgrain dash panels

### LIVEWELLS

- Threaded sure-lock stand pipe with overflow protection • Integrated bait bucket • 114 L aerated bow livewell

### SEATING

- EZ-Flip 50/50 split extenda-deck ConvertaBench • 2 removable ErgoMax™ swivel chairs • 4 on the floor seat base configuration

### DECKS AND STORAGE

- 5 drink holders • Rear battery storage area • Perko T-Handle flush locks and under rear seat storage • 7' starboard integral lockable rod box • Large rear casting deck with seat mount and storage • Large front casting deck with oversized storage

### ADDITIONAL

- EZ-clean dura-deck vinyl floor • Automatic bilge pump • Portable fuel tank • Pre-wired for 12v electric trolling motor • Removable navigation and anchor lights • 6 mooring cleats or handles



**ALL-IN PRICE**  
NO EXTRA FEES\*

## 16 XTE SPORT

**\$81** Per Week | **\$38,999\***



Build me!

With Mercury 60 ELPT 4S and Glide-On Trailer

### Choose Your Power

Fish/Cruise  Tube  Ski

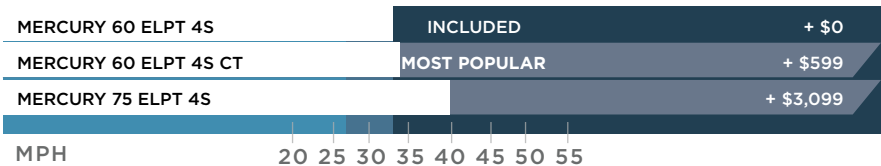

### Preferred Equipment Package

Item	VALUE:
<input checked="" type="checkbox"/> BOW CONTOURED BACKRESTS	\$849
<input checked="" type="checkbox"/> SPACE-SAVING TRAILER SWING TONGUE	\$499
<input checked="" type="checkbox"/> SWIM PLATFORM WITH FOLD DOWN STEP(S)	\$399
<input checked="" type="checkbox"/> EZ-LOAD TRAILER GUIDES	\$299
<input checked="" type="checkbox"/> DRIVER'S SEAT SLIDER	\$299
<input checked="" type="checkbox"/> 4" FISH/DEPTH FINDER	\$299
<input checked="" type="checkbox"/> 12 VOLT POWER OUTLET	\$139
<input checked="" type="checkbox"/> BIG WHEEL BACKSAVER JACK AND DOLLY	\$119
<input checked="" type="checkbox"/> 2 DELUXE ROD HOLDERS	\$79

Total Value: \$3,040. You Pay: \$0.

**The Legend Advantage: It's all included in your 16 XTE Sport Package.**



**ALL-IN PRICE**  
NO EXTRA FEES\*

## 16 XTE SPORT ULTIMATE

**\$96** Per Week | **\$46,499\***



Build me!

With Mercury 75 ELPT 4S 4S and Glide-On Trailer

### Ultimate Power Upgrade Included

Fish/Cruise  Tube  Ski

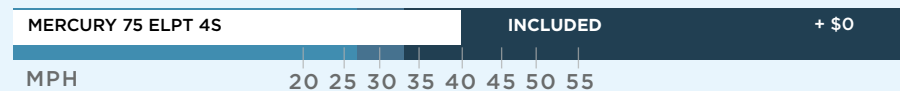

### The 16 XTE Ultimate Package which Includes:

Everything in the 16 XTE Preferred Equipment Package +

Item	VALUE:
<input checked="" type="checkbox"/> MERCURY 75 ELPT 4-STROKE	\$3,099
<input checked="" type="checkbox"/> POWERDRIVE 55/DSC/MR WITH MK BRACKET AND 60A CIRCUIT BREAKER	\$2,069
<input checked="" type="checkbox"/> BOW TO STERN COVER	\$1,199
<input checked="" type="checkbox"/> HELIX 5 CHIRP GPS G3 WITH NAVIONICS+	\$479
<input checked="" type="checkbox"/> PRO SEAT KIT	\$299
<input checked="" type="checkbox"/> 1 DEEP CYCLE BATTERY - GROUP 27	\$259
<input checked="" type="checkbox"/> TRANSOM SAVER	\$159
<input checked="" type="checkbox"/> RAM MOUNT	\$107
<input checked="" type="checkbox"/> UPGRADE TO TOW BETTER AUTO RETRACTABLE TIE DOWNS	\$36
<input checked="" type="checkbox"/> INSTALLATION OF ALL ULTIMATE PACKAGE ITEMS IF PURCHASED SEPARATELY	\$999

Total value of Ultimate Package items **\$8,705.....You Save \$1,205!**

**WE'VE GOT YOU COVERED**

<p><b>.100</b></p> <p><b>.100 Gauge</b> Perfect-Flex Aluminum</p>	<p><b>All-Welded</b> Aluminum Hull</p>	<p><b>Leakproof + 6 Year</b> For Life Warranty WOWranty</p>
---	--	---

# XTE-SERIES

## 18 XTE SPORT

### EZ-FLIP 50/50 SPLIT CONVERTA BENCH



The EZ-Flip 50/50 Split Extenda-Deck Converta-Bench provides ample seating. It flips easily in seconds into a large rear casting deck for optimal space.



Pre-wired for 12/24v optional trolling motor.



Enjoy a tournament-sized livewell with separate bait bucket.



Aft swim platform for easy boarding.



In-floor rod locker fits rods up to 7'.



GPS fish/depth finder, and illuminated gauges and switches.



Massive bow casting deck with tons of storage for all your gear and more.

## SPECIFICATIONS

Length	<b>17'6"</b>	Bottom Width	<b>76"</b>
Beam	<b>90"</b>	Package Length	<b>19'9"</b>
Hull Depth	<b>41"</b>	Package Width	<b>92"</b>
Inside Depth	<b>26"</b>	Towing Weight (lbs)	<b>2484</b>
Aluminum Thickness	<b>0.100</b>	Gas Tank	<b>95 L (25 US gal)</b>
Maximum Horsepower	<b>150</b>	Maximum Capacity (lbs)	<b>1744</b>
Hull Weight (lbs)	<b>1376</b>		



## Always Included

### CONSTRUCTION

- Intelliflex™ hull construction • Torsion beam energy transfer system • 3M highly reflective safety striping on Legend name • Large and practical slip-resistant side decks • Treated 7-ply marine-grade plywood floor and decks • Stainless steel transom and bow eyes • Injected and level foam floatation • 17° deep-v hull with reverse chines • .100 gauge aluminum hull and bow rib construction

### CONSOLE

- High profile clear-curved walk-through windshield • Ez-reset circuit breakers, switches and gauges • Chrome-bezeled and backlit speedometer and tachometer • Deluxe passenger console with extra-large glove box • Deluxe Full-Vu™ console with woodgrain dash panels

### LIVEWELLS

- Threaded sure-lock stand pipe with overflow protection • Integrated bait bucket • 114 L aerated bow livewell

### SEATING

- 2 removable ErgoMax™ swivel chairs • 4 on the floor seat base configuration • EZ-Flip 50/50 split extenda-deck ConvertaBench

### DECKS AND STORAGE

- Lockable in-floor rod locker with tube holders for 6 rods • 6 drink holders • Rear battery storage area • Perko T-Handle flush locks and under rear seat storage • 9' port and starboard integral lockable rod boxes • Large rear casting deck with dual seat mounts and storage • Large front casting deck with oversized storage

### ADDITIONAL

- EZ-clean dura-deck vinyl floor • Automatic bilge pump • 95 L built-in under-floor fuel tank • Pre-wired for 12/24v electric trolling motor • Removable navigation and anchor lights • 6 mooring cleats or handles





ALL-IN PRICE  
NO EXTRA FEES\*

## 18 XTE SPORT

**\$104** Per Week | **\$49,999\***



Build me!

With Mercury 90 ELPT 4S and Glide-On Trailer

### Choose Your Power

Fish/Cruise  Tube  Ski

Power Option	Status	Price
MERCURY 90 ELPT 4S	INCLUDED	+ \$0
MERCURY 115 ELPT 4S	MOST POPULAR	+ \$2,599
MERCURY 115 ELPT PRO XS CT		+ \$3,699

MPH: 20 25 30 35 40 45 50 55

### Preferred Equipment Package

Item	VALUE:
<input checked="" type="checkbox"/> BOW CONTOURED BACKRESTS	\$849
<input checked="" type="checkbox"/> TILT STEERING	\$599
<input checked="" type="checkbox"/> SPACE-SAVING TRAILER SWING TONGUE	\$499
<input checked="" type="checkbox"/> SWIM PLATFORM WITH FOLD DOWN STEP(S)	\$399
<input checked="" type="checkbox"/> EZ-LOAD TRAILER GUIDES	\$299
<input checked="" type="checkbox"/> DRIVER'S SEAT SLIDER	\$299
<input checked="" type="checkbox"/> 4" FISH/DEPTH FINDER	\$299
<input checked="" type="checkbox"/> 12 VOLT POWER OUTLET	\$139
<input checked="" type="checkbox"/> BIG WHEEL BACKSAVER JACK AND DOLLY	\$119
<input checked="" type="checkbox"/> 2 DELUXE ROD HOLDERS	\$79

Total Value: \$3,639 You Pay: \$0.

**The Legend Advantage: It's all included in your 16 XTE Sport Package.**



ALL-IN PRICE  
NO EXTRA FEES\*

## 18 XTE SPORT ULTIMATE

**\$122** Per Week | **\$58,999\***



Build me!

With Mercury 115 ELPT Pro XS CT and Glide-On Trailer

### Ultimate Power Upgrade Included

Fish/Cruise  Tube  Ski

Power Option	Status	Price
MERCURY 115 ELPT PRO XS CT	INCLUDED	+ \$0

MPH: 20 25 30 35 40 45 50 55

### The 18 XTE Ultimate Package which Includes:

Everything in the 18 XTE Preferred Equipment Package +

Item	VALUE:
<input checked="" type="checkbox"/> MERCURY 115 ELPT PRO XS CT 4-STROKE	\$3,699
<input checked="" type="checkbox"/> TERROVA 80/US2/IP_BT WITH MK BRACKET AND 2 60A CIRCUIT BREAKERS	\$3,049
<input checked="" type="checkbox"/> BOW TO STERN COVER	\$1,299
<input checked="" type="checkbox"/> HELIX 7 CHIRP GPS G4N WITH NAVIONICS+	\$1,049
<input checked="" type="checkbox"/> 2 DEEP CYCLE BATTERIES - GROUP 27	\$518
<input checked="" type="checkbox"/> PRO SEAT KIT	\$299
<input checked="" type="checkbox"/> MK-210D AC DUAL BANK CHARGER	\$259
<input checked="" type="checkbox"/> TRANSOM SAVER	\$159
<input checked="" type="checkbox"/> RAM MOUNT	\$107
<input checked="" type="checkbox"/> UNIVERSAL SONAR ADAPTER FOR HUMMINBIRD	\$49
<input checked="" type="checkbox"/> UPGRADE TO TOW BETTER AUTO RETRACTABLE TIE DOWNS	\$36
<input checked="" type="checkbox"/> MKR-21 AC POWER PORT (BLACK)	\$24
<input checked="" type="checkbox"/> INSTALLATION OF ALL ULTIMATE PACKAGE ITEMS IF PURCHASED SEPARATELY	\$1,490

Total value of Ultimate Package items **\$12,037.....You Save \$3,037!**

WE'VE GOT YOU COVERED

**.100 Gauge**  
Perfect-Flex Aluminum

**All-Welded**  
Aluminum Hull

**Leakproof + 6 Year**  
For Life Warranty  
WOWranty

# R-SERIES

The Legend R-Series comes with a rugged, no-nonsense type of experience.

Grab your gear, get out on the water and do your thing. No fuss, no muss. Just you, your people, your boat and the great outdoors.

R15 | R15 SC | ProSport  
Ultralite | WideBody



---

**LENGTH:**

12' - 16'

**HORSEPOWER:**

2.5HP - 50HP

**HULL WEIGHT:**

116-600 lbs



## CAST AWAY

If your top 3 priorities are fishing, angling, and casting, the R-Series is just for you.



## PERFECT FOR TROLLING

With their light construction, R-Series models are ideal for quietly trolling shallow waters.



## INCREDIBLE STABILITY

With no less than 3 external keels, fulllength Deep-V hull, lap-straked side walls, square chines, and reinforced bow ribs, the R-Series models provide as smooth a ride as any utility boat on the market.



## UNINTERRUPTED VIEWS

Let nature serenade you with loon calls, the pitter patter of fluttering wings, and the occasional fish breaching the surface for a nibble.



## GO ANYWHERE

Whether it's a 12 Ultralite or a R15, our riveted boats are designed to help you get on a plane, navigate shallow waters, and stay perfectly dry the whole time.



## TILLER VS. CONSOLE? THE CHOICE IS YOURS.

Do you like to sit back with one hand resting on the wheel? Or, do you prefer to sit up and take charge? Either way, the R-Series is here for you with 6 tiller models, 2 side consoles, and 1 full windshield model.

### WE'VE GOT YOU COVERED

**.100**

**.100 Gauge**

**Perfect-Flex Aluminum**



**Riveted-Series**

**Aluminum Hull**



**Leakproof**

**For Life Warranty**

**+**

**6YR**

**6 Year**

**WOWranty**



# R-SERIES R15



Fish and depth finder.



Store all your gear with extralarge bow storage compartments.



Enjoy a 15 gal bow livewell on this sweet front casting deck.



Spacious front casting deck.



Matching 360° swivel fishing seats.



Full windshield means fewer lost baseball caps.

## Always Included

### CONSTRUCTION

- Rear casting deck • 3M highly reflective safety striping on Legend name • Full-length deep-v hull with squared chines • Ez-grip gunnel • 7 layer, individually treated plywood floor • Injected and level foam floatation • Full-length molded splash rail • Lap-straked sidewalls • Internal lateral support ribs spaced 9" apart • Side-facing rivet line with lifetime warranty • 3 full-length .100 gauge keels • .100 gauge riveted seamless hull bottom

### LIVEWELLS

- High capacity aerator pump

### SEATING

- 4 on the floor seat base configuration • 2 utility fishing chairs

### DECKS AND STORAGE

- Rear fuel tank and battery storage area • 4 drink holders • Ez-clean dura-deck all-vinyl interior

### SAFETY

- highly-reflective safety striping

### ADDITIONAL

- Pre-wired for 12v electric trolling motor • Automatic bilge pump

# Towable. Fishable. Family friendly.



R15

**\$59** Per Week

**\$28,499\***

ALL-IN PRICE  
NO EXTRA FEES



Build me!

With Mercury 25 ELPT 4S and Glide-On Trailer

## Choose Your Power

Fish/Cruise  Tube  Ski

Power Package	Included	Price
MERCURY 25 ELPT 4S	INCLUDED	+ \$0
MERCURY 40 ELPT 4S		+ \$4,499
MERCURY 40 ELPT CT 4S	MOST POPULAR	+ \$5,099
MERCURY 50 ELPT CT 4S		+ \$6,599

MPH: 20 25 30 35 40 45 50 55

## Preferred Equipment Package

Item	VALUE:
<input checked="" type="checkbox"/> FULL STAND-UP ALL-WEATHER TOP	\$2,399
<input checked="" type="checkbox"/> SPACE-SAVING TRAILER SWING TONGUE	\$499
<input checked="" type="checkbox"/> DRIVER'S SEAT SLIDER	\$299
<input checked="" type="checkbox"/> HUMMINBIRD PIRANHAMAX 4" FISH/DEPTH FINDER	\$299
<input checked="" type="checkbox"/> 4" FISH/DEPTH FINDER	\$299
<input checked="" type="checkbox"/> BIG WHEEL BACKSAVER JACK AND DOLLY	\$119
<input checked="" type="checkbox"/> 2 DELUXE ROD HOLDERS	\$79
<input checked="" type="checkbox"/> LEGEND QUICK LATCH TIE DOWNS	\$59

Total Value: \$4,052. You Pay: \$0.

The Legend Advantage: It's all included in your R15 Package.

## SPECIFICATIONS

Length	15'1"	Hull Weight (lbs)	600
Beam	76"	Bottom Width	64"
Hull Depth	31"	Package Length	17'1"
Inside Depth	25"	Package Width	76"
Aluminum Thickness	0.100	Towing Weight (lbs)	1450
Maximum Horsepower	50	Gas Tank	Portable
Maximum Capacity (lbs)	1144		

WE'VE GOT YOU COVERED

<b>.100 Gauge</b> Perfect-Flex Aluminum	<b>Riveted-Series</b> Aluminum Hull	<b>Leakproof</b> + <b>6 Year</b> For Life Warranty	<b>6YR</b> WOWranty
--	--	---	------------------------

# R-SERIES R15 SC



Fish and depth finder.



Hide-away rod storage.



In-floor storage and livewell.



6 different spots to park your 360° swivel seats.



Convenient console switches for your nav lights, bilge pump, and livewell pump.



Pre-wired for 12V optional electric trolling motor.

## Always Included

### CONSTRUCTION

- 3M highly reflective safety striping on Legend name
- 7 layer, individually treated plywood floor
- Ez-grip gunnel
- Full-length deep-v hull with squared chines
- Full-length molded splash rail
- Side-facing rivet line with lifetime warranty
- Rear casting deck
- Injected and level foam floatation
- 3 full-length .100 gauge keels
- Lap-straked sidewalls
- Internal lateral support ribs spaced 9" apart
- .100 gauge riveted seamless hull bottom

### CONSOLE

- Ez reset circuit breakers

### LIVEWELLS

- High capacity aerator pump

### SEATING

- 4 on the floor seat base configuration
- 2 utility fishing chairs

### DECKS AND STORAGE

- Rear fuel tank and battery storage area
- 4 drink holders
- Ez-clean dura-deck all-vinyl interior

### SAFETY

- highly-reflective safety striping

### ADDITIONAL

- Automatic bilge pump



# Towable. Fishable. Family friendly.



## R15 SC

**\$53** Per Week

**\$25,499\***

ALL-IN PRICE  
NO EXTRA FEES



Build me!

Mercury 25 ELPT 4S and Glide-On Trailer

### Choose Your Power

Fish/Cruise  Tube  Ski

Power Option	Availability	Price
MERCURY 25 ELPT 4S	INCLUDED	+ \$0
MERCURY 30 ELPT 4S	MOST POPULAR	+ \$2,299
MERCURY 40 ELPT 4S		+ \$4,499
MERCURY 40 ELPT CT 4S		+ \$5,099

MPH: 20 25 30 35 40 45 50 55

### Preferred Equipment Package

Equipment	VALUE:
<input checked="" type="checkbox"/> REMOVABLE TINTED WINDSCREEN	\$699
<input checked="" type="checkbox"/> SPACE-SAVING TRAILER SWING TONGUE	\$499
<input checked="" type="checkbox"/> DRIVER'S SEAT SLIDER	\$299
<input checked="" type="checkbox"/> HUMMINBIRD PIRANHAMAX 4" FISH/DEPTH FINDER	\$299
<input checked="" type="checkbox"/> 4" FISH/DEPTH FINDER	\$299
<input checked="" type="checkbox"/> BIG WHEEL BACKSAVER JACK AND DOLLY	\$119
<input checked="" type="checkbox"/> 2 DELUXE ROD HOLDERS	\$79
<input checked="" type="checkbox"/> LEGEND QUICK LATCH TIE DOWNS	\$59

Total Value: \$2,352. You Pay: \$0.

**The Legend Advantage:** It's all included in your R15 SC Package.

## SPECIFICATIONS

Length	15'1"	Hull Weight (lbs)	570
Beam	76"	Bottom Width	64"
Hull Depth	31"	Package Length	17'1"
Inside Depth	25"	Package Width	76"
Aluminum Thickness	0.100	Towing Weight (lbs)	1420
Maximum Horsepower	50	Gas Tank	Portable
Maximum Capacity (lbs)	1000		

WE'VE GOT YOU COVERED

<b>.100 Gauge</b> Perfect-Flex Aluminum	<b>Riveted-Series</b> Aluminum Hull	<b>Leakproof + 6 Year</b> For Life Warranty	<b>6YR</b> WOWranty
--	--	--	------------------------

## R-SERIES 16 PROSPORT SC



### Always Included

#### CONSTRUCTION

• 3M highly reflective safety striping on Legend name • High-gloss oven-cured urethane exterior paint • Treated 7-ply marine-grade plywood floor and decks • Level foam floatation • Ez-grip gunnel • Stainless steel transom eyes or lift handles • Stainless steel bow eye or lift handle • Aluminum bow with integrated grab and mooring handles • Heavy-duty transom knee brace • Full-length molded splash rails • 3 full-length .100 gauge keels • .100 gauge full-width bottom ribs • Multiple .100 gauge bow ribs for maximum strength • 5° deep-v hull with hard chines • .100 gauge one-piece aluminum seamless hull bottom

#### LIVEWELLS

• Threaded sure-lock stand pipe with overflow protection • High capacity aerator pump • 45 L Livewell



#### FIND YOUR FISH.

With a standard PiranhaMAX™ 4 fish/depth finder, precisely locate your fish.



#### CRUISE YOUR WAY.

With the removable tinted windscreen, you can enjoy protection from the wind, when you choose.



#### CAST LIKE A PRO.

Designed for anglers like you, this bow casting deck is perfect for reeling in tanks.

#### SEATING

• 2 utility fishing chairs

#### DECKS AND STORAGE

• Ez-clean dura-deck all-vinyl interior • 7' port side lockable rod box • 2 drink holders • Rear fuel tank and battery storage area • Bow deck for easy electric motor installation • Large bow casting deck with oversized storage compartment

#### SAFETY

• Automatic bilge pump with float switch • Navigational lights

#### ADDITIONAL

• Pre-wired for 12v electric trolling motor

# Practical and convenient.



## 16 PROSPORT SC

**\$49** Per Week

**\$23,499\***

ALL-IN PRICE  
NO EXTRA FEES



Build me!

Mercury 25 ELPT 4S and Glide-On Trailer

### Choose Your Power

Fish/Cruise  Tube  Ski

MERCURY 25 ELPT 4S	INCLUDED	+ \$0
MERCURY 30 ELPT 4S	MOST POPULAR	+ \$2,299
MERCURY 40 ELPT 4S		+ \$4,499

MPH: 20 25 30 35 40 45 50 55

### Preferred Equipment Package

	VALUE:
<input checked="" type="checkbox"/> REMOVABLE TINTED WINDSCREEN	\$699
<input checked="" type="checkbox"/> SPACE-SAVING TRAILER SWING TONGUE	\$499
<input checked="" type="checkbox"/> HUMMINBIRD PIRANHAMAX 4" FISH/DEPTH FINDER	\$299
<input checked="" type="checkbox"/> EZ-LOAD TRAILER GUIDES	\$299
<input checked="" type="checkbox"/> BIG WHEEL BACKSAVER JACK AND DOLLY	\$119
<input checked="" type="checkbox"/> 2 DELUXE ROD HOLDERS	\$79
<input checked="" type="checkbox"/> LEGEND QUICK LATCH TIE DOWNS	\$59

Total Value: \$2,053. You Pay: \$0.

**The Legend Advantage:** It's all included in your 16 ProSport SC Package.

### SPECIFICATIONS

Length	16'2"	Hull Weight (lbs)	600
Beam	68"	Bottom Width	56"
Hull Depth	29"	Package Length	18'1"
Inside Depth	20"	Package Width	70"
Aluminum Thickness	0.100	Towing Weight (lbs)	1390
Maximum Horsepower	40	Gas Tank	Portable
Maximum Capacity (lbs)	1201		

WE'VE GOT YOU COVERED

<b>.100 Gauge</b> Perfect-Flex Aluminum	<b>Riveted-Series</b> Aluminum Hull	<b>Leakproof</b> + <b>6 Year</b> For Life Warranty	<b>6 Year</b> Warranty
--	--	---	---------------------------



## R-SERIES

# 14, 16 PROSPORT LS



### Always Included

#### 14 & 16 PROSPORT / CONSTRUCTION

• 3M highly reflective safety striping on Legend name • High-gloss oven-cured urethane exterior paint • Treated 7-ply marine-grade plywood floor and decks • Level foam flotation • Ez-grip gunnel • Stainless steel transom eyes or lift handles • Stainless steel bow eye or lift handle • Aluminum bow with integrated grab and mooring handles • Heavy-duty transom knee brace • Full-length molded splash rails • 3 full-length .100 gauge keels • .100 gauge full-width bottom ribs • Multiple .100 gauge bow ribs for maximum strength • 5° deep-v hull with hard chines • .100 gauge one-piece aluminum seamless hull bottom

#### 14 & 16 PROSPORT / SEATING

• Split vinyl-covered rear seats • 2 removable fishing chairs

#### 14 & 16 PROSPORT / DECKS AND STORAGE

• Ez-clean dura-deck all-vinyl interior • 6.5' Port side lockable rod box • 2 drink holders • Rear fuel tank and battery storage area • Bow deck for easy electric motor installation • Large front casting deck with oversized storage



#### FISH YOUR WAY.

With two removable fishing chairs and seat mounts around the boat, easily choose how you want to cast.



#### FIND YOUR FISH.

Using the standard PiranhaMAX™ 4 fish/depth finder, precisely locate your fish.



#### TRIPPING HAZARDS NO MORE.

Safely and easily store your rods with the port side lockable rod box.

#### 14 & 16 PROSPORT / LIVEWELLS

• Threaded sure-lock stand pipe with overflow protection • High capacity aerator pump • 45 L Livewell

#### 14 & 16 PROSPORT / SAFETY

• Automatic bilge pump with float switch • Navigational lights

#### 14 & 16 PROSPORT / ADDITIONAL FEATURES

• Pre-wired for 12v electric trolling motor

# Fishing, not hurdles.



## SPECIFICATIONS

Length	14'3"/16'2"	Hull Weight (lbs)	460/508
Beam	68"/68"	Bottom Width	56"/56"
Hull Depth	29"/29"	Package Length	17'1"/18'1"
Inside Depth	20"/20"	Package Width	70"/70"
Aluminum Thickness	0.100/0.100	Towing Weight (lbs)	1250/1300
Maximum Horsepower	30/40	Gas Tank	Portable/Portable
Maximum Capacity (lbs)	920/1220		

## 14 PROSPORT LS

**\$48** Per Week

**\$19,499\***

ALL-IN PRICE  
NO EXTRA FEES



Build me!

With Mercury 20 ELH EFI 4S and Glide-On Trailer

### Choose Your Power

MERCURY 20 ELH EFI 4S	INCLUDED	+ \$0
MERCURY 20 ELHPT EFI 4S	MOST POPULAR	+ \$699
MERCURY 25 ELHPT 4S		+ \$1,399
MERCURY 30 ELHPT 4S		+ \$3,399

## 16 PROSPORT LS

**\$56** Per Week

**\$22,499\***

ALL-IN PRICE  
NO EXTRA FEES



Build me!

With Mercury 20 ELH EFI 4S and Glide-On Trailer

### Choose Your Power

MERCURY 20 ELH EFI 4S	INCLUDED	+ \$0
MERCURY 20 ELHPT EFI 4S		+ \$699
MERCURY 25 ELHPT 4S	MOST POPULAR	+ \$1,399
MERCURY 30 ELHPT 4S		+ \$3,399

## 14 & 16 Preferred Equipment Package

	VALUE:
<input checked="" type="checkbox"/> SPACE-SAVING TRAILER SWING TONGUE	\$499
<input checked="" type="checkbox"/> HUMMINBIRD PIRANHAMAX 4" FISH/DEPTH FINDER	\$299
<input checked="" type="checkbox"/> EZ-LOAD TRAILER GUIDES	\$299
<input checked="" type="checkbox"/> BIG WHEEL BACKSAVER JACK AND DOLLY	\$119
<input checked="" type="checkbox"/> 2 DELUXE ROD HOLDERS	\$79
<input checked="" type="checkbox"/> LEGEND QUICK LATCH TIE DOWNS	\$59

Total Value: \$1,354. You Pay: \$0.

**The Legend Advantage: It's all included in your 14 & 16 ProSport LS Package.**

WE'VE GOT YOU COVERED

**.100 Gauge**  
Perfect-Flex Aluminum

**Riveted-Series**  
Aluminum Hull

**Leakproof + 6 Year**  
For Life Warranty  
WOWranty

# R-SERIES 14, 16 WIDEBODY



## + Add a Trailer to Your Widebody

14 Widebody: # Dub10TM - \$2,349

16 Widebody: # Dub12TM - \$2,749

More trailer options available! Contact your Memory Maker or Local Legend Dealer.

## Always Included

### 14 & 16 WIDEBODY / CONSTRUCTION

- 3M highly reflective safety striping on Legend name
- High-gloss oven-cured urethane exterior paint
- Slip-resistant and anti-glare non-skid interior paint
- Level foam floatation
- Two oar locks
- Ez-grip gunnel
- Stainless steel transom eyes or lift handles
- Stainless steel bow eye or lift handle
- Aluminum bow with integrated grab and mooring handles
- Heavy-duty transom knee brace
- Full-length molded splash rails
- 3 full-length .100 gauge keels
- Multiple .100 gauge bow ribs for maximum strength
- 5° deep-v hull with hard chines
- .100 gauge one-piece aluminum seamless hull bottom

### 14 & 16 WIDEBODY / SEATING

- Split vinyl-covered rear seats
- 2 full-width benches
- Vinyl-covered front bench

### 14 & 16 WIDEBODY / DECKS AND STORAGE

- Drop 'n' go port and starboard rod holders
- Rear fuel tank and battery storage area

### 16 WIDEBODY / LIVEWELLS

- Threaded sure-lock stand pipe with overflow protection
- High capacity aerator pump
- 38 L Livewell



Split Rear Seats



Integrated Rod Holder



# Anything but average.



Pictured with trailer, available for additional upgrade.

## SPECIFICATIONS

Length	14'3"/16'2"	Maximum Capacity (lbs)	1047/1100
Beam	68"/68"	Bottom Width	56"/56"
Hull Depth	29"/29"	Package Length	17'1"/18'4"
Inside Depth	20"/20"	Package Width	70"/70"
Aluminum Thickness	0.100/0.100	Towing Weight (lbs)	857/1040
Maximum Horsepower	30/30	Gas Tank	Portable/Portable
Hull Weight (lbs)	245/353		

## 14 WIDEBODY

**\$38** Per Week | **\$9,999\***

ALL-IN PRICE  
NO EXTRA FEES



Build me!

With Mercury 9.9 MLH 4S

### Choose Your Power

MERCURY 9.9 MLH 4S	INCLUDED	+ \$0
MERCURY 15 MLH EFI 4S		+ \$499
MERCURY 20 MLH 4S	MOST POPULAR	+ \$799
MERCURY 20 ELH 4S		+ \$1,499

14 Widebody Boat Only Price ..... \$6,999\*

## 16 WIDEBODY

**\$30** Per Week | **\$11,999\***

ALL-IN PRICE  
NO EXTRA FEES



Build me!

With Mercury 9.9 MLH 4S

### Choose Your Power

MERCURY 9.9 MLH 4S	INCLUDED	+ \$0
MERCURY 15 ELH EFI 4S		+ \$999
MERCURY 20 ELHPT 4S		+ \$2,099
MERCURY 25 ELHPT 4S	MOST POPULAR	+ \$2,899

16 Widebody Boat Only Price ..... \$8,999\*

WE'VE GOT YOU COVERED

<b>.100 Gauge</b> Perfect-Flex Aluminum	<b>Riveted-Series</b> Aluminum Hull	<b>Lifetime</b> Seam Warranty	<b>+ 6 Year</b> WOWranty
--	--	----------------------------------	-----------------------------

# R-SERIES 12, 14 ULTRALITE



## + Add a Trailer to Your Ultralite



12,14 Ultralite: # Dub10TM - \$2349

More trailer options available! Contact your Memory Maker or Local Legend Dealer.

## Always Included

### 12 & 14 ULTRALITE / CONSTRUCTION

- Riveted hull • Two oar locks • Aluminum bow and corner caps with integrated grab handles

### 12 & 14 ULTRALITE / SEATING

- 3 full-width high-mounted aluminum benches



Stainless Steel Bow Eye



Integrated grab and mooring handles

# Meet your new fishing buddy.



## SPECIFICATIONS

Length	11'9"/13'10"	Maximum Horsepower	10/15
Beam	56"/59"	Maximum Capacity (lbs)	627/700
Hull Depth	20"/20"	Gas Tank	Portable/Portable
Aluminum Thickness	0.050/0.050	Hull Weight (lbs)	112/130

## 12 ULTRALITE

**\$23** Per Week | **\$5,899\***

With Mercury 2.5 MH 4S

ALL-IN PRICE  
NO EXTRA FEES



Build me!

### Choose Your Power

MERCURY 2.5 MH 4S	INCLUDED	+ \$0
MERCURY 4 MH 4S		+ \$599
MERCURY 6 MH 4S	MOST POPULAR	+ \$899
MERCURY 9.9 MH 4S		+ \$2,299

12 Ultralite Boat Only Price ..... \$4,699\*

## 14 ULTRALITE

**\$25** Per Week | **\$6,499\***

With Mercury 2.5 MH 4S

ALL-IN PRICE  
NO EXTRA FEES



Build me!

### Choose Your Power

MERCURY 2.5 MLH 4S	INCLUDED	+ \$0
MERCURY 6 MH 4S		+ \$899
MERCURY 9.9 MH 4S	MOST POPULAR	+ \$2,299
MERCURY 15 EH EFI 4S		+ \$3,199

14 Ultralite Boat Only Price ..... \$5,299\*

WE'VE GOT YOU COVERED

**Riveted-Series**  
Aluminum Hull

**Lifetime**  
Seam Warranty

**6YR**  
+ 6 Year  
WOWranty



# Legendary Strength.

## Legend .100 Gauge Hull

While most aluminum boat companies use .058 to .090 gauge thickness on comparable models, our .100 gauge hulls are up to 73% thicker! With a super-thick .100 Gauge seamless hull bottom, your Legend boat will last longer with no potential for centre-seam leaks. While our .100 Gauge hulls provide unmatched thickness, our use of 5052 H34 cold-rolled aluminum provides the best combination of flexibility and strength.

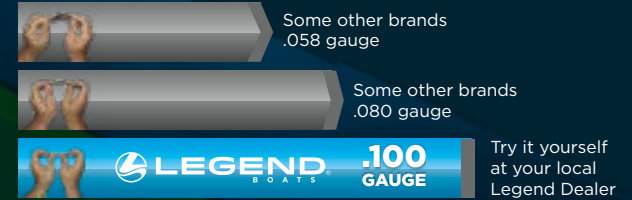

## All-Welded Series Construction

### All-Welded Series Transferable Warranty

Every Legend All Welded Series model carries our industry leading Leakproof for Life Warranty. It is remarkably simple: it covers the entire structure of the hull against leaks through the hull for as long as you own the boat. Our exciting WOWranty extends coverage on all of our key components such as decking with a Lifetime Warranty against rotting and warping.

### Intelliflex Hull Construction

Flexes and adapts to the water by dissipating energy from waves evenly throughout the hull, eliminating any chance of problem areas developing over time.

### Exclusive Comfort Ride Deep-V hull

Provides a dry, smooth and comfortable ride each and every time in all conditions provided by our sharply angled bow, deep V and reverse chines.

### 2-Piece Hull with No Side Seams

Eliminates a common weak area that causes side seam leaking on other welded boats.

### Injected Level Flootation

Not only will every Legend float even when filled with water, the injected foam creates a solid sub-floor bond that strengthens the boat and provides a silky smooth and quiet ride. Foam is injected halfway up the side-wall for extreme strength. Knock on it and see!

### Thick Lifetime Decking

With a Lifetime Warranty against rotting or warping and delamination. A thicker floor with 7 individually treated layers means a stronger boat.

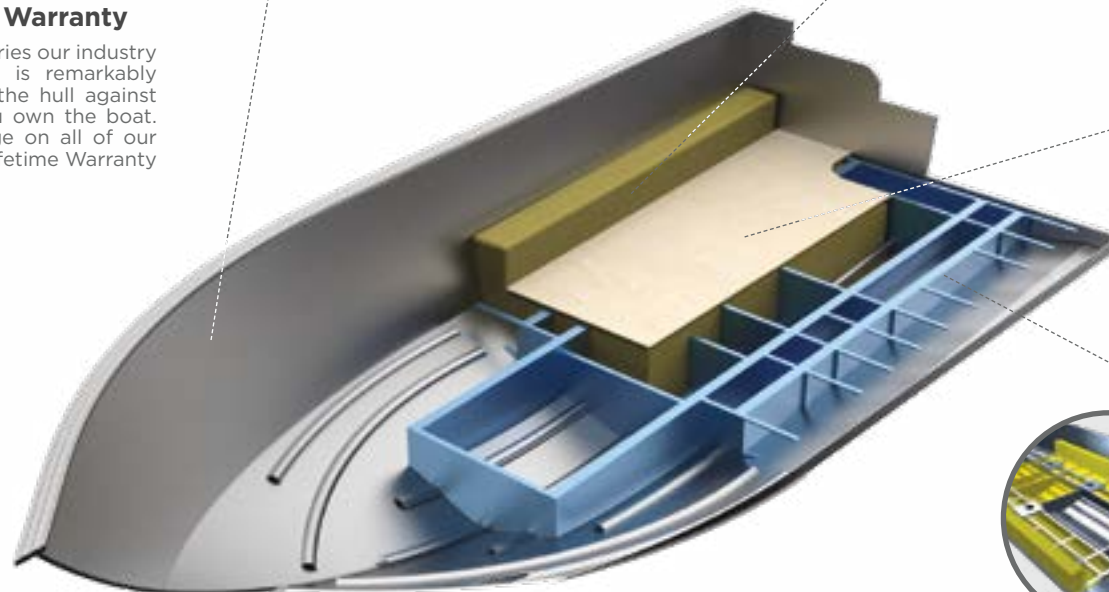

### Torsion Beam Energy Transfer System

Provides your boat with necessary flexing, while remaining light and strong.

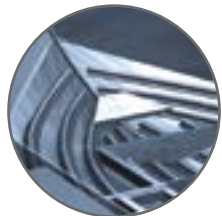

### Interlocking Bow Ribs

Overlap the front torsion system, eliminating a common weak point on most other aluminum boats.



### Reverse Angled Chines

Are bottom side edges that angle downward to create lift in the back for faster planing and increased stability.

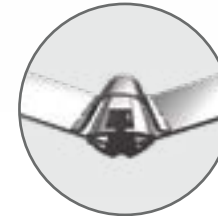

### Solid Locking Extrusions

Hold each thick hull piece into a solid center for unmatched durability. The center extrusion is over one inch thick providing an extremely solid 1,054 gauge impact zone. This means over 5 times the protection of double plated hulls.

## H34 PerfectFlex

Legend's H34 PerfectFlex aluminum has the perfect balance of strength and flexibility. Although H36 is harder, it is also more brittle. Its strength is reduced by over 80% when stressed during manufacturing or when flexed on the water. In fact, when stressed, H34 PerfectFlex is tested to be more than 2.5 times stronger than H36, making it the ultimate hardness for .100 gauge aluminum boat manufacturing.

Strength Under Pressure (PSI's)



H34 aluminum is tested to be more than 2.5 times stronger than H36, making it the ultimate hardness for aluminum boat manufacturing.



The NMMA Certified label on a Legend boat is your proof that it meets, and often exceeds, the industry's strictest quality and safety standards.

## R-Series Construction

### R-Series Transferable Warranty

Each R-Series Riveted model has a Lifetime main seam hull warranty and an amazing 10 year warranty on most other hull components. Our exciting WOWranty extends coverage on all of our key components such as decking with a Lifetime Warranty against rotting or warping.

### Full-Length Molded Splash Rail

Deflects water away from the boat interior, providing a dry, comfortable ride. Fishing lines are able to slide along the hull edge smoothly where this rail is riveted on.

### Full-Length Deep-V Hull with Squared Chines

Provides a smooth and comfortable ride while keeping the hull stable so you can move around without it feeling tippy.

### Extra-Wide EZ-Grip Gunnel

Makes holding the boat while getting in or out very easy and increases the overall strength of the hull.

### Lap-Stracked Side Walls

Full-length ridges pressed into the sidewall reduce flex and make for a stronger and sturdier boat.

### Thick Lifetime Decking

With 7 layers, each individually treated, we can offer a Lifetime Warranty against rotting or warping.

### Injected and Level Foam Floatation

Provides a stronger, quieter and safer boat. If filled with water, the boat will not flip or sink, even when loaded to capacity.

### Internal Lateral Support Ribs Spaced 9" Apart

Gives you more ribs closer together creating greater support and strength.

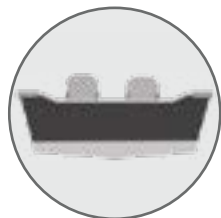

### 3 External Keels

Provide stability, solid cornering and car-bumper-like protection from underwater obstacles.



### Side-Facing Rivet Line with Lifetime Warranty

Reduces exposure to side seam stress in comparison to a bottom-facing rivet line.

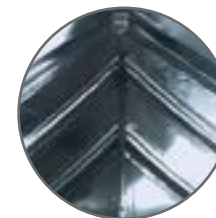

### Reinforcing Bow Ribs Attached to Transverse Rib

Are reinforced with .100 gauge aluminum that eliminates a common weak area found in the front of most boats.



# All-Weather Protection

Everyone should have protection, especially if it extends your season.

Being Canadian, we understand the harsh reality of the Canadian climate. That's why the preferred equipment package for almost every full windshield Legend model † includes the industry's toughest, most practical stand-up top, constructed with Legend's ProTech material. You'll be more comfortable, warmer and dryer regardless of what Mother Nature throws your way.

## Front Aerodynamically Matched to the Windshield

Reduces wind resistance at high speeds on the water, which increases fuel efficiency and allows for full throttle performance with the top up.

## All Snaps Are Installed Through Thick Legend ProTech Material

Our strong material provides a solid fastening point as opposed to plastic, which snaps could tear through easily.



## Rear Angled Support Bar

Much stronger than a strap, it adds greatly to the overall strength of the top and allows for the top to be stored in an arch out of the way.



## Three Bar 7/8" Tubular Frame

Our tubing is thicker and therefore stronger than industry standards. A third centre bar keeps the top in an arched formation preventing sag at any speed on the water.

## Weather-Resistant Design

Helps to reduce wind and water from entering the boat, keeping you warm and dry.



## Full Stand-Up Design That Works at Full Speed On the Water

Allows for comfortable upright maneuvering in the boat with no need to take it down even at high speeds on the water.

†Full top optional on the 16 XTE Sport & 18 XTE Sport model. Never use while trailering. Not for highway use or winter storage.



## Extra-wide Double-Zippered walk through with window

The walk-through window opens fully to allow for easy passage and allows visibility even when closed.

## Double-Stitched Zippers

Provide lasting quality in areas that receive the most stress.



## Pull-A-Dot Snaps

Used in strategic areas, they are a specially designed locking snap that keeps your top securely fastened.

## All-Metal Fittings

Unlike plastic fittings, metal ones are less likely to crack, break, or wear out.



**5+1 Year**  
Canvas Warranty

## Legend ProTech Tear and Mildew-Resistant Synthetic Material

Backed by a 5 year warranty, it is guaranteed not to rot or fade and will resist tearing, even if punctured. Stitching, zippers, seams and other top components are covered for 1 year.



# Legend Glide-On Trailers

Quality is the reason we choose Shoreland'r as the exclusive supplier for our Legend custom-matched Glide-On trailers. A high quality trailer means a high quality boating experience from loading and unloading to highway driving.

## ShoreArm'r Paint

Our premier ShoreArm'r Black powder coat paint is a textured matte black coating. It is applied electrostatically and baked on for a chip resistant heavy-duty finish.

## Self-Lubricating Bearing Buddies

Automatically injects grease to the bearing resulting in less wear.

## Space Saving Swing Tongue

This feature reduces storage length as much as 24" making it easier to fit in a garage and helps prevent shin smashing.

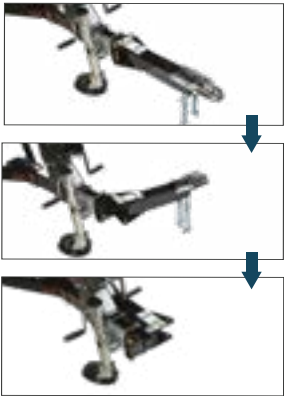

## Enclosed Custom-Moulded Fenders

Non-corroding and dent-resistant, they protect your boat from road debris and provide a safe, solid step.



## Lights With Rear Built-In Step

Reliable, submersible lamp service while the step protects the tail lights and allows access to the boat.

## Each Light Has Its Own Power Source and Ground Wire

Keeps your lights bright and working at night, even if one goes out.



## Adjustable 2" Ball Safety Coupler with Locking Pin

The coupler easily adjusts for greater hold and the pin prevents release while travelling.



## Heavy-Duty Nylon Winch Strap

The threaded seam is protected from the elements with a 3' loop that eliminates stress on stitching.



## Self-Centering Carpeted Bunk Design

Launching and loading are made effortless. The boat loads straight, stops easily and is supported over its full length for even weight distribution. Larger models have quad banks for even more support.

## Extra-Long Safety Chains with Locking Clips

Secure safety chains will not tangle or kink like cables. Easily reaches most vehicles and clips prevent unlatching during travel.

## Reverse-Angled Winch Stand with Oversized Rubber Roller

Holds the bow in place during transport preventing unwanted forward movement and safely stops the boat when loading.

## Contoured Padded Cross Members and Lower Axle

The boat sits lower, providing a more stable centre of gravity which allows for launching and loading in shallower water.

**5+1 Year**

Legend Glide-On  
Trailer Warranty

## Welded Tubular Steel Frame

Strong, clean construction with less bolts to worry about, plus the tubular design provides protective housing for wiring. This is by far the best frame in the industry, covered by the best warranty; a 5-year frame warranty and 1-year complete tongue to tail light warranty.

# Trailer, Covers & Accessories

## Bow to Stern Cover

Our custom-fit bow to stern mooring cover provides complete protection for your Legend boat. Protect your investment and keep your boat looking new. (Not for winter storage)

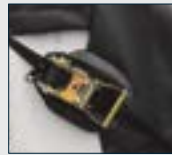

### Quick and Easy Ratchet System

Just slide the cover over top of your boat, tighten up the ratchet and you're done. It's that easy!



### Multi-vent Air Circulation System

Vents humidity to let your boat dry quickly.



14' + 16' WideBody and ProSport **\$999**  
 15' + 16' **\$1,199** | 17' + 18' **\$1,299** | 19' + 20' **\$1,499**

Prices vary by model and size  
**Plus installation (Approx. 1 hour)**

## Bimini Top

Designed for our side console and utility models, this custom-fit top provides protection from the hot sun and rain. It is constructed from Legend ProTech fabric and an all-aluminum frame and includes a convenient bimini boot.

# BTB-68 **\$1,149**  
 For boats up to 76" wide

# BTB-90 **\$1,199**  
 For boats 80" to 92" wide

**Plus installation (Approx. 1.5 hour)**



## Legend Motor Covers

Protects the engine cowling, lower unit, and propeller during transport or storage.

30HP or less **\$359**  
 40HP - 60HP **\$399**  
 75HP - 115HP **\$499**  
 150HP - 200HP **\$549**

## Rock Shield

Offers the best protection from rocks/gravel providing the ultimate boat protection.



# TOWBETTER ROCK SHIELD



## Spare Tire Carrier Starting \$199

# TA1038-00 2"x3" Frames

Spare Tire Carrier provides a safe and secure way to keep a replacement trailer tire assembly on hand when you need it.

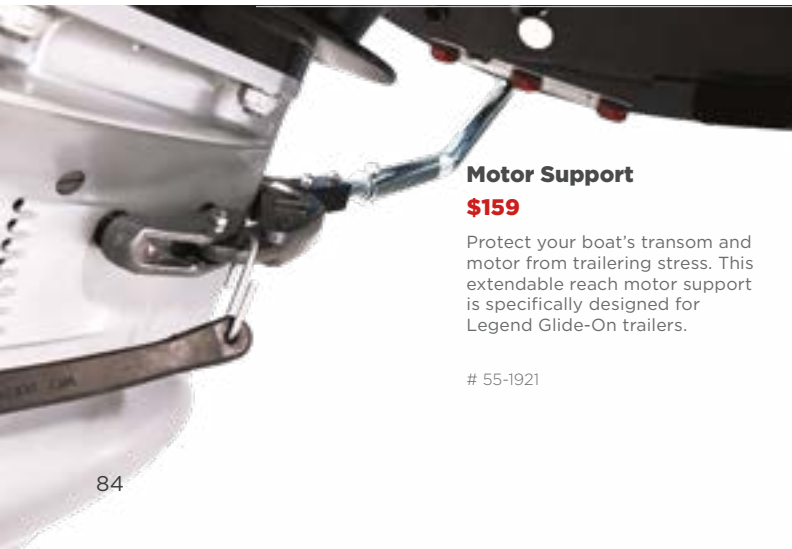

## Motor Support

Protect your boat's transom and motor from trailering stress. This extendable reach motor support is specifically designed for Legend Glide-On trailers.

# 55-1921

## Spare Tire and Rim

Don't be left stranded. Having a spare tire will give you peace of mind on your travels to and from the lake.

12" **\$189 to \$239**  
 13" **\$369 to \$499**  
 14" **\$459 to \$499**



## Legend Quick Latch Tie Downs (pair)

Our tie downs are quick, easy to use, super-strong and secure your boat safely to your trailer.

# BTDTP3B



# Seating



## ErgoMax Reclining Captain's Chair **\$1,599**

For those who want only the best. This ultra-comfortable recliner features built-in suspension, a slider, 8" post, adjustable headrest and dual flipping armrests.

- Wood-Free
- Spring-Loaded Suspension
- Flipping Armrests
- Adjustable Headrest
- 18 Recline Positions
- Seat Slider
- Pinchless Hinges

# ERGOMAX RECLINER KIT

# ERGOMAX RECLINER KIT COGNAC



## ErgoMax Swivel Chair **\$749**

Ergonomically designed to deliver maximum comfort with larger seating surfaces, integrated hand grips for stability, and a clean look in the 'closed' position. Includes a seat mount and post.

- Wood-Free
- Invisible Hinges
- Ergonomically Designed For Extreme Comfort
- Larger Seating Surface
- Folds Flat For A Cleaner Surface

# ERGOMAX SEAT KIT

# ERGOMAX SEAT KIT COGNAC



## Seat Slider **\$299**

This slider has a gear tooth lock mechanism, locks solidly, disengages easily and rides smoothly on acetal linear bearings.

# 35600281



## Utility Fishing Chair **\$549**

With an all composite frame and pinchless aluminum hinges, this comfortable chair includes a seat mount and post.

- WOOD-FREE
- PINCHLESS HINGES

# UTILITY SEAT KIT OZONE



## Pro Seat **\$299**

Allows for excellent stand-up casting positions. Includes: Pro Seat, auto-locking seat mount and extra-long 25" post.

- COMPACT DESIGN

# PRO SEAT KIT GREY



## Bow Cushions **\$999**

Add bow cushions to your 16 XTE Sport, 18 XTE Sport, 16 XTR, 18 XTR, 18 XTR Troller or 20 XTR Troller for ultimate comfort on the water.



## TowBetter Auto Retractable Tie Downs (Pair) **\$95**

It includes a retractable ratchet with a load capacity of 8330 pounds. Retracts for convenient storage and will not tangle. Making for a quick and easy bolt-on installation.

# TBARTD



## Wheel Chocks (Pair) **\$59**

TowBetter Heavy Duty Wheel Chocks (2) - The Only Wheel Chocks You Will Ever Need. Suitable for Boat Trailers, RVs, Cars, and Trucks. Durable, Non-slip, High Visibility, Built-in Molded Grab Handle.

# FST001P





# Fun & Safety

## Legend Life Jacket 4 Pack

**\$159**

Universal Legend Blue life jackets, one size.

# LEGEND-PFDBUNDLE



## Legend Oversized Fender Kit **\$209**

Everything you need to get started including:

- 1 x Legend Key Float
  - 4 x Double Braided Fender Line - 1/4" x 6'
  - 3 x Legend Ribbed Fender - 8.5" x 27"
- # DECK BOAT OVERSIZED FENDER KIT



## Legend Fender Kit **\$79**

Everything you need to get started including:

- 3 Legend 5"x20" Fenders
  - 3 Fender Loops
  - 1 Legend Key Float
  - 1 Legend Bag
- # LEGEND FENDER KIT BLACK



## Package of 6 nylon fender cleats

**\$109** installed  
# H-00007-B

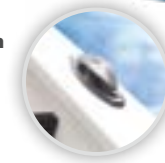

## Deluxe Safety Kit **\$349**

Everything required by Transport Canada for boating on most lakes.

**Total Value \$378** # DELUXE SAFETY KIT

### BUY THE PACKAGE AND SAVE **\$29**

#### Package includes:

- 4 Universal Legend Life Jackets
- 50 ft Buoyant Heaving Line
- Fire Extinguisher
- 2 Mooring Lines
- Safety Whistle
- Waterproof Flashlight
- 10 lb Anchor with 50 ft Rope
- Telescopic Paddle
- Bailing Bucket

See the Transport Canada Safe Boating Guide for your safety requirements.

**ABC123** **ABC123**  
**ABC123** **ABC123**

## Custom Boat Numbers **\$129**

Colour-matched to suit any Legend model, these durable vinyl number and letter packages are easy to install and allow a variety of number and letter combinations. Our numbers meet Transport Canada's regulations for vessel license number display.

Talk to your dealer for more information.

## Boat Starter Kit **\$449**

In all the excitement of buying a new boat, you may have forgotten some essential accessories. We've packaged together everything you need to begin the boating lifestyle safely and comfortably.

**Total Value \$557** # STARTER KIT - BOATS

### BUY THE PACKAGE AND SAVE **\$108**

#### Package includes:

- Deluxe Safety Kit
- Legend Fender Kit
- Custom Boat Numbers

## Swim Platform **\$399**

Access to the water for a quick swim and the ability to climb back on board is made easy with this fixed-handle platform and fold-down steps.

# 2STEPSSWIM



**ABC123** **ABC123**

# Electric Motors & Accessories

## VesselView Mobile<sup>+</sup>

**\$378.50** plus installation (Approx. 0.5 hours)

**Get Connected.** Now you can have the power of SmartCraft on your mobile device (iOS or Android) with all the digital data your SmartCraft engine supports! Connect to your engine, and get easy access to maintenance reminders, performance information and diagnostic information. The VesselView Module easily connects to your Mercury outboard.

# 8M0115080

\*May require optional Data Cable **\$139** and additional labour.

# 879981T20



### Key Features

- Connects your Mercury engine (all SmartCraft-capable engines built since 2003 [40 HP and up]) to your iOS® or Android® mobile device via BLE (Bluetooth® Low Energy 4.0).
- See engine data: fuel flow, water temperature, battery voltage, RPM, engine hours.
- Get fault code diagnostic information in clear language so you know what it means, and understand if that fault is something to be addressed when you return back to the dock or it is something more significant.
- Get mapping information and quick access to points of interest such as fuel or restaurants.
- Access the Mercury Dealer Locator and set your Preferred Dealers.
- View handy checklists associated with your boating lifestyle.
- Receive maintenance reminders and keep a maintenance log.
- Supports up to 22 different languages.



### Analog Troll Control Kits

**\$407** plus installation (Approx. 1.5 hours)

A troll control option for boats with traditional, analog gauges from 40 hp and up. This easy-to-install kit can make controlling the boat/engine speed easy with the push of a button. Adjusts speed by 10 RPM up to 1,000 RPM. Also available without "Y" harness for installations with SmartCraft.

**Analog # 8M0083439 Data cable # 879981T20**



### ROKK Wireless Charger - Edge

**\$269** plus installation (Approx. 1.5 hours)

Edge securely holds and wirelessly charges your phone even in the toughest outdoor conditions. Now you can keep your phone in sight, fully charged and ready to go.

# SC-CW-05F

\* Installation, freight and taxes extra on all prices. Prices and specifications are subject to change or error. Ask your local Legend dealer for complete details.



### TALON

WHEN YOU FIND THE RIGHT FISHING SPOT, TIME IS CRITICAL.



BLACK, SILVER: 10", 12" or 15"



BLUE, RED, WHITE: 10" or 12"

The Talon anchor system offers versatile control options, allowing users to manage it through a Control Panel, Wireless Remote, Foot Switch, i-Pilot, i-Pilot Link Remote, One-Boat Network Mobile App, or directly from a Humminbird fish finder.

**Starting at: \$2,820**  
plus installation\* (Approx 1.5hrs)



# 1358201



### MEGA LIVE IMAGING

**Starting at: \$2,100**  
plus installation\* (Approx 1.5hrs)

# 710304-1

Let your trolling motor point the way to structure and fish. Mountable on your trolling motor or pole mount system, MEGA Live Imaging™ Trolling Motor Control shows you real-time views.



### LiveScope™ Plus System

with GLS 10™ and LVS34 Transducer

**Starting at: \$2,295**  
plus installation\* (Approx 1.5hrs)

# 010-02706-00

The latest in LiveScope technology, the LiveScope Plus System offers improved resolution, reduced noise, clearer images and better target separation.





# More Accessories

## Cannon Mounting Tracks



**18" Cannon Mounting Track**  
**\$99** plus installation\* (Approx .5hrs)  
 # 1904027



**12" Cannon Mounting Track**  
**\$89** plus installation\* (Approx .5hrs)  
 # 1904026



**6" Cannon Mounting Track**  
**\$69** plus installation\* (Approx .5hrs)  
 # 1904025

## Ram Mount Kit Helix 5 & 7

Ram Ball Universal Mount  
 With 6-1/4" X 2" Plate,  
 1-1/2" Ball

**\$107**  
 plus installation\* (Approx .5hrs)  
 # 170-RAMIII



## Ram Mount Kit Helix 9

This powder-coated, marine-grade aluminum Hummingbird mount consists of a short length double socket arm, a 3.68" diameter round base with a 2.25" size ball, and a 1.5" x 4.5" rectangular plate with a 2.25" D size ball.

**\$160**  
 plus installation\* (Approx .5hrs)  
 # 1895113



## Cannon Magnum 10 STX Package with a power point, pedestal and 18" track.

Take Command of controlled-depth fishing when you equip your boat with the latest downrigger technology. Whether you're trolling the great lakes or fishing a remote lake. Let us help you get your lure in the strike zone and keep it there!

**\$1,199**  
 plus installation\* (Approx 2hr)  
 # MAGNUM PACKAGE



# 1902305 # 1903012



# 1904031 # 1904027

## Cannon Magnum 10 STX Electric Downrigger

The Magnum 10 STX features the fastest retrieval rate on the market (250 feet per minute) and a Short-Stop feature that protects the boat from swinging weight. Includes mounting base, low-profile swivel base, and a telescopic stainless steel boom that extends from 24" to 53". Magnum is built tougher and smarter to make you a better angler. Cannon Edge Design features fewer moving parts, one-piece composite construction, a redesigned boom end, protected circuit boards, and easy access to the spool, switches, plugs and mounting knobs.

## 6" Raised Aluminum Pedestal with 18" Mounting Track†

This sturdy pedestal mount slides into the mounting track. The track allows your downrigger to slide forward and back while the 6" pedestal raises it to a comfortable height to work on.

†May be required for proper downrigger installation on select boat models.

## Legend - Minn Kota Battery Charging Systems

Charge your deep cycle batteries without having to remove them. Choose to charge your batteries using 110V AC, 12V DC or both. With the AC charging kits, simply run an extension cord to your boat and plug it into the included charger panel. For DC charging, simply running your main engine extends your deep cycle battery's charge.

### Single Bank Charger



# 1865108 # 1821065

MK-106D on-board AC battery charger with power port

**\$179** plus installation\* (Approx 1.5hr)

# SBCK



### Dual Bank Charger



# 1865108 # 1822105

MK-210D on-board AC battery charger with power port- 2X5AMP

**\$279** plus installation\* (Approx 1.5hrs)

# DBCK

### Precision Charger



# 1865108 # 1832201

MK 220 PCL Dual Bank Precision Charger

**\$469** plus installation\* (Approx 1.5hrs)

# PBCK



ALL-NEW

# QUEST™ SERIES

The new QUEST series of dual 24/36 volt brushless trolling motors was designed for anglers who demand the best from their equipment - even in the harshest environments. With a reinforced motor and mount, more advanced GPS functionality than ever and even an eco mode to extend battery life, the next generation of Terrova is designed to have your back out on the water for years to come.



**2**  
YEAR  
WARRANTY

UNLOCK MORE BOAT CONTROL THAN EVER BEFORE.

## TERROVA 90/115/DSC/WR QUEST

Thrust, 60" Shaft, Dual Spectrum CHIRP Sonar, Wireless Remote and foot pedal  
Includes quick release bracket and x2 60A breakers.

**\$5,329** plus installation\* (Approx 1.5hrs)  
# 1358201

## ULTERRA 90/115/DSC/WR QUEST

Thrust, 60" Shaft, Dual Spectrum CHIRP Sonar, Wireless Remote and foot pedal  
Includes quick release bracket and x2 60A breakers.

**\$6,179** plus installation\* (Approx 1.5hrs)  
# 1358541



## TERROVA 55/DSC/WR

Terrova 55 lb. Thrust, 54" Shaft, Dual Spectrum CHIRP Sonar, Wireless Remote and foot pedal

Includes quick release bracket and a 60A breaker.  
**\$2,919** plus installation\* (Approx 1.5hrs)  
# 1358356

## TERROVA 80/DSC/WR

Terrova 80 lb. Thrust, 60" Shaft, Dual Spectrum CHIRP Sonar, Wireless Remote and foot pedal  
Includes quick release bracket and x2 60A breakers.

**\$3,479** plus installation\* (Approx 1.5hrs)  
# 1358382

Upgrade to bow panel with 24 Volt Plug **\$549**  
# 34604826

Universal Sonar Adapter for Humminbird **\$49**  
MKR-US2-8 7-Pin Adapter Cable  
# 1852068

## Advanced GPS Navigation Wireless Remote

Waterproof remote is lightweight with intuitive user menus and simplified keypad with four customizable One-Boat Network buttons, three on the keypad and one side button.  
# 1866655



\* Installation, freight and taxes extra on all prices. Prices and specifications are subject to change or error. Ask your local Legend dealer for complete details.



### HELIX 5 CHIRP GPS G3

If fishing is in your DNA, there's no such thing as "too early" or "too far." The HELIX® 5 Series answers the call with an uncompromising 5" widescreen, color display. This HELIX 5 CHIRP GPS G3 model features Dual Spectrum CHIRP 2D sonar, internal GPS with Humminbird Basemap and AutoChart Live built-in, with additional compatibility for Humminbird and Navionics premium fishing charts.

\*Ram Mount may be required for fishfinder installation.

**\$479** plus installation\* (Approx 2hrs)

# 411660-1

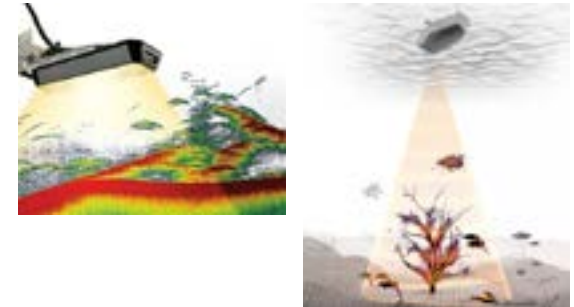

### HELIX 7 CHIRP MEGA DI GPS G4N Mega Down Imaging Sonar GPS

Features MEGA Down Imaging, Dual Spectrum CHIRP Sonar, AutoChart Live, Internal GPS and Humminbird Basemap built-in. An upgraded high-definition 7" display will give you the best view of the many pre-loaded split screen view options so that you'll never miss a fish. All HELIX 7 G4N models support Ethernet networking, Bluetooth(R), NMEA 2000(R), Wi-Fi and are compatible with the One-Boat Network(TM).

\*Ram Mount may be required for fishfinder installation.

**\$1,079** plus installation\* (Approx 2hrs)

# 411640-1

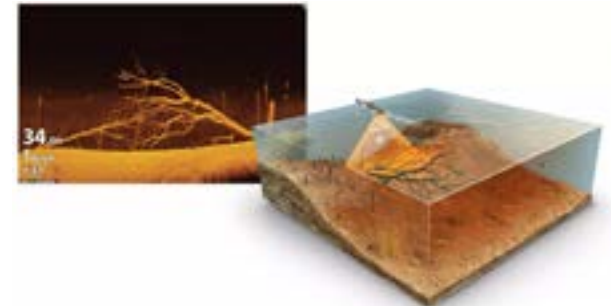

### HELIX 9 CHIRP MEGA SI+ GPS G4N Mega Side Imaging+

The HELIX 9 CHIRP MSI+ GPS G4N features a 9" display, MEGA Side Imaging+, MEGA Down Imaging+, Dual Spectrum CHIRP Sonar and internal GPS with Humminbird Basemap. As with all HELIX G4N models, this HELIX 9 includes standard features such as AutoChart Live, Wi-Fi and NMEA 2000®, in addition to Bluetooth® and Ethernet networking for compatibility with the One-Boat Network™ family of products from Humminbird, Minn Kota and Cannon.

\*Ram Mount may be required for fishfinder installation.

**\$2,309** plus installation\* (Approx 2hrs)

# 411380-1M

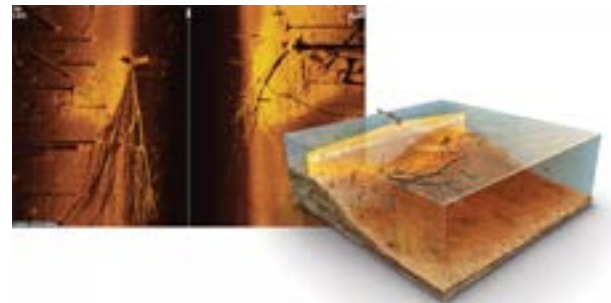

### NAVIONICS+ CARD \$225 # 010-C1367-30

Simply plug the chip into any PC/Mac and download 2D chart content for marine areas and lakes plus receive a 12 month subscription to Freshest Data which includes: free daily chart updates, Community Edits, Sonar Charts and more. Choose coverage areas from Gold and HotMaps Premium charts North America and download only the necessary areas.



# GARMIN.



## **ECHOMAP™ UHD2 55cv, With GT20-TM Transducer**

**\$630** plus installation\* (Approx 2hrs) # 010-02592-50

Experience fishing like a local pro with the Garmin ECHOMAP™ UHD2 5" cv chartplotter. The device features a bright 5-inch display, Garmin CHIRP traditional and ClearVü scanning sonars, and vivid color palettes for high-contrast underwater views. Built-in Garmin Navionics+™ mapping ensures confident navigation, and wireless networking allows seamless information sharing with other compatible Garmin chartplotters. The ActiveCaptain® app provides convenient access to OneChart™, software updates, and Garmin Quickdraw Community data for a comprehensive fishing experience.



## **ECHOMAP™ UHD2 75sv, With GT54-TM Transducer**

**\$1,460** plus installation\* (Approx 2hrs) # 010-02686-00

Unleash precision fishing with the Garmin ECHOMAP™ UHD2 7 sv. Featuring clear traditional sonar, brilliant ClearVü and SideVü scanning sonars, and LiveScope™ compatibility, this device leaves no room for fish to hide. High-contrast vivid scanning sonar color palettes enhance underwater visibility. Garmin Navionics+ cartography, wireless networking, and the ActiveCaptain® app with Wi-Fi® connectivity offer advanced fishing strategies, seamless chartplotter information sharing, and on-the-go access to OneChart™, smart notifications, software updates, and Garmin Quickdraw™ Community data.



## **ECHOMAP™ UHD2 95sv, With GT56UHD-TM Transducer**

**\$1,810** plus installation\* (Approx 2hrs) # 010-02690-00

Elevate your fishing experience with the Garmin ECHOMAP™ UHD2 9 sv. The advanced GT56UHD-TM Transducer ensures unparalleled clarity. The Ultra High-Definition ClearVü sonar provides vivid image clarity at greater depths, and the Ultra High-Definition SideVü offers 20% greater range at 1,000 kHz. High-contrast scanning sonar color palettes simplify target and structure identification. LiveScope™ sonar and wireless networking enable comprehensive fish tracking and seamless information sharing with compatible ECHOMAP UHD2 chartplotters. Stay connected on-the-go with the ActiveCaptain® app, offering OneChart™ access, smart notifications, software updates, Garmin Quickdraw™ Community data, and more via built-in Wi-Fi® connectivity.

\*Ram Mount may be required for fishfinder installation.



GARMIN.

# FORCE®

FISH WITH FORCE



## Force® Trolling Motor 80lb 24v/100lb 36v 57"

Get on fish faster, and stay on the water with the most powerful, most efficient trolling motor available – and it's quiet, too.

Includes bracket and x2 60A breakers.  
Warranty: 3yr limited lifetime on shaft.

**\$5,215** plus installation\* (Approx 2hrs) #010-02025-00



# KRAKEN®

THERE'S A NEW LEGEND TO BEHOLD



BOTH INCLUDE



Wireless remote

## Kraken® Trolling Motor 80lb 24v/100lb 36v 63"

The Force Kraken trolling motor is engineered with a longer shaft for boats with high freeboards and a pivot-style mount for easy installation in vessels where bow space is limited.

Includes bracket and x2 60A breakers.  
Warranty: 3yr limited lifetime on shaft.

**\$5,285** plus installation\* (Approx 2hrs) #010-02573-00

### Quick Release Bracket

**\$167** plus installation\* (Approx 0.5hrs)



#010-12832-60

## Tech Package #1 **\$2,699\***

plus installation\* (Approx 2hrs)  
Requires one optional Deep Cycle Battery.

Get the basics covered. The perfect package for the angler wanting to level-up their time on the water.

### INCLUDES:

- POWERDRIVE 55/DSC/MR
- Helix 5 Chirp GPS G3
- Ethernet Adapter Cable
- 30' Ethernet Cable
- Ram Ball Universal Mount
- Navionics+ Canada Chip
- Quick Release Bracket
- 60A Circuit Breaker



#TECHPACKAGE1

## Tech Package #2 **\$3,999\***

plus installation\* (Approx 2hrs)  
Requires two optional Deep Cycle Batteries.

You're a regular! This package is for the angler looking to make make their time on the lake an every weekend kinda' thing.

### INCLUDES:

- TERROVA 55/DSC/WR
- HELIX 7 CHIRP GPS G4N
- Ethernet Adapter Cable
- 30' Ethernet Cable
- Ram Ball Universal Mount
- Navionics+ Canada Chip
- Quick Release Bracket
- 60A Circuit Breaker



#TECHPACKAGE2



## Tech Package #3 **\$4,999\***

plus installation\* (Approx 2hrs)  
Requires two optional Deep Cycle Batteries.

More than a hobby. This package is going to gear you up to be tournament-ready and guarantees to awe your passengers with every catch.

### INCLUDES:

- TERROVA 80/MDI/WR 60"
- HELIX 7 CHIRP MSI GPS G4N
- Ethernet Adapter Cable
- 30' Ethernet Cable
- MKR-MI-1 Adapter
- MKR-MDI-2 Adapter
- Ram Ball Universal Mount
- Navionics+ Canada Chip
- Quick Release Bracket
- 60A Circuit Breaker



#TECHPACKAGE3

## Tech Package #4 **\$7,699\***

### QUEST SERIES

plus installation\* (Approx 2hrs)  
Requires two or three optional Deep Cycle Batteries.

Show 'em who's boss. This package is for the angler who demands the best from their equipment is guaranteed to set you apart from the competition.

### INCLUDES:

- TERROVA 90/115/DSC/WR QUEST
- HELIX 9 CHIRP MEGA SI+ GPS G4N
- Ethernet Adapter Cable
- 30' Ethernet Cable
- MKR-MI-1 Adapter
- MKR-MDI-2 Adapter
- Ram Ball Universal Mount
- Navionics+ Canada Chip
- Quick Release Bracket
- 60A Circuit Breaker



#TECHPACKAGE4



**With a rapidly growing Partner Network, Legend is taking Canada boating!**

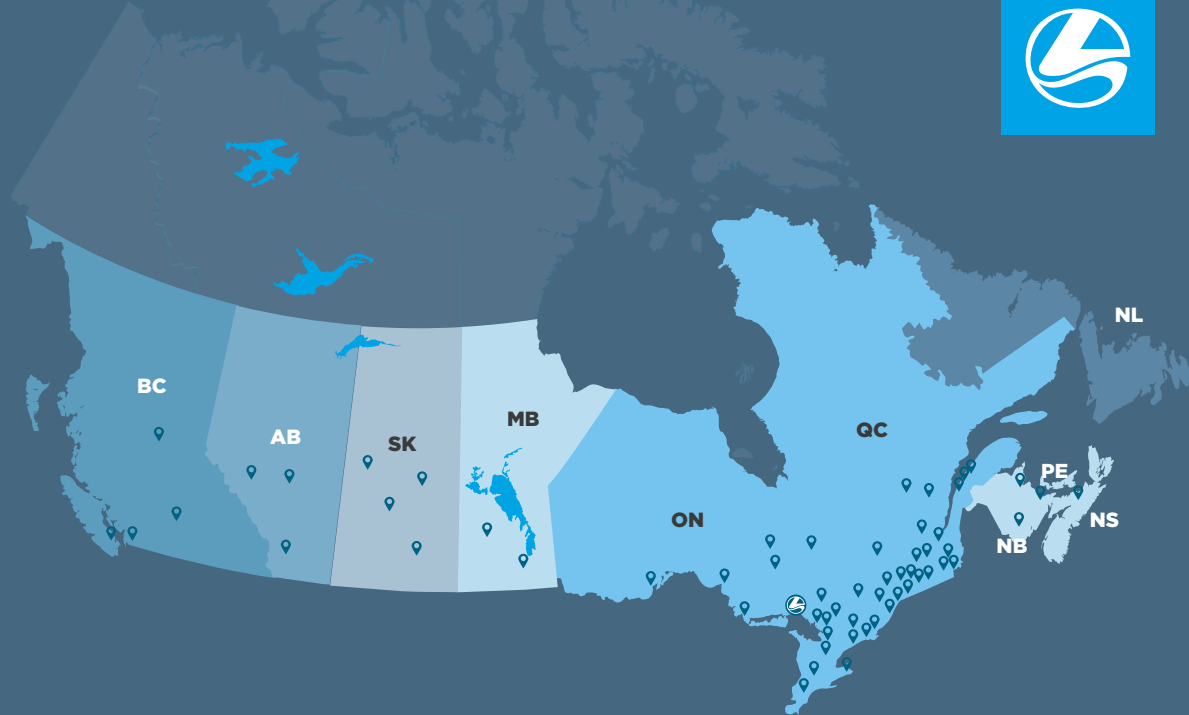

## Freight Charges by Zone.

= Headquarters Whitefish, Ontario

Zone	ON, QC	MB, NB, PE, NS	SK	AB	BC	NL
Utility Boat Only	No Fee	\$600	\$650	\$1,100	\$1,250	\$1,400
Boat Package	No Fee	\$1,175	\$1,400	\$2,075	\$2,400	\$3,500

### No Fee Setup and Orientation

All of the components of your boat, motor, and trailer package have been specially chosen for compatibility. The professionals at your authorized Legend Dealership will help you select the proper motor and options for your package. They will then prepare your package to ensure proper and worry-free operation.

### Side console and full windshield models:

The setup includes the following items: control box, shift cables, starting battery, aluminum propeller, outboard installation and set-up. Your dealer will prepare your package and give you a full orientation to ensure trouble-free boating from day one.

### Tiller models and Utility models in packages:

The setup includes the following items: outboard installation and setup, propeller, fuel tank, starting battery on packages with electric start motor or utility boat models with lights or livewells. Your dealer will prepare your package and give you a full orientation to ensure trouble-free boating from day one.

\* Freight charges outside of Zone 1 (Ontario and Quebec), licenses, and taxes are extra on all prices. Delivery is available at an additional cost. Payments are calculated with licenses, bank registration charges, and taxes as your down-payment at 8.99% over 1,040 weeks for amounts \$23,000 and higher, 9.99% over 780 weeks for amounts between \$10,000 and \$22,999, and 9.99% over 364 weeks for amounts less than \$10,000 (at time of printing). All financing is OAC. Payments will vary by province. All Choose your power prices are in addition and only available with the purchase of the specific package they are listed with; they are not stand alone motor prices. Towing weights are approximate and are calculated based on a full tank of fuel and 200 pounds for batteries and gear. Speed tests were done with 2 persons, 50 pounds of gear and proper weight distribution. Actual performance may vary. Prices, rates and specifications are subject to change or error. Pictures may show options. Ask for complete details. All illustrations, photographs and specifications in this catalogue are based on the latest product information. See actual boat for complete accuracy. Legend reserves the right to make changes at any time, without notice, in prices, colours, materials, equipment, specifications and models, and to discontinue models or equipment. For information on accessories, contact your local Legend dealer.

Please refer to your provincial laws regarding trailer brakes and ensure that your boat package and tow vehicle comply with the regulations in the provinces you intend to travel in. Brakes may be required in certain circumstances and can be purchased as an option or your trailer model can be upgraded before delivery if brakes are not available on certain trailers. It is your sole responsibility to ensure you comply with all provincial brake requirements for vehicles and also that you always operate your tow vehicle safely. Legend Boats accepts no responsibility with regards to provincial compliance.

At [legendboats.com](http://legendboats.com), you'll find a fully-priced electronic version of our catalogue as well as additional pictures and special offers. Always distribute passengers and cargo evenly, wear a PFD and follow the rules for safe boating. Visit: [www.tc.gc.ca/boatingsafety](http://www.tc.gc.ca/boatingsafety)

# Choose Your Power.

Ask your Legend dealer to help you select the Mercury outboard that best suits your needs from the motor choices below. Use the chart that corresponds with the standard engine packaged with your boat model. Simply add the amount to the standard package price to have the motor that is perfect for you.

## FROM A 25 ELPT 4-STROKE TO

- 30 ELPT 4-Stroke.....+\$2,299
- 40 ELPT 4-Stroke.....+\$4,499
- 40 ELPT CT 4-Stroke .....+\$5,099
- 50 ELPT 4-Stroke.....+\$5,799
- 50 ELPT CT 4-Stroke .....+\$6,599

## FROM A 40 ELPT 4-STROKE TO

- 40 ELPT CT 4-Stroke .....+\$599
- 50 ELPT 4-Stroke.....+\$1,299
- 50 ELPT CT 4-Stroke .....+\$2,099
- 60 ELPT 4-Stroke.....+\$3,199
- 60 ELPT CT 4-Stroke .....+\$3,799
- 90 ELPT 4-Stroke.....+\$6,999
- 90 ELPT CT 4-Stroke .....+\$7,599

## FROM A 60 ELPT 4-STROKE TO

- 60 ELPT CT 4-Stroke .....+\$599
- 75 ELPT 4-Stroke .....+\$3,099
- 90 ELPT 4-Stroke.....+\$3,799

## FROM A 90 ELPT 4-STROKE TO

- 90 ELPT CT 4-Stroke .....+\$599
- 115 ELPT 4-Stroke .....+\$2,599
- 115 ELPT ProXS CT 4-Stroke.....+\$3,699
- 150L 4-Stroke.....+\$9,099
- 150L Pro XS including Hydraulic Steering and stainless steel propeller .....+\$16,199

## FROM A 90 EXLPT 4-STROKE TO

- 90 EXLPT CT 4-Stroke.....+\$599
- 115 EXLPT 4-Stroke.....+\$2,599
- 115 EXLPT ProXS CT 4-Stroke .....+\$3,699
- 150XL 4-Stroke .....+\$9,099
- 150XL Pro XS including Hydraulic Steering and stainless steel propeller .....+\$16,199

## FROM A 115 EXLPT 4-STROKE TO

- 115 EXLPT ProXS CT 4-Stroke .....+\$1,099
- 150XL 4-Stroke .....+\$6,499
- 150XL Pro XS including Hydraulic Steering and stainless steel propeller .....+\$13,599
- 175XL Pro XS including Hydraulic Steering and stainless steel propeller .....+\$17,199

- E = Electric Start
- L = Long Shaft
- XL = Extra Long Shaft
- PT = Power Trim and Tilt
- CT = Command Thrust

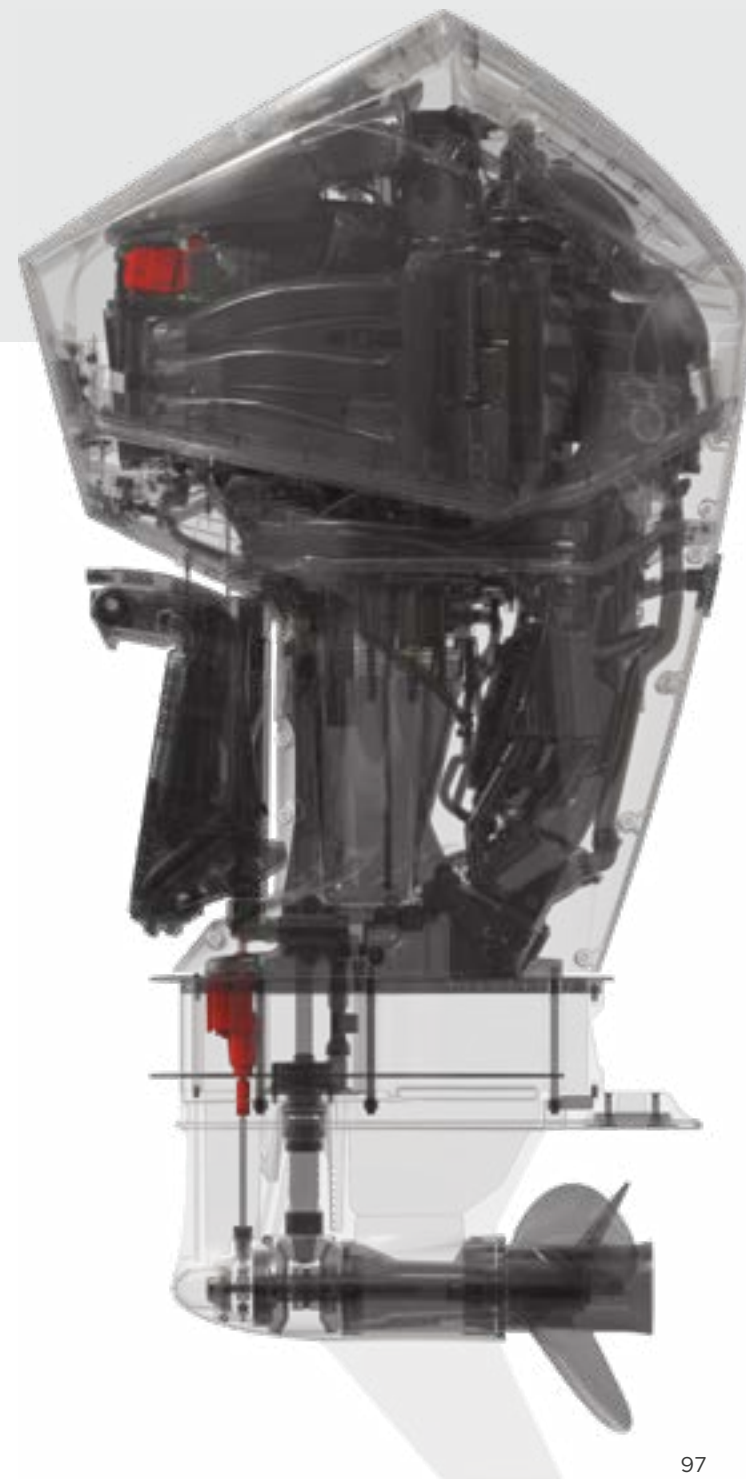



# 6-YEAR WOWRANTY

A warranty that makes you say wow!

Sure we've always had the industry's best warranties on the structural parts of our boats, like the welds, main riveted seams, pontoon tubes, decks and transoms, but what about everything else in your boat? Well, most companies offer a 1 year warranty on the other stuff and some offer up to three years. Although this is very respectable, we figured we'd double that. Legend's 6 Year WOWranty covers most other components for 6 long years. That gives you a lot of worry-free, quality, memory-makin' time.

\*For more details, visit  
[www.legendboats.com/wowranty](http://www.legendboats.com/wowranty)



## 3-Year Mercury Warranty

Every Mercury 4-Stroke outboard is backed by a 3-year standard limited warranty to give you peace of mind. Ask us about Mercury Product Protection to extend your Mercury Factory Warranty for up to 8 years.\*



## Lifetime Floor Warranty

A thicker floor means a stronger boat. With 7 layers, of marine grade plywood, each individually-treated, we can offer a lifetime warranty against rotting.\*



## Legend Glide-On 5+1 Year Trailer Warranty

Every Legend Glide-On trailer by Shoreland'r is backed by a 5 year frame warranty and 1-year complete tongue to tail light warranty.\*



## All-Welded Series Leakproof For Life Warranty

Every Legend All-Welded model carries our exciting and industry-leading Leakproof for Life Warranty. It is remarkably simple. It covers the entire structure of the hull against leaks through the hull for as long as you own the boat. In fact it's the kind of warranty you won't find on any other aluminum boat. Plus it is transferable, giving the second owner up to 10 years of protection.\*



## Legend ProTech 5+1 Year Canvas Warranty

Legend ProTech All-Synthetic Tear and Mildew-Resistant Material is backed by a 5 Year Warranty and guaranteed not to rot or fade for five years. Stitching, zippers, seams and other top components are covered for 1 year.\*



## Riveted Series Lifetime Main Seam Warranty

Each Riveted model has a Lifetime Main Seam Hull Warranty and an amazing 10 year warranty on most other hull components. This industry-leading warranty is transferable, giving the second owner up to 10 years of protection.\*

# The Legend Time Capsule

Introducing the Legend Time Capsule - a new and exciting addition to our annual catalogue! At Legend Boats, our mission has always been to Create Memories, and this year, we've found a unique way to celebrate those cherished moments.

The Time Capsule is more than just a page in our catalogue; it's a tribute to the incredible experiences our valued customers have had on the water, a way to connect our community, and an inspiration for new adventures.

**Contribute to next season's capsule!**

Scan the QR code or visit [legendboats.com/memory-share](https://legendboats.com/memory-share)



Scan the QR code to experience some of these first-hand!

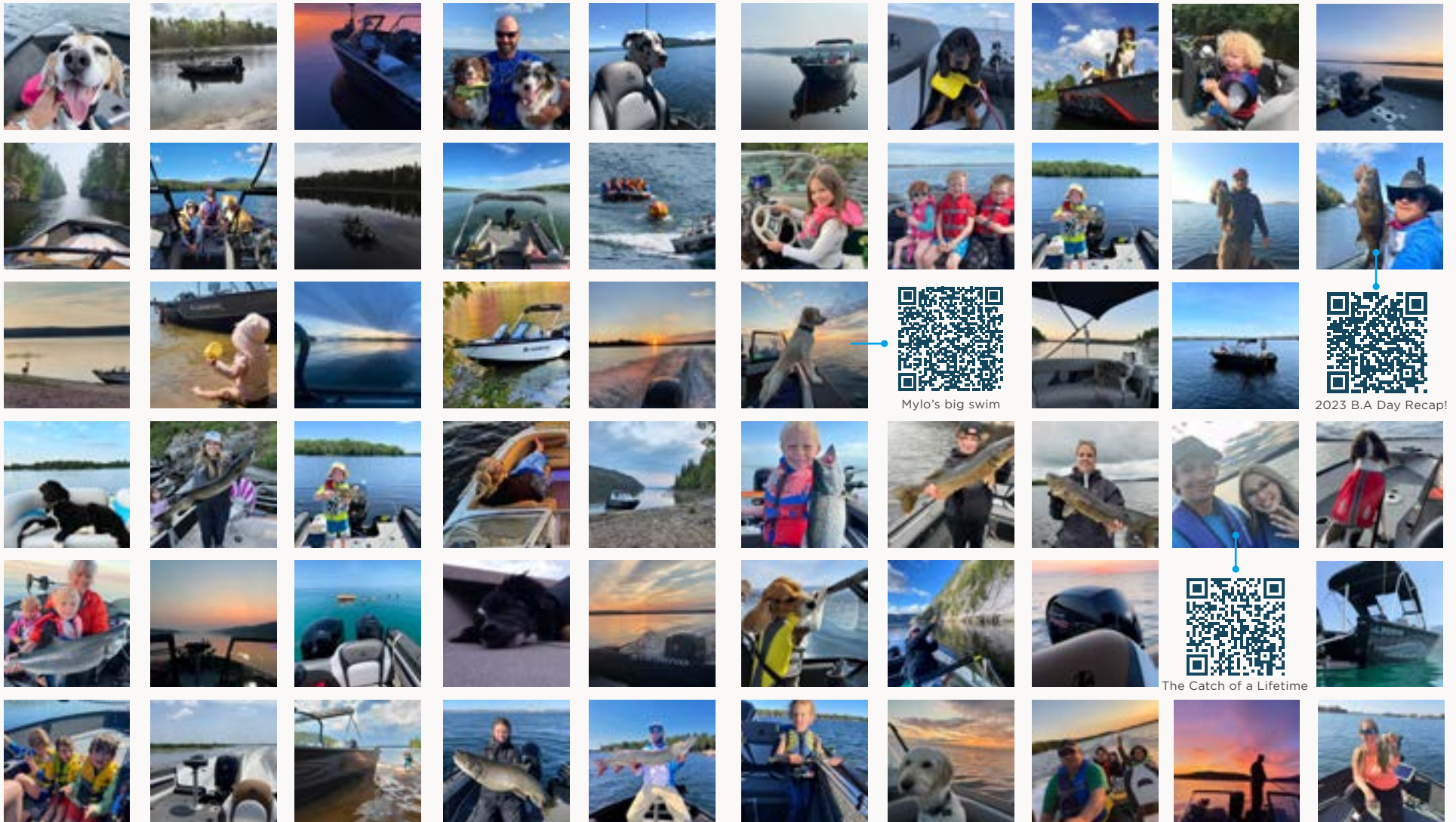

Mylo's big swim



2023 B.A Day Recap!



The Catch of a Lifetime





4795 Regional Road 55. Whitefish, ON. POM 3E0  
legendboats.com | info@legendboats.com