

Write your name here

Surname

Other names

Pearson Edexcel
Level 1/Level 2 GCSE (9-1)

Centre Number

--	--	--	--	--

Candidate Number

--	--	--	--

Mathematics

Paper 2 (Calculator)

Foundation Tier

Thursday 7 June 2018 – Morning
Time: 1 hour 30 minutes

Paper Reference

1MA1/2F

You must have: Ruler graduated in centimetres and millimetres, protractor, pair of compasses, pen, HB pencil, eraser, calculator. Tracing paper may be used.

Total Marks

Instructions

- Use **black** ink or ball-point pen.
- **Fill in the boxes** at the top of this page with your name, centre number and candidate number.
- Answer **all** questions.
- Answer the questions in the spaces provided – *there may be more space than you need.*
- You must **show all your working**.
- Diagrams are **NOT** accurately drawn, unless otherwise indicated.
- **Calculators may be used.**
- If your calculator does not have a π button, take the value of π to be 3.142 unless the question instructs otherwise.



Information

- The total mark for this paper is 80
- The marks for **each** question are shown in brackets – *use this as a guide as to how much time to spend on each question.*

Advice

- Read each question carefully before you start to answer it.
- Keep an eye on the time.
- Try to answer every question.
- Check your answers if you have time at the end.

Turn over ►

P48863A

©2018 Pearson Education Ltd.
61777107711211



Pearson

Answer ALL questions.

Write your answers in the spaces provided.

You must write down all the stages in your working.

- 1 Write $\frac{4}{50}$ as a percentage.

$$\frac{4}{50} = \frac{8}{100} = 8\%$$

8 %

(Total for Question 1 is 1 mark)

- 2 Write 1.59 correct to 1 decimal place.

1.6

(Total for Question 2 is 1 mark)

- 3 Work out the value of 3^5

$$3 \times 3 \times 3 \times 3 \times 3 = 243$$

243

(Total for Question 3 is 1 mark)

- 4 Write down a 6 digit number that has 4 as its thousands digit.
You can only use the digit 4 once.

524018
↑
1000

524018

(Total for Question 4 is 1 mark)

DO NOT WRITE IN THIS AREA

DO NOT WRITE IN THIS AREA

DO NOT WRITE IN THIS AREA



DO NOT WRITE IN THIS AREA

DO NOT WRITE IN THIS AREA

DO NOT WRITE IN THIS AREA

5 (a) Change 35 cm to mm.

$$35\text{cm} = 350\text{mm}$$

$$1\text{cm} = 10\text{mm}$$

350 mm
(1)

(b) Change 7700 millilitres to litres.

$$7700 \div 1000 = 7.7$$

7.7 litres
(1)

(c) Change 0.32 kilograms to grams.

$$0.32 \times 1000 = 320$$

320 grams
(1)

(Total for Question 5 is 3 marks)

6 Margaret is thinking of a number. She says,

"My number is odd. It is a factor of 36 and a multiple of 3"

There are two possible numbers Margaret can be thinking of.

Write down these two numbers.

9 6 ~~3~~ 3

	36
1	36
2	18
3	12
4	9
6	6

(3) 6, (9) 12, 15, 18
21, 24, 27, 30
33, 36

3

9

(Total for Question 6 is 3 marks)

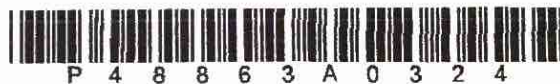

P 4 8 8 6 3 A 0 3 2 4

M Y L

- 7 Mohsin, Yusuf and Luke are going to play a game.
At the end of the game, one of them will be in First place, one of them will be in Second place and one of them will be in Third place.

Use the table below to list all the possible outcomes of the game.

First place	Second place	Third place
M	Y	L
M	L	Y
Y	M	L
Y	L	M
L	M	Y
L	Y	M

(Total for Question 7 is 2 marks)



8 Neil buys 30 pens, 30 pencils, 30 rulers and 30 pencil cases.

Price list

pens	6 for 82p
pencils	15 for 45p
rulers	10 for £1.25
pencil cases	37p each

What is the total amount of money Neil spends?

Pens 6 for 82p $5 \times 82p = 410 = \pounds 4.10$

Pencils 15 for 45p $2 \times 45p = 90p = \pounds 0.9$

rulers 10 for 1.25 $3 \times 1.25 = \pounds 3.75$

pencil cases $30 \times 37p = 1110p = \pounds 11.10$

$$4.10 + 0.9 + 3.75 + 11.10 = \pounds 19.85$$

£ 19.85

(Total for Question 8 is 5 marks)



9 Emily drives 186 miles in 3 hours.

(a) What is her average speed?

$$\frac{186}{3} = 62$$

62 mph
(2)

Sarah drives at an average speed of 58 mph for 4 hours.

(b) How many miles does Sarah drive?

$$58 \times 4 = 232$$

232 miles
(2)

(Total for Question 9 is 4 marks)

10 (a) Write down all the prime numbers between 20 and 30

23, 29
(2)

Catherine says,

"2 is the only even prime number."

(b) Is Catherine right?

You must give a reason for your answer.

yes, all other even number have 2 as a factor

(1)

(Total for Question 10 is 3 marks)

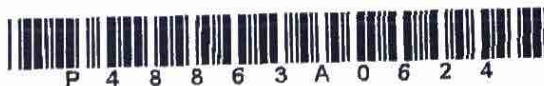

DO NOT WRITE IN THIS AREA

DO NOT WRITE IN THIS AREA

DO NOT WRITE IN THIS AREA

11 (a) Solve $x + x + x = 51$

$$3x = 51$$

$$x = 17$$

$$x = \frac{17}{(1)}$$

(b) Solve $\frac{y}{4} = 3$

$$\times 4 \quad \times 4$$

$$y = 3 \times 4$$

$$y = 12$$

$$y = \frac{12}{(1)}$$

(c) Solve $2f + 7 = 18$

$$2f + 7 = 18$$

$$-7 \quad -7$$

$$2f = 11$$

$$f = 5.5$$

$$f = \frac{5.5}{(1)}$$

(Total for Question 11 is 3 marks)

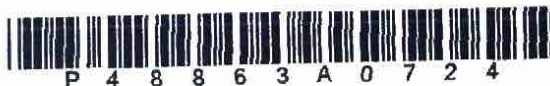

P 4 8 8 6 3 A 0 7 2 4

12 A group of football fans were asked what their half time snack was.

The table below gives information about their answers.

Snack	Number of fans	Degrees
burger	11	110°
pie	17	170°
hot dog	8	80°

Draw an accurate pie chart for this information.

36

Total = 36

$$\frac{360}{36} = 10$$

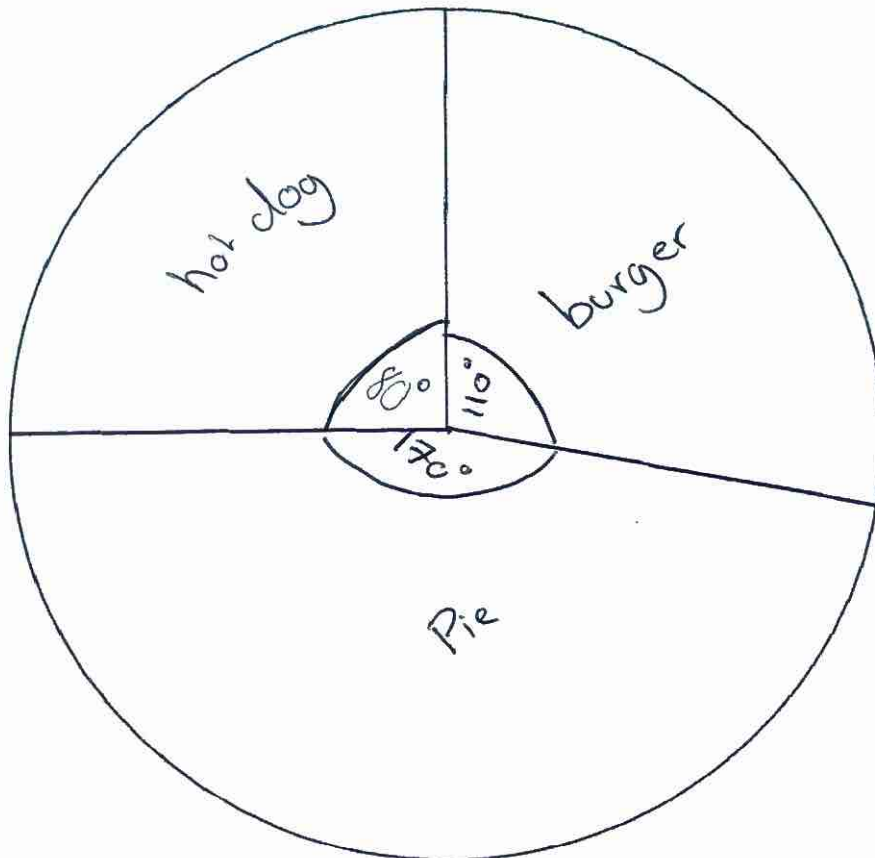

(Total for Question 12 is 3 marks)



DO NOT WRITE IN THIS AREA

DO NOT WRITE IN THIS AREA

DO NOT WRITE IN THIS AREA

13 A scout group has a raffle to raise money for charity.
There is 1 prize to be won in the raffle.

Laura buys 12 raffle tickets.
A total of 350 raffle tickets are sold.

Find the probability that Laura does **not** win the prize.

$$350 - 12 = 338$$

$$\frac{338}{350}$$

(Total for Question 13 is 2 marks)



P 4 8 8 6 3 A 0 9 2 4

14 Each worker in a factory is either left-handed or right-handed.

22 of the 45 workers are male.

16 of the 34 right-handed workers are female.

Complete the frequency tree for this information.

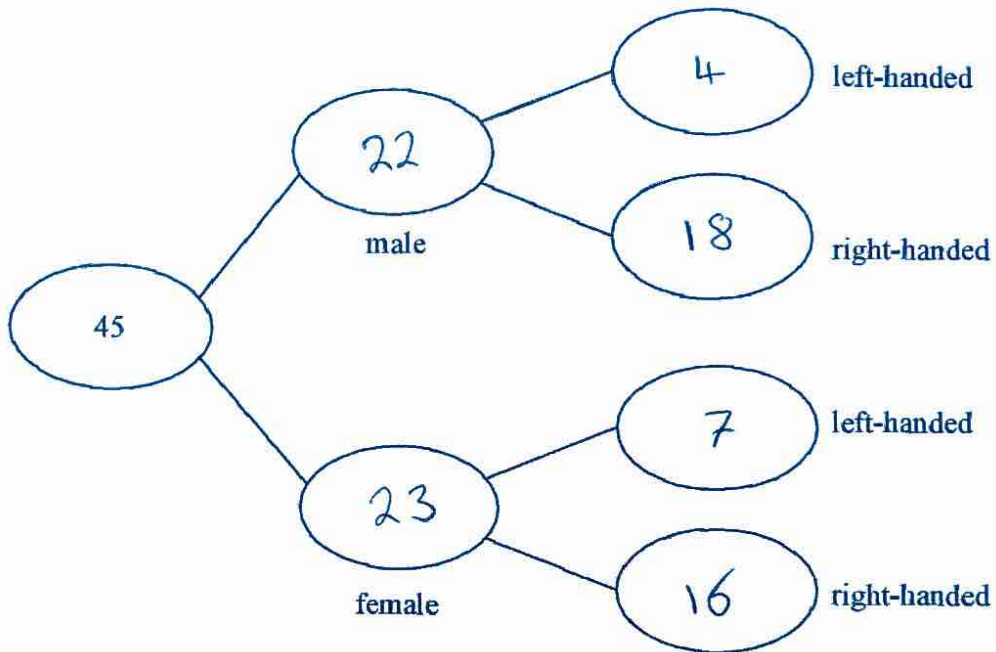

(Total for Question 14 is 3 marks)



15 Mary needs to work out the size of angle x in this diagram.

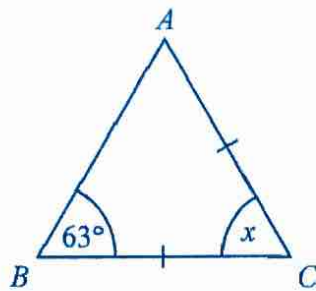

She writes

$x = 63^\circ$ because base angles of an isosceles triangle are equal.

Mary is wrong.

(a) Explain why.



An isosceles triangle. The base angles are equal

(1)

William needs to work out the size of angle y in this diagram.

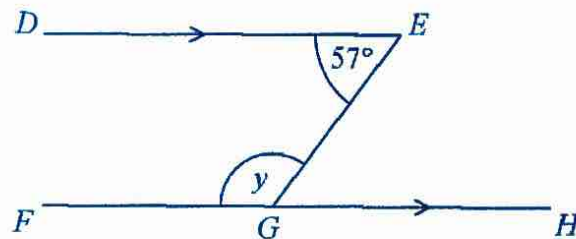

William writes

Working	Reason
angle $EGH = 57^\circ$	because corresponding angles are equal
$y = 180^\circ - 57^\circ$ $y = 123^\circ$	because angles on a straight line add up to 180°

One of William's reasons is wrong.

(b) Write down the correct reason.

$EGH = 57^\circ$ Because alternate angles are equal

(1)

(Total for Question 15 is 2 marks)



16 Marla buys some bags of buttons.

There are 19 buttons or 20 buttons or 21 buttons or 22 buttons in each bag.

The table gives some information about the number of buttons in each bag.

Number of buttons	Frequency	
19	7 5	19x
20	7	140
21	3	63
22	1	22

The total number of buttons is 320

Complete the table.

$$19x + 140 + 63 + 22 = 320$$

$$19x + 225 = 320$$

$$19x = 95$$

$$x = 5$$

(Total for Question 16 is 3 marks)

DO NOT WRITE IN THIS AREA

DO NOT WRITE IN THIS AREA

DO NOT WRITE IN THIS AREA



DO NOT WRITE IN THIS AREA

DO NOT WRITE IN THIS AREA

DO NOT WRITE IN THIS AREA

17 Here is the list of ingredients for making 30 biscuits.

Ingredients for 30 biscuits	
225 g	butter
110 g	caster sugar
275 g	plain flour
75 g	chocolate chips

Lucas has the following ingredients.

- 900 g butter
- 1000 g caster sugar
- 1000 g plain flour
- 225 g chocolate chips

What is the greatest number of biscuits Lucas can make?
You must show your working.

Butter $\frac{900}{225} = 4$

Caster sugar $\frac{1000}{110} = 9.0909$

plain flour $\frac{1000}{275} = 3.6363$

chocolate $\frac{225}{75} = 3$ ← limiting ingredient

$3 \times 30 = 90$

90

(Total for Question 17 is 3 marks)



18

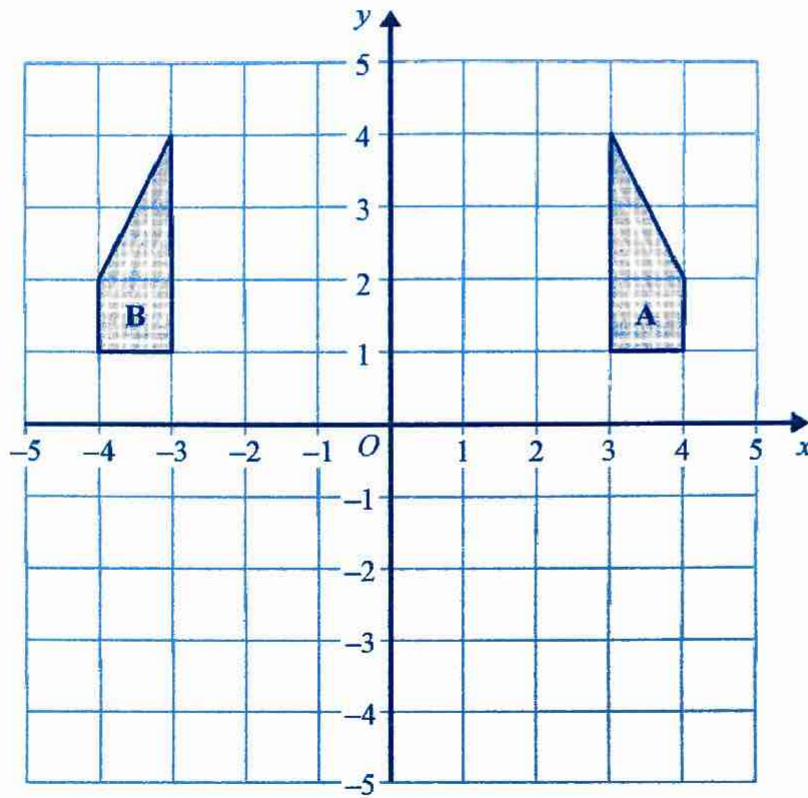

Describe fully the single transformation that maps shape A onto shape B.

Reflection along $x = 0$ (y axis)

(Total for Question 18 is 2 marks)

DO NOT WRITE IN THIS AREA

DO NOT WRITE IN THIS AREA

DO NOT WRITE IN THIS AREA



19 A farmer has a field in the shape of a semicircle of diameter 50 m.

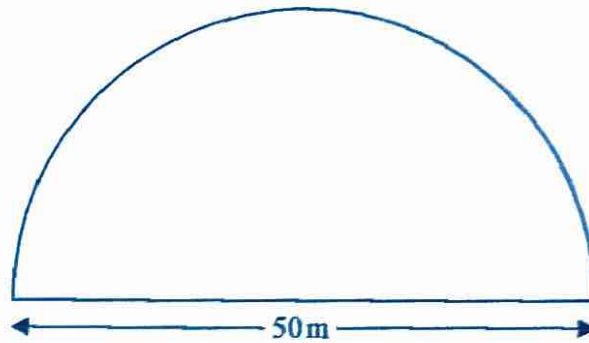

The farmer asks Jim to build a fence around the edge of the field.
Jim tells him how much it will cost.

Total cost = £29.86 per metre of fence plus £180 for each day's work

Jim takes three days to build the fence.

Work out the total cost.

$$\frac{1}{2} \pi D = \frac{1}{2} \times \pi \times 50 = 78.54 \text{ m}$$

$$78.54 + 50 = 128.54 \text{ cm} = \text{the perimeter of semicircle}$$

$$128.54 \times 29.86 = \pounds 3838.1989 \dots$$

$$+ 3 \times 180 = 540$$

$$3838.1989 \dots + 540 = 4378.1989 \dots$$

$$\pounds 4378.2$$

£ 4378.2

(Total for Question 19 is 5 marks)



20 (a) Simplify $m^3 \times m^4$

$$m^n \times m^a = m^{n+a}$$

$$\frac{m^7}{(1)}$$

(b) Simplify $(5np^3)^3$

$$\frac{125n^3p^9}{(2)}$$

(c) Simplify $\frac{32q^9r^4}{4q^3r}$

$$\frac{8q^6r^3}{(2)}$$

(Total for Question 20 is 5 marks)

DO NOT WRITE IN THIS AREA

DO NOT WRITE IN THIS AREA

DO NOT WRITE IN THIS AREA



DO NOT WRITE IN THIS AREA

21 (a) Find the lowest common multiple (LCM) of 40 and 56

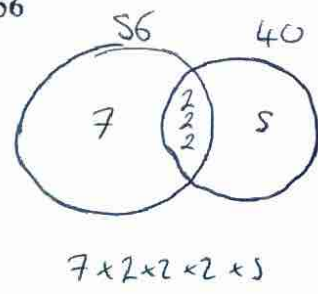
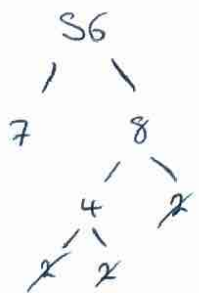
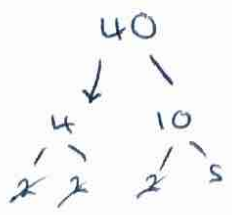

280

(2)

$A = 2^3 \times 3 \times 5$

$B = 2^2 \times 3 \times 5^2$

(b) Write down the highest common factor (HCF) of A and B.

A = $2 \times 2 \times 2 \times 3 \times 5$

B = $2 \times 2 \times 3 \times 5 \times 5$

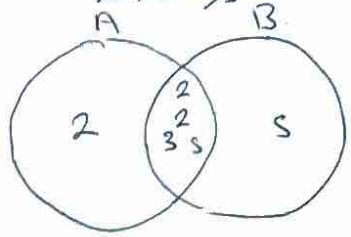

$2 \times 2 \times 3 \times 5$

60

(1)

(Total for Question 21 is 3 marks)

DO NOT WRITE IN THIS AREA

DO NOT WRITE IN THIS AREA



22 The line L is shown on the grid.

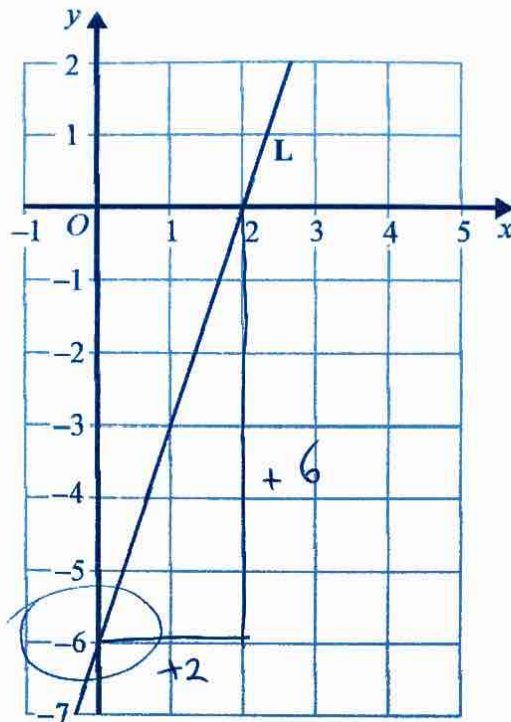

Find an equation for L.

$$\text{gradient} = \frac{\Delta y}{\Delta x} = \frac{6}{2} = 3$$

$$c = y \text{ intercept} = -6$$

$$y = 3x - 6$$

(Total for Question 22 is 3 marks)

DO NOT WRITE IN THIS AREA

DO NOT WRITE IN THIS AREA

DO NOT WRITE IN THIS AREA



DO NOT WRITE IN THIS AREA

DO NOT WRITE IN THIS AREA

DO NOT WRITE IN THIS AREA

23 Raya buys a van for £8500 plus VAT at 20%

Raya pays a deposit for the van.

She then pays the rest of the cost in 12 equal payments of £531.25 each month.

Find the ratio of the deposit Raya pays to the total of the 12 equal payments.

Give your answer in its simplest form.

$$12 \times 531.25 = 6375$$

$$8500 \times 1.2 = 10200$$

$$10200 - 6375 = 3825$$

$$3825 : 6375$$

$$3 : 5$$

(put in your calculator $\frac{3825}{6375} = \frac{3}{5}$)

$$3 : 5$$

(Total for Question 23 is 5 marks)



24 (a) Complete the table of values for $y = x^2 - x - 6$

x	-3	-2	-1	0	1	2	3
y	6	4	4	-6	4	-4	0
		0	-4		-6		

(2)

(b) On the grid, draw the graph of $y = x^2 - x - 6$ for values of x from -3 to 3

(2)

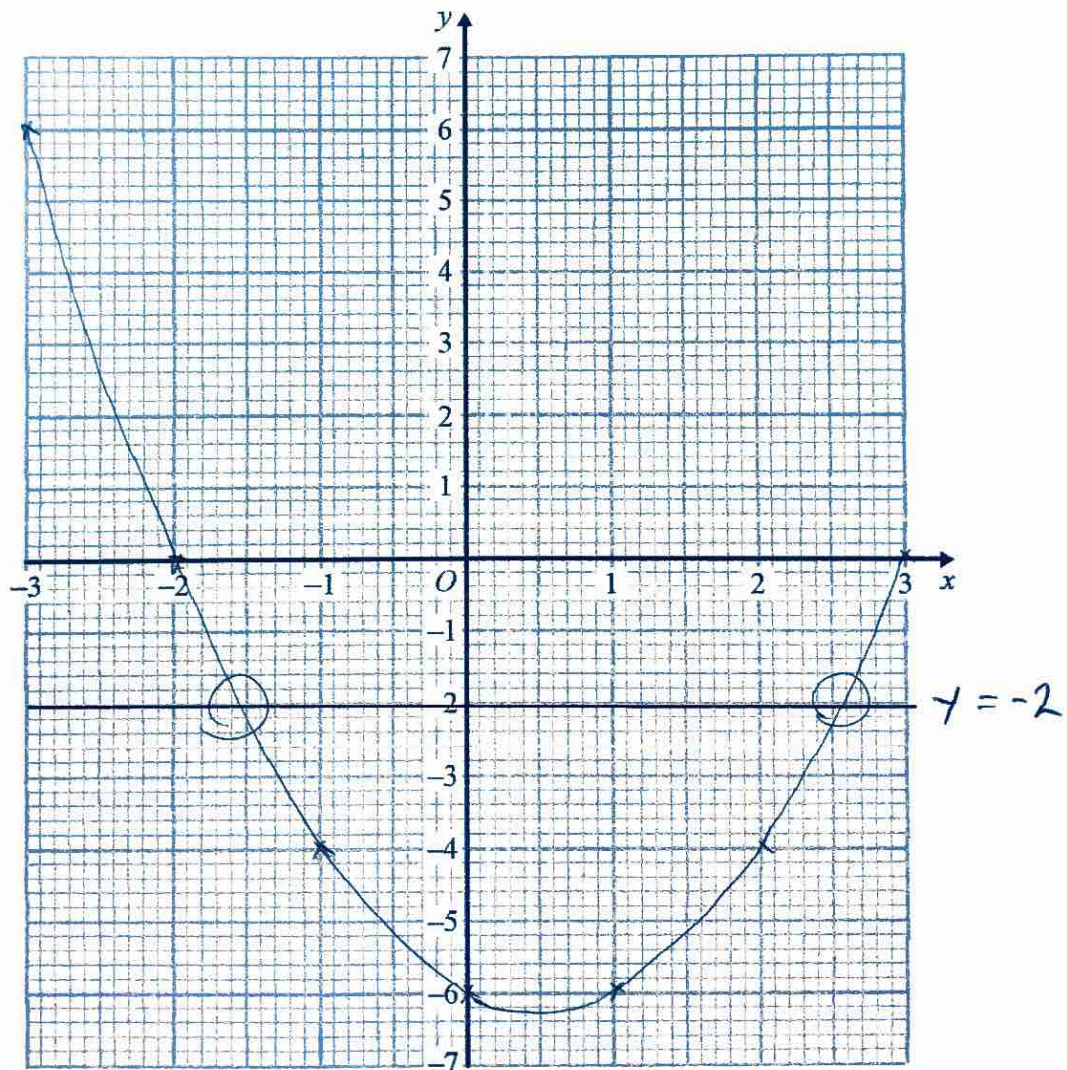

DO NOT WRITE IN THIS AREA

DO NOT WRITE IN THIS AREA

DO NOT WRITE IN THIS AREA



(c) Use your graph to find estimates of the solutions to the equation $x^2 - x - 6 = -2$

Draw $y = -2$ on the graph.

The x values of the intercept.

2.6 and -1.6

(2)

(Total for Question 24 is 6 marks)

25 A force of 70 newtons acts on an area of 20 cm^2

The force is increased by 10 newtons.

The area is increased by 10 cm^2

$$\text{pressure} = \frac{\text{force}}{\text{area}}$$

Helen says,

“The pressure decreases by less than 20%”

Is Helen correct?

You must show how you get your answer.

$$\text{pressure 1} = \frac{70}{20} = 3.5 \text{ N/m}^2$$

$$\text{pressure 2} = \frac{80}{30} = 2.67 \text{ N/m}^2$$

$$3.5 \times 0.8 = 2.8$$

$$2.8 > 2.67$$

The pressure decrease by more than 20%

(Total for Question 25 is 3 marks)



P 4 8 8 6 3 A 0 2 1 2 4

26 Here is a triangular prism.

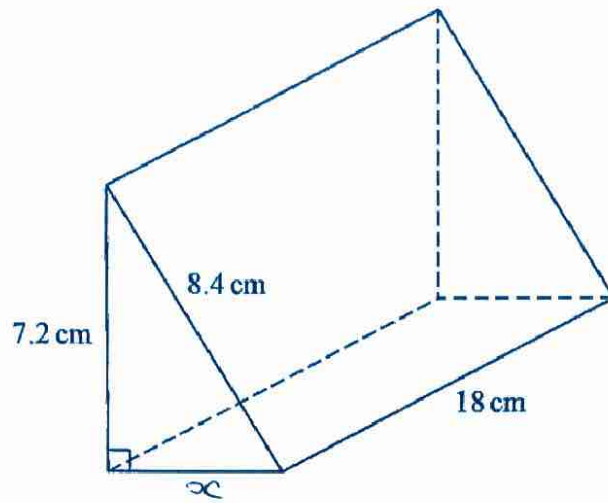

Work out the volume of the prism.
Give your answer correct to 3 significant figures.

Area of face \times length

~~Area of face \times length =~~

Step 1. Find x using Pythag

$$8.4^2 - 7.2^2 = x^2$$

$$18.72 = x^2$$

$$4.326... = x$$

$$\text{Area of face} = \frac{1}{2} \times 7.2 \times 4.326 = 15.575...$$

$$\text{Volume} = 15.575 \times 18 = 280.367...$$

$$280 \quad 338$$

280 cm³

(Total for Question 26 is 5 marks)

TOTAL FOR PAPER IS 80 MARKS

