

**REMOTE CONTROL SYSTEM  
RC-200**

**ALL SPORT OPERATION  
MANUAL**

**P1110**

DD3572889  
Rev 00  
18 May 2018



**DAKTRONICS**

**Copyright © 2018**

All rights reserved. While every precaution has been taken in the preparation of this manual, the publisher assumes no responsibility for errors or omissions. No part of this book covered by the copyrights hereon may be reproduced or copied in any form or by any means—graphic, electronic, or mechanical, including photocopying, taping, or information storage and retrieval systems—without written permission of the publisher.

*Daktronics trademarks are property of Daktronics, Inc. All other trademarks are property of their respective companies.*

# Table of Contents

<b>1</b>	<b>Introduction</b> .....	<b>1</b>
	Important Safeguards.....	1
	Specifications Label.....	1
	Recommended Temperatures.....	1
	Resources.....	1
	Daktronics Exchange and Repair & Return Programs.....	2
	Exchange Program.....	2
	Repair & Return Program.....	3
	Daktronics Warranty & Limitation of Liability.....	3
<b>2</b>	<b>RC-200 System Overview</b> .....	<b>4</b>
	Important Installation Range Considerations.....	4
<b>3</b>	<b>RC-200 Handheld Controller</b> .....	<b>5</b>
	Powering the Controller On & Off.....	5
	Using the Keypad.....	5
	Using External Power.....	5
	Battery Operation.....	5
	Idle Time.....	5
	Battery Recharging.....	5
	Config Mode.....	6
	Setting Default Radio Broadcast Group & Channel.....	6
	Setting LCD Contrast.....	6
	Setting Power Save Mode.....	6
	Connect Mode.....	7
	Switching to Connect Mode.....	7
	Signal Strength Indicator.....	7
	Common Keys.....	8
	Alternate Function Keys.....	9
<b>4</b>	<b>All Sport Applications</b> .....	<b>10</b>
	Selecting All Sport Applications (Code Numbers).....	10
	Keypad Inserts.....	11
	Keypad Insert Operation Concepts.....	11
	Common All Sport Application Keys.....	12
	New Code (Alt. Function).....	12
	New Game (Alt. Function).....	12
	Start.....	13
	Stop.....	13
	Set Time.....	13
	UP/DN (Alt. Function).....	14
	Dim (Alt. Function).....	14
	Manual Horn.....	14
	Auto Horn.....	15
<b>5</b>	<b>Clock/Score Operation</b> .....	<b>16</b>

# Table of Contents

Score (+1/-1) .....	16
Period +1 .....	16
Set TOD (Alt. Function) .....	16
<b>6 Volleyball Operation .....</b>	<b>17</b>
Score (+1/-1) .....	17
Won (+1/-1) .....	17
Reset Game Score .....	17
Game (+1/-1) .....	17
<b>7 Baseball Operation .....</b>	<b>18</b>
Score (+1/-1) .....	18
Out +1, Inning +1 .....	18
Ball +1, Strike +1, Clear Ball & Strike .....	18
Hit .....	18
Error .....	19
Time, At Bat, H/E (Alt. Function) .....	19
Time/At Bat .....	19
<b>8 Play Clock &amp; Pitch Timer Operation .....</b>	<b>20</b>
Set Reset 1, Set Reset 2 .....	20
Reset 1, Reset 2 .....	20
<b>9 Segment Timer Operation .....</b>	<b>21</b>
Segment Timer Information .....	21
Segment Number/Time .....	21
First/Last Segment .....	21
Current Segment +1 .....	22
Reset Current Segment .....	22
Reset to First Segment .....	22
Interval Time .....	22
Copy Range .....	22
Auto Stop .....	23
Warning Time .....	23
<b>10 Tennis Operation .....</b>	<b>24</b>
Court Selection .....	24
Serve .....	24
Game +1 .....	24
Point .....	25
Reset Game .....	25
Tie Break .....	25
TOD/Game .....	25
Set +1 .....	25
Matches Won (Alt. Function) .....	26
Reset Match (Alt. Function) .....	26
Next Match (Alt. Function – DakTennis Only) .....	26

# Table of Contents

Winner (Alt. Function – DakTennis Only).....	26
<b>11 Sand Volleyball Operation .....</b>	<b>27</b>
Court Selection .....	27
Serve .....	27
Point .....	27
Set +1 .....	28
Reset Game (Reset Match) .....	28
TOD/Game.....	28
Matches Won (Alt. Function) .....	28
Game +1, Tie Break, Next Match, Winner.....	28
<b>12 Basketball Operation .....</b>	<b>29</b>
Score (+1/+2) .....	29
Score (+3/-1) (Alt. Functions).....	29
Fouls +1 .....	29
Possession .....	29
Period +1.....	30
Set TOD (Alt. Function) .....	30
1/10 SEC (Alt. Function) .....	30
Bonus (Alt. Function).....	30
<b>13 Football Operation .....</b>	<b>31</b>
Score (+1/+6) .....	31
Score (+3/-1) (Alt. Functions).....	31
QTR +1 .....	31
Down +1.....	31
To Go.....	32
Ball On.....	32
TOL -1 .....	32
Possession (Alt. Function) .....	32
<b>14 Remote Start/Stop Operation .....</b>	<b>33</b>
Start .....	33
Stop .....	33
Manual Horn/Reset .....	33
<b>15 Goal Judge Operation.....</b>	<b>34</b>
Goal Light On/Off.....	34
<b>16 CAN Handheld Operation .....</b>	<b>35</b>
Common CAN Handheld Operation.....	35
Diving & Synchronized Swimming Operations .....	35
Rodeo Operations.....	35
<b>17 Troubleshooting .....</b>	<b>36</b>
Handheld Controller Error Messages .....	36
Base Station Errors.....	37
<b>IN RANGE LED On Start-up .....</b>	<b>37</b>

# Table of Contents

General Base Station Failures.....	37
Obtaining Base Station Status Information.....	37
<b>A Reference Drawings .....</b>	<b>39</b>
<b>B Sport Inserts .....</b>	<b>57</b>
<b>C Daktronics Warranty and Limitation of Liability .....</b>	<b>71</b>

# 1 Introduction

This manual is designed to explain the operation of the Daktronics RC-200 Remote Control System for All Sport® applications. For additional information regarding the safety, installation, operation, or service of this system, refer to the telephone numbers listed in **Daktronics Exchange and Repair & Return Programs (p.2)**.

## Important Safeguards

- **Read and understand all instructions, both general and for specific applications.**
- **Always turn off and/or unplug the control equipment when it is not in use. Never yank the power cord to pull the plug from the outlet. Grasp the plug and pull to disconnect.**
- **Do not drop the control console or allow it to get wet.**
- **Do not disassemble control equipment or electronic controls of the display; failure to follow this safeguard will make the warranty null and void.**
- **Do not let any power cord touch hot surfaces or hang over the edge of a table that would damage or cut the cord.**
- **If an extension cord is necessary, use a three-pronged, polarized cord. Arrange the cord with care so that it will not be tripped over or pulled out.**
- **Inspect console for shipping damage such as rattles and dents, and verify that all equipment is included as itemized on the packing slip. Immediately report any problems to Daktronics; save all packing materials if exchange is necessary.**
- **Use only the 18 VDC wallpack charger or charging station provided from Daktronics for recharging the battery. Refer to Battery Recharging (p.5).**

**CAUTION! RISK OF EXPLOSION IF BATTERY IS INCORRECTLY REPLACED.**

**DISPOSE OF USED BATTERIES ACCORDING TO THE INSTRUCTIONS.**

## Specifications Label

Power specifications as well as product assembly information can be found on an ID label on the back of the handheld device and on the bottom of the base station, similar to those shown in **Figure 1**.

When calling Daktronics customer service, please have the assembly number and the date manufactured available to ensure the request is serviced as quickly as possible.

## Recommended Temperatures

- **Operation:** 14° to 149° Fahrenheit (-10° to 65° Celsius)
- **Charging:** 32° to 104° Fahrenheit (0° to 40° Celsius)
- **Storage:** -4° to 113° Fahrenheit (-20° to 45° Celsius)

## Resources

**Figure 2** illustrates a Daktronics drawing label. This manual refers to drawings by listing the last set of digits. In the example, the drawing would be referred to as **DWG-1007804**. All references to drawing numbers, appendices, figures, or other manuals are presented in bold typeface.

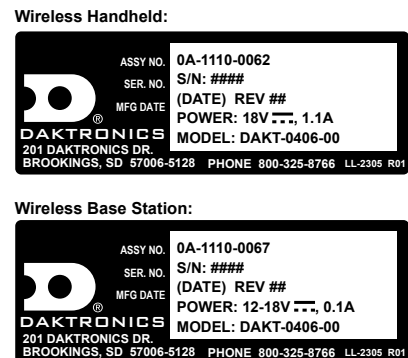

**Figure 1:** Specifications Labels

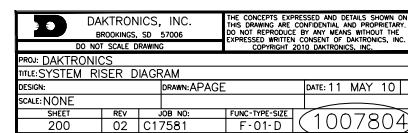

Drawing Number

**Figure 2:** Drawing Label

Any drawings referenced in a section are listed at the beginning of it as shown below:

**Reference Drawings:**

System Riser Diagram ..... **DWG-1007804**

Daktronics identifies manuals by the DD or ED number located on the cover page.

## Daktronics Exchange and Repair & Return Programs

### Exchange Program

The Daktronics Exchange Program is a service for quickly replacing key components in need of repair. If a component fails, Daktronics sends a replacement part to the customer who, in turn, returns the failed component to Daktronics. This decreases equipment downtime. Customers who follow the program guidelines explained below will receive this service.

Before contacting Daktronics, identify these important numbers:

**Display Serial Number:** \_\_\_\_\_

**Display Model Number:** \_\_\_\_\_

**Job/Contract Number:** \_\_\_\_\_

**Date Manufactured/Installed:** \_\_\_\_\_

**Daktronics Customer ID Number:** \_\_\_\_\_

To participate in the Exchange Program, follow these steps:

**1. Call Daktronics Customer Service.**

Market Description	Customer Service Number
Schools (including community/junior colleges), religious organizations, municipal clubs, and community centers	877-605-1115 Fax: 605-697-4444
Universities and professional sporting events, live events for auditoriums, and arenas	866-343-6018 Fax: 605-697-4444

**2. When the new exchange part is received, mail the old part to Daktronics.**

If the replacement part fixes the problem, send in the problem part being replaced.

- a. Package the old part in the same shipping materials in which the replacement part arrived.
- b. Fill out and attach the enclosed UPS shipping document.
- c. Ship the part to Daktronics.

**3. The defective or unused parts must be returned to Daktronics within 5 weeks of initial order shipment.**

If any part is not returned within five (5) weeks, a non-refundable invoice will be presented to the customer for the costs of replenishing the exchange parts inventory with a new part. Daktronics reserves the right to refuse parts that have been damaged due to acts of nature or causes other than normal wear and tear.



## Repair & Return Program

For items not subject to exchange, Daktronics offers a Repair & Return Program. To send a part for repair, follow these steps:

**1. Call or fax Daktronics Customer Service.**

Refer to the appropriate number in the chart on the previous page.

**2. Receive a case number before shipping.**

This expedites repair of the part.

**3. Package and pad the item carefully to prevent damage during shipment.**

Electronic components, such as printed circuit boards, should be placed in an antistatic bag before boxing. Daktronics does not recommend using packing peanuts when shipping.

**4. Enclose:**

- name
- address
- phone number
- the case number
- a clear description of symptoms

**5. Ship to:**

Daktronics Customer Service

[Case #]

201 Daktronics Drive, Dock E

Brookings, SD 57006

## Daktronics Warranty & Limitation of Liability

The Daktronics Warranty & Limitation of Liability is located at the end of this manual. The Warranty is independent of Extended Service agreements and is the authority in matters of service, repair, and display operation.

## 2 RC-200 System Overview

The RC-200 system allows wireless control of multiple scoring and display applications. This system is made up of two distinct hardware components: the RC-200 wireless handheld controller, and the RC-200 wireless Base Station.

The RC-200 wireless handheld controller (**Figure 3**) includes a 4x4 keypad and a 97x32 liquid crystal display (LCD). The RC-200 wireless handheld controller is used to enter information to be displayed on a scoreboard or display. The handheld operates using a 2.4 GHz radio with internal antenna and comes with a rechargeable Ni-MH (Nickel Metal Hydride) 2000 mAh battery which provides 8-10 hours of operation. A complete RC-200 system may include multiple RC-200 wireless handheld controllers.

The RC-200 wireless Base Station processes information received from the wireless handheld controllers and sends this information to the scoreboard or another external controller. Based on the application, an RC-200 wireless receiver may be mounted inside the display (**Figure 4**), or placed in an external tabletop enclosure (**Figure 5**). An outdoor enclosure is also available for certain applications.



**Figure 3:** RC-200 Handheld Controller



**Figure 4:** Internal RC-200 Receiver



**Figure 5:** External RC-200 Base Station (Tabletop Enclosure)

### Important Installation Range Considerations

The wireless Base Station must be located at least 10' (3 m) from the wireless handheld controller and no more than 500' (152 m) away. If the wireless handheld is used outside this range, the wireless handheld signal may drop out. Ideally, the handheld controller should have a clear line-of-sight to the Base Station antenna. Make sure the Base Station antenna is pointed straight up for best reception (it should look like a capital "L" when viewed from the side).

## 3 RC-200 Handheld Controller

### Powering the Controller On & Off

#### Using the Keypad

- Press and hold the <ON/OFF> key momentarily to power on the controller. If the LCD does not display text within a few seconds, the internal battery is most likely dead and will need to be recharged. Refer to **Battery Recharging (p.5)**.
- Press and hold the <ON/OFF> key for 5 seconds to power off the controller. The LCD will display a power down message.

#### Using External Power

Plugging the wireless handheld controller into an external power source via the power connector on top of the unit will turn it on (and charge its internal batteries). The wireless handheld will not turn off if connected to external power. When connected to external power, the top line of the LCD will show a power plug (Figure 6).

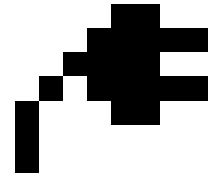

Figure 6: External Power Detect Status

When external power is removed and charging is complete, the wireless handheld will power down after a 5 second prompt to conserve battery power. Press any key during the prompt after disconnecting external power to keep the handheld unit powered on.

#### Battery Operation

When the controller is powered on, an indicator on the top line of the LCD shows the current battery status (Figure 7). The three segments within the battery will gradually disappear as the battery loses its charge.



Figure 7: Battery Status

#### Idle Time

When using battery power, by default the wireless handheld shuts itself off or “sleeps” automatically after 45 minutes of inactivity. The idle time setting may be turned off as described in **Config Mode (p.6)**, but to increase battery life, be sure to manually turn the unit off when it will be inactive for a long period of time.

#### Battery Recharging

A charger is contained inside the wireless handheld for recharging the batteries.

To recharge the batteries when not in use, simply connect an external power source to the power connector on top of the unit. A completely discharged battery will take approximately 1.5 hours of fast charging to recharge.

A power adapter is included with the wireless handheld controller for recharging the batteries and providing external power. Daktronics also offers a charging station capable of recharging up to 6 units at a time. Refer to **DWG-3639831** in **Appendix A** for more information on charging station operation.

## Config Mode

Config (“configuration”) mode (**Figure 8**) is used when a wireless server Base Station is not controlling a wireless handheld. Config mode is used to set up operational settings in the wireless handheld controller.

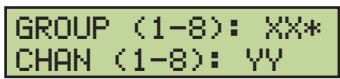

**Figure 8:** Config Mode LCD Icon



If the wireless handheld has not yet been configured for a specific channel, the Config mode will start automatically when the device is first powered on. If it has been previously configured, the wireless handheld will attempt to connect at the last connected channel.

- Configuration mode may be entered at any time by pressing and holding the **<CONFIG>** key for 5 seconds.
- Use the **<↑>** and **<↓>** arrow keys to move through the possible configuration items.

### Setting Default Radio Broadcast Group & Channel

Display	Action
	Press <b>&lt;ENTER&gt;</b> to set the default radio broadcast group and channel numbers.
 <p>XX = Broadcast Group # (Default: 1) YY = Channel # (Default: 1)</p> <p><b>Note:</b> For International units, only groups 1-4 are selectable.</p>	Use the number keys to enter the desired broadcast group and channel numbers. Press <b>&lt;ENTER&gt;</b> again to save the settings.  <b>Note:</b> The broadcast group and channel numbers should match the setting on the desired wireless Base Station to connect to on power-up.

### Setting LCD Contrast

Display	Action
	Press <b>&lt;ENTER&gt;</b> to set the contrast level.
 <p>NN = contrast value</p>	Use the up or down arrow keys on the keypad to set the desired contrast.  Press <b>&lt;ENTER&gt;</b> again to save the setting.

### Setting Power Save Mode

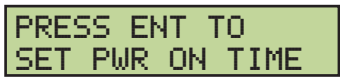
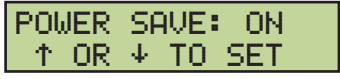
Display	Action
	Press <b>&lt;ENTER&gt;</b> to set the power off (idle) time. With this setting enabled, the controller will turn off automatically after 45 minutes of inactivity.
	Use the up or down arrow keys on the keypad to turn the power save mode ON or OFF.  Press <b>&lt;ENTER&gt;</b> again to save the setting.

## Connect Mode

Connect mode (**Figure 9**) is used when the wireless handheld is connected to a wireless server Base Station. In Connect mode, the wireless Base Station determines the operation of the handheld, and all operation is specific to the wireless Base Station Function selected.



**Figure 9:** Connect Mode LCD Icon

## Switching to Connect Mode

After all initialization and configuration is complete, the wireless handheld controller will be ready to connect to a wireless Base Station.

Display	Action
<p>INITIALIZING RADIO</p>	<p>Press &lt;CONNECT&gt; to create a connection to an available wireless Base Station on the broadcast group and channel numbers shown.</p> <p><b>Note:</b> The Wireless Base Station must be powered on and must be set to the specified broadcast group and channel.</p> <ul style="list-style-type: none"> <li>If a connection was made, the wireless handheld will be operating in Connect mode. Refer to the application-specific sections for operation details.</li> <li>If a connection could not be made, refer to <b>Section 17: Troubleshooting (p.36)</b> for information about how to resolve the problem.</li> </ul>
<p>CONNECTING VIA B: XX C: YY</p> <p>XX = Broadcast Group # YY = Channel #</p>	

## Signal Strength Indicator

Once a connection has been made, the top line of the LCD will show the signal strength (**Figure 10**). This indicator shows the approximate signal strength of the network connection. Each successive bar indicates an additional level of signal strength between the handheld and Base Station.

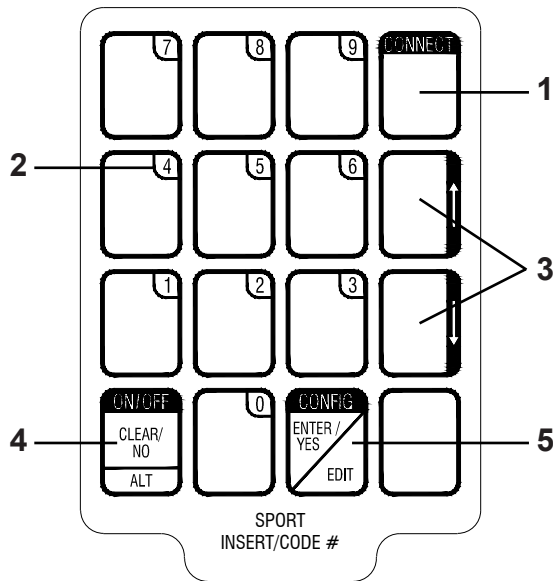

**Figure 10:** Signal Strength

When no bars or 1 bar is visible, the connection to the wireless network is likely to be limited, and the console may occasionally fail to respond. To improve signal strength, move within range of the Base Station, and remove any obstacles located between the Base Station and handheld controller if possible. For more information, refer to **Section 2: RC-200 System Overview (p.4)**.

## Common Keys

Several keys on the default keypad layout are common to multiple wireless handheld applications. These keys are noted in **Figure 11**. For a description of the function of keys for a particular application, refer to the application-specific sections of this manual.



**Figure 11:** Common RC-200 Keys

#	Key	Function
1	CONNECT	<p>This key is used to connect to a wireless Base Station. Refer to <b>Connect Mode (p.7)</b> for more information.</p> <p>Pressing <b>&lt;ALT&gt;</b> followed by <b>&lt;CONNECT&gt;</b> when a connection is made to a wireless Base Station will show Base Station revision information. Refer to <b>Base Station Errors (p.37)</b> for more information.</p>
2	Numbers	<p>These keys are used for numeric entry functions. While a particular key may normally be assigned to application-specific functions, in an Edit routine, they are also used to enter the number shown in the corner of the key.</p>
3	Up/Down Arrows	<p>These keys are used to navigate through menu choices and make certain selections. Arrows may also be assigned to application-specific functions.</p>
4	ON/OFF	<p>The <b>ON/OFF</b> operation of this key is described in <b>Powering the Controller On &amp; Off (p.5)</b>.</p>
	CLEAR/NO	<p>The <b>CLEAR</b> operation of this key pertains to editing and data entry routines. When editing a value, press <b>&lt;CLEAR&gt;</b> to remove that value. The <b>CLEAR</b> operation may also be used to escape out of an editing function. If a key was pressed inadvertently, or if the value being edited should not be changed, pressing <b>&lt;CLEAR&gt;</b> twice exits the editing routine without modifying the value.</p> <p>The <b>NO</b> operation of this key also pertains to editing and data entry routines. When a question prompt is shown on the LCD, press this key to answer the question with a "No."</p>
	ALT	<p>The <b>ALT</b> operation of this key selects alternate actions for certain application keys. Press this key before pressing another key to activate a secondary function. Refer to the section following this table for more information.</p>

#	Key	Function
5	CONFIG	The <b>CONFIG</b> operation of this key is described in <b>Config Mode (p.6)</b> .
	ENTER/YES	The <b>ENTER</b> function of this key pertains to editing and data entry routines. After editing a value, press <b>&lt;ENTER&gt;</b> to save the change.  The <b>YES</b> function of this key also pertains to editing and data entry routines. When a question prompt is shown on the LCD, press this key to answer the question with a "Yes."
	EDIT	The <b>EDIT</b> function of this key is used to edit the data associated with a particular key. For instance, pressing <b>&lt;EDIT&gt;</b> followed by a "+1" key will allow the operator to manually type in a new value using the number keys. Refer to the application-specific sections for more information about which keys have <b>EDIT</b> functionality.

### Alternate Function Keys

An alternate function of a key, if applicable, will be shown on the bottom the key below a horizontal line. Refer to **Figure 12** for an example.

- Press the key for primary function.
- Press **<ALT>** followed by the key for alternate function.

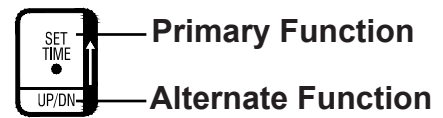

**Figure 12:** Key with ALT Functionality

## 4 All Sport Applications

This section provides information about the “All Sport” function of the RC-200 wireless Base Station. Refer to the sections following this section for sport-specific operation.

### Selecting All Sport Applications (Code Numbers)

To select a specific All Sport application (such as baseball, tennis, etc.) the “All Sport” function must first be set in the wireless Base Station.

Once the All Sport **function** has been selected, an All Sport **application** may be selected by entering a specific code number on the wireless handheld controller. This number is typically located on the bottom center of the keypad insert. These numbers are also listed in **Keypad Inserts (p.11)** and in the application-specific sections.

Display	Action
<div style="border: 1px solid black; padding: 2px; display: inline-block;">           ENTER CODE NN (APPLICATION)         </div> NN = current setting	<p>Enter the code number corresponding to the application using the number keys on the keypad. When the code number is correctly selected, a short description will be shown on the bottom line of the LCD.</p> <p><b>Note:</b> Since the wireless Base Station is typically used with a single application, once the code number has been set, the wireless Base Station will continue to use the same code number each time power is reset. To change code numbers, use the <b>&lt;NEW CODE&gt;</b> key on the wireless hand-held. Refer to <b>Common All Sport Application Keys (p.12)</b> for more information.</p>
<div style="border: 1px solid black; padding: 2px; display: inline-block;">           ENTER CODE NN NOT FOUND         </div>	<p>“NOT FOUND” is shown on bottom line of the LCD if the specified code number was not available. This typically means either the code was entered incorrectly, or the Base Station firmware does not support it. If this is a new code number that is not supported, the Base Station will need to be either replaced or reprogrammed. Contact Daktronics Customer Service. Refer to <b>Daktronics Exchange and Repair &amp; Return Programs (p.2)</b>.</p>
<div style="border: 1px solid black; padding: 2px; display: inline-block;">           RESUME PREVIOUS GAME?         </div>	<p>If the handheld controller is powered down and powered back on, the question at left will appear. Press <b>&lt;YES&gt;</b> to retain the previously-entered settings, or press <b>&lt;NO&gt;</b> to start a new game under the last code entered.</p>

**Note:** For RC-200 systems using a Controller Area Network (CAN), it will not be necessary to enter a sport code. Instead, the RC-200 will automatically detect the operation mode when correctly connected to a controller (typically an OmniSport 2000).



## Keypad Inserts

Keypad inserts allow a single console to control multiple sports and applications. Select the proper insert from the chart below and slide it into the opening on the bottom of the controller until it stops. To remove an insert, pull on the tab that extends from the controller.

If an insert is lost or damaged, a copy of the sport insert drawing, located in **Appendix B**, can be used until a replacement can be ordered.

Sport/Application	Insert Number	Code
Clock/Score	LL-2613	01
Volleyball	0G-239304	02
Baseball	LL-2605	03, 23
Play Clock / Pitch Timer	LL-2653	05
Segment Timer	LL-2613	06
Tennis	LL-2607	08
Sand Volleyball	LL-2607	09
Basketball	LL-2632	10
Football	0G-1031603	61, 62
Remote Start/Stop	0G-319079	98
Goal Judge	LL-2663	99
Judge's Console (CAN)	LL-2606	N/A
Rodeo (CAN)	LL-2608	N/A

### Keypad Insert Operation Concepts

A keypad insert identifies the keys required for normal operation of a specific sport or application. In most cases, pressing a key immediately changes the scoreboard/display. Keys that require entry of additional information are marked by a dot, (such as **<SET TIME •>**). This additional information is usually a number followed by the **<ENTER>** key.

Some keys are labeled **+1**. Pressing one of these keys once “increments”, or increases, the corresponding field on the scoreboard by one (such as score or period). A key with **-1** “decrements”, or decreases, by one.

On some inserts, certain keys have been grouped together under the heading **HOME** or **GUEST**. These keys are **team** keys and work the same for both teams. They affect the statistics only for that one team. Keys not under one of these headings are **Game** keys. They are general keys for the progress of the game (such as period or quarter). Other keys may be grouped in a similar way to emphasize that they work together.

## Common All Sport Application Keys

Several All Sport applications have keys with the same functionality, as described below.

**Note:** For other common wireless handheld keys, refer to **Common Keys (p.8)**.

### New Code (Alt. Function)

The **New Code** key (**Figure 13**) is used to select a new code number and change the current All Sport application.

**Applies to:** Baseball, Basketball, Clock/Score, Football, Goal Judge, Play Clock/Pitch Timer, Segment Timer, Tennis, Volleyball, Sand Volleyball

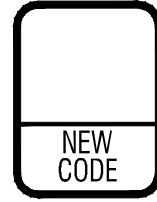

**Figure 13:**  
New Code Key

Display	Action
	<p>This key is typically implemented as an alternate function. Press <b>&lt;ALT&gt;</b> followed by <b>&lt;NEW CODE&gt;</b>.</p> <p>Press <b>&lt;ENTER&gt;</b> to select a new code number. Refer to <b>Selecting All Sport Applications (Code Numbers) (p.10)</b>.</p> <p><b>Note:</b> All data for the current application will be lost.</p> <p>Press <b>&lt;CLEAR&gt;</b> to cancel and resume normal operation.</p>

### New Game (Alt. Function)

The **New Game** key (**Figure 14**) is used to reset all current game data for a specific application. Use it to prepare for a new game by removing all data from the display.

**Applies to:** Baseball, Basketball, Clock/Score, Football, Volleyball

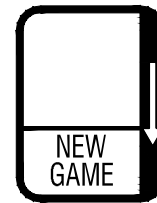

**Figure 14:**  
New Game Key

Display	Action
	<p>This key is typically implemented as an alternate function. Press <b>&lt;ALT&gt;</b> followed by <b>&lt;NEW GAME&gt;</b>.</p> <p>Press <b>&lt;ENTER&gt;</b> to start a new game.</p> <p><b>Note:</b> All data for the current game in progress will be lost.</p> <p>Press <b>&lt;CLEAR&gt;</b> to cancel and resume normal operation.</p>

## Start

Press **<START>** (Figure 15) to start the main clock.

**Applies to:** Baseball, Basketball, Clock/Score, Football, Play Clock/Pitch Timer, Remote Start/Stop, Sand Volleyball, Segment Timer, Tennis

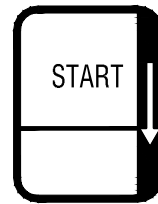
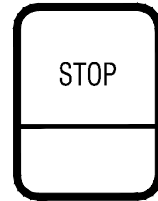

**Figure 15:**  
Start Key

## Stop

Press **<STOP>** (Figure 16) to stop the main clock.

**Applies to:** Baseball, Basketball, Clock/Score, Football, Play Clock/Pitch Timer, Remote Start/Stop, Sand Volleyball, Segment Timer, Tennis

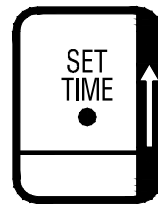

**Figure 16:**  
Stop Key

## Set Time

The **Set Time** key (Figure 17) is used to set or adjust the game time after the game clock has been stopped (or before it has started).

**Applies to:** Basketball, Clock/Score, Football, Play Clock/Pitch Timer, Sand Volleyball, Segment Timer, Tennis



**Figure 17:**  
Set Time Key

Display	Action
	<p>Press <b>&lt;SET TIME •&gt;</b> to display the current clock time. To change the time, enter the desired value the using the number keys on the keypad and press <b>&lt;ENTER&gt;</b>.</p>
 MM:SS.T = minutes, seconds, tenths of a second	<p>Press <b>&lt;SET TIME •&gt;</b> twice to display the Period time. To change the time, enter the desired value the using the number keys on the keypad and press <b>&lt;ENTER&gt;</b>. This replaces the Current time and becomes the default Period time for new games.</p> <p>Press <b>&lt;CLEAR&gt;</b> twice to cancel any changes and return to the game.</p>
	<p>If the clock is running when the <b>&lt;SET TIME •&gt;</b> key is pressed, the message at left will appear briefly. This feature may be used to view the current clock time on the controller.</p> <p><b>Note:</b> Only basketball supports tenths of a second. Baseball supports hours, minutes, and seconds.</p>

## UP/DN (Alt. Function)

The **UP/DN** key (**Figure 18**) is typically the alternate function of the **Set Time** key. This key lets the operator select whether the game clock counts up to the set time or counts down from the set time.

**Applies to:** Basketball, Clock/Score, Football, Play Clock/Pitch Timer, Sand Volleyball, Segment Timer, Tennis

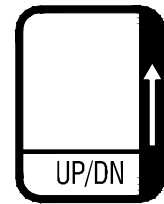

**Figure 18:**  
UP/DN Key

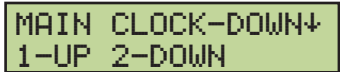
Display	Action
	<p>This key is typically implemented as an alternate function. After the main clock has been stopped, press <b>&lt;ALT&gt;</b> followed by <b>&lt;UP/DN&gt;</b> to set the direction of the clock.</p> <p>Press <b>&lt;1&gt;</b> or <b>&lt;2&gt;</b> to select <b>UP</b> or <b>DOWN</b> (default). The current direction of the clock is shown by an arrow on the LCD.</p>

## Dim (Alt. Function)

The **Dim** key (**Figure 19**) sets the dimming level (brightness) of the display.

**Applies to:** Baseball, Basketball, Clock/Score, Football, Play Clock/ Pitch Timer, Sand Volleyball, Segment Timer, Tennis, Volleyball

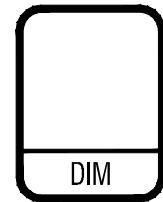

**Figure 19:**  
Dim Key

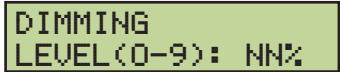
Display	Action
 <p>NN = current level</p> <p>NONE = <b>&lt;0&gt;</b>      50% = <b>&lt;5&gt;</b>            90% = <b>&lt;1&gt;</b>      40% = <b>&lt;6&gt;</b>            80% = <b>&lt;2&gt;</b>      30% = <b>&lt;7&gt;</b>            70% = <b>&lt;3&gt;</b>      20% = <b>&lt;8&gt;</b>            60% = <b>&lt;4&gt;</b>      10% = <b>&lt;9&gt;</b></p>	<p>This key is typically implemented as an alternate function. Press <b>&lt;ALT&gt;</b> followed by <b>&lt;DIM&gt;</b> to view the current dimming level.</p> <p>Press <b>&lt;0&gt;</b> (brightest) through <b>&lt;9&gt;</b> (dimmiest) to change the dimming level. Press <b>&lt;ENTER&gt;</b> to save.</p> <p>Press <b>&lt;CLEAR&gt;</b> to cancel and resume normal operation.</p>

## Manual Horn

Press the **<MANUAL HORN>** key (**Figure 20**) to sound the horn. The horn sounds as long as the key is pressed and stops sounding when the key is released.

**Applies to:** Basketball, Clock/Score, Football, Remote Start/Stop, Sand Volleyball, Segment Timer, Tennis



**Figure 20:**  
Manual Horn Key

## Auto Horn

Use the <AUTO HORN •> key (Figure 21) to set whether the horn sounds automatically when the main clock reaches 0:00.

**Applies to:** Basketball, Clock/Score, Football, Segment Timer

**Note:** For Football, Auto Horn is an alternate (<ALT>) function.



**Figure 21:**  
Auto Horn Key

Display	Action
	Press <AUTO HORN •> and then press <1> or <2> to select ON (default) or OFF.

When Auto Horn is enabled, a small 'h' will appear under the clock direction arrow on the LCD. Figure 22 shows an example where the clock is counting down and the auto horn is enabled.



**Figure 22:** Auto Horn Indicator



## 5 Clock/Score Operation

**Sport Insert: LL-2613**

**Code: 01** (Use Code 11 for optimized server/client operation.)

The sport insert drawing is located in **Appendix B**. If an insert is lost or damaged, a copy of the insert drawing can be used until a replacement arrives. Refer to **Powering the Controller On & Off (p.5)** for information on starting the console and **Common All Sport Application Keys (p.12)** for additional All Sport application keys.

### Score (+1/-1)

Display	Action
 <p>HOME SCORE + 1 NN</p> <p>NN = current setting</p>	<p>Press the home/guest <b>&lt;SCORE +1&gt;</b> key to increase the team score, or press the <b>&lt;SCORE -1&gt;</b> key to decrease the team score.</p> <p>The LCD shows which key was pressed and the new value.</p>
 <p>HOME SCORE EDIT NN*</p> <p>NN = current setting</p>	<p>Press <b>&lt;EDIT&gt;</b> followed by any score key to display the current setting. Enter the correct value using the number keys, and then press <b>&lt;ENTER&gt;</b>.</p>

### Period +1

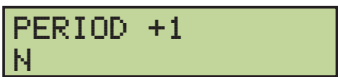
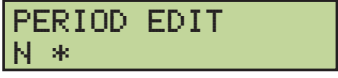
Display	Action
 <p>PERIOD +1 N</p> <p>N = current setting</p>	<p>Press <b>&lt;PERIOD +1&gt;</b> to increment the current period number.</p> <p>The new period number displays briefly.</p>
 <p>PERIOD EDIT N *</p> <p>N = current setting</p>	<p>Press <b>&lt;EDIT&gt;</b> followed by <b>&lt;PERIOD +1&gt;</b> to display the current setting. Enter the correct value using the number keys, and then press <b>&lt;ENTER&gt;</b>.</p>

### Set TOD (Alt. Function)

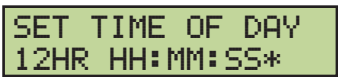
Display	Action
 <p>SET TIME OF DAY 12HR HH:MM:SS*</p> <p>HH:MM:SS = hours, mins, secs</p>	<p>Press <b>&lt;ALT&gt;</b> followed by <b>&lt;SET TOD&gt;</b> to set the Time of Day. Enter the correct number using the number keys, and then press <b>&lt;ENTER&gt;</b>. The time of day clock is now displayed, if the scoreboard has that capability.</p>



## 6 Volleyball Operation

**Sport Insert: 0G-239304**



**Code: 02**

The sport insert drawing is located in **Appendix B**. If an insert is lost or damaged, a copy of the insert drawing can be used until a replacement arrives. Refer to **Powering the Controller On & Off (p.5)** for information on starting the console and **Common All Sport Application Keys (p.12)** for additional All Sport application keys.

### Score (+1/-1)

Display	Action
 <p>HOME SCORE + 1 NN</p> <p>NN = current setting</p>	<p>Press the home/guest <b>&lt;SCORE +1&gt;</b> key to increase the team score, or press the <b>&lt;SCORE -1&gt;</b> key to decrease the team score.</p> <p>The LCD shows which key was pressed and the new value.</p>
 <p>HOME SCORE EDIT NN*</p> <p>NN = current setting</p>	<p>Press <b>&lt;EDIT&gt;</b> followed by any score key to display the current setting. Enter the correct value using the number keys, and then press <b>&lt;ENTER&gt;</b>.</p>

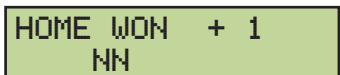
### Won (+1/-1)

Display	Action
 <p>HOME WON + 1 NN</p> <p>NN = current setting</p>	<p>Press the home/guest <b>&lt;WON +1&gt;</b> key to increase the games won, or press the <b>&lt;WON -1&gt;</b> key to decrease the games won.</p> <p>The LCD shows which key was pressed and the new value.</p>
 <p>HOME WON EDIT NN*</p> <p>NN = current setting</p>	<p>Press <b>&lt;EDIT&gt;</b> followed by either won key for the appropriate team to display the current setting. Enter the correct value using the number keys, and then press <b>&lt;ENTER&gt;</b>.</p>

### Reset Game Score

Display	Action
 <p>RESET GAME? ENTER TO ACCEPT</p>	<p>Press <b>&lt;RESET GAME SCORE&gt;</b> followed by <b>&lt;ENTER&gt;</b> to reset both home and guest scores to zero. This key is used to clear the Game Score fields at the beginning of each match.</p>

### Game (+1/-1)

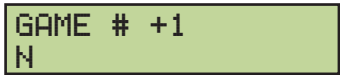
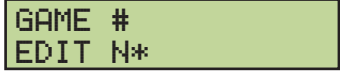
Display	Action
 <p>GAME # +1 N</p> <p>N = current setting</p>	<p>Press the <b>&lt;GAME +1&gt;</b> or <b>&lt;GAME -1&gt;</b> key to set the current game number.</p>
 <p>GAME # EDIT N*</p> <p>N = current setting</p>	<p>Press <b>&lt;EDIT&gt;</b> followed by either game key to display the current setting. Enter the correct value using the number keys, and then press <b>&lt;ENTER&gt;</b>.</p>



## 7 Baseball Operation

**Sport Insert:** LL-2605

**Code:** 03, 23

The sport insert drawing is located in **Appendix B**. If an insert is lost or damaged, a copy of the insert drawing can be used until a replacement arrives. Refer to **Powering the Controller On & Off (p.5)** for information on starting the console and **Common All Sport Application Keys (p.12)** for additional All Sport application keys.

### Score (+1/-1)

Display	Action
 <p>HOME SCORE + 1 NN</p> <p>NN = current setting</p>	<p>Press the home/guest <b>&lt;SCORE +1&gt;</b> key to increase the team score, or press the <b>&lt;SCORE -1&gt;</b> key to decrease the team score.</p> <p>The LCD shows which key was pressed and the new value.</p>
 <p>HOME SCORE EDIT NN*</p> <p>NN = current setting</p>	<p>Press <b>&lt;EDIT&gt;</b> followed by any score key to display the current setting. Enter the correct value using the number keys, and then press <b>&lt;ENTER&gt;</b>.</p>

### Out +1, Inning +1

Press **<OUT +1>** or **<INNING +1>** to increment the total outs or innings, respectively. The new numbers appear immediately on the LCD.



Display	Action
 <p>INNING # EDIT NN*</p> <p>NN = current setting</p>	<p>Press <b>&lt;EDIT&gt;</b> followed by <b>&lt;OUT +1&gt;</b> or <b>&lt;INNING +1&gt;</b> to display the current setting. Enter the correct value using the number keys, and then press <b>&lt;ENTER&gt;</b>.</p>

### Ball +1, Strike +1, Clear Ball & Strike

Press **<BALL +1>** or **<STRIKE +1>** to increment the pitch types. Press **<CLEAR BALL & STRIKE>** to immediately reset both values to 0.



**Note:** If the ball value is 4 when **<BALL +1>** is pressed, the value is blanked out. If the strike value is 3 when **<STRIKE +1>** is pressed, the value is blanked out.

### Hit

Display	Action
 <p>HIT ON</p>	<p>Press <b>&lt;HIT&gt;</b> to turn on the hit indicator or digits. Press <b>&lt;HIT&gt;</b> again to turn off the hit indicator or digits.</p> <p>The hit status displays briefly.</p> <p><b>Note:</b> When hit is already on, pressing <b>&lt;ERROR&gt;</b> will turn it off.</p>
 <p>HIT OFF</p>	



## Error

Display	Action
	Press <b>&lt;ERROR&gt;</b> to turn on the hit indicator or digits. Press <b>&lt;ERROR&gt;</b> again to turn off the hit indicator or digits.  The error status displays briefly.  <b>Note:</b> When error is already on, pressing <b>&lt;HIT&gt;</b> will turn it off.
	

## Time, At Bat, H/E (Alt. Function)

Press **<ALT>** followed by a key below to select what is displayed on the scoreboard:

- **<TIME>** shows two digits of time.
- **<AT BAT>** shows the player At Bat number.
- **<H/E>** shows an "H" or an "E" when **<HIT>** or **<ERROR>** is pressed.

## Time/At Bat

If the controller is set to show the time, the **<TIME/AT BAT •>** key operates like the standard **<SET TIME>** key. Refer to **Common All Sport Application Keys (p.12)**.

If the controller is set to show AT BAT, **<TIME/AT BAT •>** key operates as shown below.

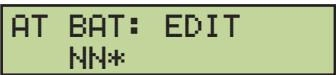
Display	Action
 NN = current setting	Press <b>&lt;TIME/AT BAT •&gt;</b> , enter the correct value using the number keys, and then press <b>&lt;ENTER&gt;</b> .

## 8 Play Clock & Pitch Timer Operation

Sport Insert: LL-2653

Code: 05

The sport insert drawing is located in **Appendix B**. If an insert is lost or damaged, a copy of the insert drawing can be used until a replacement arrives. Refer to **Powering the Controller On & Off (p.5)** for information on starting the console and **Common All Sport Application Keys (p.12)** for additional All Sport application keys.

### Set Reset 1, Set Reset 2

Display	Action
 MM:SS = minutes, seconds	Press <b>&lt;SET RESET 1 •&gt;</b> or <b>&lt;SET RESET 2 •&gt;</b> to set the current Reset 1 or Reset 2 value, respectively, for the play clock/pitch timer.  To change the time, enter the desired value the using the number keys, and then press <b>&lt;ENTER&gt;</b> .

### Reset 1, Reset 2

- Press **<RESET 1>** to return the timer to the Reset 1 value configured above.
- Press **<RESET 2>** to return the timer to the Reset 2 value configured above.

For more information about play clock setups featuring server/client Base Stations, refer to **DWG-3639940** in **Appendix A**.

## 9 Segment Timer Operation

**Sport Insert:** LL-2613

**Code:** 06

The sport insert drawing is located in **Appendix B**. If an insert is lost or damaged, a copy of the insert drawing can be used until a replacement arrives. Refer to **Powering the Controller On & Off (p.5)** for information on starting the console and **Common All Sport Application Keys (p.12)** for additional All Sport application keys.

### Segment Timer Information

The segment timer is used to time events such as practice sessions. Operation of the segment timer is determined by 40 segments of pre-programmed length. The segment timer will count down starting at the segment number that is set as **First Segment**. When the first segment is completed, the timer will count the preset **Interval Time** and move on to the next segment. The timer will continue counting segments until the segment number that is set as **Last Segment** is complete. It then will reset to the segment saved as the **First Segment** and will either begin counting down or wait for the **<START>** key to be pressed, depending on the **Auto Stop At Last Seg** setting. Refer to **Auto Stop (p.23)** to set the segment-stopping feature.

The **First Segment** and **Last Segment** values can be used to set up specific practice sessions. For example, the practice session for one sport could be programmed for 5-minute segments on segments 1–10, while another might use 10-minute segments on segments 11–20. Set the **First Segment** and **Last Segment** values to the desired segment numbers for the session, and the console will count down each of the segments in order. It may also be set to either stop on the last segment or loop back to the first segment segments, again based on the **Auto Stop At Last Seg** setting.

### Segment Number/Time

Display	Action
	Press <b>&lt;SEG. NO. • TIME •&gt;</b> to set individual segment times.
	Enter the segment to be edited using the number keys, and then press <b>&lt;ENTER&gt;</b> .
NN = segment number MM:SS = minutes, seconds	Enter the time for the segment using the number keys. Press <b>&lt;ENTER&gt;</b> to move to the next segment time.
	Press <b>&lt;ENTER&gt;</b> again to exit the function.

### First/Last Segment

Display	Action
	Press <b>&lt;FIRST/LAST SEGMENT&gt;</b> , use the number keys to enter the segment to be set as the first segment, and then press <b>&lt;ENTER&gt;</b> . Use the number keys to enter the segment to be set as the last segment, and then press <b>&lt;ENTER&gt;</b> .
NN = current first segment XX = current last segment	The console will be reset to the segment selected here when the <b>&lt;RESET TO FIRST SEGMENT&gt;</b> key is pressed. After the segment set as the last segment is completed, the console will automatically reset to the segment saved as the first segment.

## Current Segment +1

Press **<CURRENT SEGMENT +1>** to move to the next segment. The new segment number appears immediately on the LCD.

Display	Action
<p>MM:SS = minutes, seconds</p>	Press <b>&lt;EDIT&gt;</b> followed by <b>&lt;CURRENT SEGMENT +1&gt;</b> to display the current setting. Enter the correct value using the number keys, and then press <b>&lt;ENTER&gt;</b> .

## Reset Current Segment

Press **<RESET CURRENT SEGMENT>** to reset the segment time to the value specified by the current segment. The segment number will remain at the current value.

## Reset to First Segment

Press **<RESET TO FIRST SEGMENT>** to return to the first segment.

**Note:** This function is disabled while the clock is running.

## Interval Time

The interval time is the time between each segment.

Display	Action
<p>MM:SS = minutes, seconds</p>	Press <b>&lt;INTERVAL TIME •&gt;</b> to display the current value of interval time. Enter the interval time using the number keys, and then press <b>&lt;ENTER&gt;</b> .
<p>* = current setting</p>	<p>This setting determines whether the interval count will be displayed on the scoreboard.</p> <p>Press <b>&lt;1&gt;</b> to display the interval time on the scoreboard. Press <b>&lt;2&gt;</b> to disable interval time display. The interval time will be displayed only on the controller.</p> <p><b>Note:</b> Regardless of this setting, the value saved in interval time will be counted down between segments. Set the interval time to <b>00:00</b> if no interval between segments is desired.</p> <p><b>Note:</b> When the interval time is being displayed, the segment number on the scoreboard flashes to indicate that the time displayed is interval time.</p>

## Copy Range

This key sets a range of segments to a specific time value.

Display	Action
<p>MM:SS = minutes, seconds XX = starting segment value YY = ending segment value</p>	<p>Press <b>&lt;COPY RANGE •&gt;</b> and enter the time desired. Press <b>&lt;ENTER&gt;</b> to move to the next field. Enter the first and last segments that will have this time. When the last segment in the copy range is set, the menu will exit.</p> <p>Once completed, all segments from XX to YY (inclusive) will be set to the specified time.</p>

## Auto Stop

**Note:** To set the console to stop after the last segment in the series is completed, the auto stop at each segment setting must be set to **NO**.

Display	Action
<pre>STOP AT EACH SEG 1-YES 2*NO</pre> <p>* = current setting</p>	<p>Press &lt;AUTO STOP&gt; to enter this menu.</p> <ul style="list-style-type: none"> <li>Press &lt;1&gt; to set the console to stop after each segment is completed.</li> <li>Press &lt;2&gt; to set the console to automatically begin the next segment when each segment is completed.</li> </ul>
<pre>STOP AT LAST SEG 1*YES 2-NO</pre> <p>* = current setting</p>	<p>If Stop at Each Segment is set to <b>NO</b>, the console will prompt for the Auto Stop at Last Segment setting:</p> <ul style="list-style-type: none"> <li>Press &lt;1&gt; to set the console to stop when the last segment has been completed.</li> <li>Press &lt;2&gt; to set the console to start over at the first segment when the last segment is completed.</li> </ul>

## Warning Time

Display	Action
<pre>WARNING TIME MM:SS*</pre> <p>MM:SS = minutes, seconds</p>	<p>When the warning time is reached, the segment number flashes until the main clock reaches zero.</p> <p>Press &lt;WARNING TIME •&gt;, enter the time in minutes and seconds using the number keys, and then press &lt;ENTER&gt;.</p> <p>Enter 00:00 for no warning time (default).</p>

## 10 Tennis Operation



**Sport Insert:** LL-2607

**Code:** 08

The sport insert drawing is located in **Appendix B**. If an insert is lost or damaged, a copy of the insert drawing can be used until a replacement arrives. Refer to **Powering the Controller On & Off (p.5)** for information on starting the console and **Common All Sport Application Keys (p.12)** for additional All Sport application keys.

### Court Selection

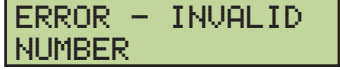

Multiple wireless handheld controllers may be connected to a single wireless Base Station in the Tennis application. Each connected handheld controller will operate a specific court, and the controller number for the handheld is selected when powered up.

Display	Action
 <p>ENTER CONTROLLER NUMBER NN*</p> <p>NN = current setting</p>	<p>Enter the controller number for the court that this particular handheld will operate, and then press <b>&lt;ENTER&gt;</b>.</p> <p>Typically, controller 1 would run court 1, controller 2 would run court 2, and so on. Some systems may be set up differently.</p>
 <p>ERROR - NUMBER TAKEN</p>	<ul style="list-style-type: none"> <li>If the number entered has already been selected for another controller, the error message at top left will display. Select another number.</li> <li>If the controller number entered is too high, the error message at bottom left will display. Select another number.</li> </ul>
 <p>ERROR - INVALID NUMBER</p>	

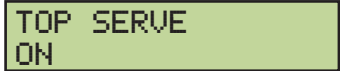
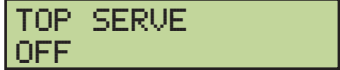
### Serve

Display	Action
 <p>TOP SERVE ON</p>	<p>Press the Top/Bottom <b>&lt;SERVE&gt;</b> key to turn the serve indicators ON or OFF for the respective player/team.</p> <p><b>Note:</b> When one serve indicator is already on, pressing the opposite <b>&lt;SERVE&gt;</b> key will turn it off.</p>
 <p>TOP SERVE OFF</p>	

### Game +1

Display	Action
 <p>GAMES WON +1 SET X TOP Y</p> <p>X = current set Y = games won</p>	<p>Press the Top/Bottom <b>&lt;GAME +1&gt;</b> key to increment the number of games won in the current set for the respective player/team.</p> <p>The LCD shows which key was pressed and the new value.</p>
 <p>GAMES WON EDIT SET X TOP Y</p> <p>X = current set Y = games won</p>	<p>Press <b>&lt;EDIT&gt;</b> followed by the Top/Bottom <b>&lt;GAME +1&gt;</b> key to display the current setting. Enter the correct value using the number keys, and then press <b>&lt;ENTER&gt;</b>.</p>

## Point

Press the Top/Bottom **<POINT>** key to increment the total points for the respective player/team. The points will increment as 15, 30, 40 AD or GA. If **Tie Break** scoring mode is selected, the points will increment by 1. The new point values appear immediately on the LCD.

Display	Action
<pre>TOP=NN*  BOT= EDIT TOP</pre> <p>NN = current setting</p>	Press <b>&lt;EDIT&gt;</b> followed by the Top/Bottom <b>&lt;POINT&gt;</b> key to display the current setting. Enter the correct value using the number keys, and then press <b>&lt;ENTER&gt;</b> .

## Reset Game

Press **<RESET GAME>** to immediately reset the player points for the current game.

## Tie Break

Press **<TIE BREAK>** to set the mode of scoring to **Tie Break** mode. In **Tie Break** scoring mode, player points increase by one with each press of the **<POINTS>** key.

**Note:** Tie Break scoring mode may only be selected when both player point values are 0. To change scoring mode back to normal, press the **<RESET GAME>** key.

## TOD/Game

The **<TOD/GAME >** key toggles the console between displaying game time or time of day (TOD) and allows the operator to change the time of day.

Display	Action
<pre>SET TIME OF DAY 12HR HH:MM:SS*</pre> <p>HH:MM:SS = hours, mins, secs</p>	Press <b>&lt;TOD/GAME &gt;</b> to set the Time of Day. Enter the correct value using the number keys, and then press <b>&lt;ENTER&gt;</b> . The time of day clock is now displayed, if the scoreboard has that capability.

## Set +1

Press **<SET +1>** to increment the current set number. The new set number appears immediately on the LCD.

Display	Action
<pre>SET EDIT NN</pre> <p>NN = current setting</p>	Press <b>&lt;EDIT&gt;</b> followed by <b>&lt;SET +1&gt;</b> to display the current setting. Enter the correct value using the number keys, and then press <b>&lt;ENTER&gt;</b> .
<pre>INVALID SET PLEASE RE-ENTER</pre>	If the set number entered is invalid, the error message at left will display. Enter another set number.

## Matches Won (Alt. Function)

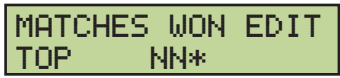
Display	Action
 NN = current setting	Press <b>&lt;ALT&gt;</b> followed by the Top/Bottom <b>&lt;MATCHES WON&gt;</b> key to display the matches won. Enter the correct value using the number keys, and then press <b>&lt;ENTER&gt;</b> .

## Reset Match (Alt. Function)

Display	Action
	Press <b>&lt;ALT&gt;</b> followed by <b>&lt;RESET MATCH&gt;</b> . Press <b>&lt;ENTER&gt;</b> to reset the current match, or press <b>&lt;CLEAR&gt;</b> to cancel.  All set scores and the current game score will be cleared, and the set number will return to 1.

## Next Match (Alt. Function – DakTennis Only)

Display	Action
	Press <b>&lt;ALT&gt;</b> followed by <b>&lt;NEXT MATCH&gt;</b> to tell the DakTennis™ software to switch to the next match. The LCD will show that the next match was selected.

## Winner (Alt. Function – DakTennis Only)

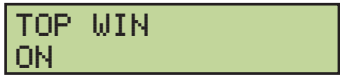
Display	Action
	Press <b>&lt;ALT&gt;</b> followed by <b>&lt;WINNER&gt;</b> for the Top/Bottom player/team to tell the DakTennis™ software to set them as the winner if currently off or clear the winner if currently on. The LCD will show the status of the winner being set ON or OFF.

For more information, refer to the **DakTennis Version 3 Installation & Operation Manual (DD1965926)**, available online at [www.daktronics.com/manuals](http://www.daktronics.com/manuals).



# 11 Sand Volleyball Operation

**Sport Insert:** LL-2607

**Code:** 09

The sport insert drawing is located in **Appendix B**. If an insert is lost or damaged, a copy of the insert drawing can be used until a replacement arrives. Refer to **Powering the Controller On & Off (p.5)** for information on starting the console and **Common All Sport Application Keys (p.12)** for additional All Sport application keys.

## Court Selection

Multiple wireless handheld controllers may be connected to a single wireless Base Station in the Sand Volleyball application. Each connected handheld controller will operate a specific court, and the controller number for the handheld is selected when powered up.

Display	Action
<div style="border: 1px solid black; padding: 2px; background-color: #d9ead3;">ENTER CONTROLLER NUMBER NN*</div> <p>NN = current setting</p>	<p>Enter the controller number for the court that this particular handheld will operate and then press <b>&lt;ENTER&gt;</b>.</p> <p>Typically, controller 1 would run court 1, controller 2 would run court 2, and so on. Some systems may be set up differently.</p>
<div style="border: 1px solid black; padding: 2px; background-color: #d9ead3;">ERROR - NUMBER TAKEN</div>	<ul style="list-style-type: none"> <li>• If the number entered has already been selected for another controller, the error message at top left will display. Select another number.</li> <li>• If the controller number entered is too high, the error message at bottom left will display. Select another number.</li> </ul>
<div style="border: 1px solid black; padding: 2px; background-color: #d9ead3;">ERROR - INVALID NUMBER</div>	

**Note:** On the sport insert and LCD, "TOP" = HOME and "BOT" = GUEST.

## Serve

Display	Action
<div style="border: 1px solid black; padding: 2px; background-color: #d9ead3;">TOP SERVE ON</div>	<p>Press the Top/Bottom <b>&lt;SERVE&gt;</b> key to turn the serve indicators ON or OFF for the respective team.</p> <p><b>Note:</b> When one serve indicator is already on, pressing the opposite <b>&lt;SERVE&gt;</b> key will turn it off.</p>
<div style="border: 1px solid black; padding: 2px; background-color: #d9ead3;">TOP SERVE OFF</div>	

## Point

Press the Top/Bottom **<POINT>** key to increment the total points by 1 for the respective team in the currently selected set. The new point values appear immediately on the LCD.

Display	Action
<div style="border: 1px solid black; padding: 2px; background-color: #d9ead3;">SCORE EDIT TOP NN*</div> <p>NN = current setting</p>	<p>Press <b>&lt;EDIT&gt;</b> followed by the Top/Bottom <b>&lt;POINT&gt;</b> key to display the current setting. Enter the correct value using the number keys, and then press <b>&lt;ENTER&gt;</b>.</p>

## Set +1

Press **<SET +1>** to increment the current set number. The new set number appears immediately on the LCD. The scores will be set to 0 for each team, if they do not already have points entered for the set.

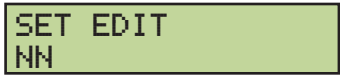
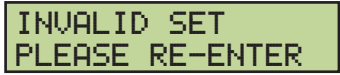
Display	Action
 NN = current setting	Press <b>&lt;EDIT&gt;</b> followed by <b>&lt;SET +1&gt;</b> to display the current setting. Enter the correct value using the number keys, and then press <b>&lt;ENTER&gt;</b> .
	If the set number entered is invalid, the error message at left will display. Enter another set number.

## Reset Game (Reset Match)

Display	Action
	Press <b>&lt;RESET GAME&gt;</b> followed by <b>&lt;ENTER&gt;</b> to confirm resetting the current match. This is typically performed after completion of the final set.  All scores will be cleared, and the set number will return to 1.

## TOD/Game

The **<TOD/GAME •>** key toggles the console between displaying game time or time of day (TOD) and allows the operator to change the time of day.

Display	Action
 HH:MM:SS = hours, mins, secs	Press <b>&lt;TOD/GAME&gt;</b> to set the Time of Day. Enter the correct value using the number keys, and then press <b>&lt;ENTER&gt;</b> . The time of day clock is now displayed, if the scoreboard has that capability.

## Matches Won (Alt. Function)

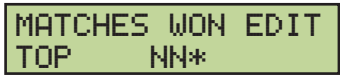
Display	Action
 NN = current setting	Press <b>&lt;ALT&gt;</b> followed by the Top/Bottom <b>&lt;MATCHES WON&gt;</b> key to display the matches won. Enter the correct value using the number keys, and then press <b>&lt;ENTER&gt;</b> .

## Game +1, Tie Break, Next Match, Winner

These keys are not used for Sand Volleyball mode.



## 12 Basketball Operation

**Sport Insert:** LL-2632

**Code:** 10 (Use Code 20 for optimized server/client operation.)

The sport insert drawing is located in **Appendix B**. If an insert is lost or damaged, a copy of the insert drawing can be used until a replacement arrives. Refer to **Powering the Controller On & Off (p.5)** for information on starting the console and **Common All Sport Application Keys (p.12)** for additional All Sport application keys.



### Score (+1/+2)

Display	Action
 <p>HOME SCORE + 1 NNN</p> <p>NNN = current setting</p>	<p>Press the home/guest <b>&lt;SCORE +1&gt;</b> or <b>&lt;SCORE +2&gt;</b> key to increase the team score by the value printed on the key.</p> <p>The LCD shows which key was pressed and the new value.</p>
 <p>HOME SCORE EDIT NNN*</p> <p>NNN = current setting</p>	<p>Press <b>&lt;EDIT&gt;</b> followed by any score key to display the current setting. Enter the correct value using the number keys, and then press <b>&lt;ENTER*&gt;</b>.</p>

### Score (+3/-1) (Alt. Functions)

Display	Action
 <p>HOME SCORE + 3 NNN</p> <p>NNN = current setting</p>	<p>Press <b>&lt;ALT&gt;</b> followed by the home/guest <b>&lt;SCORE +3&gt;</b> key to increase the team score, or the <b>&lt;SCORE -1&gt;</b> key to decrease the team score.</p> <p>The LCD shows which key was pressed and the new value.</p>

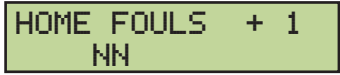
### Fouls +1

Display	Action
 <p>HOME FOULS + 1 NN</p> <p>NN = current setting</p>	<p>Press the home/guest <b>&lt;FOULS +1&gt;</b> key to increase the number of team fouls.</p> <p>The LCD shows which key was pressed and the new value.</p>
 <p>HOME FOULS EDIT NN*</p> <p>NN = current setting</p>	<p>Press <b>&lt;EDIT&gt;</b> followed by any fouls key to display the current setting. Enter the correct value using the number keys, and then press <b>&lt;ENTER&gt;</b>.</p>

### Possession

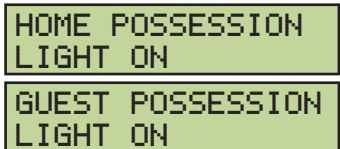
Display	Action
 <p>HOME POSSESSION LIGHT ON</p> <p>GUEST POSSESSION LIGHT ON</p>	<p>Press <b>&lt;POSS&gt;</b> to light the appropriate indicator. Each press will turn the other possession light on.</p>

## Period +1

Display	Action
<pre>PERIOD +1 NN</pre> <p>N = current setting</p>	<p>Press <b>&lt;PERIOD +1&gt;</b> to increment the current period.</p> <p>The new period number displays briefly.</p>
<pre>PERIOD EDIT N *</pre> <p>N = current setting</p>	<p>Press <b>&lt;EDIT&gt;</b> followed by <b>&lt;PERIOD +1&gt;</b> to display the current setting. Enter the correct value using the number keys, and then press <b>&lt;ENTER&gt;</b>.</p>

## Set TOD (Alt. Function)

Display	Action
<pre>SET TIME OF DAY 12HR HH:MM:SS*</pre> <p>HH:MM:SS = hours, mins, secs</p>	<p>Press <b>&lt;ALT&gt;</b> followed by <b>&lt;SET TOD&gt;</b> to set the Time of Day. Enter the correct number using the number keys, and then press <b>&lt;ENTER&gt;</b>. The time of day clock is now displayed, if the scoreboard has that capability.</p>

## 1/10 SEC (Alt. Function)

Display	Action
<pre>TIME MM:SS ↓ H- G-</pre> <p>MM:SS = minutes, seconds</p>	<p>Press <b>&lt;ALT&gt;</b> followed by <b>&lt;1/10 SEC&gt;</b> to toggle showing 1/10 of a second on the main clock.</p> <p>The top line of the LCD immediately updates to show the extra tenth of a second.</p>
<pre>TIME MM:SS.T ↓ H- G-</pre> <p>MM:SS.T = minutes, seconds, tenths of a second</p>	

## Bonus (Alt. Function)

Display	Action
<pre>HOME BONUS LIGHT 1-ON-1</pre>	<p>Press <b>&lt;ALT&gt;</b> followed by the home/guest <b>&lt;BONUS&gt;</b> key to turn on the 1-ON-1 bonus light.</p>
<pre>HOME BONUS LIGHT 2-SHOT</pre>	<p>Press <b>&lt;ALT&gt;</b> followed by the same <b>&lt;BONUS&gt;</b> key a second time to turn on the 2 SHOT bonus light.</p>
<pre>HOME BONUS LIGHT OFF</pre>	<p>Press <b>&lt;ALT&gt;</b> followed by the same <b>&lt;BONUS&gt;</b> key a third time to turn on the bonus light OFF.</p>



## 13 Football Operation

**Sport Insert: 0G-1031603**

**Code: 61, 62**

The sport insert drawing is located in **Appendix B**. If an insert is lost or damaged, a copy of the insert drawing can be used until a replacement arrives. Refer to **Powering the Controller On & Off (p.5)** for information on starting the console and **Common All Sport Application Keys (p.12)** for additional All Sport application keys.

### Score (+1/+6)

Display	Action
 <p>HOME SCORE + 1 NNN</p> <p>NNN = current setting</p>	<p>Press the home/guest <b>&lt;SCORE +1&gt;</b> or <b>&lt;SCORE +6&gt;</b> key to increase the team score by the value printed on the key.</p> <p>The LCD shows which key was pressed and the new value.</p>
 <p>HOME SCORE EDIT NNN*</p> <p>NNN = current setting</p>	<p>Press <b>&lt;EDIT&gt;</b> followed by any score key to display the current setting. Enter the correct value using the number keys, and then press <b>&lt;ENTER*&gt;</b>.</p>

### Score (+3/-1) (Alt. Functions)

Display	Action
 <p>HOME SCORE + 3 NNN</p> <p>NNN = current setting</p>	<p>Press <b>&lt;ALT&gt;</b> followed by the home/guest <b>&lt;SCORE +3&gt;</b> key to increase the team score, or the <b>&lt;SCORE -1&gt;</b> key to decrease the team score.</p> <p>The LCD shows which key was pressed and the new value.</p>

### QTR +1

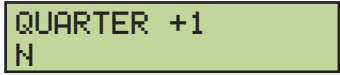
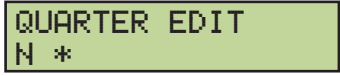
Display	Action
 <p>QUARTER +1 N</p> <p>N = current setting</p>	<p>Press <b>&lt;QTR +1&gt;</b> to increment the current quarter.</p> <p>The new quarter number displays briefly.</p>
 <p>QUARTER EDIT N *</p> <p>N = current setting</p>	<p>Press <b>&lt;EDIT&gt;</b> followed by <b>&lt;QTR +1&gt;</b> to display the current setting. Enter the correct value using the number keys, and then press <b>&lt;ENTER&gt;</b>.</p>

### Down +1

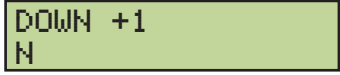
Display	Action
 <p>DOWN +1 N</p> <p>N = current setting</p>	<p>Press the <b>&lt;DOWN +1&gt;</b> key to increment the down number. The value increments from 1 to 4 then repeats.</p>

Display	Action
<div style="border: 1px solid black; padding: 5px; background-color: #d9ead3;"> DOWN EDIT  N* </div> <p>N = current setting</p>	Press <EDIT> followed by <DOWN +1> to display the current setting. Enter the correct value using the number keys, and then press <ENTER>.

## To Go

Display	Action
<div style="border: 1px solid black; padding: 5px; background-color: #d9ead3;"> TO GO EDIT  NN* </div> <p>NN = current setting</p>	Press <TO GO •> to set the distance to go until first down. Enter the correct value using the number keys, and then press <ENTER>.

## Ball On

Display	Action
<div style="border: 1px solid black; padding: 5px; background-color: #d9ead3;"> BALL ON EDIT  NN* </div> <p>NN = current setting</p>	Press <BALL ON •> to set the yard line of the ball. Enter the correct value using the number keys, and then press <ENTER>.

## TOL -1

Display	Action
<div style="border: 1px solid black; padding: 5px; background-color: #d9ead3;"> HOME TOL - 1  N </div> <p>N = current setting</p>	Press the home/guest <TOL -1> key to decrement the number of Time Outs Left (TOL). By default, each team starts the game with 3 time outs.
<div style="border: 1px solid black; padding: 5px; background-color: #d9ead3;"> HOME TOL  EDIT N* </div> <p>N = current setting</p>	Press <EDIT> followed by any TOL key to display the current setting. Enter the correct value using the number keys, and then press <ENTER>.

## Possession (Alt. Function)

Display	Action
<div style="border: 1px solid black; padding: 5px; background-color: #d9ead3;"> HOME POSS  LIGHT ON </div> <div style="border: 1px solid black; padding: 5px; background-color: #d9ead3;"> HOME POSS  LIGHT OFF </div>	Press <ALT> followed by the home/guest <POSS> key to light the possession indicator. A second press will turn the indicator off, as will turning on the opposing team's indicator.



# 14 Remote Start/Stop Operation

Sport Insert: 0G-319079



Code: 98

The sport insert drawing is located in **Appendix B**. If an insert is lost or damaged, a copy of the insert drawing can be used until a replacement arrives. Refer to **Powering the Controller On & Off (p.5)** for information on starting the console and **Common All Sport Application Keys (p.12)** for additional All Sport application keys.

## Start

Display	Action
	When the clock is stopped, the LCD will show the clock status on the bottom line as OFF.  Press <b>&lt;START&gt;</b> and the top line of the LCD will briefly show the function, and then the clock status will change to RUN.
	

## Stop

Display	Action
	When the clock is already running, the LCD will show the clock status on the bottom line as RUN.  Press <b>&lt;STOP&gt;</b> and the top line of the LCD will briefly show the function, and then the clock status will change back to OFF.
	

## Manual Horn/Reset

Depending on the current jack the Base Station is connected to on the All Sport 5000 controller, this key will have different functions:

- When connected to the **J4** (main clock) jack, the key functions as a manual horn.
- When connected to the **J7** (shot/play clock) jack, the key functions as a timer reset.

For more information on Remote Start/Stop setups, refer to **DWG-3660093** in **Appendix A**.

# 15 Goal Judge Operation

**Sport Insert:** LL-2663  
**Code:** 99

The sport insert drawing is located in **Appendix B**. If an insert is lost or damaged, a copy of the insert drawing can be used until a replacement arrives. Refer to **Powering the Controller On & Off (p.5)** for information on starting the console and **Common All Sport Application Keys (p.12)** for additional All Sport application keys.

**Note:** When using the RC-200 as a Goal Judge console, operators should disable the auto power off setting. Refer to **Setting Power Save Mode (p.6)**.

## Goal Light On/Off

Display	Action
	Press <GOAL LIGHT ON/OFF> to turn the goal lights ON if they are off, or OFF if they are already on.

For more information about goal judge setups, refer to **DWG-3640999** in **Appendix A**.



# 16 CAN Handheld Operation

This section describes operation details specific to CAN (Controller Area Network) handheld operations. CAN handheld functionality is used when handheld operation is controlled by a device on the CAN network such as the OmniSport 2000 timing console. Refer to **DWG-3640329** in **Appendix A** for typical CAN setup information.

## Common CAN Handheld Operation

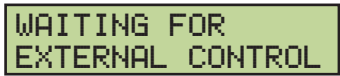
Display	Action
	<p>When the message at left is shown on the LCD, the Base Station is waiting to be connected to an external device on the CAN network.</p> <p>When a CAN device is detected, the LCD will update to show application-specific information.</p>

## Diving & Synchronized Swimming Operations

**Sport Insert: LL-2606**

Refer to the **Judge Consoles** section of the **OmniSport 2000 Timing Console Operations Manual (ED-13312)** for application-specific operation instructions. This manual is available online at [www.daktronics.com/manuals](http://www.daktronics.com/manuals).

## Rodeo Operations

**Sport Insert: LL-2608**

Refer to the **Judge's Console Operation** section of the **OmniSport 2000 Rodeo Timer Operations Manual (ED-14843)** for application-specific operation instructions. This manual is available online at [www.daktronics.com/manuals](http://www.daktronics.com/manuals).

# 17 Troubleshooting

## Handheld Controller Error Messages

Display	Cause/Solution
<div data-bbox="297 373 630 443" style="border: 1px solid black; padding: 2px; background-color: #e0e0e0;">           NO SERVER FOUND            B: XX C: YY         </div> <p data-bbox="297 453 574 506">XX = Broadcast Group # YY = Channel #</p> <div data-bbox="297 569 630 638" style="border: 1px solid black; padding: 2px; background-color: #e0e0e0;">           ENT TO RETRY            CLEAR SETS CHAN         </div>	<p data-bbox="675 369 1390 426">The wireless handheld could not find a server on the specified broadcast group and channel.</p> <ul data-bbox="675 443 1422 741" style="list-style-type: none"> <li data-bbox="675 443 1422 499">• Make sure the wireless Base Station is powered on, and is set for the specified broadcast group and channel.</li> <li data-bbox="675 516 1422 573">• Make sure the handheld is within minimum and maximum range limits. Refer to <b>RC-200 System Overview (p.4)</b>.</li> <li data-bbox="675 590 1422 667">• Press <b>&lt;ENTER&gt;</b> to retry the connection (if the handheld was just moved in range or the wireless Base Station has been correctly configured).</li> <li data-bbox="675 684 1422 741">• Press <b>&lt;CLEAR&gt;</b> to set the broadcast group and channel to a different number and retry.</li> </ul>
<div data-bbox="297 772 630 842" style="border: 1px solid black; padding: 2px; background-color: #e0e0e0;">           NO RESPONSE ON            B: XX C: YY         </div> <p data-bbox="297 852 574 905">XX = Broadcast Group # YY = Channel #</p> <div data-bbox="297 1094 630 1163" style="border: 1px solid black; padding: 2px; background-color: #e0e0e0;">           ENT TO RETRY            CLEAR SETS CHAN         </div>	<p data-bbox="675 768 1401 825">The wireless handheld <b>did</b> find a server on the specified broadcast group and channel, but the server did not respond.</p> <ul data-bbox="675 842 1401 1245" style="list-style-type: none"> <li data-bbox="675 842 1401 898">• Make sure the handheld is within minimum and maximum range limits. Refer to <b>RC-200 System Overview (p.4)</b>.</li> <li data-bbox="675 915 1401 972">• Cycle power to the wireless Base Station and retry the connection.</li> <li data-bbox="675 989 1401 1066">• Make sure that there are no other wireless Base Stations within range on the same group or channel. Try a different group/channel if necessary.</li> <li data-bbox="675 1083 1401 1161">• Press <b>&lt;ENTER&gt;</b> to retry the connection (if the handheld was just moved in range or the wireless Base Station has been correctly configured).</li> <li data-bbox="675 1178 1401 1245">• Press <b>&lt;CLEAR&gt;</b> to set the group/channel to a different number and retry.</li> </ul>
<div data-bbox="297 1310 630 1379" style="border: 1px solid black; padding: 2px; background-color: #e0e0e0;">           ERROR - THIS            CHANNEL IN USE         </div>	<p data-bbox="675 1306 1373 1392">The message at left is displayed if another wireless handheld controller is currently connected to the Base Station and the application does not permit multiple handheld units.</p> <p data-bbox="675 1430 1393 1516">Power off any other unused handheld units on the same channel in the area. Refer to <b>Powering the Controller On &amp; Off (p.5)</b>.</p> <p data-bbox="675 1549 1393 1635">Although multiple wireless handheld controllers may be connected to a single Base Station, the following applications only allow <b>one</b> handheld device to be connected at a time:</p> <ul data-bbox="675 1669 1154 1812" style="list-style-type: none"> <li data-bbox="675 1669 846 1696">• Baseball</li> <li data-bbox="675 1696 846 1724">• Basketball</li> <li data-bbox="675 1724 846 1751">• Clock/Score</li> <li data-bbox="675 1751 846 1778">• Football</li> <li data-bbox="675 1778 846 1806">• Goal Judge</li> <li data-bbox="870 1669 1154 1696">• Play Clock/Pitch Timer</li> <li data-bbox="870 1696 1154 1724">• Remote Start/Stop</li> <li data-bbox="870 1724 1154 1751">• Segment Timer</li> <li data-bbox="870 1751 1154 1778">• Volleyball</li> </ul>

Display	Cause/Solution
<div style="border: 1px solid black; padding: 2px; margin-bottom: 5px;">LOW SIGNAL STRENGTH</div> <div style="border: 1px solid black; padding: 2px;">PRESS CLEAR FOR CONFIG MENU</div>	<p>The Base Station has stopped responding to the wireless handheld. This could mean any following scenario is true:</p> <ul style="list-style-type: none"> <li>• The Base Station was turned off or has lost power.</li> <li>• The Base Station was changed to a different broadcast group or channel.</li> <li>• The Base Station and handheld are too far away or too close. Refer to <b>RC-200 System Overview (p.4)</b>.</li> </ul> <p>If all of these problems have been checked and the handheld still shows Low Signal Strength, cycle power on both the handheld and Base Station.</p>

## Base Station Errors

### IN RANGE LED On Start-up

The **IN RANGE** LED flashes several times at start-up while the server Base Station searches for other Base Stations on the same channel within range. If another server Base Station is found, this LED will flash continuously, indicating that only one server Base Station is allowed on a given channel.

### General Base Station Failures

The wireless Base Station uses the on-board LEDs to indicate failure status. When a failure occurs, the **DATA OUT / TX** and **IN RANGE** LEDs flash in a repetitive pattern to indicate the failure type. The LEDs will flash on for a long period of time, followed by a series of short flashes that give the error type. This sequence will repeat 5 times, after which the Base Station will reset.

If an error sequence is being displayed on the LEDs, first cycle power to the wireless Base Station by disconnecting power for several seconds and then reconnecting. If the problem persists, please contact Daktronics Customer Service. Refer to **Daktronics Exchange and Repair & Return Programs (p.2)**.

### Obtaining Base Station Status Information

When connected to a wireless Base Station in any All Sport function, the wireless handheld can obtain status information about the Base Station. This information includes the Base Station broadcast group/channel, firmware version number, and region.

Display	Action
<div style="border: 1px solid black; padding: 2px; margin-bottom: 5px;">VN.N DD-3561942</div> <div style="border: 1px solid black; padding: 2px;">BG:XX CH:YY R</div> <p>N.N = firmware version  XX = broadcast group #  YY = channel #  R = region (D for Domestic,  I for International)</p>	<p>Press <b>&lt;ALT&gt;</b> followed by <b>&lt;CONNECT&gt;</b> to display Base Station status information.</p> <p>Press any key to return to normal operation.</p>

*This page intentionally left blank.*

# A Reference Drawings

Refer to **Resources (p.1)** for information regarding how to read the drawing number. Any contract-specific drawings take precedence over the general drawings.

## Reference Drawings:

Charging Station- Specifications and Operation .....	<b>DWG-3639831</b>
System Riser Diagram: RC-200- Baseball/Tennis.....	<b>DWG-3639930</b>
System Riser Diagram: RC-200 Server/Client Line .....	<b>DWG-3639940</b>
System Riser; Tennis; Remote Base Station.....	<b>DWG-3640082</b>
System Riser; Tennis; Multi-Court, DakTennis, Radio, CG .....	<b>DWG-3640119</b>
System Riser Diagram; DakTennis, Video Control .....	<b>DWG-3640268</b>
System Riser; Indoor/Outdoor Single Court, RC-200 .....	<b>DWG-3640312</b>
System Riser: RC-200, Rodeo/Diving/Sync Swimming .....	<b>DWG-3640329</b>
System Riser; Tennis; Outdoor Multi-Court, CG.....	<b>DWG-3640342</b>
System Riser; Tennis; Indoor Multi-Court, CG .....	<b>DWG-3640403</b>
Base Station: Indoor Installation .....	<b>DWG-3640534</b>
Base Station: Outdoor Installation .....	<b>DWG-3640913</b>
Base Station: DistaView Scoreboard Installation .....	<b>DWG-3640952</b>
Riser Diagram: Goal Indicator System w/ RC-200.....	<b>DWG-3640999</b>
System Riser; Tennis; Multi-Court, RC-200 Direct.....	<b>DWG-3641206</b>
System Riser, RC-100 Game/DOG Clock Remote St/St .....	<b>DWG-3660093</b>

*This page intentionally left blank.*

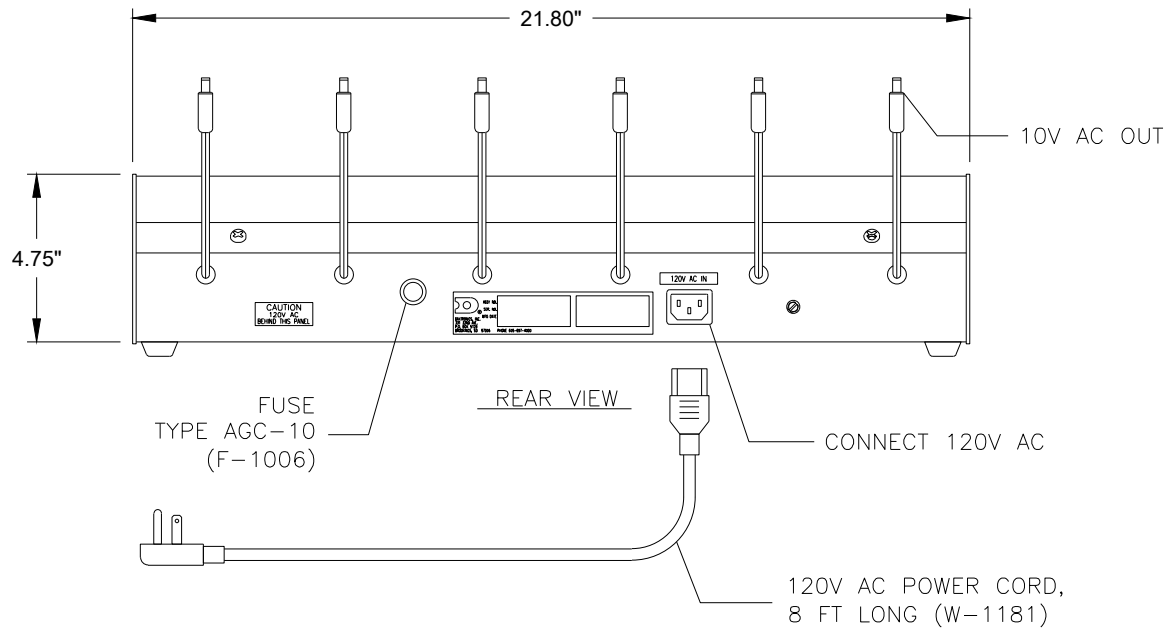

THE RC-200 CHARGING STATION WILL PROVIDE POWER TO CHARGE THE BATTERY IN UP TO SIX RC-200 CONSOLES AT ONE TIME.

PLACE RC-200 CONSOLES FACE DOWN ON THE FRONT OF THE CHARGING STATION. PLUG THE CORDS INTO THE POWER JACKS ON THE CONSOLES. CONNECT THE 120V AC POWER CORD INTO THE JACK IN THE BACK OF THE CHARGING STATION.

THE CONSOLES CAN REMAIN CONNECTED TO THE CHARGING STATION AFTER CHARGING IS COMPLETE. THE BATTERY IN THE RC-200 IS NOT FIELD REPLACEABLE. IF A BATTERY FAILS, CONTACT DAKTRONICS FOR REPLACEMENT SERVICE.

CHARGING STATION WEIGHT: ABOUT 10 LBS, WITHOUT RC-200 CONSOLES. MAX. POWER CONSUMPTION: 100 WATTS.

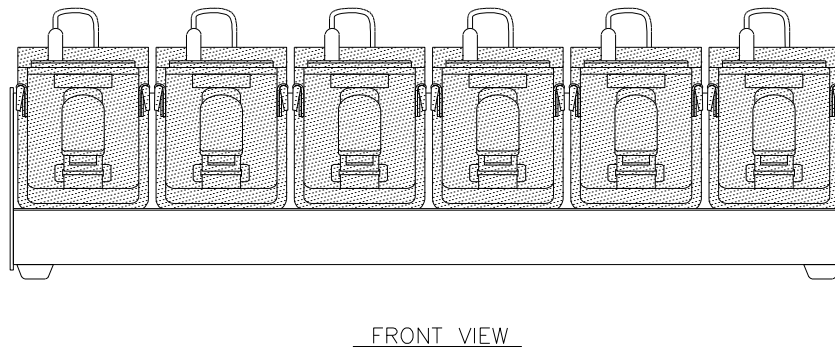
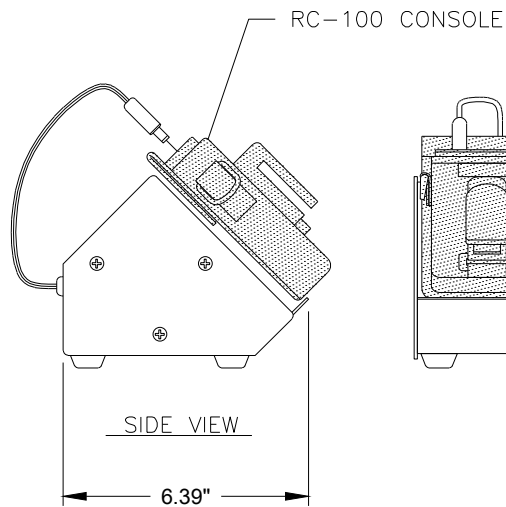

		THE CONCEPTS EXPRESSED AND DETAILS SHOWN ON THIS DRAWING ARE CONFIDENTIAL AND PROPRIETARY. DO NOT REPRODUCE BY ANY MEANS WITHOUT THE EXPRESS WRITTEN CONSENT OF DAKTRONICS, INC. OR ITS WHOLLY OWNED SUBSIDIARIES. COPYRIGHT 2017 DAKTRONICS, INC. (USA)		THIRD ANGLE PROJECTION 	
		PROJECT: RC-200 CONSOLE			
TITLE: CHARGING STATION- SPECIFICATIONS AND OPERATION					
DATE: 16 MAY 17		DIM UNITS: INCHES [MILLIMETERS]		SHEET REV	
SCALE: NTS		DO NOT SCALE DRAWING		00	
DESIGN: AVB		JOB NO. P1110		FUNC - TYPE - SIZE R - 04 - A	
DRAWN: AHUNTER				3639831	

**NOTE:** THIS DETAIL SHOWS A BA-515. ACTUAL RC-200 SCOREBOARD RECEIVER BASE STATION MAY BE IN A DIFFERENT LOCATION DEPENDING ON DISPLAY TYPE.

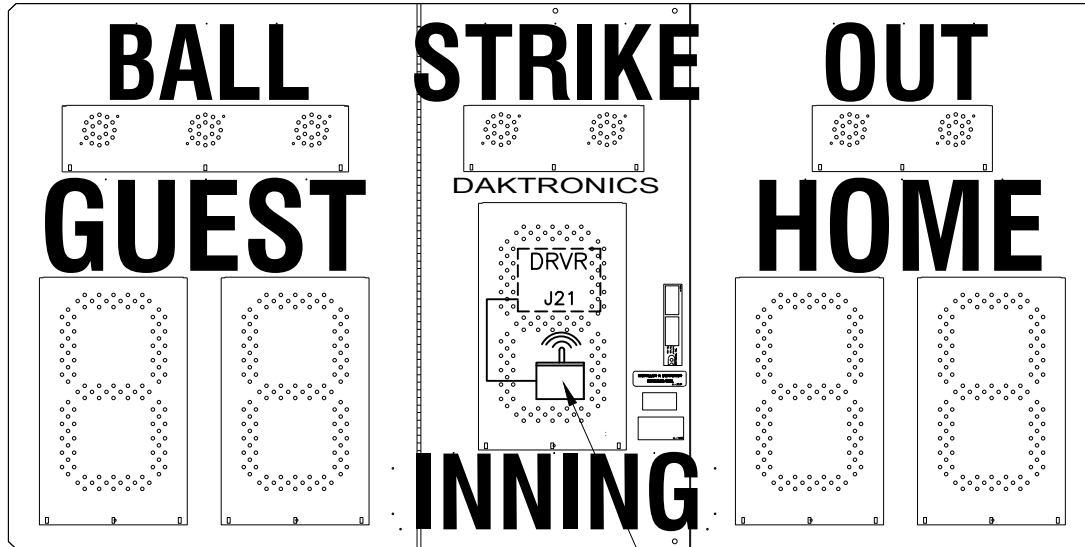

**NOTE:** THE WIRELESS BASE STATION COMES PRE-SET TO, GROUP 1, CHANNEL 1. HOWEVER, ANY GROUP/CHANNEL CAN BE USED.

0A-1110-0065  
FUNCTION SETTING = 2

**NOTE:** RC-200 SCOREBOARD RECEIVER BASE STATION IS LOCATED BEHIND THE FRONT ACCESS PANEL OF DISPLAY.

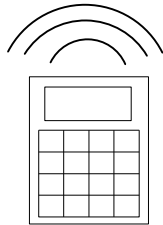

0A-1110-0062  
INSERT: LL-2605 (BASEBALL) CODE 03  
INSERT: LL-2607 (TENNIS) CODE 08

		<small>THE CONCEPTS EXPRESSED AND DETAILS SHOWN ON THIS DRAWING ARE CONFIDENTIAL AND PROPRIETARY. DO NOT REPRODUCE BY ANY MEANS WITHOUT THE EXPRESS WRITTEN CONSENT OF DAKTRONICS, INC. OR ITS WHOLLY OWNED SUBSIDIARIES. COPYRIGHT 2017 DAKTRONICS, INC. (USA)</small>		<small>THIRD ANGLE PROJECTION</small>		
		PROJECT: RADIO LINK				
TITLE: SYSTEM RISER DIAGRAM: RC-200- BASEBALL/TENNIS						
DATE: 16 MAY 17		DIM UNITS: INCHES [MILLIMETERS]		SHEET REV		
SCALE: NONE		DO NOT SCALE DRAWING				00
DESIGN: RTAGTOW		JOB NO. P1110		FUNC - TYPE - SIZE R - 01 - A		
DRAWN: AHUNTER						3639930



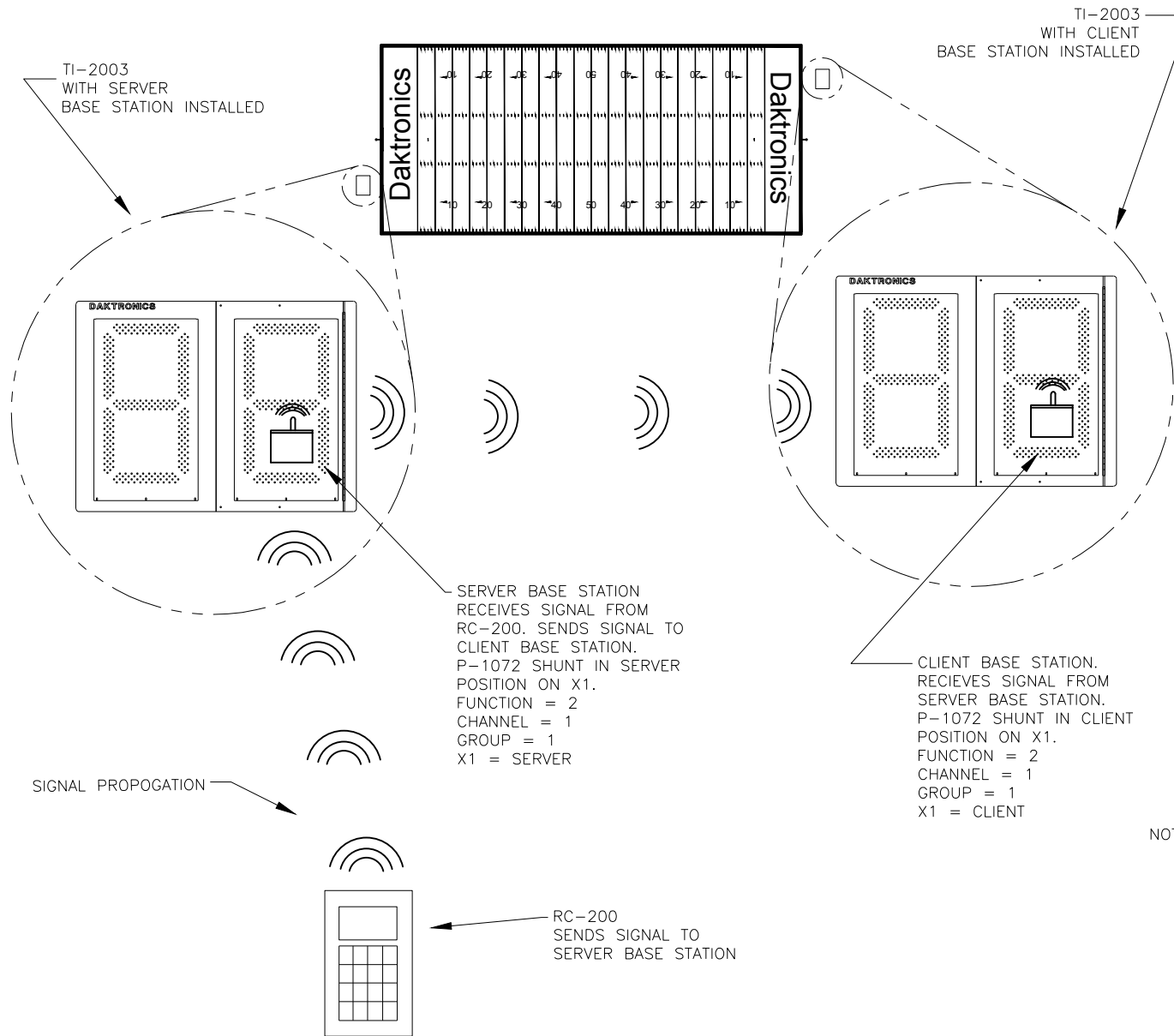

SERVER BASE STATION  
RECEIVES SIGNAL FROM  
RC-200. SENDS SIGNAL TO  
CLIENT BASE STATION.  
P-1072 SHUNT IN SERVER  
POSITION ON X1.  
FUNCTION = 2  
CHANNEL = 1  
GROUP = 1  
X1 = SERVER

CLIENT BASE STATION.  
RECIEVES SIGNAL FROM  
SERVER BASE STATION.  
P-1072 SHUNT IN CLIENT  
POSITION ON X1.  
FUNCTION = 2  
CHANNEL = 1  
GROUP = 1  
X1 = CLIENT

NOTE:  
SIGNAL PROPAGATES FROM THE RC-200  
TO THE SERVER BASE STATION, THE  
SERVER BASE STATION THEN SENDS A  
NEW SIGNAL TO THE CLIENT BASE STATION.  
RC-200 CAN ONLY COMMUNICATE WITH ONE  
SERVER BASE STATION AT A TIME.

SIGNAL PROPOGATION

0A-1110-0062  
INSERT: LL-2653 (PLAY CLOCK) CODE 05

		THE CONCEPTS EXPRESSED AND DETAILS SHOWN ON THIS DRAWING ARE CONFIDENTIAL AND PROPRIETARY. DO NOT REPRODUCE BY ANY MEANS WITHOUT THE EXPRESS WRITTEN CONSENT OF DAKTRONICS, INC. OR ITS WHOLLY OWNED SUBSIDIARIES. COPYRIGHT 2017 DAKTRONICS, INC. (USA)			
PROJECT: RC-200 SERVER/CLIENT LINE					
TITLE: 3639940.dwg					
DATE: 16 MAY 17		DIM UNITS: INCHES [MILLIMETERS]		SHEET	
SCALE: NONE		DO NOT SCALE DRAWING		REV	
DESIGN: ARICHTE		JOB NO. P1110		FUNC - TYPE - SIZE	
DRAWN: AHUNTER		R - 01 - A		3639940	

CONTROL LOCATION

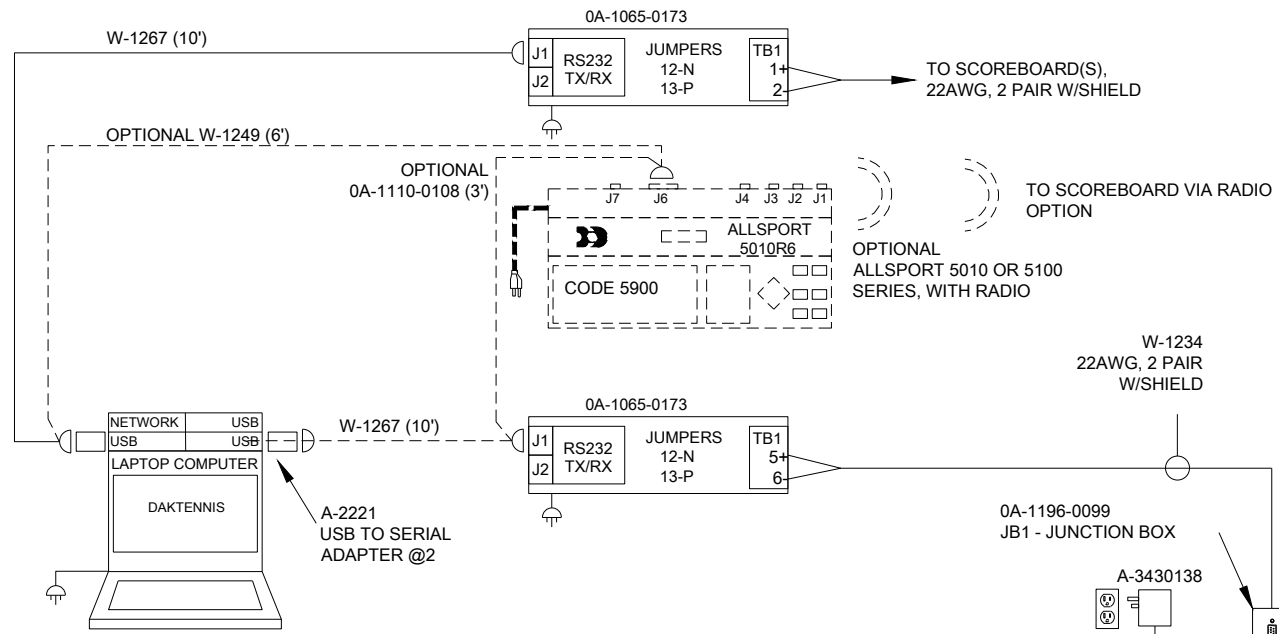

**JB1 - PIN OUT**

PIN #	FUNCTION	TERMINAL CONNECTION	CONNECTION TO CONVERTER
J1-1	12-24VDC +	TB1-1	N/C
J1-2	CL TX+	TB1-2	TB1-5
J1-3	N/C	N/C	N/C
J1-4	N/C	N/C	N/C
J1-5	DC GND, CL TX-	TB2-1	TB1-6
J1-6	N/C	N/C	N/C
J1-7	N/C	N/C	N/C
J1-8	N/C	N/C	N/C
J1-9	N/C	N/C	N/C

**JB2 - PIN OUT**

PIN #	FUNCTION	TERMINAL CONNECTION
J3-1	RS232 TX +	N/C
J3-2	RS232 RX +	N/C
J3-3	DC GND, CL TX-	TB2-1
J3-4	12-24VDC +	TB1-1
J3-5	CL TX+	TB1-2
J3-6	NOT USED	N/C

REMOTE LOCATION UP TO 125FT AWAY.

OUTDOOR BASE STATION  
0A-1110-0068  
FUNCTION SETTING = 2  
ANY GROUP/CHANNEL

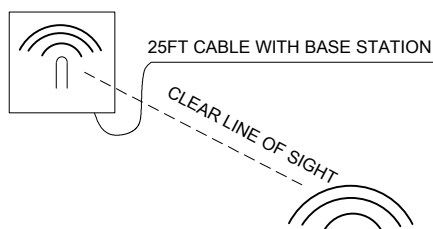

RC-200 CONTROLLER  
0A-1110-0062  
INSERT: LL-2607  
CODE: 08

NOTE:  
THE RC-200 CONTROLLER(S) USE ANY GROUP/CHANNEL. HOWEVER, THE BASE STATION AND RC-200 CONTROLLER(S) MUST BE OPERATING ON THE SAME GROUP/CHANNEL. MAX OF 8 RC-200 CONTROLLERS CAN BE USED WITH 1 BASE STATION.

W-1234, 22AWG, 2 PAIR W/SHIELD MAX 125FT.

0A-1196-0167  
JB2 - JUNCTION BOX

**DAKTRONICS**

THE CONCEPTS EXPRESSED AND DETAILS SHOWN ON THIS DRAWING ARE CONFIDENTIAL AND PROPRIETARY. DO NOT REPRODUCE BY ANY MEANS WITHOUT THE EXPRESS WRITTEN CONSENT OF DAKTRONICS, INC. OR ITS WHOLLY OWNED SUBSIDIARIES. COPYRIGHT 2017 DAKTRONICS, INC. (USA)

THIRD ANGLE PROJECTION

PROJECT: RC-200 TENNIS		SHEET		REV
TITLE: SYSTEM RISER; TENNIS; REMOTE BASE STATION				00
DATE: 15 MAY 17	DIM UNITS: INCHES [MILLIMETERS]			
SCALE: NONE	DO NOT SCALE DRAWING			
DESIGN: KBIERBA	JOB NO.	FUNC - TYPE - SIZE		3640082
DRAWN: AHUNTER	P1110	R - 01 - A		

INDOOR MULTI-COURT SCOREBOARD LAYOUT  
REFER TO MANUAL FOR ALL POWER, SIGNAL, AND  
INSTALLATION DETAILS.

REAR VIEW

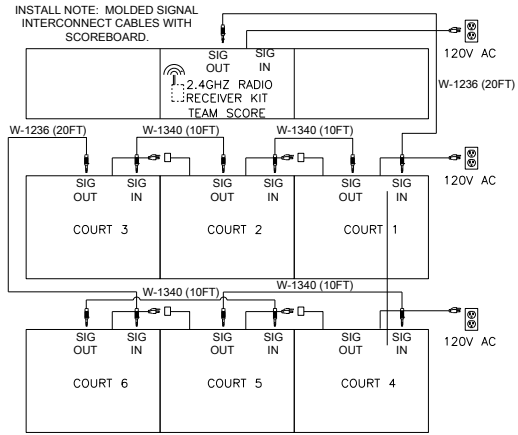

OUTDOOR MULTI-COURT SCOREBOARD LAYOUT  
REFER TO MANUAL FOR ALL POWER, SIGNAL, AND  
INSTALLATION DETAILS.

REAR VIEW

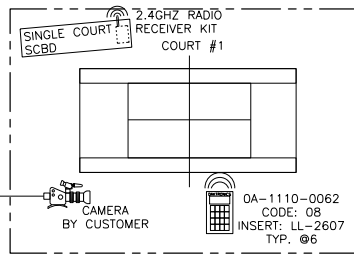
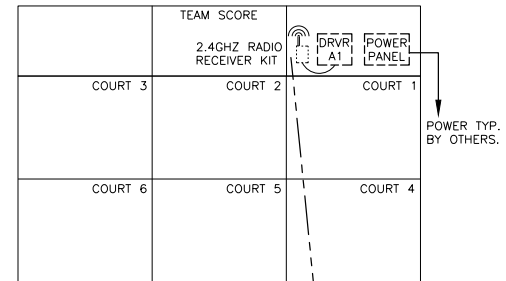

NOTE:  
THE 6 RC-200 CONTROLLERS USE ANY  
GROUP/CHANNEL. HOWEVER, THE BASE STATION  
AND HAND HELD CONTROLLERS MUST BE OPERATING  
ON THE SAME GROUP/CHANNEL.

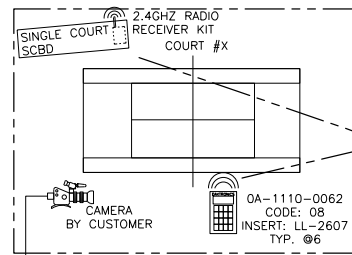

ALL RADIO  
COMMUNICATION  
REQUIRES CLEAR  
LINE OF SIGHT.

DAKTENNIS CONTROL LOCATION  
CLEAR LINE OF SIGHT REQUIRED.

0A-1110-0066 BASE STATION KIT.  
TYPICAL SETTING:  
FUNCTION = 2  
ANY GROUP/CHANNEL  
SERVER JUMPER ENABLED.  
NOTE: SEE DWG-3640082 AND OUTDOOR 1  
BASE STATION 0A-1110-0067 IF YOU NEED  
TO REMOTE LOCATE FOR BETTER LINE OF  
SIGHT.

TYP. USB TO SERIAL  
ADAPTERS BY  
OTHERS.

COURT CAMERA DATA  
LINES BY CUSTOMER.

PRODUCTION LOCATION  
ALLSPORT CG SETUP

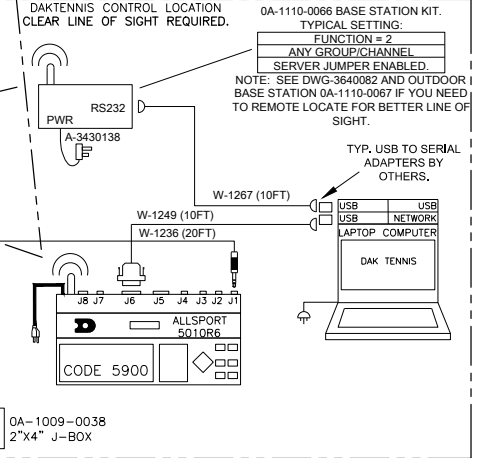
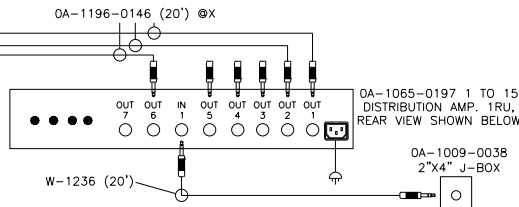
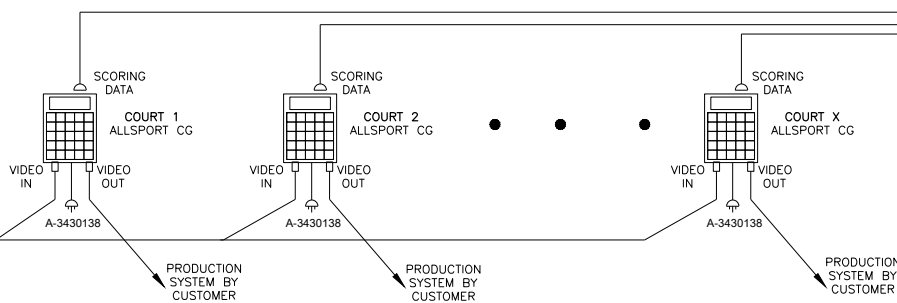

		<small>THE CONCEPTS EXPRESSED AND DETAILS SHOWN ON THIS DRAWING ARE CONFIDENTIAL AND PROPRIETARY. DO NOT REPRODUCE BY ANY MEANS WITHOUT THE EXPRESS WRITTEN CONSENT OF DAKTRONICS, INC. OR ITS WHOLLY OWNED SUBSIDIARIES. COPYRIGHT 2017 DAKTRONICS, INC. (USA)</small>		
<b>PROJECT: TENNIS SCOREBOARD</b>				
<b>TITLE: SYSTEM RISER; TENNIS; MULTI-COURT, DAKTENNIS, RADIO, CG</b>				
DATE: 15 MAY 17	DIM UNITS: INCHES (MILLIMETERS)	SHEET	REV	00
SCALE: NONE	DO NOT SCALE DRAWING			
DESIGN: RTAGTOW	JOB NO.	FUNC - TYPE - SIZE		
DRAWN: AHUNTER	P1164	E - 10 - B	3640119	

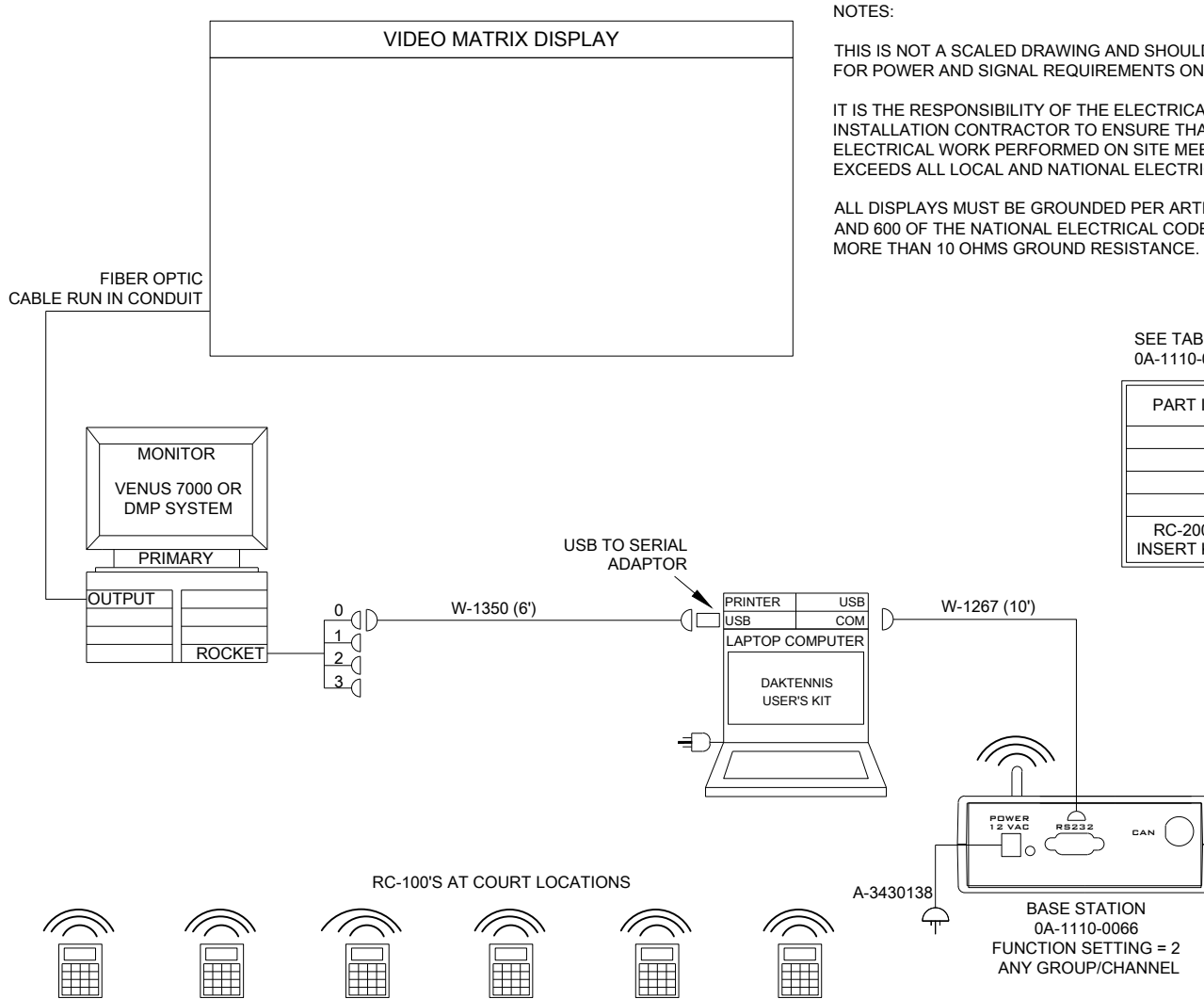

**NOTES:**

THIS IS NOT A SCALED DRAWING AND SHOULD BE USED FOR POWER AND SIGNAL REQUIREMENTS ONLY.

IT IS THE RESPONSIBILITY OF THE ELECTRICAL INSTALLATION CONTRACTOR TO ENSURE THAT ALL ELECTRICAL WORK PERFORMED ON SITE MEETS OR EXCEEDS ALL LOCAL AND NATIONAL ELECTRICAL CODES.

ALL DISPLAYS MUST BE GROUNDED PER ARTICLE 250 AND 600 OF THE NATIONAL ELECTRICAL CODE WITH NO MORE THAN 10 OHMS GROUND RESISTANCE.

SEE TABLE BELOW FOR CONTENTS OF RC-100 HANDHELD, CONTROLLER KIT: 0A-1110-0102

PART ID	ASSEMBLY #	DESCRIPTION AND OPERATOR INFO
	0A-1000-1079	CD; SOFTWARE, ALL SPORT MANUALS
	0A-1110-0062	RC-200 WIRELESS HANDHELD
	EN-1995	RC-200 BLACK, SOFT CARRY CASE
	A-3430138	TRANSFORMER; 12VAC; WALLPACK 6' CORD
RC-200 INSERT KIT	LL-2806	RC-200 TENNIS INSERT USE CODE 08



RC-200 WIRELESS HANDHELD: 0A-1110-0062, TYP. @6. INCLUDED IN RC-200 HANDHELD, CONTROLLER KIT: 0A-1110-0064.

**NOTE:**  
THE (6) RC-200 CONTROLLERS USE ANY GROUP/CHANNEL, HOWEVER, THE BASE STATION AND HAND HELD CONTROLLERS MUST BE OPERATING ON THE SAME CHANNEL. USE CODE 08 FOR TENNIS.

		THE CONCEPTS EXPRESSED AND DETAILS SHOWN ON THIS DRAWING ARE CONFIDENTIAL AND PROPRIETARY. DO NOT REPRODUCE BY ANY MEANS WITHOUT THE EXPRESS WRITTEN CONSENT OF DAKTRONICS, INC. OR ITS WHOLLY OWNED SUBSIDIARIES. COPYRIGHT 2017 DAKTRONICS, INC. (USA)		THIRD ANGLE PROJECTION 	
PROJECT: TENNIS SCOREBOARD					
TITLE: SYSTEM RISER DIAGRAM; DAKTENNIS, VIDEO CONTROL					
DATE: 16 MAY 17		DIM UNITS: INCHES [MILLIMETERS]		SHEET	
SCALE: NONE		DO NOT SCALE DRAWING		REV	
DESIGN: RTAGTOW		JOB NO. P1164		FUNC - TYPE - SIZE	
DRAWN: AHUNTER		E - 10 - A		3640268	

NOTE:  
 SAMPLE SCOREBOARD MODEL SHOWN. SEE  
 SPECIFICATION MATERIAL ON MODEL PURCHASED.

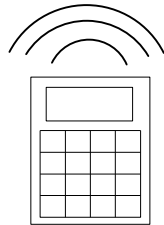
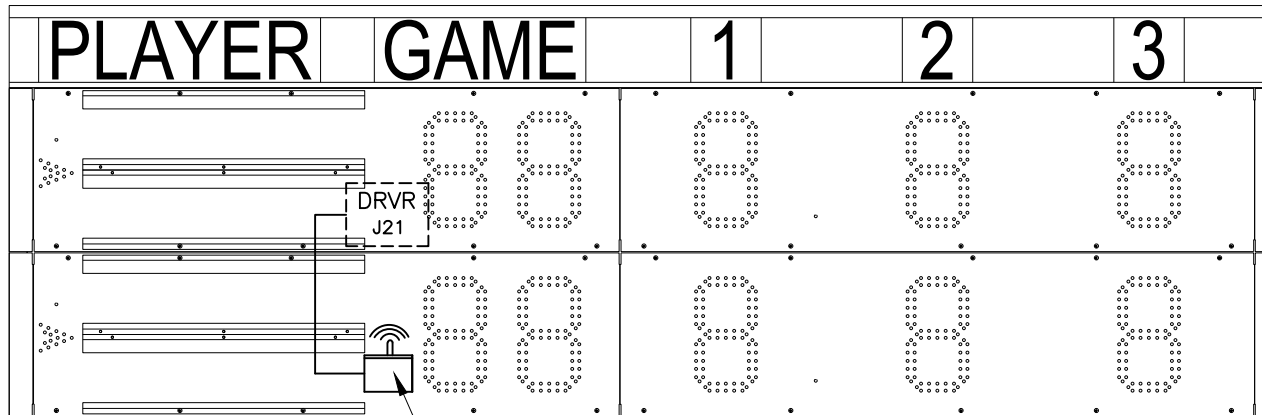

0A-1110-0062  
 INSERT: LL-2607 (TENNIS) CODE 08

0A-1110-0065  
 FUNCTION SETTING = 2

NOTE: RC-200 SCOREBOARD RECEIVER  
 BASE STATION IS LOCATED BEHIND THE  
 FRONT ACCESS PANEL OF DISPLAY.

NOTE:  
 THE WIRELESS BASE STATION COMES PRE-SET TO  
 GROUP 1 / CHANNEL 1. HOWEVER, ANY  
 GROUP/CHANNEL CAN BE USED.

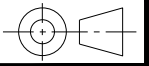
	THE CONCEPTS EXPRESSED AND DETAILS SHOWN ON THIS DRAWING ARE CONFIDENTIAL AND PROPRIETARY. DO NOT REPRODUCE BY ANY MEANS WITHOUT THE EXPRESS WRITTEN CONSENT OF DAKTRONICS, INC. OR ITS WHOLLY OWNED SUBSIDIARIES. COPYRIGHT 2017 DAKTRONICS, INC. (USA)			
	PROJECT: TENNIS SCOREBOARDS			
TITLE: SYSTEM RISER; INDOOR/OUTDOOR SINGLE COURT, RC-200				
DATE: 16 MAY 17	DIM UNITS: INCHES [MILLIMETERS]		SHEET	REV
SCALE: NONE	DO NOT SCALE DRAWING			00
DESIGN:	JOB NO.	FUNC - TYPE - SIZE		3640312
DRAWN: AHUNTER	P1164	R - 01 - A		

### SYNCHRONIZED SWIMMING

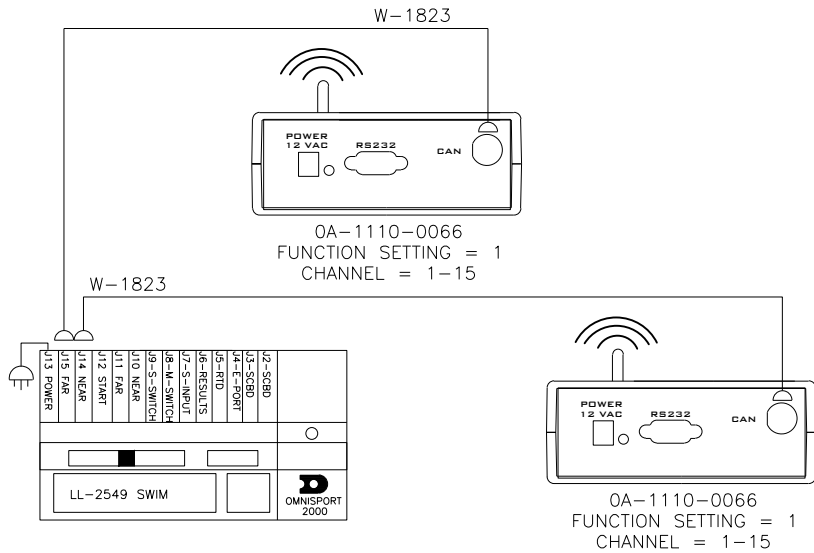
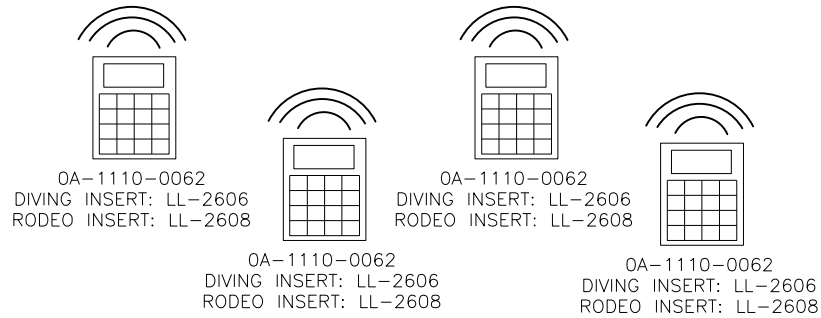

**NOTE:**

UP TO 18 RC-200 CONTROLLERS CAN BE USED AT ONCE (9 RC-200 CONTROLLERS PER BASE STATION).

ANY GROUP/CHANNEL CAN BE USED, HOWEVER THE TWO BASE STATIONS MUST BE SET TO DIFFERENT CHANNELS. EACH BASE STATION AND ITS RESPECTIVE RC-200 CONTROLLERS NEED TO BE SET TO THE SAME CHANNEL.

### DIVING/RODEO

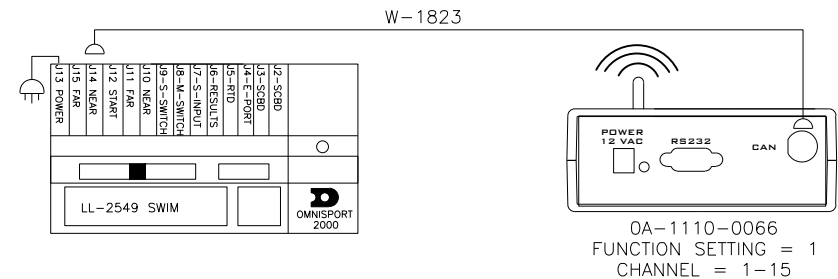
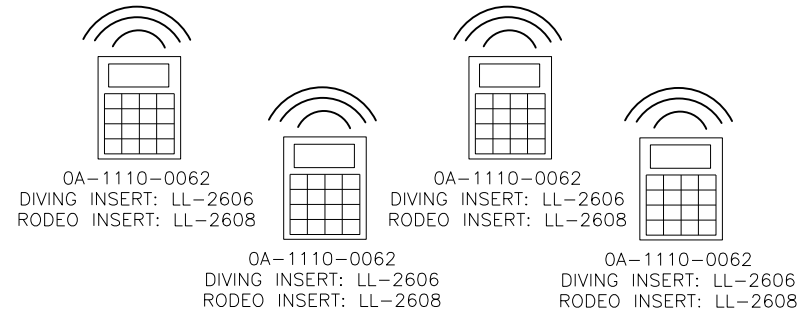

**NOTE:**

UP TO 9 RC-200 CONTROLLERS CAN BE USED AT ONCE.

ANY GROUP/CHANNEL CAN BE USED, HOWEVER THE BASE STATION AND ALL RC-200 CONTROLLERS MUST BE OPERATING ON THE SAME CHANNEL.

		THE CONCEPTS EXPRESSED AND DETAILS SHOWN ON THIS DRAWING ARE CONFIDENTIAL AND PROPRIETARY. DO NOT REPRODUCE BY ANY MEANS WITHOUT THE EXPRESS WRITTEN CONSENT OF DAKTRONICS, INC. OR ITS WHOLLY OWNED SUBSIDIARIES. COPYRIGHT 2017 DAKTRONICS, INC. (USA)		THIRD ANGLE PROJECTION	
PROJECT: <b>RADIO LINK</b>					
TITLE: <b>SYSTEM RISER: RC-200- RODEO/DIVING/SYNC SWIMMING</b>					
DATE: <b>24 MAY 17</b>		DIM UNITS: <b>INCHES [MILLIMETERS]</b>		SHEET <b>REV</b>	
SCALE: <b>NONE</b>		DO NOT SCALE DRAWING			
DESIGN: <b>RTAGTOW</b>		JOB NO.		FUNC - TYPE - SIZE	
DRAWN: <b>AHUNTER</b>		<b>P1110</b>		<b>R - 01 - A</b>	
					<b>3640329</b>

OUTDOOR SCOREBOARD LAYOUT  
REFER TO MANUAL FOR ALL POWER,  
SIGNAL AND INSTALLATION DETAILS.

REAR VIEW

SINGLE COURT  
REFER TO MANUAL FOR ALL POWER,  
SIGNAL AND INSTALLATION DETAILS.

SINGLE COURT  
REFER TO MANUAL FOR ALL POWER,  
SIGNAL AND INSTALLATION DETAILS.

SINGLE COURT  
REFER TO MANUAL FOR ALL POWER,  
SIGNAL AND INSTALLATION DETAILS.

SINGLE COURT  
REFER TO MANUAL FOR ALL POWER,  
SIGNAL AND INSTALLATION DETAILS.

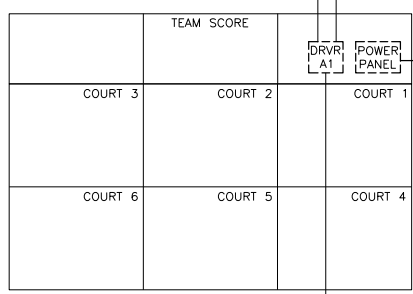

POWER TYP. BY OTHERS.

POWER TYP. BY OTHERS.

POWER TYP. BY OTHERS.

POWER TYP. BY OTHERS.

PS INTERNAL PWR/SIG. TERM LOCATION.  
EXACTLY LOCATION IS DETERMINED BY  
MODEL PURCHASED.

① 2 PAIR, 22AWG W/ SHIELD IN  
DEDICATED CONDUIT, DAK, CABLE #  
W-1234. CONDUIT & LABOR TO INSTALL BY  
OTHERS

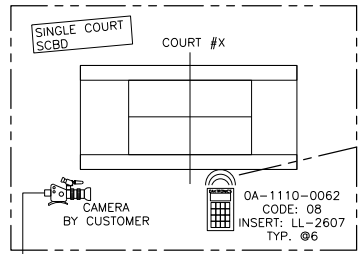
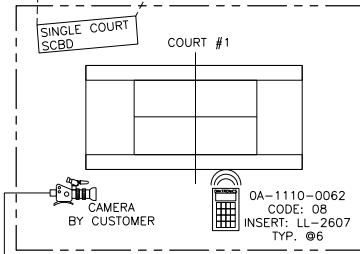

NOTE:  
THE 6 RC-200 CONTROLLERS USE ANY  
GROUP/CHANNEL. HOWEVER, THE BASE STATION  
AND HAND HELD CONTROLLERS MUST BE OPERATING  
ON THE SAME GROUP/CHANNEL.

DAK TENNIS CONTROL LOCATION  
CLEAR LINE OF SIGHT REQUIRED.

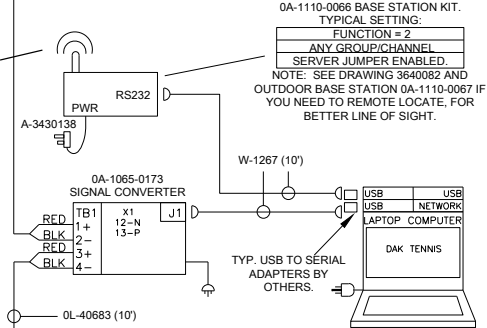

COURT CAMERA DATA  
LINES BY CUSTOMER.

PRODUCTION LOCATION  
ALLSPORT CG SETUP

0A-1196-0146 (20') ØX

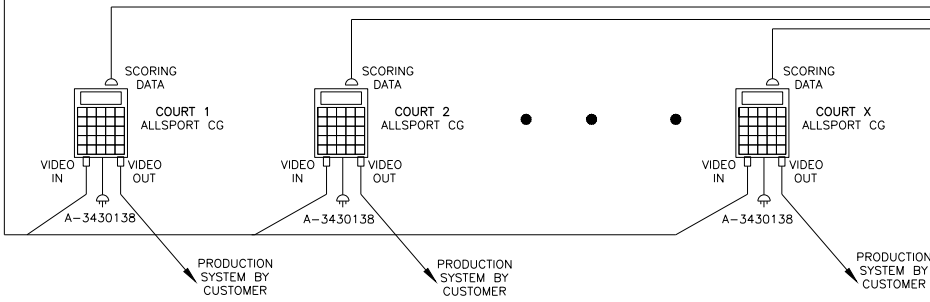

0A-1065-0197 1 TO 15  
DISTRIBUTION AMP. 1RU,  
REAR VIEW SHOWN BELOW

W-1077, 1 PAIR, 22AWG MINIMUM IN  
CONDUIT WHERE REQUIRED.  
1000FT MAX. DISTANCE

		<small>THE CONCEPTS EXPRESSED AND DETAILS SHOWN ON THIS DRAWING ARE CONFIDENTIAL AND PROPRIETARY. DO NOT REPRODUCE BY ANY MEANS WITHOUT THE EXPRESS WRITTEN CONSENT OF DAKTRONICS, INC. OR ITS WHOLLY OWNED SUBSIDIARIES. COPYRIGHT 2017 DAKTRONICS, INC. (USA)</small>		
<b>PROJECT: TENNIS SCOREBOARDS</b>				
<b>TITLE: SYSTEM RISER; TENNIS; OUTDOOR MULTI-COURT, CG</b>				
DATE: 16 MAY 17	DIM UNITS: INCHES (MILLIMETERS)		SHEET	REV
SCALE: NONE	DO NOT SCALE DRAWING			
DESIGN: MMILLER	JOB NO. P1164	FUNC - TYPE - SIZE R-01-B		3640342
DRAWN: AHUNTER				

INDOOR SCOREBOARD LAYOUT  
REFER TO MANUAL FOR ALL POWER, SIGNAL AND INSTALLATION DETAILS.

REAR VIEW

ONLY FOR SINGLE COURT SCBDS

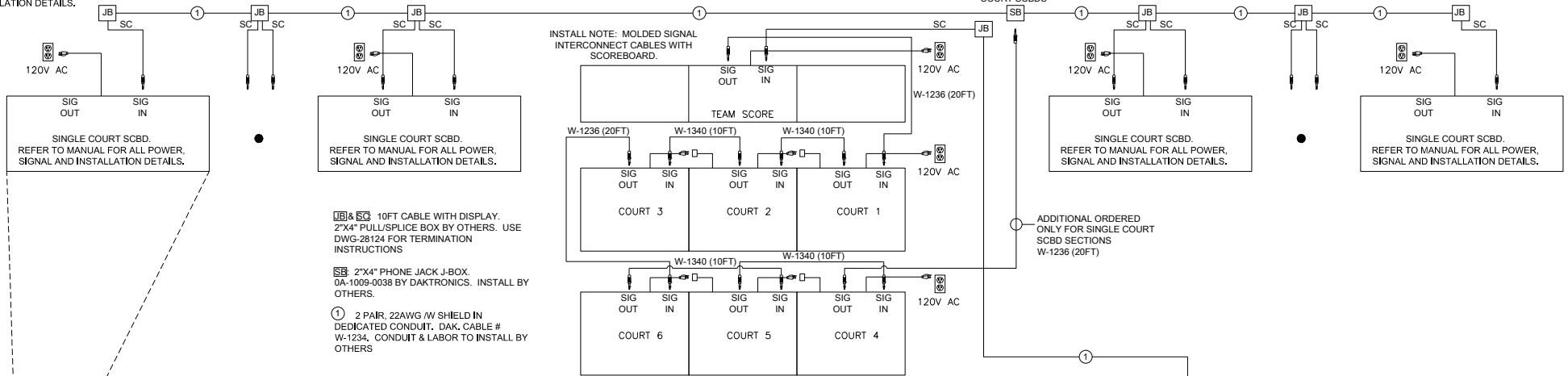

- JB & SC 10FT CABLE WITH DISPLAY. 2"x4" PULL/SPLICE BOX BY OTHERS. USE DWG-28124 FOR TERMINATION INSTRUCTIONS
- SB 2"x4" PHONE JACK J-BOX. 0A-1009-0038 BY DAKTRONICS. INSTALL BY OTHERS.
- ① 2 PAIR, 22AWG IW SHIELD IN DEDICATED CONDUIT, DAK. CABLE # W-1234. CONDUIT & LABOR TO INSTALL BY OTHERS

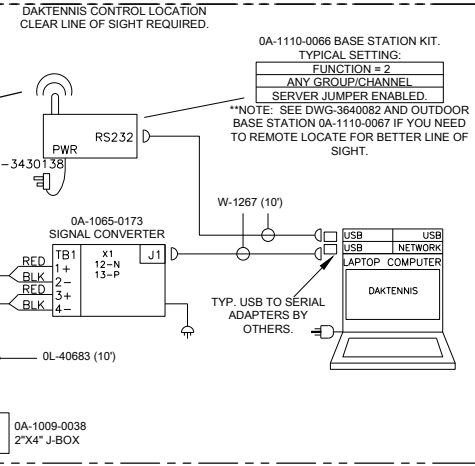
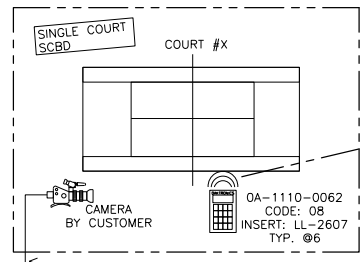
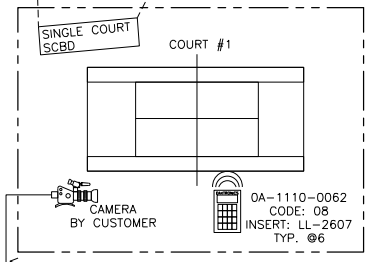

PRODUCTION LOCATION ALLSPORT CG SETUP

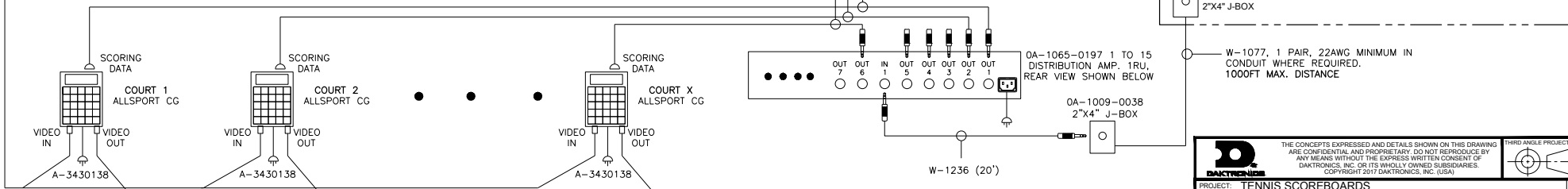

		<small>THE CONCEPTS EXPRESSED AND DETAILS SHOWN ON THIS DRAWING ARE CONFIDENTIAL AND PROPRIETARY. DO NOT REPRODUCE BY ANY MEANS WITHOUT THE EXPRESS WRITTEN CONSENT OF DAKTRONICS, INC. OR ITS WHOLLY OWNED SUBSIDIARIES. COPYRIGHT 2017 DAKTRONICS, INC. (USA)</small>		
<b>PROJECT: TENNIS SCOREBOARDS</b>				
<b>TITLE: SYSTEM RISER, TENNIS; INDOOR MULTI-COURT, CG</b>				
DATE: 11 JAN 05	DIM UNITS: INCHES (MILLIMETERS)		SHEET	REV
SCALE: NONE	DO NOT SCALE DRAWING		00	
DESIGN:	JOB NO. P1164	FUNC - TYPE - SIZE R-01-B	3640403	
DRAWN: RTAGTOW				



TOP VIEW

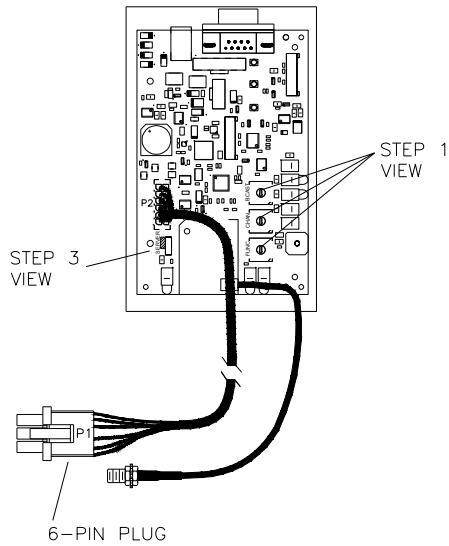

STEP 1 CHART

FUNCTION SETTING	FUNCTION (SERVER MODE)
1	CAN HANDHELD JUDGES CONSOLE
2	ALL SPORT SCBD CONTROLLER - GEN I
F	RESET MEMORY/TEST

STEP 1  
 USING A SMALL FLAT HEAD SCREW DRIVER OR YOUR FINGERS CHANGE THE SWITCHES TO THE DESIRED FUNCTION, GROUP, AND CHANNEL NUMBER. (REFER TO STEP 1 VIEW AND CHART FOR CHANNEL SELECTION.)

STEP 2  
 NOTE THE CHANNEL AND GROUP NUMBER SET FOR THIS UNIT.

STEP 3  
 BASE STATION IS SET IN FACTORY FOR SERVER MODE. FOR CLIENT MODE, SET JUMPERS TO RIGHT MOST POSITION.

BASE STATION MOUNTING IN MOST INDOOR SCOREBOARDS.  
 SEE DWG-1130990 FOR BASE STATION MOUNTING IN SCOREBOARDS MADE AFTER MARCH 2013

NOTE: MOUNT THE BASE STATION INTERNALLY, CHECK SO IT WILL NOT INTERFERE WITH ANYTHING.

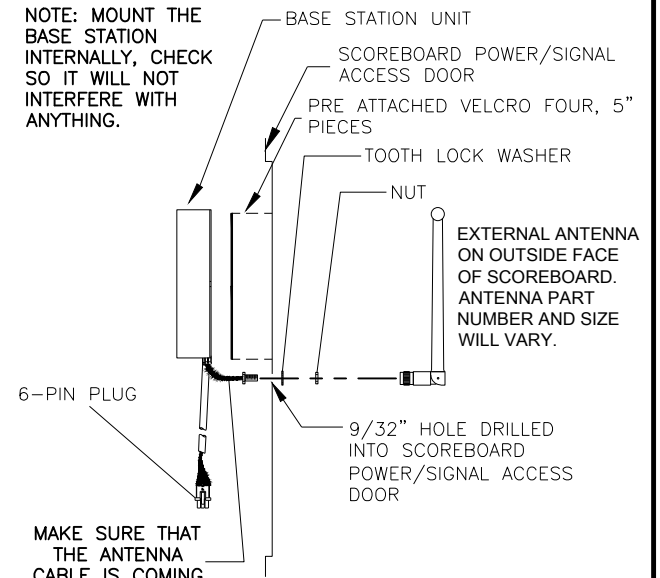

MAKE SURE THAT THE ANTENNA CABLE IS COMING FROM THE BOTTOM OF THE BASE STATION, TO PREVENT WATER DAMAGE, AS SHOWN ABOVE.

LEGACY VIEW

(BUILT PRIOR TO APRIL 2015)

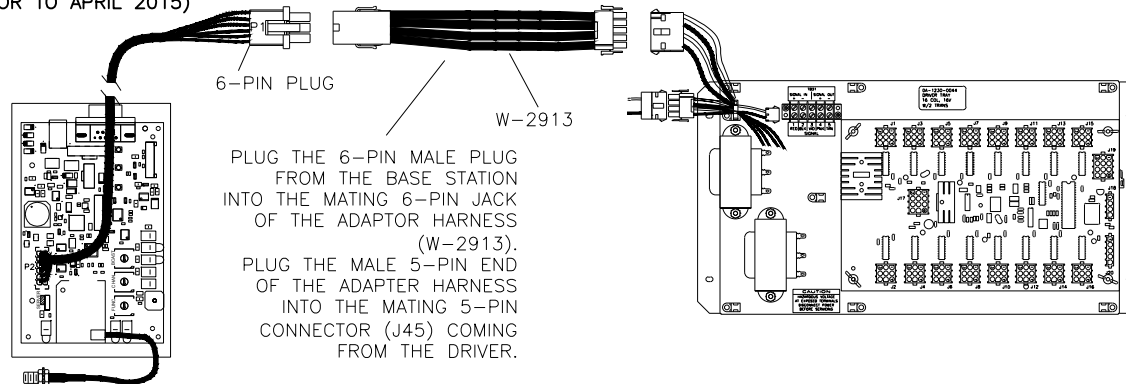

PLUG THE 6-PIN MALE PLUG FROM THE BASE STATION INTO THE MATING 6-PIN JACK OF THE ADAPTOR HARNESS (W-2913).  
 PLUG THE MALE 5-PIN END OF THE ADAPTER HARNESS INTO THE MATING 5-PIN CONNECTOR (J45) COMING FROM THE DRIVER.

GYRUS VIEW

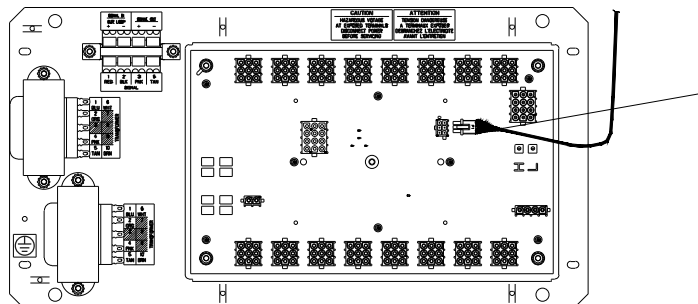

PLUG THE 6-PIN MALE PLUG FROM THE BASE STATION INTO THE MATING 6-PIN JACK (J21) ON THE DRIVER PCB AS SHOWN.

		THE CONCEPTS EXPRESSED AND DETAILS SHOWN ON THIS DRAWING ARE CONFIDENTIAL AND PROPRIETARY. DO NOT REPRODUCE BY ANY MEANS WITHOUT THE EXPRESS WRITTEN CONSENT OF DAKTRONICS, INC. OR ITS WHOLLY OWNED SUBSIDIARIES. COPYRIGHT 2017 DAKTRONICS, INC. (USA)		THIRD ANGLE PROJECTION 	
PROJECT: RC-100					
TITLE: BASE STATION: INDOOR INSTALLATION					
DATE: 11 NOV 04		DIM UNITS: INCHES [MILLIMETERS]		SHEET	
SCALE: NONE		DO NOT SCALE DRAWING		REV	
DESIGN:		JOB NO.		FUNC - TYPE - SIZE	
DRAWN: DULSCHM		P1110		E - 07 - A	
					3640534

TOP VIEW  
BASE STATION VIEW WITH FUNCTION SETTINGS CHART

- STEP 1**  
USING A SMALL FLAT HEAD SCREW DRIVER OR YOUR FINGERS CHANGE THE SWITCHES TO THE DESIRED FUNCTION, GROUP, AND CHANNEL NUMBER. (REFER TO STEP 1 VIEW AND CHART.)
- STEP 2**  
NOTE THE CHANNEL NUMBER SET FOR THIS UNIT.
- STEP 3**  
BASE STATION IS SET IN FACTORY FOR SERVER MODE. FOR CLIENT MODE, SET JUMPERS TO RIGHT MOST POSITION.

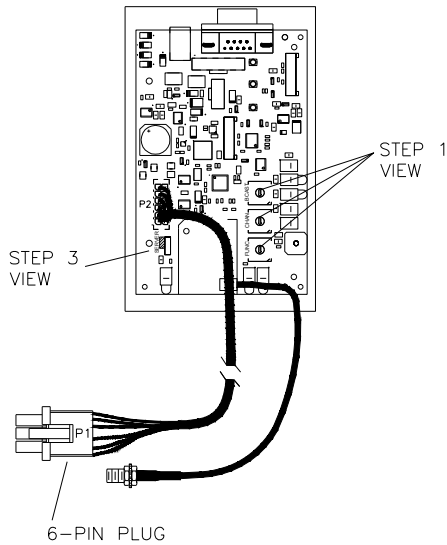

STEP 1 CHART

FUNCTION SETTING	FUNCTION (SERVER MODE)
1	CAN HANDHELD JUDGES CONSOLE
2	ALL SPORT SCBD CONTROLLER - GEN I
F	RESET MEMORY/TEST

SIDE VIEW  
BASE STATION MOUNTING DETAILS FOR MOST OUTDOOR SCOREBOARDS

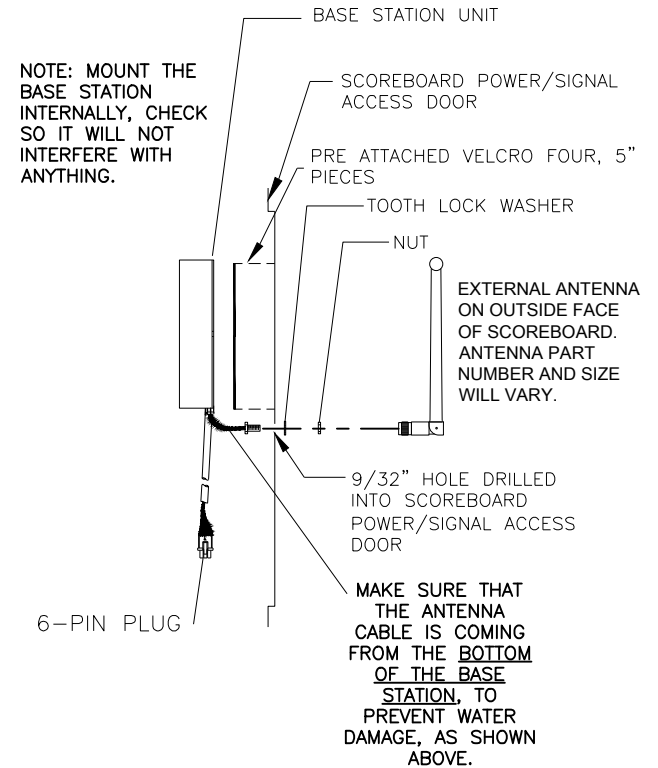

GYRUS VIEW

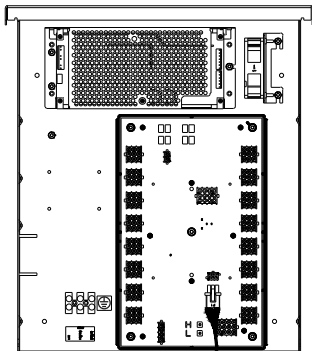

PLUG THE 6-PIN MALE PLUG FROM THE BASE STATION INTO THE MATING 6-PIN JACK (J21) ON THE DRIVER PCB AS SHOWN.

CONNECTING THE BASE STATION WIRE HARNESS  
FRONT VIEW OF DRIVER ENCLOSURE; LID REMOVED

PLUG THE 6-PIN MALE PLUG FROM THE BASE STATION INTO THE MATING 6-PIN JACK OF THE ADAPTOR HARNESS (W-2913).  
PLUG THE MALE 5-PIN END OF THE ADAPTER HARNESS INTO THE MATING 5-PIN CONNECTOR (J45) COMING FROM THE DRIVER.

LEGACY VIEW

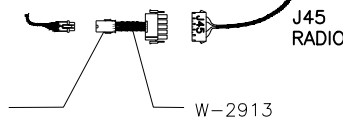
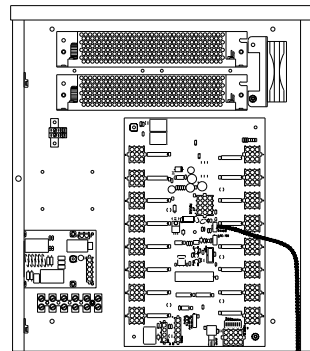

REV 01	DATE: 15 SEPT 2017	CORRECTED TITLE	BY: SJC
PROJECT: RC-200 TITLE: BASE STATION: OUTDOOR INSTALLATION			
DATE: 17 MAY 17	DIM UNITS: INCHES [MILLIMETERS]		SHEET
SCALE: NTS	DO NOT SCALE DRAWING		REV
DESIGN: MMILLER	JOB NO.	FUNC - TYPE - SIZE	3640913
DRAWN: AHUNTER	P1110	E - 07 - A	

TOP VIEW

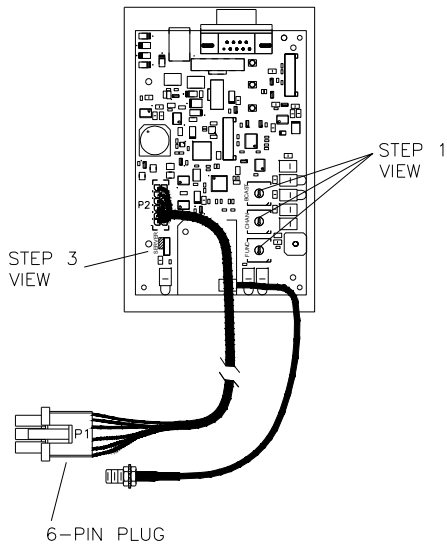

**STEP 1**  
 USING A SMALL FLAT HEAD SCREW DRIVER OR YOUR FINGERS CHANGE THE SWITCHES TO THE DESIRED FUNCTION, GROUP, AND CHANNEL NUMBER. (REFER TO STEP 1 VIEW AND CHART FOR CHANNEL SELECTION.)  
**STEP 2**  
 NOTE THE CHANNEL NUMBER SET FOR THIS UNIT.  
**STEP 3**  
 BASE STATION IS SET IN FACTORY FOR SERVER MODE. FOR CLIENT MODE, SET JUMPERS TO RIGHT MOST POSITION.

STEP 1 CHART

FUNCTION SETTING	FUNCTION (SERVER MODE)
1	CAN HANDHELD JUDGES CONSOLE
2	ALL SPORT SCBD CONTROLLER - GEN I
F	RESET MEMORY/TEST

BASE STATION MOUNTING DETAILS FOR MOST OUTDOOR SCOREBOARDS.

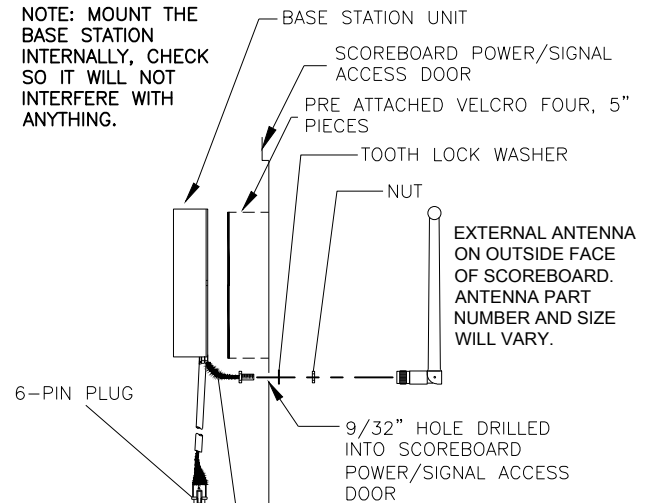

NOTE: MOUNT THE BASE STATION INTERNALLY, CHECK SO IT WILL NOT INTERFERE WITH ANYTHING.

MAKE SURE THAT THE ANTENNA CABLE IS COMING FROM THE BOTTOM OF THE BASE STATION, TO PREVENT WATER DAMAGE, AS SHOWN ABOVE.

PLUG THE 6-PIN MALE PLUG FROM THE BASE STATION INTO THE MATING 6-PIN JACK OF THE ADAPTOR HARNESS (W-2913).  
 PLUG THE MALE 5-PIN END OF THE ADAPTER HARNESS INTO THE MATING 5-PIN CONNECTOR (J45) COMING FROM THE DRIVER.

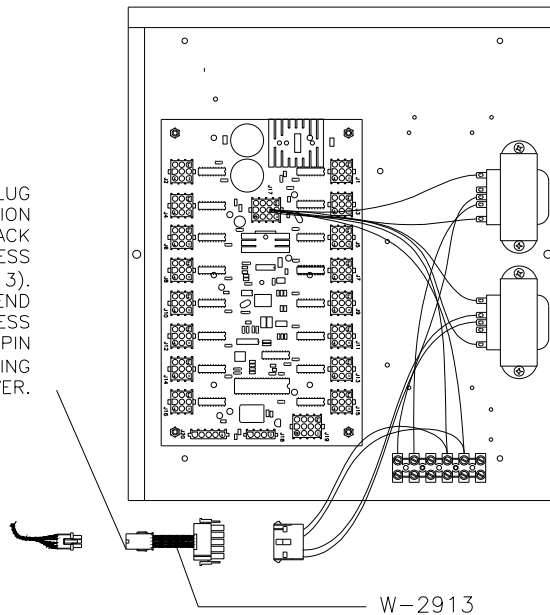

		THE CONCEPTS EXPRESSED AND DETAILS SHOWN ON THIS DRAWING ARE CONFIDENTIAL AND PROPRIETARY. DO NOT REPRODUCE BY ANY MEANS WITHOUT THE EXPRESS WRITTEN CONSENT OF DAKTRONICS, INC. OR ITS WHOLLY OWNED SUBSIDIARIES. COPYRIGHT 2017 DAKTRONICS, INC. (USA)		THIRD ANGLE PROJECTION 	
PROJECT: RC-100					
TITLE: BASE STATION: DISTAVIEW SCOREBOARD INSTALLATION					
DATE: 14 MAR 06		DIM UNITS: INCHES [MILLIMETERS]		SHEET	
SCALE: 1 = 7		DO NOT SCALE DRAWING		REV	
DESIGN:		JOB NO.		FUNC - TYPE - SIZE	
DRAWN: APAGE		P1110		E - 07 - A	
					3640952

SECONDARY WIRED SETUP

SIDE VIEW

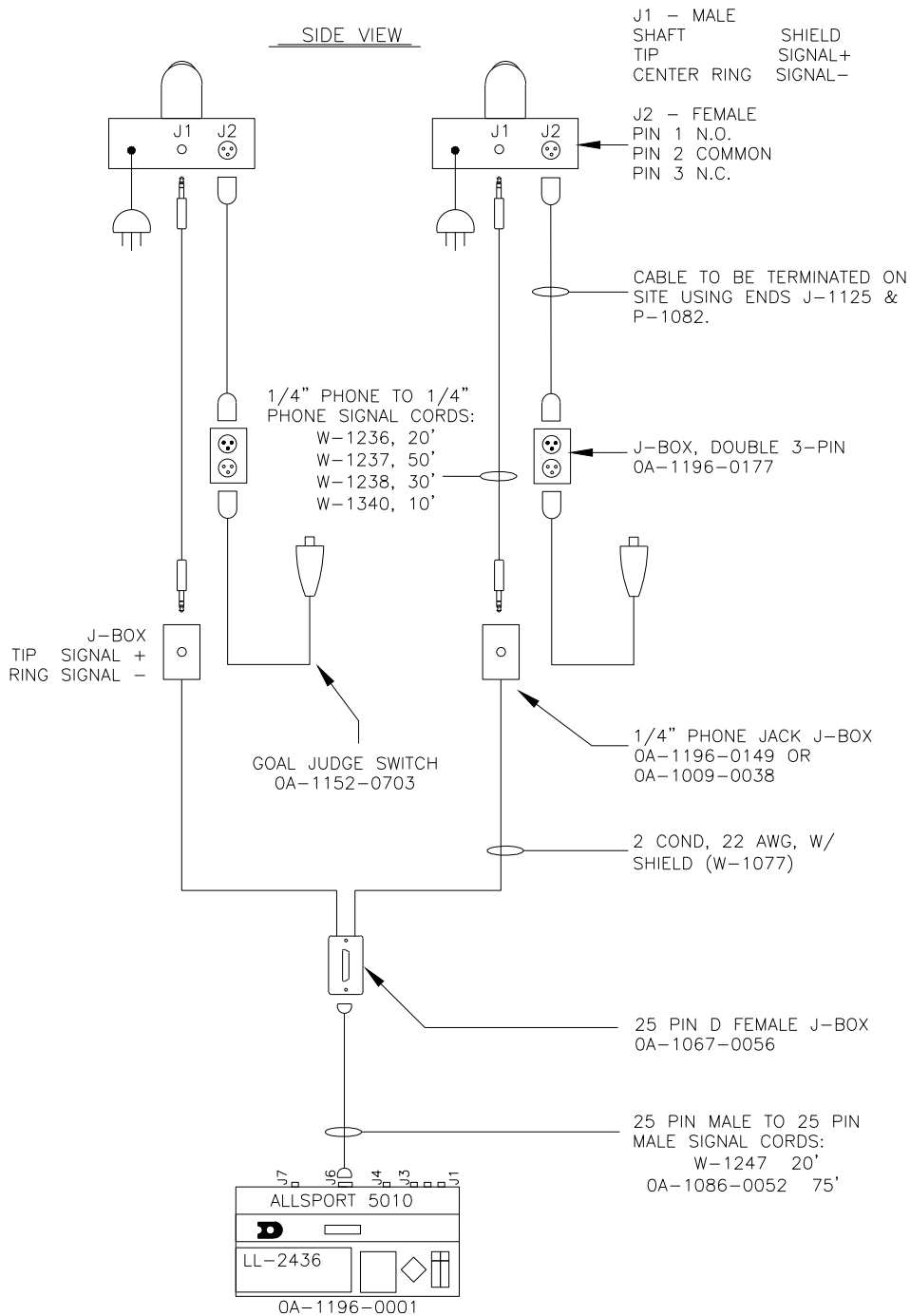

PRIMARY WIRELESS SETUP

FRONT VIEW

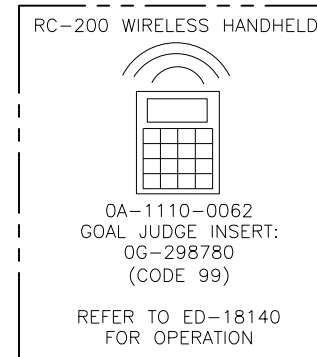
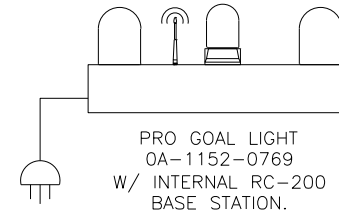

		THE CONCEPTS EXPRESSED AND DETAILS SHOWN ON THIS DRAWING ARE CONFIDENTIAL AND PROPRIETARY. DO NOT REPRODUCE BY ANY MEANS WITHOUT THE EXPRESS WRITTEN CONSENT OF DAKTRONICS, INC. OR ITS WHOLLY OWNED SUBSIDIARIES. COPYRIGHT 2017 DAKTRONICS, INC. (USA)		THIRD ANGLE PROJECTION		
PROJECT: STANDARD INDOOR LED SCOREBOARDS						
TITLE: RISER DIAGRAM: GOAL INDICATOR SYSTEM W/ RC-200						
DATE: 17 MAY 17		DIM UNITS: INCHES [MILLIMETERS]		SHEET REV		
SCALE: NTS		DO NOT SCALE DRAWING				
DESIGN: MMILLER		JOB NO. P1152		FUNC - TYPE - SIZE R - 01 - A		
DRAWN: AHUNTER						3640999



OUTDOOR BASE STATION  
REQUIRES CLEAR LINE OF SIGHT  
WITH HAND HELD RC-200 UNIT.

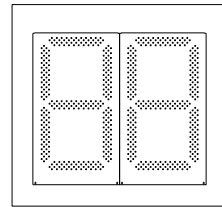
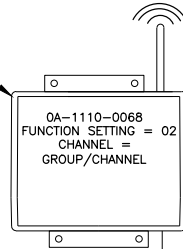

NOTE:  
THE WIRELESS BASE STATION COMES PRE-SET TO  
GROUP 1, CHANNEL 1. HOWEVER, ANY  
GROUP/CHANNEL CAN BE USED.

25' CABLE ATTACHED  
TO BASE STATION

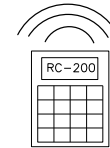

OA-1110-0062  
INSERT: OG-319079  
(REMOTE START/STOP) CODE 98

RC-200 HANDHELD  
CONTROLLER CAN BE USED TO  
CONTROL EITHER THE DOG  
CLOCK OR GAME CLOCK. THE  
CONTROL ROOM HANDHELDS  
CAN BE USED AS BACKUP/  
ALTERNATIVE CONNECTION.

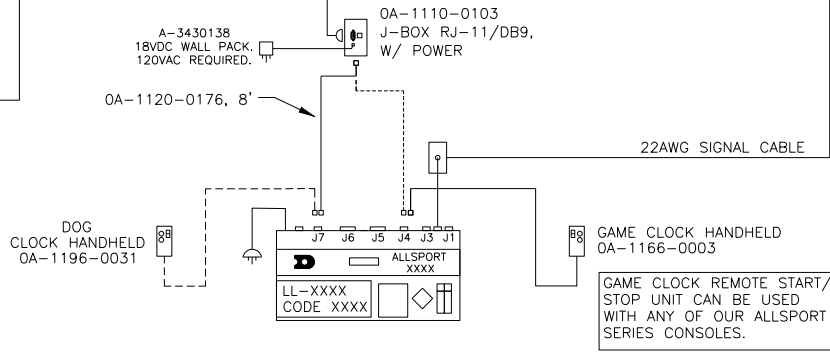

- OA-1110-0074, RC-200 REMOTE START/STOP KIT INCLUDES THE FOLLOWING:
- OA-1110-0064, RC-200 HAND HELD KIT
- OA-1110-0103, RC-200 REMOTE S/S J-BOX
- OA-1110-0068, RC-200 REMOTE S/S BASE STATION
- OA-1120-0176, 8' RJ-11 CABLE
- A-3430138, WALL PACK POWER TRANSFORMER
- OG-319079, REMOTE START STOP INSERT.

		<small>THE CONCEPTS EXPRESSED AND DETAILS SHOWN ON THIS DRAWING ARE CONFIDENTIAL AND PROPRIETARY. DO NOT REPRODUCE BY ANY MEANS WITHOUT THE EXPRESS WRITTEN CONSENT OF DAKTRONICS, INC. OR ITS WHOLLY OWNED SUBSIDIARIES. COPYRIGHT 2016 DAKTRONICS, INC. (USA)</small>		
PROJECT: RC-200 WIRELESS				
TITLE: SYSTEM RISER, RC-200 GAME/DOG CLOCK REMOTE ST/ST				
DATE: 29 JUNE 17	DM UNITS: INCHES [MILLIMETERS]	SHEET		REV
SCALE: 1 = 1	DO NOT SCALE DRAWING			
DESIGN: SCOLGRO	JOB NO.: P1110	FUNC - TYPE - SIZE: E - 10 - B	3660093	
DRAWN: SCOLGRO				

# B Sport Inserts

Refer to **Resources (p.1)** for information regarding how to read the drawing number.

**Reference Drawings:**

Insert; LL-2608, RC-100, Rodeo .....	<b>DWG-231529</b>
Insert: LL-2605- RC-100- Baseball .....	<b>DWG-231530</b>
Insert; LL-2607, RC-100, Tennis.....	<b>DWG-231531</b>
Insert; LL-2606, RC-100, Judges Console .....	<b>DWG-231532</b>
Custom Insert; Volleyball, RC-100 .....	<b>DWG-239304</b>
Insert; LL-2613, RC-100 Clock/Score .....	<b>DWG-239307</b>
Insert; LL-2613 Back, RC-100 Segment Timer.....	<b>DWG-247621</b>
Insert, LL-2632, RC-100, Basketball .....	<b>DWG-253583</b>
Insert; LL-2653, RC-100 Play Clock.....	<b>DWG-280870</b>
Insert; LL-2663, RC-100 Goal Judge .....	<b>DWG-298780</b>
Insert: Custom- RC-100- Start/Stop Remote.....	<b>DWG-319079</b>
Insert; Custom, RC-100, Football .....	<b>DWG-1031603</b>

*This page intentionally left blank.*



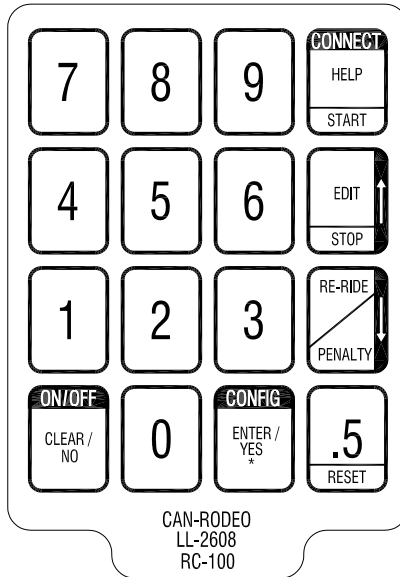

THE CONCEPTS EXPRESSED AND DETAILS SHOWN ON THIS DRAWING ARE CONFIDENTIAL AND PROPRIETARY. DO NOT REPRODUCE BY ANY MEANS, INCLUDING ELECTRONICALLY WITHOUT THE EXPRESSED WRITTEN CONSENT OF DAKTRONICS, INC. COPYRIGHT 2003 DAKTRONICS, INC.

DAKTRONICS, INC. BROOKINGS, SD 57006

PROJ: HANDHELD WIRELESS CAN SYSTEM

TITLE: INSERT; LL-2608, RC-100, RODEO

DES. BY: GWITCHE

DRAWN BY: GWITCHE

DATE: 12 JAN 05

REVISION

APPR. BY:

SCALE: 1 = 1

00

1110-E07A-231529

REV.	DATE	DESCRIPTION	BY	APPR.

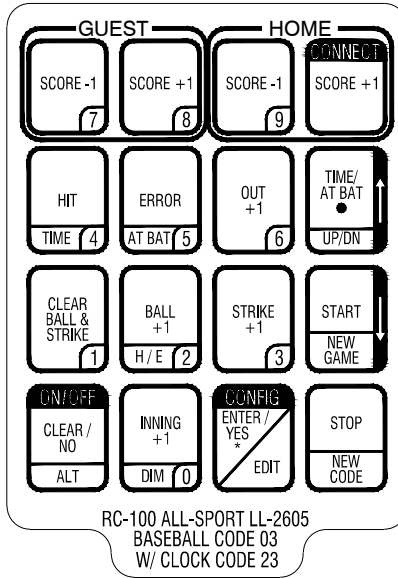

	<b>DAKTRONICS, INC.</b> BROOKINGS, SD 57006	THE CONCEPTS EXPRESSED AND DETAILS SHOWN ON THIS DRAWING ARE CONFIDENTIAL AND PROPRIETARY. DO NOT REPRODUCE BY ANY MEANS WITHOUT THE EXPRESSED WRITTEN CONSENT OF DAKTRONICS, INC. COPYRIGHT 2010 DAKTRONICS, INC.
	DO NOT SCALE DRAWING	

REV 03	DATE: 18 JUN 10	ADD H/E LABEL TO KEY 2.	BY: CRD
REV 02	DATE: 27 JUN 08	ADDED BASEBALL WITH CLOCK CODE 13 TEXT	BY: JMC
REV 01	DATE: 21 MAY 07	ADDED TIME/AT BAT CONTROLS	BY: JMC

PROJ: HANDHELD WIRELESS CAN SYSTEM			
TITLE: INSERT: LL-2605- RC-100- BASEBALL			
DESIGN: GWITCHE		DRAWN: GWITCHE	
SCALE: 1 = 1		DATE: 12 JAN 05	
SHEET	REV	JOB NO:	FUNC-TYPE-SIZE
	03	P1110	E-07-A
			231530

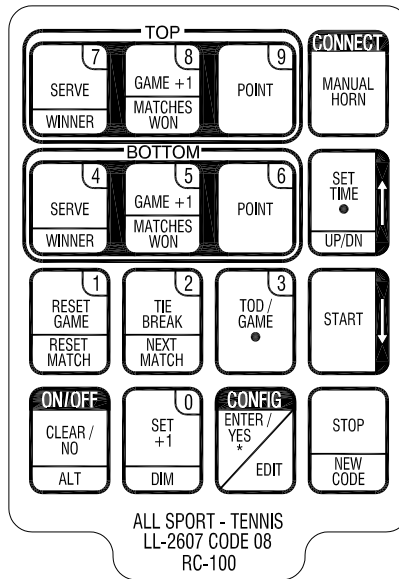

THE CONCEPTS EXPRESSED AND DETAILS SHOWN ON THIS DRAWING ARE CONFIDENTIAL AND PROPRIETARY. DO NOT REPRODUCE BY ANY MEANS, INCLUDING ELECTRONICALLY WITHOUT THE EXPRESSED WRITTEN CONSENT OF DAKTRONICS, INC. COPYRIGHT 2003 DAKTRONICS, INC.

DAKTRONICS, INC. BROOKINGS, SD 57006

PROJ: HANDHELD WIRELESS CAN SYSTEM

TITLE: INSERT; LL-2607, RC-100, TENNIS

DES. BY: GWITCHE

DRAWN BY: GWITCHE

DATE: 12 JAN 05

REVISION

APPR. BY:

SCALE: 1 = 1

01

1110-E07A-231531

REV.	DATE	DESCRIPTION	BY	APPR.
01	14 SEP 05	ADDED WINNER TEXT TO SERVE KEYS ADDED NEXT MATCH TEXT TO TIE BREAK KEY	DJU	

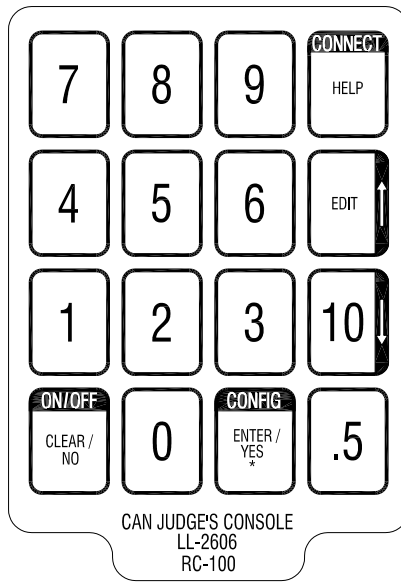

THE CONCEPTS EXPRESSED AND DETAILS SHOWN ON THIS DRAWING ARE CONFIDENTIAL AND PROPRIETARY. DO NOT REPRODUCE BY ANY MEANS, INCLUDING ELECTRONICALLY WITHOUT THE EXPRESSED WRITTEN CONSENT OF DAKTRONICS, INC. COPYRIGHT 2003 DAKTRONICS, INC.

DAKTRONICS, INC. BROOKINGS, SD 57006

PROJ: HANDHELD WIRELESS CAN SYSTEM

TITLE: INSERT; LL-2606, RC-100, JUDGES CONSOLE

DES. BY: GWITCHE

DRAWN BY: GWITCHE

DATE: 12 JAN 05

REVISION

APPR. BY:

00

SCALE: 1 = 1

1110-E07A-231532

REV.	DATE	DESCRIPTION	BY	APPR.

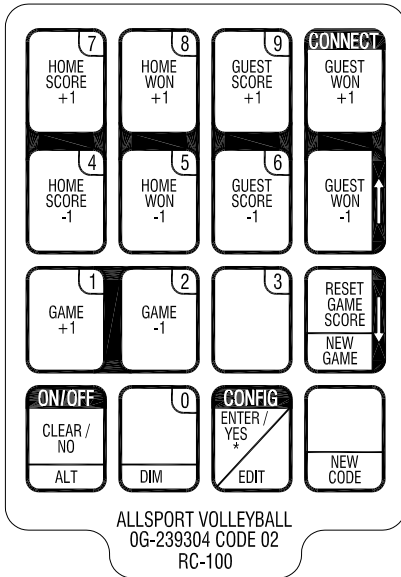

THE CONCEPTS EXPRESSED AND DETAILS SHOWN ON THIS DRAWING ARE CONFIDENTIAL AND PROPRIETARY. DO NOT REPRODUCE BY ANY MEANS, INCLUDING ELECTRONICALLY WITHOUT THE EXPRESSED WRITTEN CONSENT OF DAKTRONICS, INC. COPYRIGHT 2005 DAKTRONICS, INC.

DAKTRONICS, INC. BROOKINGS, SD 57006

PROJ:

TITLE: CUSTOM INSERT; VOLLEYBALL, RC-100

DES. BY:

DRAWN BY: GWITCHE

DATE: 14 APR 05

REVISION

APPR. BY:

00

SCALE: 1=1

1110-V07A-239304

REV.	DATE	DESCRIPTION	BY	APPR.

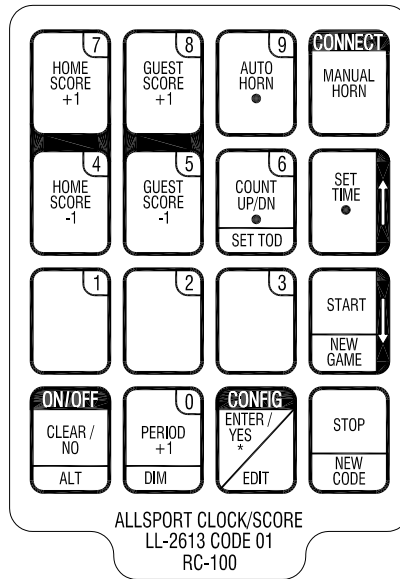

THE CONCEPTS EXPRESSED AND DETAILS SHOWN ON THIS DRAWING ARE CONFIDENTIAL AND PROPRIETARY. DO NOT REPRODUCE BY ANY MEANS, INCLUDING ELECTRONICALLY WITHOUT THE EXPRESSED WRITTEN CONSENT OF DAKTRONICS, INC. COPYRIGHT 2005 DAKTRONICS, INC.

DAKTRONICS, INC. BROOKINGS, SD 57006

PROJ:

TITLE: INSERT; LL-2613, RC-100 CLOCK/SCORE

DES. BY:

DRAWN BY: GWITCHE

DATE: 15 APR 05

REVISION

APPR. BY:

SCALE: 1=1

01

1110-R07A-239307

01	31 MAR 06	ADDED "SET TOD" ALT FUNCTION TO 6 KEY	DJU	
REV.	DATE	DESCRIPTION	BY	APPR.

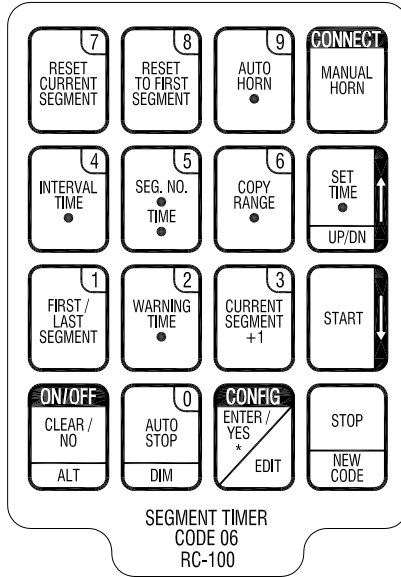

THE CONCEPTS EXPRESSED AND DETAILS SHOWN ON THIS DRAWING ARE CONFIDENTIAL AND PROPRIETARY. DO NOT REPRODUCE BY ANY MEANS, INCLUDING ELECTRONICALLY WITHOUT THE EXPRESSED WRITTEN CONSENT OF DAKTRONICS, INC. COPYRIGHT 2004 DAKTRONICS, INC.

DAKTRONICS, INC. BROOKINGS, SD 57006

PROJ: HANDHELD WIRELESS CAN SYSTEM

TITLE: INSERT; LL-2613 BACK, RC-100 SEGMENT TIMER

DES. BY:

DRAWN BY: DULSCHM

DATE: 14 JUL 05

REVISION

APPR. BY:

SCALE: 1 = 1

1110-R07A-247621

REV.	DATE	DESCRIPTION	BY	APPR.

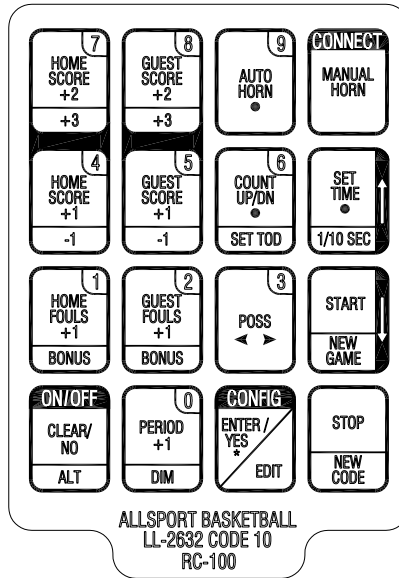

REV.	DATE	DESCRIPTION	BY	APPR.
02	31 MAY 06	ADDED NUMBER KEYS 1-9	JMC	
01	31 MAR 06	ADDED "SET TOD" ALT FUNC TO COUNT UP/DN	DJU	

THE CONCEPTS EXPRESSED AND DETAILS SHOWN ON THIS DRAWING ARE CONFIDENTIAL AND PROPRIETARY. DO NOT REPRODUCE BY ANY MEANS, INCLUDING ELECTRONICALLY WITHOUT THE EXPRESSED WRITTEN CONSENT OF DAKTRONICS, INC. COPYRIGHT 2004 DAKTRONICS, INC.

DAKTRONICS, INC. BROOKINGS, SD 57006

PROJ: HANDHELD WIRELESS CAN SYSTEM  
 TITLE: INSERT; LL-2632, RC-100, BASKETBALL  
 DES. BY: DULSCHM DRAWN BY: JCOSE DATE: 29 DEC 05

REVISION	APPR. BY:	1110-E07A-253583
02	SCALE: 1 = 1	



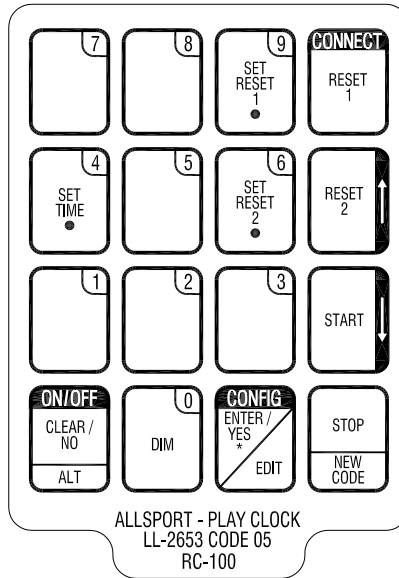

THE CONCEPTS EXPRESSED AND DETAILS SHOWN ON THIS DRAWING ARE CONFIDENTIAL AND PROPRIETARY. DO NOT REPRODUCE BY ANY MEANS, INCLUDING ELECTRONICALLY WITHOUT THE EXPRESSED WRITTEN CONSENT OF DAKTRONICS, INC. COPYRIGHT 2004 DAKTRONICS, INC.

DAKTRONICS, INC. BROOKINGS, SD 57006

PROJ: HANDHELD WIRELESS CAN SYSTEM

TITLE: INSERT; LL-2653, RC-100 PLAY CLOCK

DES. BY: DULSCHM

DRAWN BY: DULSCHM

DATE: 04 AUG 06

REVISION

APPR. BY:

SCALE: 1 = 1

1110-E07A-280870

REV.	DATE	DESCRIPTION	BY	APPR.

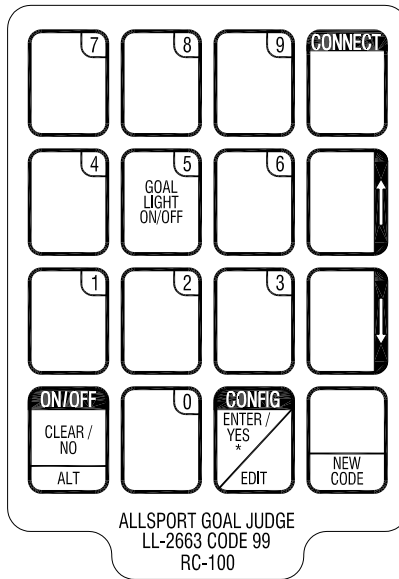

THE CONCEPTS EXPRESSED AND DETAILS SHOWN ON THIS DRAWING ARE CONFIDENTIAL AND PROPRIETARY. DO NOT REPRODUCE BY ANY MEANS, INCLUDING ELECTRONICALLY WITHOUT THE EXPRESSED WRITTEN CONSENT OF DAKTRONICS, INC. COPYRIGHT 2007 DAKTRONICS, INC.

DAKTRONICS, INC. BROOKINGS, SD 57006

PROJ:

TITLE: INSERT; LL-2663, RC-100 GOAL JUDGE

DES. BY: JCOSE

DRAWN BY: JCOSE

DATE: 08 MAR 07

REVISION

APPR. BY:

SCALE:

1=1

1110-R07A-298780

REV.	DATE	DESCRIPTION	BY	APPR.
00				

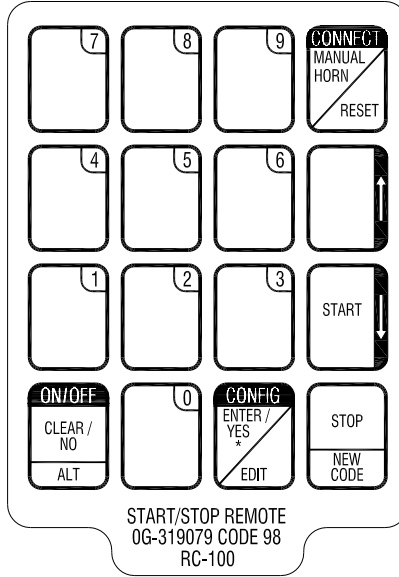

FRONT VIEW

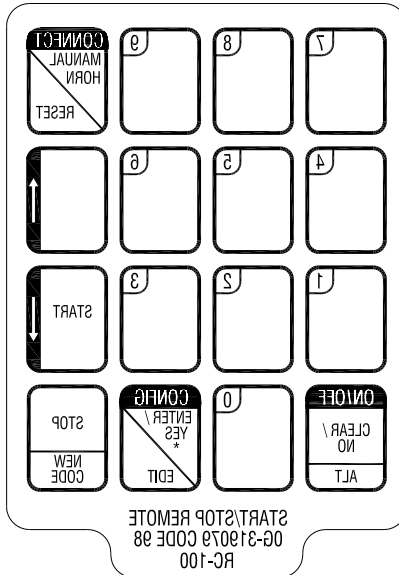

REAR VIEW

THE CONCEPTS EXPRESSED AND DETAILS SHOWN ON THIS DRAWING ARE CONFIDENTIAL AND PROPRIETARY. DO NOT REPRODUCE BY ANY MEANS, INCLUDING ELECTRONICALLY WITHOUT THE EXPRESSED WRITTEN CONSENT OF DAKTRONICS, INC. COPYRIGHT 2009 DAKTRONICS, INC.

DAKTRONICS, INC. BROOKINGS, SD 57006

PROJ:

TITLE: INSERT: CUSTOM- RC-100- START/STOP REMOTE

DES. BY: JCOSE

DRAWN BY: JCOSE

DATE: 07 AUG 07

REVISION

APPR. BY:

01

SCALE: 1=1

1110-R07A-319079

01	13 APR 09	ADDED RESET TO MANUAL HORN KEY	DJU	
REV.	DATE	DESCRIPTION	BY	APPR.

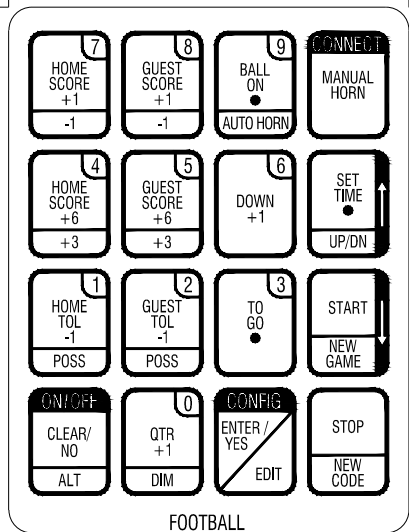

FOOTBALL  
 0G-1031603 CODE 61, 62  
 RC-100



**DAKTRONICS, INC.**

BROOKINGS, SD 57006

DO NOT SCALE DRAWING

THE CONCEPTS EXPRESSED AND DETAILS SHOWN ON THIS DRAWING ARE CONFIDENTIAL AND PROPRIETARY. DO NOT REPRODUCE BY ANY MEANS WITHOUT THE EXPRESSED WRITTEN CONSENT OF DAKTRONICS, INC. COPYRIGHT 2010 DAKTRONICS, INC.

PROJ: HANDHELD WIRELESS CAN SYSTEM			
TITLE: INSERT; CUSTOM, RC-100, FOOTBALL			
DESIGN: BCARSRU		DRAWN: DULSCHM	
SCALE: 1 = 1		DATE: 07 SEP 10	
SHEET	REV	JOB NO:	FUNC-TYPE-SIZE
	03	P1110	E-07-A
			1031603

REV 03	DATE: 25 MAR 13	ADDED CODE 62 TO DESCRIPTION	BY: DJU
REV 02	DATE: 12 NOV 10	ADDED EDIT TO ENTER KEY ADDED NO TO CLEAR KEY ADDED MANUAL TO HORN KEY	BY: DJU
REV 01	DATE: 22 SEP 10	MOVED AUTO HORN ALT FUNCTION FROM HORN KEY TO BALL ON KEY	BY: DJU

## **C Daktronics Warranty and Limitation of Liability**

This section includes the Daktronics Warranty & Limitation of Liability statement (SL-02374).

*This page intentionally left blank.*

# DAKTRONICS WARRANTY & LIMITATION OF LIABILITY

This Warranty and Limitation of Liability (the "Warranty") sets forth the warranty provided by Daktronics with respect to the Equipment. By accepting delivery of the Equipment, Purchaser and End User agree to be bound by and accept these terms and conditions. Unless otherwise defined herein, all terms within the Warranty shall have the same meaning and definition as provided elsewhere in the Agreement.

DAKTRONICS WILL ONLY BE OBLIGATED TO HONOR THE WARRANTY SET FORTH IN THESE TERMS AND CONDITIONS UPON RECEIPT OF FULL PAYMENT FOR THE EQUIPMENT.

## 1. Warranty Coverage

A. Daktronics warrants to the original end user (the "End User") that the Equipment will be free from Defects (as defined below) in materials and workmanship for a period of one (1) year (the "Warranty Period"). The Warranty Period shall commence on the earlier of: (i) four weeks from the date that the Equipment leaves Daktronics' facility; or (ii) Substantial Completion as defined herein. The Warranty Period shall expire on the first anniversary of the commencement date.

"Substantial Completion" means the operational availability of the Equipment to the End User in accordance with the Equipment's specifications, without regard to punch-list items, or other non-substantial items which do not affect the operation of the Equipment.

B. Daktronics' obligation under this Warranty is limited to, at Daktronics' option, replacing or repairing, any Equipment or part thereof that is found by Daktronics not to conform to the Equipment's specifications. Unless otherwise directed by Daktronics, any defective part or component shall be returned to Daktronics for repair or replacement. This Warranty does not include on-site labor charges to remove or install these components. Daktronics may, at its option, provide on-site warranty service. Daktronics shall have a reasonable period of time to make such replacements or repairs and all labor associated therewith shall be performed during regular working hours. Regular working hours are Monday through Friday between 8:00 a.m. and 5:00 p.m. at the location where labor is performed, excluding any holidays observed by Daktronics.

C. Daktronics shall pay ground transportation charges for the return of any defective component of the Equipment. All such items shall be shipped by End User DDP Daktronics designated facility. If returned Equipment is repaired or replaced under the terms of this Warranty, Daktronics will prepay ground transportation charges back to End User and shall ship such items DDP End User's designated facility; otherwise, End User shall pay transportation charges to return the Equipment back to the End User and such Equipment shall be shipped Ex Works Daktronics designated facility. All returns must be pre-approved by Daktronics before shipment. Daktronics shall not be obligated to pay freight for any unapproved return. End User shall pay any upgraded or expedited transportation charges.

D. Any replacement parts or Equipment will be new or serviceably used, comparable in function and performance to the original part or Equipment, and warranted for the remainder of the Warranty Period. Purchasing additional parts or Equipment from the Seller does not extend the Warranty Period.

E. Defects shall be defined as follows. With regard to the Equipment (excepting LEDs), a "Defect" shall refer to a material variance from the design specifications that prohibit the Equipment from operating for its intended use. With respect to LEDs, "Defects" are defined as LED pixels that cease to emit light. Unless otherwise expressly provided, this Warranty does not impose any duty or liability upon Daktronics for partial LED pixel degradation. Notwithstanding the foregoing, in no event does this Warranty include LED pixel degradation caused by UV light. This Warranty does not provide for the replacement or installation of communication methods including but not limited to, wire, fiber optic cable, conduit, trenching, or for the purpose of overcoming local site interference radio equipment substitutions.

EXCEPT AS OTHERWISE EXPRESSLY SET FORTH IN THIS WARRANTY, TO THE MAXIMUM EXTENT PERMITTED BY APPLICABLE LAW, DAKTRONICS DISCLAIMS ANY AND ALL OTHER PROMISES, REPRESENTATIONS AND WARRANTIES APPLICABLE TO THE EQUIPMENT AND REPLACES ALL OTHER WARRANTIES OR CONDITIONS, EXPRESS OR IMPLIED, INCLUDING, BUT NOT LIMITED TO, ANY IMPLIED WARRANTIES OR CONDITIONS OF MERCHANTABILITY, FITNESS FOR A PARTICULAR PURPOSE, OR ACCURACY OR QUALITY OF DATA. OTHER ORAL OR WRITTEN INFORMATION OR ADVICE GIVEN BY DAKTRONICS, ITS AGENTS OR EMPLOYEES, SHALL NOT CREATE A WARRANTY OR IN ANY WAY INCREASE THE SCOPE OF THIS LIMITED WARRANTY.

THIS LIMITED WARRANTY IS NOT TRANSFERABLE.

## 2. Exclusion from Warranty Coverage

This Warranty does not impose any duty or liability upon Daktronics for any:

A. damage occurring at any time, during shipment of Equipment unless otherwise provided for in the Agreement. When returning Equipment to Daktronics for repair or replacement, End User assumes all risk of loss or damage, agrees to use any shipping containers that might be provided by Daktronics, and to ship the Equipment in the manner prescribed by Daktronics;

B. damage caused by: (i) the improper handling, installation, adjustment, use, repair, or service of the Equipment, or (ii) any physical damage which includes, but is not limited to, missing, broken, or cracked components resulting from non-electrical causes; altered, scratched, or fractured electronic traces; missing or gauged solder pads; cuts or clipped wires; crushed, cracked, punctured, or bent circuit boards; or tampering with any electronic connections, provided that such damage is not caused by personnel of Daktronics or its authorized repair agents;

C. damage caused by the failure to provide a continuously suitable environment, including, but not limited to: (i) neglect or misuse; (ii) improper power including, without limitation, a failure or sudden surge of electrical power; (iii) improper air conditioning, humidity control, or other environmental conditions outside of the Equipment's technical specifications such as extreme temperatures, corrosives and metallic pollutants; or (iv) any other cause other than ordinary use;

# DAKTRONICS WARRANTY & LIMITATION OF LIABILITY

D. damage caused by fire, flood, earthquake, water, wind, lightning or other natural disaster, strike, inability to obtain materials or utilities, war, terrorism, civil disturbance, or any other cause beyond Daktronics' reasonable control;

E. failure to adjust, repair or replace any item of Equipment if it would be impractical for Daktronics personnel to do so because of connection of the Equipment by mechanical or electrical means to another device not supplied by Daktronics, or the existence of general environmental conditions at the site that pose a danger to Daktronics personnel;

F. statements made about the product by any salesperson, dealer, distributor or agent, unless such statements are in a written document signed by an officer of Daktronics. Such statements as are not included in a signed writing do not constitute warranties, shall not be relied upon by End User and are not part of the contract of sale;

G. damage arising from the use of Daktronics products in any application other than the commercial and industrial applications for which they are intended, unless, upon request, such use is specifically approved in writing by Daktronics;

H. replenishment of spare parts. In the event the Equipment was purchased with a spare parts package, the parties acknowledge and agree that the spare parts package is designed to exhaust over the life of the Equipment, and as such, the replenishment of the spare parts package is not included in the scope of this Warranty;

I. security or functionality of the End User's network or systems, or anti-virus software updates;

J. performance of preventive maintenance;

K. third-party systems and other ancillary equipment, including without limitation front-end video control systems, audio systems, video processors and players, HVAC equipment, batteries and LCD screens;

L. incorporation of accessories, attachments, software or other devices not furnished by Daktronics; or

M. paint or refinishing the Equipment or furnishing material for this purpose.

### **3. Limitation of Liability**

Daktronics shall be under no obligation to furnish continued service under this Warranty if alterations are made to the Equipment without the prior written approval of Daktronics.

It is specifically agreed that the price of the Equipment is based upon the following limitation of liability. In no event shall Daktronics (including its subsidiaries, affiliates, officers, directors, employees, or agents) be liable for any claims asserting or based on (a) loss of use of the facility or equipment; lost business, revenues, or profits; loss of goodwill; failure or increased cost of operations; loss, damage or corruption of data; loss resulting from system or service failure, malfunction, incompatibility, or breaches in system security; or (b) any special, consequential, incidental or exemplary damages arising out of or in any way connected with the Equipment or otherwise, including but not limited to damages for lost profits, cost of substitute or replacement equipment, down time, injury to property or any damages or sums paid to third parties, even if Daktronics has been advised of the possibility of such damages. The foregoing limitation of liability shall apply whether any claim is based upon principles of contract, tort or statutory duty, principles of indemnity or contribution, or otherwise.

In no event shall Daktronics be liable for loss, damage, or injury of any kind or nature arising out of or in connection with this Warranty in excess of the Purchase Price of the Equipment. The End User's remedy in any dispute under this Warranty shall be ultimately limited to the Purchase Price of the Equipment to the extent the Purchase Price has been paid.

### **4. Assignment of Rights**

The Warranty contained herein extends only to the End User (which may be the Purchaser) of the Equipment and no attempt to extend the Warranty to any subsequent user-transferee of the Equipment shall be valid or enforceable without the express written consent of Daktronics.

### **5. Governing Law**

The rights and obligations of the parties under this Warranty shall not be governed by the provisions of the United Nations Convention on Contracts for the International Sales of Goods of 1980. The parties consent to the application of the laws of the State of South Dakota to govern, interpret, and enforce each of the parties' rights, duties, and obligations arising from, or relating in any manner to, the subject matter of this Warranty, without regard to conflict of law principles.

### **6. Availability of Extended Service Agreement**

For End User's protection, in addition to that afforded by the warranties set forth herein, End User may purchase extended warranty services to cover the Equipment. The Extended Service Agreement, available from Daktronics, provides for electronic parts repair and/or on-site labor for an extended period from the date of expiration of this warranty. Alternatively, an Extended Service Agreement may be purchased in conjunction with this Warranty for extended additional services. For further information, contact Daktronics Customer Service at 1-800-DAKTRONICS (1-800-325-8766).

