



2:1 Half-Rectangle Triangle Ruler Set

The 2:1 ratio means the unit will be twice as long as it is wide and this is the industry standard. If a pattern requires a half-rectangle triangle ruler, this is the ratio they are referring to.

HRT A Ruler

- ◆ 4 1/2" x 8 1/2" is the outside dimension.
- ◆ Ruler has multiple sizes down to 1/8" increments.
- ◆ **Logo is always positioned on the 'low side'** of unit regardless of which side the seam is pressed.
- ◆ HRT A Ruler is considered to be the **left** ruler.

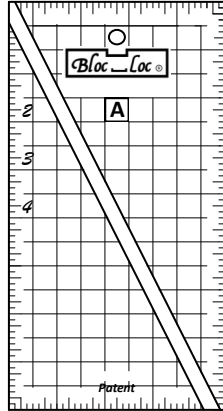

HRT B Ruler

- ◆ 4 1/2" x 8 1/2" is the outside dimension.
- ◆ Ruler has multiple sizes down to 1/8" increments.
- ◆ **Logo is always positioned on the 'low side'** of unit regardless of which side the seam has been pressed. HRT B Ruler is considered to be the **right** ruler.

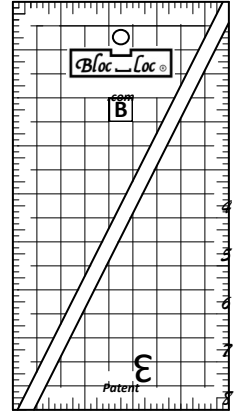

HRT A Unit

Completed but not trimmed, so it is NOT finished yet.

In this illustration, the seam has been pressed to the white triangle.

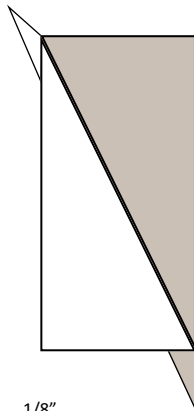

HRT B Unit

Completed but not trimmed, so it is NOT finished yet.

In this illustration, the seam has been pressed to the white triangle.

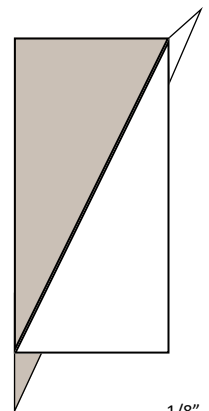

HRT A Unit

Trimmed but not finished yet.

In this illustration, the seam has been pressed to the white triangle. Diagonal seam is located 1/8" from the corner on each end.

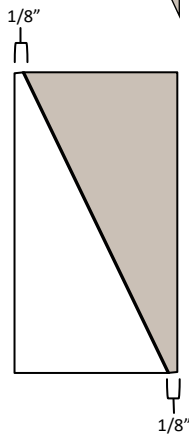

HRT B Unit

Trimmed but not finished yet.

In this illustration, the seam has been pressed to the white triangle. Diagonal seam is located 1/8" from the corner on each end.

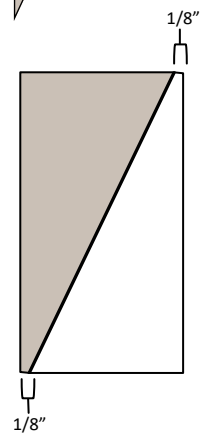

HRT A Unit

When finished (COMPLETELY SEWN IN), the diagonal seam will end in the corner.

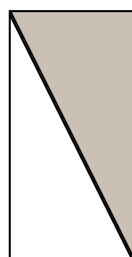

HRT B Unit

When finished (COMPLETELY SEWN IN), the diagonal seam will end in the corner.

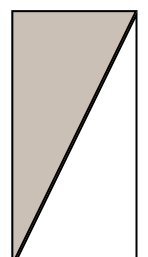

Making HRT Units (practice)

1. Arrange 5" x 10" rectangles into pairs with **RIGHT SIDES UP (RSU)**.

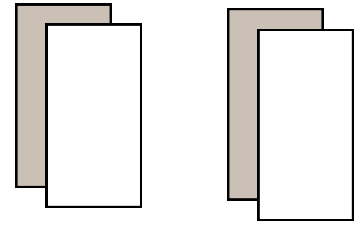

(1) 5" x 10" taupe fabric and
(1) background fabric EACH

2. Cut one pair in half diagonally corner to corner from lower RIGHT to upper LEFT.
THIS DIRECTION IS FOR AN "A" UNIT.

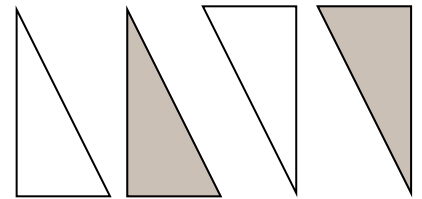
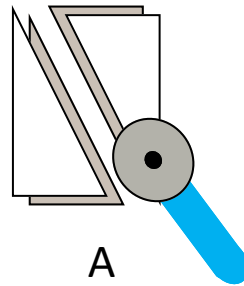

Spread the triangles apart and this is what you get after an "A" cut.

3. Re-arrange the pieces to pair a background and taupe rectangle each as shown right.

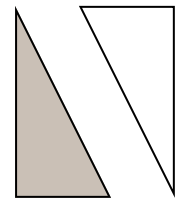
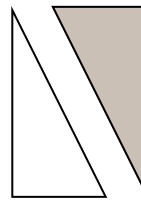

4. Re-arrange the A triangles to look like this in front of your sewing machine. Drag the background triangle down to down to make the distance across wider. It will now be off-set from the taupe triangle by nearly 1/2".

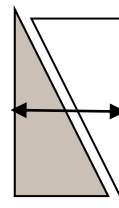

From 1/4" offset ...

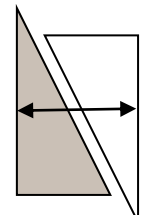

...to nearly 1/2" offset

5. Flip each white triangle onto a taupe triangle so they are right sides together (RST).

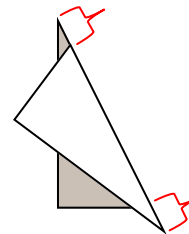

Flip the white triangle on top of the pink triangle so there is nearly 1/2" space from the pink tip to the white corner.

6. Stitch 1/4" seam. Press seams to the background triangle.

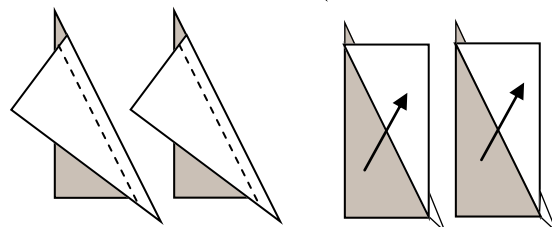

Pink triangle is now the low side.

7. Trim to **4 1/2" x 8 1/2"** using Bloc Loc HRT A ruler. Make sure the Bloc Loc logo on the ruler is placed on the side of the unit where there is no seam allowance. Trim just a few threads along right side and across the top. Turn the mat around and slide ruler along seam until the correct size appears on the newly cut edges of Unit A. Make sure the ruler is fully locked on before making the final trim.

Right Handed Trimming

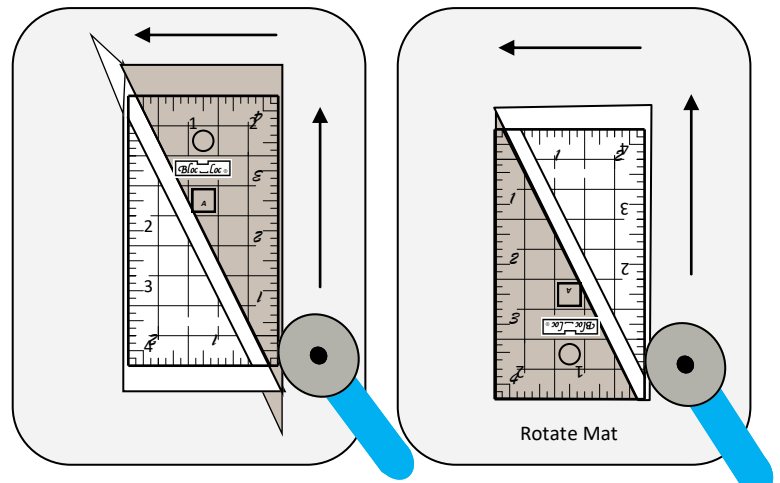

Seam will end 1/8" from each corner. Stack (all same orientation) and set to one side.

Stack all HRT A units together.

Left Handed Trimming

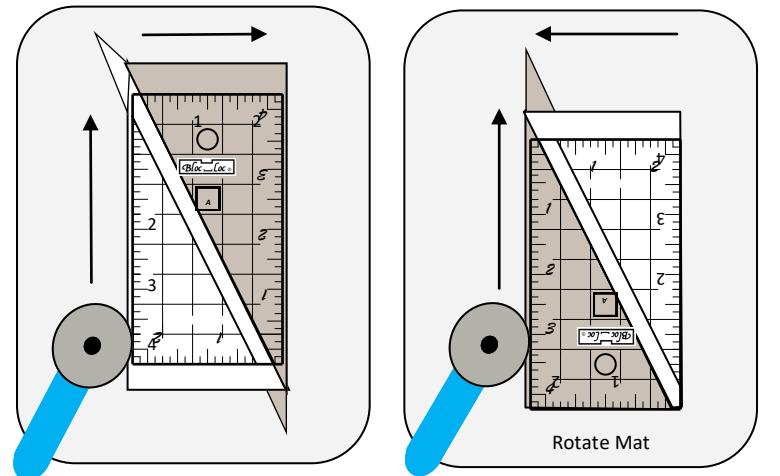

OOPS! What's Wrong With This HRT Unit ?

The unit shown right has been trimmed with the logo on the high side instead of the low side which will result in an excess of 1/4" on each end. If this ever happens, set it aside and use it someday in a project. Technically, it's incorrect for this project and so you would need to make another unit.

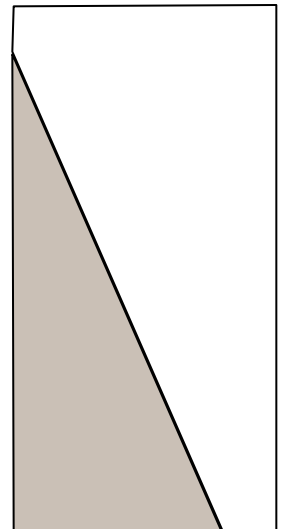

1. UNIT B: Cut the second pair in half diagonally corner to corner exactly like this for all HRT B units.

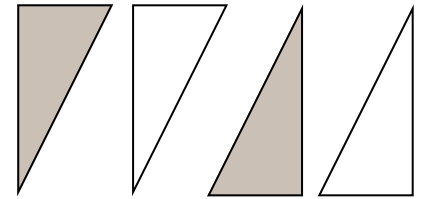
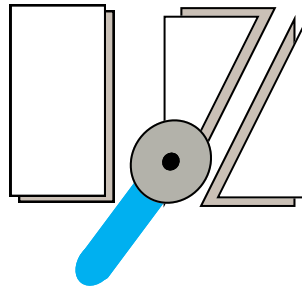

Spread the triangles apart and this is what you get after an "B" cut.

2. Re-arrange the B triangles to look like this in front of your sewing machine. Drag the background triangle down to down to make the distance across wider. It will now be off-set from the taupe triangle by nearly than 1/2".

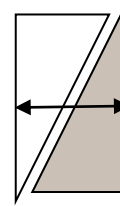

From 1/4" offset ...

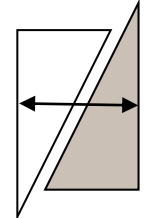

...to nearly 1/2" offset

3. Flip each taupe triangle onto a background triangle so they are right sides together (RST).

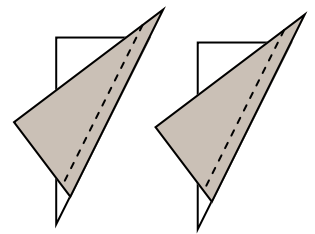
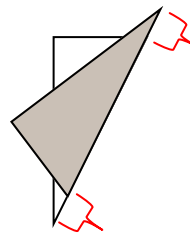

4. Stitch 1/4" seam. Press seams to the taupe triangle.

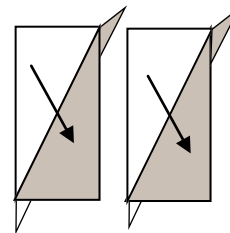

Background triangle is now on the low side.

Seam allowances are under the taupe triangle.

Q: Why is the B unit pressed in the opposite direction? A: It must be pressed this way if the unit is to be matched with an A unit so the seams will nestle.

Right Handed Trimming

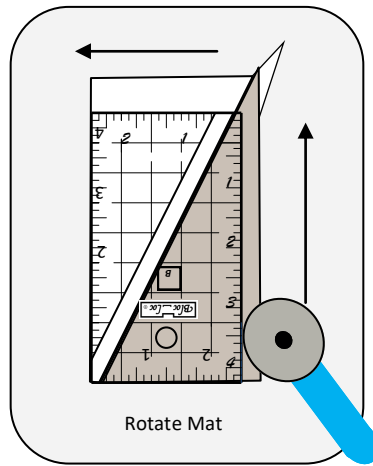
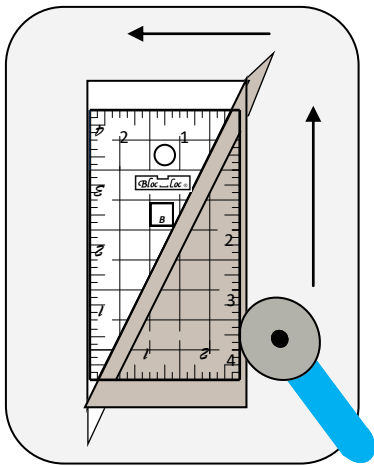

Rotate Mat

Left Handed Trimming

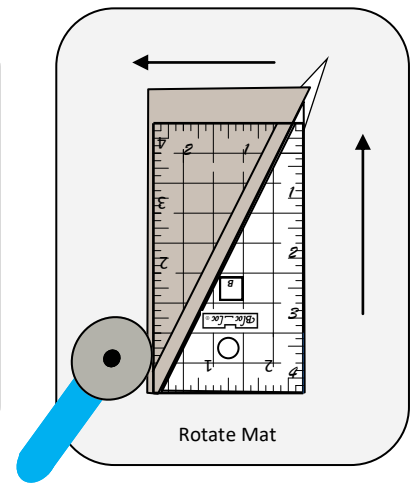
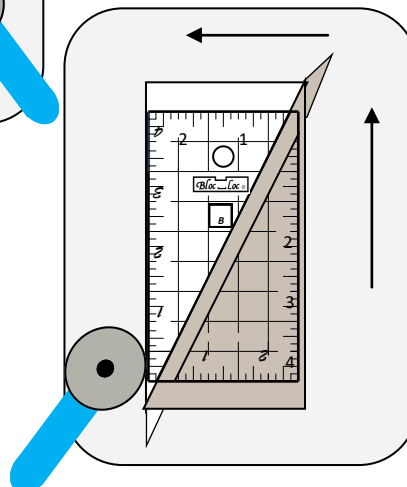

Rotate Mat

Stack all HRT B units together.

How to join HRT A and HRT B together so you will achieve a perfect 1/4" seam allowance at the peak.

GOAL: There must be a full 1/4" at the top, starting from the peak to the cut edge.

HOW: Set your stitch length at 2.0 AND select "needle down". With RST, **flip HRT Unit A on top of Unit B** so the seams are interlocked. Pin as shown. Begin counting the stitches from the raw edge to the first diagonal seam. You should be able to stitch 4-5 stitches from the cut edge of the unit to the diagonal seam. Knowing this should make it easier to make a perfect 1/4" seam across the top.

Press center (vertical) seam open.

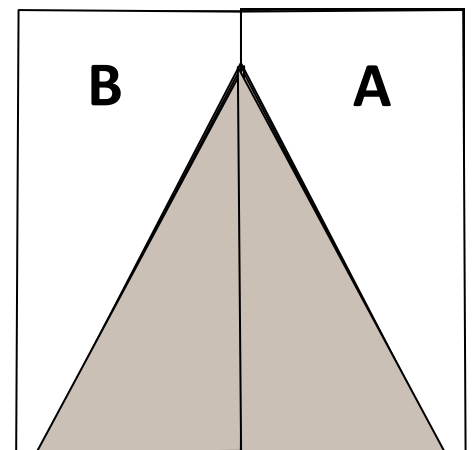
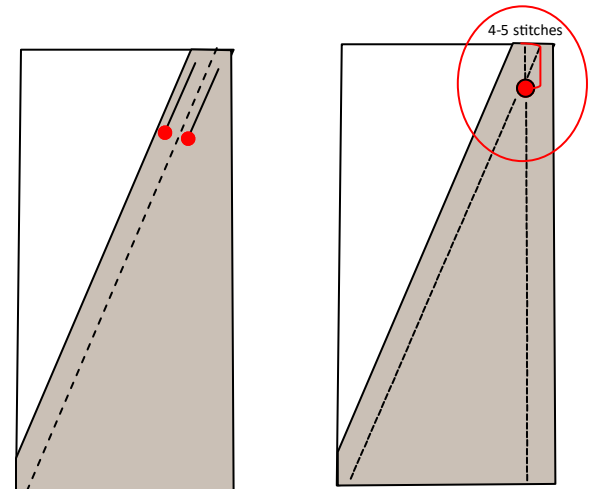
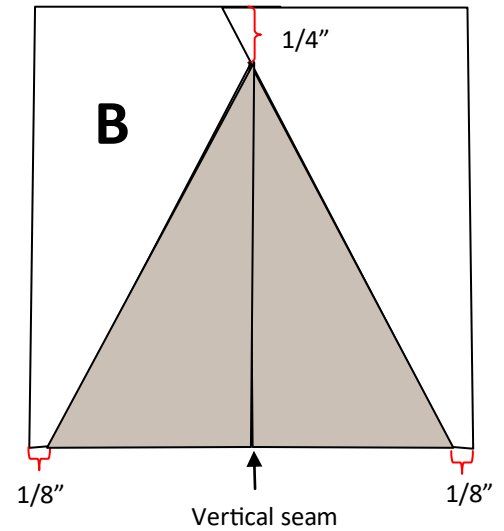

Press center (vertical) seam open.