

METAL CEILINGS

LINEAR
BOX 4 & DEEP BOX 4 SERIES

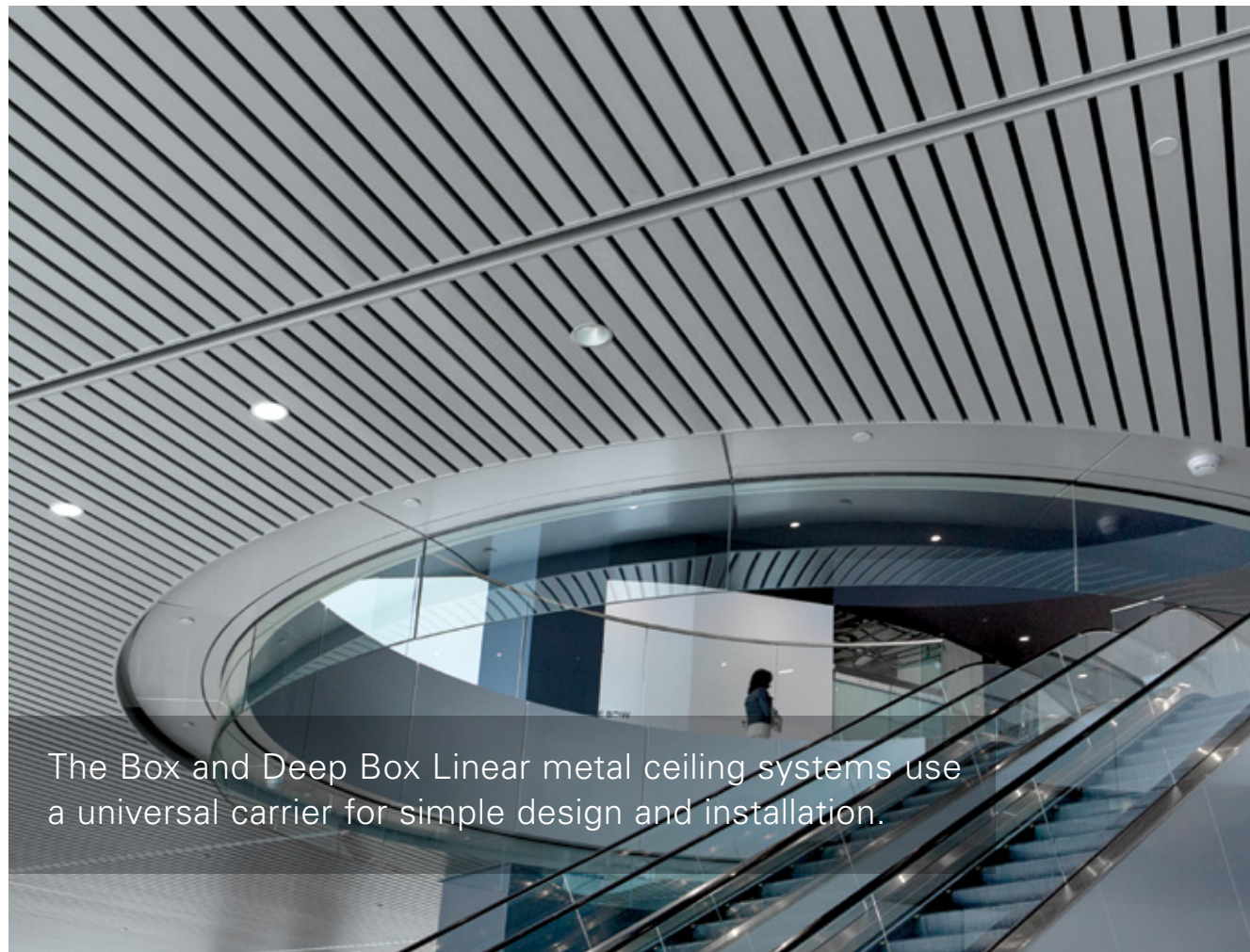

The Box and Deep Box Linear metal ceiling systems use a universal carrier for simple design and installation.

Project: The Bow, Encana, Calgary, Canada; Box 4 Photo credit: Bob Perzel

KEY FEATURES

- Panel module width: 4"
- Panel lengths: 3' to 16'
- Panel depths:
 - 5/8" (Box 4)
 - 1" (Deep Box 4)
- Square-edge design
- Curved carrier application available
- Waste reduction with factory fabricated dimensional material
- Downweight: reduce dead load with lightweight aluminum
- Easy plenum access
- Interior and exterior applications
- Compatible with industry standard lighting, HVAC, speaker, fire safety, and security services

TYPICAL SECTIONS

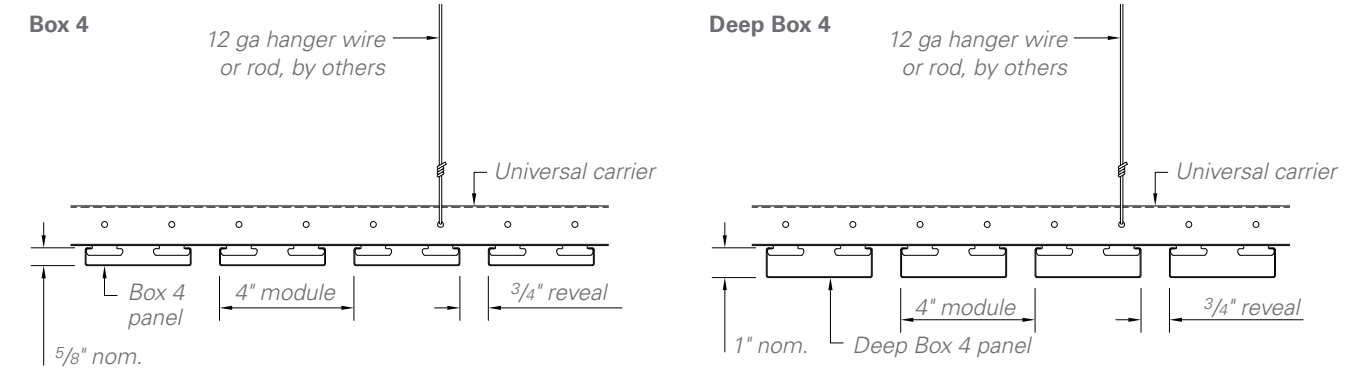

TYPICAL ISOMETRICS

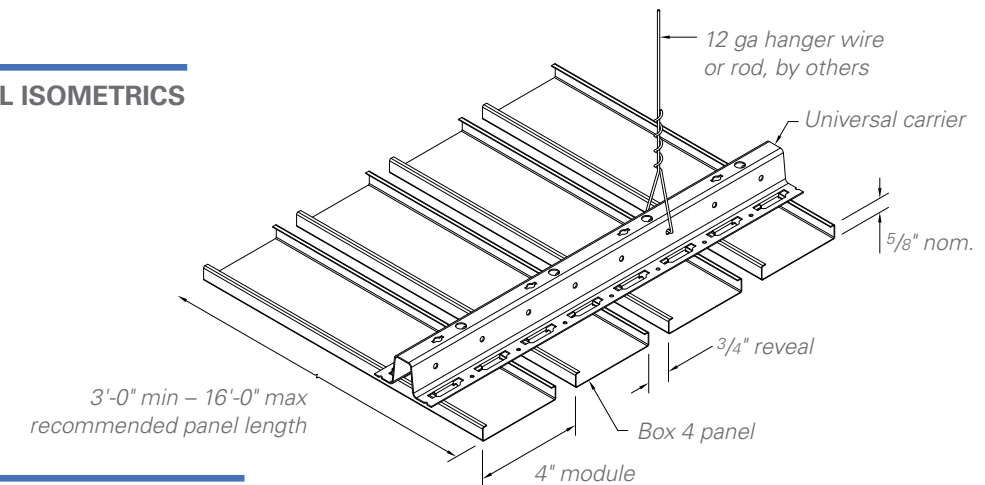

PERFORATION PATTERNS

Standard patterns shown. Perforations not available on real wood veneer. Scale shown: 1:1, unless otherwise noted.

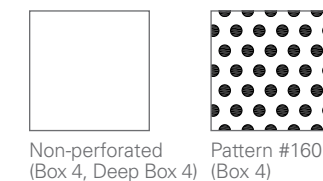

PHYSICAL DATA

Substrate: Aluminum
Warranty: 1 year
Seismic rating: Zones A,B,C,D,E,F
Fire rating: Class A Fire Rated per ASTM E84
 - Painted or anodized metal: Flame spread: ≤ 25, Smoke ≤ 50
 - Film on metal: Flame spread: ≤ 25, Smoke ≤ 50
 - Wood veneer on metal: Flame spread: ≤ 25, Smoke ≤ 55 (for interior applications)
Weight: Varies 0.5 – 1.0 lbs./sq.ft.
Wind load: Per code (for exterior applications)
Recycled content: Up to 92%
Light reflectance (LR) Coefficient per ASTM E1264 & ASTM E1477:
 - Varies with finish
 - Cotton White: LR = 0.81
Acoustical ratings – NRC: See Resources section.

BIM

REVIT files available for BIM contributions, see website for details.

LEED V4 CREDITS

EA: Optimize Energy Performance
 MR: Building Product Disclosure
 EQ: Low-Emitting Materials
 EQ: Indoor Air Quality Assessment
 EQ: Daylight
 EQ: Acoustic Performance

CERTIFICATIONS

GREENGUARD Gold Certified
 EPDs – available upon request

METAL CEILINGS

LINEAR BOX 4 & DEEP BOX 4 SERIES

COLORS & FINISHES

A wide choice of colors and finishes are available and some carry a premium price over manufacturer's standard colors. Custom color matching is available upon request. Minimum quantities and lead times may apply. See website for the most up to date information and to order samples. Colors are for illustration purposes only.

STANDARD PAINT COLORS



Natural 7163 Cotton White 0280

CUSTOM COLORS

Premium custom colors.



Custom

WHITE FINISH OPTIONS

Powder-coat paint finish for Arctic White #1015P (Gloss 10-20); Crystalline White #1050P (Gloss 45-55); Supernova White #1085P (Gloss 80-90)

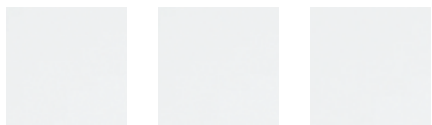

Arctic White 1015P Crystalline White 1050P Supernova White 1085P

DAYLIGHTING WHITE PAINT FINISH

Powder-coat paint finish offering LRV 96; non-glare, 3% low gloss finish. Certified by: Applied Technical Services, Inc. Test Report No. D233185. Test reports available by request.

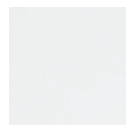

Performance White 9603P

STANDARD METALLIC

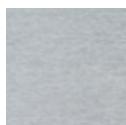

Brushed Aluminum 0004

BLACK FINISH OPTIONS

Powder-coat paint finish for Starless Black #5000P (Matte); Raven Black #5030P (Gloss 25-35); Sable Black #5060P (Gloss 65-75); Wet Glass Black #5095P (Gloss 90-95)



Starless Black 5000P Raven Black 5030P Sable Black 5060P Wet Glass Black 5095P



STANDARD WOOD VENEER OPTIONS

Real wood veneer (interior only). Formaldehyde-free, Class A composite panel. Non-perforated only. Note: This is a small subset of veneers available. Please contact manufacturer for client-specific species and stains.



White Oak (Rift) 9003 Douglas Fir (VG) 9005 Cherry (Flat) 9013 Walnut (Flat) 9114 Anigre (Qtr) 9122 Maple (Flat) 9427

DECORATED WOOD-LOOK OPTIONS

Powder-coat paint finish (interior and exterior). Formaldehyde-free, Class A composite panel. This finish is recommended for exterior conditions.



Fonthill Cherry 8422 Walnut 8424 Amber Bamboo 8432 Fine Wenge 8433 Grey Barnwood Cedar 8434 Golden Douglas Fir 8436 American Oak 8439 Crazy Cajun Cypress 8442 Swamp Cypress 8444 Clipper Teak 8446 Windjammer Teak 8449 Douglas Fir 8452 Anigre 8453 Farm Maple 8458 Caravel Teak 8460 Regatta Teak 8461 Summer Maple 8465 Terrace Maple 8466 Light Pecan 8475 Northwest Mountain Hemlock 8486 Whitewash 8487 Rustic Cherry 8739 Cherry 8742

COIL-COATED WOOD-LOOK OPTIONS

Polyester coil-coated painted finish (interior and exterior). Formaldehyde-free, Class A composite panel. Minimums apply.

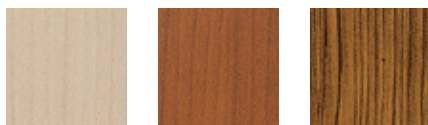

Chaucer Maple 8947 Columbia Cherry 8950 Celtic Walnut 8956

LAMINATED (FILM) WOOD FINISHES

Film (interior only). Formaldehyde-free, Class A composite panel. Minimums apply.



American Natural 8000 Russian Maple 8003 Hayward Cherry 8005 Caramel Bamboo 8030 Straight Larch 8104 Northern Walnut 8105 Eastern Black Walnut 8106 Chatham Oak 8107