



The Box and Deep Box Linear metal ceiling systems use a universal carrier for simple design and installation.

Project: Mayo Clinic Proton Therapy Facility PHX, Phoenix, AZ; Deep Box 6 Photo credit: Robb Williamson, AECOM Corporate Photographer

KEY FEATURES

- Panel module width: 6"
- Panel lengths: 3' to 16'
- Panel depths:
 - 5/8" (Box 6)
 - 1" (Deep Box 6)
- Square-edge design
- Curved carrier application available
- Waste reduction with factory fabricated dimensional material
- Downweight: reduce dead load with lightweight aluminum
- Easy plenum access
- Interior and exterior applications
- Compatible with industry standard lighting, HVAC, speaker, fire safety, and security services

TYPICAL SECTIONS

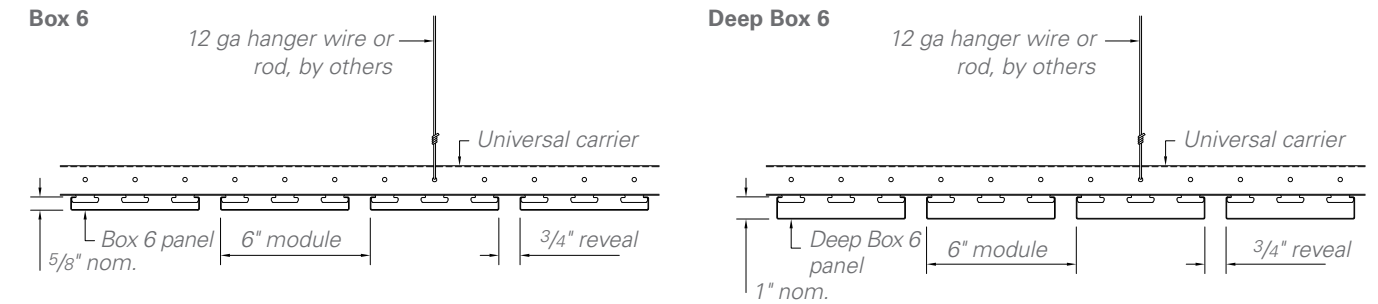

TYPICAL ISOMETRICS

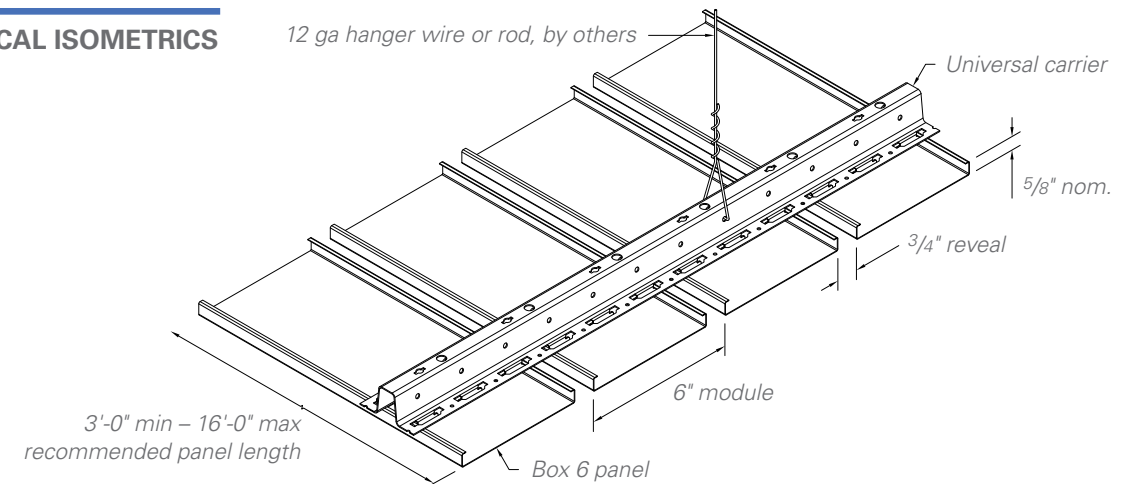

PERFORATION PATTERNS

Standard patterns shown. Perforations not available on real wood veneer. Scale shown: 1:1, unless otherwise noted.

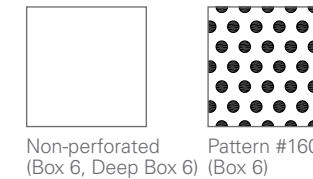

PHYSICAL DATA

Substrate: Aluminum
Warranty: 1 year
Seismic rating: Zones A,B,C,D,E,F
Fire rating: Class A Fire Rated per ASTM E84
 – Painted or anodized metal: Flame spread: ≤ 25, Smoke ≤ 50
 – Film on metal: Flame spread: ≤ 25, Smoke ≤ 50
 – Wood veneer on metal: Flame spread: ≤ 25, Smoke ≤ 55 (for interior applications)
Weight: Varies 0.5 – 1.0 lbs./sq.ft.
Wind load: Per code (for exterior applications)
Recycled content: Up to 92%
Light reflectance (LR) Coefficient per ASTM E1264 & ASTM E1477:
 – Varies with finish
 – Cotton White: LR = 0.81
Acoustical ratings – NRC: See Resources section.

BIM

REVIT files available for BIM contributions, see website for details.

LEED V4 CREDITS

EA: Optimize Energy Performance
 MR: Building Product Disclosure
 EQ: Low-Emitting Materials
 EQ: Indoor Air Quality Assessment
 EQ: Daylight
 EQ: Acoustic Performance

CERTIFICATIONS

GREENGUARD Gold Certified
 EPDs – available upon request

METAL CEILINGS

LINEAR BOX 6 & DEEP BOX 6 SERIES

COLORS & FINISHES

A wide choice of colors and finishes are available and some carry a premium price over manufacturer's standard colors. Custom color matching is available upon request. Minimum quantities and lead times may apply. See website for the most up to date information and to order samples. Colors are for illustration purposes only.

STANDARD PAINT COLORS



CUSTOM COLORS

Premium custom colors.

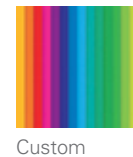

WHITE FINISH OPTIONS

Powder-coat paint finish for Arctic White #1015P (Gloss 10-20); Crystalline White #1050P (Gloss 45-55); Supernova White #1085P (Gloss 80-90)

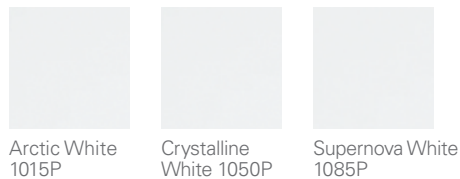

DAYLIGHTING WHITE PAINT FINISH

Powder-coat paint finish offering LRV 96; non-glare, 3% low gloss finish. Certified by: Applied Technical Services, Inc. Test Report No. D233185. Test reports available by request.

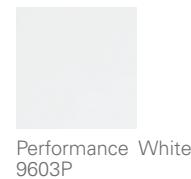

STANDARD METALLIC

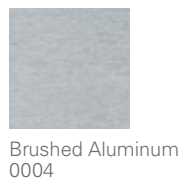

BLACK FINISH OPTIONS

Powder-coat paint finish for Starless Black #5000P (Matte); Raven Black #5030P (Gloss 25-35); Sable Black #5060P (Gloss 65-75); Wet Glass Black #5095P (Gloss 90-95)



STANDARD WOOD VENEER OPTIONS

Real wood veneer (interior only). Formaldehyde-free, Class A composite panel. Non-perforated only. Note: This is a small subset of veneers available. Please contact manufacturer for client-specific species and stains.

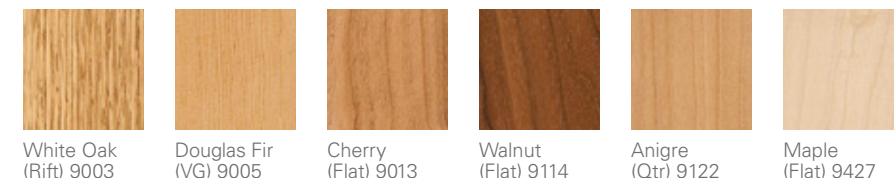

DECORATED WOOD-LOOK OPTIONS

Powder-coat paint finish (interior and exterior). Formaldehyde-free, Class A composite panel. This finish is recommended for exterior conditions.



COIL-COATED WOOD-LOOK OPTIONS

Polyester coil-coated painted finish (interior and exterior). Formaldehyde-free, Class A composite panel. Minimums apply.

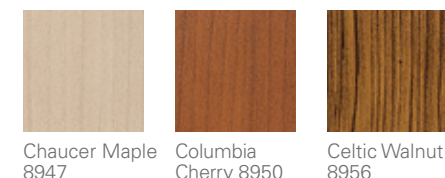

LAMINATED (FILM) WOOD FINISHES

Film (interior only). Formaldehyde-free, Class A composite panel. Minimums apply.

