

METAL CEILINGS

PLANK & TILE
HOOK-ON



Hook-On metal ceiling systems offer simple and customizable ceiling solutions.

Project: UNC Charlotte PORTAL Bldg Cafe; Charlotte, NC; Hook-On Photo credit: Bob Perzel

KEY FEATURES

- Two panel size sets:
 - 6" to 24" widths up to 120" long
 - 30" width up to 60" long
- Square-edge design
- Waste reduction with factory fabricated dimensional material
- Downweight: reduce dead load with lightweight aluminum
- Easy plenum access
- Compatible with industry standard lighting, HVAC, speaker, fire safety, and security services

TYPICAL ISOMETRICS

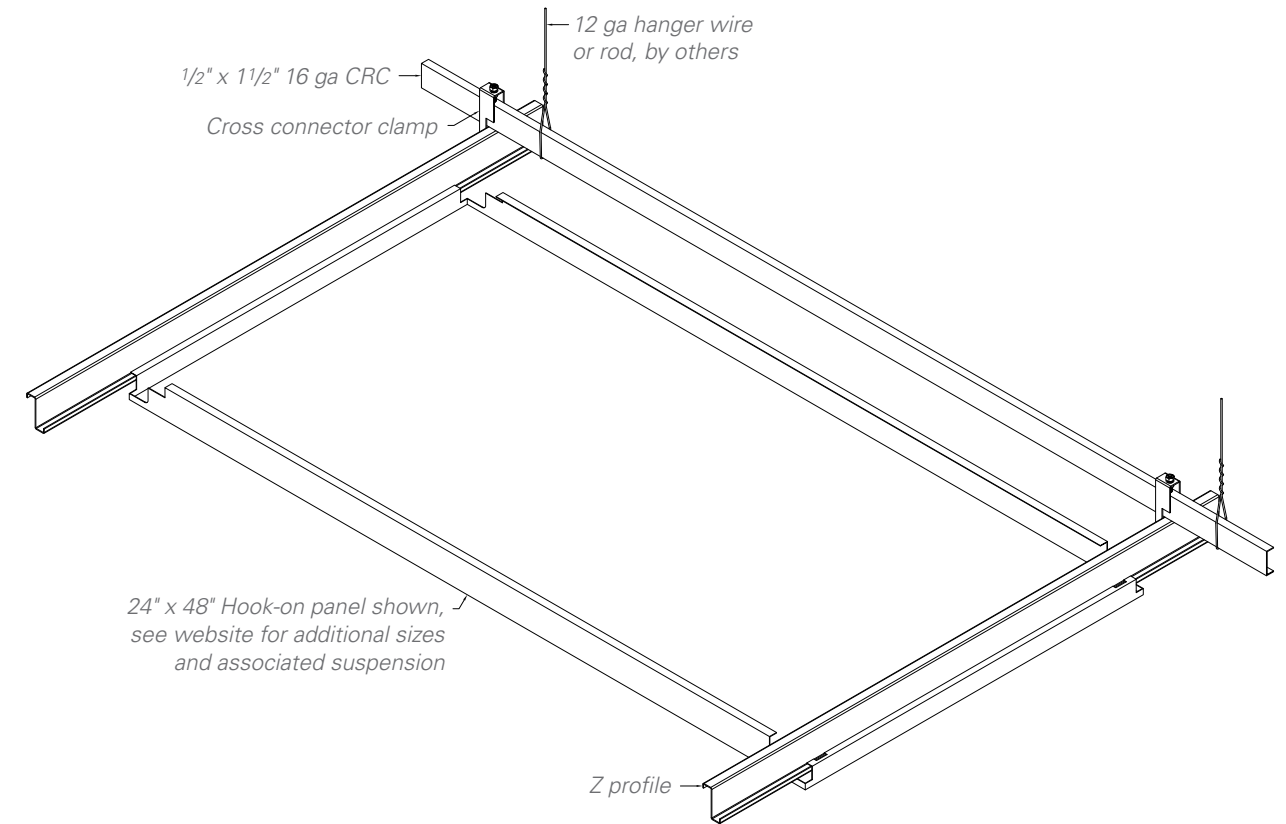

PERFORATION PATTERNS

Standard patterns shown. See Resources section to see all perforation patterns. Scale shown: 1:1, unless otherwise noted.

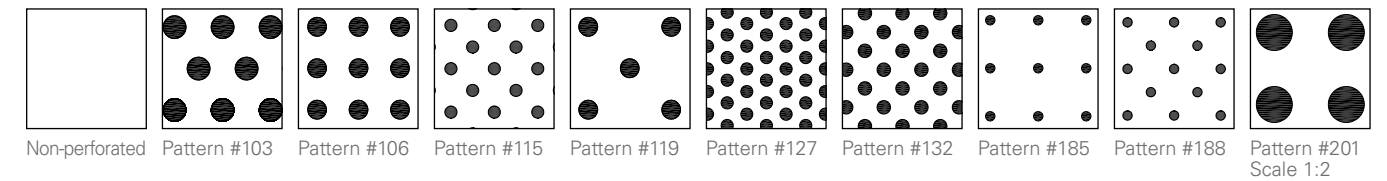

PHYSICAL DATA

Substrate: Aluminum
Warranty: 1 year
Seismic rating: Zones A,B,C,D,E,F
Fire rating: Class A Fire Rated per ASTM E84
 – Painted or anodized metal: Flame spread: ≤ 25, Smoke ≤ 50
Weight: Varies 1.0 – 1.6 lbs./sq.ft.
Wind load: Per code (for exterior applications)
Recycled content: Up to 85%
Light reflectance (LR) Coefficient per ASTM E1264 & ASTM E1477:
 – Varies with finish
 – Cotton White: LR = 0.81
Acoustical ratings – NRC: See Resources section.

BIM

REVIT files available for BIM contributions, see website for details.

LEED V4 CREDITS

EA: Optimize Energy Performance
 MR: Building Product Disclosure
 EQ: Low-Emitting Materials
 EQ: Indoor Air Quality Assessment
 EQ: Daylight
 EQ: Acoustic Performance

CERTIFICATIONS

GREENGUARD Gold Certified
 FSC chain of custody veneers available
 EPDs – available upon request

METAL CEILINGS

PLANK & TILE HOOK-ON

COLORS & FINISHES

A wide choice of colors and finishes are available and some carry a premium price over manufacturer's standard colors. Custom color matching is available upon request. Minimum quantities and lead times may apply. See website for the most up to date information and to order samples. Colors are for illustration purposes only.

STANDARD PAINT COLORS

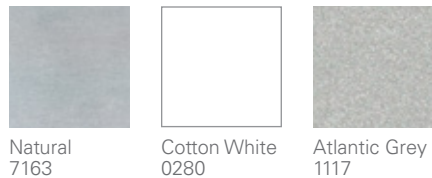

CUSTOM COLORS

Premium custom colors.



Custom

WHITE FINISH OPTIONS

Powder-coat paint finish for Arctic White #1015P (Gloss 10-20); Crystalline White #1050P (Gloss 45-55); Supernova White #1085P (Gloss 80-90)

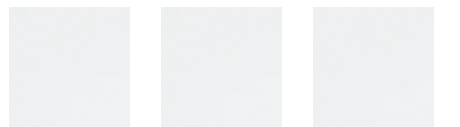

Arctic White 1015P
Crystalline White 1050P
Supernova White 1085P

DAYLIGHTING WHITE PAINT FINISH

Powder-coat paint finish offering LRV 96; non-glare, 3% low gloss finish. Certified by: Applied Technical Services, Inc. Test Report No. D233185. Test reports available by request.

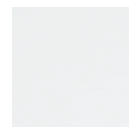

Performance White 9603P

STANDARD METALLIC

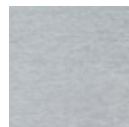

Brushed Aluminum 0004

STAINLESS STEEL OPTIONS

Substrate: stainless steel. Object shows reflectivity of finish.



2B Satin 7772C
#4 Brushed 7774C
#8 Mirror 7778C

BLACK FINISH OPTIONS

Powder-coat paint finish for Starless Black #5000P (Matte); Raven Black #5030P (Gloss 25-35); Sable Black #5060P (Gloss 65-75); Wet Glass Black #5095P (Gloss 90-95)



Starless Black 5000P
Raven Black 5030P
Sable Black 5060P
Wet Glass Black 5095P

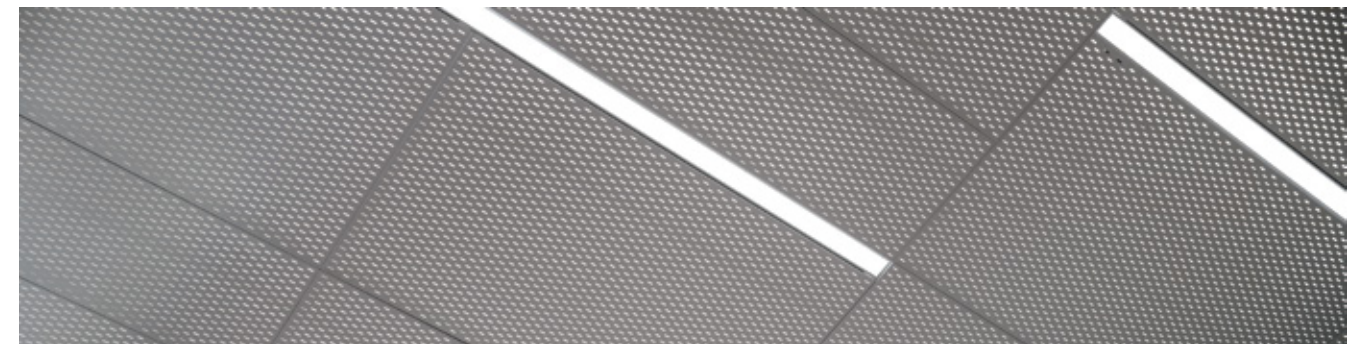

STANDARD WOOD VENEER OPTIONS

Real wood veneer (interior only). Formaldehyde-free, Class A composite panel. Note: This is a small subset of veneers available. Please contact manufacturer for client-specific species and stains.



White Oak (Rift) 9003
Douglas Fir (VG) 9005
Cherry (Flat) 9013
Walnut (Flat) 9114
Anigre (Qtr) 9122
Maple (Flat) 9427

DECORATED WOOD-LOOK OPTIONS

Powder-coat paint finish (interior and exterior). Formaldehyde-free, Class A composite panel. This finish is recommended for exterior conditions.



COIL-COATED WOOD-LOOK OPTIONS

Polyester coil-coated painted finish (interior and exterior). Formaldehyde-free, Class A composite panel. Minimums apply.



Chaucer Maple 8947
Columbia Cherry 8950
Celtic Walnut 8956

LAMINATED (FILM) WOOD FINISHES

Film (interior only). Formaldehyde-free, Class A composite panel. Minimums apply.



American Natural 8000
Russian Maple 8003
Hayward Cherry 8005
Caramel Bamboo 8030
Northern Walnut 8105
Chatham Oak 8107