

Colony

OEM and Custom
Hardware

2019

Over 2800 engineered kits for Harley-Davidson motorcycles from 1911 to present



|| Where Excellence is a Standard ||

MADE IN THE U.S.A.

Thank You for Choosing Colony...where excellence is a standard.

Notice:

Colony is a manufacturer of after market products which are designed to be used on Harley Davidson motorcycles. The word Harley Davidson® and all words used in this catalog denoting model, motorcycle or number are intended for reference purposes only. No parts appearing in this catalog are licensed, sponsored or endorsed by Harley Davidson, Inc.®

Back Orders:

All back ordered items will be shipped to you within 30 days. Those backorders which we are unable to make complete within 30 days will be automatically cancelled unless notified by customer.

Cover photo: 1939 El "Cut-down"

Builder: Tom Faber • Faber Cycle, www.fabercycle.com

Owner: Charles Wesholski • Kick-start M/C Parts, 616-245-8991

(See price list for parkerized and cadmium bolts, nuts, and washers)

INDEX

ACORN NUTS		
Bagged 10 Packs	8	
Bulk	5	
OEM Style	5, 7, 8	
Packaged	7	
Trays	16	
AIR CLEANER MOUNTING KIT... 134, 135		
AIR CLEANER SCREWS		
Acorn	17, 20	
Cap	17, 20	
Custom	23, 27, 134	
S&S	134	
Stock	134	
AIR HORN COVER MOUNT	75	
ALLEN SCREWS		
Button Head 10 Packs	11	
Flat Head 10 Packs	12	
Head Plugs	26	
Show Bike Kits	26	
Standard Knurled Head 10 Packs	10	
Standard Polished Head 10 Packs	9	
Kits	21, 22, 23, 24, 25, etc.	
Trays	15	
AXLE	127	
AXLE COVER, Front and Rear	63	
AXLE NUT KITS		
Acorn	55	
Cap	55	
Stock	55	
AXLE SPACER KITS .. 57, 58, 59, 60, 61, 62		
AXLE SPRING CLIP, Rear	58	
BATTERY		
Box Mounting Kit	71	
Rubber Mounts	71, 115	
Terminal Kit	71	
Wing Nuts	75	
BOLTS		
Hex Head, 10 packs	14	
Trays	15	
BOLTS, PARKERIZED, CADMIUM	See price list	
BOOT GUARD	47	
BRAKE		
Arm Anchor Stud Kit	124, 126	
Banjo Bolts	66	
Cable Adjusting Screw	126	
Cable Bracket	103	
Cable Oiler	126	
Caliper Anti-vibration Kit	122	
Caliper Bleeder Screws	127	
Caliper Mounting Kit	124	
Drum Bolt Kit	128	
Drum Grease		
Fitting Extension, Drain	127, 128	
Front Lower Connection	127	
Lever & Bracket Mounting Kit ...	80, 118	
Lever Pivot Screw	80	
Lever Studs	80	
Master Cylinder Mount Kit	23, 142	
Pivot Bolt Kits	124, 125	
Rear Brake Caliper Anchor		
Arm Bolt Kit	124	
Rear Brake Switch Pull Kit	73	
Rod Mounting Kits	126	
Rotor Screws		
Allen	119	
Stock	119	
Torx	119	
Seal	95	
Shackle Rebuilding Kit	94	
Shaft Nuts/Locks/Bushings/Tool	124	
Shell Dowel Pin Set	128	
Shoe Pivot Stud, Cup	125	
Switch Mount Kit	126	
BRUSH HOLDER ASSEMBLY	70	
CAP NUTS		
Bagged 10 Packs	8	
Bulk	5	
Packaged	7	
CAM COVER SCREWS		
Acorn	19, 20, 40	
Cap	19, 20, 40	
Stock	40	
Stock Phillips	40	
Allen	24, 27, 40	
CARBURETOR		
Fittings	106, 107	
Low Speed Needles	108	
Float Valve and Seat	108	
S&S Carburetor Screw Kit	106	
Screws	106	
Support Brackets	104	
Venturis	105, 109	
CHAIN ADJUSTERS		
Custom	56	
Stock	56	
Swing Arm	56	
CHAIN GUARD MOUNTING KIT... 110, 111		
CHAIN HOUSING COVER CAP	35	
CHAIN OILER	142	
CIRCUIT BREAKER		
Adjuster Plate, Screw Kit	74	
Acorn, Screws	17	
Clamp, Screws	73	
Stock, Screws	74	
Post Rebuild Kit	71	
Wire Assembly	74	
CLUTCH		
Adjusting Hole Cap	35	
Adjusting Nut/Lockwasher	137, 138	
Adjusting Screw Kit	80	
Arm Rebuilding Kit	137	
Backing Plate Stud Spacers	139	
Booster Bracket U-Bolt	139	
Fulcrum Rebuild Kit	137	
Cable Adjusting Sleeve, Bracket..	139, 102	
Gear Nut, Side Nut	139	
Hub Bearing Plate Springs	139, 142	
Lever Bushings	147	
Lever Friction Disc Kit	148	
Lever Rod Bolt	132	
Lever Shaft, Stud	147	
Lever Spring Stud	147	
Pushrod Adjusters	137	
Spring Guide Stud Nuts/Locks	138	
Tools	137	
COIL		
Mounting Kits	77	
Mounting Studs	77, 127	
Nuts	77	
CONTROL COIL ADJUSTERS	126	
CRANK PIN NUT	41	
Lockplates	41	
CRANKCASE BREATHER STUD	44	
CRANKCASE OIL STRAINER	142	
CRANKCASE VENT FITTING/HOSE ...	44	
CRASH BAR MOUNTING KIT	146	
CYLINDER BASE		
Acorn Nuts	17, 20, 32	
Big Bore Nuts	32	
Cap Nuts	17, 20, 32	
Stock Nuts	32	
Studs, Stock and Hi-Performance	32, 68	
Stud Spacers	32, 68	
CYLINDER HEADBOLTS		
Acorn	17, 19	
Allen	23, 27	
Cap	17, 19	
Stock	69	
12 Point	68	
Washers	68	
CYLINDER BRACKET	86	
CYLINDER HEAD STUDS	32, 69	
DASH		
Center Screw	114	
Ignition Switch Mount	114	
Panel Switch Knobs	70	
Plate Hardware	114	
Screw Kit		
Acorn	17, 114	
Allen	23, 114	
Cap	17, 114	
DISC BRAKE ROTOR BOLTS		
Allen	119	
Stock	119	
DRAIN PLUGS	46	
ELECTRICAL		
Battery Terminal Screws	71	
Frame Terminal Screws	71	
Headlight Mounting Kit	71	
Panel Cover Mounting Kit		
Acorn	17	
Allen	23	
Spark Plug Cable Pack Nut	77	
Terminal Box/Plate Assembly	71, 72	

EXHAUST PIPE NIPPLE & NUT.....	35
EXHAUST PORT STUDS.....	133
EXHAUST SYSTEM MOUNTING KITS ..	133
FAIRING MOUNT KIT	23
FENDER	
Brace Clips.....	94
Hinge Pin.....	113
Lamp Wire Kit, Front	72
Mount Kit.....	20, 23, 27, 100, 112, 113
Rail Screws	
Acorn.....	17, 20
Allen.....	23, 27
Cap	17, 20
Stock	112
Strut Mounting Kit, Custom.....	23, 112
FOOTBOARD HINGE BOLT KIT	116
FOOTBOARD MOUNTING KITS.....	116
FOOTBOARD STUD MOUNTING KIT ..	117
FOOTPEG MOUNTING	
HARDWARE.....	27, 118
FORK	
Bolt	89
Bracket Cover Allen Screws.....	23, 27
Caps	89, 95
Drain Screws.....	88
Panel Mount Kit.....	88
Plug.....	89
Screw Kits	88
Slider Bottom Stud & Nut Kit	88
Springer Parts.....	93, 94
Stem Nuts/Bolts	90, 91, 92
Tube Cap Installation Tools	89
Tube Spring Retainer	89
FRAME CLAMP BOLT KIT	130
GAS TANK	
Fittings.....	101
Shut Off Knob, Assembly	101
Shut Off Rod Parts	101
Strainer Assembly	99
Strainer Cap.....	99
Strainer Screen.....	99
Tank Mounting Kit	23, 27, 100
Top of Tank Screw Kit.....	101
GEAR BOX ADJUSTING SCREW.....	83
GEAR BOX GREASE TUBE	127
GENERATOR	
Mounting Hardware.....	72, 73
Pole Screws	72
Positive Terminal Screw Kit.....	72
Screws	
Acorn.....	17, 20, 40
Allen.....	23, 27, 40
Cap	17, 20, 40
Stock	40
Stock Phillips	40
GREASE FITTINGS.....	122
Grease Fitting Adaptor.....	122
HANDLEBAR	
Bolt Kit.....	78, 79
End Nuts.....	79

Grip Retainer	79
Mounting Kits	
Acorn.....	17, 20
Allen.....	23, 27
Cap	17, 20
Stock	78
Plungers, Plugs.....	79
Riser Bolts, Bushings.....	78
Riser Washers, Covers.....	78
HEADBOLTS	
Acorn	17, 19
Allen.....	23, 27
Cap	17, 19
Stock	68, 69
12 Point	68
HEADBOLT	
Covers	
Acorn.....	17, 20, 64
Cap	17, 20, 64
Custom.....	61, 64
Washers.....	68
HEADLIGHT HOUSING MOUNT	76
HEADLIGHT RESTORATION AND MOUNTING KIT	71, 74, 76
HEADLIGHT VISOR MOUNTING KIT	
Acorn	17, 20
Allen.....	23, 27
Cap	17, 19
Stock	74
HEX NUTS	
Bulk.....	6
Bagged 10 Packs	8
Parkerized, Cadmium.....	See price list
Trays	16
HOUSING TO FRAME CLAMP BOLT KIT	130
HORN SCREW KIT	74
HORN TERMINAL BOARD KIT.....	75
HUB BEARING CONE SEAL RETAINER AND LOCKNUT KIT, Front	129
IGNITION MODULE SIDE COVER MOUNT KIT	142
IGNITION SWITCH CONTACT ROLLER ..	75
IGNITION SWITCH MOUNT.....	114
IGNITION TIMER COVER STUDS	74
INSTRUMENT PANEL RESTORATION KITS.....	70
INTAKE MANIFOLD MOUNT KIT ..	23, 27, 95
JIFFY STAND/FOOT CLUTCH LEVER MOUNTING KIT	115
KICK STARTER MOUNT KITS ...	140, 141
KICK STARTER NUTS, BUSHINGS, SEALS.....	140, 141
KICK STARTER PEDAL PARTS	141
KICKER STARTER TRIPPER BOLT & NUT KIT, TOOL	130
KICKER SPRING STUD.....	130
KICKSTAND MOUNTING KIT	115

KNUCKLENUTS	17, 36
LEGSIELD MOUNTING KIT	82
LICENSE PLATE Mounting Kit	
Acorn/Cap.....	65
Allen/Custom	65
LIFTER BASE SCREWS	
Acorn	17, 20, 39
Allen.....	23, 27
Cap	17, 19, 20, 39
Stock	39
Stock Phillips	39
12 Point	39
LIGHT SWITCH CONTACT.....	74
LOCKNUTS	
Nylon Insert Locknuts	
Bulk.....	6
Bagged-10 Packs.....	8
Trays	16
Pushrod Tappet Adjuster	53
Transmission Mainshaft	42
LUGGAGE CARRIER MOUNT	126
MACHINE GUN AND AMMUNITION BRACKET MOUNTING KIT	118
MAGNETO ADAPTER PLATE SCREW KIT.....	77
MANIFOLD	
Conversion Kit	33
Intake.....	33
Mounting Screws.....	23, 27
Nipples, Tool	33, 34
Nuts	33
Seals	33
METRIC FASTENERS.....	13
MOTOR	
Case Drain Plug.....	44
Case Kits	
Acorn.....	16, 17, 43
Allen.....	23, 27, 43
Stock	43
Case Nuts-Slotted.....	44
Mount Bolt Covers	64
Mount Kits	
Acorn.....	17, 20
Allen.....	23, 27
Stock	84
Mount Spacers	86
OIL	
Hose Cover Mounting Kit	
Acorn.....	17
Allen.....	23
Line Fittings	96, 98
Filter Screws	
Acorn.....	17, 21
Allen.....	23, 27
Nipple Cap	96
Pump Mounting Hardware	
Acorn.....	17, 18, 21
Allen.....	23, 27, 31
Cap	17, 18, 21, 31
Stock	31
Pump Nut	31
Pump Plugs-Custom & Stock	29, 30
Pump Tappet Oil Screen.....	29

Tank			
Brackets.....	97	Acorn.....	18, 21, 37
Dipstick.....	98	Allen.....	24, 28, 37
Fittings.....	87, 96	Cap.....	18, 21, 37
Hose Clamps.....	105	Custom.....	38
Mounting Hardware.....	96, 97	Lower.....	38
Plug.....	45, 46	Stock.....	36, 37
Rubber Mounts.....	130	Box Drain Tube Fitting.....	96, 97
PIKE NUTS		Box Studs.....	37, 38
Bulk.....	5	Feed Line Nipple.....	96
Custom Pike Nuts.....	29, 32	Rebuilding Kits.....	93, 95
Packaged.....	7	Shaft End Plugs	
Bagged-10 Packs.....	8	Allen.....	37
Tray.....	16	Custom.....	18, 21, 37
PINCH BOLTS		Stock.....	36, 37
Allen.....	23	Shaft Nut & Washer Kit	
Stock.....	79	Acorn.....	18, 21, 36
PINION GEAR SHAFT NUTS.....	41	Cap.....	18, 21, 36
Gear Nut Wrench.....	42	Shaft Seals, Washers.....	37
PLUGS		Thrust Washers.....	35
Allen Screw Heads.....	26	RUBBER MOUNTS.....	130
POINT COVER SCREWS		SADDLE BAG MOUNTING KIT.....	47
Acorn.....	18, 21	SADDLE BAG GUARD, SUPPORT	
Allen.....	24, 27	MOUNT.....	123
Cap.....	18, 21	SAFETY GUARD U-BOLTS.....	146
PRIMARY		SEALS	
Cap Installation Tool.....	136	Manifold.....	33
Cover Cap.....	136	Pushrod Cover Seal Kit.....	49
Cover Screw Kits		Sprocket Shaft.....	87
Acorn.....	18, 21, 39	SEAT	
Allen.....	24, 28, 39	Bracket Mounting Kit.....	143
Cap.....	18, 21, 39	Clevis Pin & Spring.....	143
Stock.....	39	Mount Kit.....	143, 144, 145
Mount Kit.....	110, 111	Post Bushing & Installation Tool.....	143
PUSHROD COVERS.....	48, 49, 50	Post Rod, Locknuts.....	143, 144
PUSHRODS.....	53	Springs, Custom and Stock....	144, 145
Hydraulic Lifter Converters.....	53	Tee Bushing.....	143
Installation Tool.....	54	Tee Pivot Bolt.....	143
Locknuts.....	53	SHIFT GATE	
Pushrod Cover Adaptor & Conversion		Clamp Nuts.....	122
Kits, Sportster.....	50	Screws.....	134
REAR AXLE ADJUSTERS.....	56	SHIFTER	
RIDE CONTROL SIDE PLATE		Assembly Cover Screw Kit.....	85
STUD KIT.....	131	Cam Plunger Kit.....	83, 85
RISER BOLTS.....	78	Cam Shaft Lock Screw.....	85
ROCKER		Foot Lever Bushing.....	132
Arm Cover Nut Strip, Gaskets.....	35	Guide Screws.....	134
Arm Cover Screws.....	18, 21, 35	Lever Stud.....	132
Arm Cover Washers.....	35	Rod End Bolt, Pin.....	132
Arm Nuts.....	37, 38	SHOCK MOUNTING BOLT KITS.....	131
Arm Studs.....	37, 38	SHOW BIKE KITS	
ROCKER		Acorn.....	22
Box Nut Kit		Allen.....	26
Acorn.....	18, 37	Cap.....	22
Cap.....	18, 37	SIDE BAR MOUNT KIT.....	118
Stock.....	37	SIDECAR PARTS.....	150, 151
Box Screw Kit		SKIDPLATE MOUNTING KIT.....	82
12 Point.....	38	SPACERS, GENERAL USE.....	25
		SPACERS, OEM STYLE.....	149
		SPARK PLUG CABLE BRACKET.....	103
		SPEEDOMETER	
		Cable Clamps.....	102
		Drive Block-off Plug.....	130
		Mounting Kit.....	127
		Sensor Mount	
		Acorn.....	17
		Allen.....	21
		SPOKE NIPPLE WRENCH.....	142
		SPOTLIGHT REBUILD MOUNT KIT.....	76
		SPRINGER PARTS.....	93, 94, 95
		SPROCKET	
		Cover Screws	
		Acorn.....	21, 40
		Allen.....	28, 40
		Cap.....	21, 40
		Stock.....	40, 44
		Shaft Nuts, Lock Plates.....	41
		Nuts	
		Acorn.....	42
		Stock.....	41, 42
		Rear Wheel Hardware	
		Acorn.....	121
		Allen.....	120, 121
		Cap.....	121
		12 Point.....	121
		Shaft Seals.....	87
		Installation Tool.....	87
		STAND, CENTER MOUNT.....	123
		STAND, FRONT MOUNT.....	123
		STAND, REAR MOUNT.....	123
		STAR HUB COVER SCREWS	
		Acorn.....	18
		Cap.....	18
		Stock.....	129
		STEERING DAMPER KIT.....	91
		STEM	
		Bolt.....	90
		Nuts, Dust Shield.....	90, 91
		STOCK HARDWARE KITS.....	67
		STRAPS, CABLE, TUBE, HOSE.....	125
		STUD INSTALLATION TOOLS.....	67
		SUPPORT ROD MOUNT KIT.....	118
		SWING ARM	
		End Cover and Nut/Screw Kit.....	56
		Pivot Bolt Covers.....	64
		Bolts.....	64
		SWITCH BOX MOUNT KIT.....	76
		SWITCH HOUSING SCREWS	
		Acorn.....	19, 21
		Allen.....	21, 24
		SWITCH KNOBS.....	70
		TACHOMETER DRIVE	
		BLOCK OFF PLUG.....	130
		TAIL LAMP MOUNTING KIT.....	72, 73

TAPPET SCREW, NUTS53	Side Cover Kit	WASHERS
THROTTLE	Acorn..... 18, 81	Countersunk Custom.....12
Cable Clamps103	Allen.....24	Cylinder Base Lockwashers.....32
Control Coil Sleeves.....79	Cap18, 81	Flatwashers–Packaged.....6
Roller and Pins79	Stock 81, 82	Headbolt Washers.....68
THROWOUT BEARING ASSEMBLY ..137	Top Cover Kit	Lockwashers–Packaged.....6
TIMING	Acorn.....18	Parkerized, Cadmium..... <i>See price list</i>
Cover Oil Passage Bolt.....130	Allen.....22	Trays16
Cover Screws	Cap18	WHEEL
Acorn..... 19, 40	Stock 81, 82	Adjuster Hardware.....56
Allen..... 24, 27, 40	Stock Phillips.....82	Bearing Seal Kit.....129
Cap 19, 40	VALVE	Hub Bearing Cone Seal Retainer.....129
Stock40	Covers, Seals, Wrench.....51, 52	Hub Screws
Stock Phillips40	Cover Nut Strips35	Acorn19
Plugs.....45	Cover Screws	Cap19
TOOL BOX MOUNTING KIT114	Acorn.....18	Stock129
TOP OF TANK SCREW KIT.....101	Allen.....24	Lug Bolts, Wrench.....128
TOWBAR ROCKER STUDS.....95	Cap18	Tool, Puller.....142
TRANSMISSION	Oversized81	STABILIZER COLLAR STUDS35
Adjusting Screw, Plate83	Stock81	WHEEL-BEARING LOCKNUT, TOOL...129
Case Bottom Studs.....83	Retainers54	WINDSHIELD TRIM, MOUNT
CAM Follower, Retainer83	Stem Caps for Tires65	SCREW KIT130
Drain Plugs..... 44, 46	Washers.....81	WING NUTS75
Fill Plugs.....47	VENTURI, CARBURETOR.....109	WIRE CLIPS102
Grease Tube.....127	VENTURI REMOVAL TOOL.....107	
Kicker Cover Studs81	VOLTAGE REGULATOR MOUNT KIT	
Mainshaft Locknut.....42	Acorn19	
Mainshaft Nut Lock Plate42	Allen24	
Mounting Kit	Stock 21, 72	
Acorn.....19	VRSCA HARDWARE.....152	
Allen.....24		
Stock83		
Relief Pipe Nut.....85		

These restoration guide books are a must for that perfect restoration. Very detailed with lots of photos so you will have no excuse not to have that 100 point restoration. Many thanks to Bruce Palmer, Johnny Sells, and Steve Slocombe for publishing these books and to guiding us in this enjoyable hobby.



Steve Slocombe
BOOK 001
1930–1936 VL



Johnny Sells
BOOK 002
1929–1936 45"

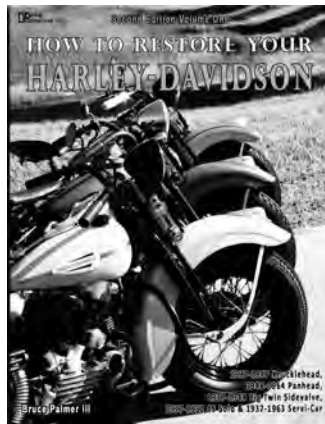

Bruce Palmer III
BOOK 003
1937–1965 Big Twins, 45"

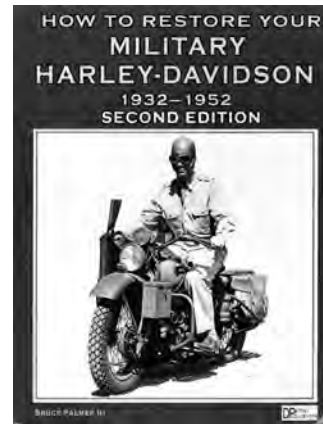

Bruce Palmer III
BOOK 004
1932–1952 Military

Acorn Nuts, Cap Nuts, Pike Nuts

Colony Style Acorn



OEM Style Acorn



Pike Nut



Chrome Plated - Bulk Acorn · Cap · Pike Nuts

COLONY STYLE ACORN			
Hex Size	Thread Series		
	SAE	UNC	Metric
3/8	8-32		
3/8	10-32	10-24	
3/8		12-24	
7/16	1/4-28	1/4-20	6MM (1.0)
7/16	1/4-24	H.D. Thrd.	
1/2	5/16-24	5/16-18	8MM (1.25)
9/16	3/8-24	3/8-16	10MM (1.25)
11/16	7/16-20	7/16-14	
3/4	1/2-20	1/2-13	12MM (1.25)
7/8	9/16-18	9/16-12	14MM (1.50)
15/16	5/8-18	5/8-11	
1-1/8	3/4-16		
1-1/4	5/8-18	5/8-11	

OEM STYLE ACORN			
Hex Size	Thread Series		
	SAE	UNC	Metric
3/8	8-32		
3/8	10-32	10-24	
3/8		12-24	
7/16	1/4-28	1/4-20	6MM (1.0)
1/2	5/16-24	5/16-18	8MM (1.25)
9/16	3/8-24	3/8-16	10MM (1.25)
11/16	7/16-20	7/16-14	
3/4	1/2-20	1/2-13	12MM (1.25)

PIKE			
Hex Size	Thread Series		
	SAE	UNC	Metric
3/8	10-32	10-24	
3/8	8-32	10-24	
7/16	1/4-28	1/4-20	6MM (1.0)
7/16	1/4-24	H.D. Thrd.	
1/2	5/16-24	5/16-18	8MM (1.25)
9/16	3/8-24	3/8-16	10MM (1.25)
3/4	7/16-20	7/16-14	
7/8	1/2-20	1/2-13	12MM (1.25)
7/8	9/16-18	9/16-12	14MM (1.50)
1.0	5/8-18	5/8-11	
1-1/4	5/8-18	5/8-11	

Cap Nut



Custom Acorn Nut

Flanged acorn nut for various custom applications.
3/4 OD with 9/16 milled hex

Thread Size	Stock No.
5/16-18	MHA-001
3/8-16	MHA-002
5/16-24	MHA-005
3/8-24	MHA-003
7/16-20	MHA-004

CAP			
Hex Size	Thread Series		
	SAE	UNC	Metric
3/8	8-32		
3/8	10-32	10-24	
7/16	1/4-28	1/4-20	6MM (1.0)
7/16	1/4-24	H.D. Thrd.	
1/2	5/16-24	5/16-18	8MM (1.25)
9/16	3/8-24	3/8-16	10MM (1.25)
11/16	7/16-20	7/16-14	
3/4	1/2-20	1/2-13	12MM (1.25)
7/8	9/16-18	9/16-12	14MM (1.50)



Custom Pike Nut

Flanged pike nut for various custom applications.
3/4 OD with 9/16 milled hex

Thread Size	Stock No.
5/16-18	MHP-002
3/8-16	MHP-003
5/16-24	MHP-011
3/8-24	MHP-012
7/16-20	MHP-013

Washers, Nylon Insert Locknuts, Hex Nuts

Chrome Plated - Flatwashers

Stock No.	Description	Quantity
9633-50	1/4" (1/4 x 7/16 x 1/16) OEM 6099	50 per card
8166-12	1/4" (1/4 x 9/16 x 3/64)	12 per card
2115-12	1/4" (1/4 x 39/64 x 3/32)	12 per card
2110-12	5/16" (5/16 x 9/16 x 1/16)	12 per card
8167-12	5/16" (5/16 x 5/8 x 1/16)	12 per card
2113-12	5/16" (5/16 x 11/16 x 1/16)	12 per card
2633-6	3/8" (3/8 x 11/16 x 1/16)	6 per card
8168-6	3/8" (3/8 x 3/4 x 3/32)	6 per card
2111-6	3/8" (3/8 x 13/16 x 1/16)	6 per card
2114-6	3/8" (3/8 x 7/8 x 1/8)	6 per card

Stock No.	Description	Quantity
8169-6	7/16" (7/16 x 3/4 x 3/32)	6 per card
2112-6	7/16" (7/16 x 15/16 x 1/8)	6 per card
9972-5	1/2" (1/2 x 1-1/16 x 3/32)	5 per card
8-F-100	#8 (.175 x 3/8 x 3/64)	bag of 100
10-F-100	#10 (.195 x 7/16 x 3/64)	bag of 100
12-F-100	#12 (.215 x 1/2 x 3/64)	bag of 100
1/4-F-100	1/4" (1/4 x 9/16 x 1/16)	bag of 100
5/16-F-100	5/16" (5/16 x 5/8 x 1/16)	bag of 100
3/8-F-100	3/8" (3/8 x 3/4 x 3/32)	bag of 100
7/16-F-100	7/16" (7/16 x 3/4 x 3/32)	bag of 100

Chrome Plated Lockwashers

Stock No.	Description	Quantity
9516-12	1/4"	12 per card
9517-12	5/16"	12 per card
9518-6	3/8"	6 per card
9519-6	7/16"	6 per card
9971-5	1/2"	5 per card
8-L-100	#8	bag of 100
10-L-100	#10	bag of 100
12-L-100	#12	bag of 100
1/4-L-100	1/4"	bag of 100
5/16-L-100	5/16"	bag of 100
3/8-L-100	3/8"	bag of 100
7/16-L-100	7/16"	bag of 100

Zinc Plated - Flatwashers

Stock No.	Description	Quantity
3284-50	1/4" (1/4x7/16x1/16) OEM 6099	50 per card

Chrome Plated Nylon Insert



Hex Size	Thread Series		
	SAE	UNC	Metric
5/16	8-32		4MM (.70)
3/8	10-32	10-24	5MM (.80)
7/16	1/4-28	1/4-20	6MM (1.0)
1/2	5/16-24	5/16-18	8MM (1.25)
9/16	3/8-24	3/8-16	10MM (1.25)
11/16	7/16-20	7/16-14	12MM (1.25)
3/4	1/2-20	1/2-13	
15/16	5/8-18	5/8-11	



Chrome Plated Nylon Insert Locknuts Thin

Hex Size	SAE	UNC
7/16	1/4-28	1/4-20
1/2	5/16-24	5/16-18
9/16	3/8-24	3/8-16
11/16	7/16-20	7/10-14
3/4	1/2-20	1/2-13

Chrome Plated Hex Nuts



Hex Size	Thread Series		
	SAE	UNC	Metric
5/16	8-32		
3/8	10-32	10-24	
7/16		12-24	
7/16	1/4-28	1/4-20	6mm (1.0)
1/2	5/16-24	5/16-18	8mm (1.25)
9/16	3/8-24	3/8-16	10mm (1.25)
11/16	7/16-20	7/16-14	
3/4	1/2-20	1/2-13	
15/16	5/8-18		



Chrome Plated Hex Nuts Thin

Hex Size	SAE	UNC
7/16	1/4-28	1/4-20
1/2	5/16-24	5/16-18
9/16	3/8-24	3/8-16
11/16	7/16-20	7/16-14
3/4	1/2-20	1/2-13

Chrome Plated Acorn Nuts, Cap Nuts, Pike Nuts, Washers

Colony Style Acorn



Cap Nut



Pike Nut



Chrome Plated - Skin Packaged Acorn • Cap • Pike Nuts

ACORN		
Thread Size	Stock No.	Quan/Pkg.
1/4-24 H.D.	6930-5	5
10-32 SAE	6931-5	5
1/4-28 SAE	6932-5	5
5/16-24 SAE	6933-4	4
3/8-24 SAE	6934-3	3
7/16-20 SAE	6935-2	2
1/2-20 SAE	6936-1	1
9/16-18 SAE	6937-1	1
5/8-18 SAE 15/16"	6938-1	1
3/4-16 SAE 1-1/8"	6939-1	1
5/8-18 SAE 1-1/4"	6940-1	1
10-24 UNC	6941-5	5
1/4-20 UNC	6942-5	5
5/16-18 UNC	6943-4	4
3/8-16UNC	6944-3	3
7/16-14 UNC	6945-2	2
1/2-13 UNC	6946-1	1
9/16-12 UNC	6947-1	1
5/8-11 UNC 15/16"	6948-1	1
5/8-11 UNC 1-1/4"	6949-1	1
6MM Metric (1.0)	6950-5	5
8MM Metric (1.25)	6951-4	4
10MM Metric (1.25)	6952-3	3
12MM Metric (1.25)	6953-1	1
14MM Metric (1.50)	6954-1	1

CAP		
Thread Size	Stock No.	Quan/Pkg.
1/4-24 H.D.	8414-5	5
10-32 SAE	8415-5	5
1/4-28 SAE	8416-5	5
5/16-24 SAE	8417-4	4
3/8-24 SAE	8418-3	3
7/16-20 SAE	8419-2	2
1/2-20 SAE	8420-1	1
9/16-18 SAE	8421-1	1
5/8-18 SAE 15/16"	8422-1	1
10-24 UNC	8423-5	5
1/4-20 UNC	8424-5	5
5/16-18 UNC	8425-4	4
3/8-16 UNC	8426-3	3
7/16-14 UNC	8427-2	2
1/2-13 UNC	8428-1	1
9/16-12 UNC	8429-1	1
5/8-11 UNC 15/16"	8430-1	1
6MM Metric (1.0)	8431-5	5
8MM Metric (1.25)	8432-4	4
10MM Metric (1.25)	8433-3	3
12MM Metric (1.25)	8434-1	1
14MM Metric (1.50)	8435-1	1

PIKE		
Thread Size	Stock No.	Quan/Pkg.
1/4-24 H.D.	6900-5	5
10-32 SAE	6901-5	5
1/4-28 SAE	6902-5	5
5/16-24 SAE	6903-4	4
3/8-24 SAE	6904-3	3
7/16-20 SAE	6905-2	2
1/2-20 SAE	6906-1	1
9/16-18 SAE	6907-1	1
5/8-18 SAE 1"	6908-1	1
5/8-18 SAE 1-1/4"	6909-1	1
10-24 UNC	6910-5	5
1/4-20 UNC	6911-5	5
5/16-18 UNC	6912-4	4
3/8-16 UNC	6913-3	3
7/16-14 UNC	6914-2	2
1/2-13 UNC	6915-1	1
9/16-12 UNC	6916-1	1
5/8-11 UNC 1"	6917-1	1
5/8-11 UNC 1-1/4"	6918-1	1
6MM Metric (1.0)	6919-5	5
8MM Metric (1.25)	6920-4	4
10MM Metric (1.25)	6921-3	3
12MM Metric (1.25)	6922-1	1
14MM Metric (1.50)	6923-1	1

OEM Style Acorn



ACORN		
Thread Size	Stock No.	Quan/Pkg.
10-32 SAE	2829-5	5
1/4-28 SAE	2830-5	5
5/16-24 SAE	2831-4	4
3/8-24 SAE	2832-3	3
7/16-20 SAE	2833-2	2
1/2-20 SAE	2834-1	1
10-24 UNC	2835-5	5
1/4-20 UNC	2836-5	5
5/16-18 UNC	2837-4	4
3/8-16UNC	2838-3	3
7/16-14 UNC	2839-2	2
1/2-13 UNC	2840-1	1

ACORN		
Thread Size	Stock No.	Quan/Pkg.
6MM Metric (1.0)	2841-5	5
8MM Metric (1.25)	2842-4	4
10MM Metric (1.25)	2843-3	3
12MM Metric (1.25)	2844-1	1
14MM Metric (1.50)	2845-1	1

Chrome Plated Acorn Nuts, Cap Nuts, Pike Nuts, Hex Nuts, Nylon Insert Locknuts

• 10 Packs •



ACORN NUTS—COLONY STYLE	
Thread Size	Stock No.
10-32	AN-100
12-24	AN-101
1/4-28	AN-102
1/4-24	AN-103
5/16-24	AN-104
3/8-24	AN-105
7/16-20	AN-106
1/2-20	AN-107
8-32	AN-125
10-24	AN-112
1/4-20	AN-113
5/16-18	AN-114
3/8-16	AN-115
7/16-14	AN-116
1/2-13	AN-117
6 MM (1.00)	AN-121
8 MM (1.25)	AN-122
10 MM (1.25)	AN-123
12 MM (1.25)	AN-124
14 MM (1.50)	AN-126



ACORN NUTS—OEM STYLE	
Thread Size	Stock No.
10-32	PAN-172
1/4-28	PAN-152
5/16-24	PAN-153
3/8-24	PAN-154
7/16-20	PAN-155
1/2-20	PAN-156
10-24	PAN-173
1/4-20	PAN-159
5/16-18	PAN-160
3/8-16	PAN-161
7/16-14	PAN-162
1/2-13	PAN-163
6 MM (1.00)	PAN-168
8 MM (1.25)	PAN-169
10 MM (1.25)	PAN-170
12 MM (1.25)	PAN-171



PIKE NUTS	
Thread Size	Stock No.
8-32	PN-324
10-32	PN-300
1/4-28	PN-301
1/4-24	PN-302
5/16-24	PN-303
3/8-24	PN-304
7/16-20	PN-305
1/2-20	PN-306
10-24	PN-310
1/4-20	PN-311
5/16-18	PN-312
3/8-16	PN-313
7/16-14	PN-314
1/2-13	PN-315
6 MM (1.0)	PN-319
8 MM (1.25)	PN-320
10 MM (1.25)	PN-321
12 MM (1.25)	PN-322
14 MM (1.50)	PN-323



HEX NUTS	
Thread Size	Stock No.
10-32	HN-415
1/4-28	HN-400
5/16-24	HN-401
3/8-24	HN-402
7/16-20	HN-403
1/2-20	HN-404
5/8-18	HN-417
8-32	HN-413
10-24	HN-414
1/4-20	HN-406
5/16-18	HN-407
3/8-16	HN-408
7/16-14	HN-409
1/2-13	HN-416
6 MM (1.0)	HN-410
8 MM (1.25)	HN-411
10 MM (1.25)	HN-412



CAP NUTS	
Thread Size	Stock No.
10-32	CN-200
1/4-28	CN-201
1/4-24	CN-202
5/16-24	CN-203
3/8-24	CN-204
7/16-20	CN-205
1/2-20	CN-206
8-32	CN-222
10-24	CN-209
1/4-20	CN-210
5/16-18	CN-211
3/8-16	CN-212
7/16-14	CN-213
1/2-13	CN-214
6 MM (1.0)	CN-217
8 MM (1.25)	CN-218
10 MM (1.25)	CN-219
12 MM (1.25)	CN-220
14 MM (1.50)	CN-221



NYLON INSERT LOCKNUTS	
Thread Size	Stock No.
10-32	NL-500
1/4-28	NL-501
5/16-24	NL-502
3/8-24	NL-503
7/16-20	NL-504
1/2-20	NL-505
5/8-18	NL-513
10-24	NL-507
1/4-20	NL-508
5/16-18	NL-509
3/8-16	NL-510
7/16-14	NL-511
1/2-13	NL-512
4 MM (.70)	NL-514
5 MM (.80)	NL-515
6 MM (1.0)	NL-516
8 MM (1.25)	NL-517
10 MM (1.50)	NL-518
12 MM (1.75)	NL-519

Chrome Plated Allen Screws - Polished

• 10 Packs •



Fine Thread

Fine Thread	Stock Number
10-32 x 1/2	PSHC-200
10-32 x 5/8	PSHC-201
10-32 x 3/4	PSHC-202
10-32 x 1	PSHC-203
1/4-24 x 7/8	PSHC-204
1/4-24 x 1-7/16	PSHC-205
1/4-24 x 1-5/8	PSHC-206
1/4-24 x 2-1/4	PSHC-207
1/4-24 x 2-3/4	PSHC-208
1/4-28 x 5/8	PSHC-209
1/4-28 x 3/4	PSHC-210
1/4-28 x 7/8	PSHC-211
1/4-28 x 1	PSHC-212
1/4-28 x 1-1/4	PSHC-213
1/4-28 x 1-1/2	PSHC-214
1/4-28 x 1-3/4	PSHC-215
1/4-28 x 2	PSHC-216
1/4-28 x 2-1/4	PSHC-217
5/16-24 x 5/8	PSHC-218
5/16-24 x 3/4	PSHC-219
5/16-24 x 7/8	PSHC-220
5/16-24 x 1	PSHC-221
5/16-24 x 1-1/4	PSHC-222
5/16-24 x 1-1/2	PSHC-223
5/16-24 x 1-3/4	PSHC-224
5/16-24 x 2	PSHC-225
5/16-24 x 2-1/4	PSHC-226
5/16-24 x 2-1/2	PSHC-227
5/16-24 x 2-3/4	PSHC-228
5/16-24 x 3	PSHC-229
5/16-24 x 3-1/4	PSHC-230
3/8-24 x 3/4	PSHC-231
3/8-24 x 1	PSHC-232
3/8-24 x 1-1/4	PSHC-233
3/8-24 x 1-1/2	PSHC-234
3/8-24 x 1-3/4	PSHC-235
3/8-24 x 2	PSHC-236
3/8-24 x 2-1/4	PSHC-237
3/8-24 x 2-1/2	PSHC-238

Fine Thread

Fine Thread	Stock Number
3/8-24 x 2-3/4	PSHC-239
3/8-24 x 3	PSHC-240
3/8-24 x 3-1/4	PSHC-247
3/8-24 x 3-1/2	PSHC-248
7/16-20 x 1	PSHC-2008
7/16-20 x 1-1/4	PSHC-242
7/16-20 x 1-1/2	PSHC-243
7/16-20 x 2	PSHC-2009
7/16-20 x 2-1/2	PSHC-244
7/16-20 x 3	PSHC-245
7/16-20 x 3-1/2	PSHC-246
1/2-20 x 1-3/4	PSHC-2026
1/2-20 x 2	PSHC-2011
1/2-20 x 2-1/4	PSHC-2012
1/2-20 x 2-1/2	PSHC-2013
1/2-20 x 2-3/4	PSHC-2014
1/2-20 x 3	PSHC-2015
1/2-20 x 3-1/2	PSHC-2017

Coarse Thread

Coarse Thread	Stock Number
10-24 x 1/2	PSHC-250
10-24 x 5/8	PSHC-251
10-24 x 3/4	PSHC-252
10-24 x 1	PSHC-2021
10-24 x 1-1/4	PSHC-253
10-24 x 1-3/4	PSHC-254
1/4-20 x 3/8	PSHC-255
1/4-20 x 1/2	PSHC-256
1/4-20 x 5/8	PSHC-257
1/4-20 x 3/4	PSHC-258
1/4-20 x 7/8	PSHC-259
1/4-20 x 1	PSHC-260
1/4-20 x 1-1/8	PSHC-261
1/4-20 x 1-1/4	PSHC-262
1/4-20 x 1-3/8	PSHC-2010
1/4-20 x 1-1/2	PSHC-263
1/4-20 x 1-3/4	PSHC-264
1/4-20 x 2	PSHC-265
1/4-20 x 2-1/4	PSHC-266
1/4-20 x 2-1/2	PSHC-267
1/4-20 x 2-3/4	PSHC-268
1/4-20 x 3	PSHC-2024
1/4-20 x 3-1/2	PSHC-2025
1/4-20 x 4	PSHC-2027
1/4-20 x 4-3/4	PSHC-2023

Coarse Thread

Coarse Thread	Stock Number
5/16-18 x 1/2	PSHC-270
5/16-18 x 5/8	PSHC-271
5/16-18 x 3/4	PSHC-272
5/16-18 x 7/8	PSHC-273
5/16-18 x 1	PSHC-274
5/16-18 x 1-1/4	PSHC-275
5/16-18 x 1-1/2	PSHC-276
5/16-18 x 1-3/4	PSHC-277
5/16-18 x 2	PSHC-278
5/16-18 x 2-1/4	PSHC-279
5/16-18 x 2-1/2	PSHC-280
5/16-18 x 2-3/4	PSHC-281
5/16-18 x 3	PSHC-282
5/16-18 x 3-1/4	PSHC-283
5/16-18 x 3-1/2	PSHC-284
5/16-18 x 4	PSHC-2028
5/16-18 x 4-1/4	PSHC-2029
5/16-18 x 4-1/2	PSHC-2030
3/8-16 x 1/2	PSHC-2001
3/8-16 x 3/4	PSHC-285
3/8-16 x 7/8	PSHC-2002
3/8-16 x 1	PSHC-286
3/8-16 x 1-1/8	PSHC-287
3/8-16 x 1-1/4	PSHC-288
3/8-16 x 1-1/2	PSHC-289
3/8-16 x 1-3/4	PSHC-290
3/8-16 x 2	PSHC-291
3/8-16 x 2-1/4	PSHC-292
3/8-16 x 2-1/2	PSHC-293
3/8-16 x 2-3/4	PSHC-294
3/8-16 x 3	PSHC-295
3/8-16 x 3-1/4	PSHC-296
3/8-16 x 3-1/2	PSHC-297
7/16-14 x 1	PSHC-2003
7/16-14 x 1-1/4	PSHC-2022
7/16-14 x 1-1/2	PSHC-299
7/16-14 x 1-3/4	PSHC-2016
7/16-14 x 2	PSHC-2004
7/16-14 x 2-1/4	PSHC-2031
7/16-14 x 2-1/2	PSHC-2005
7/16-14 x 3	PSHC-2006
7/16-14 x 3-1/2	PSHC-2007
1/2-13 x 1-3/4	PSHC-2018
1/2-13 x 2	PSHC-2019
1/2-13 x 2-1/4	PSHC-2020

Chrome Plated Allen Screws - Knurled

• 10 Packs •



Coarse Thread

Coarse Thread	Stock Number
5/16-18 x 1/2	SHC-965
5/16-18 x 5/8	SHC-966
5/16-18 x 3/4	SHC-967
5/16-18 x 7/8	SHC-968
5/16-18 x 1	SHC-969
5/16-18 x 1-1/4	SHC-970
5/16-18 x 1-1/2	SHC-971
5/16-18 x 1-3/4	SHC-972
5/16-18 x 2	SHC-973
5/16-18 x 2-1/4	SHC-974
5/16-18 x 2-1/2	SHC-975
5/16-18 x 2-3/4	SHC-976
5/16-18 x 3	SHC-977
5/16-18 x 3-1/4	SHC-978
5/16-18 x 3-1/2	SHC-979
5/16-18 x 4	SHC-9018
5/16-18 x 4-1/2	SHC-9032
5/16-18 x 5	SHC-9033
5/16-18 x 5-1/2	SHC-9034
5/16-18 x 6	SHC-9035
3/8-16 x 1/2	SHC-9001
3/8-16 x 3/4	SHC-980
3/8-16 x 7/8	SHC-9002
3/8-16 x 1	SHC-981
3/8-16 x 1-1/8	SHC-982
3/8-16 x 1-1/4	SHC-983
3/8-16 x 1-1/2	SHC-984
3/8-16 x 1-3/4	SHC-985
3/8-16 x 2	SHC-986
3/8-16 x 2-1/4	SHC-987
3/8-16 x 2-1/2	SHC-988
3/8-16 x 2-3/4	SHC-989
3/8-16 x 3	SHC-990
3/8-16 x 3-1/4	SHC-991
3/8-16 x 3-1/2	SHC-992
3/8-16 x 5-1/2	SHC-993
7/16-14 x 1	SHC-9004
7/16-14 x 1-1/4	SHC-9016
7/16-14 x 1-1/2	SHC-994
7/16-14 x 1-3/4	SHC-9017
7/16-14 x 2	SHC-903
7/16-14 x 2-1/2	SHC-904
7/16-14 x 3	SHC-905
7/16-14 x 3-1/2	SHC-906
1/2-13 x 1/2	SHC-995
1/2-13 x 1-3/4	SHC-9026
1/2-13 x 2	SHC-9027
1/2-13 x 2-1/4	SHC-9028
1/2-13 x 2-1/2	SHC-9005
1/2-13 x 2-3/4	SHC-9006

Fine Thread

Fine Thread	Stock Number
8-32 x 3/8	SHC-9013
8-32 x 3/4	SHC-9012
8-32 x 1-1/2	SHC-9011
10-32 x 1/2	SHC-900
10-32 x 5/8	SHC-901
10-32 x 3/4	SHC-996
10-32 x 1	SHC-997
10-32 x 1-1/4	SHC-9009
10-32 x 1-1/2	SHC-9010
1/4-28 x 5/8	SHC-907
1/4-28 x 3/4	SHC-908
1/4-28 x 7/8	SHC-909
1/4-28 x 1	SHC-910
1/4-28 x 1-1/4	SHC-911
1/4-28 x 1-1/2	SHC-912
1/4-28 x 1-3/4	SHC-913
1/4-28 x 2	SHC-914
1/4-28 x 2-1/4	SHC-915
5/16-24 x 5/8	SHC-916
5/16-24 x 3/4	SHC-917
5/16-24 x 7/8	SHC-918
5/16-24 x 1	SHC-919
5/16-24 x 1-1/4	SHC-920
5/16-24 x 1-1/2	SHC-921
5/16-24 x 1-3/4	SHC-922
5/16-24 x 2	SHC-923
5/16-24 x 2-1/4	SHC-924
5/16-24 x 2-1/2	SHC-925
5/16-24 x 2-3/4	SHC-926
5/16-24 x 3	SHC-927
5/16-24 x 3-1/4	SHC-928
3/8-24 x 3/4	SHC-929
3/8-24 x 1	SHC-930
3/8-24 x 1-1/4	SHC-931
3/8-24 x 1-1/2	SHC-932
3/8-24 x 1-3/4	SHC-933
3/8-24 x 2	SHC-934
3/8-24 x 2-1/4	SHC-935
3/8-24 x 2-1/2	SHC-936
3/8-24 x 2-3/4	SHC-937
3/8-24 x 3	SHC-938
3/8-24 x 3-1/4	SHC-998
3/8-24 x 3-1/2	SHC-999
3/8-24 x 5-1/2	SHC-939

Fine Thread

Fine Thread	Stock Number
7/16-20 x 1	SHC-9003
7/16-20 x 1-1/4	SHC-940
7/16-20 x 1-1/2	SHC-941
7/16-20 x 2	SHC-902
7/16-20 x 2-1/2	SHC-942
7/16-20 x 3	SHC-943
7/16-20 x 3-1/2	SHC-944
1/2-20 x 1-1/4	SHC-9019
1/2-20 x 1-1/2	SHC-9020
1/2-20 x 1-3/4	SHC-9007
1/2-20 x 2	SHC-9021
1/2-20 x 2-1/4	SHC-9022
1/2-20 x 2-1/2	SHC-9008
1/2-20 x 2-3/4	SHC-9023
1/2-20 x 3	SHC-9024
1/2-20 x 3-1/2	SHC-9025

Coarse Thread

Coarse Thread	Stock Number
10-24 x 1/4	SHC-9029
10-24 x 3/8	SHC-9030
10-24 x 1/2	SHC-945
10-24 x 5/8	SHC-946
10-24 x 3/4	SHC-947
10-24 x 1	SHC-9000
10-24 x 1-1/4	SHC-948
10-24 x 1-3/4	SHC-949
1/4-20 x 3/8	SHC-950
1/4-20 x 1/2	SHC-951
1/4-20 x 5/8	SHC-952
1/4-20 x 3/4	SHC-953
1/4-20 x 7/8	SHC-954
1/4-20 x 1	SHC-955
1/4-20 x 1-1/8	SHC-956
1/4-20 x 1-1/4	SHC-957
1/4-20 x 1-1/2	SHC-958
1/4-20 x 1-3/4	SHC-959
1/4-20 x 2	SHC-960
1/4-20 x 2-1/4	SHC-961
1/4-20 x 2-1/2	SHC-962
1/4-20 x 2-3/4	SHC-963
1/4-20 x 3	SHC-9014
1/4-20 x 3-1/4	SHC-9031
1/4-20 x 3-1/2	SHC-9015
1/4-20 x 4	SHC-964
1/4-20 x 4-3/4	SHC-9036

Chrome Plated Button Head Allen Screws

• 10 Packs •



Coarse Thread

Fine Thread

Fine Thread	Stock Number
8-32 x 1/2	BHC-800
8-32 x 5/8	BHC-801
8-32 x 3/4	BHC-802
8-32 x 1	BHC-879
10-32 x 1/4	BHC-880
10-32 x 3/8	BHC-881
10-32 x 1/2	BHC-803
10-32 x 3/4	BHC-804
10-32 x 1	BHC-805
1/4-28 x 1/2	BHC-808
1/4-28 x 3/4	BHC-809
1/4-28 x 1	BHC-810
1/4-28 x 1-1/4	BHC-886
1/4-28 x 1-1/2	BHC-887
1/4-28 x 1-3/4	BHC-888
1/4-28 x 2	BHC-8000
5/16-24 x 3/8	BHC-811
5/16-24 x 1/2	BHC-812
5/16-24 x 5/8	BHC-8004
5/16-24 x 3/4	BHC-813
5/16-24 x 7/8	BHC-8002
5/16-24 x 1	BHC-814
5/16-24 x 1-1/4	BHC-815
5/16-24 x 1-1/2	BHC-816
5/16-24 x 1-3/4	BHC-817
5/16-24 x 2	BHC-885
3/8-24 x 1/2	BHC-818
3/8-24 x 3/4	BHC-819
3/8-24 x 1	BHC-820
3/8-24 x 1-1/4	BHC-821
3/8-24 x 1-1/2	BHC-822
3/8-24 x 1-3/4	BHC-823
3/8-24 x 2	BHC-824
3/8-24 x 2-1/4	BHC-875
3/8-24 x 2-1/2	BHC-876
3/8-24 x 3	BHC-878
1/2-20 x 1	BHC-892
1/2-20 x 1-1/4	BHC-893
1/2-20 x 1-1/2	BHC-894
1/2-20 x 2	BHC-895
1/2-20 x 2-1/2	BHC-896
1/2-20 x 3	BHC-897
1/2-20 x 4	BHC-898

Coarse Thread	Stock Number
10-24 x 3/8	BHC-859
10-24 x 1/2	BHC-825
10-24 x 5/8	BHC-826
1/4-20 x 3/8	BHC-827
1/4-20 x 1/2	BHC-828
1/4-20 x 5/8	BHC-829
1/4-20 x 3/4	BHC-830
1/4-20 x 7/8	BHC-831
1/4-20 x 1	BHC-832
1/4-20 x 1-1/8	BHC-833
1/4-20 x 1-1/4	BHC-834
1/4-20 x 1-1/2	BHC-835
1/4-20 x 1-3/4	BHC-836
1/4-20 x 2	BHC-837
1/4-20 x 2-1/4	BHC-838
1/4-20 x 2-1/2	BHC-839
1/4-20 x 2-3/4	BHC-860
5/16-18 x 1/2	BHC-840
5/16-18 x 3/4	BHC-841
5/16-18 x 7/8	BHC-842
5/16-18 x 1	BHC-843
5/16-18 x 1-1/4	BHC-844
5/16-18 x 1-1/2	BHC-845
5/16-18 x 1-3/4	BHC-846
5/16-18 x 2	BHC-847
5/16-18 x 2-1/2	BHC-882
3/8-16 x 1/2	BHC-848
3/8-16 x 5/8	BHC-8001
3/8-16 x 7/8	BHC-8003
3/8-16 x 3/4	BHC-849
3/8-16 x 1	BHC-850
3/8-16 x 1-1/4	BHC-851
3/8-16 x 1-1/2	BHC-852
3/8-16 x 1-3/4	BHC-853
3/8-16 x 2	BHC-854
3/8-16 x 2-1/4	BHC-855
3/8-16 x 2-1/2	BHC-856
3/8-16 x 2-3/4	BHC-857
3/8-16 x 3	BHC-858
1/2-13 x 1/2	BHC-899
1/2-13 x 3/4	BHC-8005
1/2-13 x 1	BHC-889
1/2-13 x 1-1/2	BHC-890
1/2-13 x 2	BHC-891
1/2-13 x 2-1/2	BHC-883

Chrome Plated Flat Head Allen Screws

• 10 Packs •



Fine Thread

Fine Thread	Stock Number
8-32 x 1/4	FHS-132
8-32 x 3/8	FHS-133
8-32 x 1/2	FHS-100
8-32 x 5/8	FHS-101
8-32 x 3/4	FHS-102
10-32 x 1/4	FHS-135
10-32 x 1/2	FHS-103
10-32 x 5/8	FHS-134
10-32 x 3/4	FHS-104
10-32 x 1	FHS-105
1/4-28 x 1/2	FHS-106
1/4-28 x 3/4	FHS-107
1/4-28 x 1	FHS-108
1/4-28 x 1-1/4	FHS-109
1/4-28 x 1-1/2	FHS-110
1/4-28 x 2	FHS-111
1/4-28 x 2-1/4	FHS-112
1/4-28 x 2-1/2	FHS-113
5/16-24 x 1/2	FHS-114
5/16-24 x 3/4	FHS-115
5/16-24 x 1	FHS-116
5/16-24 x 1-1/4	FHS-117
5/16-24 x 1-1/2	FHS-118
5/16-24 x 1-3/4	FHS-119
5/16-24 x 2	FHS-120
3/8-24 x 1/2	FHS-121
3/8-24 x 3/4	FHS-122
3/8-24 x 1	FHS-123
3/8-24 x 1-1/4	FHS-124
3/8-24 x 1-1/2	FHS-125
3/8-24 x 1-3/4	FHS-126
3/8-24 x 2	FHS-127
7/16-20 x 1-1/4	FHS-128
7/16-20 x 1-1/2	FHS-129
7/16-20 x 1-3/4	FHS-130
7/16-20 x 2	FHS-131
1/2-20 x 2-3/4	FHS-137
1/2-20 x 3	FHS-190
5/8-18 x 1-1/4	FHS-192
5/8-18 x 1-1/2	FHS-193

Coarse Thread

Coarse Thread	Stock Number
10-24 x 1/2	FHS-150
10-24 x 5/8	FHS-151
10-24 x 3/4	FHS-183
10-24 x 1	FHS-184
1/4-20 x 3/8	FHS-152
1/4-20 x 1/2	FHS-153
1/4-20 x 5/8	FHS-154
1/4-20 x 3/4	FHS-155
1/4-20 x 7/8	FHS-156
1/4-20 x 1	FHS-157
1/4-20 x 1-1/4	FHS-158
1/4-20 x 1-1/2	FHS-159
1/4-20 x 1-3/4	FHS-160
1/4-20 x 2	FHS-161
1/4-20 x 2-1/4	FHS-162
1/4-20 x 2-1/2	FHS-163
5/16-18 x 1/2	FHS-164
5/16-18 x 3/4	FHS-165
5/16-18 x 7/8	FHS-166
5/16-18 x 1	FHS-167
5/16-18 x 1-1/4	FHS-168
5/16-18 x 1-1/2	FHS-169
5/16-18 x 1-3/4	FHS-170
5/16-18 x 2	FHS-171
3/8-16 x 1/2	FHS-172
3/8-16 x 3/4	FHS-173
3/8-16 x 1	FHS-174
3/8-16 x 1-1/4	FHS-175
3/8-16 x 1-1/2	FHS-176
3/8-16 x 1-3/4	FHS-177
3/8-16 x 2	FHS-178
3/8-16 x 2-3/4	FHS-186
3/8-16 x 3	FHS-191
3/8-16 x 3-1/2	FHS-196
7/16-14 x 1	FHS-185
7/16-14 x 1-1/4	FHS-179
7/16-14 x 1-1/2	FHS-180
7/16-14 x 1-3/4	FHS-181
7/16-14 x 2	FHS-182
1/2-13 x 1	FHS-194
1/2-13 x 1-1/2	FHS-188
1/2-13 x 2	FHS-195
1/2-13 x 2-1/2	FHS-187
1/2-13 x 2-3/4	FHS-136
1/2-13 x 3	FHS-189

Companion Countersunk Chrome Plated Washers

for use with Flat Head
Allen Screws for Ultra
Custom Applications



Chrome plated 82 degrees countersunk washers are made to accept flat head allen screws for a variety of custom applications. Available packaged as follows:

Stock No.	Size	Quantity
9843-8	#10	8 per card
9834-8	1/4"	8 per card
9835-8	5/16"	8 per card
9836-5	3/8"	5 per card
9844-5	7/16"	5 per card
9973-4	1/2"	4 per card

Standard Chrome Plated Metric Fasteners

• 10 Packs •

Thread pitches for metric fasteners on this page are as follows:

4mm — .70
5mm — .80
6mm — 1.0
8mm — 1.25
10mm — 1.50
12mm — 1.75

Nylon Insert Locknuts

Thread Size	Stock Number
4mm	NL-514
5mm	NL-515
6mm	NL-516
8mm	NL-517
10mm	NL-518
12mm	NL-519

Hex Nut

Thread Size	Stock Number
6mm	HN-410
8mm	HN-411
10mm	HN-418
12mm	HN-419

Flanged Nuts

Thread Size	Stock Number
6mm	MFN-0001
8mm	MFN-0002
10mm	MFN-0003
12mm	MFN-0004

Lock Washers

Bag of 100 pieces

Size	Stock Number
6mm	6MM-L-100
8mm	8MM-L-100
10mm	10MM-L-100
12mm	12MM-L-100

Flat Washers

Bag of 100 pieces

Size	Stock Number
6mm	6MM-F-100
8mm	8MM-F-100
10mm	10MM-F-100
12mm	12MM-F-100

Allen Screws

Size	Polished Head Stock Number	Knurled Head Stock Number
5mm x 10mm	MPSHC-0201	MSHC-0901
5mm x 12mm	MPSHC-0202	MSHC-0902
6mm x 10mm	MPSHC-0203	MSHC-0903
6mm x 16mm	MPSHC-0204	MSHC-0904
6mm x 20mm	MPSHC-0205	MSHC-0905
6mm x 25mm	MPSHC-0206	MSHC-0906
6mm x 30mm	MPSHC-0207	MSHC-0907
6mm x 40mm	MPSHC-0208	MSHC-0908
6mm x 50mm	MPSHC-0209	MSHC-0909
8mm x 20mm	MPSHC-0210	MSHC-0910
8mm x 30mm	MPSHC-0211	MSHC-0911
8mm x 40mm	MPSHC-0212	MSHC-0912
8mm x 50mm	MPSHC-0213	MSHC-0913
10mm x 25mm	MPSHC-0214	MSHC-0914
10mm x 30mm	MPSHC-0215	MSHC-0915
10mm x 40mm	MPSHC-0216	MSHC-0916
10mm x 50mm	MPSHC-0217	MSHC-0917

Button Head Allen Screws

Size	Stock Number
5mm x 13mm	MBHC-0801
6mm x 12mm	MBHC-0802
6mm x 15mm	MBHC-0803
6mm x 20mm	MBHC-0804
6mm x 25mm	MBHC-0805
6mm x 30mm	MBHC-0806
6mm x 40mm	MBHC-0807
6mm x 50mm	MBHC-0808
8mm x 15mm	MBHC-0810
8mm x 20mm	MBHC-0811
8mm x 25mm	MBHC-0812
8mm x 30mm	MBHC-0813
8mm x 35mm	MBHC-0814

Chrome Plated Hex Head Bolts - Polished

• 10 Packs •



Fine Thread

Fine Thread	Stock Number
1/4-28 x 1/2	HHC-6001
1/4-28 x 5/8	HHC-650
1/4-28 x 3/4	HHC-651
1/4-28 x 7/8	HHC-652
1/4-28 x 1	HHC-653
1/4-28 x 1-1/4	HHC-654
1/4-28 x 1-1/2	HHC-655
1/4-28 x 1-3/4	HHC-656
1/4-28 x 2	HHC-657
1/4-28 x 2-1/4	HHC-658
1/4-28 x 5-1/2	HHC-696
5/16-24 x 5/8	HHC-659
5/16-24 x 3/4	HHC-660
5/16-24 x 7/8	HHC-661
5/16-24 x 1	HHC-662
5/16-24 x 1-1/4	HHC-663
5/16-24 x 1-1/2	HHC-664
5/16-24 x 1-3/4	HHC-665
5/16-24 x 2	HHC-666
5/16-24 x 2-1/4	HHC-667
5/16-24 x 2-1/2	HHC-691
5/16-24 x 2-3/4	HHC-692
5/16-24 x 3	HHC-693
5/16-24 x 5	HHC-697
3/8-24 x 3/4	HHC-668
3/8-24 x 1	HHC-669
3/8-24 x 1-1/4	HHC-670
3/8-24 x 1-1/2	HHC-671
3/8-24 x 1-3/4	HHC-672
3/8-24 x 2	HHC-673
3/8-24 x 2-1/4	HHC-679
3/8-24 x 2-1/2	HHC-680
3/8-24 x 2-3/4	HHC-681
3/8-24 x 3	HHC-682
3/8-24 x 3-1/4	HHC-683
3/8-24 x 3-1/2	HHC-684
7/16-20 x 1	HHC-674
7/16-20 x 1-1/4	HHC-675
7/16-20 x 1-1/2	HHC-676
7/16-20 x 1-3/4	HHC-677
7/16-20 x 2	HHC-678

Coarse Thread

Coarse Thread	Stock Number
1/4-20 x 1/2	HHC-633
1/4-20 x 5/8	HHC-600
1/4-20 x 3/4	HHC-601
1/4-20 x 7/8	HHC-602
1/4-20 x 1	HHC-603
1/4-20 x 1-1/4	HHC-604
1/4-20 x 1-1/2	HHC-605
1/4-20 x 1-3/4	HHC-606
1/4-20 x 2	HHC-607
1/4-20 x 2-1/4	HHC-608
1/4-20 x 2-3/4	HHC-698
5/16-18 x 1/2	HHC-632
5/16-18 x 5/8	HHC-609
5/16-18 x 3/4	HHC-610
5/16-18 x 7/8	HHC-611
5/16-18 x 1	HHC-612
5/16-18 x 1-1/4	HHC-613
5/16-18 x 1-1/2	HHC-614
5/16-18 x 1-3/4	HHC-615
5/16-18 x 2	HHC-616
5/16-18 x 2-1/4	HHC-617
5/16-18 x 2-1/2	HHC-629
5/16-18 x 2-3/4	HHC-630
5/16-18 x 3	HHC-631
5/16-18 x 3-1/4	HHC-694
5/16-18 x 3-1/2	HHC-6002
3/8-16 x 3/4	HHC-618
3/8-16 x 1	HHC-619
3/8-16 x 1-1/4	HHC-620
3/8-16 x 1-1/2	HHC-621
3/8-16 x 1-3/4	HHC-622
3/8-16 x 2	HHC-623
3/8-16 x 2-1/4	HHC-685
3/8-16 x 2-1/2	HHC-686
3/8-16 x 2-3/4	HHC-687
3/8-16 x 3	HHC-688
3/8-16 x 3-1/4	HHC-689
3/8-16 x 3-1/2	HHC-690
3/8-16 x 3-3/4	HHC-699
7/16-14 x 1	HHC-624
7/16-14 x 1-1/4	HHC-625
7/16-14 x 1-1/2	HHC-626
7/16-14 x 1-3/4	HHC-627
7/16-14 x 2	HHC-628

Hardware Assortments



Chrome Plated Button Head Socket Head Screws

Stock No.
 Tray-005 Complete assortment of screws as listed below
 COARSE THREAD
 Tray-004 Complete assortment of screws as listed below
 FINE THREAD
 Individual packs of 10 pieces each

Coarse	Fine	Size
BHC-859	BHC-800	8 x 1/2
BHC-825	BHC-802	8 x 3/4
BHC-826	BHC-879	8 x 1
BHC-828	BHC-803	10 x 1/2
BHC-830	BHC-804	10 x 3/4
BHC-832	BHC-805	10 x 1
BHC-834	BHC-808	1/4 x 1/2
BHC-835	BHC-809	1/4 x 3/4
BHC-836	BHC-810	1/4 x 1
BHC-837	BHC-812	5/16 x 1/2
BHC-838	BHC-813	5/16 x 3/4
BHC-841	BHC-814	5/16 x 1
BHC-843	BHC-815	5/16 x 1-1/4
BHC-844	BHC-816	5/16 x 1-1/2
BHC-845	BHC-817	5/16 x 1-3/4
BHC-846	BHC-819	3/8 x 3/4
BHC-849	BHC-820	3/8 x 1
BHC-850	BHC-821	3/8 1-1/4
BHC-851	BHC-822	3/8 x 1-1/2
BHC-852	BHC-823	3/8 x 1-3/4
BHC-853	BHC-824	3/8 x 2
BHC-854	BHC-875	3/8 x 2-1/4
BHC-855	BHC-876	3/8 x 2-1/2
BHC-856	BHC-878	3/8 x 3

Chrome Plated Hex Head Bolts

Stock No.
 Tray-011 Complete assortment of screws as listed below
 COARSE THREAD
 Tray-012 Complete assortment of screws as listed below
 FINE THREAD

Coarse	Fine	Size
HHC-600	HHC-650	1/4 x 5/8
HHC-601	HHC-651	1/4 x 3/4
HHC-602	HHC-652	1/4 x 7/8
HHC-603	HHC-653	1/4 x 1
HHC-604	HHC-654	1/4 x 1-1/4
HHC-605	HHC-655	1/4 x 1-1/2
HHC-606	HHC-656	1/4 x 1-3/4
HHC-607	HHC-657	1/4 x 2
HHC-608	HHC-658	1/4 x 2-1/4
HHC-609	HHC-659	5/16 x 5/8
HHC-610	HHC-660	5/16 x 3/4
HHC-611	HHC-661	5/16 x 7/8
HHC-612	HHC-662	5/16 x 1
HHC-613	HHC-663	5/16 x 1-1/4
HHC-614	HHC-664	5/16 x 1-1/2
HHC-615	HHC-665	5/16 x 1-3/4
HHC-616	HHC-666	5/16 x 2
HHC-617	HHC-667	5/16 2-1/4
HHC-618	HHC-668	3/8 x 3/4
HHC-619	HHC-669	3/8 x 1
HHC-620	HHC-670	3/8 x 1-1/4
HHC-621	HHC-671	3/8 x 1-1/2
HHC-622	HHC-672	3/8 x 1-3/4
HHC-623	HHC-673	3/8 x 2

Chrome Plated Smooth Head Socket Head Screws

Stock No.
 Tray-006 Complete assortment of screws as listed below
 COARSE THREAD
 Tray-007 Complete assortment of screws as listed below
 FINE THREAD

Coarse	Fine	Size
PSHC-257	PSHC-209	1/4 x 5/8
PSHC-258	PSHC-210	1/4 x 3/4
PSHC-259	PSHC-211	1/4 x 7/8
PSHC-260	PSHC-212	1/4 x 1
PSHC-262	PSHC-213	1/4 x 1-1/4
PSHC-263	PSHC-214	1/4 x 1-1/2
PSHC-264	PSHC-215	1/4 x 1-3/4
PSHC-265	PSHC-216	1/4 x 2
PSHC-266	PSHC-217	1/4 x 2-1/4
PSHC-271	PSHC-218	5/16 x 5/8
PSHC-272	PSHC-219	5/16 x 3/4
PSHC-273	PSHC-220	5/16 x 7/8
PSHC-274	PSHC-221	5/16 x 1
PSHC-275	PSHC-222	5/16 x 1-1/4
PSHC-276	PSHC-223	5/16 x 1-1/2
PSHC-277	PSHC-224	5/16 x 1-3/4
PSHC-278	PSHC-225	5/16 x 2
PSHC-279	PSHC-226	5/16 2-1/4
PSHC-285	PSHC-231	3/8 x 3/4
PSHC-286	PSHC-232	3/8 x 1
PSHC-288	PSHC-233	3/8 x 1-1/4
PSHC-289	PSHC-234	3/8 x 1-1/2
PSHC-290	PSHC-235	3/8 x 1-3/4
PSHC-291	PSHC-236	3/8 x 2

Chrome Plated Socket Head Screws

Stock No.
 Tray-009 Complete assortment of screws as listed below
 COARSE THREAD
 Tray-010 Complete assortment of screws as listed below
 FINE THREAD

Coarse	Fine	Size
SHC-952	SHC-907	1/4 x 5/8
SHC-953	SHC-908	1/4 x 3/4
SHC-954	SHC-909	1/4 x 7/8
SHC-955	SHC-910	1/4 x 1
SHC-957	SHC-911	1/4 x 1-1/4
SHC-958	SHC-912	1/4 x 1-1/2
SHC-959	SHC-913	1/4 x 1-3/4
SHC-960	SHC-914	1/4 x 2
SHC-961	SHC-915	1/4 x 2-1/4
SHC-966	SHC-916	5/16 x 5/8
SHC-967	SHC-917	5/16 x 3/4
SHC-968	SHC-918	5/16 x 7/8
SHC-969	SHC-919	5/16 x 1
SHC-970	SHC-920	5/16 x 1-1/4
SHC-971	SHC-921	5/16 x 1-1/2
SHC-972	SHC-922	5/16 x 1-3/4
SHC-973	SHC-923	5/16 x 2
SHC-974	SHC-924	5/16 x 2-1/4
SHC-980	SHC-929	3/8 x 3/4
SHC-981	SHC-930	3/8 x 1
SHC-983	SHC-931	3/8 x 1-1/4
SHC-984	SHC-932	3/8 x 1-1/2
SHC-985	SHC-933	3/8 x 1-3/4
SHC-986	SHC-934	3/8 x 2

Hardware Assortments



Chrome Plated Lockwashers and Flatwashers Stock No.

Stock No.	Description	Quantity
9633-50	Flatwashers OEM#6099	50/pkg
1/4-F-100	Flatwashers	Bag of 100
2115-12	Flatwasher (1/4x39/64x3/32)	12 pcs
5/16-F-100	Flatwasher	Bag of 100
2113-12	Flatwasher (5/16x11/16x1/16)	12 pcs
3/8-F-100	Flatwashers	Bag of 100
2111-6	Flatwasher (3/8x13/16x1/16)	6 pcs
2114-6	Flatwasher (3/8x7/8x1/8)	6 pcs
7/16-F-100	Flatwashers	Bag of 100
2112-6	Flatwasher (7/16x15/16x1/8)	6 pcs
1/4-L-100	Lockwashers	Bag of 100
5/16-L-100	Lockwashers	Bag of 100
3/8-L-100	Lockwashers	Bag of 100
7/16-L-100	Lockwashers	Bag of 100
9971-5	Lockwasher 1/2"	5 pcs
9972-5	Flatwasher (1/2x1-1/16x3/32)	5 pcs

Chrome Plated Hex Nuts Stock No.

Tray-003 Complete assortment of nuts as listed below in packs of 10 pieces each

Stock No.	Size
HN-415	10-32
HN-400	1/4-28
HN-401	5/16-24
HN-402	3/8-24
HN-403	7/16-20
HN-404	1/2-20
HN-414	10-24
HN-406	1/4-20
HN-407	5/16-18
HN-408	3/8-16
HN-409	7/16-14
HN-417	5/8-18

Chrome Plated Nylon Insert Locknuts Stock No.

Tray-002 Complete assortment of nuts as listed below in packs of 10 pieces each

Stock No.	Size
NL-500	10-32
NL-501	1/4-28
NL-502	5/16-24
NL-503	3/8-24
NL-504	7/16-20
NL-505	1/2-20
NL-507	10-24
NL-508	1/4-20
NL-509	5/16-18
NL-510	3/8-16
NL-511	7/16-14
NL-512	1/2-13
NL-513	5/8-18

Chrome Plated Acorn Nuts Stock No.

Tray-008 Complete assortment of nuts as listed below in packs of 10 pieces each*

Stock No.	Size
AN-125	8-32
AN-100	10-32
AN-102	1/4-28
AN-104	5/16-24
AN-105	3/8-24
AN-106	7/16-20
AN-107	1/2-20
AN-112	10-24
AN-113	1/4-20
AN-114	5/16-18
AN-101	12-24
AN-115	3/8-16
AN-116	7/16-14
AN-117	1/2-13
5/8-18A	5/8-18 SAE 15-16*
5/8-11A	5/8-11 UNC 15/16*

*One piece only

Chrome Plated Pike Nuts Stock No.

Tray-013 Complete assortment of nuts as listed below in packs of 10 pieces each*

Stock No.	Size
PN-324	8-32
PN-300	10-32
PN-301	1/4-28
PN-302	1/4-24
PN-303	5/16-24
PN-304	3/8-24
PN-305	7/16-20
PN-306	1/2-20
PN-310	10-24
PN-311	1/4-20
PN-312	5/16-18
PN-313	3/8-16
PN-314	7/16-14
PN-315	1/2-13
5/8-18P	5/8-18, 1" hex*
5/8-18P-L	5/8-18, 1-1/4" hex*
5/8-11P	5/8-11, 1" hex*

*One piece only

Harley Davidson Knucklehead, Panhead, Shovelhead, Evolution, Twin Cam 88 Screw and Nut Kit Application Index

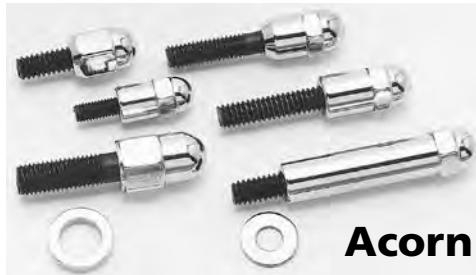

Acorn Style Stock Number		Cap Style Stock Number
7206-2	Air cleaner screws – Sportster and 74's pre 78 with stock air cleaners	8461-2
8606-6	Axle Kit (Rear) – Big Twins 1973-up	8607-6
7130-10	Circuit Breaker Screw Kit – Big Twins 1936-1957	8446-10
7017-16	Cylinder Base Nut Kit – Big Twins 1930-1977	8437-16
7813-8	Cylinder Base Nut Kit – Shovelhead 1978-1984	8474-8
8016-4	Dash Mounting Kit – FX 1977-1985	8476-4
9014-3	Dash Mounting Kit – 1986-up FXR models except FXRS 1988-up	9015-3
9947-8	Electrical Panel Cover Mounting Kit – Dyna models 1991-up	
7207-8	Fender Rail Mounting Kit (Rear) – FX 1971-1986	8462-8
9638-30	Fender Rail Screw Kit (Rear) – 1958-1980 FL, FLH	
2045-34	Fender Strut Mounting Kit (Rear) – All FX and FL Softail 2000-up except FX Deuce	
7114-2	Generator Screw Kit – Big Twins 1936-1957	8444-2
7113-2	Generator Screw Kit – Big Twins 1958-1969	8443-2
8724-18	Handlebar Clamp & Gauge Mount Kit – FX 1983-1994	8725-18
9961-12	Handlebar Clamp & Gauge Mount Kit – FX 1995-up	
8722-16	Handlebar Clamp Mount Kit – FX, FLST, 1974-up - Replaces OEM 4816	8723-16
9777-8	Handlebar Lever and Switch Housing Screw Kit – Big Twins 1982-1995	
9778-8	Handlebar Lever and Switch Housing Screw Kit – Big Twins 1996-up Dyna, Softail, 1996-2007 FLT	
8717-4	Headlight Visor Mounting Bolt Kit – FX 1959-up	8718-4
9000-4	Head Bolt Covers – All Evolution 1984 – Early 1985	9002-4
7153-20	Head Bolt Kit – Big Twins 1948-1983	8457-20
7152-20	Head Bolt Kit – Knucklehead 1936-1939	8456-20
7157-20	Head Bolt Kit – Knucklehead 1940-1947	8460-20
7803-11	Kickstand Mounting Kit – 4 speed Big Twins 1936-1986 (except Softail models)	
7110-8	Knuckle Nuts – Knucklehead 1936-1947	
7131-8	Lifter Base Screw Kit – O.H.V. Big Twins 1936-1975	8447-8
7628-8	Lifter Base Screw Kit – Big Twins 1976-up except Twin Cam 88	8470-8
9941-24	Lifter Base Screw Kit – Twin Cam 88 Dyna and FLT models 1999-up, Softail 2000-up	
8480-8	Late Lifter Bases to Early Case Conversion Kit	8490-8
8121-34	Motor Case Stud & Nut Kit – Flathead 1936-1939	
8124-34	Motor Case Stud & Nut Kit – Flathead 1940-1948	
8127-34	Motor Case Stud & Nut Kit – Knucklehead 1936-1939	
8130-34	Motor Case Stud & Nut Kit – Knucklehead 1940-1947	
8133-34	Motor Case Stud & Nut Kit – Panhead 1948-1964	
8136-34	Motor Case Stud & Nut Kit – Panhead/Shovelhead 1965-1969	
8139-34	Motor Case Stud & Nut Kit – Shovelhead 1970-1978	
8142-34	Motor Case Stud & Nut Kit – Shovelhead/Evolution 1979-1995	
9882-22	Motor Case Stud & Nut Kit – Evolution 1996-up	
9955-27	Motor Case Stud & Nut Kit – Dyna 1999-up, Softail 2000-up, Touring 1999-2016	
7603-4	Motor Mount Kit (Lower) – Big Twins 1936-1984	
7604-7	Motor Mount Kit (Upper) – Big Twins 1936-1984	
9936-28	Motor Mount Kit, Front – Dyna Models 1991-up	
9822-4	Oil Filter Adaptor Screw Kit – Evolution 1992-up, except Twin Cam 88	
9938-6	Oil Filter Adaptor Screw Kit – Dyna 1999-up, Touring 1999-2016	
9949-6	Oil Hose Cover Mounting Kit – Dyna 1999-up, Touring 1999-2016	
2689-10	Oil Pan Mounting Kit – 2006-up Dyna	
7100-13	Oil Pump Nut Kit – Big Twins 1936-1967 (NUTS ONLY)	8439-13
7417-13	Oil Pump Screw Kit – Big Twins 1968-1977	8469-13

Harley Davidson Knucklehead, Panhead, Shovelhead, Evolution, Twin Cam 88 Screw and Nut Kit Application Index



Acorn



Cap

Acorn Style Stock Number		Cap Style Stock Number
7827-12	Oil Pump Screw Kit – Big Twins 1978-1991	8477-12
9763-16	Oil Pump Screw Kit – Softail 1992-1999, Dyna and FLT 1992-1998	9764-16
8402-2	Point Cover Screws – Big Twins 1971-up	8491-2
8403-2	Point Cover Screws – Big Twins 1971-up GOLD PLATED	8492-2
9953-10	Point Cover Screws – Dyna 1999-up, Softail 2000-up, Touring 1999-2016	
7414-20	Primary Cover Screw Kit – Use on Stamped Steel Inner & Outer Big Twins 1936-1969	8468-20
7146-12	Primary Cover Screw Kit – Big Twins 1965-1970 Cast Aluminum Cover	8452-12
7350-15	Primary Cover Screw Kit – Big Twins 1971-up 4-Speed	8464-15
7304-16	Primary Cover Screw Kit – Big Twins 1965-1979 with Accessory-Type Pressed Metal Primary Cover	8463-16
8481-20	Primary Cover Screw Kit – All Big Twins with 5-Speed 1980-1984	8482-20
8914-17	Primary Cover Screw Kit – 1985-up FXR, 1985-1999 FLT, 5 Speed, except 1989-up FXST	8915-17
8917-19	Primary Cover Screw Kit – 1989-06 Softail and 1991-05 Dyna Glide	8918-19
2686-18	Primary Cover Screw Kit – 2006-up Dyna	
2471-20	Primary Cover Mount Kit – 2007-up Softail	
9958-19	Primary Cover Screw Kit – Twin Cam 88 FLT models 1999-2006	
2534-19	Primary Cover Mounting Kit – 2007-2016 Touring	
7412-24	Rocker Arm Cover Screw Kit – All Panhead	8467-24
8868-16	Rocker Box Screw Kit – 1985-up FL, FX, 1986-up XL, except Twin Cam 88	8933-16
9943-26	Rocker Box Screw Kit – Dyna 1999-up, Softail 2000-up, Touring 1999-2016	
7102-12	Rocker Box Bolt Kit – Knucklehead 1936-1947	8440-12
7137-22	Rocker Box Nut Kit – Shovelhead 1966-1984	8449-22
7143-4	Rocker Shaft End Plug Kit – Shovelhead 1966-1970	
8001-8	Rocker Shaft End Plug Kit – Shovelhead 1966-1970 GOLD	
7142-4	Rocker Shaft End Plug Kit – Shovelhead 1971-1984	
8000-8	Rocker Shaft End Plug Kit – Shovelhead 1971-1984 GOLD	
8730-8	Rocker Shaft Nut & Washer Kit – Shovelhead 1966-1984	8400-8
8731-8	Rocker Shaft Nut & Washer Kit – Shovelhead 1966-1984 GOLD	8436-8
	Rocker Shaft Nut & Washer Kit – Shovelhead 1966-1984 CAD	8401-8

Harley Davidson Knucklehead, Panhead, Shovelhead, Evolution, Twin Cam 88 Screw and Nut Kit Application Index



Acorn



Cap

Acorn Style Stock Number		Cap Style Stock Number
8413-8	Switch Housing Screw Kit – Big Twins 1973-1981	8489-8
7129-12	Timing Cover Screw Kit – Big Twins 1936-1969	8445-12
7402-7	Timing Cover Screw Kit – Big Twins 1970-1992	8466-7
9820-6	Timing Cover Screw Kit – Big Twins 1993-up, except Twin Cam 88	
9945-20	Timing Cover Screw Kit – Twin Cam 88 Dyna, FLT and Softail models	
7602-11	Transmission Adjusting Screws and Mounting Kit – Big Twins 1936-1964	
7800-8	Transmission Mounting Plate to Frame Kit – 4-Speed Big Twins 1936-1986	
8404-27	Transmission Screw & Nut Kit – FLT 1980-1985 & 5-Speed	8478-27
7112-19	Transmission Side Cover Nut Kit – Big Twins 1936-1984 4-Speed	8442-19
8751-19	Transmission Side Cover Nut Kit – All Big Twins 4-Speed 1936-1984 Shovelhead Evolution 4-Speed Use on Long Studs	8752-19
8912-13	Transmission Side Cover Screw Kit – 1987-06 FX, FL, Softail & all 1991-05 Dyna models	8913-13
2687-13	Transmission Side Cover Screw Kit – 2006-up Dyna	
2532-14	Transmission Side Cover Mounting Kit – 2007-2016 Touring	
2475-19	Transmission Side Cover Mount Kit – 2007-up Softail	
8910-5	Transmission Shifter Cover Screw Kit – FX, FL, Evolution 1980-1987	8911-5
8921-5	Transmission Shifter Cover Screw Kit – FXR, FLT, Evolution 1988-97	8922-5
9785-9	Transmission Shifter Cover and Speedometer Sensor Screw Kit – 1991-05 Dyna Models	
2688-6	Transmission Shifter Cover Screw Kit – 2006-up Dyna	
9951-12	Transmission Shifter Cover and Speedometer Sensor Screw Kit – Softail 1998-2006, FLT 1998-2006	
2533-6	Transmission Shifter Cover Mounting Kit – 2007-up FLT	
2473-6	Transmission Shifter Cover Mount Kit – 2007-up Softail	
9934-8	Transmission to Motor Mounting Kit – Dyna, FLT and Softail models up to 2006	
2469-8	Transmission to Motor Mount Kit – 2007-up Twin Cam Dyna, FLT, Softail	
2047-4	Voltage Regulator Mounting Kit – 2000-up Softail	
7144-5	Wheel Hub Cover Screw Kit – Big Twins 1936-1966	8451-5

Sportster Screw & Nut Kits



Acorn Style Stock Number		Cap Style Stock Number
7206-2	Air Cleaner Screws–Sportster and 74's pre 78 with Stock Air Cleaners	8461-2
8606-6	Axle Kit (Rear) –Sportster 1979-up	8607-6
7118-9	Cam Cover Screw Kit–Sportster 1957-1970	
7150-8	Cam Cover Screw Kit–Sportster 1971-1985	8454-8
8865-11	Cam Cover Screw Kit–883/1100 XL 1986-2003	
2223-11	Cam Cover Screw Kit–Sportster 2004-up	
7018-16	Cylinder Base Nut Kit–Sportster 1957-1985	8438-16
7623-8	Cylinder Base Nut Kit–XLR Style–Sportster 1957-1985	
7624-8	Cylinder Base Nut Kit–XLR Style–Sportster 1957-1985 BLACK	
7207-8	Fender Rail Mounting Kit (Rear)–Sportster 1954-1978	8462-8
7130-2	Generator Screw Kit–Sportster 1957-1970	
7154-2	Generator Screw Kit–Sportster 1971-1985	8458-2
8724-18	Handlebar Clamp & Gauge Mount Kit–Sportster 1983-1994	8725-18
9961-12	Handlebar Clamp & Gauge Mount Kit–Sportster 1995-up	
8722-16	Handlebar Clamp Mount Kit–Sportster 1974-up	8723-16
9777-8	Handlebar Lever and Switch Housing Screw Kit–Sportster 1982-1995	
9778-8	Handlebar Lever and Switch Housing Screw Kit–Sportster 1996-2003	
2795-8	Handlebar Lever and Switch Housing Screw Kit–Sportster 2004-up	
8717-4	Headlight Visor Mounting Bolt Kit–Sportster 1959-up	8718-4
9110-9	Head Bolt Covers–XL 1973-1984	9112-9
9000-4	Head Bolt Covers–All Evolution 1984 - early 1985	9002-4
7151-16	Head Bolt Kit–Sportster 1957-1972	8455-16
7352-16	Head Bolt Kit–Sportster 1973-1985	8465-16
7139-4	Lifter Base Screw Kit–Sportster 1957-1985	8450-4
8867-4	Lifter Base Screw Kit–883/1100 XL 1986-1990	
9765-4	Lifter Base Screw Kit–Sportster 1991-1994	
9766-4	Lifter Base Screw Kit–Sportster 1995-2003	
2225-8	Lifter Base Kit–Sportster 2004-up	
2218-8	Motor Case Kit–Sportster 2004-up	
7141-18	Motor Mount Kit (Front Lower)–Sportster 1957-1985	
7408-10	Motor Mount Kit–Extra Length–Sportster 1957-1985	
8870-21	Motor Mount Kit (Lower)–883/1100 XL 1986-1992	
9773-8	Motor Mount Kit (Center)–Sportster 1986-2003	
8871-13	Motor Mount Kit (Upper)–883/1100 XL 1986-2003	
2668-21	Motor Mount Kit (Lower)–Sportster 1993-2003	
2229-16	Motor Mount Kit–Sportster 2004-up	

Sportster Screw & Nut Kits



Acorn



Cap

Acorn Style Stock Number		Cap Style Stock Number
8864-4	Oil Filter Adaptor Screw Kit-883/1100 XL 1986-1990	
9805-10	Oil Pump Mounting Kit-Sportster 1954-1976	
9806-8	Oil Pump Mounting Kit-Sportster 1977-1990	
9775-8	Oil Pump Mounting Kit-Sportster 1991-up	
8402-2	Point Cover Screw Kit-Sportster 1971-2003	8491-2
8403-2	Point Cover Screw Kit-Sportster 1971-2003 GOLD PLATED	8492-2
7117-16	Primary Cover Screw Kit (Stamped Steel Cover) Sportster 1957-1969	
7116-14	Primary Cover Screw Kit-XLH 1967-1970, XLCH 1970	
7149-11	Primary Cover Screw Kit-Sportster 1971-1976	8453-11
7631-11	Primary Cover Screw Kit-Sportster 1977-1985	8473-11
8869-13	Primary Cover Screw Kit-883/1100 XL 1986-1990	
9768-15	Primary Cover Screw Kit-Sportster 1991-1993	
9770-17	Primary Cover Screw Kit-Sportster 1994-2003	
2221-24	Primary Cover Screw Kit-Sportster 2004-up	
7136-14	Rocker Box Screw Kit-Sportster 1957-1976	8448-14
7629-14	Rocker Box Screw Kit-Sportster 1977-1985	8471-14
8868-16	Rocker Cover Screw Kit-883/1100 XL 1986-up	8933-16
7143-4	Rocker Shaft End Plug Kit-Sportster 1957-1970	
8001-8	Rocker Shaft End Plug Kit-Sportster 1957-1970 GOLD	
7142-4	Rocker Shaft End Plug Kit-Sportster 1971-1985	
8000-8	Rocker Shaft End Plug Kit-Sportster 1971-1985 GOLD	
8730-8	Rocker Shaft Nut & Washer Kit-Sportster 1957-1985	8400-8
8731-8	Rocker Shaft Nut & Washer Kit-Sportster 1957-1985 GOLD	8436-8
	Rocker Shaft Nut & Washer Kit-Sportster 1957-1985 CAD	8401-8
7115-2	Sprocket Cover Screw Kit-Sportster 1957-1970	
7155-4	Sprocket Cover Screw Kit-Sportster 1971-1976	8459-4
7630-3	Sprocket Cover Screw & Nut Kit-Sportster 1977-1985	8472-3
8866-8	Sprocket Cover/Master Cylinder Mounting Kit-883/1100 XL 1986-2003	
2227-4	Sprocket Cover Kit-Sportster 2004-up	
8413-8	Switch Housing Screw Kit-Sportster 1973-1981	8489-8

Show Bike Kits

**Complete Motor Kits
Acorn or Cap Style
In Chrome**

**EVERYTHING IN
ONE PACKAGE!**

**Order ONE Number
Get EVERYTHING
You Need!**



Acorn

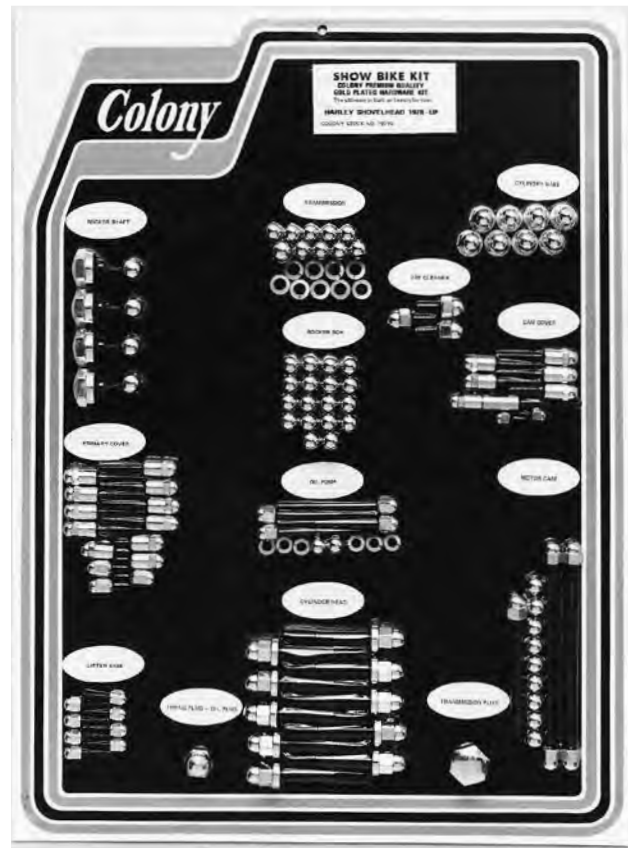

Cap

Stock No.	Description - ACORN
7900	Harley Davidson Sportster XLCH 1957-1964
7901	Harley Davidson Sportster 1965-1970
7902	Harley Davidson Sportster 1971-1973
7903	Harley Davidson Sportster 1974-1976
7904	Harley Davidson Sportster 1977-1985
7919	Harley Davidson Sportster Evolution 1986-1990
7922	Harley Davidson Sportster 1991-1993
7927	Harley Davidson Sportster 1994-2003
7935	Harley Davidson Sportster 2004-up
7905	Harley Davidson Knucklehead 1936-1939
7906	Harley Davidson Knucklehead 1940-1947
7907	Harley Davidson Panhead 1948-1957
7908	Harley Davidson Panhead 1958-1965
7909	Harley Davidson Shovelhead 1966-1969
7910	Harley Davidson Shovelhead 1970-1975
7915	Harley Davidson Shovelhead 1976-1977
7911	Harley Davidson Shovelhead 1978-1984
7916	Harley Davidson Shovelhead FLT 5-Speed 1979-1984
7917	Harley Davidson Evolution 4-Speed 1984-1986
7918	Harley Davidson Evolution 5-Speed 1985-1986
7920	Harley Davidson Evolution Softail 1987-1988
7921	Harley Davidson Evolution Softail 1989-1991, Dyna Glide 1991
7923	Harley Davidson Evolution Softail & DynaGlide 1992-1995
7924	Harley Davidson Evolution Softail 1996-1999 & DynaGlide 1996-1998
7925	Harley Davidson Twin Cam Dyna Models 1999-05
7934	Harley Davidson Twin Cam Dyna Models 2006-up
7928	Harley Davidson Twin Cam Softail Models 2000-06
7933	Harley Davidson Softail Models 2007-up
7929	Harley Davidson FLT, FXR 1987-1991
7930	Harley Davidson FLT, FXR 1992-1995
7931	Harley Davidson FLT 1996-1998
7926	Harley Davidson Twin Cam Touring Models 1999-2006
7932	Harley Davidson Twin Cam Touring Models 2007-2016

Stock No.	Description - CAP
8502	Harley Davidson Sportster 1971-1973
8503	Harley Davidson Sportster 1974-1976
8504	Harley Davidson Sportster 1977-1985
8519	Harley Davidson Sportster Evolution 1986-1990
8522	Harley Davidson Sportster 1991-1993
8505	Harley Davidson Knucklehead 1936-1939
8506	Harley Davidson Knucklehead 1940-1947
8507	Harley Davidson Panhead 1948-1957
8508	Harley Davidson Panhead 1958-1965
8509	Harley Davidson Shovelhead 1966-1969
8510	Harley Davidson Shovelhead 1970-1975
8515	Harley Davidson Shovelhead 1976-1977
8511	Harley Davidson Shovelhead 1978-1984
8516	Harley Davidson Shovelhead FLT 5-Speed 1979-1984
8517	Harley Davidson Evolution 4-Speed 1984-1986
8518	Harley Davidson Evolution 5-Speed 1985-1986
8520	Harley Davidson Evolution Softail 1987-1988
8521	Harley Davidson Evolution Softail 1989-1991, DynaGlide 1991
8523	Harley Davidson Evolution Softail & DynaGlide 1992-1995
8524	Harley Davidson Evolution Softail 1996-1999 & DynaGlide 1996-1998



Knucklehead, Panhead, Shovelhead, Evolution, Twin Cam 88 Chrome Plated Polished, Knurled & Button Head Allen Screw Kits

Description	Knurled Stock No.	Polished Stock No.	Button Head Stock No.
Air Cleaner Mounting Kit-1978-1983 Big Twins	2007-6	2007-6-P	
Dash Screw Kit-FX 1977-1985 Chrome			8775-4
Dash Screw Kit-1986-up FXR Models except 1988-up FXRS			9016-3
Electrical Panel Cover Mounting Kit-1991-up Dyna models	9948-8	9948-8-P	
Fairing Mount Kit-1996-up Harley Models with Batwing Fairing			2849-14
Fender Brace and Fork Mounting Kit-1974-1984 FX, XL			2531-12
Fender Rail Mounting Kit (Rear)-FX 1973-1985	2522-6	2522-6-P	
Fender Rail Mounting Kit (Rear)-FXWG 1980-1985	2527-8	2527-8-P	
Fender Strut Mounting Kit (Rear) - 1986-1999 Softail (4 Hole 59969-86) (6 Hole 59954-86)			2290-14
Fender Strut Mounting Kit (Rear) - 2000-2003 FL, 2000-2002 FX Softail except FX Deuce			2044-26
Fender Strut Mounting Kit - 2003-up FX, 2004-up FL Softail			2876-38
Fork Bracket Cover Screw Kit-FX 1971-90			8757-8
Fork Front and Back Panel Mounting Kit - 1987-up FLSTC, FLSTF, FLSTN			9981-8
Fuel Gauge Housing and Trim Panel Assembly Mounting Kit-1994-up FXD, FXDS-CON and FXDX			9940-9
Fuel Tank Mounting Kit-Big Twins through 1984	2524-2	2524-2-P	
Fuel Tank Mounting Kit-1985-1986 FXWG, FXST, FXSB, FXEF	2530-6	2530-6-P	
Fuel Tank Mounting Kit-FXR 1988-1994	2523-5	2523-5-P	
Fuel Tank Mounting Kit-Softail 1990-1995	2528-10	2528-10-P	
Generator Screws-Panhead & Shovelhead 1958-1969 Chrome	8754-2	8754-2-P	
Handlebar Clamp Screw Kit-FX 1974-1981 Chrome	8795-4	8795-4-P	
Handlebar Clamp Screw Kit-FX, FL, w/out Handlebar Gauges 1982-up Chrome	8796-4	8796-4-P	
Handlebar Clamp and Gauge Mounting Kit-FX 1983-1994	9636-8		
Handlebar Clamp and Gauge Mounting Kit-FX and Sportster 1995-up	9962-6		
Handlebar Lever Mount Screw Kit-FX, FL through 1972	8797-4	8797-4-P	
Handlebar Lever Mount & Master Cylinder Cover Screws-B.T. 1973-1981	8766-10	8766-10-P	
Handlebar Lever Mount & Master Cylinder Cover Screws-FL, XL 1982-1995	8767-10	8767-10-P	
Handlebar Lever Mount & Master Cylinder Cover Screws-1996-up Dyna, Softail, 1996-2007 Touring			9776-10
Handlebar Lever Mount & Master Cylinder Cover Screws-2008-up Touring models			2553-10
Headbolt Screw Kit-Panhead & Shovelhead 1948-up Chrome	8777-20	8777-20-P	
Headlight Visor Mounting Kit-FX 1959-up	9783-4	9783-4-P	
Intake Manifold to Cylinder Head Mounting Kit-Big Twins Late 1982-1989	9930-14	9930-14-P	
Intake Manifold to Cylinder Head Mounting Kit-Big Twins 1990-1994, XL 1988-1994	9931-8	9931-8-P	
Intake Manifold to Cylinder Head Mounting Kit-Big Twins and XL 1995-up	9932-8	9932-8-P	
Instrument Panel Mounting Screw Kit-2006-up Dyna			2346-3
Lifter Base Screw Kit-Big Twin 1936-1976 Chrome			8760-16
Lifter Base Screw Kit-Big Twins 1936-1976 *SPECIAL 1/4-20 THREAD FOR AFTER MARKET CASES*			9828-16
Lifter Base Screw Kit-Big Twin 1976-up Chrome, except Twin Cam 88	8726-8	8726-8-P	
Lifter Base Screw Kit-Pre 1976 Case to Late-Type Lifter Bases Chrome		8727-8	
Lifter Base Screw Kit-1999-up Twin Cam 88 Dyna and Touring, 2000-up Softail	9942-16	9942-16-P	
Master Cylinder Mounting Kit, Rear-FX 1984-1985	2526-4	2526-4-P	
Master Cylinder Allen Screw Kit, Rear, 1982-1994 FXR, 1984-1995 Softail	2109-12	2109-12-P	
Motor Mounting Kit-Big Twins 1970-1984	9926-17	9926-17-P	
Motor Mounting Kit-Softail 1984-1999	9927-28	9927-28-P	
Motor Mounting Kit, Lower, 2000-up Softail		2116-15	
Motor Mounting Kit, Upper-1984-1999 Softail	2854-6	2854-6-P	
Motor Mounting Kit-FLT, FLHT, FXR, FXRS 1988-2006 with rubber mounted motors	9928-20	9928-20-P	
Motor Mounting Kit-Touring 2007-2008	2403-22	2403-22-P	
Motor Mounting Kit-FLT 2009-2016 Touring	2709-24	2709-24-P	
Motor Mounting Kit, Front-1991-up Dyna models	9937-20	9937-20-P	
Motor Case Mounting Kit-1999-up Twin Cam 88 Dyna, 2000-up Softail, 1999-2016 Touring	9956-18	9956-18-P	
Oil Filter Adaptor Screw Kit-Big Twin 1992-up Chrome, except Twin Cam 88	9821-4	9821-4-P	
Oil Filter Adaptor Screw Kit-1999-up Dyna, 1999-2016 Touring	9939-6	9939-6-P	
Oil Hose Cover Mounting Kit-1999-up Dyna, 1999-2016 Touring	9950-6	9950-6-P	
Oil Pan Screw Kit-2006-up Dyna	2344-10	2344-10-P	
Oil Pan Screw Kit-2007-up Touring	2400-12	2400-12-P	
Oil Pump Mounting Kit-OHV Big Twin 1936-1967 Chrome		8745-13	
Oil Pump Mounting Kit-Shovelhead 1968-1977 Chrome		8746-12	
Oil Pump Mounting Kit-Shovelhead & Evolution 1978-1991 Chrome	8747-12	8747-12-P	
Oil Pump Mounting Kit-Softail 1992-1999 Dyna and FLT 1992-1998	9762-16	9762-16-P	
Pinch Bolts, Triple Tree-All FL and Wide Glide	9782-4	9782-4-P	

Knucklehead, Panhead, Shovelhead, Evolution, Twin Cam 88 Chrome Plated Polished, Knurled & Button Head Allen Screw Kits



Description	Knurled Stock No.	Polished Stock No.	Button Head Stock No.
Point Cover Screws--All Harleys 1970-1978 Chrome			8764-2
Point Cover Screws--All Harleys 1979-up Chrome, except Twin Cam 88			8765-2
Point Cover Screws--1999-up Dyna, 2000-up Softail, 1999-2016 Touring			9954-5
Point Cover Screw Kit--2017-up Touring			2219-2
Primary Cover Screw Kit--Big Twin 1936-1964 Chrome	8756-30	8756-30-P	
Primary Cover Screw Kit--1971-up Shovelhead & Evolution 4-Speed	8762-17	8762-17-P	
Primary Cover Screw Kit--1980-1984 Shovelhead & Evolution 5-Speed	8763-20	8763-20-P	
Primary Cover Screw Kit--1985-up FXR, 1985-1999 FLT, 5-Speed, except 1989-up FXST	8916-17	8916-17-P	
Primary Cover Screw Kit-- 2007-up Softail, 2017-up Touring	2470-20	2470-20-P	
Primary Cover Mount Kit-- 1989-2006 Softail and 1991-05 Dyna Glide	8919-19	8919-19-P	
Primary Cover Screw Kit--1999-2006 Twin Cam 88 Touring models	9959-38	9959-38-P	
Primary Cover Screw Kit--2006-up Dyna	2342-18	2342-18-P	
Primary Cover Mounting Kit--2007-2016 Touring	2402-18	2402-18-P	
Rocker Cover Screw Kit--FX, FL 1985-up, except Twin Cam 88	8931-16	8931-16-P	
Rocker Cover Screw Kit-- Buttonhead Allens FX, FL 1985-up, except Twin Cam 88			9788-24
Rocker Cover Screw Kit--1999-up Twin Cam 88 Dyna, 2000-up Softail, 1999-2016 Touring	9944-24	9944-24-P	
Spotlight and Turn Signal Bracket Mount Kit--1996-up, Harley Models with Batwing Fairing			2848-8
Timing Cover Screw Kit--Big Twin 1936-1969 Chrome			8755-12
Timing Cover Screw Kit--Big Twins 1936-1970 *SPECIAL 1/4-20 THREAD FOR AFTER MARKET CASES*			9827-12
Timing Cover Screw Kit--Shovelhead & Evolution 1970-1992 Chrome	8761-7	8761-7-P	
Timing Cover Screw Kit--Big Twins 1993-up Chrome, except Twin Cam 88	9819-12	9819-12-P	
Timing Cover Screw Kit--1999-up Twin Cam 88 Dyna and Touring, 2000-up Softail	9946-20	9946-20-P	
Transmission Mounting Kit--FXST 1986-up			9866-18
Transmission to Motor Mounting Kit--1999-2006 Twin Cam Dyna and Touring, 2000-06 Softail	9935-8	9935-8-P	
Transmission to Motor Mounting Kit--2007-up Twin Cam Dyna FLT, Softail	2468-8	2468-8-P	
Transmission Side Cover Screw Kit--B.T. 4-Speed 1936-1984 Chrome	8820-9	8820-9-P	
Transmission Side Cover Screw Kit--FX, FL 1980-1986 5-Speed	8908-15	8908-15-P	
Transmission Side Cover Screw Kit--FX, FL, Softail 1987-2006, and all 1991-05 Dyna models	8909-13	8909-13-P	
Transmission Side Cover Mounting Kit--2007-up Softail	2474-19	2474-19-P	
Transmission Side Cover Mounting Kit--2007-up Softail	2474-19	2474-19-P	
Transmission Side Cover Screw Kit--2006-up Dyna	2343-13	2343-13-P	
Transmission Side Cover Screw Kit--2007-2016 Touring	2401-15	2401-15-P	
Transmission Side Cover Screw Kit--2017-up Touring	3104-14	3104-14-P	
Transmission Shifter Cover Screw Kit--FX, FL 1980-1986 4-Speed	8905-7	8905-7-P	
Transmission Shifter Cover Screw Kit--FX, FL 1980-1987 5-Speed	8906-5	8906-5-P	
Transmission Shifter Cover & Speedometer Sensor Screw Kit--FXR, FLT, Softail 1988-97	8907-5	8907-5-P	
Transmission Shifter Cover and Speedometer Sensor Screw Kit--1998-06 Softail and FLT 1998-06	9952-11	9952-11-P	
Transmission Shifter Cover Mounting Kit--2007-up Softail	2472-12	2472-12-P	
Transmission Shifter Cover Screw Kit--2007-up Touring	2404-6	2404-6-P	
Transmission Shifter Cover & Speedometer Sensor Screw Kit--Dyna Models 1991-05	9789-17	9789-17-P	
Transmission Shifter Cover Screw Kit--2006-up Dyna	2345-6	2345-6-P	
Transmission Top Cover Screw Kit--Big Twin 1936-1964 Chrome			8750-14
Valve Cover Screw Kit--All Panheads with Aluminum D-Rings Chrome	8736-24	8736-24-P	
Valve Cover Screw Kit--All Panheads with Steel D-Rings Chrome	8737-24	8737-24-P	
Voltage Regulator Mounting Kit -- 2000-up Softail	2046-8	2046-8-P	

Spacers



Chrome Plated Spacers

Chrome plated steel spacers made for a snug fit on 1/4", 5/16", 3/8", 7/16", or 1/2" bolt. Available in individual packs of 5 as listed below.

Stock No. SPC-100 Complete assortment of 1/4", 5/16", and 3/8" spacers, 90 total pieces, as listed below. Includes satchel style tray.



1/4

Stock No.	Size (9/16" OD)
SPC-001	1/4" x 1/8"
SPC-002	1/4" x 1/4"
SPC-003	1/4" x 3/8"
SPC-004	1/4" x 1/2"
SPC-044	1/4" x 5/8"
SPC-005	1/4" x 3/4"
SPC-007	1/4" x 7/8"
SPC-006	1/4" x 1"
SPC-047	1/4" x 1-1/8"
SPC-048	1/4" x 1-1/4"
SPC-049	1/4" x 1-3/8"
SPC-050	1/4" x 1-1/2"

5/16

Stock No.	Size (5/8" OD)
SPC-011	5/16" x 1/8"
SPC-012	5/16" x 1/4"
SPC-013	5/16" x 3/8"
SPC-014	5/16" x 1/2"
SPC-043	5/16" x 5/8"
SPC-015	5/16" x 3/4"
SPC-017	5/16" x 7/8"
SPC-016	5/16" x 1"
SPC-051	5/16" x 1-1/8"
SPC-052	5/16" x 1-1/4"
SPC-053	5/16" x 1-3/8"
SPC-054	5/16" x 1-1/2"

3/8

Stock No.	Size (3/4" OD)
SPC-021	3/8" x 1/8"
SPC-022	3/8" x 1/4"
SPC-023	3/8" x 3/8"
SPC-024	3/8" x 1/2"
SPC-042	3/8" x 5/8"
SPC-025	3/8" x 3/4"
SPC-039	3/8" x 7/8"
SPC-026	3/8" x 1"

7/16

Stock No.	Size (13/16" OD)
SPC-033	7/16" x 1/8"
SPC-034	7/16" x 1/4"
SPC-035	7/16" x 3/8"
SPC-036	7/16" x 1/2"
SPC-045	7/16" x 5/8"
SPC-037	7/16" x 3/4"
SPC-040	7/16" x 7/8"
SPC-038	7/16" x 1"

1/2

Stock No.	Size (15/16" OD)
SPC-027	1/2" x 1/8"
SPC-028	1/2" x 1/4"
SPC-029	1/2" x 3/8"
SPC-030	1/2" x 1/2"
SPC-046	1/2" x 5/8"
SPC-031	1/2" x 3/4"
SPC-041	1/2" x 7/8"
SPC-032	1/2" x 1"

Allen Show Bike Kits

Complete Motor Kits in choice of Chrome Plated Knurled or Polished Styles

These high quality chrome plated allen Show Bike Kits contain everything you need to mount the following: Rocker Box, Primary Cover, Lifter Base, Transmission Covers, Oil Pump, Air Cleaner, Cam Cover, Point Cover, Timing Plug, Motor Mounts (Early XL motor mounts include spacers), Sportster kits also include fasteners for Sprocket Cover, Rear Master Cylinder and Generator. Twin Cam 88 kits also include fasteners for Motor Case & Oil Hose Cover. Button head allens and flat head allens are used where necessary.

Knurled Stock No.	Description	Polished Stock No.
1021	Harley Davidson 2002-2005 VRSCA	1021-P
1023	Harley Davidson Dyna 2006-up	1023-P
1000	Harley Davidson Dyna 1999-05	1000-P
1002	Harley Davidson Dyna Glide 1993-1998	1002-P
1003	Harley Davidson Dyna Glide 1991-1992	1003-P
1025	Harley Davidson Softail 2007-up	1025-P
1018	Harley Davidson Softail 2000-06	1018-P
1004	Harley Davidson Softail 1992-1999	1004-P
1005	Harley Davidson Softail 1989-1991	1005-P
1006	Harley Davidson Softail 1987-1988	1006-P
1007	Harley Davidson Evolution 4-Speed 1984-1986	1007-P
1028	Harley Davidson Touring 2017-up	1028-P
1026	Harley Davidson Touring 2009-2016	1026-P
1024	Harley Davidson Touring 2007-2008	1024-P
1001	Harley Davidson Touring 1999-2006	1001-P
1020	Harley Davidson FLT, FXR 1992-1998	1020-P
1019	Harley Davidson FLT, FXR 1987-1991	1019-P
1008	Harley Davidson Evolution 5-Speed 1985-1986	1008-P
1009	Harley Davidson FLT 5-Speed 1979-1984	1009-P
1010	Harley Davidson Shovelhead 1978-1984	1010-P
1011	Harley Davidson Shovelhead 1976-1977	1011-P
1012	Harley Davidson Shovelhead 1970-1975	1012-P
1022	Harley Davidson Sportster 2004-up	1022-P
1013	Harley Davidson Sportster 1994-2003	1013-P
1014	Harley Davidson Sportster 1991-1993	1014-P
1015	Harley Davidson Sportster 1986-1990	1015-P
1016	Harley Davidson Sportster 1977-1985	1016-P
1017	Harley Davidson Sportster 1971-1976	1017-P



Allen Screw Hole Plugs

Decorative chrome plated hole plugs add a smooth finished look to your screw head.

- Stock No. 2162-300** Assortment tray, contains 100 pcs each of 1/4", 5/16", and 3/8"
- Stock No. 2164-100** 1/4" – bag of 100 pcs
- Stock No. 2165-100** 5/16" – bag of 100 pcs
- Stock No. 2166-100** 3/8" – bag of 100 pcs
- Stock No. 2189-100** 7/16" – bag of 100 pcs





Sportster Chrome Plated Polished, Knurled & Button Head Allen Screw Kits

Description	Knurled Stock No.	Polished Stock No.	Button Head Stock No.
Air Cleaner Cover Mounting Screws–2004-up Sportster			2278-2
Cam Cover Screw Kit–Sportster 1971-1985 Chrome	8783-8	8783-8-P	
Cam Cover Screw Kit–Sportster 1986-2003	9751-11	9751-11-P	
Cam Cover Mount Kit–Sportster 2004-up	2222-11	2222-11-P	
Fender Brace and Fork Mounting Kit- Sportster–1974-1984			2531-12
Fender Mounting Kit- Rear–1957-1978	2529-6	2529-6-P	
Fender Mounting Kit- Front–1984-up Sportster	2271-8	2271-8-P	
Fender Mounting Kit- Rear–2004-up Sportster			2274-10
Fork Bracket Cover Screw Kit–Sportster 1952-90			8757-8
Footpeg Support Bracket Mounting Kit, Left and Right–2004-up Sportster	2269-7	2269-7-P	
Footrest Mounting Kit, Passenger Left and Right–2004-up Sportster	2270-4	2270-4-P	
Fork Bracket Mounting Kit, Lower and Upper–2004-up Sportster			2272-5
Gas Tank Mounting Kit–2004-up Sportster	2266-8	2266-8-P	
Generator Screws–Sportster 1957-1970 Chrome	9757-2	9757-2-P	
Generator Screws–Sportster 1971-1985 Chrome	8787-2	8787-2-P	
Handlebar Clamp Screw Kit–Sportster 1974-1981 Chrome	8795-4	8795-4-P	
Handlebar Clamp Screw Kit–Sportster 1982-up Chrome	8796-4	8796-4-P	
Handlebar Clamp and Gauge Mount Kit–1983-94 XL	9636-8	9636-8-P	
Handlebar Clamp and Gauge Mounting Kit–FX and Sportster 1995-up	9962-6		
Handlebar Lever Mount Screw Kit–Sportster through 1972	8797-4	8797-4-P	
Handlebar Lever Mount & Master Cylinder Cover Screws–Sportster 1973-1981	8766-10	8766-10-P	
Handlebar Lever Mount & Master Cylinder Cover Screws–FL, FX, XL 1982-1995	8767-10	8767-10-P	
Handlebar Lever Mount & Master Cylinder Cover Screws–Buttonhead Allens Sportster 1996-2003			9776-10
Handlebar Lever Mount & Master Cylinder Cover Screws–Sportster 2004-up			2378-10
Headbolt Screw Kit–Sportster 1957-1972	9747-16	9747-16-P	
Headbolt Screw Kit–Sportster 1973-1985	9748-16	9748-16-P	
Headlight Visor Mounting Kit–Sportster 1959-up	9783-4	9783-4-P	
Intake Manifold to Cylinder Head Mounting Kit–Big Twins 1990-1994, XL 1988-1994	9931-8	9931-8-P	
Intake Manifold to Cylinder Head Mounting Kit–Big Twins and XL 1995-up	9932-8	9932-8-P	
Intake Manifold to Cylinder Head Mounting Kit–XL 1986-1987	9933-12	9933-12-P	
Lifter Base Screw Kit–Sportster 1957-1990 Chrome	8782-4	8782-4-P	
Lifter Base Screw Kit–Sportster 1991-1994	9759-4	9759-4-P	
Lifter Base Screw Kit–Sportster 1995-2003	9760-4	9760-4-P	
Lifter Base Screw Kit–Sportster 2004-up	2224-8	2224-8-P	
Motor Case Kit–XL 1957-1976	2067-8		
Motor Case Kit–XL 1997-1990	2068-10		
Motor Case Kit–XL 1991-2003	2075-8		
Motor Case Kit–Sportster 2004-up	2217-8	2217-8-P	
Motor Mount Kit–Sportster 1957-1985	9797-20	9797-20-P	
Motor Mount Kit (Center)–Sportster 1986-1990	2993-8	2993-8-P	
Motor Mount Kit (Center)–Sportster 1992	2994-8	2994-8-P	
Motor Mount Kit (Center)–Sportster 1991, 1993-2003	9771-8	9771-8-P	
Motor Mount Kit (Lower)–Sportster 1986-1998	9772-22	9772-22-P	
Motor Mount Kit (Lower)–Sportster 1999-2003	2667-22	2667-22-P	
Motor Mount Kit (Upper)–Sportster 1986-2003	9793-9	9793-9-P	
Motor Mount Kit–Sportster 2004-up			2228-16
Oil Pump Mounting Kit–Sportster 1954-1976 Chrome	8816-10	8816-10-P	
Oil Pump Mounting Kit–Sportster 1977-1990 Chrome	8817-10	8817-10-P	
Oil Pump Mounting Kit–Sportster 1991-2003	9774-8	9774-8-P	
Oil Filter Adaptor Screw Kit–Sportster 1986-1990	9752-4	9752-4-P	
Point Cover Screws– All Harleys 1970-1978 Chrome			8764-2
Point Cover Screws– All Harleys 1979-2003			8765-2
Point Cover Screws–Sportster 2004-up			2219-2
Tappet Anti-Rotation Screws–Sportster 2000-up		2231-4	

Sportster Chrome Plated Polished, Knurled & Button Head Allen Screw Kits



Description	Knurled Stock No.	Polished Stock No.	Button Head Stock No.
Primary Cover Screw Kit–XLCH 1957-1969 with Stamped Steel Cover	9753-9	9753-9-P	
Primary Cover Screw Kit–Sportster 1971-1976 Chrome	8785-12	8785-12-P	
Primary Cover Screw Kit–Sportster 1977-1985 Chrome	8788-11	8788-11-P	
Primary Cover Screw Kit– Sportster 1986-1990	9749-11	9749-11-P	
Primary Cover Screw Kit– Sportster 1991-1993	9767-15	9767-15-P	
Primary Cover Screw Kit– Sportster 1994-2003	9769-17	9769-17-P	
Primary Cover Screw Kit–Sportster 2004-up	2220-24	2220-24-P	
Rocker Box Screw Kit–Sportster 1957-1976 Chrome	8789-28	8789-28-P	
Rocker Box Screw Kit–Sportster 1977-1985 Chrome	8790-28	8790-28-P	
Rocker Cover Screw Kit–XL 1986-up	8931-16	8931-16-P	
Rocker Cover Screw Kit–Buttonhead Allens XL 1986-up			9788-24
Shifter Rod Link and Lever Mount Kit–2004-up Sportster	2267-4	2267-4-P	
Sprocket Cover Screw Kit–Sportster 1971-1976 Chrome	8784-4	8784-4-P	
Sprocket Cover Screw Kit–Sportster 1977-1985 Chrome	8786-5	8786-5-P	
Sprocket Cover/Master Cylinder Mount Kit–Sportster 1986-2003	9750-6	9750-6-P	
Sprocket Cover Mount Kit–Sportster 2003-up	2226-4	2226-4-P	
Sprocket Cover Screw Kit–Sportster 1971-1976 Chrome	8784-4	8784-4-P	
Sprocket Cover Screw Kit–Sportster 1977-1985 Chrome	8786-5	8786-5-P	
Sprocket Cover/Master Cylinder Mount Kit–Sportster 1986-2003	9750-6	9750-6-P	
Sprocket Cover Mount Kit–Sportster 2003-up	2226-4	2226-4-P	
Tappet Anti-Rotation Screws–2000-up		2231-4	

Oil Pump Plugs-Custom



Oil Pump Relief Valve Plug
Fits 1968-1980 Big Twins.
Replaces OEM 26377-68.
Stock No. 8700-2

Tappet Oil Screen Plug
Fits 1970-1980 Big Twins.
Replaces OEM 657.
Stock No. 8701-2

Oil Pump Check Valve Plug
Fits 1936-1980 Big Twins.
Replaces OEM 26362-36.
Stock No. 8702-2

Tappet Oil Screen, Oil Pump Check Valve, Relief Valve Plug
Fits 1981-up Big Twins.
Replaces OEM 26263-80.
Stock No. 8703-2

Tappet Oil Screen Plug
Fits 1952-1965 Big Twins.
Replaces OEM 24987-52.
Stock No. 8704-2

Tappet Oil Screen Plug
Fits 1966-1969 Big Twins.
Replaces OEM 655.
Stock No. 8705-2



Tappet Oil Screen, Oil Pump Check Valve, Relief Valve Plug Set
Complete set of 3 plugs fit 1970-1980 Big Twins.
Stock No. 8706-6

Tappet Oil Screen, Oil Pump Check Valve, Relief Valve Plug Set
Complete set of 3 plugs fit 1981-up Evolution Big Twins.
Replaces OEM 26263-80.
Stock No. 8707-6



Tappet Oil Screen, Oil Pump Check Valve, Relief Valve Plug
Fits 1981-up Big Twins.
Replaces OEM 26263-80.
Stock No. 2073-2

Allen Style!

Tappet Oil Screen, Oil Pump Check Valve, Relief Valve Plug Set
Complete set of 3 plugs fit 1981-up Big Twins.
Replaces OEM 26263-80.
Stock No. 2074-6

Allen Style!



Tappet Oil Screen, Oil Pump Check Valve, Relief Valve Plug
Fits 1981-up Big Twins.
Replaces OEM 26263-80.
Stock No. 2486-1

Pike Style!

Oil Pump Plugs-OEM



A. Oil Pump Bypass Valve Plug
Fits OHV Big Twins 1936-1952, all UL and 45's 1937-up.
OEM 26367-36.
Stock No. 9526-1 Chrome
Stock No. 9527-1 Cad
Stock No. 9528-1 Parkerized

B. Oil Pump Check Valve Plug
Fits OHV Big Twins 1936-1980, all UL and 45's 1937-up.
OEM 26362-36.
Stock No. 9523-1 Chrome
Stock No. 9524-1 Cad
Stock No. 9525-1 Parkerized

C. Oil Screen Plug
Fits all Big Twin 1952-1965.
OEM 24987-52, plug and OEM 24994, copper gasket.
Stock No. 9603-2 Chrome
Stock No. 9604-2 Cad

D. Oil Pump Relief Valve Plug
Fits Big Twins 1954-1967.
OEM 26377-54, plug and OEM 6581, brass washer.
Stock No. 9605-2 Chrome
Stock No. 9606-2 Cad

E. Oil Pump Relief Valve Plug
Fits Big Twins 1968-1980.
OEM 26377-68, plug and OEM 6581, brass washer.
Stock No. 9607-2 Chrome
Stock No. 9608-2 Cad

F. Oil Screen Plug
Fits 1981-up FL, FX.
OEM 26263-80, with o-ring.
Stock No. 9644-2 Chrome
Stock No. 9645-2 Cad

Oil Pump Check and Relief Valve Plugs
Fits 1981-up FL, FX.
OEM 26263-80, with o-rings. (Same as F. Above)
Stock No. 9634-4 Chrome
Stock No. 9635-4 Cad



Oil Screen Plug
Fits all Big Twin 1966-1969.
OEM 655, plug and OEM 62702-52 brass gasket.
Stock No. 9874-2 Chrome
Stock No. 9875-2 Cad

Oil Screen Plug
Fits all Big Twin 1970-1980.
OEM 657, plug with o-ring.
Stock No. 9876-2 Chrome
Stock No. 9877-2 Cad



Tappet Oil Screen
Stock No. 2146-2
OEM 24981-70 oil screen and OEM 24982-70 spring. Fits all 1970-1999 Big Twins

Stock No. 2284-2
OEM 24983-00 screen and 11301 o-ring. Fits 2000-up Softtail.

Stock No. 2496-2
OEM 24981-66 screen and 24982-66 spring. Fits 1966-1969 Shovelhead.

Oil Pump Plugs/Hardware



Oil Pump Plug Kit

Cadmium plated reproduction of 26423-52A plug, 26374-52 spring and 8866 ball used on 1952-1954 K, KH.

Stock No. 2325-3

Oil Pump Mounting Hardware-Custom



Big Twin 1936-1957 – NUTS ONLY
Stock No. 7100-13 Acorn Style
Stock No. 8439-13 Cap Style



Chrome Allen – Knurled
 (For polished allen screw kits follow knurled stock number with -P or see chart on pages 16-17)

Stock No. 8745-13 OHV Big Twin 1936-1967
Stock No. 8746-12 Big Twin 1968-1977
Stock No. 8747-12 Big Twin 1978-1991
Stock No. 9762-16 Softail 1992-1999, Dyna and FLT 1992-1998
Stock No. 8816-10 Sportster 1954-1976
Stock No. 8817-10 Sportster 1977-1990
Stock No. 9774-8 Sportster 1991-2003



Chrome Acorn Style
Stock No. 7417-13 Big Twin 1968-1977
Stock No. 7827-12 Big Twin 1978-1991
Stock No. 9763-16 Softail 1992-1999, Dyna and FLT 1992-1998
Stock No. 9805-10 Sportster 1954-1976
Stock No. 9806-8 Sportster 1977-1990
Stock No. 9775-8 Sportster 1991-2003



Chrome Cap Style
Stock No. 8469-13 Big Twin 1968-1977
Stock No. 8477-12 Big Twin 1978-1991
Stock No. 9764-16 Softail 1992-1999, Dyna and FLT 1992-

Oil Pump Mounting Hardware-OEM



Oil Pump Nut Kit
 This 6-pack of hard to find 1/4-24 hex nuts will fit the oil pump on pre-1968 Harleys. This special size nut also has many miscellaneous applications throughout the early models.

Stock No. 8110-12 Chrome Plated
Stock No. 8111-12 Cad Plated
Stock No. 9673-12 Parkerized



Oil Pump Nut
 Exact reproduction of oil pump nut with 1/4-24 thread used on pre-1968 Harley Davidson.

Stock No. 8108-1 Chrome Plated 1936-1967 OHV (Long)
Stock No. 8109-1 Cad Plated 1936-1967 OHV
Stock No. 9674-1 Parkerized 1936-1967 OHV
Stock No. 8719-1 Chrome Plated 1941-1948 (Short)
 74 & 80 S.V., 1941-1954 45's

Stock No. 8721-1 Cad Plated 1941-1948
 74 & 80 S.V., 1941-1954 45's

Stock No. 9631-1 Parkerized 1941-1948



Stock OEM Style
Stock No. 8740-19 OHV Big Twin 1936-1967 Chrome (Shown)
Stock No. 8741-19 OHV Big Twin 1936-1967 Cad
Stock No. 9694-19 OHV Big Twin 1936-1967 Parkerized
Stock No. 8742-14 Big Twin 1968-1977 Chrome
Stock No. 8743-14 Big Twin 1968-1977 Cad
Stock No. 8744-12 Big Twin 1978-1991 Chrome
Stock No. 9787-12 Big Twin 1978-1991 Zinc
Stock No. 8814-15 Sportster 1952-Early 1971 Chrome
Stock No. 8815-15 Sportster 1952-Early 1971 Cad
Stock No. 9614-10 Sportster Late 1971-1976 Chrome
Stock No. 9615-10 Sportster Late 1971-1976 Cad
Stock No. 9408-22 HD 45's 1937-1973 Chrome
Stock No. 9409-22 HD 45's 1937-1973 Cad
Stock No. 9663-22 HD 45's 1937-1973 Parkerized

45'S Oil Pump Mounting Hardware
 now includes all studs.

Cylinder Base Nuts



- A. Big Twin 1930-1977 Chrome Acorn
Stock No. 7017-16
- B. Sportster 1957-1985 Chrome Acorn
Stock No. 7018-16
- C. Big Twin 1978-1984 Chrome Milled Hex Acorn
Stock No. 7813-8
- D. Sportster 1957-1985 XLR Type
Stock No. 7623-8 Chrome
Stock No. 7624-8 Black Oxide

Big Twin Pre-Evolution Big Bore
Stock No. 8600-8 Chrome
Stock No. 8601-8 Black Oxide
- E. Big Twin 1930-1977 Chrome Cap
Stock No. 8437-16
- F. Sportster 1957-1985 Chrome Cap
Stock No. 8438-16
- G. Big Twin 1978-1984 Chrome Milled Hex Cap
Stock No. 8474-8
- H. Big Twin 1930-1978 Stock
Stock No. 8104-16 Chrome
Stock No. 8105-16 Cad
Stock No. 9623-16 Parkerized

Sportster and 45's Stock
Stock No. 8106-16 Chrome
Stock No. 8107-16 Cad
Stock No. 9624-16 Parkerized

7/16 Lockwashers 8 per pack OEM
P/N 7055
Stock No. 9715-8 Chrome
Stock No. 8171-8 Cad
Stock No. 9716-8 Parkerized
- I. 80 cu. in. Shovelhead 1978-1984
Stock OEM 16838-78
Stock No. 9100-8 Chrome
Stock No. 9101-8 Zinc
Stock No. 9102-8 Black Oxide
- J. Cylinder Base Stud Spacer
Shovelhead 1978-1984
OEM 16836-78
Stock No. 8860-8 Chrome
Stock No. 8861-8 Black Oxide
- K. Big Twin 1978-1984 Chrome Milled Hex Pike
Stock No. 2419-8

Cylinder Studs



Cylinder Base Stud Set

These heat treated studs with interference threads are equal to or better than the original Harley part and are available for the following:

- Stock No. 8856-8** 1930-77 Big Twins. OEM 16831-30
- Stock No. 8857-8** 1978-84 Big Twins. OEM 16837-78
- Stock No. 8858-8** 1954-85 K, XL OEM 16830-54, 16830-72
- Stock No. 2367-8** 1929-57 45's, OEM 16830-29



Cylinder Base Stud Set

OEM style heat treated alloy steel studs equal or surpass original equipment.

- Stock No. 9424-8** 1985-99 Big Twin Evolution
OEM 16837-85C
- Stock No. 9507-8** 1986-up Evolution XL
OEM 16832-86C
- Stock No. 2083-8** 1999-up Twin Cam 88
OEM 16834-99

Hi-Performance Cylinder Base Stud Kit

High tensile aircraft quality studs fit 1983-1998 Big Twin Evolution.

Stock No. 2442-8



Intake Manifolds

"Rubber Band" Type Intake Manifold Conversion Kit for 1940-1954 Knucklehead and Panhead

Here is a complete conversion kit that will eliminate those troublesome intake manifold leaks common to Knucklehead and Panheads with worn and distorted "plumber" style manifold components.

Stock No. 7314-9

Complete Kit

One Kit Contains:

- 1 Cast Almag Manifold
- 2 Conversion Nipples
- 2 Nipple to Cylinder Head Seals
- 2 Nipple to Manifold Seals
- 2 Rivets
- 4 Carburetor Mounting Screws

Stock No. 7315-3

Manifold Only, 1955-1965 Panhead

Stock No. 7344-6

Steel Conversion Nipple Kit Only, 1940-54 O.H.V. 74

Stock No. 7627-4

Aluminum Weld-in Nipple Kit Only, 1948-1954 Panhead

Stock No. 8004-4

Steel Conversion Nipple Kit Only, 1936-39 Knucklehead w/Small Port Heads



Manifold Inlet Nipple Rivet

Parkerized duplicate of OEM 27045-32 rivet used on 1937-1947 61", 74", 80" Big Twins, Sidevalves and 1952-1956 K, KH. Pack of 10 pieces.

Stock No. 2636-10



Intake Manifold Nipple Repair Kit

Cadmium plated OEM 27049-52 screw, 27048-52 nut and 512 cotter pin. Used to replace rivets.

Stock No. 2230-6



Intake Manifold Nuts

Precision machined duplicates of original Harley part. These manifold nuts are guaranteed to fit and seal properly. Now available for the following Harley Davidson engines:

1940-54 O.H.V. 74's, 61's, 1953-1956 K, KH

Stock No. 7103-2

Chrome Plated

Stock No. 7614-4

Cad Plated

Stock No. 9718-4

Parkerized

1930-48 74 and 80 Flathead; 1936-39 61 O.H.V.; 1940-46 WLD, 1930-1936 VL

Stock No. 8012-2

Chrome Plated

Stock No. 8007-2

Cad Plated

Stock No. 9702-2

Parkerized

1937-73 Harley '45'

Stock No. 8227-2

Chrome Plated

Stock No. 8228-2

Cad Plated

Stock No. 9703-2

Parkerized



Intake Manifold Seals

Precision machined brass seals are duplicates of the original Harley part. Now available for the following Harley Davidson engines:

Stock No. 7104-2

1940-54 O.H.V. 74's, 61's, 1953-56 K, KH

Stock No. 2905-2

Undersized (ID 1.694/1.696") 1940-54 O.H.V.

74's, 61's, 1953-56 K, KH

Stock No. 7356-2

Harley '45's

Stock No. 8006-2

1930-48 All Sidevalves except 45's, also 1936-39 61 Knucklehead, 1930-1936 VL

Intake Manifolds



Intake Manifold Nipple and Rivet Installation Tool

Tools used to install manifold nipple and rivet on all OHV 74's 1940-1954 and 1953-1956 K, KH.

Stock No. 2763-5



Intake Manifold Nipple

Threaded steel nipple is exact duplicate of original Harley part.

Stock No. 7119-2 All O.H.V. 74's 1940-54,
1953-1956 K, KH—SHOWN

Stock No. 9422-1 Harley 45's 1937-1973

Stock No. 9423-1 74 & 80 Sidevalve 1930-1948

Stock No. 9513-1 61 O.H.V. 1936-1939

Oversized Nipple

1-13/16-20 thread, to repair those damaged threads on 1940-54 OHV 74's, 1953-56 K, KH.

Stock No. 2995-1

Replacement Hardware



Exhaust Pipe Nipple and Nut

Nickel Plated, accurately reproduced nuts and nipples fit the following:
Stock No. 9209-1 Harley 74 & 61, 1924-29, OEM 1012-25 Nipple.
Stock No. 9210-1 Harley 74, 1921-24 and 61 & 74, 1925-29, OEM 1014-21 Nut.



Front Wheel Stabilizer Collar Stud Kit

Reproduction of OEM 44350-30 studs, nuts, and lockwashers used on 1930-1952 45 Solo and 1932-1940 Servi-car.
Stock No. 2599-6



Chain Housing Cover Cap

Reproduction of OEM 60564-65 chain housing cover cap used on 1965-early 1966 FL, FLH.
Stock No. 2640-1

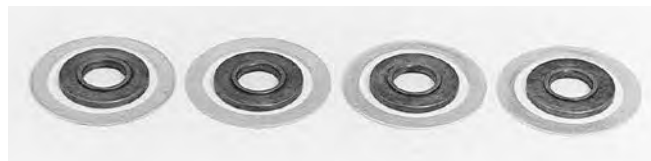

Rocker Arm Thrust Washer

Precision machined, heat treated duplicate of original Harley Davidson part used on 1936-47 Knucklehead engines, OEM 119-36 and Packing Washer, OEM 123-36.
Stock No. 7605-4

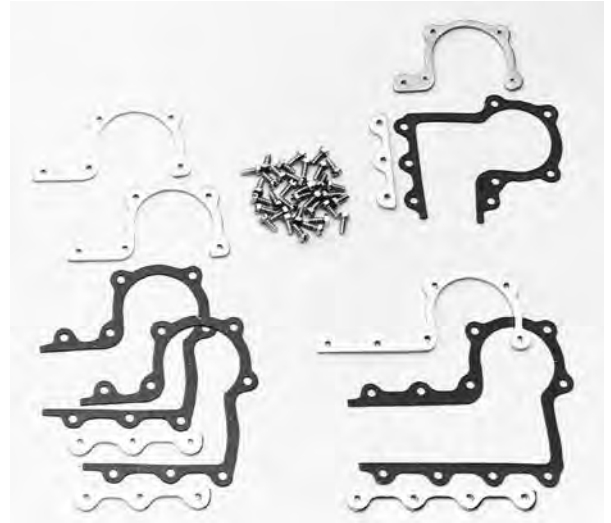

Knucklehead Rocker Cover Nut Strips

This kit includes all 8 strips, 4 gaskets, and 34 screws. All holes are tapped for easy assembly. Parkerized.

Stock No. 7517-8 All Knucklehead 1939-1947
Stock No. 3282-4 Gasket Set Only



Rocker Arm Cover Screw Kit

Reproduction of screws used on 1938-1947 Knucklehead. 34 pieces.

Stock No. 2955-34 1938 61" OHV (Fillister Head Slotted)

Stock No. 3023-34 1939-1947 Chrome (Hex Head)

Stock No. 3024-34 1939-1947 Cadmium (Hex Head)

Stock No. 3025-34 1939-1947 Parkerized (Hex Head)

Rocker Box Nuts/Bolts



Chrome Plated Rocker Box Cap Nut Kit
 Chrome plated rocker shaft nuts and washers, plus rocker box cap nuts add a fresh new detailed look to all Shovelhead engines 1966-1984.
Stock No. 8449-22



Chrome Plated Rocker Shaft End Plugs
 These chrome plated rocker arm shaft end plugs will add that classic Knucklehead look to any Sportster or Shovelhead engine. Installation or removal is much easier than original slotted Harley part. Packaged 4 per set.
Stock No. 7142-4 Fits Sportster & Shovelhead 1971-1984
Stock No. 7143-4 Fits Sportster 1957-1970 & Shovelhead 1966-1970



Rocker Shaft End Nut Kit
 Cap style end nuts and washers will replace the "Red Dot" nuts found on all Shovelhead 1966-1984 and Sportster 1957-1985.
Stock No. 8400-8 Chrome Plated
Stock No. 8401-8 Cad Plated

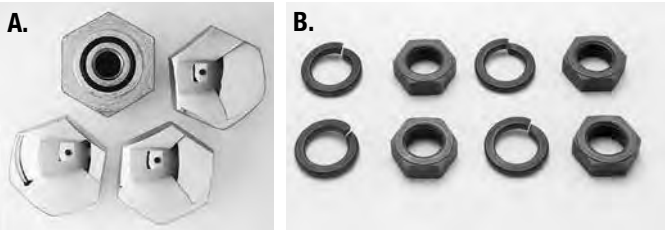

A. Knuckle Nut Set
 Duplicate of original Harley part except for the addition of a positive "O" ring seal to prevent oil leakage. Contains 4 nuts and 4 seals. Fits all Knucklehead engines 1936-1947.
Stock No. 7110-8

B. Rocker Shaft End Nut Kit
 OEM 7831 nuts and lockwashers fit 1936-1947 Knucklehead.
Stock No. 9840-8 Chrome Plated
Stock No. 9841-8 Cad Plated
Stock No. 9842-8 Parkerized



Rocker Shaft End Nut Kit
 Acorn style end nuts and washers will replace the "Red Dot" nuts found on all Shovelhead 1966-1984 and Sportster 1957-1985.
Stock No. 8730-8 Chrome Plated



Knuckle Nut Set
 Duplicate of original style 114-36 nuts and 469-15 washers used on 1936-1947 Knucklehead.
Stock No. 3189-4 Chrome Plated
Stock No. 3190-4 Cad Plated
Stock No. 3191-4 Parkerized



Rocker Box Mounting Kit
 Stock replacement hex head bolts machined from solid bar as original in choice of plating. Fits Knucklehead 1936-1947.
Stock No. 8778-12 Chrome Plated
Stock No. 8779-12 Cad Plated, Machined, Plain Head
Stock No. 9699-12 Parkerized, Machined, Plain Head
Stock No. 3286-12 Parkerized, CP1035

Rocker Box Nuts/Bolts

Rocker Box Stud Kit

High quality studs used to mount rocker box on 1966-1984 Shovelheads. Replaces OEM 17506-66 (long stud), OEM 17508-66 (short stud), and 16864-48 (motor stud). Package of 11 studs cover 1 cylinder only.
Stock No. 2322-11



Rocker Shaft End Caps

Colony designed end caps provide ease of installation, ample clearance between gas tank, and a custom touch for all Shovelhead 1971-up and Sportster 1971-1984.

Stock No. 8614-4 Chrome Plated
Stock No. 8615-4 Cad Plated
Stock No. 8616-4 Black Oxide



Rocker Box Nut Kit

Plated hex nuts and flatwashers add a clean, detailed, stock look to all Shovelhead Harley Davidson 1966-1984.

Stock No. 8608-36 Chrome Plated
Stock No. 8609-36 Cad Plated



Rocker Box Bolt Kit

Stock replacement hex head bolts and washers fit all Sportster 1957-1985.

Stock No. 9829-28 Chrome, 1957-1976
Stock No. 9830-28 Cad, 1957-1976 (Plain Head)
Stock No. 3207-28 Cad, 1957-1976 (CP 1038)
Stock No. 3208-28 Cad, 1977-1985 (CP 1038)
Stock No. 9831-28 Chrome, 1977-1985
Stock No. 9832-28 Cad, 1977-1985 (Plain Head)



Rocker Box Nut Kit

Chrome plated acorn nuts fit rocker boxes and rocker arm shafts. Kit includes rocker arm shaft washers. Fits all Shovelhead 1966-1984.

Stock No. 7137-22



Rocker Box Bolt Kit or Cap

Chrome plated acorn style bolts fit rocker boxes all Sportster 1957-1985.

Stock No. 7136-14 1957-1976 Acorn Style
Stock No. 7629-14 1977-1985 Acorn Style
Stock No. 8448-14 1957-1976 Cap Style
Stock No. 8471-14 1977-1985 Cap Style



Rocker Shaft End Cap and Nut Kit

Nice reproduction of original style end caps in choice of plating for Sportster and Shovelhead.

Stock No. 8222-8 1957-70 Chrome Plated (Slotted)
Stock No. 8223-8 1957-70 Cad Plated (Slotted)
Stock No. 8224-8 1971-84 Chrome Plated (Allen)
Stock No. 8225-8 1971-84 Cad Plated (Allen)

SPECIAL Rocker Shaft End Cap and Nut Kit

Early style slotted head and late style 1/2-20 threads to be used on 1957-1970 Shovelhead and Sportster with late style rocker shaft.

Stock No. 2019-8 Chrome Plated
Stock No. 2020-8 Cad Plated



Rocker Box Bolt Kit

Chrome plated allen style bolts fit rocker boxes all Sportster 1957-1985.

Stock No. 8789-28 1957-1976 Knurled
Stock No. 8790-28 1977-1985 Knurled
Stock No. 8789-28-P 1957-1976 Polished
Stock No. 8790-28-P 1977-1985 Polished



Rocker Arm Shaft Washers and O-Rings Kit

Replacement washers, OEM 17450-73, 6466 and o-rings 11101 used on 1966-1984 Shovelhead, 1957-1984 Sportster.

Stock No. 2233-12

Rocker Box Nuts/Bolts



Rocker Cover Screw Kit

Chrome plated 12 point screw, washers, and gaskets mount rocker covers on 1985-up FL, FX, and 1986-up XL.

Stock No. 2280-16



Custom Rocker Cover Screw Kit

Chrome plated flat head allen screws, custom low profile companion countersunk washers and gaskets mount rocker covers on 1985-up FL, FX and 1986-up XL, except Twin Cam 88.

Stock No. 9833-24



Lower Rocker Box Mounting Kit

Stock replacement hardware for mounting both lower rocker boxes on Evolution Big Twins and Sportsters.

Stock No. 2078-18

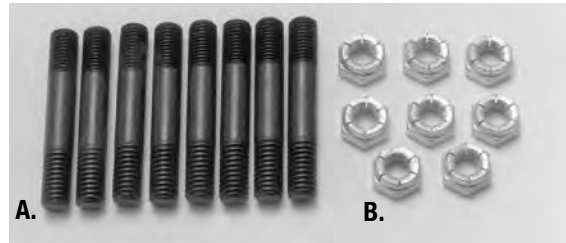

Rocker Arm Stud and Nut Kits

A. High quality studs with interference threads are duplicate of OEM 17647-48. Fits 1948-1965 Panhead. Package of 8 studs cover 1 cylinder head.

Stock No. 9917-8 Parkerized

B. Aircraft quality flexloc nuts are exact duplicate of OEM 7727. Fits 1948-1965 Panhead. Package of 8 flexloc nuts cover 1 cylinder head.

Stock No. 9918-8 Cad Plated



Rocker Arm Cover to Frame Bracket Stud Kit

Reproduction of OEM 3412 studs and hardware used on 1978-1985 XL, XLCH, XLX, 1981-1985 XLS and 1978 XLCH. Contains 2 studs and hardware.

Stock No. 2308-2

Lifter Base Screws

Chrome Acorn Style

Stock No.

- 7131-8** OHV Big Twin 1936-1975
7628-8 Big Twin 1976-up, except Twin Cam 88
9941-24 Twin Cam 88 Dyna & FLT models 1999-up, Softail 2000-up
8480-8 Late Lifter Bases to Pre-1976 Cases 1/4-24 Thread
7139-4 Sportster 1957-1985
8867-4 Sportster 1986-1990
9765-4 Sportster 1991-1994
9766-4 Sportster 1995-2003



Chrome Cap Style

Stock No.

- 8447-8** OHV Big Twin 1936-1975
8470-8 Big Twin 1976-up, except Twin Cam 88
8490-8 Late Lifter Bases to Pre-1976 Cases 1/4-24 Thread
8450-4 Sportster 1957-1985



Chrome Allen Style - Knurled

(For polished allen screw kits follow knurled stock number with -P or see chart on pages 19-22)

Stock No.

- 8760-16** Big Twin 1936-1976 (Button)
9828-16 Big Twin 1936-1976 (Button), Special 1/4-20 threads for after market cases
8726-8 Big Twin 1976-up, except Twin Cam 88
9942-16 Twin Cam 88 Dyna & FLT models 1999-up, Softail 2000-up
8727-8 Late Lifter Bases to Pre-1976 Cases 1/4-24 Thread
8782-4 Sportster 1957-1990
9759-4 Sportster 1991-1994
9760-4 Sportster 1995-2003
2224-8 Sportster 2004-up



Stock OEM Style

Stock No.

- 8102-16** Big Twins 1936-1953, HD 45's 1937-1973 Chrome (slotted)
8103-16 Big Twins 1936-1953, HD 45's 1937-1973 Cad (slotted)
9622-16 Big Twins 1936-1953, HD 45's 1937-1973 Parkerized (slotted)
2099-16 Big Twins 1950-1953, 1952-1956 K Models Chrome (Phillips)
2100-16 Big Twins 1950-1953, 1952-1956 K Models Cad (Phillips)
9814-16 Big Twins 1936-1953, Chrome, with 1/4-20 thread for after market cases
9815-16 Big Twins 1936-1953, Cad, with 1/4-20 thread for after market cases
9816-16 Big Twins 1936-1953, Parkerized, with 1/4-20 thread for after market cases
8604-16 Big Twin 1954-1975 Chrome
8605-16 Big Twin 1954-1975 Cad
2364-16 Big Twin 1954-1975 Chrome with 1/4-20 thread for after market cases
2365-16 Big Twin 1954-1975 Cad with 1/4-20 thread for after market cases
9845-4 Sportster 1957-1985 Chrome
9846-4 Sportster 1957-1985 Cad (Plain Head)
3209-4 Sportster 1957-1985 Cad (CP1038)



12 Point Style

Stock No.

- 8708-8** Big Twins 1976-up Chrome 1/4-20
8709-8 Big Twins 1976-up Cad 1/4-20
8710-8 Big Twins 1976-up Black 1/4-20
8711-8 Late Lifter Bases to Pre-1976 Cases Chrome 1/4-24
8712-8 Late Lifter Bases to Pre-1976 Cases Cad 1/4-24
8713-8 Late Lifter Bases to Pre-1976 Cases Black 1/4-24



Primary Cover Screw Kits



Chrome Acorn Style

Stock No.

- 7414-20** Use on Stamped Steel Inner & Outer Big Twins 1936-1969
7146-12 Big Twins 1965-1970 with Cast Aluminum Cover
7350-15 Big Twins 1971-up 4-Speed
7304-16 Big Twins 1965-1979 with Accessory-Type Pressed Metal Primary Cover
8481-20 All Big Twins with 5-Speed 1980-1984
8914-17 1985-up FXR, 1985-1999 FLT with 5-Speed except 1989-up FXST
8917-19 1989-up Softail and 1991-up Dyna Glide
9958-19 Twin Cam 88 FLT models 1999-up
7117-16 Stamped Steel Cover Sportster 1957-1969
7116-14 XLH 1967-1970, XLCH 1970
7149-11 Sportster 1971-1976
7631-11 Sportster 1977-1985
8869-13 883/1100 XL 1986-1990
9768-15 Sportster 1991-1993
9770-17 Sportster 1994-2003

Chrome Cap Style

Stock No.

- 8468-20** Use on Stamped Steel Inner & Outer Big Twins 1936-1969
8452-12 Big Twins 1965-1970 with Cast Aluminum Cover
8464-15 Big Twins 1971-up 4-Speed
8463-16 Big Twins 1965-1979 with Accessory-Type Pressed Metal Primary Cover
8482-20 All Big Twins with 5-Speed 1980-1984
8915-17 Big Twins 1985-up with 5-Speed except 1989 FXST
8918-19 1989-up Softail & 1991-up Dyna Glide
8453-11 Sportster 1971-1976
8473-11 Sportster 1977-1985

Chrome Allen Style - Knurled

Stock No.

- (For polished allen screw kits follow knurled stock number with -P or see chart on pages 19-22)
8756-30 Big Twins 1936-1964
8762-17 Shovelhead & Evolution 4-Speed 1971-up
8763-20 Shovelhead & Evolution 5-Speed 1980-84
8916-17 1985-up FXR, 1985-1999 FLT 5-Speed, except 1989-up FXST
8919-19 1989-up Softail & 1991-up Dyna Glide
9959-38 Twin Cam 88 FLT models 1999-up
9753-9 XLCH 1957-1969 with Stamped Steel Cover

Chrome Allen Style Continued

Stock No.

- 8785-12** Sportster 1971-1976
8788-11 Sportster 1977-1985
9749-11 Sportster 1986-1990
9767-15 Sportster 1991-1993
9769-17 Sportster 1994-2003

Stock OEM Style

Stock No.

- 8155-30** Big Twins 1936-1964 (Slotted) Chrome
8156-30 Big Twins 1936-1964 (Slotted) Cad
9724-30 Big Twins 1936-1964 (Slotted) Parkerized
3067-30 Big Twins 1936-1964 (Phillips) Parkerized
3068-30 Big Twins 1936-1964 (Phillips) Cad
8799-12 Big Twins 1965-1969 (Slotted) Chrome
8800-12 Big Twins 1965-1969 (Slotted) Cad
9307-17 Shovelhead 1970-1980 Chrome
9308-17 Shovelhead 1970-1980 Cad
9852-5 "K" Models 1952-1956 Chrome
9853-5 "K" Models 1952-1956 Cad
9850-5 XL, XLH 1957-1966 Chrome
9851-5 XL, XLH 1957-1966 Cad
8890-20 XLCH 1957-1969 Chrome
8891-20 XLCH 1957-1969 Cad
8892-12 XLH 1967-1970, XLCH 1970 Chrome
8893-12 XLH 1967-1970, XLCH 1970 Cad
2063-14 XL 1971-1976 Chrome
2064-14 XL 1971-1976 Cad
2065-13 XL 1977-1980 Chrome
2066-13 XL 1977-1980 Cad

Cam Cover Screws



Chrome Cap Style

Stock No.

- 8445-12** Big Twins 1936-1969
- 8466-7** Big Twins 1970-1992
- 8454-8** Sportster 1971-1985

Chrome Allen Style - Knurled

Stock No.

(For polished allen screw kits follow knurled stock number with -P or see chart on pages 19-22)

- 8755-12** Big Twins 1936-1969
- 8761-7** Shovelhead & Evolution 1970-1992
- 9819-12** Big Twins 1993-up, except Twin Cam 88
- 9946-20** Twin Cam 88 Dyna & FLT models 1999-up, Softail 2000-up
- 8783-8** Sportster 1971-1985
- 9751-11** Sportster 1986-2003
- 2222-11** Sportster 2004-up

Stock OEM Style

Stock No

- 8149-12** Big Twins 1936-1969 Chrome (slotted)
- 8150-12** Big Twins 1936-1969 Cad (slotted)
- 9621-12** Big Twins 1936-1969 Parkerized (slotted)
- 2101-12** Big Twins 1950-1952 Chrome (Phillips)
- 2102-12** Big Twins 1950-1952 Cad (Phillips)
- 9794-12** Big Twins 1936-1969 Chrome Special 1/4-20 thread for aftermarket cases
- 9795-12** Big Twins 1936-1969 Cad Special 1/4-20 thread for aftermarket cases
- 9796-12** Big Twins 1936-1969 Parkerized Special 1/4-20 thread for aftermarket cases
- 9305-7** Shovelhead 1970-1980 Chrome
- 9306-7** Shovelhead 1970-1980 Cad
- 9412-19** HD 45's 1937-1973 Chrome
- 9413-19** HD 45's 1937-1973 Cad
- 9668-19** HD 45's 1937-1973 Parkerized
- 8894-9** K, KH, XL, XLCH, XLH 1952-1970 Chrome
- 8895-9** K, KH, XL, XLCH, XLH 1952-1970 Cad
- 2061-8** XL 1971-1980 Chrome
- 2062-8** XL 1971-1980 Cad

Chrome Acorn Style

Stock No.

- 7129-12** Big Twins 1936-1969
- 7402-7** Big Twins 1970-1992
- 9820-6** Big Twins 1993-up, except Twin Cam 88
- 9945-20** Twin Cam 88 Dyna & FLT models 1999-up, Softail 2000-up
- 7118-9** Sportster 1957-1970
- 7150-8** Sportster 1971-1985
- 8865-11** 883/1100 XL 1986-2003

Sprocket Cover Screws



Chrome Cap Style

Stock No.

- 8459-4** Sportster 1971-1976
- 8472-3** Sportster 1977-1985

Chrome Allen Style - Knurled

(For polished allen screw kits follow knurled stock number with -P or see chart on pages 19-22)

Stock No.

- 8784-4** Sportster 1971-1976
- 8786-5** Sportster 1977-1985
- 9750-6** Sportster 1986-2003
- 2226-4** Sportster 2004-up

Stock OEM Style

Stock No.

- 8882-2** K Model 1952-1953 Chrome
- 8883-2** K Model 1952-1953 Cad
- 8884-2** XL 1954-1970 Chrome
- 8885-2** XL 1954-1970 Cad
- 8886-2** XL 1952-1970 w/Ex. Clamp Mount Chrome
- 8887-2** XL 1952-1970 w/Ex. Clamp Mount Cad
- 8888-2** XL 1971-1976 Chrome
- 8889-2** XL 1971-1976 Cad
- 2059-5** XL 1977-1980 Chrome
- 2060-5** XL 1977-1980 Cad

Chrome Acorn Style

Stock No.

- 7115-2** Sportster 1957-1970
- 7155-4** Sportster 1971-1976
- 7630-3** Sportster 1977-1985
- 8866-8** 883/1100 XL 1986-2003

Generator Screws



Chrome Acorn Style

Stock No.

- 7114-2** Big Twins 1936-1957
- 7113-2** Big Twins 1958-1969
- 7130-2** Sportster 1957-1970
- 7154-2** Sportster 1971-1985

Chrome Cap Style

Stock No.

- 8444-2** Big Twins 1936-1957
- 8443-2** Big Twins 1958-1969
- 8458-2** Sportster 1971-1985

Chrome Allen Style - Knurled

(For polished allen screw kits follow knurled stock number with -P or see chart on pages 19-22)

Stock No.

- 8754-2** Panhead and Shovelhead 1958-1969
- 9757-2** Sportster 1957-1970
- 8787-2** Sportster 1971-1985

Stock OEM Style—Continued

Stock No.

- 2977-2** VL 1930-1936
- 9108-2** Big Twin S.V. 1930-1948 Chrome
- 9109-2** Big Twin S.V. 1930-1948 Cad
- 9678-2** Big Twin S.V. 1930-1948 Parkerized
- 8151-2** Big Twins 1936-1957 Chrome (slotted)
- 8152-2** Big Twins 1936-1957 Cad (slotted)
- 9679-2** Big Twins 1936-1957 Parkerized (slotted)
- 2097-2** Big Twins 1950-1954 Chrome (Phillips)
- 2098-2** Big Twins 1950-1954 Cad (Phillips)
- 8153-2** Big Twins 1958-1969 Chrome
- 8154-2** Big Twins 1958-1969 Cad
- 8207-2** HD 45's 1932-1957 Chrome
- 8208-2** HD 45's 1932-1957 Cad
- 9712-2** HD 45's 1932-1957 Parkerized
- 8209-2** HD 45's 1958-1973 Chrome
- 8210-2** HD 45's 1958-1973 Cad
- 8877-2** K, XL 1952-1970 Chrome
- 8878-2** K, XL 1952-1970 Cad
- 9880-2** XL 1971-1985 Chrome
- 9881-2** XL 1971-1985 Zinc



Generator Screw Kit, Special

OEM head style generator screws to install 3 brush generators with 1/4-24 threads to cases that have been drilled out for 5/16" bolts. 1936-57 Big Twins.

Stock No.

- 2990-2** Cad
- 2991-2** Parkerized

Nuts, Locks, Tools—Motor Shafts

Crank Pin Nuts

Exact duplicate of original equipment.

Stock No. 2911-2

1915-1936 All Twins. Replaces OEM 365-15, 13/16-18" thread.

Stock No. 2906-2

1936-1940 61" OHV and 1937-1940 74", 80" SV. Replaces OEM 23966-36 (Flange style), 7/8-18" thread.

Stock No. 7109-2

1941-1952 61" OHV and 1941-1948 74", 80" SV. Replaces OEM 23966-36, 2 nuts per kit (Hex style), 7/8-18" thread.

Stock No. 2376-1

1937-1973 45's. Replaces OEM 364-37 (8010). 1 nut per kit, 11/16-18" thread.

Stock No. 2411-2

1941-1953 74" Big Twins. Replaces OEM 23967-41. 2 nuts per kit, 1-18" thread.

Stock No. 2412-2

1954-early 1981 Big Twins. Replaces OEM 23966-54. 2 nuts per kit, 1-18" thread.

Stock No. 2569-2

1954-early 1981 KH, Sportster. Replaces OEM 23967-54A. 2 nuts per kit, 1-20" thread.

Stock No. 2570-2

Late 1981-1999 Sportster. Replaces OEM 23901-81. 2 nuts per kit, 1-20" thread.

Stock No. 2571-2

Late 1983-1999 Big Twins. Replaces OEM 23969-83. 2 nuts per kit, 1-20" thread.



Crank Pin Nut Lock Plates

Set of 2 lock plates and mount screws.

Stock No. 3085-4

1912-1929 Pocket Valves, 1930-1934 Singles and 1929-1973 45's. Replaces OEM 368-12.

Stock No. 2901-4

1936-1940 Big Twins. Replaces OEM 23970-36.

Stock No. 2412-6

1941-1953 Big Twins, 1957-1980 XL. Replaces OEM 23971-41.

Stock No. 2413-6

1954-early 1980 Big Twins. Replaces OEM 23971-54.



Pinion and Sprocket Shaft Lock Plates

Set of 2 lock plates and screws. 1936-1971

Big Twins pinion and sprocket shaft. 1972-1980 Big Twins and 1957-1980 XL pinion only.

OEM 24015-36.

Stock No. 2384-4

Original replacement style.

Flywheel Side—Sprocket Shaft Nuts

Stock No. 2286-1

Big Twins 1936-71. Replaces OEM 24023-36, 3/4-18" thread.

Stock No. 2288-1

Big Twins 1972-early 1985. Replaces OEM 24017-72/24017-80, 1-1/8-16" thread.



Sprocket Side—Sprocket Shaft Nuts

Stock No. 2539-1

1930-1936 VL. Replaces OEM 364-30, 3/4-18" thread.

Stock No. 7101-1

Big Twins 1930-54 (shown). Replaces OEM 24003-30, 11/16-18" thread.

Stock No. 7826-1

Big Twins 1955-76. Replaces OEM 24003-55, 7/8-14" thread.

Stock No. 2289-1

45's 1929-up. Replaces OEM 7991 (2050-12), 5/8-18" thread.

Stock No. 2572-1

Sportster Late 1981-1985. Replaces OEM 23902-81, 3/4-20" thread.

Stock No. 2293-1

Sportster 1991-92. Replaces OEM 7652, 3/4-16" thread.

Stock No. 2285-1

Sportster 1993-up. Replaces OEM 7839, 3/4-16" thread.

Flywheel Side—Pinion Shaft Nuts

Stock No. 2539-1

1930-1936 VL. Replaces OEM 364-30, 3/4-18" thread.

Stock No. 2286-1

Big Twins 1936-early 1981. Replaces OEM 24023-36, 3/4-18" thread.

Stock No. 2287-1

KH, Sportster 1954-early 1981. Replaces OEM 8011, 11/16-18" thread.

Stock No. 2572-1

Sportster Late 1981-1985. Replaces OEM 23902-81, 3/4-20" thread.

Stock No. 2375-1

Big Twins Late 1981-1989. Replaces OEM 24016-80, 3/4-20" thread.

Stock No. 2409-1

Big Twins Late 1954-1989. Replaces OEM 24023-54, 5/8-24" thread.



Gear and Sprocket Shaft Nut Lockwasher Kit

Duplicate of 368-29 locks and screws used on 1929-1973 45's.

Stock No. 3084-4

Nuts, Locks, Tools—Motor Shafts



Motor Sprocket Nut

Reproduction of stock nut.

Stock No. 2898-1

Late 1970-1990 Big Twins, OEM 40392-70, 7/8-14" thread.

Stock No. 2900-1

Late 1991-2006 Big Twins, (except 2006 Dyna). OEM 40392-91, 7/8-14" thread.

Stock No. 2917-1

1970-1990 Sportster, OEM 40387-70, 3/4-16" thread.

Stock No. 2293-1

1991-1992 Sportster, OEM 7652, 3/4-16" thread.

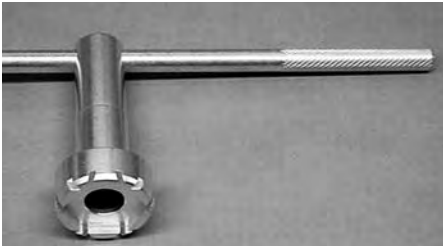

Countershaft Sprocket Lock Nut Wrench

Reproduction of OEM 12023-X wrench used on any Big Twin sprocket lock nut from 1915-1991.

Stock No. 2683-1

Transmission Mainshaft Locknut

Stock No. 3005-2 Big Twins 1915-1935, OEM 2335-15, 1-1/2-24" L.H. thread.

Stock No. 3114-1 2006-up Dyna, 2007-up Softail, Touring OEM 35241-06, 1-3/4-20" thread.

Stock No. 8408-1 Big Twins 1936-91, OEM 35211-36. (shown), 1-1/2-24" L.H. thread.

Stock No. 2320-1 1992-up XL, 1992-2005 Dyna, 1992-2006 Touring, Softail, OEM 35211-91A/B, 1-1/2-24" L.H. thread.

Stock No. 2376-1 45's 1937-73. Replaces OEM 8010 (364-37), 11/16-18" thread.



Transmission Mainshaft Bearing Nut and Locktab

Parkerized accurate reproduction of 35046-36 nut and 35050-40 locktab used on 1936-1985 Big Twins, 7/8-18" thread.

Stock No. 2430-2



Transmission Mainshaft Sprocket Nut

Parkerized reproduction of OEM 35047-71A nut and locktab used on 1971-early 1984 Sportster, 7/8-20" thread.

Stock No. 2679-2



Motor Sprocket Nut Decorative Chrome Plated Acorn Style

Chrome plated acorn style. Big Twins 1936-54.

Stock No. 7107-1

11/16-18 thread Chrome plated acorn style. Big Twins 1955-76.

Stock No. 7816-1

7/8-14 thread Chrome plated acorn style. Sportster 1957-up

Stock No. 7817-1

3/4-16 thread



Pinion Gear Nut Wrench

Quality tool designed to remove and install pinion gear nut, OEM 24023-54, Colony P/N 2409-1. Black oxide finish.

Stock No. 2429-1



Sprocket Nut Lockplate

Reproduction of lockplate and screws with lockpatch. Black oxide finish.

Stock No. 3118-3

1993-2006 Softail, Touring and 1993-2005

Dyna Models. Replaces OEM 40251-92A.

Stock No. 3119-3

2007-up Softail, Touring and 2006-up

Dyna Models. Replaces OEM 35242-06.

Motor Case Hardware

These complete motor case kits from Colony contain all the necessary hardware to bolt together the Harley motor cases. Each kit is packaged for the specific application. There are no universal "fits all" kits. We know that a rebuild job can only be as good as the nuts and bolts that hold it together. Available 3 ways: Stock with cad plating; Stock with chrome plating; Acorn with chrome plating.



Stock No.	Description		
2979-28	Motor Case Kit VL	1930-1936	Stock Cad
8121-34	Motor Case Kit Flathead	1936-1939	Acorn Chrome
8122-34	Motor Case Kit Flathead	1936-1939	Stock Chrome
8123-34	Motor Case Kit Flathead	1936-1939	Stock Cad
3010-34	Motor Case Kit Flathead	1936-1939	Stock Parkerized
8124-34	Motor Case Kit Flathead	1940-1948	Acorn Chrome
8125-34	Motor Case Kit Flathead	1940-1948	Stock Chrome
8126-34	Motor Case Kit Flathead	1940-1948	Stock Cad
3011-34	Motor Case Kit Flathead	1940-1948	Stock Parkerized
8127-34	Motor Case Kit O.H.V. Big Twins	1936-1939	Acorn Chrome
8128-34	Motor Case Kit O.H.V. Big Twins	1936-1939	Stock Chrome
8129-34	Motor Case Kit O.H.V. Big Twins	1936-1939	Stock Cad
3012-34	Motor Case Kit O.H.V. Big Twins	1936-1939	Stock Parkerized
8130-34	Motor Case Kit O.H.V. Big Twins	1940-1947	Acorn Chrome
8131-34	Motor Case Kit O.H.V. Big Twins	1940-1947	Stock Chrome
8132-34	Motor Case Kit O.H.V. Big Twins	1940-1947	Stock Cad
3013-34	Motor Case Kit O.H.V. Big Twins	1940-1947	Stock Parkerized
8133-34	Motor Case Kit Panhead	1948-1964	Acorn Chrome
8134-34	Motor Case Kit Panhead	1948-1964	Stock Chrome
8135-34	Motor Case Kit Panhead	1948-1964	Stock Cad
3014-34	Motor Case Kit Panhead	1948-1964	Stock Parkerized
8136-34	Motor Case Kit Big Twins	1965-1969	Acorn Chrome
8137-34	Motor Case Kit Big Twins	1965-1969	Stock Chrome
8138-34	Motor Case Kit Big Twins	1965-1969	Stock Cad
8139-34	Motor Case Kit Shovelhead	1970-1978	Acorn Chrome
8140-34	Motor Case Kit Shovelhead	1970-1978	Stock Chrome
8141-34	Motor Case Kit Shovelhead	1970-1978	Stock Cad
8142-34	Motor Case Kit Shovelhead/EVO	1979-1995	Acorn Chrome
8143-34	Motor Case Kit Shovelhead/EVO	1979-1995	Stock Chrome
8144-34	Motor Case Kit Shovelhead/EVO	1979-1995	Stock Cad
9882-22	Motor Case Kit B.T. Evolution	1996-up	Acorn Chrome
9883-20	Motor Case Kit B.T. Evolution	1996-up	Flanged Nut Style Chrome
9884-20	Motor Case Kit B.T. Evolution	1996-up	Flanged Nut Style Zinc
9956-18	Motor Case Kit Twin Cam 88	1999-up	Allen Chrome - Knurled
9956-18-P	Motor Case Kit Twin Cam 88	1999-up	Allen Chrome - Polished
9955-27	Motor Case Kit Twin Cam 88	1999-up	Acorn Chrome
2788-16	Motor Case Kit 45's	1929-1931	Parkerized/Cad
3310-17	Motor Case Kit 45's (R Models)	1932-1936	Parkerized/Cad
3103-17	Motor Case Kit 45's	1937-1939	Stock Cad
8619-17	Motor Case Kit 45's	1940-1973	Stock Chrome
8620-17	Motor Case Kit 45's	1940-1973	Stock Cad
9697-17	Motor Case Kit 45's	1940-1973	Parkerized
2451-17	Motor Case Kit "K" Models	1952-1956	Stock Cad
9878-13	Motor Case Kit Sportster	1957-1976	Stock Cad
9879-31	Motor Case Kit Sportster	1977-1990	Stock Zinc
2067-8	Motor Case Kit Sportster	1957-1976	Allen Chrome - Knurled
2068-10	Motor Case Kit Sportster	1977-1990	Allen Chrome - Knurled
2075-8	Motor Case Kit Sportster	1991-2003	Allen Chrome - Knurled

Motor Case Hardware



Slotted 1/4-24 Thread Nut Kit

Special designed slotted nut and installation tool has been produced by Colony for all pre-1930 Harley motor cases.

Stock No. 8628-6 Package of 6 cad plated nuts

Stock No. 8629-1 Installation tool

Stock No. 2952-6 Package of 6 Nickel Plated Nuts



Installation Tool, OEM Style

Accurate reproduction of original factory T-handle wrench used on the 1/4-24 slotted pre-1930 motor case nuts.

(Colony P/N 8628-6 nuts)

Stock No. 2594-1



Motor Case Drain Plug/Oil Pump Body Plug

Reproduction of OEM P/N 700 plug fits Big Twin motor case 1936-1970, oil pump body 1968-1984 and 45's motor case 1937-up.

Stock No. 8116-1 Chrome Plated

Stock No. 8117-1 Cad Plated

Stock No. 9675-1 Parkerized



Sprocket Cover Stud & Nut Kit

Exact reproduction of sprocket cover mounting hardware used on Harley 45's 1935-1973.

Stock No. 8621-16 Chrome Plated

Stock No. 8622-16 Cad Plated

Stock No. 9686-16 Parkerized

Motorcase Breather Pipe Nipple

Reproduction of 24918-52 nipple used on 1952-1984 K and Sportster models and 1965-1967 FL, FLH.

Stock No. 3311-1



Crankcase Breather Stud and Pipe Assembly

Parkerized reproduction of breather stud and pipe.

Stock No. 2988-3 1939-1947 Knucklehead OEM 543-36

Stock No. 2989-3 1948-1957 Panhead OEM 543-48



Motor Case Breather Stud

Parkerized reproduction of 24914-58 stud assembly, 24925-58 spacer and 24918-58 rubber nipple used on 1958-1963 FL, FLH.

Stock No. 3113-5



Transmission Drain Plug

Cad plated reproduction of OEM 453-11 early style dome top slotted plug fits 1911-1936 J, JD, VL.

Stock No. 2974-1



Crankcase Vent Fitting and Hose

OEM replica zinc plated vent fitting and hose used on 1977-1980 Sportster. Replaces OEM 34744-77.

Stock No. 2440-2

Timing Plugs

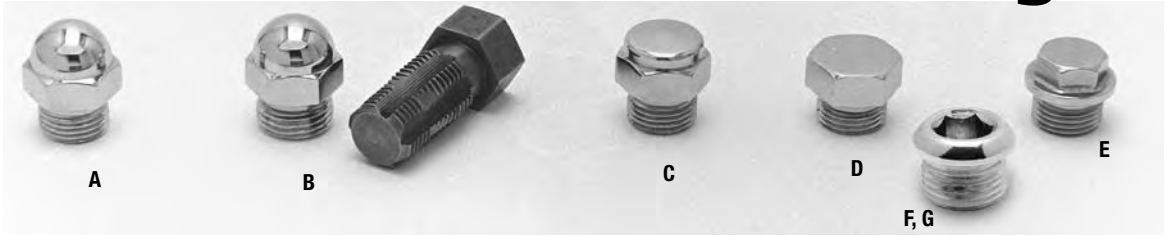

A. Acorn style plug fits all models Harley Big Twin and Sportster timing plug holes and oil tanks with 5/8-18 drain holes.
Stock No. 7106-1

B. Acorn style plug with an oversize thread and one tap for rethreading the stripped out timing hole. Fits all Harley timing holes.

Stock No. 7500-2 Plug and Tap
Stock No. 9407-1 Tap Only

Tap to be used if cases are apart.
Use tap stock no. 2282-1 for on bike rethreading.

Stock No. 7501-1 Plug Only
Stock No. 2282-1 11/16-16 4 Flute Standard Tap

C. Cap style plug fits all models Harley Big Twins and Sportster timing plug holes and oil tanks with 5/8-18 drain holes.
Stock No. 8441-1

D. Quality reproduction of stock timing/oil tank plug. Offered in choice of polished and chrome plated, cad plated or parkerized. Use tap, Colony P/N 9407-1 to rethread stripped out timing hole. 5/8-18 thread.

Stock No. 8114-1 Chrome Plated - 3/4 Hex, FL, XL, 1952-1969, OEM P/N 704.
Stock No. 8115-1 Cad Plated - 3/4 Hex, FL, XL 1952-1969, OEM P/N 704.

OVERSIZED! **Stock No. 9304-1** Chrome Plated - Oversize plug with 3/4 Hex and 11/16-16 Thread.
Stock No. 9404-1 Cad Plated - Oversize plug with 3/4 Hex and 11/16-16 Thread.
Stock No. 9714-1 Parkerized - Oversize plug with 3/4 Hex and 11/16-16 Thread.

OVERSIZED!

Stock No. 2588-1 Cad Plated - Oversize plug with 7/8 Hex and 11/16-16 Thread.

Stock No. 2589-1 Parkerized - Oversize plug with 7/8 Hex and 11/16-16 Thread.

Stock No. 9502-1 Chrome Plated - 7/8 Hex, All Models 1938-1951, OEM P/N 2326-38.

Stock No. 9503-1 Cad Plated - 7/8 Hex, All Models 1938-1951, OEM P/N 2326-38.

Stock No. 9504-1 Parkerized - 7/8 Hex, All Models 1938-1951, OEM 2326-38.

E. Exact duplicate of 5/8-18 timing plug-transmission oil fill plug used on the following:

1936-1939 Big Twin timing plug
1926-1940 45 transmission fill plug
OEM 2326-26

Stock No. 8610-1 Chrome Plated

Stock No. 8611-1 Cad Plated

Stock No. 8612-1 Parkerized

F. Quality duplicate of allen style plug used on all Harley Davidson 1970-up, Dyna, Touring up to 1998, Softail up to 1999, Sportster up to 2003. OEM 720. 5/8-18 thread.

Stock No. 9402-1 Chrome Plated

Stock No. 9403-1 Cad Plated

G. Allen style plug with oversize threads. Use tap, Colony P/N 9407-1 to rethread stripped out timing hole. Used on Harley Davidson 1970-up, Dyna, Touring up to 1998, Softail up to 1999, Sportster up to 2003. 11/16-16 thread.

Stock No. 9960-1 Chrome Plated

NOTE: Use 5/8" drill for proper hole size when using 11/16-16 oversize tap.

Drain Plugs

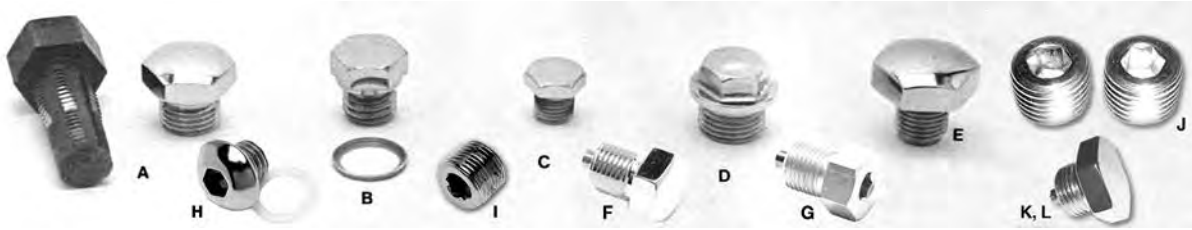

- A.** Chrome plated dome head plug with an oversize thread and one tap for rethreading the stripped out drain hole. Fits O.H.V. Big Twin 1965-up and Sportster 1967-up. 9/16-18 thread.

Stock No. 7502-2 Plug and Tap
Stock No. 7503-1 Plug Only
Stock No. 2385-1 9/16-18 4 Flute Standard Tap

Tap to be used if cases are apart.
 Use tap stock no. 2385-1 for on bike rethreading.

- B.** Quality reproduction of drain plug and brass gasket used on Sportster transmission, motor case, oil tank and Big Twin 1937-1986 transmission. 1/2-13 Thread. OEM 707.

Stock No. 8494-1 Chrome Plated
Stock No. 8495-1 Cad Plated

- C.** Quality reproduction of original Harley motor case drain plug, OEM 453-11/700, fits Big Twins 1911-1970. 3/8-24 thread.

Stock No. 8116-1 Chrome Plated
Stock No. 8117-1 Cad Plated
Stock No. 9675-1 Parkerized

- D.** Available in 3 different finishes, this plug fits all Harley oil tank drains with 5/8-18 hole. Also transmission oil fill on 45's to 1940.

Stock No. 8610-1 Chrome Plated
Stock No. 8611-1 Cad Plated
Stock No. 8612-1 Parkerized

- E.** Chrome plated plug with gasket fits all Harley Big Twin 1981-89 oil tank with 1/2-20 thread.

Stock No. 8493-2

Reproduction of original transmission and oil drain magnetic plug, OEM 60328-98A. Fits 2000-up Big Twins. 1/2-20 thread.

- F.** **Stock No. 2295-1** Chrome Plated Custom Dome Head

- G.** **Stock No. 2296-1** Chrome Plated Stock Style

- Stock No. 2297-1** Zinc Plated Stock Style

- Stock No. 2807-1** Chrome Plated, oversized 9/16-18 thread

- Stock No. 2808-1** Zinc Plated, oversized 9/16-18 thread

OVERSIZED!

- H.** **Stock No. 2439-1** Chrome plated button head allen drain plug and gasket used on Sportster transmission, motor case, oil tank and Big Twin 1937-1986 transmission. 1/2-13 thread. OEM 707.

- I.** **Stock No. 2418-1** Chrome plated transmission pan drain plug for 2000-up Dyna and FLT models. OEM 45893-99

- J.** **Stock No. 2549-2** Chrome plated crankcase plugs for 1999-up FLT, Dyna and 2000-up Softail. Also used on 1999-up FLT transmission. 2/kit. OEM 765.

- K.** Reproduction of transmission magnetic drain plug used on 1981-1992 FLT and FXR models. OEM 722.

Stock No. 2566-2 Chrome Plated

Stock No. 2567-2 Zinc Plated

- L.** Duplicate drain plug, replaces OEM 60346-65 and 60348-65A used on 1965-1984 FL, 1971-1984 FX chain housing and 1967-1992 Sportster crankcase. 1/2-20 thread.

Stock No. 2828-1 Chrome Plated

Stock No. 2824-1 Zinc Plated

Stock No. 3052-1 Oversized, Chrome Plated, 9/16-18 thread

Stock No. 3051-1 Oversized, Zinc Plated, 9/16-18 thread

NOTE: Use 33/64" drill for proper hole size when using 9/16-18 oversize tap.

Transmission Plugs



Transmission Filler Plug

Exact reproduction of original cadmium plated steel plug, OEM 2326-17, used on 1917-1929 61" and 1921-1936 74".

Stock No. 2976-1

- A. Custom fill plug will fit all Big Twins 1940-1984 with 4 speed transmission. 7/8-18 thread.
Stock No. 7351-2 Chrome Plated
- B. Custom cap style plug fits Harley Big Twins 1940-1984 with 4 speed transmission. 7/8-18 thread.
Stock No. 8801-2 Chrome Plated
- C. Cap style custom fill plug fits Harley Evolution 5 speed transmission 1985-1986. 7/8-18 thread.
Stock No. 8803-2 Chrome Plated
- D. Custom fill plug/dipstick fits Harley Evolution. 7/8-18 thread.
Stock No. 8405-2 Chrome Plated, 5 speed transmission 1985-1986
Stock No. 9861-2 Chrome Plated, 1987-2005 Dyna models, 1987-2006 Softail and Touring models.
- E-F. Reproduction of original Harley part available in standard or oversize self tapping. Fits Harley Big Twin 1936-up with 4 speed transmission. 7/8-18 thread.
Stock No. 8118-1 Standard Chrome (E)
Stock No. 7616-1 Standard Cad (E)
Stock No. 9700-1 Standard Parkerized (E)
- Stock No. 8406-1** Oversize Chrome (F)
Stock No. 8407-1 Oversize Cad (F) **OVERSIZED!**
- G. Chrome plated custom fill plug is designed to restore "pulled" threads in the Harley transmission side cover. Fits all Big Twins 1940-1984 with 4 speed transmission.
Stock No. 7156-2
- H. Quality reproduction of original Harley part. Fits Harley 45's 1941-up. 11/16-11 thread.
Stock No. 8631-1 Chrome Plated
Stock No. 8613-1 Cad Plated
Stock No. 9719-1 Parkerized
- I. Reproduction of stock knurled transmission filler plug available in chrome plated steel or brushed aluminum. Fits 1958-1980 Big Twin Harley Davidson. 7/8-18 thread.
Stock No. 9400-1 Chrome Plated Steel
Stock No. 9401-1 Brushed Aluminum
- J. Chrome plated steel reproduction of original transmission filler plug.
Stock No. 9885-2 1987-2005 Dyna models
1987-2006 Softail and Touring models
Stock No. 2786-2 2006-up Dyna models
2007-up Softail, Touring and Trike models
- K. Parkerized reproduction of OEM 2326-35 transmission fill plug used on 1935-1940 45's.
Stock No. 2655-1



Boot Guard

Accurate reproduction of the original OEM 11500-38 boot guard mounts on the exhaust pipe. Used on 1936-up Knucklehead and Flathead:

Stock No. 2577-1 Chrome Plated
Stock No. 2943-1 Parkerized



Utility Saddle Bag Holder Kit

Accurate reproduction OEM style fasteners P/N 11724-X, used to hold saddlebags on 1936-1938 Big Twins.

Stock No. 2634-12



Saddle Bag Mounting Kit

Cad plated studs, chrome plated correct OEM style acorn nuts to install saddle bag mounting plates on all Harley Davidson 1934-1957.

Stock No. 8205-8

Lower Pushrod Cover Kits



Lower Pushrod Cover Kits

These stock pushrod covers are beautifully plated duplicates of the Harley part. Available in sets of 4 with rubber seals for the following:

Chrome Plated

- Stock No. 7824-12** Knucklehead 1940-1947, Chrome Plated
- Stock No. 3026-12** Knucklehead 1940-1947, Parkerized
- Stock No. 3029-12** Knucklehead 1940-1947, Cadmium Plated
- Stock No. 7823-12** Panhead/Shovelhead 1948-Early 1979
- Stock No. 2091-12** Shovelhead L1979-1984
- Stock No. 9202-12** Big Twin Evolution 1984-up, Sportster 1986-90
- Stock No. 9968-12** Twin Cam 88, 1999-up, Touring up to 2016
- Stock No. 7822-12** Sportster 1957-1985
- Stock No. 3141-16** Touring Models (M8) 2017-up



Chrome Plated Billet Aluminum Custom Pushrod Cover Kits

These chrome plated pushrod covers have a decorative grooved pattern that will add a custom look. Available in sets with rubber seals for the following:

- Stock No. 7135-8** Panhead/Shovelhead 1948-up
For 1979-1984 Shovelhead use Colony P/N 7808-4 inner covers.
- Stock No. 7134-8** Sportster 1957-1985



Chrome Plated Billet Aluminum Pushrod Cover Kit

These chrome plated aluminum pushrod covers are made to look like the OEM covers but are machined from aluminum. Fits 1936-1939 Knucklehead.

Stock No. 7133-8

Upper Pushrod Cover Kits



Replacement Upper Pushrod Cover Kits (Outer)

Each kit contains 4 chrome plated retaining clips, 4 chrome plated cups, 4 springs, 4 rubber seals, and 4 steel washers. These are exact duplicates of the Harley part and are available for the following:

Chrome Plated

- Stock No. 7509-20** Knucklehead 1936-1939, (2" long clips)
- Stock No. 7507-20** Sportster 1957-1985 and Panhead 1948-1965 (2-3/8" long clips)
- Stock No. 9887-20** Sportster 1986-1990, (2-13/16" long clips)
- Stock No. 8602-20** All Shovelhead and 1940-1947 Knucklehead-Strocker Length, (3-1/2" long clips)
- Stock No. 7508-20** All Shovelhead, Evolution, and 1940-1947 Knucklehead (3-5/16" long clips)
- Stock No. 3027-20** 1940-1947 Knucklehead, Parkerized
- Stock No. 3030-20** 1940-47 Knucklehead, Cadmium Plated
- Stock No. 9970-20** 1999-up Twin Cam 88, 2017-up M8 (1-3/4" long clips)
- Stock No. 9865-20** Evolution with S&S lifter blocks, (3" long clips), Chrome Plated

Pushrod Cover/Seal Kits

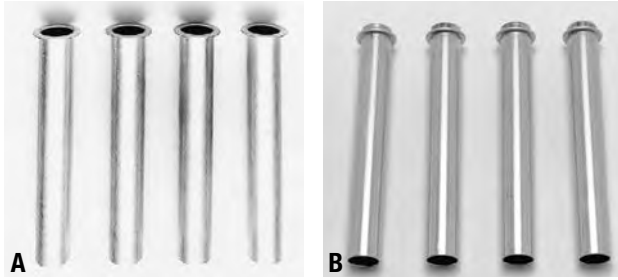

Replacement Upper Pushrod Covers (Inner)

- A. Stock No. 7808-4** Fits 1936-early 1979 all Big Twins O.H.V., also Sportster 1957-85 (SHOWN), Zinc Plated
- A. Stock No. 3028-4** Fits 1936-early 1979 all Big Twins O.H.V., also Sportster 1957-85, Parkerized
- A. Stock No. 3031-4** Fits 1936-early 1979 all Big Twins O.H.V., also Sportster 1957-85, Cadmium Plated
- B. Stock No. 9213-4** Fits late 1979-up Shovelhead, also 1984-up Big Twin Evolution.
- Stock No. 9969-4** Fits 1999-up Twin Cam 88, 2017-up M8 (*not shown*)



Pushrod Cover Seal Kit

Rubberized cork seals replace old style cork for improved sealing and longer life. Packed 12 per kit.

- Stock No. 8728-12** All Panhead, Shovelhead to 1979
- Stock No. 8729-12** Sportster 1957-1979, Knucklehead 1936-1947
- Stock No. 9529-12** 1984-up Big Twin Evolution, Twin Cam and 1986-1990 Sportster



Pushrod Cover Seal Kit

All rubber seals, alternative to the cork or rubberized cork. Packed 12 per kit.

- Stock No. 3170-12** All Panhead, Shovelhead to 1979
- Stock No. 3171-12** Sportster 1957-1979, Knucklehead 1936-1947



Pushrod Cover Seal Kit

Duplicate of original o-ring or quad seals, as required.

- Stock No. 9529-12** 1984-up Big Twin Evolution, Twin Cam and 1986-1990 Sportster (o-rings)
- Stock No. 2142-12** Shovelhead L1979-1984 (Quad Seals) *SHOWN*

Pushrod Cover Kits



Pushrod Cover Conversion Kit

Complete kit includes upper, lower and inner pushrod covers to convert your 1991-2003 Sportster to the early style removable pushrod covers. Use Colony P/N 2254-2 adaptors.
Stock No. 2255-36



Pushrod Cover Kit

Complete kit includes upper, lower and inner removable pushrod covers for use when installing adjustable pushrods.
Stock No. 2253-26 2004-up Sportster.
Stock No. 3126-36 1999-up Twin Cam motors.



Pushrod Cover Conversion Adaptor Kit

These adaptors eliminate the need to remove the cylinder heads to access the pushrods by allowing installation of the early style removable pushrod covers and easy installation of adjustable pushrods. Fits 1991-2003 Sportster. Use Colony P/N 2255-36 complete Pushrod Cover Kit.
Stock No. 2254-2



Pushrod Cover Kit

Lower pushrod covers and upper clips used when installing adjustable pushrods in Twin Cam motors. Requires the use of OEM springs, retainers and washer.
Stock No. 2148-8



Pushrod Cover Conversion and Adaptor Kit

Adapts your 1991-2003 Sportster lifter base to use the early style removable pushrod covers. Complete kits include upper, lower, inner covers and adaptors.
Stock No. 2140-40



Pushrod Cover Kit

Chrome plated custom billet aluminum upper and lower covers for 1984-up Big Twin Evolution.
Stock No. 2453-12 Upper covers, lower covers and spring retainers only.
Stock No. 2454-36 Complete kit with all components required.

Valve Covers



Valve Cover Set

Reproduction of valve spring covers and gaskets. Designed with internal o-ring for a positive seal.

- Stock No. 2885-24** 1930-1936 VL, Cad Plated
- Stock No. 3091-24** 1930-1936 VL, Chrome Plated
- Stock No. 2886-24** 1937-1938 Big Twin Sidevalve, Cad Plated
- Stock No. 3092-24** 1937-1938 Big Twin Sidevalve, Chrome Plated
- Stock No. 3300-12** O-rings and gaskets kit for above.

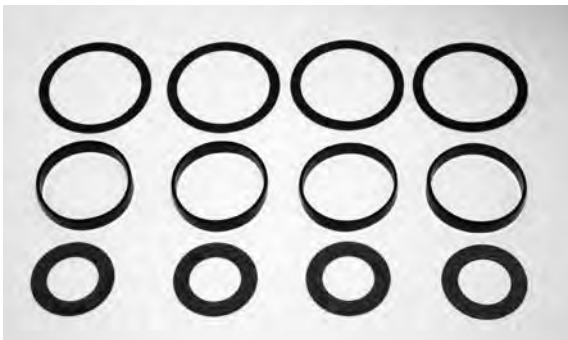

Valve Cover Seal Kit

Reproduction of OEM 175-29, 176-26 and 167-38 gaskets used on 1929-1973 45" motors.

Stock No. 2715-12



Valve Spring Cover Wrench Set

Duplicate of 11806-30 (94522-30) and 11806-30A (94521-30) wrenches used on 1930-1938 VL, UL threaded type valve covers (Colony P/N 2885-24, 2886-24).

Stock No. 3245-2



Valve Cover Set

Reproduction of valve spring covers and gaskets used on 1930 45" Twins.

Stock No. 2887-20 Cadmium Plated



Valve Cover Set

Reproduction of valve spring covers and gaskets used on 1931-1941 45's.

Stock No. 2642-20 Cadmium Plated

Stock No. 3273-20 Chrome Plated

Valve Spring Cover Set

Reproduction of valve spring covers and gaskets used on 1942-1973 45's.

Stock No. 2717-20 Cadmium Plated

Stock No. 2721-20 Chrome Plated

Stock No. 2722-20 Parkerized

Valve Covers



Valve Cover Set

Reproduction valve covers used on 1939-1948 UL, ULH Sidevalves.

Stock No. 3065-36 Parkerized

Stock No. 3066-36 Cadmium Plated

Stock No. 3076-36 Chrome Plated



Lower Valve Spring Cover Kit

Reproduction of 18255-52A covers, o-rings and gaskets used on 1952-1956 all Harley K models.

Stock No. 3057-4 Cadmium Plated



Valve Spring Cover Set

Gray nickel plated duplicate of valve spring covers and gaskets used on 1926-1934 Singles and 1929 45's.

Stock No. 3187-10



Valve Cover Seal Set

Reproduction of OEM 173-39A, 175-39A, and 175-39C gaskets used on 1939-1948 UL, ULH Sidevalves.

Stock No. 3093-12

Pushrod Kits

COMPLETE CONVERSION KITS FEATURING:

- AIRCRAFT QUALITY MATERIALS
- PRECISION TOLERANCES
- INSTALLATION INSTRUCTIONS
- ALL PUSHRODS ARE MANUFACTURED FROM 7/16 O.D. ALUMINUM ALLOY TUBING



Aluminum Alloy Tubular Pushrod and Hydraulic Lifter Conversion Kit

The installation of this kit will correct all problems associated with hydraulic lifters and at the same time substantially reduce valve train weight. Complete conversion kits available for the following:

- Stock No. 7131-12** Harley Panhead 1953-1965
Stock No. 7132-12 Harley Shovelhead 1966-1983
Stock No. 8603-8 Harley Big Twin Evolution 1984-up

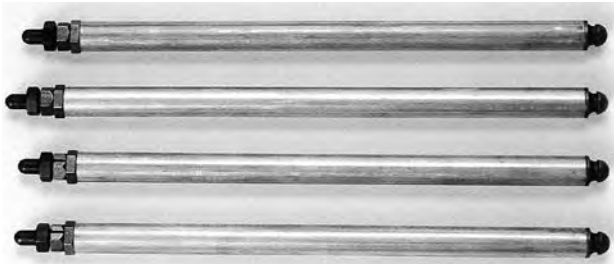

Replacement Aluminum Pushrods For Use With Hydraulic Lifters

These pushrods replace the stock steel rods and still retain the hydraulic lifters.

- Stock No. 7515-4** Harley Panhead 1953-1965
Stock No. 7516-4 Harley Shovelhead 1966-1983



Hydraulic Lifter Converters

Convert 74 hydraulic lifters to solids and still use factory pushrods. Easy and inexpensive way to convert to solid lifters. NOTE: Colony Stock No. 7515-4 or 7516-4 pushrods will work perfectly with these converters.

Stock No. 8204-4



Aluminum Alloy Pushrod Kits

These lightweight pushrods are manufactured from the best materials obtainable regardless of cost. Aircraft grade aluminum tubing and heat treated steel ends provide maximum durability and long life expectancy. Available for the following:

Stock No.

- 7122-4** Harley 74, 1948-1952
7519-4 Harley 61, 1948-1952
7505-4 Harley Knucklehead 74, 1936-1947
7518-4 Harley Knucklehead 61, 1936-1947
7506-4 Harley Panhead 1948-1952
 Using 1966-up Shovelhead Top End
7123-4 Sportster 1957-1985



Tappet Screw and Nut Kit

Reproduction of tappet screws and locknuts.

- Stock No. 3253-8** OEM 18554-37 screws and 18570-38 locknuts used on 1957-1985 Sportster.
Stock No. 3255-8 OEM 18555-36 screws and 18570-38 locknuts used on 1936-1952 Big Twins.



Pushrod Tappet Adjuster Locknuts

Split locknuts with 9/32-32 thread fit Harley Davidson 1915-1984 Singles, Flatheads, O.H.V. Big Twins, 45's, Sportster and K models. Replaces OEM 18570-38.

Stock No. 8780-4



Tappet Screw and Nut Kit

Bolts are specifically threaded to replace both OEM 221-15 and 221-40A used on 1929-1973 Side Valves and 1952-1953 K models. Complete with nuts.

Stock No. 2779-8

Pushrods



Pushrod Lifter Tool

Tool to make installation of pushrod easier, insert tool onto pushrod end and lift. Use on Knucklehead, Panhead, and Shovelhead.

Stock No. 3056-1



Aluminum Valve Collars

These lightweight collars are machined from 7075 aluminum alloy for durability in high performance engines. Fits all O.H.V. Big Twin Harley 1936-1984.

NOTE: Use stock split locks.

Stock No. 7120-4

Axle Nuts



A. Front Axle Nut Kits

Quality hardware kits offered by Colony to make the older Harleys look better and stay together longer. Kits contain one each: axle nut, sleeve nut and cotter pin or two castle nuts and two cotter pins depending on application.

Stock No. 9405-3	Harley VL	1930-1936 Chrome Plated	
	Big Twins	1936-1945 Chrome Plated	
Stock No. 9406-3	Harley VL	1930-1936 Parkerized	
	Big Twins	1936-1945 Parkerized	
Stock No. 8162-3	Big Twins	1946-1971 Chrome Plated	(SHOWN)
Stock No. 8163-3	Big Twins	1946-1971 Cad Plated	
Stock No. 2816-3	Big Twins	1946-1971 Parkerized	
Stock No. 8852-4	Singles	1926-1934 Chrome Plated	
	45 Solo	1929-1936 Chrome Plated	
Stock No. 8853-4	Singles	1926-1934 Cad Plated	
	45 Solo	1929-1936 Cad Plated	
Stock No. 9689-4	Singles	1926-1934 Parkerized	
	45 Solo	1929-1936 Parkerized	
Stock No. 8854-4	45 Solo	1937-1952 Chrome Plated	
Stock No. 8855-4	45 Solo	1937-1952 Cad Plated	
Stock No. 9690-4	45 Solo	1937-1952 Parkerized	

B. Front Axle Nut and Washer Kit

Chrome plated machined steel washer, hex nut, and lockwasher fits Harley Wideglide, FX, or Sportster.

Stock No. 8768-3 Fits FX, Sportster 1973-up. Replaces OEM 7813, 7038 & 6653. 5/8-18 thread.

Stock No. 8769-3 Fits Wideglide 1972-up. Replaces OEM 7845, 7068 & 6590HW. 1/2-20 thread.

B. Front Axle Nut and Washer Kit

Cadmium plated, steel washer, hex nut, and lockwasher fits Harley Wideglide, FX, or Sportster.

Stock No. 2927-3 Fits FX, Sportster 1973-up. Replaces OEM 7813, 7038 & 6653. 5/8-18 thread.

Stock No. 3022-3 Fits Wideglide 1972-up. Replaces OEM 7845, 7068 & 6590HW. 1/2-20 thread.



Front Axle Nut and Washer Kit

Reproduction of 43886-52 nut and lockwasher used on 1952-1972 K, KH, XL, XLH, XLCH.

Stock No. 2926-2 Cad Plated

Stock No. 2929 Chrome Plated

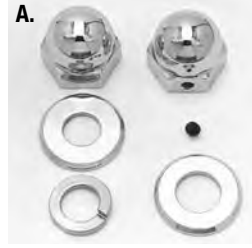

A. Rear Axle Kit

Chrome plated nut & washer kits to modify rear axle on all Harley Big Twin 1973-up, Sportster 1979-up. Kit includes instructions, some machining required.

Stock No. 8606-6 Acorn Style

Stock No. 8607-6 Cap Style

B. Rear Axle Nut and Washer Kit

Chrome plated heavy duty machined steel washers prevent distortion of square swingarms on all Harley Big Twins 1973-up and Sportster 1979-up. Replaces OEM 7813, 7038, 6653 & 33080-36. 5/8-18 thread.

Stock No. 8715-4



Rear Axle Nut and Lock Kit

Quality reproduction rear axle kit contains axle nut, sleeve nut, sleeve collar and axle nut lockwasher. All parts are made to original Harley specifications.

Stock No. 8160-4 Big Twins 1930-1972 Chrome Plated (SHOWN)

Stock No. 8161-4 Big Twins 1930-1972 Cad Plated

Stock No. 9692-4 Big Twins 1930-1972 Parkerized

Stock No. 8832-4 45 Solo 1936-1952 Chrome Plated

Stock No. 8833-4 45 Solo 1936-1952 Cad Plated

Stock No. 9688-4 45 Solo 1936-1952 Parkerized

Stock No. 9610-5 VL 1930-1936 Chrome Plated

Stock No. 9611-5 VL 1930-1936 Parkerized

Stock No. 2366-6 Servi-car 1932-1973 Parkerized

Axle Adjusters



Rear Chain Adjuster
 Reproduction of chain adjuster used on Sportster 1952-1980.
Stock No. 7703-2 Chrome Plated
Stock No. 9020-2 Cad Plated



Rear Chain Adjusters
 These high quality adjusters are available in pairs with plated nuts.

Stock No. 8014-2 Big Twins 1936-72 Cad Plated
Stock No. 7704-2 Big Twins 1936-72 Chrome Plated (SHOWN)
Stock No. 9629-2 Big Twins 1936-72 Parkerized
Stock No. 7814-2 Harley 45's 1930-52 Chrome Plated
Stock No. 8479-2 Harley 45's 1930-52 Cad Plated
Stock No. 9628-2 Harley 45's 1930-52 Parkerized
Stock No. 9500-4 H.D. Servi-car 1932-73 Chrome Plated, OEM 82906-32 Adjuster, 7793 Nut, H.D. Servi-car 1932-73, Cad Plated, OEM 82906-32 Adjuster, 7793 Nut, H.D. Servi-car 1932-73, Parkerized, OEM 82906-32 Adjuster, 7793 Nut.



Complete Rear Wheel Adjuster Kit
 This complete kit contains adjusters, chrome plated end plates, chrome plated hex nuts, and custom chrome plated tapered lock nuts.
Stock No. 8100-8 FX, FL 1973-84; FXR 1981-87; XL 1979-92
Stock No. 2748-8 1997-2004 Sportster
Stock No. 2747-8 1997-2001 FLT
Stock No. 2407-8 1985-1996 FLT



Chrome Plated Custom Rear Axle Adjusters
 Chrome plated, domed head adjusters and nuts replace unsightly original equipment on the following Softail models:



Stock No.
8934-2 1986-1992, Replaces OEM 47579-86
9515-2 1993-1999, Replaces OEM 47579-93
2023-2 2000-07, Replaces OEM 47579-00
2517-2 2008-up, Replaces OEM 4433
2882-2 2006-up, Dyna models, Replaces OEM 45991-06

Swingarm End Cover and Nut Kit

These nicely chrome plated end covers and nuts will replace the original Harley part used on .

Stock No. 8101-6 FX, FL 1973-87; FXR 1981-87; XL 1979-92
Stock No. 2259-8 1993-2004 XL



Chrome Plated Swing Arm End Plates and Custom Wheel Adjuster Hardware Kit

Fits 1991-2005 all Dyna models. Replaces OEM P/N 41113-90

Stock No. 2000-6 End Plates and Adjuster Hardware
Stock No. 2001-2 End Plates Only
Stock No. 9987-4 Adjuster Hardware Only



Swing Arm End Plates
 Chrome plated end plates.

Stock No. 2090-2 1981-1994 FXR, 1979-2001 FLT
Stock No. 2793-2 1979-2004 XL

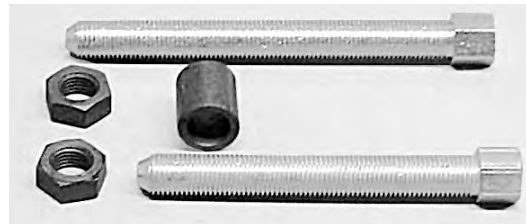

Rear Axle Adjuster Kit

Cad plated bolts OEM 2826-30, parkerized collar OEM 3011-30 and parkerized nuts OEM 0129 fit 1930-1936 74" and 80" Twins.
Stock No. 2069-5

Chain Tensioner Pad and Lockwasher Kit

Reproduction of OEM 39996-65 lockwasher 39976-65B pad, washers and bolts used on 1965-2000 FL, FX Big Twins.

Stock No. 2997-6



Axle Spacers - Front



Chrome plated axle spacer kits are available with custom decorative grooved spacers or with smooth spacers. Kits contain axle nut (hex, castle or nylon insert locknut), machined washer, lockwasher and 1 or 2 spacers, depending on application.

SPORTSTER MODELS

Stock No.	Description
9974-4	1995-1999 all models, OEM 43617-95, with decorative grooves.
9975-4	Same as above without decorative grooves.
2027-5	2000-07 all models, OEM 43358-00, 43617-00, with decorative grooves.
2028-5	Same as above without decorative grooves.
2509-6	2008-up Sportster, 43358-08, 43522-08, without decorative grooves.

SOFTAIL MODELS

Stock No.	Description
9823-3	1988-1996 FXSTS, OEM 40910-84A, with decorative grooves.
9824-3	Same as above without decorative grooves.
9998-3	1997-1999 FXSTS, OEM 43683-97, with decorative grooves.
9999-3	Same as above without decorative grooves.
2031-4	2000-up FXSTS, 43683-00, with decorative grooves.
2032-4	Same as above without decorative grooves.
9924-4	1990-1995 FLSTF, OEM 43657-89, with decorative grooves.
9925-4	Same as above without decorative grooves.
9922-5	1996-1999 FLSTF, OEM 43657-89, 43674-95, with decorative grooves.
9923-5	Same as above without decorative grooves.
2029-5	2000-2006 FLSTF, FLSTFI, OEM 43617-00, 43683-00, with decorative grooves.
2030-5	Same as above without decorative grooves.
2387-5	2007-up FLSTF, OEM 41695-07, 41502-07, without decorative grooves.
9994-4	1997-1999 FLSTC, OEM 43683-97, with decorative grooves.
9995-4	Same as above without decorative grooves.
2033-4	2000-2006 FLSTC, OEM 43683-00, with decorative grooves.
2034-4	Same as above without decorative grooves.
2390-5	2007-up FLSTC, FLSTN, OEM 41510-07, 41502-07, without decorative grooves.
2864-5	1997-1999 FLSTS, OEM 43360-97, 43624-97, without decorative grooves.
2388-5	2000-up FLSTS, OEM 43360-00, 43624-00, without decorative grooves.
9825-4	1984-1996 FXST, FXSTC, FXSTB, OEM 40910-84A/B, with decorative grooves.
9826-4	Same as above without decorative grooves.
9992-5	1997-1999 FXST, FXSTC, FXSTB, OEM 40910-84B, 43683-97, with decorative grooves.
9993-5	Same as above without decorative grooves.
2021-5	2000-2006 FXST, FXSTB, FXSTI, FXSTBI, OEM 43683-00, 40910-00, with decorative grooves.
2022-5	Same as above without decorative grooves.
2391-7	2007-up FXST, FXSTB, FXSTC, OEM 41504-07, 41502-07, without decorative grooves.
2211-5	2001-2006 FXSTD, FXSTDI, OEM 43623-00, 43683-00, without decorative grooves.
2389-7	2007-up FXSTD, OEM 41505-07, 41502-07, without decorative grooves.

TRIKE MODELS

2787-5	2009-up Trike, OEM 83888-09 without decorative grooves.
--------	---

DYNA MODELS

9825-4	1984-1994 FXDWG, OEM 40910-84A/B, with decorative grooves.
9826-4	Same as above without decorative grooves.
9990-5	1995-1996 FXDWG, OEM 40910-84A, 43674-95, with decorative grooves.
9991-5	Same as above without decorative grooves.
9992-5	1997-1999 FXDWG, OEM 40910-84B, 43683-97, with decorative grooves.
9993-5	Same as above without decorative grooves.
2021-5	2000-05 FXDWG, FXDWGI, OEM 43683-00, 40910-00, with decorative grooves.
2022-5	Same as above without decorative grooves.
2337-5	2006-07 FXDWGI, OEM 40927-06, 40926-06, without decorative grooves.
9974-4	1995-1999 all except FXDWG, OEM 43617-95, with decorative grooves.
9975-4	Same as above without decorative grooves.
2027-5	2000-2003 all except FXDWG, FXDWGI, 43358-00, 43617-00A, with decorative grooves.
2028-5	Same as above without decorative grooves.
2256-5	2004-05 all except FXDWG/I OEM 43706-04, 43757-04, without decorative grooves
2339-5	2006-07 all except FXDWGI, OEM 40940-06, 40936-06, without decorative grooves.
2514-5	2008-up all Dyna except FXDWG and FXDF, 11804, without decorative grooves.
2515-5	2008-up FXDWG, FXDF, 40926-08, 40927-08, without decorative grooves.

FLH/FLT MODELS

9825-4	1984-1999 all models except FLHR, FLHRCI, OEM 40910-84A/B, with decorative grooves.
9826-4	Same as above without decorative grooves.
9988-4	1994-1999 FLHR, FLHRCI, OEM 40910-84A, 40915-94, with decorative grooves.
9989-4	Same as above without decorative grooves.
2035-5	2000-2006 all models, OEM 43520-00, 43521-00, with decorative grooves.
2036-5	Same as above without decorative grooves.
2507-5	2008-up FLH, FLT Touring models, 41901-08, without decorative grooves.

Axle Spacers - Rear



Rear Axle Nut & Spacer Kits

Chrome plated castle nut, spring clip, machined washer and decorative grooved spacers or smooth spacers fit the following:

Stock No. Description

- 9811-3** 1991-1999 Dyna, OEM 41591-90, with decorative grooves. (shown)
- 9812-3** Same as above without decorative grooves.
- 2037-4** 2000-05 Dyna, OEM 43654-00, 41591-00, with decorative grooves.
- 2038-4** Same as above without decorative grooves.
- 2335-5** 2006-07 Dyna, OEM 40947-06, 40942-06, without decorative grooves.
- 2516-5** 2008-up Dyna, OEM 41242-08, 40947-08, without decorative grooves.
- 9996-3** 1986-1999 Sportster, OEM 41594-73, with decorative grooves.
- 9997-3** Same as above without decorative grooves.
- 2039-4** 2000-2003 Sportster, OEM 40910-00, 43654-00, with decorative grooves.
- 2040-4** Same as above without decorative grooves.
- 2258-5** 2004 Sportster, OEM 40930-04, 43654-00, without decorative grooves
- 2257-4** 2005 Sportster, OEM 40930-05, 43654-00A, without decorative grooves
- 2483-4** 2006-07 Sportster, OEM 41084-02A, 40930-05, without decorative grooves
- 2510-5** 2008-up Sportster, 40930-05, 41730-08, without decorative grooves.
- 2149-5** 2000-2001 FLT models, OEM 40981-00, 43654-00, with decorative grooves.
- 2150-5** Same as above without decorative grooves.
- 2613-4** 2002-2007 FLH, FLT Touring models, 41240-02, 41084-02, without decorative grooves.
- 2508-4** 2008-up FLH, FLT Touring models, 11844, 41242-08, without decorative grooves.



Rear Axle Nut & Spacer Kits

Chrome plated castle nut and decorative grooved spacers or smooth spacers fit the following:

Stock No. Description

- 9809-4** 1986-1999 all Softail models, OEM 47577-86, 47577-94, 41595-86, 41591-90, with decorative grooves. (shown)
- 9810-4** Same as above without decorative grooves.
- 2025-5** 2000-07 Softail models (except 2006 FXST, FXSTB, FXSTS, FLSTFSE2), OEM 41595-00, 43654-00, 47577-00, with decorative grooves.
- 2026-5** Same as above without decorative grooves.
- 2512-7** 2008-up Softail, OEM 41242-08, 41359-08, 41694-08 without decorative grooves.



Rear Axle Spring Clip

Reproduction of latest OEM P/N 510 spring clip used on all 1991-up FL, FX, XL. 5 spring clips per package.

Stock No. 2042-5 Chrome Plated

Stock No. 3266-5 Zinc Plated

Axle Spacers



Chrome Plated Axle Spacers

Offered in a variety of lengths for use on your custom application. Sold each.
 1-1/8" OD x 3/4" ID 1-1/2" OD x 1" ID

Stock No.	Description	Stock No.	Description
2195-1	1/8"	2234-1	1/8"
2196-1	1/4"	2235-1	1/4"
2197-1	3/8"	2236-1	3/8"
2198-1	1/2"	2237-1	1/2"
2199-1	5/8"	2238-1	5/8"
2200-1	3/4"	2239-1	3/4"
2201-1	7/8"	2240-1	7/8"
2202-1	1"	2241-1	1"



Aluminum Axle Spacer Stock

5" long 6061 aluminum spacer stock. Nice smooth OD turned finish for easy polishing. Cut to length desired.

Stock No. 3319-1	For 5/8" axle, 1-1/8" OD
Stock No. 3316-1	For 3/4" axle, 1-1/8" OD
Stock No. 3314-1	For 25mm axle, 1-1/2" OD
Stock No. 3317-1	For 1" axle, 1-1/2" OD

OEM Axle Spacers

Chrome Plated



OEM Part Number	Outside Dimension	Inside Dimension	Length
11804	1-1/2"	1"	.985"
11843	1.840"/1.498"	25mm	1.396"
11844	1-1/2"	1"	.132"
11848	1.740"	25mm	.255"
40437-01	1-1/2"	1"	.630"
40910-00	1-1/8"	3/4"	.890"
40910-84A	1-1/8"	3/4"	1.280"
40915-94	1-1/8"	3/4"	1.242"
40926-06	1-1/2"	1"	1.025"
40926-08	1.470"	25mm	1.150"
40927-06	1-1/2"	1"	.803"
40927-08	1.470"	25mm	.883"
40930-04	1-1/4"	3/4"	1.478"
40930-05	1-1/2"	1"	1.480"
40936-06	1-1/2"	1"	.815"
40940-06	1-1/2"	1"	.718"
40942-06	1-1/2"	1"	.473"
40947-06	1-1/2"	1"	2.098"
40947-08	1.470"	25mm	2.090"
40981-00	1-1/8"	3/4"	1.520"
41084-02A	1-3/8"	1"	.471"
41242-08	1.470"	25mm	.736"
41350-08	1.470"	25mm	1.240"
41359-08	1.480"	25mm	2.312"
41502-07	1-1/2"	1"	1.115"
41504-07	1-1/2"	1"	.895"
41505-07	2-7/16"	1"	.790"
41510-07	1-7/8"	1"	.337"
41519-00	1-1/8"	3/4"	1.975"
41591-00	1-1/4"	3/4"	1.690"
41591-90	1-1/4"	3/4"	1.437"
41594-73	1-1/8"	3/4"	.645"
41595-00	1-1/8"	3/4"	1.875"
41595-86	1-1/8"	3/4"	1.218"
41694-08	1.480"	25mm	.375"

OEM Axle Spacers

Chrome Plated



OEM Part Number	Outside Dimension	Inside Dimension	Length
41695-07	1-1/2"	1"	.520"
41730-08	1-1/2"	1"	.501"
41901-08	1.350"	25mm	1.013"
43358-00	1-1/8"	3/4"	.140"
43358-08	1.470"	25mm	.317"
43360-00	1-5/8"	3/4"	.377"
43360-97	1-5/8"	3/4"	.819"
43520-00	1-3/8"	3/4"	.970"
43521-00	1-3/8"	3/4"	.885"
43522-08	1.470"	25mm	.648"
43571-01	1-1/2"	1"	.317"
43617-00	1-1/8"	3/4"	.518"
43617-95	1-1/8"	3/4"	.930"
43623-00	2-3/16"	3/4"	.790"
43624-00	2-3/16"	3/4"	.468"
43624-97	2-1/4"	3/4"	.930"
43642-01	1-1/2 "	1"	.815"
43654-00	1-1/8"	3/4"	.470"
43654-00A	1-3/8"	1"	.475"
43654-86	1-1/8"	3/4"	.732"
43657-89	1-1/8"	3/4"	1.000"
43674-95	1-1/8"	3/4"	1.406"
43683-00	1-1/8"	3/4"	.990"
43683-97	1-1/8"	3/4"	1.340"
43706-04	1-1/2"	1"	.523"
43757-04	1-1/2"	1"	.150"
47577-00	1-1/2"	3/4"	.440"
47577-86	1-1/2"	3/4"	.625"
47577-94	1-1/2"	3/4"	.625"
59413-08	1.745"	25mm	.260"
83888-09	1-1/2"	25mm	1.015"
AS-001	1-1/4"	3/4"	1.125"
AS-002	1-1/4"	3/4"	.438"
AS-003	1-1/4"	3/4"	.500"
AS-004	1-1/4"	3/4"	1.250"

Axle Spacers



Outer Rear Axle Spacers

Duplicate of OEM axle spacers.

- A. Stock No. 2866-1** 1936-1957 Big Twins, 41595-36, Parkerized.
Stock No. 2867-1 1936-1957 Big Twins, 41595-36, Chrome Plated.
- B. Stock No. 2868-1** 1938-1952 45 Solo, 41593-38, Parkerized.
Stock No. 2869-1 1938-1952 45 Solo, 41593-38, Chrome Plated.
- C. Stock No. 2870-1** 1955-1978 KH, Sportster, 41600-54, Cadmium Plated.
Stock No. 2871-1 1955-1978 KH, Sportster, 41600-54, Chrome Plated.
Stock No. 3322-1 1952-1954 K, KH, 41600-52, Cadmium Plated.
- D. Stock No. 2872-1** 1958-1966 FL, FLH, 41595-58, Parkerized.
Stock No. 2873-1 1958-1966 FL, FLH, 41595-58, Chrome Plated.
- E. Stock No. 2874-1** 1967-1972 FL, FLH, 41595-67, Parkerized.
Stock No. 2875-1 1967-1972 FL, FLH, 41595-67, Chrome Plated.
- F. Stock No. 2971-1** 1971-1972 FX, Cadmium.
Stock No. 2972-1 1971-1972 FX, Chrome Plated.



Front Axle Spacer

Duplicate of OEM 43884-36 spacer used on 1936-1948 Big Twin Springers, 1942-1943 WLC and 1941-1957 Servi-Car.

- Stock No. 2889-1** Parkerized
- Stock No. 2890-1** Chrome Plated

Axle Covers – Rear – Axle Covers – Front



(DOME)

Front Axle Covers

Decorative chrome plated domed covers add a smooth finished look. Easily installed with set screw. Set of 2.

Stock No. 2120-2 1972 FL, 1973-84 4-speed FL, 1980-99 FL, FLHT, 1980-86 FXWG, 1984-06 Softail (except Deuce), 1988-94 FXR. Fits most 1/2-20 threaded axles.

Stock No. 3015-2 2001-2006 Softail Deuce.

Stock No. 3274-2 2001-2011 Softail Springer and Heritage Springer.

Stock No. 2392-2 2000-2007 Touring models, 2004-2007 Dyna models (except 04-05 FXDWG and 07 FXDSE).

Stock No. 2535-2 2008-up Touring, XL, Dyna models, 2007-up Softail models (except FXCWC), and 2002-up VRSC (except VRSCR, VRSCF).

Stock No. 2519-2 1988-2007 Sportster models, 1991-2005 Dyna, 1991-2003 Dyna (except Wideglide)

Rear Axle Covers

Stock No. 2443-2 1989-2004 Sportster, 1991-2005 Dyna

Stock No. 2445-2 2005-2007 Sportster

Stock No. 2725-2 2008-2012 Sportster

Stock No. 2121-2 1984-2007 Softail

Stock No. 2408-2 2008-up Dyna and Softail models
2013-up Sportster (Except FXCW and FXSB)

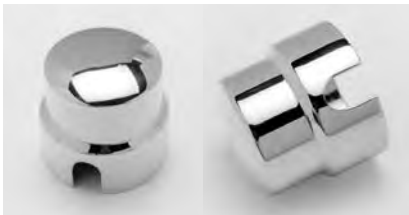

Rear Axle Covers

Chrome plated covers add a smooth finished look. Easily installed with set screws. Set of 2. Fits 1984-2007 Softail.

Stock No. 2121-2

A.



B.



Rear Axle Adjuster Covers

Chrome plated domed or chopper style pike nut covers add a custom look and hide the unsightly factory hardware. Easily installed with set screws.

A. Stock No. 2446-2 Domed, 1993-2004 Sportster

B. Stock No. 2261-2 Pike, 1993-2004 Sportster

A. Stock No. 2448-2 Domed, 2005-up Sportster

B. Stock No. 2444-2 Pike, 2005-up Sportster



(PIKE)

Front Axle Covers

Decorative chrome plated chopper style pike nut covers add a custom look. Easily installed with set screws. Set of 2.

Stock No. 2263-2 1972 FL, 1973-84 4-speed FL, 1980-99 FL, FLHT, 1980-86 FXWG, 1984-06 Softail (except Deuce), 1988-94 FXR. Fits most 1/2-20 threaded axles.

Stock No. 3016-2 2001-2006 Softail Deuce.

Stock No. 3275-2 2001-2011 Softail Springer and Heritage Springer.

Stock No. 2393-2 2000-2007 Touring models, 2004-2007 Dyna models (except 04-05 FXDWG and 07 FXDSE).

Stock No. 2536-2 2008-up Touring, XL, Dyna models, 2007-up Softail models (except FXCWC), and 2002-up VRSC (except VRSCR, VRSCF).

Stock No. 2264-2 1988-2007 Sportster models. 1991-2003 Dyna (except Wideglide).

Rear Axle Covers

Stock No. 2260-2 1989-2004 Sportster, 1991-2005 Dyna

Stock No. 2447-2 2005-2007 Sportster

Stock No. 2726-2 2008-2012 Sportster

Stock No. 2487-2 1984-2007 Softail

Stock No. 2902-2 2008-up Dyna, Softail, 2013-up Sportster (Except FXCW and FXSB)



Rear Axle Covers

Chrome plated chopper style pike nut covers add a custom look. Easily installed with set screws. Set of 2. Fits 1984-2007 Softail.

Stock No. 2487-2

Covers

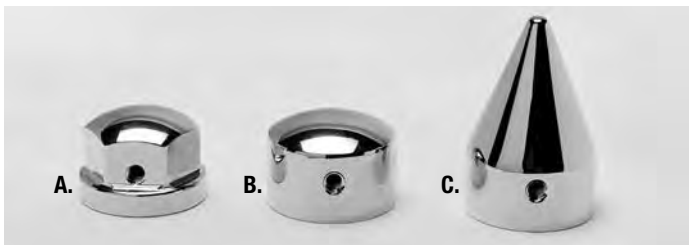

Evolution/Twin Cam Headbolt Covers

Chrome plated headbolt covers to hide dull 12 point headbolts on all late 1985-up FL, FX, XL. Simple installation with set screw.

- A. **Stock No. 2024-4** Custom hex dome style
- B. **Stock No. 2232-4** Smooth style
- C. **Stock No. 2262-4** Pike style



Evolution Head bolt Covers

7/8 Hex Acorn or Cap style covers hide unsightly factory 12 point head bolts. Simple installation with set screw adds beauty to all 1984-early 1985 Big Twin & Sportster Evolution motors.

- | | |
|------------------|--------------|
| Stock No. | Style |
| 9000-4 | Chrome Acorn |
| 9002-4 | Chrome Cap |



Sportster Head Bolt Covers

3/4 hex acorn or cap style covers hide unsightly factory 12 point head bolts on 1973-1984 Sportster motors. Kit contains 8 covers and 1 allen wrench.

- Stock No. 9110-9** Chrome Acorn
- Stock No. 9112-9** Chrome Cap



Swing Arm Pivot Bolt Kit

Chrome plated custom domed head or hex head swingarm pivot bolts and internal tooth lockwashers used on 1984-1999 Softail.

- A. **Stock No. 2205-4** Domed Head
- B. **Stock No. 2215-4** Hex Head



Motor Mount Bolt Covers

Chrome plated covers add a smooth finished look. Easily installed with set screw. Set of 2. Fits 2000-up Softail.

Stock No. 2119-2



Swingarm Covers

Chrome plated covers add a smooth finished look. Easily installed with set screw. Set of 2.

- Stock No. 2122-2** 2000-2007 Softail except FLSTF, FXSTD
- Stock No. 2141-2** 1986-1999 Softail except FLSTS
- Stock No. 2780-2** 2008-up Softail except FXCW, FXCWC



Swingarm Covers

Chrome plated covers add a smooth finished look. Available with red or yellow reflectors. Easily installed with set screw. Set of 2. 1986-1999 Softail except FLSTS.

- Stock No. 8939-2** Yellow
- Stock No. 8940-2** Red

Valve Stem Caps



Chrome Plated Brass Valve Stem Caps

Designed to completely cover threads on steel stems to give a smooth clean look. Offered in two lengths. With chrome plated brass lock nuts. 2 caps, 2 nuts per kit.

Stock No. Description

- A. 2194-4 Medium Length—Cap style—13/16" overall height
- 2210-4 Long Length—Cap style—1" overall height
- B. 2357-4 Medium Length—Pike style—1-5/8" overall height
- 2358-4 Long Length—Pike style—1-7/8" overall height



A.



B.

License Plate Mounting

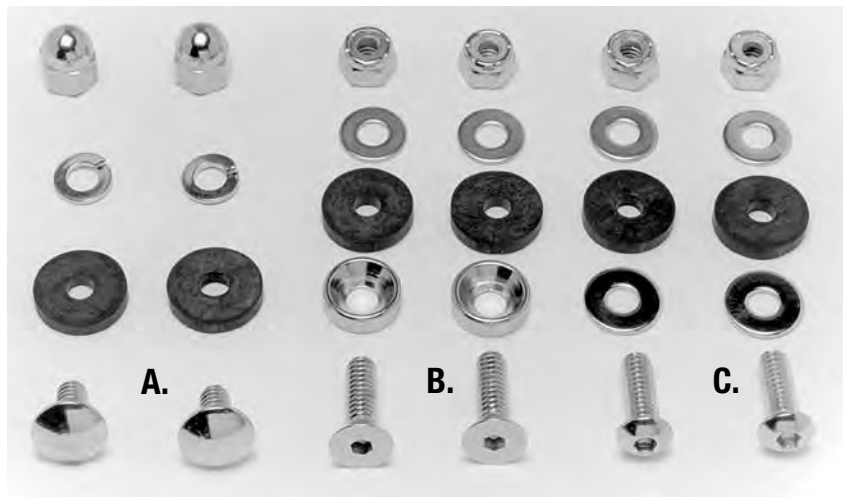

License Plate Mounting Hardware Kit

Chrome plated hardware and rubber insulators to eliminate vibration. Fits all slotted brackets, cycle and automotive.

- A. Stock No. 7815-4 Acorn Style
- Stock No. 8475-4 Cap Style
- B. Stock No. 9871-10 Custom
- C. Stock No. 9872-10 Button Allen

Brake Line Banjo Bolts



Pike



Domed Hex

Allen

Brake Line Banjo Bolts

Chrome plated bolt used on 2006-up VRSC and 2008-up Touring models with 10mm brake line, replaces OEM 41750-06A/B. Includes 2 copper crush washers. 10mm x 1.0 thread.

Stock No. Description

- 2602-3** Domed Hex style
- 2603-3** Allen style

Brake Line Banjo Bolt Crush Washers

Copper crush washers used on 2006-up VRSC and 2008-up Touring models with 10mm brake line. Replaces OEM 41751-06A.

Stock No. 2724-10 10mm

Brake Line Banjo Bolt Crush Washers

Copper crush washers for 2004-2013 Sportster 10mm brake line banjo fittings, replaces OEM 41732-04 and 12mm brake line banjo fittings, replaces OEM 41743-04. 10 pieces per pack.

Stock No. Description

- 2313-10** 10mm
- 2314-10** 12mm

Wheel Cylinder Banjo Bolts

Cadmium plated reproduction of OEM 41743-58 wheel cylinder banjo bolt, complete with OEM 41744-58 gaskets used on 1958-1972 FL, FLH. 3/8-24 thread.

Stock No. 2363-3

Brake Line Banjo Bolts

Chrome plated domed hex bolt or allen bolt fits front and/or rear master cylinders and calipers with 10mm brake line, replaces OEM 41747-82A. Includes 2 copper crush washers. 3/8-24 thread.

Stock No. Description

- 2190-3** Domed hex style
- 2191-3** Allen style
- 2360-3** Pike style

Brake Line Banjo Bolts

Chrome plated domed hex bolt or allen bolt fits front master cylinder with 12mm brake line, replaces OEM 41739-84A. Includes 2 copper crush washers. 7/16-24 thread.

Stock No. Description

- 2192-3** Domed hex style
- 2193-3** Allen style
- 2362-3** Pike style

Brake Line Banjo Bolt Crush Washers

Copper crush washers for 10mm brake line banjo fittings, replaces OEM 4171-82A and for 12mm brake line banjo fittings, replaces OEM 45583-83. 10 pieces per pack.

Stock No. Description

- 2206-10** 10mm
- 2207-10** 12mm

Brake Line Banjo Bolts

Chrome plated domed hex bolt or allen bolt fits 2004-2013 Sportster with 10mm brake line, replaces OEM 41736-04. Includes 2 copper crush washers. 10mm x 1.25 thread.

Stock No. Description

- 2300-3** Domed hex style
- 2301-3** Allen style
- 2359-3** Pike style

Brake Line Banjo Bolts

Chrome plated domed hex bolt or allen bolt fits 2004-2013 Sportster with 12mm brake line, replaces OEM 41737-04. Includes 2 copper crush washers. 12mm x 1.50 thread.

Stock No. Description

- 2302-3** Domed hex style
- 2303-3** Allen style
- 2361-3** Pike style

Brake Line Banjo Bolts

10mm Chrome plated bolt fits front/rear brake lines on 2013-up Dyna, 2014-up Touring and XL, 2015-up Softail. Replaces OEM 11600001.

Stock No. Description

- 2968-3** Domed hex style
- 2969-3** Allen style
- 2970-3** Pike style

Complete Stock Hardware Kits

Each kit contains all the stock motor nuts, bolts, washers and studs for your motor in choice of chrome or cad plating. The kit includes primary cover screws, lifter base screws, circuit breaker screws, case studs and nuts, timing plug, cam cover screws, cylinder base nuts and washers, oil pump nuts and bolts, transmission side cover nuts and washers, transmission top screws, transmission fill plug, generator screws, head bolts and washers. All hardware meets or exceeds original Harley specifications.

Note: Kits 8302 and 8303 do not include valve cover screws.



Stud Installation Tools

High quality, hardened, black oxide finished stud installation tools. Engraved for easy identification.

Stock No. 2398-9 9 piece assortment tray, consists of 1/4", 5/16", 3/8", and 7/16" coarse and fine thread tools.

Stock No. 2394-3 1/4-20, 1/4-28, and 1/4-24

Stock No. 2395-2 5/16-18 and 5/16-24

Stock No. 2396-2 3/8-16 and 3/8-24

Stock No. 2397-2 7/16-20 and 7/16-14

Note: Valve cover screws not included in the following kits: 8302 CHR, 8303 CHR, 8302 CAD, 8303 CAD, 8302 PARK. Please purchase separately.

Stock No.		
8300 CHR	Harley Davidson Knucklehead	1936-1939 Chrome
8301 CHR	Harley Davidson Knucklehead	1940-1947 Chrome
8302 CHR	Harley Davidson Panhead	1948-1957 Chrome
8303 CHR	Harley Davidson Panhead	1958-1965 Chrome
8304 CHR	H-D 74 & 80 Side Valve with Cast Iron Heads	1937-1939 Chrome
8305 CHR	H-D 74 & 80 Side Valve with Cast Iron Heads	1940-1948 Chrome
8306 CHR	H-D 74 & 80 Side Valve with Aluminum Heads	1940-1948 Chrome
8307 CHR	Harley Davidson Shovelhead	1966-1969 Chrome
8308 CHR	Harley Davidson 45 with Cast Iron Heads	1937-1973 Chrome
8309 CHR	Harley Davidson 45 with Aluminum Heads	1937-1973 Chrome
8311 CHR	Harley Davidson Shovelhead	1970-1975 Chrome
8312 CHR	Harley Davidson Shovelhead	1976-1978 Chrome
8313 CHR	Harley Davidson Shovelhead	1979-1980 Chrome
8314 CHR	Harley Davidson Shovelhead	1981-1984 Chrome
8324 CHR	"K" Models	1952-1953 Chrome
8325 CHR	"K" Models	1954-1956 Chrome
8315 CHR	XL, XLH	1957-1966 Chrome
8316 CHR	XLCH	1957-1969 Chrome
8317 CHR	XLH 1967-1970, XLCH 1970	1967-1970 Chrome
8319 CHR	Sportster	1971-1973 Chrome
8320 CHR	Sportster	1974-1976 Chrome
8321 CHR	Sportster	1977-1980 Chrome
8322 CHR	Sportster	1981-1985 Chrome
8323 CAD	VL	Early 1930 Cad
8318 CAD	VL (this kit contains cad or parkerized hardware as required for original finish)	Late 1930-1936 Cad or Parkerized
8300 CAD	Harley Davidson Knucklehead	1936-1939 Cad
8301 CAD	Harley Davidson Knucklehead	1940-1947 Cad
8302 CAD	Harley Davidson Panhead	1948-1957 Cad
8303 CAD	Harley Davidson Panhead	1958-1965 Cad
8304 CAD	H-D 74 & 80 Side Valve with Cast Iron Heads	1937-1939 Cad
8305 CAD	H-D 74 & 80 Side Valve with Cast Iron Heads	1940-1948 Cad
8306 CAD	H-D 74 & 80 Side Valve with Aluminum Heads	1940-1948 Cad
8307 CAD	Harley Davidson Shovelhead	1966-1969 Cad
8308 CAD	Harley Davidson 45 with Cast Iron Heads	1937-1973 Cad
8309 CAD	Harley Davidson 45 with Aluminum Heads	1937-1973 Cad
8310 CAD	2 Cycle Harley Davidson 125, 165, 175 c.c.	1948-1966 Cad
8311 CAD	Harley Davidson Shovelhead	1970-1975 Cad
8312 CAD	Harley Davidson Shovelhead	1976-1978 Cad
8313 CAD	Harley Davidson Shovelhead	1979-1980 Cad
8314 CAD	Harley Davidson Shovelhead	1981-1984 Cad
8324 CAD	"K" Models	1952-1953 Cad
8325 CAD	"K" Models	1954-1956 Cad
8315 CAD	XL, XLH	1957-1966 Cad
8316 CAD	XLCH	1957-1969 Cad
8317 CAD	XLH 1967-1970, XLCH 1970	1967-1970 Cad
8319 CAD	Sportster	1971-1973 Cad
8320 CAD	Sportster	1974-1976 Cad
8321 CAD	Sportster	1977-1980 Cad
8322 CAD	Sportster	1981-1985 Zinc
8300 PARK	Harley Davidson Knucklehead	1936-1939 Parkerized
8301 PARK	Harley Davidson Knucklehead	1940-1947 Parkerized
8302 PARK	Harley Davidson Panhead	1948-1957 Parkerized
8304 PARK	H-D 74 & 80 Side Valve with Cast Iron Heads	1937-1939 Parkerized
8305 PARK	H-D 74 & 80 Side Valve with Cast Iron Heads	1940-1948 Parkerized
8306 PARK	H-D 74 & 80 Side Valve with Aluminum Heads	1940-1948 Parkerized
8308 PARK	Harley Davidson 45 with Cast Iron Heads	1937-1973 Parkerized
8309 PARK	Harley Davidson 45 with Aluminum Heads	1937-1973 Parkerized

Evolution / Twin Cam Headbolts



Evolution/Twin Cam Headbolt Kits

Polished & chrome plated 12 point dome top headbolts add a custom look.

Stock No. 2011-8 L1985-1991 Big Twins, 1986-1992 Sportster.
Replaces OEM 16480-85A and 16478-85A.

Stock No. 2012-8 1992-up Big Twins, 1993-up Sportster.
Replaces OEM 16480-92 and 16478-85A.

Stock No. 2279-16 L1984-E1985 Big Twins.

Evolution/Twin Cam Headbolt Kits

Zinc plated 12 point dome top headbolts.

Stock No. 3019-8 L1985-1991 Big Twins, 1986-1992 Sportster.
Replaces OEM 16480-85A and 16478-85A.

Stock No. 3020-8 1992-up Big Twins, 1993-up Sportster.
Replaces OEM 16480-92 and 16478-85A.



Evolution Headbolt Washers

Headbolt washers are exact duplicates of OEM 16482-85 used on 1984-Early 1985 Big Twins & Sportster.

Stock No. 2017-8 Chrome plated

Stock No. 2018-8 Cad plated

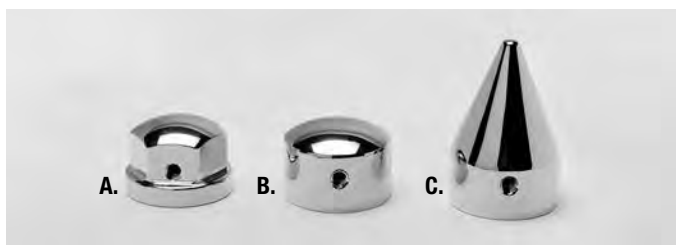

Evolution/Twin Cam Headbolt Covers

Chrome plated headbolt covers to hide dull 12 point headbolts on all late 1985-up FL, FX, XL. Simple installation with set screw. Set of 4.

A. Stock No. 2024-4 Custom hex dome style

B. Stock No. 2232-4 Smooth style

C. Stock No. 2262-4 Pike style



Cylinder Base Stud Kit

OEM style heat treated alloy steel studs equal or surpass original equipment.

Stock No. 9424-8 1985-99 Big Twin Evolution, OEM 16837-85C

Stock No. 9507-8 1986-up Evolution XL, OEM 16832-86C.

Stock No. 2083-8 1999-up Twin Cam 88, OEM 16834-99.



Hi-Performance Cylinder Base Stud Kit

High tensile aircraft quality studs fit 1985-1998 Big Twin Evolution.

Stock No. 2442-8

Headbolts- Original Equipment Style

These head bolt, head nut and washer kits are the highest quality available. They are accurately machined from high strength steel and hardened to original Harley specifications to prevent stretching. All bolts feature rolled threads for superior strength and fit. All bolts, nuts, and washers are plated for corrosion resistance and clean appearance.



Head Bolt Kits (Plain heads except as noted)

Description	Chrome Stock No.	Cad Stock No.	Parkerized Stock No.
1929-1934 Singles incl. Washers			3061-14
Harley '74' and '80' w/Alum. Heads	8216-18	7711-18	9727-18
Harley '45' w/Aluminum Heads	8217-18-45	7711-18-45	9705-18-45
Harley Early 1930 VL (7/16-20 Thread) incl. washer			3260-36
Harley '45', '74', '80' w/Cast Iron Heads	8218-36	7712-36	9728-36
Knucklehead 1936-1939 Incl. Washers	8219-20	7713-20	9725-20
Knucklehead 1940-1947 Incl. Washers	8220-20	7714-20	9726-20
Knucklehead 1940-1947 Incl. Washers			3127-20 CP1035
WL & G Models w/Cast Iron Heads 1951-1973	9888-16	9889-16	
'K' Models 1952-1953	9640-16	9641-16	
'KH' Models 1954-1956	9642-16	9643-16	
Panhead/Shovel 1948-1976 Incl. Washers	8221-20	7825-20 CP1038	2963-20 CP1038
Shovelhead 1977-1984 (Flanged Hex Head)	2967-10 CP	2966-10 CP	
Sportster 1957-1972 Incl. Washers	8944-16	8945-16	
Sportster 1973-1985 Incl. Washers	9211-16 CP	9212-16 CP	
Headbolt, OEM 16813-65, Alternator "45" models 1965-1973	2055-1	2056-1	
WR, WLDR 1940-1951			2435-16

Head Bolt Washer Kits

Description	Chrome	Cad	Parkerized
Harley Aluminum Flathead Washer Kit (Early style with tapered top)			2432-18
Harley Aluminum Flathead Washer Kit	8215-18	7710-18	9698-18
All Harleys 1936-up with 7/16 Bolts (6469)	8488-10	8170-10	9704-10
All Harleys OHV, Sidevalves w/ Cast Iron Heads (6486)	2008-10	2009-10	2010-10

12 Point Head Bolts

Description	Chrome	Cad	Black Oxide
Panhead/Shovel 1948-up incl. Washers	8714-20 CP		8618-20 CP

Cylinder Head Nuts and Studs

OEM duplicate nuts, washers and studs used on 45's with cast iron heads and 3/8-16 head studs.



- A. Stock No. 2183-16** Fits 1929-1950. Replaces OEM 16802-29 studs with 3/8-16 thread. Contains 16 studs, parkerized.
- B. Stock No. 2152-36** Fits 1929-1941 45's with cast iron heads and 3/8-16 head studs. Contains 12 pcs of OEM 15-26 long nuts, 6 pcs of 0120 short nuts and 18 pcs of 0224 washer, parkerized. Also fits 1926-1932 singles.
- C. Stock No. 7709-32** Fits 1942-50 45's with cast iron heads and 3/8-16 head studs. Contains 16 pieces of 15-26 long nuts and 16 pieces of OEM 0224 washers, cad plated.



Electrical Hardware

Instrument Panel Dash Base Contact Spring Kit

Accurate reproduction of contact springs, OEM 4508-36, 4557-37, and 4508-38 used on 1936-1946 Big Twins and 45's. See Colony Kit 2714-36 for all fasteners.

Stock No. 2609-4



Instrument Panel Light Shield Kit

Cadmium plated reproduction of OEM 4523-39 and 4523-39A used on 1936-1946 Big Twins and 45's.

Stock No. 2671-2



Panel Light Switch Kit

Cadmium plated reproduction of all parts except for switch knob. Fits 1937-1946 Big Twins and 45's. See our selection of switch knobs for your application.

Stock No. 2810-13

1937-1938 Big Twins

Stock No. 2811-13

1939-1946 Big Twins and 45's



Instrument Panel Dash Base Side Bulb Contact Springs

Cadmium plated reproduction of 4509-38 contacts used on 1938-1946 Big Twins and 45's. See Colony Kit 2714-36 for all fasteners.

Stock No. 2862-2



Instrument Panel Base Restoration Kit

OEM style hardware used to restore instrument panel base on 1939-1946 Big Twins. Complete with rivet installation tools.

Stock No. 2714-36

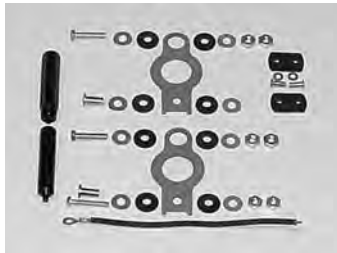

Negative Brush Holder Assembly

Cadmium plated reproduction of OEM 30367-32 special nuts, screws, and washers (OEM Kit #30353-32) used on 1932-1951 Big Twins and 45's.

Stock No. 2863-7



Instrument Panel Base Restoration Kit

OEM style hardware used to restore instrument panel base on 1947-1957 Big Twins.

Stock No. 2713-42



Switch Stem Handle

Cadmium plated reproduction of the original knurled switch stem handle used on 1937-1938 Big Twins. OEM 4556-37.

Stock No. 2610-1



Panel Switch Knob and Screw Kit

Chrome or parkerized dome top knobs, OEM 4556-39, used on 1939-early 1943 45's and Big Twins. Includes special 4-36 cad plated screw, OEM 4558-43.

Stock No. 2562-2

Chrome

Stock No. 2563-2

Parkerized



Panel Switch Knob and Screw Kit

Chrome or parkerized flat top knobs, OEM 4556-42, used on late 1943-1946 45's and Big Twins. Includes special 4-36 cadmium plated screw and washer, OEM 4558-43.

Stock No. 2560-2

Chrome

Stock No. 2561-2

Parkerized



Electrical Hardware



Electrical Terminal Box Assembly

This quality reproduction terminal box is now available pre-assembled, painted black, and ready to install. They are properly insulated to eliminate grounding and include all necessary mounting hardware. The installation of this box and a new wire harness is a must when restoring the electrical system on Harley Big Twins and '45's 1948-69.

Stock No. 8005-12



Battery Terminal Kit

These faithfully reproduced battery terminal fasteners and felt washers will add a look of authenticity to any restoration. Fits all 6 volt Harley Davidsons 1923-65.

Stock No. 7615-4 Early style shoulder nuts (shown)
Stock No. 3313-6 Late style hex nuts



Battery Box Mounting Kit

Reproduction of original hardware mount battery box on 1965-1984 FX, FL and 1967-1978 XL.

Stock No. 2331-20



Headlight Restoration and Mounting Kit

Cad plated hardware to restore bucket and mount headlight on Big Twin and 45 Springers 1935-1948.

Stock No. 8943-27 (shown)

Stock No. 2006-3 1949-1959 Big Twins and 1952-1958 XL, K, KH. Consists of OEM P/N 67815-45 beveled washer, 7918 nut and lockwasher.

Stock No. 2307-3 1959-up XL, XLH, XLCH, XLX, XLS. Consists of OEM 67815-59A beveled washer, 7845 nut and lockwasher.



Electrical Terminal Plate

This quality reproduction terminal plate is pre-assembled, painted black and ready to install with mounting hardware provided in kit. All hardware and insulators are identical to O.E.M. Use this kit on restorations or custom bike applications. Fits all 1970-77 FL, FX. OEM 72300-70.

Stock No. 9639-22



Electrical Terminal Plate

Quality reproduction of the original board and hardware.

Stock No. 2305-12 Big Twins 1949-1957

Stock No. 2306-16 Big Twins 1958-1969



Frame Electrical Terminal Screws and Fittings

Duplicate of O.E.M. Kit No. 1523-26A. Contains insulators, screws and nuts as original. Fits 1936-1947 Big Twins and 45's.

Stock No. 8942-14

A. Circuit Breaker Post Rebuild Kit

This item is an accurate reproduction of a repair kit offered by Harley in the 1940's and '50's to repair damaged and broken posts and insulators on all model Harleys 1930-1948. The Colony kit also provides an installation tool to install post.

Stock No. 8848-6 With Tool

Stock No. 3229-5 Without Tool

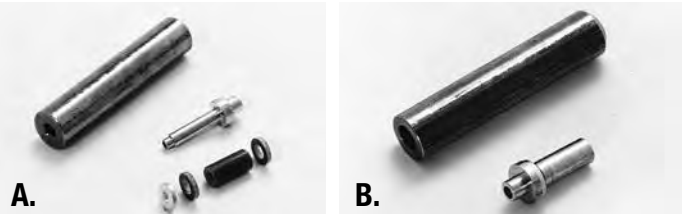

B. Circuit Breaker Post Rebuild Kit

Accurate reproduction of brass circuit breaker post fits the following Harley Davidson models: 1948-69 FL, XL, K, and 45. Kit contains 1 post and 1 installation tool.

Stock No. 8849-2

Electrical Hardware

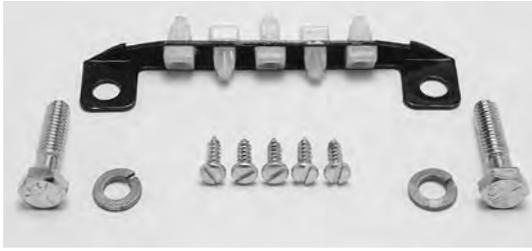

Electrical Terminal Plate

Quality painted and pre-assembled terminal plate includes mounting hardware. Fits 1970-1974 FX, XL. OEM 72303-70.
Stock No. 9817-15



Generator Mounting Kit

Faithful reproduction of strap hardware and shims used on all Harley Davidson 1930-1957.

Stock No. 8214-7 Cad Plated
Stock No. 9681-7 Parkerized



Generator Positive Terminal Screw Kit

Correct reproduction of the original hardware.

Stock No. 2126-12 1932-1957 All Harley models
Stock No. 2127-11 1958-1969 Big Twins, 1958-65 Servi-Car, 1958-1981 Sportster



Generator Pole Shoe Screw Kit

Parkerized reproduction of OEM screws.

Stock No. 9520-4 All Twins 1918-1950, Type 1, Oval head style, OEM 30280-18. (4/kit)

Stock No. 3214-4 All Twins 1951-1957, Type 2, Flat head style, OEM 30280-18. (4/kit)

Stock No. 2476-2 Big Twins 1958-1969, XL 1958-1981, OEM 30280-58, 2/kit (shown)

Voltage Regulator Mounting Kit

OEM style fasteners mount regulator on 1965-1969 FL, FLH.

Stock No. 2329-9



Front Fender Lamp Wire Kit

Steel tube, clamps, nuts, connectors, wire and loom will secure wire to fender as original. Duplicate of OEM Harley Davidson kit fits 1935-1947 all models. Instructions included.

Stock No. 9786-11



Beehive Tail Lamp Mounting Kit

Parkerized OEM style exact reproduction screws and nuts to properly mount beehive tail lamp on all 1939-1946 Harley Davidson. Screws also fit 1936-1938 dash cover.

Stock No. 9813-12



Front Fender Lamp Gaskets and Screws Kit

Reproduction of 13402-47 and 13402-35 gaskets and 13403-35 and 13404-35 screws used on 1935-1948 Springers.

Stock No. 3240-4



Electrical Hardware



Tail Light Bracket Mounting Kit

Parkerized 5055-47A screw and cadmium plated 5055-47C flexloc nut used on 1947-1948 Harley Tombstone taillight bracket.

Stock No. 2778-4



Circuit Breaker Mounting Clamp and Stud Kit

Cadmium plated 32516-66 clamp, 24811-63 stud and 7683 flexloc nut used on 1966-1969 FL, FLH.

Stock No. 2948-3



Timer Clamp Kit

Zinc plated clamp, OEM 32515-66 and screws, OEM 3422W used on 1966-1970 XLH and 1970 XLCH.

Stock No. 2961-3

Brake Switch Clip Kit

Reproduction of 42281-35A bracket, 42282-35A stud and 7688 nut used on 1966-1974 XLH, XLCH.

Stock No. 3224-3



Rear Brake Spring and Brake Lock Pull

Reproduction of 2958-35 Type 2 pull, stud, wing nut used on 1937-1938 45's, 1937-E 1940 Big Twin brake spring pull and 1937-E 1940 45 brake lock.

Stock No. 2918-3



Generator Frame Screw Kit

Parkerized OEM 30012-32 screws used on 1932-1957 Harley Twins. Screws are 5-1/2" long.

Stock No. 2964-2



Tail Light Cover Screw Kit

Stainless steel screws, OEM 11375-38, set of 3, used on 1947-1954 Big Twins Tombstone tail light cover.

Stock No. 2965-3



Rear Brake Switch Pull Kit

Cadmium plated bracket, stud, wing nut, parkerized pull wire and black spring used on 1940-1957 Big Twins.

Stock No. 2998-5

Rear Brake Switch Pull Kit

Parkerized bracket, stud, wing nut, pull wire and black spring used on 1940-1957 Big Twins.

Stock No. 2999-5

Rear Brake Switch Pull Kit

Cadmium plated bracket, stud, wing nut, parkerized pull wire and black spring used on 1939-1952 45's.

Stock No. 3001-5

Rear Brake Switch Pull Kit

Parkerized bracket, stud, wing nut, pull wire and black spring used on 1939-1952 45's.

Stock No. 3002-5



Circuit Breaker to Coil Wire Assembly

Accurate reproduction of complete assembly used on 1936-1964 All Twins.

Stock No. 2542-10 1936-1948

Stock No. 2543-10 1949-1964



Ignition Cover Timer Stud Kit

Reproduction of original ignition timer cover studs, set of 2.

Stock No. 2538-2 Stock 8-32 thread

Stock No. 2745-2 Oversized 10-32 thread 1972-1979 Big Twins and Sportster (replaces OEM 32601-78)

Stock No. 2540-2 Stock 8-32 thread

Stock No. 2743-2 Oversized 10-32 thread 1980-up Big Twins and Sportster (replaces OEM 32606-82 and 32601-80)



Circuit Breaker Adjusting Screw Kit

Cadmium plated fasteners, OEM 32593-47, 1062 and 7744 used on 1947-1964 Big Twins, 45's, XL. (all battery models)..

Stock No. 2632-3



Headlight Visor Mounting Kit

Chrome plated bolts and washers used to mount headlight visor on 1959-up all FX and XL models.

Stock No. 9784-4



Distributor Adjuster Plate

Reproduction of OEM 32594-47 plate, correctly made from spring steel, used on 1947-1964 all Twins, K, KH, Sportster.

Stock No. 3094-1

Electrical Hardware



Horn Diaphragm Screw and Nut Kit

Parkerized reproduction of OEM 4811-31 nut and 4810-31 screw used on 1931-1957 Delco-Remy horns.

Stock No. 3225-2



Light Switch Contact Pin

Correct reproduction of 71859-29 (4770-29) pin with correct headpoint for proper contact and spring 71861-29 (4771-29)..

Stock No. 3280-2



Circuit Breaker and Voltage Regulator Screw Kit

Reproduction of OEM screws and washers.

Stock No. 8145-10 1936-1964 OHV Big Twins, Chrome plated

Stock No. 8146-10 1936-1964 OHV Big Twins, Cad plated

Stock No. 9684-10 1936-1964 OHV Big Twins, Parkerized

Stock No. 9414-8 1937-1973 45's Chrome plated

Stock No. 9415-8 1937-1973 45's Cad plated

Stock No. 9665-8 1937-1973 45's Parkerized

Electrical Hardware

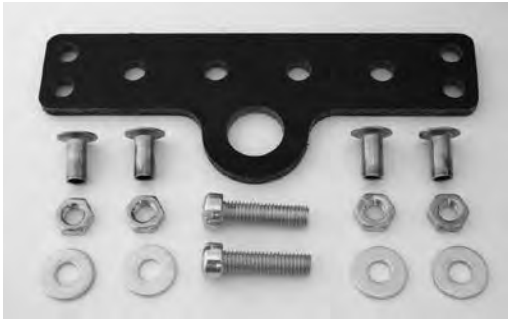

Horn Terminal Board Kit
 Reproduction of OEM 4829-42M board and fasteners. Used on 1942-1952 WLA, WLC, XA.
Stock No. 2789-15



Horn Terminal Board Kit
 Reproduction of OEM 4829-42 board and fasteners. Used on all models 1942-1946 except WLA, WLC.
Stock No. 2819-8



Battery Box Lid Wing Nuts
 Reproduction of 66387-26, 4409-26 battery lid 5/16-18 thread wing nuts. 4 per kit.
Stock No. 3100-4 Cadmium plated
Stock No. 3174-4 Parkerized



Battery Box Lid Wing Nuts
 Reproduction of 66387-24, 4409-24 battery lid 1/4-20 thread wing nuts. 4 per kit.
Stock No. 3184-4 Cadmium plated
Stock No. 3185-4 Parkerized



Battery Box Lid Wing Nuts
 Reproduction of late dimple style 66387-26 battery lid 5/16-18 thread wing nuts. 4 per kit.
Stock No. 3183-4 Zinc plated



Battery Box Lid Wing Nuts
 Reproduction of late dimple style 66387-24 battery lid 1/4-20 thread wing nuts. 4 per kit..
Stock No. 3249-4



Ignition Switch Contact Roller
 Reproduction of 71560-36 roller used on 1936-1984 Big Twins.
Stock No. 3172-1



Breaker Point Eccentric Screw
 Duplicate of 30507-47A screw used on 1947-Early 1963, 1965-1969 FL, FLH and 1954-1970 KH, XL, XLH, 1970 XLCH.
Stock No. 3146-1



Air Horn Cover Mounting Kit
 Reproduction of 1408-35 screws used on 1935-1936 R, RL, RLD, VLD, VLH, and 1936 Knucklehead. Cadmium plated..
Stock No. 3147-2

Electrical Hardware



Headlamp Housing Mount Kit

Cadmium plated reproduction of OEM 2824W screws used on 1960-1978 FL, FLH.

Stock No. 3188-4



Headlight Bracket Mounting Kit

Reproduction of original fasteners used to mount headlight bracket when no ride control or shock absorber is used on 1936-1948 Big Twins and 1940-1957 45's.

Stock No. 2777-9

Cadmium Plated

Stock No. 2776-9

Chrome Plated



Switch Box Fastening Bolt Kit

Duplicate of OEM 4506-39A bolts and lockwashers used on 1929-1931 D, DL, DLD, 1930-1936 V, VL, VLD, VLE, VLH and 1932-1936 R, RL, RLD.

Stock No. 3202-4 Parkerized

Stock No. 3204-4 Nickel Plated

Headlamp & Horn Bracket Insulator Terminal Kit with Fender Lamp Wires

Insulators, wires, steel and brass hardware for headlamp bracket to fender light on 1945-1948 Big Twins and 1945-1957 Servi-car.

Stock No. 2096-14

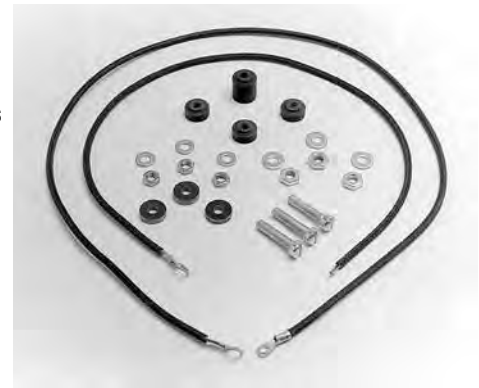

Headlamp Bracket Mounting Kit

Complete kit to mount the headlight bracket on 1955-1959 Big Twins.

Stock No. 2108-12



Spotlight Rebuild Kit

Rebuild kit for Guide Spotlight used on all 1938-1961 Harley models. Includes cad plated hardware to restore and mount bracket and correct wire assembly.

Stock No. 2568-24



Spotlight Mounting Kit

Reproduction of 3960, 3956 CP 1038 bolts, 6702 washers, 58102-49 spacers and locks used on 1949-1978 Big Twins.

Stock No. 3294-16 Parkerized

Stock No. 3295-16 Cadmium Plated

Stock No. 3296-16 Chrome Plated

Spotlight Fork Bracket Bolt Nut Kit

Reproduction of 68620-46 nuts and washers used on 1938-1961 all Harley models with spotlights.

Stock No. 2757-6 Chrome

Stock No. 2758-6 Cadmium



Headlight Lens Retainer Spring Set

Reproduction of 67733-35 (4910-35) springs used on Springer headlights, 1936-1948 Big Twins 1935-1952 45's, and 1935-1957 Servi-car.

Stock No. 3287-2



Spotlight Mounting Kit

Reproduction of 3960W, 4014W, 3974W bolts, 58102-49 spacers, 6702, 6336B washers and locks used on 1979-1984 FL, FLH.

Stock No. 3297-18 Zinc Plated

Stock No. 3298-18 Chrome Plated

Coil Mounting Hardware



Coil Mounting Kit

Complete quality reproduction coil mounting kit for 1930-36 VL and 1929-47 45's. Contains: 1728-30 plate, 1723-30 u-bolts, 1724-29 u-bolt straps, 0256 lockwashers, 0107 nuts, 31728-30 screws and screw plates.

Stock No. 2327-23



Spark Plug Cable Packing Nut Kit

Faithful reproduction of coil nuts and packing used on Harley Davidsons 1927-59. Cad plated as original.

Stock No. 7804-6



Coil Mounting Kit

Complete quality reproduction coil mounting kit for 1937-1947 UL, Knucklehead. Contains: 1723-36 u-bolts, 1723-36A spacers, 0256 lockwashers, 0107 nuts and 1724-29 u-bolt straps.

Stock No. 2281-18

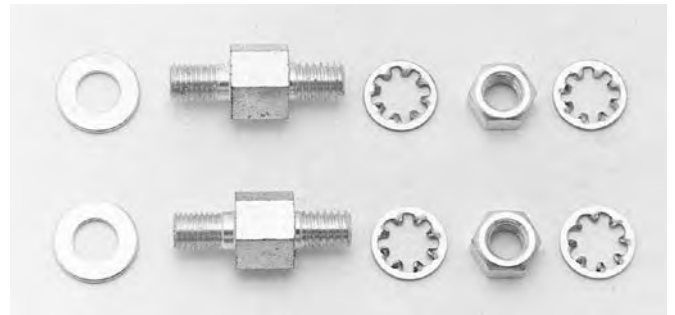

Coil Mounting Stud Kit

Cad plated studs, nuts and washers to mount coil and terminal box to frame on Big Twins and 45's.

Stock No. 8823-10

Big Twins and 45's 1948-1955.

Replaces OEM 72341-48

Big Twins 1956-1982.

Replaces OEM 72341-56A

Stock No. 8824-8



Magneto Adapter Plate Screw Kit

Duplicate of OEM 29601-48 screws, 3791 bolts and 7683 flexloc nuts used on 1958-early 1962 XLCH.

Stock No. 2884-6 Cadmium Plated

Handlebar Hardware



Handlebar Riser Washer Kit

Decorative chrome plated cupped washers used on handlebar risers. Fits most models 1973-up. Set of 4 pieces. Replaces OEM 56159-73.

Stock No. 2123-4



Custom Handlebar Riser Washer Kit

Chrome plated custom handlebar riser washers are machined and heavier than stock to eliminate "cupping". Fits most models 1973-up. Replaces OEM 56159-73. Set of 4 pieces.

Stock No. 2415-4



Handlebar Damper Kit

Bushings are made from high density poly for a stiffer construction than stock rubber units. Complete with spacers. Fits 1973-up Big Twins and Sportsters. Replaces OEM 56158-73, 53156-86, and 56153-73.

Stock No. 2349-6



Custom Billet Cone Head Riser Bolt Covers

Chrome plated riser bolt covers add a custom billet look. Many applications using 1/2" socket head riser bolt.

Stock No. 2417-2



Handlebar Riser Cover Mounting Kit

Accurate reproduction of OEM 56167-49 studs and OEM 7736 acorn nuts used to mount the riser cover on 1949-1959 Big Twins.

Stock No. 2147-8



Riser Bolt Sets

Riser bolts to be used on many stock and aftermarket applications. Each kit contains 2 bolts and 2 lockwashers. Available in chrome plated smooth head allen, chrome plated hex head bolt or cadmium plated hex head bolt.

Size	Allen	Hex Head	Cadmium Hex Head
1/2-13 x 2-1/2	2094-4	2135-4	2245-4
1/2-13 x 2-3/4	2095-4	2136-4	2246-4
1/2-13 x 3	2129-4	2137-4	2247-4
1/2-13 x 3-1/2	2130-4	2138-4	2248-4
1/2-13 x 3-3/4	2131-4	2139-4	2249-4
1/2-20 x 2-1/2	2132-4	2242-4	2250-4
1/2-20 x 2-3/4	2133-4	2243-4	2251-4
1/2-20 x 3	2134-4	2244-4	2252-4



Handlebar Damper Kit

Stock style rubber bushings and spacers used on all Big Twins and Sportsters 1973-up. Replaces OEM 56158-73, 53156-86, and 56153-73.

Stock No. 2428-6



Handlebar Riser Mounting Kit

Reproduction of parkerized OEM 56154-49 bolts and cad plated OEM 7900 flexloc nuts used on 1949-1959 Big Twins.

Stock No. 2680-4



Custom Billet Cone Head Riser Bolt Covers and Bolts

Chrome plated riser bolt covers add a custom billet look. Complete with 1/2-13 x 2-3/4 chrome plated smooth head allen screws. Fits 1997-up FXST, FXSTB, FXSTC and FXSTD. Also fits 1993-2000 FXR and 1991-up Dyna models.

Stock No. 2416-4

Handlebar Hardware



Handlebar Throttle & Spark Roller & Pin Kit

Hardened and ground rollers, pins, coil plug set screws, control wire ends.

Stock No. 8923-8 All H.D. 1910-1948 OEM's 9281, 56278-10, 56283-31, 56276-31.

Stock No. 8924-8 All H.D. 1954-1974 OEM's 9261, 56278-10, 56276-31.



Handlebar End Nuts

Exact reproduction of handlebar end nuts used on 1910-1974 Harley Davidson.

Stock No. 9114-2 w/57/64-24 thread fits all models 1910-21 and 1930 VL.

Stock No. 7625-2 w/13/16-24 thread fits all Twins 1931-36, 1931-39 45's.

Stock No. 7626-2 w/57/64-24 thread fits 1922-30 all models, 1937-48 Big Twins, 1940-up all models

Stock No. 9214-2 w/3/4-16 thread fits K, XL 1954-72, FL 1954-74.

Handlebar Bolt Kit

Machined reproduction of pinch bolts and lockwashers. Plain Head.

Stock No. 2749-4 1936-1939 Big Twins Replaces OEM 6033-30.

Stock No. 2750-4 1937-1939 45's Replaces OEM 2655-37.

Stock No. 2992-4 1940-1948 Big Twins Springer, 1940-Up 45 Springers replaces OEM 4636.



Handlebar Bolt Kit

Duplicate of pinch bolts used on 1940-1948 Big Twin Springers, 1940-up 45 Springers. OEM 4636 includes lockwashers. CP 1035.

Stock No. 9217-4 Chrome Plated

Stock No. 9218-4 Cad Plated

Stock No. 9508-4 Parkerized



Handlebar Grip Retainer Kit

Retainers 56235-47 and 56240-47 screws used on 1949-1953 Big Twins, 45's, K Models, and 1948-1949 Lightweights.

Stock No. 2181-6 Chrome Plated

Stock No. 3083-6 Cad Plated



Handlebar Plunger

Accurate reproduction of throttle and spark plunger. 2 plungers per kit for the following:

Stock No. 9505-2 1936 61", 1937-1948 Big Twin, 1940-1948 45 Solo and Servi-Car, OEM 3316-36.

Stock No. 9804-2 1931-1939 45 Solo and Servi-Car, 1931-1936 VL. OEM 3316-31.

Handlebar Plunger

Accurate reproduction of throttle and spark plunger, OEM 56400-53. Fits 1954-1974 FL, 1971-1973 FX, 1954-1973 XL, 1954-1973 Servi-Car. 1 plunger and 1 set screw per kit.



Stock No. 9514-2



Control Coil End Plugs

Set of 2 reproduction plugs.

Stock No. 3241-2 OEM 56410-47 plugs used on 1949-1954 all Harley models, 1954-1957 Servi-Car with rubber mounted handlebars. Right hand thread, .188" cable.

Stock No. 3242-2 OEM 56410-53 plugs used on 1954-1974 Big Twins, 1954-1973 K, KH, XL, 1958-1973 Servi-Car with rubber mounted handlebars.

Stock No. 3243-2 Replaces OEM 3332-10, 3332-31. Used on 1910-up Singles, 1931-1939 45's, Servi-car, 1931-1936 VL. Left hand thread. .240" cable. .778" OD.

Stock No. 3315-2 OEM 3332-16 plugs used on 1936 61", 1940-1948 45 Solo and Servi-car. Left hand thread. .240" cable. .833" OD.



Triple Tree Pinch Bolt Set

Chrome plated hex bolts and lockwashers fit all FL and Wideglide models.

Stock No. 9803-4

Handlebar Plunger

Accurate reproduction of handlebar plunger, OEM 56391-49. Fits 1949-1953 Big Twins and 45's.

Stock No. 2304-2



Handlebar Grip Retainer Kit

Chrome plated retainers 56235-47, 56235-49, and 56240-47 screws used on 1950-1959 Lightweights.

Stock No. 2182-4

Handlebar Hardware



Hand Brake Lever Screw Kit

Parkerized reproduction of 4154-28 and 4156-28 screws and 4157-28 spring washer used on 1928-1940 all Harley brake levers.

Stock No. 2958-4



Clutch and Brake Hand Lever Bushing

Reproduction of bushing, washer and cotter pin, cadmium plated.

Stock No. 2809-3 1949-1964 All models, OEM 45033-49 bushing.

Stock No. 2730-3 1941-1948 All models, OEM 45033-41 bushing.



Clutch Hand Lever Bracket Clamp Kit

Correct reproduction of 38710-41 clamp, screws and nuts used on Late 1953-1964 K, KH, XL and 1941-1948 Big Twins, 45's and Servi-car.

Stock No. 3128-5 Cadmium plated

Stock No. 3129-5 Parkerized



Clutch and Brake Lever Pivot Screw Kit

Cad plated reproduction of pivot screws and nuts used on clutch and brake levers. Big Twins and 45's 1941-1964.

Stock No. 8819-4



Clutch and Brake Lever Repair Bushings

Bushings are designed to fix worn out brake and clutch lever pivot holes on 1941-1964 levers. Use 7/16" drill to open holes to correct size.

Stock No. 3216-2



Hand Clutch Adjusting Screw Kit

Cadmium plated 38674-52 adjuster and 7744 nut used on 1952-1967 FL, FLH.

Stock No. 3063-2



Front Brake Hand Lever Bracket Clamp Kit

Correct reproduction of 45030-28 clamp, screws and nuts.

Stock No. 3130-5 1941-1954 all Harley models, cadmium plated

Stock No. 3131-5 1941-1954 all Harley models, parkerized

Stock No. 3132-5 1955-1964 all Harley models, cadmium plated

Transmission Kicker Cover



Transmission Kicker Cover Stud Kit

Quality reproduction of OEM kicker cover studs used on all Big Twin 1936-84. 9 pieces OEM P/N 33298, 4 pieces OEM P/N 24818-52.

Stock No. 9637-13 Parkerized
Stock No. 3144-13 Cadmium



Panhead Valve Cover Screws

Duplicate of screws used on Harley Panhead valve covers 1951-1954.

Stock No. 2850-24 Cadmium/Parkerized



Panhead Valve Cover Screws

Exact duplicate of special screws used on all Harley Panhead valve covers 1948-1965.

Stock No. 8732-24 Chrome Plated. Use with Aluminum 'D' Rings.
Stock No. 8733-24 Cad Plated. Use with Aluminum 'D' Rings.



Stock No. 8734-24 Chrome Plated. Use with Steel 'D' Rings.
Stock No. 8735-24 Cad Plated. Use with Steel 'D' Rings.

Panhead Valve Covers Washers (not shown)

Exact duplicate of washers, OEM 6150W, used under hold down screws on 1954-1965 Panheads.

Stock No. 9984-24 Chrome Plated.
Stock No. 9985-24 Cad Plated.

Oversized Panhead Valve Cover Screws

Stock style screws with oversized 1/4-20 threads to be used for stripped heads on 1948-1965 Panheads. 6 screws per kit.

Stock No. 2013-6 Chrome Plated, use with Aluminum "D" Rings.
Stock No. 2014-6 Cad Plated, use with Aluminum "D" Rings.
Stock No. 2015-6 Chrome Plated, use with Steel "D" Rings.
Stock No. 2016-6 Cad Plated, use with Steel "D" Rings.



Transmission Side Cover Kit

Chrome plated transmission side cover and clutch arm nuts fit all Harley Big Twin 1936-84 with 4 speed.

Stock No. 7112-19 Acorn Style
Stock No. 8442-19 Cap Style



Transmission Side Cover Kit

Available in two styles these chrome plated transmission side cover nuts have extra deep threads for long studs. Fits all Big Twin 1936-84 with 4 speed.

Stock No. 8751-19 Acorn Style
Stock No. 8752-19 Cap Style



Transmission Side Cover Kit

Stock Harley hardware kit contains nuts and washers for the transmission side cover and clutch arm. Available in choice of plating. Fits all Big Twins to 1984.

Stock No. 8112-20 Chrome Plated
Stock No. 8113-20 Cad Plated
Stock No. 9671-20 Parkerized



Transmission Top Cover and Side Cover Mounting Kits

Quality reproduction machined studs, nuts, and washers for that perfect restoration.

Stock No. 2377-36 Transmission Top Cover, 1915-1930 Twins, Nickel Plated
Stock No. 2379-36 Transmission Top Cover, 1915-1930 Twins, Parkerized
Stock No. 2381-24 Transmission Side Cover, 1915-1930 Twins, Nickel Plated
Stock No. 2382-24 Transmission Side Cover, 1915-1930 Twins, Parkerized
Stock No. 2380-36 Transmission Top Cover, 1931-1936 VL, Parkerized
Stock No. 2383-24 Transmission Side Cover, 1931-1936 VL, Parkerized

Replacement Hardware



Transmission Top Cover Screw Kit

Duplicate of OEM screws used to mount the transmission top cover.

- Stock No. 9612-13** Big Twins 1936-1955, Chrome (Hex Vent Plug)
- Stock No. 9613-13** Big Twins 1936-1955, Cad (Hex Vent Plug)
- Stock No. 9620-13** Big Twins 1936-1955, Parkerized (Hex Vent Plug)
- Stock No. 8147-13** Big Twins 1956-1964, Chrome
- Stock No. 8148-13** Big Twins 1956-1964, Cad (SHOWN)
- Stock No. 2103-13** Big Twins 1950-1953, Chrome (Phillips)
- Stock No. 2104-13** Big Twins 1950-1953, Cad (Phillips)
- Stock No. 8748-12** Big Twins 1965-1978, Chrome (Allen)
- Stock No. 8749-12** Big Twins 1965-1978, Cad (Allen)
- Stock No. 9656-8** FL, FX 4-speed 1979-1985, Chrome (Hex Head)
- Stock No. 9657-8** FL, FX 4-speed 1979-1985, Zinc (Hex Head)



Transmission Side Cover Screw Kit

Duplicate of OEM 2278 screws used on all 45's 1929-1973.

- Stock No. 9300-5** Chrome
- Stock No. 9301-5** Cad
- Stock No. 9687-5** Parkerized



Leg Shield U-Bolt and Fairing Mount Kit

Parkerized 58563-51 u-bolts used on Late 1951-Early 1977 Big Twin leg shields and 1952-up KRTT fairing mount.

Stock No. 3153-6



Transmission Top and Side Cover Screw Kit

Duplicate of OEM screws used to mount the transmission top and side cover on all 1937-1973 45's.

- Stock No. 9410-27** Chrome
- Stock No. 9411-27** Cad
- Stock No. 9666-27** Parkerized



Legshield Mounting Kit

Accurate reproduction of all fasteners required to mount legshields on 1940-1942 WLA. Machined plain head bolts.

Stock No. 2597-17



Skid Plate Mounting Hardware

Reproduction of fasteners required to mount skid plate on 1940-1942 WLA. Machined plain head bolts.

Stock No. 2590-13

Transmission Mounting Hardware



Transmission Mounting Kits

Complete transmission mounting kits are faithful reproductions of stock Harley hardware.

- Stock No. 9837-10** All H.D. 45'S 1929-1974, Chrome
- Stock No. 9838-10** All H.D. 45'S 1929-1974, Cad
- Stock No. 9839-10** All H.D. 45'S 1929-1974, Parkerized
- Stock No. 8231-26** Big Twins 1936-1964, Chrome (SHOWN)
- Stock No. 8232-26** Big Twins 1936-1964, Cad (1035, 1038 CP)
- Stock No. 9695-26** Big Twins 1936-1964, Parkerized (1035, 1038 CP)
- Stock No. 2314-36** 1936-1947 Big Twins, Parkerized (Machined Plain Head Bolts)
- Stock No. 9418-19** Big Twins 1965-Early 1977, Chrome
- Stock No. 9419-19** Big Twins 1965-Early 1977, Zinc
- Stock No. 9420-21** Big Twins Late 1977-1986, Chrome
- Stock No. 9421-21** Big Twins Late 1977-1986, Zinc
- Stock No. 9866-18** FXST 1986-1999, Chrome
- Stock No. 9867-18** FXST 1986-1999, Zinc



Cam Follower and Retainer Kit

Reproduction of 34064-52 retainer, 34062-52 cam follower, 34066-52 lock and 34068-52A spring used on 1952-1979 FL, FLH, and 1971-1979 FX.
Stock No. 3032-4



Shifter Cam Plunger Kit

Kit consists of 34053-36 parkerized cap, 8872 ball and 34057-36 spring. Fits 1936-76 Big Twin with handshift & 1940-1973 '45's.
Stock No. 9983-3



Transmission 2nd Gear Retaining Bracket Locktab and Bolt Kit

Parkerized duplicate of OEM 3754 screws and 35335-33 locktab used on 1935-1973 45's.

Stock No. 2734-3



Transmission Adjusting Bolt

Quality reproduction adjusters used on 45's and Big Twins.

- Stock No. 2975-1** J, JD, VL 1925-1936, Cad
- Stock No. 9729-1** All H.D. 45's 1929-up, Chrome
- Stock No. 8625-1** All H.D. 45's 1929-up, Cad (SHOWN)
- Stock No. 9693-1** All H.D. 45's 1929-up, Parkerized
- Stock No. 9735-1** Big Twins 1936-64, Chrome
- Stock No. 9736-1** Big Twins 1936-64, Cad
- Stock No. 9737-1** Big Twins 1936-64, Parkerized



Transmission Case Bottom Stud Kits

Quality reproduction studs available in standard, oversize and extra oversize sold in sets of 4 with Parkerized finish.

- A. Stock No. 9653-4** 3/8-16 x 3/8-24, 1936-83 Big Twins
- B. Stock No. 9654-4** 7/16-14 x 3/8-24, 1936-83 Big Twins
- C. Stock No. 9655-4** 1/2-13 x 3/8-24, 1936-83 Big Twins
- D. Stock No. 9863-5** 7/16-14 x 3/8-24, 1984-up Softail (NOT SHOWN)
- E. Stock No. 9919-3** 7/16-14 x 7/16-20, 1929-up Harley 45's (NOT SHOWN)
- F. Stock No. 3098-4** 1915-1936 Twins (except 1936 EL) (NOT SHOWN)



Transmission Adjuster Screw Support Strap

Duplicate of 47720-36 bracket used on 1936-1957 Big Twins.

- Stock No. 3095-1** Chrome
- Stock No. 3096-1** Cad
- Stock No. 3097-1** Parkerized

Motor Mounting Hardware



Upper and Lower Motor Mount Kit

Complete stock motor mount kits feature special length heat treated bolts, castle nuts, cotter pins, and heavy duty washers. As applicable.

- Stock No.**
8164-19 O.H.V. Big Twins 1936-1969 Chrome Plated (SHOWN)
8165-19 O.H.V. Big Twins 1936-1969 Cad Plated (1038 CP)
9627-19 O.H.V. Big Twins 1936-1969 Parkerized (1038 CP)
2313-19 O.H.V. Big Twins 1936-1947, Parkerized (Machined Plain Head Bolts)
2648-9 Upper Motor Mount Kit, Big Twins 1936-1947, Cad Plated
2649-9 Upper Motor Mount Kit, Big Twins 1936-1947, Parkerized
2578-4 Upper Motor Mount Kit, Big Twins 1948-1951, Parkerized
2595-13 Upper Motor Mount Kit, Big Twins 1952-1972, Sportster 1957-early 1972, Cad Plated
2650-13 Upper Motor Mount Kit, Big Twins 1952-1972, Sportster 1957-early 1972, Parkerized
9625-16 Lower Motor Mount Kit, All H.D. 45's, 1930-1936 VL, Chrome Plated
8825-16 Lower Motor Mount Kit, All H.D. 45's, 1930-1936 VL, Cad Plated (1035 CP)
9626-16 Lower Motor Mount Kit, All H.D. 45's, 1930-1936 VL, Parkerized (1035 CP)
3034-16 Lower Motor Mount Kit, All H.D. 45's, 1930-1936 VL, Parkerized (Machined Plain Head Bolts)
9779-5 Upper Motor Mount Kit, H.D. 45's 1932-up, 1930-1936 VL, Chrome Plated
9780-5 Upper Motor Mount Kit, H.D. 45's 1932-up, 1930-1936 VL, Cad Plated (1035 CP)
9781-5 Upper Motor Mount Kit, H.D. 45's 1932-up, 1930-1936 VL, Parkerized (1035 CP)
3035-5 Upper Motor Mount Kit, H.D. 45's 1932-up, 1930-1936 VL, Parkerized (Machined Plain Head Bolts)
9521-22 Big Twin Side Valve, 1937-1947, Chrome Plated
9522-22 Big Twin Side Valve, 1937-1947, Cad Plated (1035, 1038 CP)
9723-22 Big Twin Side Valve, 1937-1947, Parkerized (1035, 1038 CP)
3036-22 Big Twin Side Valve, 1937-1947, Parkerized (Machined Plain Head Bolts)

Cylinder Head Motor Brace Mounting Kit

Accurately reproduced studs, nuts, and washers used to mount motor brace to cylinder head.

- Stock No. 2368-8** 1948-65 Panhead, Parkerized
Stock No. 2369-8 1948-65 Panhead, Cadmium
Stock No. 2370-8 1966-84 Shovelhead

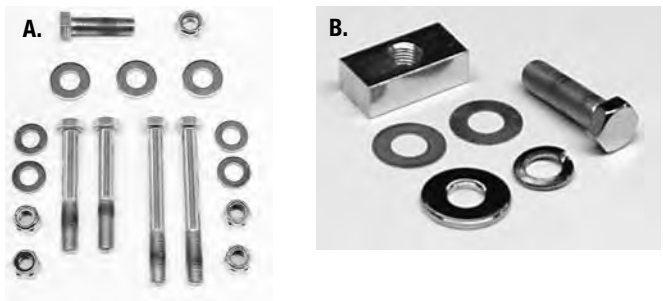

(See pages 16, 17, 18 for Allen Style)

A. Upper and Lower Motor Mount Kit

Complete stock motor mount kit features heat treated and plated bolts, locknuts, and heavy duty washers.

- Stock No. 8806-17** Shovelhead 1970-1984, Chrome Plated (SHOWN)
Stock No. 8807-17 Shovelhead 1970-1984, Zinc Plated
Stock No. 9854-28 Softail 1984-1999, Chrome Plated
Stock No. 9855-28 Softail 1984-1999, Zinc Plated

B. Top Motor Mount Kit

Mounting block OEM 16284-84, bolt and washers used on 1984-1999 Softail.

- Stock No. 2852-6** Chrome Plated
Stock No. 2853-6 Zinc Plated

C. Lower Motor Mount Kit

Complete kit for 2000-up Softail.

- Stock No. 2117-15** Chrome Plated
Stock No. 2118-15 Cad Plated

Lower Motor Mount

Complete stock motor mount kit features heat treated and plated bolts, locknuts, and heavy duty washers.

- Stock No. 9859-20** Chrome Plated, 1988-2006 FLT, FLHT, FXR, FXRS with rubber mounted motors.
Stock No. 9860-20 Zinc Plated, 1988-2006 FLT, FLHT, FXR, FXRS with rubber mounted motors.
Stock No. 2485-22 Chrome Plated, 2007-up FLT



Front Upper and Lower Motor Mount Kit

Complete stock motor mount kits features plated bolts, locknuts, washers, spacers and special biter washers. Fits 1957-1985 Sportster.

- Stock No. 9798-20** Chrome Plated
Stock No. 9799-20 Cad Plated

Transmission Hardware



Shifter Fork Cam Shaft Lock Screw and Oil Seal Kit

Reproduction of 34051-38 screw and 34036-36 seal used on 1938-1973 45's and Servi-car.

Stock No. 3116-2



Shifter Fork Cam Shaft Lock Screw and Oil Seal Kit

Reproduction of 34050-36 screw and 34036-36 seal used on 1936-early 1979 Big Twins.

Stock No. 3117-2



Shifter Assembly Cover Screw Kit

Reproduction of flat head socket screws used on 1965-early 1979 FL, FX. Replaces OEM screws 1772W, 1780, 1764W, 1775, 1767W.

Stock No. 3233-10



Cam Follower and Retainer Kit

Reproduction of 34065-52 retainer, 34062-52 cam follower, 34067-52 lock and 34068-52A spring used on 1952-early 1984 K, KH, XL.

Stock No. 3203-4



Relief Pipe Nut

Cadmium plated 544-26 nut used on 1926-1934 Singles and 1929-1931 45" Twins.

Stock No. 3272-1

Motor Mounting Hardware



Cylinder Bracket—Aluminum Heads

Reproduction of OEM 2806-40 cylinder bracket used on 1936-1952 WL 45 and 1936-1973 Servi-car. Made correctly from spring steel.

Stock No. 2945-1 Parkerized

Stock No. 2946-1 Cadmium Plated

Stock No. 2947-1 Chrome Plated



Top Motor Mount to Cylinder Head Bracket Mounting Kit

Chrome plated companion countersunk washers and flat head allen screws add a custom look to 1993-up Big Twins and 1986-2007 Sportster, 1993-2007 Touring and 1993-2017 Dyna, Softail.

Stock No. 9967-4



Top Motor Mount Spacers Harley 45

Nice reproduction of original Harley 45 part. This part spaces out the two longest headbolts on 1937-1974 45's.

Stock No. 8229-2 Chrome Plated

Stock No. 8230-2 Cad Plated

Stock No. 9721-2 Parkerized



Rear Engine Mount Nut Kit

Reproduction of 16202-62 knurled nuts used on 1962-1978 XL, XLH, XLCH. 2/Kit

Stock No. 3033-2



Rear Motor Mount and Sprocket Cover Mounting Kit

Zinc plated reproduction of 24825-82 studs, 34886-82 stud, nuts and washers used on 1983-1985 Sportster.

Stock No. 3058-10

Sprocket Shaft Seals



Sprocket Shaft Bearing Retainer

Bearing retainer with lip seal will "dry up" the sprocket shaft on 1955-1968 Big Twins.

Stock No. 7410-1 Standard
Stock No. 7410-1-OS Oversized threads +.002
Stock No. 7410-1-US Undersized threads -.002



Sprocket Shaft Bearing Retainer Installation Tool

Quality tool designed to remove and install stock and aftermarket bearing retainer, Colony P/N 7410-1. Black oxide finish. Used on 1955-1968 Big Twins retainers.

Stock No. 2318-1



Sprocket Shaft Seal and Snap Ring

Stock No. 7411-2 Big Twins 1936-1954
Stock No. 8211-2 1939-1973 45's



Left Bearing End Oil Slinger

Duplicate of OEM style slinger and snap ring.

Stock No. 2742-2 Big Twins 1936-1954
Stock No. 2740-2 1939-1973 45's



Mainshaft Oil Seal Cork Washer and Main Drive Gear Spacer Key

Reproduction of 35231-36 cork seal and 35175-38 key used on 1936-Early 1979 all 4 speed Big Twins.

Stock No. 3306-2

Fork Slider Drain Screws



A. Quality reproduction of stock screws and copper washers used on K, XL, FX 1952-1972.

OEM 46201-52 plug and 6218-W washer.
Stock No. 9907-4 Chrome Plated
Stock No. 9908-4 Cad Plated

B. Stock plugs used on FL 1949-Early 1977.

OEM 45830-48.
Stock No. 9909-2 Chrome Plated
Stock No. 2733-2 Cadmium Plated

C. Chrome plated button head allen screws and copper washers used on XL, FX, FXR 1973-up.

Replaces OEM 45790-80 and 45996-73.
Stock No. 9910-4

D. Chrome plated button head allen screws and copper washers used on FXWG, FLT and Softail models 1980-up and FL models Late 1977-1984.

Replaces OEM 45858-77.
Stock No. 9758-2



Fork Slider Bottom Cap Stud and Nut Kit

Chrome plated locknuts and replacement studs fit the following:

Stock No. 8813-4 FLH Wideglide 1949-77
Stock No. 8826-6 Showa & Kayaba 1973-up



Fork Slider Screw Kit

Cadmium plated OEM 1367 screws used on 1949-Early 1977 FL, FLH.

Stock No. 3017-4



SHOWA Fork Damper Tube Mounting Kit

Replacement for OEM 45405-75A screws and copper washers used on 1979-up XL, 1975-up FL, FX with SHOWA forks.

Stock No. 2985-2



Fork Panel Mounting Kit

Cadmium plated reproduction of 2823 and 2758 screws used to mount fork panel on 1949-1959 Big Twins, 1952-1970 K, XL, 1958-1959 Servi-Car w/ Glide front end.

Stock No. 3175-6



Damper Fork Tube Screw and Washer Kit

Zinc plated duplicate of 45995-73 screw and 45992-73 washer used on 1973-1974 XLH, XLCH, and 1973-1977 FX.

Stock No. 3318-4

Fork Tube Plugs/Bolts



Chrome Plated fork tube caps available in Colony custom dome top for a classic look or stock flat top. 1 plug/kit.

Fork Tube Cap

Fits Sportster and K Models 1952-1972; 1971-1972 Superglides. Replaces OEM 45756-59.

Stock No. 7621-1 Custom

Stock No. 2373-1 Stock



Fork Tube Plug

Chrome plated plug screws into fork tube.

Stock No.

8226-1 1948-1977 Wideglide
Replaces OEM 45776-49

8716-1 1978-up Wideglide
Replaces OEM 45838-77



Fork Tube Cap

Chrome plated fork cap replaces OEM 45993-74. Complete with o-ring. Used on 1975-1976 XLH, XLCH.

Stock No. 2935-1



Fork Tube Plug, Pike Style

Chrome plated classic chopper style fork tube plugs. 1 plug/kit.

Stock No. 2499-1 Sportster and K Models 1952-1972, 1971-1972 Superglides. Replaces OEM 45756-59

Stock No. 2498-1 1973 Mid 1985 Sportster and Superglide. Replaces OEM 45993-73

Stock No. 2500-1 Mid-1985-up Sportster and Superglide, Replaces OEM 45993-86

Stock No. 2311-2 FL, FXWG, Softail 1978-up. Replaces OEM 45419-80. (Pictured)

Stock No. 2312-2 FX, XL 1988-up. Replaces OEM 45996-87

Sportster Fork Tube Spring Retainer and Pin Wrench Kit

These replacement fork tube spring retainers will fit all 1952-1972 Sportsters. Kit includes 1 handy pin wrench for proper installation and removal of original or Colony retainers.

Stock No. 7700-3

Stock No. 7701-2 Retainers Only



Fork Tube Cap

Fits Sportster and Superglide.

Stock No. 7622-1 1973-Mid 1985—Custom
Replaces OEM 45993-73

Stock No. 2372-1 1973-Mid 1985—Stock
Replaces OEM 45993-73

Stock No. 8863-1 Mid 1985-1987—Custom
Replaces OEM 45993-86

Stock No. 2371-1 Mid 1985-1987—Stock
Replaces OEM 45993-86



Fork Tube Bolt

This flat top bolt is a duplicate of orig. equipment.

Stock No.

9911-1 Chrome, Wideglide 1960-1977

8872-1 Zinc, Wideglide 1960-1977
(will fit 1948-1977)

Replaces OEM 45754-60

9912-2 Chrome, FL, FXWG, Softail
1978-up.
Includes OEM 5710 washer.
Replaces OEM 45419-80

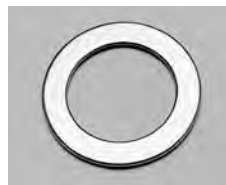

Fork Tube Bolt Washers

Chrome plated washers are used with fork tube bolt on FL, FXWG and Softail 1978-up. Replaces OEM 5710.

Stock No. 9964-2 Set of 2



Fork Tube Bolt

Chrome plated replacement fork tube bolts for Wideglide front ends.

Stock No.

7620-1 1948-1977 Vented
Replaces OEM 45754-49

8233-1 1978-up Non-vented
Replaces OEM 45777-77
and OEM 45419-80



Fork Tube Plug

Chrome plated duplicate of original OEM 45841-84 plug used on all 1984-2001 FLT models.

Stock No. 2737-1



Fork Tube Plug

Chrome plated duplicate of original OEM 45839-84 bolt used on all 1984-2001 FLT models.

Stock No. 2736-1

Fork Tube Plug Wrench



Flat Top Style



Domed Top Style

Stock No. 2317-1

Heat treated socket wrench is designed for easy removal and installation of stock 1-3/8 hex flat top fork tube plugs. Installed o-ring eliminates damage to top of plug. Black oxide finish.

Stock No. 2319-1

Heat treated socket wrench is designed for easy removal and installation of 1-3/8 Hex Colony custom dome style fork tube plugs. Will also fit stock and Colony Knucklehead rocker arm shaft nuts (Colony P/N 7110-8). Installed o-ring eliminates damage to top of plug. Black oxide finish.

Stem Nuts



Chrome Plated Stem Nut

This stem nut is designed to fit Harley Big Twin & 45 Springers. The shoulder on its base fits into the top triple clamp for positive alignment.

Stock No. 7802-1 Big Twin 1936-1977

Stock No. 8008-1 45 Springers

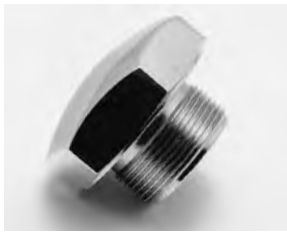

Chrome Plated Stem Bolt

Chrome plated stem bolt fits all Sportster 1957-1978 with stock triple clamp.

Stock No. 7618-1



Chrome Plated Stem Nuts

Chrome plated stem nuts fit Sportster, 45's and Big Twin Harley.

Stock No. 7004-1 7/8-24 Thread size for Sportster & 45's

Stock No. 7009-1 1-24 Thread size for Big Twin Harley



Chrome Plated Stem Nut

Stem nut fits FX 1971-up and Sportster 1979-up with stock triple clamp. Replaces OEM 45718-71.

Stock No. 7619-1 Stem nut and washer—Chrome plated

Stock No. 9963-1 Washer only—Chrome plated

Stock No. 2399-2 Stem Nut and Washer, Stock Zinc



Chrome Plated Stem Bolt, Custom

Chrome plated custom dome shaped stem bolt with chrome plated washer replaces OEM P/N 4453 bolt and cover on 1986-up FLST, FXR, FXD, XL.

Stock No. 9978-2 5/8-18 Thread Size.

Stem Nuts-Stock Replacement

Stem Bolt and Cover Kit

Complete kit includes sleeve, stem bolt, dust shield, spacer, rubber plug, and chrome cover. Fits all Sportster 1957-1978 without steering damper.

Stock No. 8809-6 Complete Kit
Stock No. 8810-2 Cover & Rubber Plug ONLY



Stem Nut

Reproduction stem nut is exact duplication of original Harley part.

Stock No. 8484-1 Big Twin Springer Chrome

Stock No. 8485-1 Big Twin Springer Cad

Stock No. 9720-1 Big Twin Springer Parkerized

Stock No. 8486-1 Harley 45 Springer Chrome

Stock No. 8487-1 Harley 45 Springer Cad

Stock No. 9713-1 Harley 45 Springer Parkerized



Stem Bolt and Washer Kit

Zinc plated bolt, OEM P/N 4453, complete with washer fits 1986-up FLST, FXR, FXD, XL.

Stock No. 9976-2



Chrome Plated Stem Cap

Chrome plated fork stem cap with 1/4-20 stud fits 1980-up FXST, FXWG.

Stock No. 2058-1

Chrome Plated Stem Cap

Chrome plated fork stem cap with 1/4-20 stud screws into Colony P/N 9976-2 bolt. Fits 1986-up FLST, FXR, FXD, XL.

Stock No. 9977-1

Stem Nuts



Chrome Plated Stem Nut

Precision machined stock stem nut, steel lockwasher and stainless steel cover fits Harley Wideglide 1949-up without steering damper.

Stock No. 2937-5

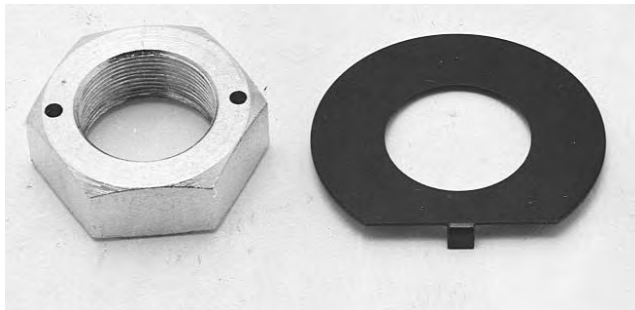

Stem Nut/Lockwasher Kit

Precision machined stock stem nut and stamped steel lockwasher 45717-63, fits 1949-up FLH & 1980-up FXWG, FXST, without steering damper.

Stock No. 8808-2 1949-1959, Zinc, replaces 45718-48 nut.

Stock No. 2184-2 1949-1959, Chrome, replaces 45718-48 nut.

Stock No. 3050-2 1960-up, Zinc, replaces 45718-60 nut.



Steering Damper Upper Kit

Accurate reproduction of lever and all upper steering damper fasteners. Correct part finish as applicable.

Stock No. 2584-7 1936-1948 Big Twins (as shown)

Stock No. 2585-7 1937-1952 45's and 1953-1957 Servi-cars (all parkerized)

Stock No. 3136-7 1936-1948 Big Twins
Chrome plated

Stock No. 3137-7 1937-1952 45's and 1953-1957 Servi-cars
Chrome plated

Front Fork Steering Damper Spring Kit

Reproduction of 46715-48 spring steel spider washer and 46751-48 spring used on 1949-1977 FL, FLH, 1958-1973 Servi-car.



Upper Fork Bearing Adjustment Nut

Zinc plated reproduction.

Stock No. 2799-1 OEM 48332-48B nut used on 1948-1984 FL, 1984-2009 FXST and 1991-2005 FXDWG.

Stock No. 3053-1 OEM 48307-06 nut used on 2006-up Dyna.

Stock No. 3186-1 OEM 48324-00 (48324-00A) nut used on 2005-2008 V-rod, 2001-2007 FXSTD, 2008-2010 FXCW and 2011-up FXS.

Stock No. 3228-1 OEM 48330-48A nut used on 1949-1984 4-speed Big Twins 1993-2005 FXDWG, 1984-2006 Softail, except 2000-2006 FXSTD.



Stem Crown Nut

Reproduction stem nut and dust shield.

Stock No. 3237-1 1940-1957 45" Solo and Servi-Cars.
7/8-24 thread. Parkerized. OEM 2754-40.

Stock No. 3331-1 1940-1947 45" Solo and Servi-Cars.
7/8-24 thread. Chrome plated. OEM 2754-40.

Stock No. 3236-1 1939-1948 Big Twins Springer.
1-24 thread. Parkerized. OEM 2753-36.

Stock No. 3332-1 1939-1948 Big Twins Springer.
1-24 thread. Chrome plated. OEM 2753-36.



Upper Bearing Dust Shield

Zinc plated reproduction of 48361-80 used on 1949-up Big Twin 4-speed, Softail up to 2017, Dyna/FXR up to 2005 Touring 1980-2013, Sportster 1982-2003.

Stock No. 3265-1

Stem

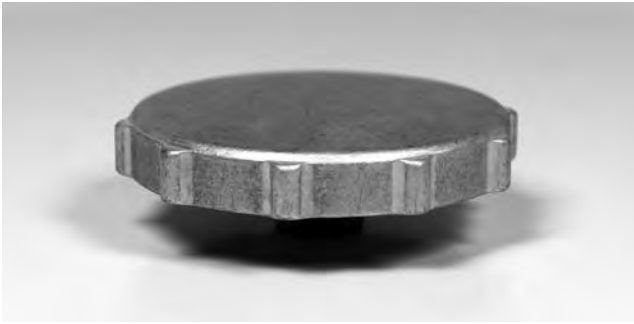

Steering Damper Knob

Reproduction of 46746-52 aluminum knob used on 1952-1966 K, KH, Sportster (except 1959 CH), 1960-up Servi-Car and 1960-1984 FL, FLH.

Stock No. 3218-1



Steering Damper Adjusting Screw and Locknut Kit

Reproduction of 46743-60 adjusting screw and 7763W locknut used on 1960-1984 Big Twin FL models.

Stock No. 3251-2



Steering Damper Anchor Plate Kit

Reproduction of cadmium plated 46730-52 anchor plate and parkerized 4379 bolt (CP 1035), nut and washers used on 1952-1963 K, KH, and Sportster.

Stock No. 3219-5



Steering Damper Rod and Spacer Kit

Parkerized rod 46769-55, cad plated spacer 46776-55 and nut 7763W used on 1955-56 KH, 1957-66 XL (except 1959 CH).

Stock No. 3271-3



Steering Damper Rod Lock Spring

Parkerized reproduction of 46780-55 lock spring used on 1955-1961 KH, XL, XLH, XLCH.

Stock No. 3223-1



Fork Bracket Bolt and Clip Kit

Reproduction of parkerized 45711-51A bolt, 7947W castle nut, 559 cotter pin and cad plated 45710-58 clip used on 1950-early 1977 FL, FLH.

Stock No. 3303-5

Harley Springer Rebuilding Parts

Complete Rocker Rebuilding Kit

This kit contains all components needed to completely rebuild the rockers on 1930-1952 Harley 45 Solo Springers. These kits are identical to, and interchangeable with new old stock Harley Parts. Materials, heat treating, and plating are equal to or better than original equipment. There has been no compromise in quality or authenticity.

Stock No. 9216-22 Complete Kit [Pictured]

Stock No. 2941-22 All Parkerized

Rocker Stud Lockwashers

Contains the two tabs necessary to prevent loosening of critical fasteners on Harley 45 rocker assemblies.

Stock No. 9019-2 Harley 45 Solo 1940-52

Rocker Stud Bushing Kit

Contains four hardened and ground rocker stud bushings, exact duplicate of N.O.S. Harley 45 part.

Stock No. 8011-4 Harley 45 Solo 1930-52

Rocker Stud Bushing Removal and Installation Tool

This piloted mandrel and support sleeve simplifies bushing removal and installation. Prevents damage to rocker and bushing.

Stock No. 7611-2 Big Twin and 45 Springers

Rocker Stud Removal and Installation Tool

Tool has pilot to simplify removal and installation, and prevent damage to slot.

Stock No. 2823-1 Harley 45 Solo 1930-52



Harley Springer Rebuilding Parts

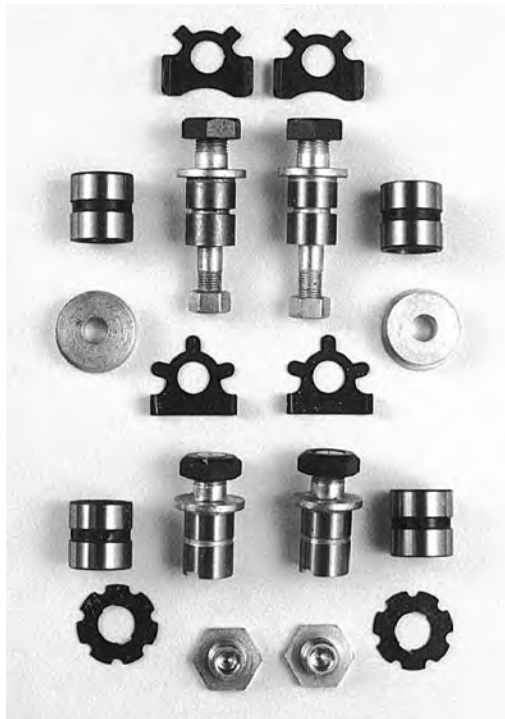

Complete Rocker Rebuilding Kit

This kit contains all components needed to completely rebuild the rockers on the 1931-1948 Big Twin Springers. All items in this kit are identical to, and interchangeable with new old stock Harley parts. Materials, heat treating, and plating are equal to or better than original equipment. There has been no compromise in quality and authenticity.

Stock No. 7606-26 Complete Kit [Pictured]

Stock No. 2939-26 All Parkerized

Rear Rocker Stud Assembly

Contains one hardened and ground bushing, one hardened and ground rocker stud with spool spacer and 3/8-24 nut for fender mount, one 1/2-20 hardened mounting nut and one lock tab.

Stock No. 7608-6 Big Twin Springer

Rocker Stud Bushing Kit

Contains four hardened and ground rocker stud bushings, exact duplicate of N.O.S. Harley part.

Stock No. 7610-4 Big Twin Springer, Standard Size

Stock No. 3072-4 Big Twin Springer, Oversized +.003

Rocker Stud Bushing Removal and Installation Tool

This piloted mandrel and support sleeve simplifies bushing removal and installation. Prevents damage to rocker or bushing.

Stock No. 7611-2 Big Twin and 45 Springer

Front Rocker Stud Assembly

Contains one hardened and ground bushing, one hardened and ground rocker stud with end plug, one 1/2-20 hardened nut and two lock tabs.

Stock No. 7607-7 Big Twin Springer

Rocker Stud Lockwashers

Contains the six lock tabs necessary to prevent loosening of critical fasteners on Harley rocker assemblies.

Stock No. 7609-6 Big Twin Springer

Rocker Stud Spacers

Contains two spacers, OEM 2644-31, used on 1931-1940 Big Twins.

Stock No. 2913-2 Parkerized

Stock No. 2914-2 Cadmium Plated

FLSTS and FXSTS Complete Rocker Rebuild Kit

Includes all components needed to mount rockers. Decorative chrome plated.

Stock No. 2213-16 1997-up FLSTS

Stock No. 2214-16 1988-up FXSTS



Harley Springer Rebuilding Parts

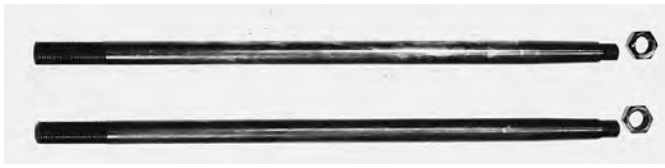

Harley Springer Spring Rod Kit

Exact reproduction of the original spring rods. These rods are heat treated for wear resistance and parkerized as original.

- Stock No. 2089-8** VL 1930
- Stock No. 9862-8** VL 1931-1936
- Stock No. 7707-4** Big Twins 45's, Servi-Car 1936-1957
- Stock No. 2781-6** 45's 1931-1937
- Stock No. 2782-4** 45's 1938-1939

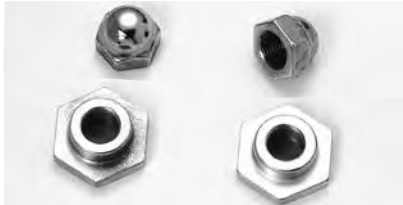

Springer Spring Retainer and Top Nut Set

These spring retainers and top nuts are exact duplicates of OEM parts used from 1930-1954 in choice of plating for the following models.

- Stock No. 2986-4** Chrome Acorns—Cad Retainers, Fits 1936-1938 Big Twins and 1949-1957 45's.
- Stock No. 2987-4** Parkerized Acorns—Parkerized Retainers, Fits 1936-1938 Big Twins and 1949-1957 45's.
- Stock No. 7613-2** Chrome Acorns—Cad Retainers, Fits 1936-48 45's, 1953-54 Servi-Car & 1939-48 Big Twin Springers
- Stock No. 7111-2** Chrome Retainers Only, Fits 1936-52 45's, 1953-54 Servi-Car & 1936-48 Big Twin Springers
- Stock No. 9416-4** Cad Retainers—Chrome Hex Nuts, Fits 1930-35 VL, RL
- Stock No. 9417-4** Cad Retainers—Parkerized Hex Nuts, Fits 1930-35 VL, RL
- Stock No. 2815-2** Parkerized Acorn—Parkerized Retainers, Fits 1936-48 45's, 1953-54 Servi-Car & 1939-48 Big Twin Springers
- Stock No. 2921-2** Chrome Acorn—Chrome Retainers, Fits 1936-48 45's, 1953-54 Servi-Car & 1939-48 Big Twin Springers



Front Brake Shackle Rebuilding Kit

High quality reproduction of original Harley parts. This kit contains all wear parts needed to restore the front brake shackle assembly to factory tolerances.

- Stock No. 2651-10** 1939 Big Twins and 45's
- Stock No. 8010-10** 1940-1948 Big Twins and 45's (shown)
- Stock No. 2299-10** 1936-1938 Big Twins and 45's
- Stock No. 2298-10** 1930-1936 VL

Front Brake Shackle Bushing Installation Tool

This tool will simplify installation or removal of brake shackle bushing on all 1930-1948 Big Twins and 45's.

Stock No. 2959-2



Harley Springer Spring Rod Bushings

These precision machined bushings are heat treated for wear resistance as original.

- Stock No. 7706-2** 1931-45 Big Twin and 45 Springers, Cadmium Plated
- Stock No. 3000-2** 1931-45 Big Twin and 45 Springers, Parkerized
- Stock No. 2143-2** 1946-52 45's, 1946-49 Big Twins, 1946-57 Servi-Car



Fender Brace Clip Locks

This new Colony kit has been reproduced due to popular demand. These clips are exact duplicates of the original Harley parts and will give the restoration of Harley Springers that final touch of authenticity. Fits Big Twin Springers 1934-1948, 45 Springers 1940-1954.

Stock No. 8009-2



Springer Ball Bushing Retainer

Precision stamping to secure spring rod bushing on 1946-52 45's, 1946-57 Servicar and 1946-49 Big Twins.

OEM 54230-45 plate includes OEM fasteners.

Stock No. 2151-5

Front Brake Shackle Stud Grease Nipple

Reproduction of OEM 4124-31A grease nipple used on 1931-1936 45", 1931-1936 74" and 80", 1937 45" and 1930-1934 C Singles. Parkerized.

Stock No. 2773-1



Harley Springer Rebuilding Parts



Springer Front Brake Grease Seal

This kit contains the spring, steel washer, and cork gasket used on front brake backing plate on all Big Twin Springers 1937-1948, also Servi-Car 1941-1957. Another detail item from Colony to make your Harley Springer like new.

Stock No. 8617-4



Fork Rocker Studs, Towbar

Duplicate of OEM 45673-39 studs used with towbars on 1940-1957 Servi-car and 1940-1948 Big Twins.

Stock No. 2635-2



Top Plugs for Classic Springer Forks

Custom plugs which fit reproduction Springer forks with legs that are threaded at the upper end. M20 x 1.5 thread. Set of 2..

Stock No. 3142-2 Aluminum

Stock No. 3143-2 Brass

Oil Tank - Oil Line Accessories

Rocker Box Drain Tube Fittings

These specially made oil drain tube fittings are an exact reproduction of the difficult to find Harley part used on all 1938-1947 Knucklehead engines. Parkerized finish.

Stock No. 7705-4



Rocker Feed Line Nipple

Accurate reproduction of special threaded fitting used on rocker feed oil line 1936-1941 O.H.V., vent line 1937-1964 Harley 45. OEM 25235-36.

Stock No. 9738-1 Chrome Plated

Stock No. 8630-1 Cad Plated

Stock No. 9701-1 Parkerized



Oil Nipple Cap

Cad plated duplicate of OEM 3583-15. Can be used on all H.D. 1915-1964 when oil lines are disconnected to prevent leakage or contamination during storage.

Stock No. 9808-6



Banjo Style Feed Line Fitting Kit

Banjo bolts, OEM 63578-36, threaded bushings, OEM 17325-36, cam cover fitting, OEM 25235-36 and washers, OEM 6440 used on 1936-1941 Knucklehead.

Stock No. 9847-9 Chrome Plated

Stock No. 9848-9 Cadmium Plated



Oil Line/Vent Line Fittings

These oil line fittings are exact duplicates of the original type used on 1936-1964 Big Twin Harley Davidson. Use these with braided stainless steel or stock rigid steel oil lines.

Stock No. 7612-3 Cad Plated

Stock No. 7148-3 Chrome Plated

Stock No. 3047-3 Parkerized



Rocker Box and Cam Cover Oil Feed Line Fitting Kit

Duplicate of oil feed line fittings used on 1942-1947 Knucklehead. OEM 95-42, 95-42A.

Stock No. 7349-3

Chrome Plated (SHOWN)

Stock No. 8941-3 Cad Plated

Stock No. 3046-3 Parkerized



Knucklehead Intake and Exhaust Rocker Arm Cover Return Oil Line Nuts

Set of 4 nuts used on 1936-1947 Knucklehead rocker cover return lines.

Stock No. 3307-4



Oil Pump Cover Oil Pipe Nipple

OEM 26424-50 nipple and OEM 6377 brass washer used on 1950-1964 Big Twins.

Stock No. 2624-2 Cadmium Plated

Stock No. 3238-2 Chrome



Oil Pressure Switch Nipple Kit

Cadmium plated nipple, OEM 26569-39 is complete with brass screen, OEM 6440, used on 1939-1957 Big Twins.

Stock No. 2623-1



Oil Pressure Switch Nipple

Cadmium plated nipple, OEM 26569-58, is complete with screen and OEM 6440 washer used on 1958-1969 Big Twins.

Stock No. 3246-1



Oil Tank Oil Line Nipple Kit

Exact reproduction of weld-on oil line nipples.

Stock No. 2694-3



Oil Tank Bracket to Frame Mounting Kit

This kit contains exact duplicate of fasteners, spacers and lockwashers used on 1958-1964 Big Twins.

Stock No. 9205-12 Chrome Plated

Stock No. 9206-12 Cad Plated (Plain Head)



Oil Tank Mounting Kit

Reproduction fasteners and spacers to mount oil tank on all 1936-1957 Big Twin Harleys.

Stock No. 9602-8 Chrome Plated

Stock No. 8213-8 Cad Plated (1038 CP)

Stock No. 9667-8 Parkerized (1038 CP)

Stock No. 3037-8 Parkerized (Machined Plain Head Bolts)



Oil Pump Fitting

Used to replace stripped or broken fitting in cast iron side valve feed or scavenger pump. 7/16-20 thread with internal hex for easy installation.

Stock No. 2374-1 Cadmium Plated



Oil Tank - Oil Line Accessories



Oil Tank Mounting Plates

Parkerized reproduction of 62552-52 plates used on 1958-1965 XLCH, XLR and 1952-1967 KR, KRTT.

Stock No. 3149-2

Oil Tank Mounting Bolt Kit, Rear

Parkerized reproduction of 62556-52 bolt and washers used on 1958-1965 XLCH, XLR and 1952-1967 KR, KRTT.

Stock No. 3150-4



Oil Tank Mounting Bracket

Black powder coated reproduction replaces OEM 62555-70 and 62555-73 bracket used on 1970-1978 XLCH.

Stock No. 3305-1



Oil Tank Mounting Bracket

Parkerized reproduction of OEM 62555-53 bracket used on 1953-1965 K, KH, XLCH horseshoe oil tanks.

Stock No. 3221-1



Oil Tank Mounting Bracket

Parkerized reproduction of OEM 62555-66 bracket used on 1966-1969 XLCH.

Stock No. 3244-1



Oil Tank Mounting Bolt Kit, Front

Reproduction of 4012 bolts, washers and nuts used on 1958-1965 XLCH, XLR and 1952-1967 KR, KRTT.

Stock No. 3151-14 Parkerized (1038 CP)

Stock No. 3158-14 Cadmium (1038 CP)



Upper Oil Tank Mounting Kit

Parkerized CP 1038 3791 bolts, 7675 nuts, 6227, 7035 washers used on 1966-1969 XLCH.

Stock No. 3262-8



Lower Oil Tank Bracket to Motor Case Mounting Kit

Parkerized studs 62761-66, CP 1035 4293 bolts, 7045 and 6395B washers used on 1966-1969 XLCH.

Stock No. 3264-8



Lower Oil Tank to Bracket Mounting Kit

Parkerized bolts 3831, spring 60640-29, 7688 nuts, 6245B, 6236B washers and 515 cotter pins used on 1966-1969 XLCH.

Stock No. 3263-12

Oil Tank - Oil Line Accessories



Rocker Arm Cover Oil Line Fitting Kit

Parkerized reproduction of 63526-57 fittings used on 1966-1984 FL, FX and 1957-1984 XL, XLH, XLCH.

Stock No. 3138-4



Rocker Arm Cover Oil Line Fitting Nuts and Seals

Reproduction of 63527-57 nuts and 63529-57 seals used on 1966-1984 FL, FX and 1957-1984 XL, XLH, XLCH.

Stock No. 3179-8



Oil Line Fitting

Replaces OEM 63533-41. Thread is 1/8" NPT, for use with 3/8" hose.

Stock No. 2070-1 Chrome Plated

Stock No. 2735-1 Cad Plated



Oil Tank Vent Pipe Nipple Bolt and Washer Kit

Cadmium plated 3572-36B bolt and 3572-36C brass washers used on 1937-1973 45's and Servi-Car.

Stock No. 3069-3



Oil Line Banjo Bolt and Washer Kit

Oil line banjo bolt 3570-36A, brass washers 3570-36B used on 1936-1937 Knucklehead and 1937 Flathead, Sidevalve.

Stock No. 3003-3



Chrome Plated Oil Tank Cap and Dipstick for Harley Davidson

Here is a functional decorative item for Harley oil tanks. The hex size and shallow crown are similar to a Knucklehead knuckle nut. This combination filler cap and dipstick will fit stock Harley tanks 1936-1954 and all accessory tanks with 1-1/4-20 thread. Packaged complete with "O" ring.

Stock No. 7354-2 Fits Oil Tanks with 1-1/4-20 Thread

Stock No. 7355-2 Fits All Custom Oil Tanks with 1-5/16-12 Thread



Oil Tank Filler Cap and Gauge

Duplicate of OEM filler cap complete with gasket (OEM 62628-36).

Stock No. 2903-2 1936-1940 Big Twins, Cad Plated, OEM 62625-36.

Stock No. 2907-2 1936-1940 Big Twins, Parkerized, OEM 62625-36.

Stock No. 2904-2 1941-1964 Big Twins, Cad Plated, OEM 62625-36A.

Stock No. 2908-2 1941-1964 Big Twins, Parkerized, OEM 62625-36A.

Stock No. 3288-2 1958-1965 XLCH, Cad Plated, OEM 62625-62.

Gas Line Accessories



Gas Strainer Assembly
Nickel plated gas strainer is exact duplicate of OEM 3623-32 used on 1932-1938 Twins. Includes cap, gaskets and screen.
Stock No. 9659-1



Gas Strainer Assembly
Cad plated in line style gas strainer is exact duplicate of OEM 3623-39 used on 1939-1941 Twins. Includes screen and gasket.
Stock No. 9661-1



Gas Strainer Assembly
Cad plated gas strainer is exact duplicate of OEM 3623-41M used on 1942-1949 Twins. Includes cap, gaskets and screen.
Stock No. 9660-1



Gas Strainer Assembly
Cad plated gas strainer is exact duplicate of OEM 62250-50 used on 1950-1965 Twins. Includes cap, gaskets and screen.
Stock No. 9662-1



Gas Strainer Assembly
Universal Cad plated gas strainer provides retro-look and simplifies hook up to gas tanks using 1/4" neoprene fuel line. Includes cap, gaskets and screen.
Stock No. 2212-1

Gas Strainer Cap
Brass diamond knurl style cap and gaskets are exact duplicate of OEM 3629-32 cap, 3633-32 gasket. Fits all Twins 1932-1938.
Stock No. 9730-3



Gas Strainer Rebuild Kit
OEM 3627-39 screen, OEM 3613-39 gasket and body to carburetor gasket to rebuild in line style gas strainer used on all Twins 1939-1941.
Stock No. 9731-3



Gas Strainer Cap
Straight knurl cap and gaskets are exact duplicate of OEM 3629-32 cap, 3633-32 gasket. Fits all Twins 1942-1965.
Stock No. 8925-3 Chrome
Stock No. 8926-3 Cad



Gas Strainer Screen
Quality duplicate of original brass screen assembly and gaskets. Fits Big Twins and 45's 1932-1965 OEM P/N 62265-32 screen, 62270-32 gasket.
Stock No. 8927-3



Gas Tank Accessories



Gas Tank Mounting Kit

This kit contains exact duplicates of fasteners used to mount gas tank on 1937-1975 Big Twins and 1971-1972 FX.

- Stock No. 9891-18** Chrome Plated
- Stock No. 9892-18** Cad Plated (1038 CP)
- Stock No. 9893-18** Parkerized (1038 CP)
- Stock No. 3038-18** Parkerized (Machined Plain Head Bolts)

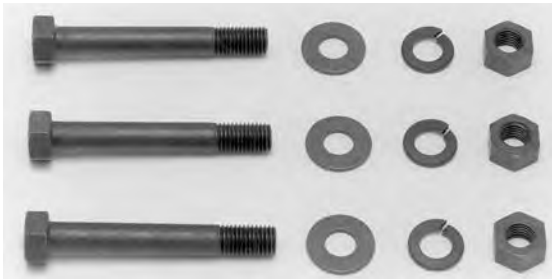

Gas Tank Mounting Kit

This kit contains exact duplicates of fasteners used to mount gas tank on 1937-1952 45 Solo and 1937-up Servicar.

- Stock No. 9894-12** Chrome Plated
- Stock No. 9895-12** Cad Plated (1038 CP)
- Stock No. 9896-12** Parkerized (1038 CP)
- Stock No. 3039-12** Parkerized (Machined Plain Head Bolts)



Gas Tank Mounting Kit

Reproductions of fasteners used to mount gas tank clip.

- Stock No. 2461-3** 1910-1917 all models, nickel plated
- Stock No. 2462-9** 1918-1924 JD, nickel plated (*shown*)
- Stock No. 2463-8** 1925-1936 JD, DL, RL, VL and Singles
Cadmium and Parkerized



Gas Tank Mounting Kit

Chrome plated custom acorn nuts, washers, studs, spacers and grommets used to mount gas tank on all 1996-up Sportster.

- Stock No. 2107-16** 1996-2003
- Stock No. 2265-6** 2004-up



Gas Tank Mounting Kit

Chrome plated countersunk washers and flat head allen bolts mount lower front gas tankl.

- Stock No. 2072-4** 1991-1999 Softail
- Stock No. 2106-4** 1998-up FLT



Gas Tank Mounting Kit Milled Hex Acorn or Pike

Chrome plated custom nuts, washers and studs mount gas tank on 1991-up Dyna.

- Stock No. 2076-10** Acorn
- Stock No. 2436-10** Pike



Gas Tank Mounting Kit Milled Hex Acorn or Pike

Chrome plated custom nuts, washers and stud mount gas tank.

- Stock No. 2077-5** 2000-up Softail, Acorn
- Stock No. 2437-5** 2000-up Softail, Pike
- Stock No. 2128-5** 1984-1999 Softail, Acorn
- Stock No. 2438-5** 1984-1999 Softail, Pike



Rubber Grommets and Spacers Kit

6 rubber grommets, OEM 11447 and 2 spacers, OEM 5775 used to mount gas tank on all 1984-1999 Softail.

- Stock No. 2105-8**

Gas Tank Accessories

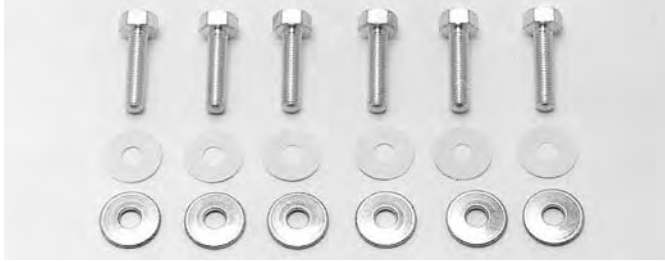

Top of Tank Screw & Washer Kit

Duplicate of original Harley hardware used to mount tank to frame on all Harley 1918-1936, 1936-1952 45's. OEM Part No. 3665 Bolt, 61820-18 Washer. Kit includes paper gaskets to avoid paint chipping as original.

Stock No. 8821-18 Nickel Plated
Stock No. 8822-18 Cad Plated
Stock No. 2814-18 Parkerized
Stock No. 8821-18-O.S. Nickel Plated (Oversized)
Stock No. 8822-18-O.S. Cad Plated (Oversized)
Stock No. 2817-18 Parkerized (Oversized)



Gas Tank Shut-off Rod Upper Kit

Accurate reproduction of all upper shut-off rod parts: 3637-40, 3636-40, 4764-26, 3635-40, 3634-40 and 018. Used on all 1940-1965 Big Twins and 45's.

Stock No. 2702-7 Chrome, Cadmium
Stock No. 2703-7 Parkerized



Gas Tank Shut-off Spacer and Washers Kit

Cadmium plated 62096-40 spacer and 62085-40 brass washers used on 1940-1958 45's.

Stock No. 3055-3



Gas Tank Shut Off Valve Extension Knob

Beautifully chrome plated duplicate of the original Harley accessory. The installation of this accessory allows easier operation of the shut off valve used on 1940-1965 Harley gas tanks.

Stock No. 7801-2



Gas Tank Fitting Kit

This chrome plated fitting kit is designed to utilize flexible hose on original style shut off valves and tanks. .

Stock No. 2821-3 1940-1949
Stock No. 7807-3 1950-1965



Fuel Line Fitting Nuts and Seals

Reproduction of 62361-50 nuts and 62360-50 seals used on 1950-1965 FL, 1950-1952 45's and 1950-1958 Servi-car. Set of 2 each.

Stock No. 3325-4

Speedometer Cable Clamps

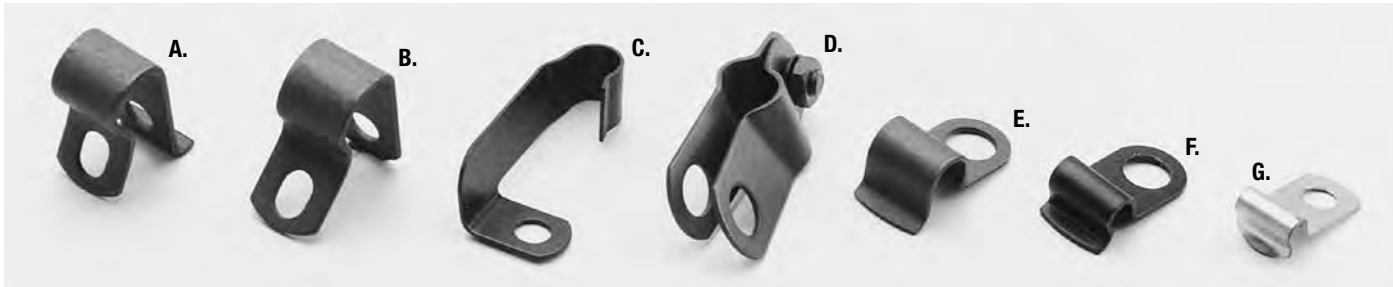

Speedometer Cable Clamps

Exact duplicate of original Harley clamps.

- A. Stock No. 9646-1** 74 & 80 Sidevalves 1936-1938, 61 & 74 O.H.V. 1936-1951, OEM 67075-36 Parkerized
- B. Stock No. 9647-1** 45 Solo 1937-1952, Servi-car 1937-1956, OEM 67074-37, Parkerized
- C. Stock No. 9648-1** 45 Solo 1941-1952, OEM 67076-41, Parkerized
- D. Stock No. 9649-5** 74 & 80 Side Valves 1939-1948, OEM. P/N 67086-39, Parkerized
- E. Stock No. 9650-1** O.H.V. Big Twins 1952-1956, OEM 67075-52 Parkerized
- F. Stock No. 9651-1** O.H.V. Big Twins 1957-1961, 1957-1961 XL, OEM 67074-57 Parkerized
- G. Stock No. 9652-1** O.H.V. Big Twins 1961-1980, 1961-1980 XL, OEM 67075-57A Zinc Plated

Wire Clips

Quality reproductions of original clips.

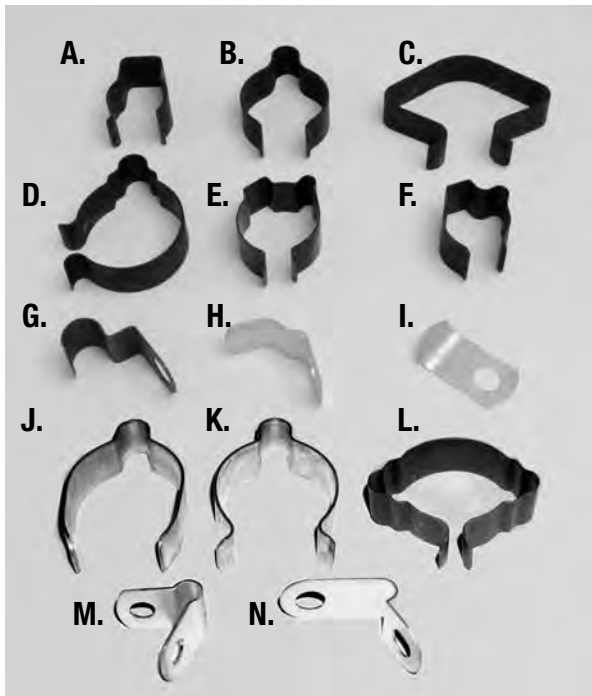

- A. Stock No. 2449-1** OEM 9976, 45's rear frame
- B. Stock No. 2450-1** OEM 9979, 1936-1969 Big Twins, 1957-1969 XL front frame leg
- C. Stock No. 2489-1** OEM 10012, 1961-1984 Big Twins, 1984 XL frame head tube
- D. Stock No. 2490-1** OEM 4730-30A, 1930-1949 45's and 1936-1949 Big Twins seat post tube, frame tube and frame head
- E. Stock No. 2491-1** OEM 4727-30, 1930-1948 Big Twins brake light, battery wire
- F. Stock No. 2492-1** OEM 4727-23, 1923-1933 all models taillight
- G. Stock No. 2504-1** 4703-38A, 1940-57 45's and Servi-car, and 1938-1948 Big Twins, 1957 XL horn wire
- H. Stock No. 2505-1** 9970, 1941-1964 74 OHV, 1957-1974 XL front spark plug cable
- I. Stock No. 2520-1** 4726-37, 1938-1965 Big Twins, 1957-1965 XL timer wire
- J. Stock No. 2547-1** OEM 1977, Type I, late 1945-early 1947 Big Twins, 1957-1960 XL frame head tube (bull neck)
- K. Stock No. 2545-1** OEM 9977, Type II, late 1947-1949 Big Twins, frame head tube
- L. Stock No. 2546-1** OEM 9977, Type III, 1950-1960 Big Twins, frame head tube
- M. Stock No. 2586-1** OEM 9957, 1949-1964 Big Twins timer cable clamp
- N. Stock No. 2587-1** OEM 4726-36A, 1936-1948 Big Twins timer cable clamp
- O. Stock No. 2960-1** Parkerized OEM 4726-36, 1936-1940 O.H.V. Early style spark plug cable clip
- Stock No. 2996-1** Cadmium-plated
- P. Stock No. 2951-1** Parkerized wire clip, OEM 9983 1951-1969 Big Twins tail lamp and generator harness and 1963-early 1967 Servi-car signal lamp cables.
- Q. Stock No. 3259-1** OEM 4726-24 parkerized wire clip, 1924-1929 J, JD, JDH, 1930 V, VL, VC and 1931-1932 all Singles.
- R. Stock No. 3278-2** OEM 4726-31 parkerized wire clip, 1931-1936 45", 74", 80" Twins and C Singles. Triple Clamp. Set of 2.
- S. Stock No. 3290-1** OEM 4163-30 parkerized wire clip, 1930-1936 V, VL, 1930-1931 D, DL, DLD, 1932-1936 R, RL, RLD, 1937-1940 WL, G. Control cil clamp, front fork to brake.
- T. Stock No. 3323-1** OEM 4730-30 clamp, 1930-1936 all models except 1936 61" Twins. Lighting cable.

Throttle & Spark Cable Clamps



Throttle and Brake Cable Clamps

Accurately reproduced brackets and clamps feature parkerized finish and mounting hardware as original. Available for the following:

- A. Stock No. 9005-4** 1936-1948 O.H.V. Big Twin OEM 3371-36 Throttle Cable Bracket
- B. Stock No. 9006-4** 1937-1948 S.V. Big Twin OEM 3371-37 Throttle Cable Bracket
- C. Stock No. 9007-2** 1930-up '45' OEM 9967 Throttle and Spark Cable Bracket, 2/bike
- D. Stock No. 9008-5** 1938-1948 S.V. Big Twin OEM 55627-38 Spark Cable Bracket
- E. Stock No. 2041-7** 1952-1972 KH, XL, XLH, XLCH and 1971-1972 FX Brake Cable Bracket
OEM P/N 45218-52
1968-1972, 1974 FL, FLH, FX Throttle Cable Bracket
- F. Stock No. 2760-3** 1936-1948 Big Twins, 1941-1957 45's, 1941-up Servi-Car, OEM 4162-36, Brake Cable to Fork Clip
- G. Stock No. 2909-4** 1972-1973 XLH, XLCH, Throttle Cable Bracket and Clamp, 38679-72, 27449-72
- H. Stock No. 2954-4** 1948 O.H.V. Big Twins, Throttle Cable Bracket, OEM 56604-48
- I. Stock No. 3215-4** 1949-1953 Big Twins, Throttle Cable Bracket, OEM 56605-49, 56608-49.



Spark Control Coil Frame Clip

Parkerized clamp, OEM 56626-37, screw, nut and lockwasher used on 1937-1946 Big Twins.

Stock No. 2627-4



Front Brake Cable Handlebar Clip

Parkerized clamp, OEM 9980, screw, nut and lockwasher used on 1928-1948 Big Twins and 1932-1957 45's, Servi-cars.

Stock No. 2628-4 Parkerized

Stock No. 3239-4 Chrome



Spark Plug Cable Bracket

Parkerized reproduction of OEM 1602-37 spark plug cable bracket used on 1937-1973 45's and Sidevalves.

Stock No. 2434-1



Spark Plug Cable Bracket

Zinc plated reproduction of OEM 32000-37A bracket used on 1966-1984 Big Twins.

Stock No. 3222-1



Clutch Cable Bracket

Reproduction of OEM 38676-52 brackets used on 1952-Early 1970 K, KH, XL, XLH, XLCH.

Stock No. 2208-4 Cadmium Plated

Stock No. 2209-4 Parkerized



Lower Brake Cable Clamp

Reproduction of OEM 4163-40 clamp used on 1940-1952 45's and Servi-car.

Stock No. 2949-1 Parkerized

Stock No. 2950-1 Cadmium Plated



Brake Cable Clevis Clamp and Nut

Reproduction of 45216-49 clamp and 7725 flexloc nut used on 1949-1971 EL, FL, FLH, 1971-1972 FX, 1952-1972 K, XL, and 1951-1971 45's, Servi-Car.

Stock No. 3291-2

Carburetor Brackets

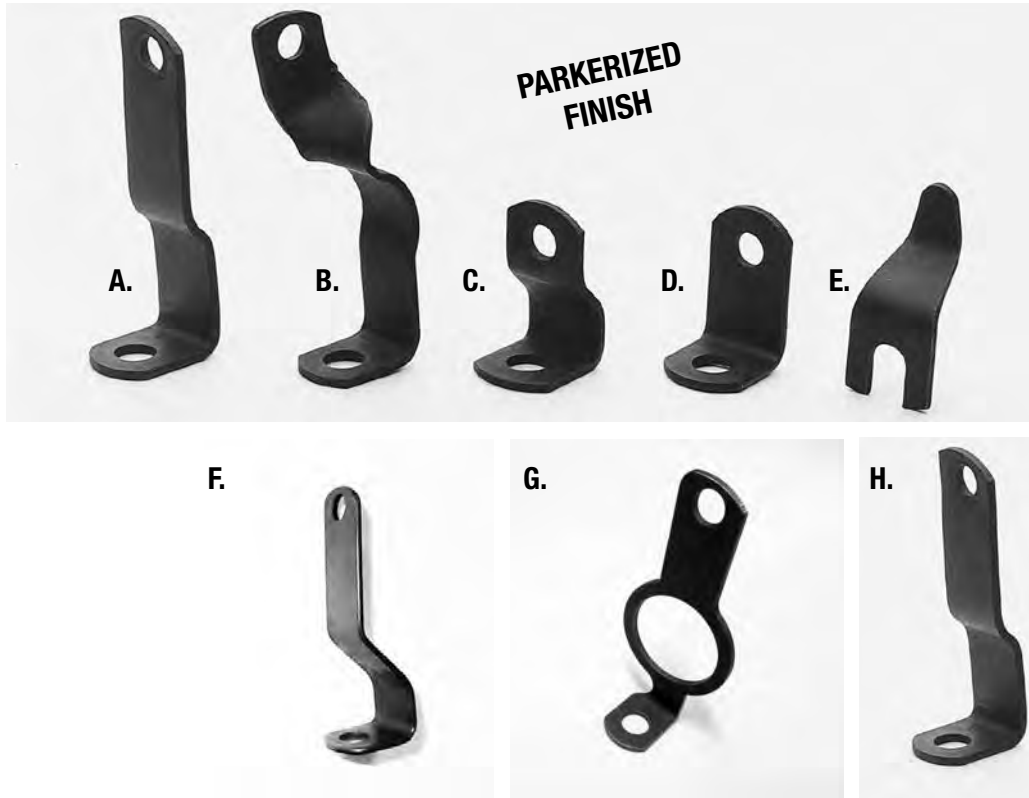

Carburetor Support Brackets

Exact reproduction of the original Harley brackets used to support the Linkert carburetor.

- | | |
|---|--|
| <p>A. Stock No. 9009-5 O.H.V. Big Twins 1948-1953
OEM 27431-41, Type 2</p> <p>B. Stock No. 9010-5 O.H.V. Big Twins Late 1955-1965
OEM 27431-41B</p> <p>C. Stock No. 9011-5 Sidevalve Big Twin 1930-1938
OEM 1110-33</p> <p>D. Stock No. 9012-5 Sidevalve Big Twin 1939-1948
OEM 1110-39</p> | <p>E. Stock No. 9013-4 45 Solo 1936-1952, Servi-car 1936-1958
OEM 27432-36</p> <p>F. Stock No. 2931-5 O.H.V. Big Twins 1936-1940
OEM 1110-36</p> <p>G. Stock No. 2953-5 O.H.V. Big Twins 1954-Early 1955
OEM 27431-41A</p> <p>H. Stock No. 3199-5 O.H.V. Big Twins 1941-1947,
OEM 27431-41, Type 1</p> |
|---|--|

Hose Clamps



Chain Oiler Hose Lower Bracket

Parkerized reproduction of 63612-53 early style bracket used on 1953-up KR models.

Stock No. 3108-1



Chain Oiler Hose Hose Clamp

Duplicate of OEM 9951 used on late 1978-1982 FL, FLH. Zinc plated.

Stock No. 3169-1



Chain Oiler Hose Upper Bracket

Parkerized reproduction of 63611-53 bracket used on 1953-1969 KR, XLCH.

Stock No. 3109-1



Chain Oiler Hose Lower Bracket

Parkerized reproduction of 63612-53 late-style bracket used on 1961-1969 XLCH.

Stock No. 3110-1

Carburetor Hardware



Carburetor Bowl Lock Nut Kit

Carburetor bowl lock nut kit includes copper gasket, nut and lockwasher. Fits all 1930-1965 Harley Twins with Linkert Carb. Replaces OEM 27375-29.

Stock No. 8901-4 Chrome Plated

Stock No. 8902-4 Cad Plated (*SHOWN*)

Stock No. 3121-6 Complete kit as above but contains drain hole in bowl lock nut, simply remove screw and drain.

Stock No. 3122-4 Complete kit as above but bowl lock nut is brass.



Carburetor Bowl Valve Cover Cap

Reproduction of OEM 27390-33 brass cap used on 1933-1952 45's, 1933-1948 74", 80" side valves, 1953-1954 Servi-car and 1952-1956 K, KH.

Stock No. 2729-1 Cad Plated

Stock No. 2732-1 Brass, not plated



Linkert Carburetor Fitting

Chrome plated steel with "O" ring seal designed to adapt Linkert carburetor to 1/4" I.D. flexible fuel line.

Stock No. 7158-2



Intake Manifold Pipe Mounting Screws

Exact duplicate of original screws.

A. Stock No. 2420-3 Nickel plated, OEM 1123-15, 1915-1923 J model (61")

B. Stock No. 2421-3 Cadmium plated, OEM 1123-21, 1921-1923 JD and 1924-1929 J, JD



Carb Mounting Screw Kit

Slotted head screws are available in many lengths and choice of plating. Fits all Twins with Linkert Carb.

Stock No. 2422-3 1930-58 R, W, and Servi-cars (all 3 bolt 1" carburetors) Parkerized OEM 1123-29, 5/8" long, 3/Kit, 1/4-24 thread

Stock No. 2423-3 1941-1946 WLD, 1941-1943 WLA, 1943 WLC. Parkerized, OEM 1123-41, 1-3/16" long, 3/Kit, 5/16-18 thread

Stock No. 8158-8 All Linkert without insulator block, Chrome, OEM 27422-39, 3/4" long, 4/Kit, 5/16-18 thread

Stock No. 8159-8 All Linkert without insulator block, Cadmium, OEM 27422-39, 3/4" long, 4/Kit, 5/16-18 thread

Stock No. 9672-8 All Linkert without insulator block, Parkerized, OEM 27422-39, 3/4" long, 4/Kit, 5/16-18 thread

Stock No. 8929-8 All Linkert with insulator block, Chrome, OEM 27424-48, 15/16" long, 4/Kit, 5/16-18 thread

Stock No. 8930-8 All Linkert with insulator block, Cadmium, OEM 27424-48, 15/16" long, 4/Kit, 5/16-18 thread

Stock No. 9664-8 All Linkert with insulator block, Parkerized, OEM 27424-48, 15/16" long, 4/Kit, 5/16-18 thread

Stock No. 2455-3 1930-1939 61", 74", 80" Twins and 1940 WL, WLD. Parkerized, OEM 1123-30, 5/8" long, 3/Kit, 5/16-18 thread



Carburetor Control Coil Clip

Cadmium plated reproduction of OEM 9959 clip used on 1949-1957 45's. Also used as timer wire clip on 1961-64

Servi-car. 2/kit.

Stock No. 2552-2



S&S Carburetor Chrome Allen Screw Kit

Chrome plated smooth head allen screws replace the stock screws for a more decorative finish. For "E" and "G" models.

Stock No. 2596-13

Carburetor Hardware



Carburetor Idle Hole Body Plug and Idle Passage Plug Screws
Exact duplicate of OEM 27325-33 plug and OEM 27327-24 screws used on all 1933-1965 Linkert carburetors.
Stock No. 2681-4



Carburetor Throttle Lever Wire Block
Cadmium plated duplicate of OEM 27450-36 block, screw, cotter pin and brass washers used on all Linkert and Bendix carburetors.
Stock No. 2658-5 Standard Size
Stock No. 2664-5 Oversized +.005



Carburetor Needle Valve Lever Screw
Correct reproduction of OEM 27397-27 screw used on all 1927-1965 linkert carbs, cadmium plated.
Stock No. 2598-1



Linkert Venturi Removal Tool
This Colony designed tool is precision machined from steel and heat treated for durability. This tool will easily remove the most stubborn venturis and includes set of 3 interchangeable adaptors to service all Linkert carbs. NOTE: The use of an arbor or hydraulic press is strongly recommended.
Stock No. 2701-6



Carburetor Float Valve and Seat
Reproduction of OEM 27382-33 float valve and seat, OEM 27402-33 gasket used on 1933-1965 Linkert carburetors.
Stock No. 2880-3



Carburetor Float Lever Screw Kit
Cadmium plated screw with rod, OEM 27383-11 and screw, 27384-16, used on 1916-1965 Schebler and Linkert carburetors.
Stock No. 2827-3

Carburetor Hardware

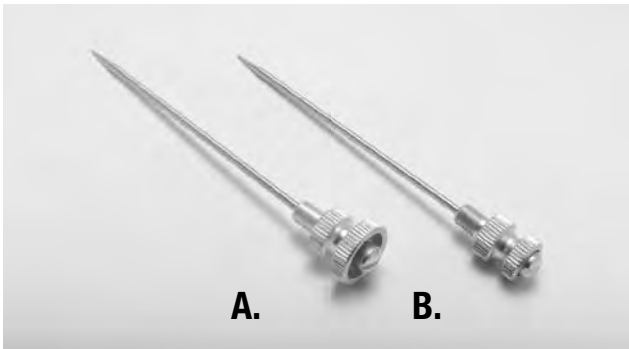

Linkert Low Speed Needle Valve

Accurate reproduction of OEM 27337-27 needle valve used on all 1948-1965 1-1/4" and 1-1/2" carburetors. 3-1/2" long needle available with Type 1 or Type 2 head.

A. Stock No. 2695-5 Type 1

B. Stock No. 2696-5 Type 2



Linkert Carburetor High Speed Needle

Cadmium plated reproduction of 27300-50 needle used on 1950-1965 Big Twins.

Stock No. 2700-1

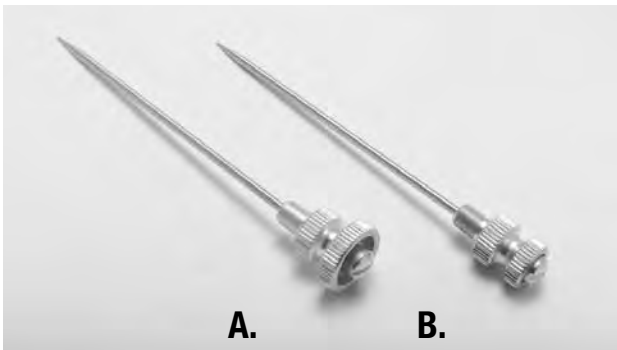

Linkert Low Speed Needle Valve

Accurate reproduction of OEM 27340-33 needle valve used on all 1933-1947 1" carburetors. 3-1/16" long needle available with Type 1 or Type 2 head.

A. Stock No. 2707-5 Type 1

B. Stock No. 2708-5 Type 2



Linkert Carburetor High Speed Needle

Cadmium plated reproduction of 27297-52 needle used on 1952-1956 K Models..

Stock No. 2697-1



Low Speed Needle Valve Lever Spring Collar and Spring

Reproduction of OEM 1262-27 collar and OEM 1264-27 spring used on all 1927-1965 Linkert carburetors.

Stock No. 2643-2

Linkert Carburetor Venturi

Carburetor Data Chart

1" Linkert M Series Carburetors

H-D Part #	Model #	Venturi Size	Application
1133-30	M-4	7/8"	1930-1935 D, R and Servi-Car
	M-11	7/8"	
1133-30	M-16	7/8"	1930-1935 RL, 1930-1935 74 Commercial
1133-36 (27120-36)	M-16	7/8"	1936-1948 R, W and Servi-Car
27120-30	M-18	7/8"	1949-1958 W and Servi-Car
27150-42	M-17R	13/16"	1942 XA right cylinder
27151-42	M-17L	13/16"	1942 XA left cylinder

1-1/4" Linkert M Series Carburetors

H-D Part #	Model #	Venturi Size	Application
1134-30	M-2	1-1/16"	1930-1933 74 except commercial, 1930-1936 DLD and RLD, 1936 RL
	M-31	1-1/16"	
	M-21	1-1/16"	
1134-33	M-31 M-41	1-1/16"	1933 VLD, 1934-1935 74, 1937-1941 WL and WLD, 1936 VLD
1134-35	M-41L	1-1/8"	1935-1936 VLH
1134-36	M-5	1-1/16"	1936-1939 E and EL
27128-36	M-55	1-1/16"	1936-1939 E and EL, a 1950s replacement carb
1134-37 (27122-37)	M-51	1-1/16"	1937-1948 U and UL, 1942-1948 WL, WLD, 1942 US (US Navy)
1134-37A	M-51L	1-1/8"	1937-1941 UH and ULH
1133-40M	M-64	1-1/16"	1940 WLA
1134-40M	M-65	1-1/16"	1940 UA
1133-41M	M-84	1-1/16"	early 41WLA unknown military model with oil bath filter
	M-641	15/16"	
1133-41M	M-88	15/16"	later 41WLA, all 42WLA, 1942-43 WLC, 1949-early-1951 WLA
1134-41T	M-97	1-1/16"	1941 TA
1134-41	M-90	15/16"	1942 ELC and 1942 ELA
1134-42M	M-58	1-1/16"	1941-1942 US (South Africa), 1943-1944 US (Navy)
27122-37	M-52	1-1/16"	1949-early-1951 45 except W and Servi-Car
27122-37	M-54	1"	later-1951-1952 45 W and Servi-Car
1133-41M	M-54B	1"	later-1951-1952 WLA

1-1/2" Linkert M Series Carburetors

H-D Part #	Model #	Venturi Size	Application
1134-40	M-25	1-5/16"	1940 E and EL, early-1941 F and FL
1134-40 (27126-40)	M-75	1-5/16"	later-1941 FL and FLH, optional for 1942-1948 F and FL
1134-40A	M-35 M-35T M-35TP	1-1/8"	1941-1948 E and EL, 1942-1948 F and FL (27128-40)
27128-48	M-36 M-36A	1-1/8"	1949-early-1950 61, early-1949 F and FL field conversion for M-36
27128-48	M-61	1-1/8"	later-1950-1952 E and EL
27128-48	M-61B	1-1/8"	later replacement carburetor for 1949-1952 61
27130-48	M-45 M-45A	1-5/16"	later-1949-early-1950 F and FL field conversion for M-45
		1-5/16"	
27130-48	M-74	1-5/16"	later-1950-early-1951 F and FL
27130-48	M-74B	1-5/16"	later-1951-1965 F and FL
27146-52	M-53	19/32"	1952-1954 K
		1-1/4"	
27146-52A	M-53A1	1-5/16"	1955-1956 KH

*** Carburetor data chart is reprinted with permission from Bruce Palmer III, author of "How to Restore Your Harley-Davidson" ©

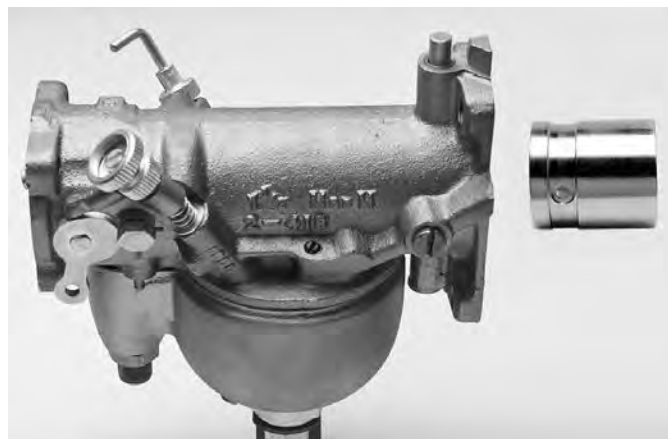

Venturis for Linkert Carburetors to Fit All Models Harley-Davidson 1930-1965

These precision machined aluminum venturis are made to exacting tolerances in the Colony tradition for perfect fit and like-new performance.

Colony P/N	OEM P/N	Venturi Size	Application Carburetor Model P/N
2328-1	27360-29 1265-29A	7/8"	M4, M11, M16, M18
2330-1	27361-30 1265-30	1"	M31, M42, M54, M54B
2332-1	27362-30 1265-30A	1-1/16"	M2, M5, M21, M41 M51, M52, M55, M58, M64, M65, M84, M97
2822-1	Same as 2332-1 but +.025" oversized outside diameter		
2334-1	27363-30 1265-30B	1-1/8"	M41L, M51L
3164-1	Same as 2334-1 but +.025" oversized outer diameter		
2336-1	27363-40 1265-40	1-1/8"	M61B, M61, M36A, M36, M35, M35T, M35TP
2710-1	Same as 2336-1 but +.025" oversized outside diameter		
2338-1	27363-41 1265-41	1-5/16"	M74B, M74, M45A, M45
2818-1	Same as 2338-1 but +.025" oversized outside diameter		
2340-1	27364-41 1265-41M	15/16"	M88, M90, M641

Venturis for Linkert Carburetors used on Indian Models

Stock No. 2465-1 1941-1948 Chiefs. Used on: M-6, M-341, M-343 and M-344 carburetors.

Stock No. 2467-1 80" Chiefs and Bonneville. Used on: M-350, M-352 and M-Bonn carburetors.

Chain Guard/Inner Primary Mounting Kits



Inner Primary Mounting Kit

This complete mounting kit contains reproductions of the original Harley hardware used to mount the inner primary cover on 1936-1954 Big Twins.
Stock No. 7811-14



Inner Primary Mounting Kit

Complete mounting kit contains reproductions of original Harley hardware used to mount a stamped steel inner primary cover on Big Twins 1955-1964.
Stock No. 7812-12



Inner Primary Mounting Kit

This complete mounting kit contains reproductions of the original Harley hardware used to mount the cast aluminum inner primary cover to case on Harley Big Twins 1965-1969.
Stock No. 8798-12



Inner Primary Mounting Kit

Complete hardware kits properly mount inner primary on the following:

- Stock No. 9868-26** FL, FX 1970-1979
- Stock No. 9869-24** FL, FX 1980-1985
- Stock No. 9904-17** FLT, FXR 1986-2000
- Stock No. 9870-16** Softail 1986-1993 and Dyna Glide 1991-1993
- Stock No. 9873-16** Softail 1994-1999, Dyna Glide 1994-1998
- Stock No. 2294-14** 1999-2005 Dyna Glide, 2000-2006 Softail, 2001-2006 FLT



Inner Primary Chain Guard Kit

Parkerized complete hardware and mounting kit correct for all Harley Big Twins 1936-1944 with stamped steel cover. Contains 3805-36B Type 1 locks.
Stock No. 3073-16



Inner Primary Chain Guard Kit

Parkerized complete hardware and mounting kit fits all Harley Big Twins 1945-1954 with stamped steel cover. Contains 3805-36B Type 2 lock.
Stock No. 3045-14



Inner/Outer Primary Cover Mounting Kit

This complete mounting kit contains reproductions of the original Harley hardware used to mount the inner and outer primary covers.
Stock No. 8627-9 1937-1964 45's (shown)
Stock No. 3004-9 1930-1936 VL's



Inner Primary Cover Rear Chain Guard Bolt Kit

Bolts, washers, springs, nuts to mount cover to frame. Duplicate of OEM factory kit 3814-36. Fits all 1936-1964 Big Twins.
Stock No. 9601-10 Parkerized
Stock No. 2071-10 Chrome Plated

Chain Guard/Inner Primary Mounting Kits



Chain Guard Stud

Cadmium plated duplicate of OEM 472-30 stud, washers and nut used on 1930-1936 VL.
Stock No. 2978-4



Inner Primary Chain Guard Mounting Kit

Complete mounting kit contains the following: 3813-29 bolts, 3815-29 cupped washers, 3814-29 springs, 0215 washers, 0108 nuts, and 0290 cotter pins. Fits 1929-1940 45's and 1929-1934 Singles. Parkerized.
Stock No. 2283-12



Outer Chain Guard Mounting Kit

Parkerized reproduction of OEM 3550 screws used to mount outer chainguard on 1951-1973 Servi-cars.
Stock No. 2431-9

Rear Chainguard Mounting Kit

Reproduction of CP 1038, 4012, and 3974 bolts, 6107B flat washers, 5926B spacer and 11411 grommet and locks used on 1963-1982 FL, FLH.

Stock No. 3292-9 Cadmium Plated
Stock No. 3293-9 Chrome Plated



Rear Chain Guard Mounting Kit

All hardware required to properly mount rear chain guard on all 45 Solo 1936-1952, Servi-Car to 1973.

Stock No. 9744-7 Chrome Plated

Stock No. 9745-7 Cad Plated

Stock No. 9746-7 Parkerized

Stock No. 3040-7 Parkerized (Plain Head Bolts)



Front Chain Guard Inner Primary Cover Mounting Kit

Duplicate of OEM 60648-39 screw plugs and OEM 60650-32 washers used on all 1939-1973 45's and Servi-car.

Stock No. 2521-4



Front Chain Guard Inner Primary Mount Plug Remove/Install Plug

Tool to remove and mount the 60648-39 plugs on 1939-1973 45's and Servi-car. Use screw to secure tool to plug.

Stock No. 3111-2

Fender Mount Kits

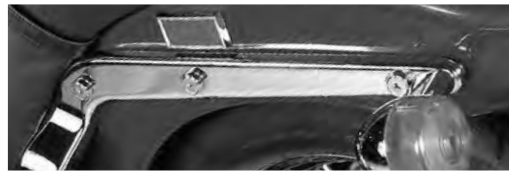

Rear Fender Strut Mounting Kit, Custom

Chrome plated unique low profile allen hardware kits mount struts.

Stock No. 9920-46 Mounts 4 hole struts, OEM 59969-86 on 1986-99 5 speed Heritage Softail and Fat Boy (shown)

Stock No. 9921-56 Mounts 6 hole struts, OEM 59954-86 on 1986-99 FXST, FXSTC, FXSTS and Bad Boy.

Stock No. 2043-26 2000-2003 FL, 2000-2002 FX *except* FX Deuce.

Stock No. 2268-10 2004-up Sportster

Stock No. 2497-38 2004-up FL, 2003-up FX

(See pages 14, 16, 18, 21 for Acorn and Allen style kits)



Rear Fender Mounting Kit

Reproduction of stock Harley hardware used to install rear fender on 45 Solo 1929-1952.

Stock No. 9790-15 Chrome Plated,

Stock No. 9791-15 Cad Plated (1038 CP)

Stock No. 9792-15 Parkerized (1038 CP)

Stock No. 3042-15 Parkerized (Machined Plain Head Bolts)



Front Fender Mounting Kit

Correctly reproduced locktabs, OEM 7410, and bolts used to mount front fender on 1951-1978 FL, FLH.

Stock No. 2290-8 Parkerized

Stock No. 2291-8 Cadmium

Stock No. 2292-8 Chrome



Front Fender Mounting Kit

Reproduction of stock Harley hardware used to install stock front fender on all 1936-1948 Springers.

Stock No. 9742-6 Chrome Plated

Stock No. 8203-6 Cad Plated

Stock No. 9680-6 Parkerized

Stock No. 8009-2 Locks Only-Parkerized



Rear Fender Mounting Kit

Reproduction of stock Harley hardware used to install rear fender.

Stock No. 9708-18 Chrome Plated, 1936-1957 Big Twins

Stock No. 8202-18 Cad Plated, 1936-1957 Big Twins (1035, 1038 CP)

Stock No. 9707-18 Parkerized, 1936-1957 Big Twins (1035, 1038 CP)

Stock No. 3041-18 Parkerized, 1936-1957 Big Twins (Machined Plain Head Bolts)



Rear Fender Brace Bracket Bolt Kit

Parkerized OEM 3743-23 bolts, nuts and washers used on 1923-1940 Twins.

Stock No. 2460-2



Rear Fender Frame Clamp Bolt Kit

OEM 59802-47 and 4004 bolts, nuts and washers used on 1936-1957 Big Twins. (Machined Plain Head Bolts)

Stock No. 2493-6 Parkerized

Stock No. 3220-6 Chrome Plated



Rear Fender Support Mounting Kit

Duplicate of stock OEM hardware organized in kits for the following Harley Models:

Stock No. 8879-30 FL, FLH 1958-1980 Chrome

Stock No. 2625-30 FL, FLH 1958-1980 Cadmium

Stock No. 8880-18 K, XL 1952-1958 Chrome

Stock No. 2626-18 K, XL 1952-1958 Cadmium

Stock No. 8881-18 XL 1959-1978 Chrome

Stock No. 2665-18 XL 1959-1978 Cadmium

Fender Mount Kits



Fender to Brace Rivets and Tool

Reproduction of 0314 fender rivets used on 1930-1979 all Harley models. Installation tool included. 10 rivets.

Stock No. 2980-11



Front Fender Mounting Kit

Cadmium plated 3948 bolts (7/16" hex) 7127 locks and 7744 nuts used on 1954-1969 K models and Sportster.

Stock No. 3276-14



Fender Hinge Pin and Rivet Kit

Pin and rivets used to mount hinge onto fender.

Stock No. 2805-5 1930-1942 All models. Brass pin OEM 3752-30, 0314 rivets.

Stock No. 2806-5 1943-1979 All models. Steel pin OEM 59862-30, 8515 rivets.



Front Mud Flap Mounting Kit

Parkerized reproduction screws, washers and nuts used on 1932-1949 45's and Big Twins.

Stock No. 3180-18



Rear Fender Brace Bracket Bolt Kit

Cadmium plated 5425 carriage bolts, nuts and washers used on 1941-1957 Big Twins and 45's.

Stock No. 3064-2 Parkerized

Stock No. 3205-2 Cadmium plated

Stock No. 3206-2 Chrome plated

Replacement Hardware



Dash Plate Mounting Kit

This kit contains all the hardware required to properly install the dash plate and cover on all Harley Twins 1936-1946. Another kit from Colony to make restoration or custom building more fun.

Stock No. 7715-6



Dash Cover Mounting Center Screw and Stud Kit

This kit features a chrome plated center screw without choke cable hole. In addition to the perfectly reproduced center screw, OEM 71075-47, this kit also includes the center screw washer, OEM 6466, mounting base stud, OEM 71067-47, lockwasher, OEM 71069-47, and locknut, OEM 7848 used on all Harley models 1947-1967.

Stock No. 7716-2 Complete
Stock No. 8483-2 Center Screw Only

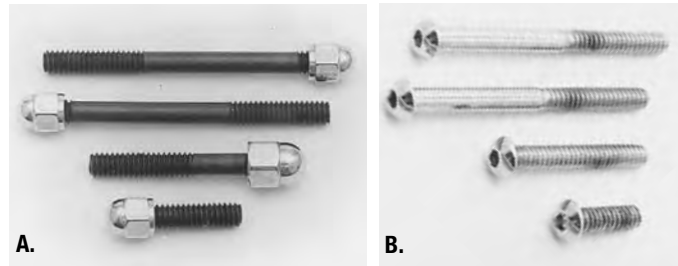

A. Dash Mounting Kit

Chrome plated hardware to mount dash on the following:

Stock No. 8016-4 Acorn Style, 1977-1985 FX

Stock No. 8476-4 Cap Style, 1977-1985 FX

Stock No. 9014-3 Acorn Style, 1986-up FXR models except FXRS 1988-up

Stock No. 9015-3 Cap Style, 1986-up FXR models except FXRS 1988-up

B. Dash Screw Kit

Chrome plated allen screws mount dash on the following:

Stock No. 8775-4 1977-1985 FX

Stock No. 9016-3 1986-up FXR models except 1988-up FXRS



Tool Box Mounting Kit

All the necessary stock hardware to mount the tool box.

Stock No. 2456-10 Parkerized, 1931-1934 Twins

Stock No. 2457-8 Parkerized, 1935-1936 74" Twins and 1931-1934 45's and singles

Stock No. 2458-8 Chrome, 1935-1936 74" Twins and 1931-1934 45's and singles

Stock No. 8206-9 Cad Plated, 1935-1954 all Harley-Davidson

Stock No. 9669-9 Parkerized, 1935-1954 all Harley-Davidson

Stock No. 2002-13 Cad Plated, 1955-1957 Big Twins (shown)

Stock No. 2003-6 Cad Plated, 1958-early 1962 Big Twins

Stock No. 2004-6 Cad Plated, late 1962-1964 Big Twins

Stock No. 2005-9 Cad Plated 1952-1966 K, KH, XL, XLH



Ignition Switch Mounting Spacer Kit

Cadmium plated spacer, OEM 4560-41MA, screws and washers used on WLA with original switch and blackout feature.

Stock No. 2618-12

Jiffy Stand Mounting



Jiffy Stand and Foot Clutch Lever Bracket Mounting Kit

Nuts, bolts and washers are duplicates of OEM hardware used on 1936-1978 Big Twins.

Stock No. 9617-18 Chrome Plated

Stock No. 9618-18 Cad Plated (1035, 1038 CP)

Stock No. 9619-18 Parkerized (1035, 1038 CP)

Stock No. 3043-18 Parkerized (Machined Plain Head Bolts)



Jiffy Stand Pin and Screw Kit

Jiffy stand pin, OEM 50090-53 and screw, OEM 1760B for use on 1954- Early 1984 Sportster.

Stock No. 2079-2



Jiffy Stand Leg Bracket Mounting

U-Bolt Kit

Parkerized 1723-30 u-bolt, nuts and lockwashers used on 1930-1952 45" Solo and 1930-1936 VL.

Stock No. 2653-5



Jiffy Stand Mounting Kit

Zinc plated 50003-89B pin, 554A clip, washers and 53158-98 (53176-08) bushings as applicable.

Stock No. 3133-4 1991-up Dyna models

Includes pin, washers and clip

Stock No. 3134-4 2002-up VRSC, 2007-up Softail, 1998-up Sportster

Includes pin, bushings and clip (*SHOWN*)

Stock No. 3135-3 1989-1997 Sportster

Includes pin, washer and clip



Jiffy Stand, Shift Lever, Footrest & Brake Lever Brackets Mounting Kit

Chrome plated polished allen screws, flat head allen screws and custom countersunk washers fit 2000-up Softail.

Stock No. 2049-18



Jiffy Stand Clevis Pin Pretzel Clip

Reproduction of OEM 554A clip used on 1989-up XL, 1991-up Dyna, 2002-up VRSC and 2007-up Softail.

Stock No. 3181-5 Zinc plated

Stock No. 3182-5 Chrome plated

Footboard Mounting



Footboard Hinge Bolt Kit

Reproduction of special shoulder bolts used to mount footboards on all Harley Davidson 1914-1981, OEM 2954-14.

Stock No. 9886-12 1914-1940, Slotted, Parkerized

Stock No. 8773-12 1941-1981, Hex Style, Cad Plated

Stock No. 9685-12 1941-1981, Hex Style, Parkerized



Footboard Hinge Rivet Kit

Reproduction of 2945-14, 50628-14 rivets used on 2938-14 (rectangular) and 50603-40 (half moon) footboards, 1914-1973 All Harley models. 8/kit.

Stock No. 3248-8



Footboard Hinge Bolt—Buddy Footrest Bolt Kit

Reproduction of special shoulder bolts, pins and bushings used to mount footboards and buddy footrest on all 1941-1964 Harley Davidson.

Stock No. 8774-18 Cad Plated

Stock No. 9722-18 Parkerized



Footboard Hinge Bolt Kit

Reproduction of special shoulder bolt, OEM 50635-82. Fits all 1982-up FL and FX with footboards.

Stock No. 2125-12 Chrome plated

Stock No. 3173-8 Zinc plated

Footboard Mounting

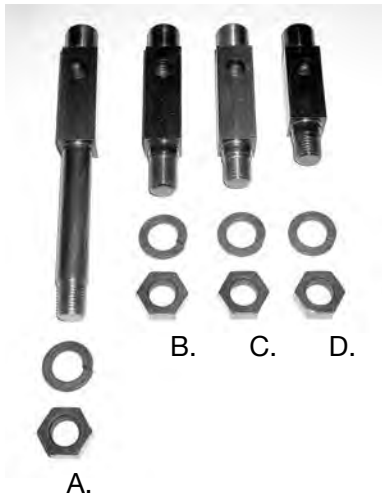

Footboard Mounting Stud Kit

Correct parkerized reproduction of studs, nuts and washers used to mount floorboards.

- A. Stock No. 2605-3** 1914-1922 All Models
OEM 2948-14 Stud
- B. Stock No. 2606-3** 1914-1928 All Models
OEM 2949-14 Stud
- C. Stock No. 2607-3** 1925-1928 All Models
OEM 2950-25 Stud
- D. Stock No. 2608-3** 1924-1928 All Models
OEM 2951-24 Stud

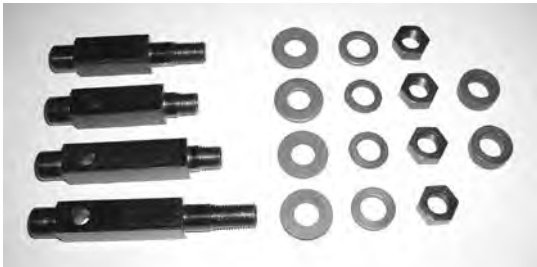

Footboard Mounting Kits

Correct parkerized reproduction of studs, nuts and washers used to mount floorboards.

- Stock No. 2579-18** 1935-1973 45's and Servi-car, contains studs 2949-35, 2951-24, 2951-35.
- Stock No. 2604-12** 1930-1936 VL, contains studs 2949-14, 2948-30, 2949-30, 2950-30.

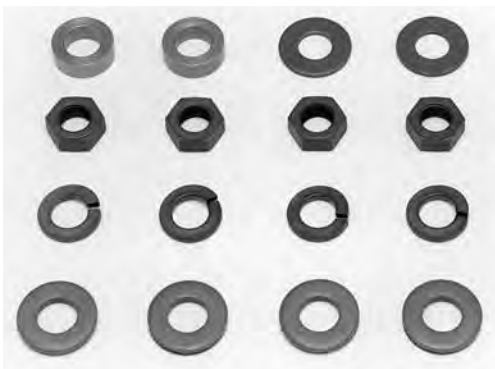

Footboard Stud Mounting Kit

Parkerized duplicates of original fasteners used to mount footboard studs.

- Stock No. 9905-16** Big Twins 1936-1957 (shown)
- Stock No. 9906-14** Servicar and 45 Solo 1935-up



Footboard Mounting Kit

Correct parkerized reproduction of studs, nuts and washers used to mount floorboards on 1936-1954 Big Twins. Contains studs 2948-36, 2949-36 and 2950-36.

Stock No. 2675-20



Footboard Mounting Kit

Parkerized studs 50658-36, 50655-36, 50654-36, 50658-55, washers and nuts used to mount footboards on 1955-1957 Big Twins.

Stock No. 3154-18



Footboard Mounting Kit

Parkerized studs 50656-48A, 50658-55, 50658-58, 50655-58A, washers and nuts used to mount footboards on 1958-1964 Big Twins.

Stock No. 2912-14



Footboard Mounting Kit

Parkerized studs, washers and nuts used to mount footboard on 1965-1969 Big Twins. Studs: 50658-58, 50655-58A, 50658-55.

Stock No. 3168-16

Replacement Hardware



Left and Right Sidebar-Front and Rear Support Rod Mounting Kit
 Accurately reproduced special shoulder nuts, nuts and washers fit all 45's 1932-1973.
Stock No. 9800-14 Chrome Plated
Stock No. 9801-14 Cad Plated
Stock No. 9802-14 Parkerized



Foot Brake Lever & Bracket Mounting Kit
 Nut, washers and bolts are duplicates of OEM hardware used on 1936-1971 Big Twins.
Stock No. 9732-7 Chrome Plated
Stock No. 9733-7 Cad Plated (1035 CP)
Stock No. 9734-7 Parkerized (1035 CP)
Stock No. 3044-7 Parkerized (Machined Plain Head Bolts)



Footpeg Mounting Shoulder Bolt and Nut Kit - Custom
 Chrome plated low head socket cap screws add a custom look to all driver and/or passenger pegs on 1969-up FL, FX, XL. Replaces OEM 4721.
Stock No.2048-4



Footpeg Mounting Shoulder Bolt and Nut Kit
 Shoulder bolts and locknuts to mount driver and passenger pegs are available in chrome plated custom dome or stock.
Stock No. 8850-4 Chrome Plated Custom Dome FX, XL, FL Driver and/or Passenger 1952-1968, OEM P/N 50970-52
Stock No. 9965-4 Stock Cad Plated, 1952-1968, OEM P/N 50970-52, 7725
Stock No. 8851-4 Chrome Plated Custom Dome FX, XL, FL Driver and/or Passenger 1969-up, OEM P/N 4721
Stock No. 9966-4 Stock Zinc Plated, 1969-up, OEM P/N 4721, 7778



Machine Gun Bracket and Ammunition Box Mounting Kit
 Correct reproduction of all fasteners used to mount OEM 11202-42M and 11201-42M brackets on 1940-42 WLA.
Stock No. 2554-34

Chrome Plated Disc Brake Rotor Hardware Kits

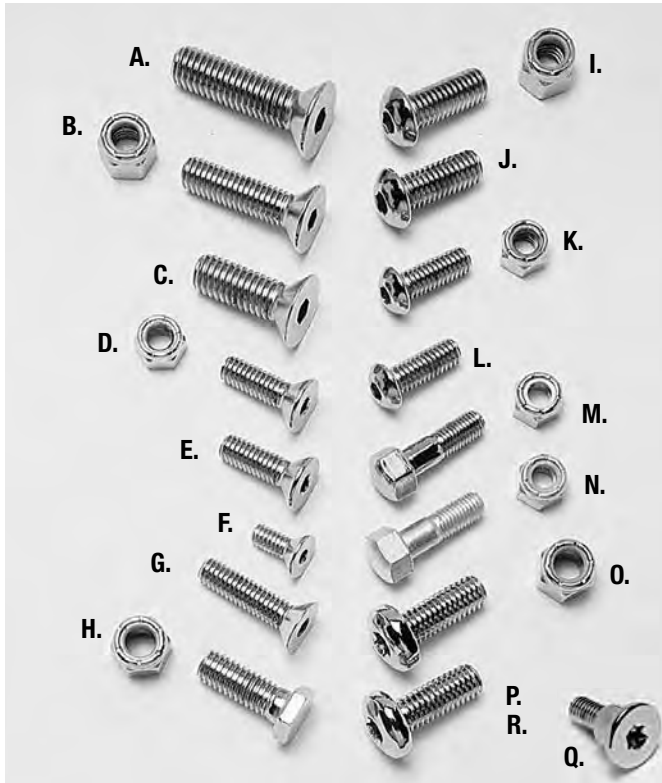

- A.** Front or Rear Rotor to Hub Screw Kit fits 1982-1985 FLT. OEM 1642. 7/16-14 x 1-3/4 F.S.
Stock No. 8847-5
- B.** Rear Rotor to Hub Screw & Nut Kit fits 1979-up, FX, XL, 1981-1984 FL Spoke or cast. OEM 1605 and 1604. 3/8-16 x 1-1/2 F.S.
Stock No. 8791-10
- C.** Front or Rear Rotor to Hub Screw Kit fits 1980-1981 FLT. OEM 1643. 7/16-14 x 1-1/4 F.S.
Stock No. 8792-5
- D.** Front Rotor to Hub Screw & Nut Kit fits 1978-1983 FXWG. Dual disc requires 2 sets. 5/16-18 x 1 F.S.
Stock No. 8831-10
- E.** Front Rotor to Hub Screw Kit fits dual disc FX, XL 1978-1982. 5/16-18 x 7/8 F.S.
Stock No. 8758-10
- F.** Front Rotor to Hub Screw Kit fits single disc FX, XL 1974-1977. 1/4-20 x 5/8 F.S.
Stock No. 8759-5
- G.** Front Rotor to Hub Screw Kit fits 1974-80 FX, 1974-77 XL with mag wheel. 5/16-18 x 1-1/4 F.S.
Stock No. 9600-5
- H.** Front & Rear Rotor to Hub Thin Hex Head Bolt & Nut Kit fits 1973-1980 FL rear, 1973-1974 FL front, 1973 FX, XL front. OEM 41198-73. 3/8-16 x 1 Hex.
Stock No. 8738-10
- I.** Front & Rear Rotor to Hub Bolt & Nut Kit. Same application as 8738-10 above but contains button head allen screws. 3/8-16 x 1 Button.
Stock No. 8739-10
- J.** Rear Cast Wheel Rotor Bolt Kit fits all 1979-1991 FX, FL and 1979-1996 XL with cast rear wheel. 3/8-16 x 1 Button.
Stock No. 9632-5
- K.** Front Rotor to Hub Screw & Nut Kit fits 1984-up FXST, FXWG. 5/16-18 x 7/8 Torx. OEM 3655.
Stock No. 8794-10 Chrome plated
Stock No. 3268-10 Zinc
- L.** Front Rotor to Hub Screw Kit fits 1984-up FX, FXR, XL, FLT single disc. Fits 2006-up Dyna Laced Wheel. Dual disc requires 2 sets. 5/16-18 x 7/8 Torx. OEM 3655.
Stock No. 8793-5 Chrome plated
Stock No. 3267-5 Zinc
- M.** Rear Brake Drum Bolt & Nut Kit. Special chrome plated shouldered bolts and locknuts. 5/16-24 Special Hex.
Stock No. 8811-16 1966-1978 XL, 1" long
Stock No. 2800-16 1952-1965 K, KH, Sportster, 3/4" long
- N.** Rear Brake Drum Bolt & Nut Kit as above except cad plated.
Stock No. 8812-16 1966-1978 XL, 1" long (Nylock Nut)
Stock No. 2801-16 1952-1965 K, KH, Sportster, 3/4" long (Flexloc Nut)
- O.** Rear Rotor to Hub Bolt & Nut Kit fits XL, FLT, Softail and Dyna Glide 1992-up. OEM 43567-92 screw. 3/8-16 x 1 Torx.
Stock No. 9807-10 Chrome plated
Stock No. 3270-10 Zinc
- P.** Rear Disc Brake Rotor Screw Kit fits all models 1997-up with cast rear wheel. OEM 43567-92 screw. 3/8-16 x 1 Torx.
Stock No. 9818-5 Chrome plated
Stock No. 3269-5 Zinc
- Q.** Front Rotor to Hub Screw Kit fits 2006-up Dyna Cast Wheel only. OEM 3762M
Stock No. 2341-5
- R.** Front Rotor to Hub Screw Kit fits 2014-up Touring models (Except FRM Road King). OEM 41500020. 8mm x 1.25 x 30mm Torx.
Stock No. 2925-10

Chrome Plated Rear Sprocket Hardware Kits

Chrome Plated Rear Sprocket Hardware Kits with Flat Head Allen Screws & Companion Countersunk Washers for Ultra Custom Applications



Flat Head Allen Screws, Companion Countersunk Washers & Locknuts fit 1973-up Big Twins and Sportster with chain drive spoke rear wheel. Replaces OEM 41197-73.

Stock No. 9856-15

Flat Head Allen Screws and Companion Countersunk Washers fit 1973-1992 Big Twins and 1979-1990 Sportster with cast rear wheel including belt drive and 1993-1998 Big Twins, except 1997-1998 Softail with spoke rear wheel. Replaces OEM 3769.

Stock No. 9857-10

Flat Head AllenScrews, Companion Countersunk Washers & Locknuts fit 1985-1992 Big Twins with belt drive spoke rear wheel. Replaces OEM 4726.

Stock No. 9858-15



Front Wheel Hub Plate

Powder coated plate used on various 2000-2015 Sportster models. Can be used on other models 2-15/64" ID x 4-3/8" OD x 5/16" holes.

Stock No. 3320-1 Replaces 43359-00, Silver

Stock No. 3321-1 Replaces 43355-00, Black

Chrome Plated Rear Sprocket Hardware Kits

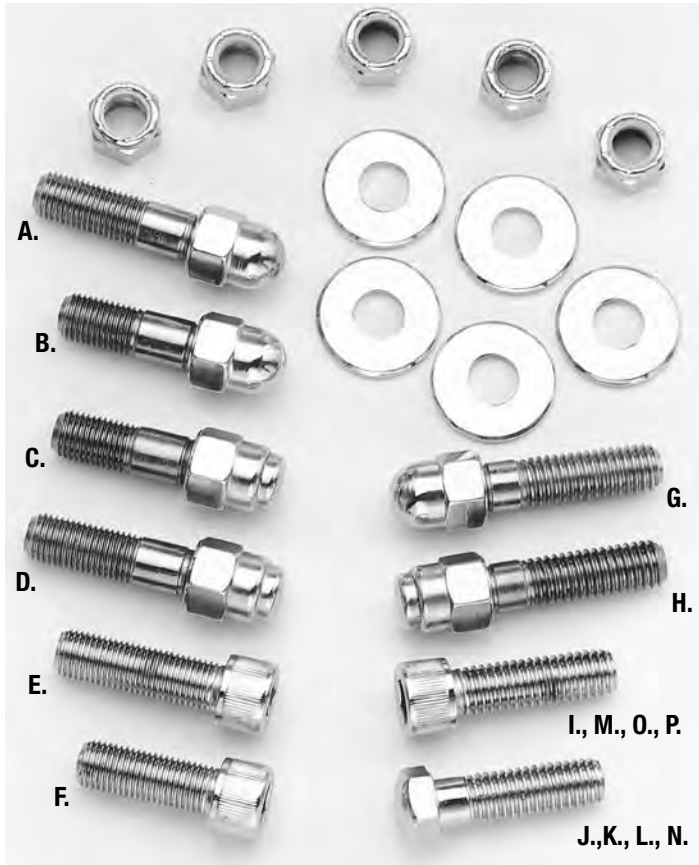

12 Point
E, F, I.

- A. Acorn Style Sprocket Bolt & Nut Kit fits 1985-1992 Big Twins with belt drive spoke rear wheel. Replaces OEM P/N 4726.
Stock No. 8843-10
- B. Acorn Style Sprocket Bolt & Nut Kit fits 1973-up Big Twins & Sportster with chain drive spoke rear wheel. Replaces OEM P/N 41197-73.
Stock No. 8836-10
- C. Cap Style Sprocket Bolt & Nut Kit fits 1973-up Big Twins & Sportster with chain drive spoke rear wheel. Replaces OEM P/N 41197-73.
Stock No. 8837-10

Chrome Plated Sprocket Washer Kit

Chrome plated hardened washers for sprockets using 7/16" bolts. 5/Pack.
Stock No. 2670-5



Sprocket Bolt Chrome Washer Kit

Chrome plated spring steel washers used on 7/16" rear sprocket bolts on most 1973-up Big Twins and 1979-up Sportsters.
Stock No. 3009-5

- D. Cap Style Sprocket Bolt & Nut Kit fits 1985-1992 Big Twins with belt drive spoke rear wheel. Replaces OEM P/N 4726.
Stock No. 8844-10
- E. Sprocket Bolt & Nut Kit fits 1985-1992 Big Twins with belt drive spoke rear wheel. Replaces OEM P/N 4726.
Stock No. 8842-10 Polished Allen Bolts, 7/16-20 x 1-1/2
Stock No. 2275-10 12 Point Bolts, 7/16-14 x 1-1/2
- F. Sprocket Bolt & Nut Kit fits 1973-up Big Twins & Sportster with chain drive spoke rear wheel. Replaces OEM P/N 41197-73.
Stock No. 8834-10 Polished Allen Bolts, 7/16-20 x 1-1/4
Stock No. 2276-10 12 Point Bolts, 7/16-14 x 1-1/4
- G. Acorn Style Sprocket Bolt & Washer Kit fits 1973-1992 Big Twins and 1979-1990 Sportster with cast rear wheel including belt drive and 1993-1998 Big Twins, except 1997-1998 Softail with spoke rear wheel. Replaces OEM P/N 3769, 3771.
Stock No. 8838-10
- H. Cap Style Sprocket Bolt & Washer Kit fits 1973-1992 Big Twins and 1979-1990 Sportster with cast rear wheel including belt drive and 1993-1998 Big Twins, except 1997-1998 Softail with spoke rear wheel. Replaces OEM P/N 3769, 3771.
Stock No. 8839-10
- I. Sprocket Bolt & Washer Kit fits 1973-1992 Big Twins and 1979-1990 Sportster with cast rear wheel including belt drive and 1993-1998 Big Twins, except 1997-1998 Softail with spoke rear wheel. Replaces OEM P/N 3769, 3771. 7/16-14 x 1-1/2
Stock No. 8835-10 Polished Allen Bolts
Stock No. 2277-10 12 Point Bolts
- J. Rear Sprocket Bolt, Nut & Washer Kit. Special domed hex bolts, locknuts and washers fit 1979-1990 Sportster and 1973-1998 Big Twins, except 1997-1998 Softail, with spoke rear wheel.
Stock No. 9609-15 7/16-14 x 1-1/2
- K. Rear Sprocket Bolt & Washer Kit. Special domed hex bolts and washers fit 1979-1990 Sportster and 1973-1992 Big Twins with cast rear wheel. 7/16-14 x 1-1/2
Stock No. 9608-10
- L. Rear Sprocket Bolt & Washer Kit. Special domed hex bolts & washers fit 1993-1996 all Big Twins, 1997-1998 Dyna and FLT, 1991-1999 Sportster with cast rear wheel. Also fits 1997-1999 Softail, 1999 Dyna, 1999-up FLT, 2000-up Sportster with spoke or cast rear wheel.
Stock No. 2053-10 7/16-14 x 1-3/4
- M. Polished Allen Sprocket Bolt & Washer Kit fits 1993-1996 all Big Twins, 1997-1998 Dyna and FLT with cast rear wheel. Also fits 1997-1999 Softail, 1999 Dyna, 1999-up FLT with spoke or cast rear wheel. Replaces OEM P/N 3730A, 3899.
Stock No. 2054-10 7/16-14 x 1-3/4
- N. Rear Sprocket Bolt & Washer Kit. Special domed hex bolts and washers fit 2000-2006 Softail and 2000-2005 Dyna with spoke or cast rear wheel.
Stock No. 2051-10 7/16-14 x 2-1/4
- O. Polished Allen Sprocket Bolt & Washer Kit fits 2000-2006 Softail and 2000-2005 Dyna with spoke or cast rear wheel. Replaces OEM P/N 3737.
Stock No. 2052-10 7/16-14 x 2-1/4
- P. Polished Allen Sprocket Bolt & Washer Kit fits 2006-up Dyna, 2007-up Softail, with spoke or cast rear wheel. Replaces OEM P/N 3873, 3109.
Stock No. 2340-10 7/16-14 x 2-1/2

Replacement Hardware



Flat Top Alemite Grease Fitting Adaptor

This grease fitting adaptor is designed to be used on alemite grease fitting, OEM 0340. Tapped 1/8 NPT to use with standard grease gun.
Stock No. 9929-1



Grease Fitting/Flat Top Alemite

Exact reproduction brass flat top alemite grease fitting used on pre-1938 Harleys. Many U.S.A. cycle and automotive applications. 6 pieces per kit. H.D. OEM 0340.

Stock No. 8770-6 Nickel Plated
Stock No. 2962-6 Raw Brass

Shift Gate Clamp Nuts

Beautiful reproduction of the 2" hex nuts used to fasten shift gate to tank on 1916-1935 all models and 1936 VL Harley Davidson. OEM 2210-16. Offered in chrome or nickel plating.
Stock No. 8845-2 Nickel Plated
Stock No. 8846-2 Chrome Plated

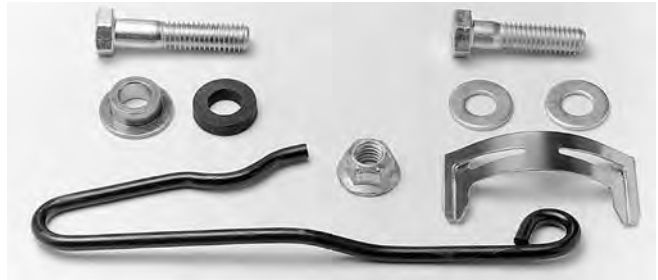

Caliper Anti-Vibration Kit

Designed for use on all 1973-1980 FL, FX rear caliper. OEM 41670-73
Stock No. 8935-9



Rear Caliper Stabilizer Bracket Bolt and Nut Kit

Zinc plated OEM 44040-80 bolt with rubber insert, 7855W nut, bolts and flexlock nuts used on 1980-1985 FLT.
Stock No. 2855-7



Grease Fittings/Zerk Type

5/16-32 Grease fittings used on 1936-1984 Harleys. 6 pieces per kit.

- A. Stock No. 9864-6** Straight, Cad Plated, OEM 9851
- Stock No. 9897-6** Straight, Chrome Plated, OEM 9851
- Stock No. 2794-6** Straight, Parkerized, OEM 9851
- B. Stock No. 2860-6** 67-1/2°, Cad Plated, OEM 9852
- Stock No. 2859-6** 67-1/2°, Chrome Plated, OEM 9852
- Stock No. 2861-6** 67-1/2°, Parkerized, OEM 9852
- C. Stock No. 2857-6** 90°, Cad Plated, OEM 9853
- Stock No. 2856-6** 90°, Chrome Plated, OEM 9853
- Stock No. 2858-6** 90°, Parkerized, OEM 9853

Replacement Hardware



Rear Stand Mounting Hardware

These hardware kits are an accurate reproduction of original Harley fasteners used to mount the rear stand on the following:

Stock No. 8840-10 Parkerized 1930-36 All Side Valve Big Twins, 1926-29 Singles, 1926-35 45's.

Stock No. 2910-6 1936 O.H.V., 1937 all Big Twins.

Stock No. 8841-10 Parkerized, 1936-38 45's.

Stock No. 8015-4 Parkerized 1938-57 All Big Twins, 1939-up 45's (SHOWN)

Stock No. 9616-4 Chrome Plated 1938-57 All Big Twins, 1939-up 45's



Center Stand Mounting Kit

Reproduction of 49404-61 clip, 5905 bushings, and all fasteners used on 1958-1981 FL, FLH with standard or dual exhaust.

Stock No. 2744-10



Front Stand Mounting Kit

Parkerized reproduction of all items needed to mount the front stand on 1931-1948 Big Twins, 1941-1942 Servi-Car, and 1942-1943 WLC.

Stock No. 3086-12



Saddlebag Guard and Support Brackets Mounting Kit

Duplicate of 90818-65 bolts, 6399 rubber washers and all other bolts and washers used on late 1965-1967 FL, FX.

Stock No. 3281-16

Replacement Hardware

Front Brake Caliper Mounting Kit

Chrome plated polished allen bolts and washers mount front brake caliper.

Stock No. 2080-4

2000-2007 FX, FL and XL models, 2002-2005 VRSCA.

Stock No. 2754-12

2008-up all models.



Rear Brake Caliper Mounting Kit

Chrome plated polished allen bolts and washers mount rear brake caliper.

Stock No. 2081-3

2000-2007 FX, FL and XL models, 2002-2005 VRSCA.

Stock No. 2755-4

2008-up Softail and Dyna models.

Front or Rear Caliper Mounting Kit

Chrome plated polished allen bolts and washers mount 1973-1980 rear or 1972-1980 front caliper on all Big Twins. Replaces OEM 44134-72A, 44132-72.

A. Stock No. 2088-8 Chrome Plated Polished Allen

B. Stock No. 3074-8 Zinc Plated, Stock Style



Front Brake Shoe Pivot Stud Kit

Cad plated pivot stud, OEM 44448-48, washer OEM 44454-48 and parkerized flatwasher, lockwasher and nut, OEM 6486, 7055 and 7835, for use on 1949-71 FLH and 1958-72 Servi-Car.

Stock No. 2082-5



Rear Wheel Brake Rod and Cable Adjusting Nut

Reproduction of OEM 42264-52 adjusting nut used on 1952-1978 K, KH, Sportster.

Stock No. 2684-1 Chrome

Stock No. 2685-1 Cadmium



Rear Brake Anchor and Pivot Kit

Accurate reproduction of OEM 41876-54 pivot stud, 41730-52 locating block, 41882-52 nut, used on drum rear brake 1954-1972 K & XL.

Stock No. 9207-4 Chrome Plated

Stock No. 9208-4 Cad Plated



Brake Shaft Nut and Lock Kit

This kit contains 2 special hex size nuts and 2 parkerized locks to prevent loosening of brake cross shaft components. Fits Big Twins 1930-1957.

Stock No. 7820-4 Cad Plated

Stock No. 8409-4 Chrome Plated

Stock No. 9677-4 Parkerized

Brake Shaft Cross Over Bushings

Bronze machined bushings used on 1937-1957 Big Twins. Use Colony's heat treated tool for easy installation.

A. Stock No. 2711-2 Bushings

B. Stock No. 2712-1 Tool

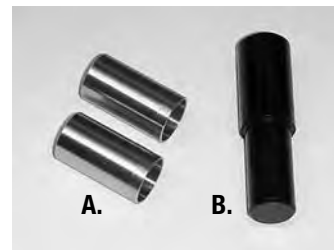

Rear Brake Caliper Anchor Arm Bolt Kit

These stock replacement bolts, nuts, washers and cotter pins fit 1973-83 FL, FX models and are available in chrome or cad plating.

Stock No. 9106-8 Chrome Plated

Stock No. 9107-8 Cad Plated



Rear Brake Caliper Anchor Arm Bolt Kit

Duplicate of OEM 40919-81 bolt used on 1981-1985 Big Twins. Complete with washer and cotter pin.

Stock No. 2564-3 Chrome Plated

Stock No. 2565-3 Zinc Plated



Pivot Bolt, Washer and Spacer

Duplicate of original Harley OEM's 41882-73, 41883-73, 41730-73. Fits 1973-78 XL with rear drum brake.

Stock No. 8936-3 Chrome Plated

Stock No. 8937-3 Cad Plated



Pivot Stud

Cadmium plated duplicate of original OEM 41876-73 stud. Fits 1973-1978 XL with rear drum brake.

Stock No. 2410-1

Replacement Hardware



Rear Brake Shoe Pivot Stud and Cup Assembly

Parkerized duplicates of original Harley parts used on 1938-1957 Big Twins.

Stock No. 2720-6



Brake Shoe Pivot Stud Kit, Front

Parkerized reproduction of OEM 44450-35 stud, washer and nut used on 1935-1951 45's.

Stock No. 2441-3

Brake Shoe Pivot Stud Kit, Rear

Parkerized reproduction of OEM 41876-41 stud, washer and nut used on 1941-1952 45's.

Stock No. 3062-3



Tube, Hose and Cable Straps

Cadmium plated straps used on 1952-1967 clutch booster cable, 1965-1971 FX, FL oil tank feed line hose and 1958-1971 Sidecar brake tube. OEM P/N 9999.

Stock No. 2753-5



Chain Housing Top Screw and Shifter Lever Pivot Screw

Reproduction of OEM 31478-65A screw used on 1965-1984 FL and 1971-1984 FX.

Stock No. 2728-1 Chrome Plated

Stock No. 2727-1 Zinc Plated



Upper Bracket Bolt and Lock Kit

Cadmium plated bolts, 45753-50 and plates, 45752-50 used on 1949-1984 FL models and 1958-1973 Servi-car with adjustable forks.

Stock No. 2185-4



Brake Operating Lever

Parkerized reproduction of OEM 4056-36 lever used on 1936-1957 Big Twins.

Stock No. 3198-1

Replacement Hardware



Front Brake Cable Adjuster
Duplicate of original Harley part.
One or two locknuts included
depending on application.

- Stock No. 9740-2** All H.D. 1928-1940, Chrome Plated.
Made to fit OEM Harley .240 OD cables.
- Stock No. 8938-2** All H.D. 1928-1940, Cad Plated.
Made to fit OEM Harley .240 OD cables.
- Stock No. 9683-2** All H.D. 1928-1940, Parkerized.
Made to fit OEM Harley .240 OD cables.
- Stock No. 9739-2** Big Twins 1941-1948, 1941-1952 45's, Servi-car
1941-1957, Chrome Plated.
- Stock No. 8624-2** Big Twins 1941-1948, 1941-1952 45's, Servi-car
1941-1957, Cad Plated (SHOWN)
- Stock No. 9630-2** Big Twins 1941-1948, 1941-1952 45's, Servi-car
1941-1957, Parkerized
- Stock No. 2883-3** 1949 Big Twins.
- Stock No. 9741-2** Big Twins 1950-1971, Sportster 1952-1972, FX
1971-1972, Chrome Plated
- Stock No. 8818-3** Big Twins 1950-1971, Sportster 1952-1972, FX
1971-1972, Cad Plated
- Stock No. 2802-2** All H.D. 1928-1940, Chrome Plated.
Made to fit aftermarket .230 OD cables.
- Stock No. 2803-2** All H.D. 1928-1940, Cad Plated.
Made to fit aftermarket .230 OD cables.
- Stock No. 2804-2** All H.D. 1928-1940, Parkerized.
Made to fit aftermarket .230 OD cables.

Brake Light Switch Mounting Kit
Correct duplicate of fasteners required to
mount brake light switch on 1939-1957
Big Twins, parkerized. (Machined Plain
Head Bolt.)
Stock No. 2503-4



Control Coil Nuts
Accurate reproduction of
OEM 3343-09 control coil
nuts used on 1909-1930 all
models. 4/Kit.
Stock No. 2459-4
Nickel plated



**Control Coil Adjusting
Sleeve, Brake**
Parkerized sleeves, 3341-28,
used on all models 1928-1936
with throttle controlled oilers.
2/Kit.
Stock No. 2479-2



**Control Coil Adjusting
Sleeve (Lower)**
Parkerized reproduction of
adjuster sleeve OEM 3341-29
and nut 0129. Fits 1929-33 DR,
RL and 1930-36 VL
Stock No. 2478-2



Luggage Carrier Mounting Kit
Duplicate of OEM nuts used to
mount luggage carrier on 1952-
1957 all solo models. Used on
OEM 53403-12 luggage carrier.
Stock No. 2591-12
Chrome plated
Stock No. 2592-12
Cadmium plated



Brake Cable Coupling and Oiler, Cad Plated
Cad plated solid brass coupling is an exact reproduction of the original
Harley design and includes the dust cover. Coupling OEM 4142-30. Fits all
models H.D. 1930-38.
Stock No. 9004-2 Made to fit OEM Harley .240 OD cables.
Stock No. 2820-2 Made to fit aftermarket .230 OD cables.



Brake Arm Anchor Stud Kit
Parkerized reproduction of brake arm anchor stud, OEM 41716-35 and
hardware used on 1935-1952 45's.
Stock No. 2326-3



Rear Brake Rod Clevis Pin Kit
Accurate reproduction of 42269-30 machined pin, 41692-36 wave washer
and other fasteners to mount rear brake rods. Parkerized.
Stock No. 2501-12 1930-1969 Big Twins
Stock No. 2502-12 1935-1952 45's
Stock No. 2537-5 Pins only, 5 pieces



Luggage Carrier Fender Mount Kit
Accurate reproduction of studs, nuts and washers. Parkerized finish.
Stock No. 2347-2 1926-41 DL, RL, WL 45's
Stock No. 2348-2 1942-up WL, WLA, WLC 45's



Luggage Carrier Mounting Kit
Parkerized reproduction of OEM
fasteners used to mount luggage
carrier, OEM P/N 2818-17, on
1930-1953 Big Twins.
Stock No. 2541-19

Replacement Hardware



Brake Caliper Bleeder Screws

Set of bleeder screws used on 1983-2003 Sportster and 1983-2004 Big Twins. Replaces OEM 44048-83.

Stock No. 2600-2 Chrome

Stock No. 2601-2 Zinc



Speedometer Mounting Kit

Cadmium plated screws, nuts and washers used to mount all 1936-up Stewart-Warner speedometers.

Stock No. 2629-4



Front Brake Control Wire Lower Connection Kit

Parkerized exact duplicate of original fasteners used on 1928-1950 45's and 1928-1948 Big Twins.

Stock No. 2593-5



Gear Box Grease Tube and Grease Fitting Kit

Stock No. 2676-2 Cadmium plated OEM 2332-30 tube and nickel plated 0344 grease fitting. Fits 1930-1936 VL.

Stock No. 2678-2 Nickel plated OEM 2332-25 tube and nickel plated 0344 grease fitting. Fits 1925-1929 61" and 74".



Spark Coil and Cover Mounting Kit

Cadmium plated studs, OEM 64611-55 and 64612-55, washers and screws, used on 1955-1966 KH and Sportster.

Stock No. 2656-8



Front Axle Kit

Parkerized reproduction of OEM 3910-30 axle, 3910-37 castle nuts and cotter pins used on 1930-1952 W models and 1934-1940 G models.

Stock No. 2897-5

Front Brake Cable Felt Washer and Packing Nut

Reproduction of 4144-30A nut, 4144-30B felt used on late 1930-1940 Big Twins, 45's, Servi-car, and 1930-1934 Singles.

Stock No. 3299-2

Cad Plated

Stock No. 3324-2

Parkerized



Replacement Hardware



Brake Drum Wheel Mounting Socket Screw Set

Quality reproduction of OEM 4026-35 bolts, hardened and parkerized. Used on all models 1936-1972. Available in standard or oversized. Complete with chip curls at bottom of socket hole, like OEM!
Stock No. 2464-5 Standard 3/8-20 thread
Stock No. 2466-5 Oversized 7/16-20 thread

Wheel Lug Wrench

Accurate reproduction of original factory wrench. A strong, handy tool to remove or replace the brake drum wheel socket screws on all Harley-Davidson models 1936-1972.
Stock No. 2488-1

Brake Shell Dowel Pin Set

Quality reproduction of OEM 41425-37 dowel pins used on 1937-1952 45's and 1937-1972 Big Twins. Set of 5.
Stock No. 2506-5



Front Brake Drum Grease Fitting Extension and Grease Drain

Stock No. 2637-3 1929-1934 Singles, 1932-1940 Servi-cars, and 1929-1952 45 Solo

Stock No. 2641-3 1936-1948 Big Twins and 1941-1957 Servi-cars



Rear Brake Drum Bolt and Nut Kit

Special shouldered bolts and locknuts for your 1952-1978 K, KH, Sportster. 5/16-24 special hex, available in your choice of finish and style. Replaces OEM 3970B.

Stock No. 2800-16 1952-1965 K, KH, XL, 3/4" long, chrome plated with nylock nuts.

Stock No. 2801-16 1952-1965 K, KH, XL, 3/4" long, cadmium plated with flexloc nuts.

Stock No. 3192-16 1952-1965 K, KH, XL, 3/4" long, parkerized bolts and cadmium plated flexloc nuts.

Stock No. 8811-16 1966-1978 XL, 1" long, chrome plated.

Stock No. 8812-16 1966-1978 XL, 1" long, cadmium plated.

Replacement Hardware



Wheel Bearing Locknut Tool

Used to install and remove front and rear wheel bearing locknuts, OEM 41201-55 and 43542-67.

Stock No. 2851-1



Rear Wheel Bearing Locknut and Seal Kit

Correct reproduction of OEM 41201-55 locknut, 41210-55 seal and 41196-55 spacer used on 1955-1978 Sportster.

Stock No. 2825-3 Chrome plated locknut

Stock No. 2826-3 Cadmium plated locknut

Front or Rear Wheel Bearing Locknut and Seal Kit

Correct reproduction of OEM 43542-67 locknut, 41210-55 seal and 41196-55 spacer used on 1967-1972 FL, FLH front or rear, 1971-1972 FX rear, 1967-1979 LE Sidecar and 1967-1972 Servi-car.

Stock No. 2846-3 Chrome plated locknut

Stock No. 2847-3 Cadmium plated locknut



Front Hub Bearing Cone Seal Retainer and Lock Nut Kits

Accurate reproduction of OEM 43633-44 retainer and OEM 43885-30 nut. Fits all 45 Solo 1930-up.

Stock No. 9302-2 Chrome Plated

Stock No. 9303-2 Cad Plated

Stock No. 9743-2 Parkerized



Front Hub Cone Lock Nuts

Nickel plated 3929-21 nuts used on 1921-1929 all JD models.

Stock No. 3163-2



Wheel Hub Outer Cover Screw Kit

OEM 2756 round head screws and 7230 washers used on all pre-1966 Harley models.

Stock No. 8200-10

Chrome

Stock No. 8201-10

Cad

Stock No. 9670-10

Parkerized



Front Wheel Bearing Seal Kit

Reproduction of wheel seals, OEM 43571-35, 43570-35 and wheel bearing cover gasket, OEM 43576-35 used on 1935-1966 W, WL, UL, EL, FL, FLH.

Stock No. 2652-3



Hub Bearing Cone Lockwasher and Oil Seal Kit

Parkerized 43635-30 lockwasher and 43632-44 oil seal used on 1930-up all 45 Solo.

Stock No. 3071-2



Front Hub Cone Lock Nuts

Nickel plated 3929-16 nuts used on 1916-1920 all JD models.

Stock No. 3162-2

Replacement Hardware



Kicker Starter Spring Stud

Quality reproduction of original Harley kicker spring stud.

Stock No. 8119-1 Big Twins 1936-up 4-Speed, Chrome Plated (shown)

Stock No. 8120-1 Big Twins 1936-up 4-Speed, Cad Plated

Stock No. 9717-1 Big Twins 1936-up 4-Speed, Parkerized

Stock No. 2878-3 Big Twins 1936-up 4-Speed, with hole to mount cover, Cad Plated

Stock No. 9754-1 45's 1941-1963, Chrome Plated

Stock No. 9755-1 45's 1941-1963, Cad Plated

Stock No. 9756-1 45's 1941-1963, Parkerized

Stock No. 9898-1 Sportster 1952-1970, Chrome Plated

Stock No. 9899-1 Sportster 1952-1970, Cad Plated

Stock No. 9900-1 Sportster 1971-1978, Chrome Plated

Stock No. 9901-1 Sportster 1971-1978, Cad Plated

Stock No. 9902-1 Sportster 1979, Chrome Plated

Stock No. 9903-1 Sportster 1979, Cad Plated



Kick Starter Tripper Bolt & Nut Kit

Parkerized, heat treated tripper bolt, OEM 33456-26 and slotted nuts, OEM 33458-41 are exact duplicates of original used on 1941-63 Harley Davidson 45.

Stock No. 9761-4



Slotted Nut Driver

Installation tool for kick starter tripper bolt nut, OEM 33458-41.

Stock No. 2525-1



Speedometer Drive Block-off Plug

Available in stock cadmium plated style or chrome plated custom domed style.

Stock No. 2785-2 1952-1956 K, KH, 11/16-18 thread, Chrome Plated.

Stock No. 2919-2 1952-1956 K, KH, 11/16-18 thread, Cadmium Plated.

Stock No. 2057-2 1957-1972 Sportster, 11/16-20 thread, Chrome Plated.

Stock No. 2915-2 1957-1972 Sportster, 11/16-20 thread, Cadmium Plated.



Tachometer Drive Block-Off Plug

Contains 1 chrome plated tachometer drive block-off plug and 1 nylon gasket. Fits Sportster 1971-1984.

Stock No. 7401-2



Housing to Frame Clamp Bolt Kit

Parkerized bolts, OEM 83001-32, nuts and lockwashers mount housing to frame. KIT IS FOR ONE CLAMP ONLY, ORDER 2 KITS FOR BOTH CLAMPS.

Stock No. 2092-12 1932-1941 Servi-Cars

Stock No. 2093-12 1942-1973 Servi-Cars



Rubber Mounting Studs

Rubber Mounts for oil tanks, battery trays and other applications

Replaces OEM 62563-65.

Complete with mounting hardware.

2 per kit.

Stock No. 2333-2



Windshield Trim Mounting Kit

Chrome plated special #12-24 phillips head screws fasten plastic to steel frame on all FL, FX, XL, K windshields 1949-up. Available 2 ways:

Stock No. 9200-33 Chrome screws and chrome acorn nuts.

Stock No. 9201-33 Chrome screws and cad acorn nuts.



Windshield Mounting Bolt Kit

Reproduction of machined plain head bolts, OEM 3996, locks and nuts, used to mount 58000-48 windshield on 1936-1957 all Harley models with spring fork.

Stock No. 3250-12

Timing Cover Oil Passage Bolt

Special oil passage bolt with nylon gasket used on 1963-1969 Big Twin Harley Davidson. OEM 25218-63.

Stock No. 8771-2 Chrome Plated

Stock No. 8772-2 Cad Plated



Replacement Hardware



Custom Shock Mounting Bolt Kit

Complete kit replaces the original zinc plated hardware with beautifully chrome plated dome head bolts for that custom look.

Stock No. 2405-10 2004-up Sportster

Stock No. 2406-10 2000-2003 Sportster



Front Fork Shock Absorber Lower Mount Kit

Parkerized reproduction of all parts required to mount the lower Monroe Shock on 1946-1957 Harley Spring Fork.

Stock No. 3106-18



Lower Shock Mount Bolt and Nut Kit, Custom

Chrome plated custom countersunk washers, flat head allens and lock-nuts mount shocks.

Stock No. 9986-8 1991-2001 Dyna

Stock No. 2881-8 2002-2005 Dyna

Front Fork Shock Absorber Upper Mount Kit

Parkerized reproduction of all parts required to mount the upper Monroe Shock on 1946-1957 Harley Spring Fork.

Stock No. 3107-16



Shock Stud Spacers Kit

Reproduction of OEM 5960W spacers for 1965-1985 FLH when crash bars are not used..

Stock No. 3247-2



Ride Control Side Plate Stud Kit

Parkerized reproduction of studs 13457-36, rubber bushings 13454-33, parkerized washers and nuts used on 1936-1947 WL, FL Springer.

Stock No. 3054-16



Shock Mounting Bolt Kit

Bolts used to mount shocks on 1984-1999 Softail. Replaces OEM 4074 and 6724.

Stock No. 2573-4
Custom dome bolts, chrome

Stock No. 3167-4
Stock style, zinc

Replacement Hardware



Shifter Lever Stud and Bushing Kit

This kit contains all hardware required to mount the shifter lever on 1936-1954 Twins with handshift. A spring steel wave washer is furnished to help prevent rattles.

- Stock No. 7818-5** Cad Plated
- Stock No. 9018-5** Chrome Plated
- Stock No. 9711-5** Parkerized



Shifter Rod End Bolt Kit

Another quality reproduction from Colony. This end bolt will tighten a "sloppy" shifter assembly with the addition of the spring steel wave washer supplied in the kit. Fits Harley Davidson 1936-1954 with handshift, 1951-1964 with footshift.

- Stock No. 7819-4** Cad Plated
- Stock No. 9103-4** Chrome Plated
- Stock No. 9706-4** Parkerized



Shifter Rod End Bolt and Bushing Kit

Cad plated shifter rod end bolt 2225-30, bushing 2226-30, nut and lockwasher used on 1930-1936 VL.

Stock No. 2480-4



Brake and Shifter Shaft Bushings

Reproduction of 47757-52 bushings used on 1952-1978. K, KH, XL, XLH, XLCH Sportster. Set of 2.

Stock No. 3258-2



Clutch Lever Rod Bolt

Reproduction shoulder bolt, nut and lockwasher fit Big Twins 1952-1964. OEM 36921-52.

- Stock No. 9203-3** Chrome Plated
- Stock No. 9204-3** Cad Plated



Shifter Lever Stud Kit

Correctly reproduced studs to mount shift lever on 1936-1946 Twins with handshift.

- A. Stock No. 2581-6** 1936-1937 Twins, Cad Plated
- B. Stock No. 2582-3** 1938-1946 Twins, Parkerized
- C. Stock No. 2865-2** 1916-1936 All models, Gray Nickel

Shifter Rod Clevis Pin Kit

Parkerized duplicate of OEM 33874-41 clevis pin, complete with cotter pin and washer used on 1941-1952 45's.

Stock No. 2647-3



Foot Shifter Lever Bushing

Reproduction of 33638-52 bushing used on 1952-1969 Big Twins.

Stock No. 3087-1



Foot Shifter Lever Bushing

Reproduction of 33638-70 bushing used on 1970-1984 Big Twins.

Stock No. 3088-1



Shifter Shaft Bushings and Seal Kit

Reproduction of 34037-52 bushings and 34035-52 seal used on 1952-1984 K, KH, XL, XLH, XLCH, XLS, XLX.

Stock No. 3257-3

Exhaust Hardware



Exhaust System Mounting Bolt Kit

Fasteners used to mount single exhaust system on 1941-1957 Knucklehead and Panhead.

Stock No. 2719-22 Chrome Plated

Stock No. 2772-22 Parkerized (1038 CP)

Stock No. 3279-22 Parkerized (Machined Plain Head Bolts)



Exhaust System Mounting Bolt Kit

Fasteners used to mount exhaust system on 1932-1973 Harley 45's.

Stock No. 3078-18 Chrome Plated

Stock No. 3077-18 Parkerized (1038 CP)

Stock No. 2216-18 Parkerized (Machined Plain Head Bolts)



Exhaust Port Studs and Nuts

Set of 4 zinc plated studs, OEM 16715-83 and 4 chrome plated flanged nuts. Used on Big Twins 1984-99, Sportster 1986-up and TC88 1999-up.

Stock No. 2188-4



Exhaust Pipe Locking Bolt Mounting Kit

Special bolts complete with lock plates prevent bolts from coming loose. Used on 1966-1984 Shovelhead.

Stock No. 3252-6 Chrome Plated

Stock No. 3254-6 Zinc Plated

Stock No. 3308-6 Black Oxide Plated



High Level Muffler Mounting Stud Kit

Reproduction of 65330-59 stud, washers and nuts used on 1959-1970 XLCH.

Stock No. 3283-6

Air Cleaner Hardware



Carburetor Air Cleaner Connection Mounting Screw Kit

Reproduction of OEM 1409-41M screws used on 1941-1952 WLA, WLC.

Stock No. 2790-4 Cadmium Plated

Stock No. 2791-4 Parkerized

Air Cleaner Cover Mounting Screws

Reproduction Phillips screws, OEM 2402, mount air cleaner cover on 1966-1977 Big Twins and 1956-1977 Sportster.

Stock No. 2324-2 Chrome Plated

Stock No. 2759-2 Cad Plated



Oval Head Screw Kit

5/16-24 x 23/32 Long. Slotted oval head screws to fit various applications such as stock Harley air cleaner and tank shift guide. Replaces OEM 33822-36.

Stock No. 8212-3 Chrome Plated

Stock No. 9710-3 Parkerized



Air Cleaner Cover Mounting Screw Kit

Chrome plated button head screws mount air cleaner cover on all 2004-up Sportster.

Stock No. 2278-2



Air Cleaner Cover Mounting Kits, Custom

Replaces OEM 29269-83, 29283-93 and 6109.

A. Stock No. 9916-2

Chrome Plated

B. Stock No. 9957-2

Chrome Plated

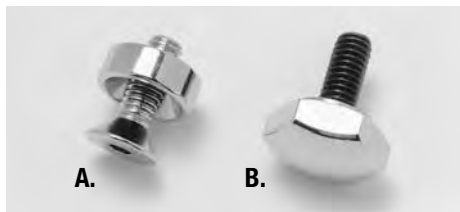

S&S Air Cleaner Cover Mounting Screws

Chrome plated custom button head countersunk allen screws mount cover on S&S air cleaners.

1/4-20x1. 3 screws per kit.

Stock No. 9980-3



Air Cleaner Back Plate Mounting Kit

Correct OEM style fasteners used on 1966-1977 Big Twins.

Stock No. 2323-6



Air Cleaner Backing Plate Rivet Replacement Kit

Rivets and tool to install new rivets on all J-slot air cleaner backing plates.

Stock No. 2666-5



Air Cleaner Mounting Screw and Lock Kit

These hardware kits contain 4 hex head screws and stamped steel locks for the following:

Stock No. 9017-5

1936-55 All Twins-Cad Plated (1 piece lock)

Stock No. 9682-5

1936-55 All Twins-Parkerized (1 piece lock)

Stock No. 7821-6

1956-65 All Twins-Cad Plated (2 piece lock)

The following kits contain locks and screws that are 1/8" longer than stock (1/2" long):

Stock No. 2922-5

1936-55 All Twins-Cad Plated (1 piece lock)

Stock No. 2923-5

1936-55 All Twins-Parkerized (1 piece lock)

Stock No. 2924-6

1956-65 All Twins-Cad Plated (2 piece lock)

Air Cleaner Cover Retaining Screw Kit

Parkerized fasteners used to mount air cleaner cover on 1936-1939 Big Twins and 45's.

Stock No. 2611-8



S&S Air Cleaner Cover Mounting Screws

Chrome plated phillips countersunk screws mount cover on S&S Air Cleaners. 1/4-20x1. 3 screws per kit..

Stock No. 2518-3

Air Cleaner Hardware



Air Cleaner Support Bracket Mounting Stud Kit

Zinc plated 24827-66A stud, screws, washers and nuts used on 1966-1978 XLH, XLCH.
Stock No. 3006-9



Air Cleaner Mounting Lock and Bolt Kit

Zinc plated 29168-83A lock and 3787 bolts used on 1984-1985 FL, FX, XL.
Stock No. 3161-4

Replacement Hardware

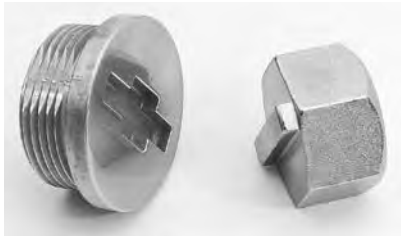

Primary and Clutch Hole Cap Installation Tool
Use of this tool will prevent damage to caps. Used on all except OEM 34742-71.
Stock No. 8862-1



Primary Cap Installation Tool
Use of this tool will prevent damage to OEM 34742-71 cap.
Stock No. 2580-1

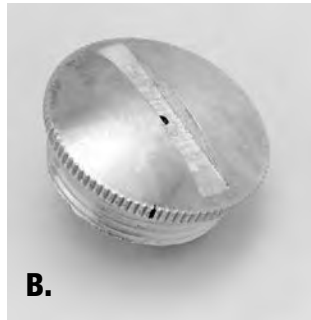
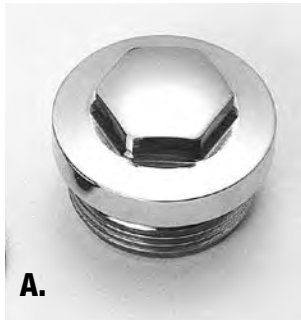

A. Primary Cover Filler Cap and Clutch Hole Cap

Custom chrome plate steel caps have a 15/16 hex to facilitate installation and removal with a standard wrench. Available for:

Stock No. 7600-4 Sportster Filler Cap Breather 1954-1976

Stock No. 7601-2 Sportster Clutch Adjusting Hole Cap 1971-1976

Stock No. 7809-2 Sportster Primary Filler Cap and Clutch Adjusting Hole Cap 1977-1985 (2 required per motor)

Stock No. 8776-2 XLH Primary Filler Cap and Clutch Adjusting Hole Cap 1985-1990 (2 required per motor)

B. Primary Cover Filler Cap

Reproduction of the original aluminum cap, OEM 34742-52A. Fits 1954-1970 Sportster. With vent hole.

Stock No. 2144-1 Aluminum

Stock No. 2145-1 Chrome Plated Steel

C. Clutch Adjusting Hole Cap

Reproduction of the original aluminum cap, OEM 37880-71. Fits 1971-1976 Sportster. No vent hole.

Stock No. 2557-1

D. Primary Cover Filler and Clutch Hole Cap

Reproduction of the original aluminum cap, OEM 34742-86. Fits 1986-1990 Sportster. No vent hole.

Stock No. 2558-1

E. Primary Cover Filler Cap

Reproduction of the original aluminum cap, OEM 34742-71. Fits 1971-1976 Sportster. With vent hole.

Stock No. 2559-1

F. Primary Cover Filler Cap and Clutch Hole Cap

Reproduction of the original aluminum cap, OEM 34742-77B. Fits 1977-1985 Sportster. No vent hole.

Stock No. 2879-1

G. Primary Cover Filler Cap and Clutch Hole Cap

Custom, allen style cap available in chrome plated steel or machined finish billet aluminum.

Stock No. 2930-4 Chrome Plated, Filler Cap Breather 1954-1976 Sportster

Stock No. 2938-4 Billet Aluminum, Filler Cap Breather 1954-1976 Sportster

Stock No. 2932-2 Chrome Plated, Clutch Adjusting Hole Cap 1971-1976 Sportster

Stock No. 2940-2 Billet Aluminum, Clutch Adjusting Hole Cap 1971-1976 Sportster

Stock No. 2934-2 Chrome Plated, Primary Filler Cap and Clutch Adjusting Hole Cap 1977-1985 Sportster (2 required per motor)

Stock No. 2942-2 Billet Aluminum, Primary Filler Cap and Clutch Adjusting Hole Cap 1977-1985 Sportster (2 required per motor)

Stock No. 2936-2 Chrome Plated, Primary Filler Cap and Clutch Adjusting Hole Cap 1985-1990 XLH (2 required per motor)

Stock No. 2944-2 Billet Aluminum, Primary Filler Cap and Clutch Adjusting Hole Cap 1985-1990 XLH (2 required per motor)

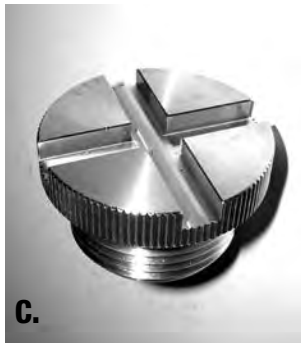

Clutch Hardware



Clutch Arm Rebuilding Kit
 Reproduction bearings, pivot bolts, and locks to rebuild the Harley 45 clutch arm and sprocket cover.

- Stock No. 8903-6** 45 Solo 1941-1943, Servi-Car 1941-1973, Chrome Plated
- Stock No. 8904-6** 45 Solo 1941-1943, Servi-Car 1941-1973, Cad Plated
- Stock No. 9709-6** 45 Solo 1941-1943, Servi-Car 1941-1973, Parkerized
- Stock No. 8410-8** 45 Solo 1944-1952 Chrome
- Stock No. 8411-8** 45 Solo 1944-1952 Cad
- Stock No. 2813-8** 45 Solo 1944-1952 Parkerized



Throwout Bearing Assembly
 Good reproduction of the Harley '45' clutch throwout bearing and pushrod. Fits 1941-1973 Harley '45'.
Stock No. 8412-1

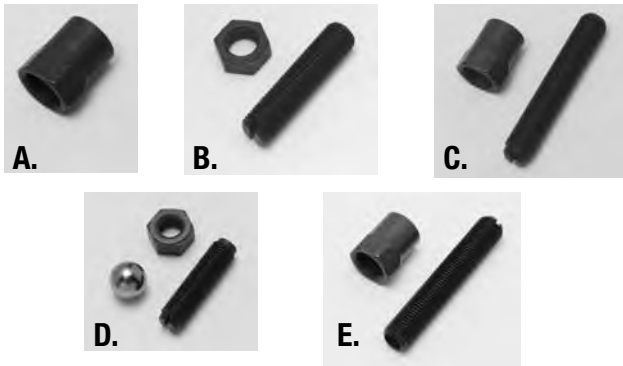

- Clutch Pushrod Adjusters**
 Accurate reproduction of adjuster and locknut, parkerized.
- A. Stock No. 2414-1** Locknut only, OEM 37361-41 used on 1941-1984 Big Twins and 1941-1973 WL, WLA, WLC, Servi-car
 - B. Stock No. 2426-2** Screw 2463-36 and locknut 0129 used on 1936-1940 Big Twins
 - C. Stock No. 2425-2** Screw 37357-41 and locknut 37361-41 used on 1941-1984 Big Twins
 - D. Stock No. 2427-3** Screw 2463-34, locknut 0117 and ball 2464-26 used on 1934-1940
 - E. Stock No. 2424-2** Screw 37358-41 and locknut 37361-41 used on 1941-1973 WL, WLA, WLC, Servi-car



Clutch Push Rod Adjusting Screw, Locknut, and Cover
 Cadmium plated 38130-54 screw, 38135-50 locknet and 37210-47 release worm cover used on 1954-1970 Sportster.
Stock No. 3070-3



Clutch Release Lever Grease Nipple
 Parkerized reproduction of OEM 37067-41 grease nipple used on 1941-1973 45's.
Stock No. 2639-1



Clutch Arm Fulcrum Rebuild Kit
 Reproduction stamping to renew clutch arm to throwout bearing surface. OEM 37052-44. Harley 45's 1941-1973.
Stock No. 8920-3



Clutch Nut and Adjusting Nut Wrench
 Accurate reproduction of original OEM 12746-36 tool used on 1936 61" and 1937-1940 Big Twins.
Stock No. 2555-1



Clutch Puller
 Accurate reproduction of original OEM 12749-36 tool used on 1936 61" and 1937-1940 Big Twins.
Stock No. 2556-1



Clutch Side Nut
 Reproduction of OEM 2275-37 nut used on all 1936-1940 Big Twins except VL.
Stock No. 2933-1



Clutch Tension Adjusting Nut and Lockwasher
 Parkerized clutch tension adjusting nut OEM 2548-36 and lockwasher OEM 2471-36 used on 1936-1940 Big Twins.
Stock No. 2452-2 Stock
Stock No. 2741-2 Undersized threads -.004

Clutch Hardware

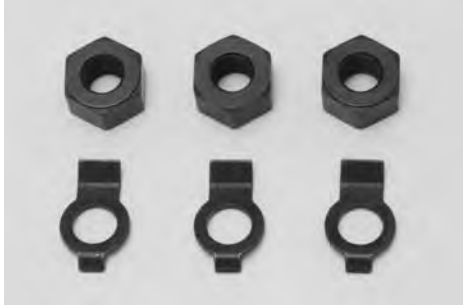

Clutch Spring Guide Stud Nut Locks and Nut Kit

Parkerized nut locks 38110-41 and nuts 7760 used on 1941-1946 Big Twins, 45's and Servi-cars.

Stock No. 2481-6



Clutch Drive Hub Stud Nut Kit

Accurate reproduction of machined 37581-47 nut used on 1947-1984 Big Twins and 1947-1973 45's. Parkerized.

Stock No. 2513-3



Clutch Hub Stud Nut Kit

Duplicate of OEM 37581-52 and 37582-52 nuts used on 1952-1970 K, KH, Sportster.

Stock No. 3075-6



Clutch Release Rod Oil Seal, Retainer and Worm Lever Spring Kit

Reproduction of 37345-52 retainer, 37339-53 seal, and 37222-52 spring used on 1953-1970 K, KH, Sportster.

Stock No. 3301-3

Clutch Hardware



Clutch Hub Nut, Lock and Clutch Gear Oil Seal Kit
 Accurate reproduction of 37525-52 nut, 37533-52A lock, 37531-56B oil seal and 11103 o-ring used on 1956-1966 KH, XL, XLH, XLCH and 1967-1969 XLCH.
Stock No. 2738-4



Clutch Backing Plate Stud Spacer Kit
 OEM style spacers and locknuts used on 1979-Early 1984 Sportster. Available in standard length and undersized.
Stock No. 2756-12 Standard
Stock No. 2765-12 -.040 Undersized
Stock No. 2775-12 -.080 Undersized



Clutch Cable Adjusting Sleeve
 Accurate reproduction of OEM 38654-53 clutch cable adjusting sleeve used on 1953-1956 K-models and 1957-early 1971 Sportster.
Stock No. 2575-1 Chrome plated
Stock No. 2576-1 Cadmium plated

Clutch Booster Bracket U-Bolt
 Duplicate of original 38460-52 U-Bolt used on 1952-1967 FL, FLH. Complete with nuts and washers.
Stock No. 2705-5 Parkerized
Stock No. 2706-5 Chrome



Clutch Hub Nut and Lock Kit
 Reproduction of OEM 37527-67 nut and 37533-52A lock used on 1967-1984 Sportster.
Stock No. 2746-2



Clutch Hub Nut Kit
 Reproduction of clutch hub nut and original seal assembly for 1941-84 Big Twins. Rubber seal included for a positive seal if original look is not needed.
Stock No. 2548-8



Clutch Gear Nut
 Precision machined duplicate of OEM P/N 37460-41, clutch gear nut and OEM P/N 37462-41, lockwasher, fits 45 Solo and Servi-Car 1941-up.
Stock No. 9533-2



Clutch Spring Tension Adjusting Nut
 Parkerized OEM 2548-40 nut used on 1940 WLA.
Stock No. 3018-1

Clutch Dome Cover Retainer Kit
 Reproduction of OEM 34897-53 retainers, screws, and lockwashers used on 1954-1970 KH, XL Sportster.
Stock No. 2928-30



Starter Crank Hardware



Kick Starter Pedal Mounting Kit

Reproduction of bolt 2100-16, bushing 2101-31 and lockspring 2102-30.
Stock No. 2769-4 1917-1941 all models.

Stock No. 2770-4 Machined domed head bolt, parkerized.
 1942-1977 FL, FLH, 1952-1963 Servi-car, 45's.
 1954-1978 Sportster, marked CP 1035, parkerized.

Stock No. 2771-4 1917-up all models, domed head, chrome plated.



Starter Crank Clamp Bolt

Reproduction of OEM 33078-44 bolt manufactured from hardened alloy steel, nut and washer, used on 1944-1952 all W models.

Stock No. 2792-3 Parkerized

Stock No. 2784-3 Chrome plated



Kickstarter and Countershaft Nut and Lock Kit

Nut 7911 and Lock 33082-16 used on 1936-up Big Twins kickstarter shaft and 1936-1979 Big Twins 4-speed countershaft.
Stock No. 2920-2



Starter Crank Clamp Bolt

Parkerized reproduction of OEM 2078-26 bolt manufactured from hardened alloy steel, nut and washer, used on 1929-1943 45's. 1926-1934 Singles, 1932-1959 Servi-car.

Stock No. 2797-3 Parkerized

Stock No. 2798-3 Chrome plated



Starter Crank Clamp Bolt

Accurate reproduction of OEM 4372W, CP 1035 bolt, nut and lockwasher used on 1941-1967 FL, FLH.

Stock No. 2891-3 Parkerized

Stock No. 2892-3 Cadmium plated

Stock No. 2893-3 Chrome plated (plain head, no marking)



Starter Gear Bumper Plate and Screw Kit

Parkerized reproduction of 1864 screws and 33353-36 bracket used on 1936-Early 1978 Big Twins.

Stock No. 3160-3

Starter Crank Hardware



A.



B.

Kick Starter Crank Bushings and Seal Kit

Duplicate of OEM 33288-37 bushings used on 1937-1967 Big Twins. Use Colony's heat treated tool for removal and installation.

A. Stock No. 2762-3 Bushing Kit

B. Stock No. 2764-2 Tool



Kick Starter Pedal Rubber Rod Kit

Reproduction of OEM 33190-17 rods, washers, and nuts used on 1917-up Harley pedals. Set of 2.

A. Stock No. 2956-2 Parkerized

B. Stock No. 2957-2 Cadmium Plated



Kick Starter Shaft Nut and Lock Kit

Reproduction of OEM 7926 nut and 33362-52 lock used on 1952-66 K, KH, XL, XLH and 1967-1979 XLCH.

Stock No. 2723-2



Kick Starter Pedal Rubber Set

Reproduction of OEM 2092-17 rubber used on 1917-up Harley pedals. Set of 2.

A. Stock No. 3021-2

Starter Shaft Nut and Spacer Kit

Replacement for your stock nut and spacer that allows you to use the 1970-up primary cover on your 1965-1969 FL.

Stock No. 2916-2



Kickstarter Crank Pedal Axle Kit

Reproduction of OEM 2095-16 axle, manufactured from hardened alloy steel, axle covers in choice of cadmium or parkerized finish, washers and nut. Used on 1916-1962 all Twins, 45's, K, KH, XL, XLH.

Stock No. 2761-5 Cadmium axle cover

Stock No. 2783-5 Parkerized axle cover.



Starter Clutch to Mainshaft Nut and Lockwasher Kit

Duplicate of 7977 nut and 33396-39 lockwasher used on 1941-1967 FL, FLH.

Stock No. 3099-2

Replacement Hardware

Wheel Puller Tool

Reproduction OEM style wheel puller tool used on 1932-1950 Servi-car.
Stock No. 2644-1



Spoke Nipple Wrench

Duplicate of 12032-x wrench designed to fit spoke nipples on front wheels on all 45" models except if equipped with 16" rims. Does not fit 1941-1947 Servi-car.
Stock No. 3048-1



Spoke Nipple Wrench

Exact reproduction of OEM 12033-39 wrench. Used on all Big Twins, 45" and Servi-cars interchangeable wheels and 45" solo front 16" wheel. (4 flat nipples)–Parkerized.
Stock No. 2693-1



Spoke Nipple Wrench

Same as above, resized larger for use on 1980-up metric spoke nipples–Cadmium.
Stock No. 2662-1



Chain Oiler Adjusting Screw Kit

Parkerized OEM 26383-32 screw and washers used on 1932-Early 1950 All Twins, 1932-1950 Servi-car, 45's. Type1.
Stock No. 3049-7



Clutch Hub Bearing Plate Springs

Cadmium plated springs, OEM 37574-44, used on 1944-1973 45's and 1944-1984 Big Twins. Pack of 3 pieces.
Stock No. 2657-3



Crankcase Oil Strainer Kit

Reproduction of OEM 24975-37 strainer, gasket 24978-57, pin 333 used on 1957-1976 Sportster and 1937-1973 Flatheads. Gasket is used on 1957-up models.
Stock No. 2704-3



Master Cylinder Mounting Kit, Rear.

Zinc plated OEM 42301-87 stud, bolt and washers used to mount master cylinder on all late 1987-1999 Softail.
Stock No. 2638-8



Ignition Module Side Cover Mount Kit

Chrome plated decorative button head allen screws used on 1986-2003 Sportster.
Stock No. 2494-3



Chain Oiler Kit

Cad plated oiler body, 63607-54, oiler adjusting screw, 63610-53, nut and brass washer used on 1954-1962 Panheads.
Stock No. 2321-4

Seat Hardware



Seat Post Rod Lock Nut and Lockwasher

Nut and lockwasher fits all Harley models 1925-81 except FX, XL. Replaces OEM 51674-25 Nut.
Stock No. 8874-2 Cad Plated
Stock No. 9691-2 Parkerized



Seat Bar Bushing Set

Precision machined, heat treated and ground bushings including mounting hardware.

Stock No. 8875-5

Harley Big Twins 1937-64, 45 Solo and Servi-car 1929-1973. Cad Plated (1038 CP)

Stock No. 9676-5

Harley Big Twins 1937-64, 45 Solo 1929-52 and Servi-car 1953 & 54. Parkerized (1038 CP)

Stock No. 8876-5

All Harley 1965-80 except XL, FX. Cad Plated

Seat Clevis Pin and Spring

Nice reproduction of seat pin and spring retainer used on all models Harley Davidson with seat post 1929-up.

Stock No. 8623-2



Seat Bar Clevis Pin

Parkerized duplicate of 3111-12 pin and cotter pin used on all 1912-1933 Harley models.

Stock No. 2731-2



Saddle to Seat Tee Mounting Kit

Accurate reproduction of studs, nuts, seat height adjustment spacers, round head bolt and tapered washers to mount the seat to the tee on all H.D. 1934-80 except FX, XL.

Stock No. 8873-18

Cad Plated

Stock No. 9696-18

Parkerized



Seat Bracket Mounting Kit

Chrome plated button head allen screws and lockwashers mount seat bracket on 87-up Heritage Softail and Fat Boy models. Replaces OEM P/N 868 and 7068.

Stock No. 9915-4



Seat Post Busing Installation Tool

Heat treated tool to install top and bottom seat post busing on 1958-1984 Big Twins complete with installation instructions.

Stock No. 2085-2



Seat Post Bushings

Set of 2 precision machined bronze seat post bushings fit 1958-1984 Big Twins. Replaces OEM 47094-58.

Stock No. 2084-2



Seat Post Bushing Installation Tool

Heat treated, black oxide finish tool to install seat post bushing.

Stock No. 2086-1

1936-1957 Big Twins

Stock No. 2087-1

All 45's and Singles 1929-up, VL 1930-1936



Seat Post Bushing

Accurate reproduction bronze bushing to fit the following Harley Models:

Stock No. 8859-1

All 45's & Singles 1929-up & VL's 1930-36.

Replaces OEM 3113-29.

Stock No. 7708-1

Big Twins 1936-57

Replaces OEM 47583-36.



Seat Tee Pivot Bolt

Quality hardened and ground cad plated reproduction pivot bolt, OEM 3107-25, nut, OEM 0129 & lockwasher fits 1925-36 J, JD, VL.

Stock No. 8928-3

Seat Hardware



Seat Post Rod, Nuts and Spacers Kit

Reproduction of OEM seat post rod, nuts and spacers.

Stock No. 2612-10 1936-1980 Big Twins except FX, VL. (15-7/8" Rod)

Stock No. 2659-10 1930-1936 74" and 80" Big Twins, 1929-1973

45's and Servi-cars (15-7/8" Rod)

Stock No. 2677-10 1936-1980 Big Twins except FX, VL. (16-7/8" Extra Long Rod)

Stock No. 2583-10 All WLA, WLC. (14-3/4" Rod)



Spring Guide Collar Set

Duplicate of OEM 51790-29 (51790-29) collars used for riders 230 lbs and over. Set of 2, Parkerized.

Stock No. 2877-2



Buddy Seat Auxiliary Spring Clip Bolt Kit

Parkerized reproduction of 5674, 5667, 3996 bolts and nuts used on 1936-1969 Big Twins. For one clip set only.

Stock No. 3157-11



Seat Spring Set

Set of upper and lower springs for Harley 45's, VL, and Servi-Car. Does not fit 1942-1943 WLA, WLC with short seat tee.

Stock No. 3080-6

Seat Spring Set

Set of upper and lower springs used on 1936-1957 Rigid Big Twins. Can also be used on 1958-up Swingarm Big Twins using solo seat only.

Stock No. 3081-7 (Shown)

Seat Spring Set

Set of upper and lower springs used on 1958-up Swingarm Big Twins.

Stock No. 3082-7

Springs are color-coded. Complete with location instructions.

Chrome Seat Springs

Chrome plated heavy duty spring steel springs for your custom solo seat. Set of 2.

Stock No. 2981-2 2"

Stock No. 2982-2 3"

Stock No. 2983-2 4"

Stock No. 2984-2 5"



Seat Spring Mounting Kit

Accurate reproduction of 52608-65 shoulder bolt, 52609-65 cupped washer, bolts, nuts and washers used on 1965-1967 FL, FLH.

Stock No. 3312-14



Seat Spring Mounting Kit

Accurate reproduction of 52608-68 shoulder bolt, 52609-65 cupped washer, bolts, nuts and washers used on 1968-1984 FL, FLH.

Stock No. 3277-14



Seat Hardware



Seat Post Retaining Plate Kit
Parkerized OEM 51526-52 plate, CP 1038 bolts and washers used on 1952-1966 K, KH, Sportster.
Stock No. 3200-5



Seat Post Spring Set
Reproduction of OEM 51781-52 upper spring and OEM 51784-52 lower spring used on 1952-1970 K, KH, XL.
Stock No. 3201-4



Saddle Bar to Seat Mounting Kit
Reproduction of 52105-52 spacer, 3956, 4020 bolts and lockwashers in correct cadmium and parkerized plating used on 1952-1970 K, KH, XL, XLH, XLCH.
Stock No. 3256-8



Seat Post Roller and Shaft Kit
Reproduction of OEM 51685-52 roller shaft, 51692-52 roller, 51690-52 spring and 9851 grease fitting used on 1952-1970 K, KH, XL, XLH, XLCH.
Stock No. 3227-4



Seat Post Kit
Reproduction of OEM 51680-52 seat post used on 1952-1970 K, KH, XL, XLH, XLCH. Set of 2.
Stock No. 3234-2



Seat Post Sleeve Bushing Installation and Removal Tool
Tool used to install and remove 51720-52 bushing on 1952-1970 K, KH, XL, XLH, XLCH.
Stock No. 3231-2



Seat Post Bushing Set
Reproduction of bronze OEM 51720-52 bushings used on 1952-1970 K, KH, XL, XLH, and XLCH. 4 pcs/kit.
Stock No. 3226-4



Seat Bar Bolt, Spacer, Bushing Kit
Reproduction of 51950-52 bolt, 51952-52 spacer, 34037-52 bushing, nut, washer and grease fitting used on 1952-1970 K, KH, XL, XLH, XLCH.
Stock No. 3235-6



Seat Post Bushing Sleeve Kit
Reproduction of OEM 51722-52 sleeves with OEM 51720-52 bronze bushings installed used on 1952-1970 K, KH, XL, XLH, and XLCH. Set of 2.
Stock No. 3230-2

Replacement Hardware



Front Crash Bar Mounting Kit

Correct fasteners used to mount crash bar on all 1951-1954 Big Twins.

Stock No. 2630-8 Chrome
Stock No. 2631-8 Cadmium



Front Safety Guard Mounting Kit

OEM style cad plated fasteners used on 1958-1969 FL.

Stock No. 2495-11



Front Safety Guard Mounting Kit

Parkerized spacers 49059-48, bolts 4051, nuts and washers used on 1948-1950 61" and 74" Twins.

Stock No. 2477-10



Front Safety Guard Mounting Kit

Correct reproduction of u-bolts, nuts and washers to mount safety guard.

Stock No. 2203-8 Parkerized, 49064-36 u-bolts, used on 1937-1947 61" 74" and 80", Big Twins and 1955-1957 Panheads.

Stock No. 2204-8 Chrome, 49064-36 u-bolts, used on 1937-1947 61", 74" and 80", Big Twins and 1955-1957 Panheads.

Stock No. 2767-10 Parkerized, 49061-32 u-bolts, used on 1932-1973 45", 1930-1936 VL.

Stock No. 2768-10 Chrome, 49061-32 u-bolts, used on 1932-1973 45", 1930-1936 VL.



Rear Crash Bar Mounting Kit

High quality, guaranteed to fit reproduction of original Harley parts used on all 1936-1957 Big Twins O.H.V. & S.V.

Stock No. 9530-13 Chrome Plated

Stock No. 9531-13 Cad Plated

Stock No. 9532-13 Parkerized

Rear Crash Bar Mounting Kit

Parkerized u-bolts

OEM 49177-38, studs

OEM 49180-36, plate

OEM 66302-29, nuts

and washers used to

mount rear crash bar

on 1938-1952 45"

Solo models.

Stock No. 2682-17



Clutch/Brake Hardware



Clutch Foot Lever Bracket Bushing Installation Tool

This tool will simplify installation or removal of bushings, OEM 36857-36, used on 1936-1978 Big Twins and 1938-1952 45's.

Stock No. 2550-2



Clutch Foot Lever Bracket Bushings

Accurate reproduction of bronze bushings used on 1936-1978 Big Twins and 1938-1952 45's. Set of 2. Replaces OEM 36857-36

Stock No. 2551-2



Foot Clutch Lever Pin Rebuild Kit

Foot clutch lever pin rebuild kit used on 1938-1940 Big Twins and 1938-1952 45's.

Stock No. 2484-3



Foot Clutch Lever Pin Rebuild Kit

Foot clutch lever pin rebuild kit used on 1941-1964 61" and 74" with hand shift.

Stock No. 2482-3



Foot Clutch Lever Pivot Shaft

OEM style shaft, heat treated and ground. Used on OEM 2409-41 lever. Fits 1941-1964 Big Twins.

Stock No. 2350-2



Foot Clutch Lever Pivot Shaft

OEM style shaft, heat treated and ground. Used on 2409-36, 2409-38, 2409-38B, 2409-39 levers. Fits 1941-52 45's and 1936-1940 Big Twins.

Stock No. 2351-2



Foot Brake Lever Stud

OEM style, heat treated and precision ground stud. Fits 1936-1938 Knucklehead. Threaded on both ends, complete with mounting hardware. Can be used on later models for easy installation.

Stock No. 2315-6

Stock Size

Stock No. 2309-6

Oversized to 23/32 for those "sloppy" brake levers. Open up brake levers with 23/32 reamer for a perfect fit, available at your local tool supply company.



Foot Brake Lever Stud

OEM style, heat treated and precision ground stud. Fits 1937-1957 Big Twins and 1939-1973 45's. Complete with mounting hardware.

Stock No. 2316-5

Stock Size

Stock No. 2310-5

Oversized to 23/32 for those "sloppy" brake levers. Open up brake levers with 23/32 reamer for a perfect fit, available at your local tool supply company.



Clutch Foot Lever Mounting Kit

Accurate reproduction of OEM 36903-47 stud used to mount clutch foot lever on all 1947-1973 Servi-cars and WR racing models. Stud is available in standard size and oversized for 11/16" hole.

Stock No. 2654-6

Standard

Stock No. 2669-6

Oversized

Foot Clutch Lever Bracket Spring Stud

Reproduction of OEM 2411-36 spring stud used on 1936-1939 Big Twins.

Stock No. 2544-1



Foot Clutch Lever Bracket Spring Stud

Reproduction of OEM 2411-32 spring stud used on 1932-1936 VL.

Stock No. 2352-1



Foot Clutch Lever Bracket Spring Stud

Reproduction of OEM 2411-40 spring stud used on 1940-1952 45's and 1940-1978 Big Twins.

Stock No. 2353-2



Clutch/Brake Hardware



Foot Clutch Lever Friction Disc, Washers and Nut Kit
Parkerized kit used on 1941-1978 Big Twins.
Stock No. 3059-5



Foot Clutch Lever Friction Disc, Washers and Nut Kit
Parkerized kit used on 1936-1940 Knucklehead, 1938-1952 45 Solo and
1938-1946 Servi-Car.
Stock No. 3060-5

Replacement Hardware



Spacers, Many Applications, 4-Pack

Cadmium plated duplicate of 58102-49 spacers used on 1958-78 FL, FLH muffler support tube, 1962-84 FL, FLH spotlight bracket and MANY OTHER APPLICATIONS!

Stock No. 2973-4



Spacers, 4-Pack

Zinc plated duplicate of 57089-71 spacers used on 1979-1984 FL, FLH muffler, support tube.

Stock No. 3165-4



Spacers, Many Applications, 4-Pack

Cadmium plated duplicate of 90908-58 spacers used on 1969-84 FL, FLH exhaust, 1958-60 FL, FLH, 1966-71 XLH saddlebag carrier and MANY MORE APPLICATIONS!

Stock No. 3007-4

Spacers, Many Applications, 4-Pack

Zinc plated duplicate of 91089-58 spacer used on 1965-1984 FL, FLH transmission cover stud, 1968-Early 1980 FL, FLH front bumper, Late 1961-1984 FL, FLH brake hose plate and MANY MORE APPLICATIONS!

Stock No. 3333-4

Sidecar Hardware



Sidecar Axle Mounting Kit
Parkerized reproduction of original fasteners used on 1933-1965 Sidecars.
Stock No. 2614-7

Sidecar Frame Brace Upper Connection Kit
Parkerized accurately duplicated fasteners used on 1937-1979 Sidecars.
Stock No. 2620-7



Spring to Frame Mounting Kit
Correct parkerized reproductions of 88172-25 U-bolts, 88170-24 shims, washers and nuts used on 1925-1984 M, LE, CLE Sidecars and 1983-1993 TLE Sidecars.
Stock No. 2716-8



Sidecar Spring Bushing Kit
Reproduction of 88174-37 bushings used on 1937-1984 M, LE, CLE Sidecars and 1983-1993 TLE Sidecars.
Stock No. 2766-4



Sidecar Body Support Rods Stud Repair Kit
Complete kit contains studs, bushings, washers and nuts to rebuild your support rods back to factory specs. Used on 1941-1993 models.
Stock No. 2433-18



Lower Front Mount Tie Rod Ball Joint Nut and Lock Nut Kit
Reproduction of OEM 87265-24 nut and 87267-24 locknut. Used on 1924-1984 Sidecars
Stock No. 2691-2



Sidecar Step to Fender Mounting Kit
Parkerized reproduction of original fasteners.
A. Stock No. 2617-3 1936-1940
B. Stock No. 2616-4 1941-1964



Axle Extension Nut Kit
Exact reproduction of fasteners used on 1930-early 1967 Sidecars.
Stock No. 2621-5 Standard length 87438-30 nut
Stock No. 2622-5 Extra long 87438-30 nut



Sidecar Step Mounting Kit
Exact reproduction of original fasteners used on 1940-1964 Sidecars.
Stock No. 2663-7 1940-1946
Stock No. 2661-7 1947-1964



Lower Front Mount Tie Bar Assembly
Parkerized reproduction of fasteners used on 1924-1984 Sidecars.
Stock No. 2692-5



Fender Inner Brace Clip Bracket Mounting Kit
Parkerized reproduction of OEM 88010-36 bracket, bolt, nuts and washers used on 1936-1965 Sidecars.
Stock No. 2615-7



Lower Front Mount Tie Rod Ball Joint
Exact reproduction of ball joint used on 1924-1984 Sidecars. Replaces OEM 87254-34.
Stock No. 2690-1



Sidecar Hardware



Rear Frame Bracket Bolt and Nut Kit

Parkerized reproduction 6036-36 bolts, 6036-36A, 6036-36B nuts and cotter pins used on 1936-1957 Sidecar.

Stock No. 3008-8



Axle, Sidecar

Excellent reproduction of 87433-36 axle used on 1936-early 1976.

Stock No. 3102-1



Windshield Side Member Mount Kit

Parkerized hardware used to mount windshield side member on one side only. Fits 1924-early 1967 Sidecars..

Stock No. 2718-11



Sidecar Frame Rear Mount

Duplicate of 87701-79 u-bolt, washers and locknuts used on 1979-up CLE, TLE, and RLE..

Stock No. 3289-5

VRSC Hardware



Front Axle Nut and Spacers Kit

Chrome plated front axle spacer kit available with custom decorative grooved or smooth spacers. Replaces OEM 43642-01 spacers.

Stock No. 2153-3 Grooved, Fits 2002-2003

Stock No. 2154-3 Smooth, Fits 2002-2003

Stock No. 2812-4 Smooth, Fits 2004-2007



Rear Axle Nut and Spacers Kit

Chrome plated rear axle spacer kit available with custom decorative grooved or smooth spacers. Replaces OEM 43571-01 and 40437-01 spacers.

Stock No. 2155-4 Grooved, Fits 2002-2004

Stock No. 2156-4 Smooth, Fits 2002-2004

Stock No. 2888-4 Smooth, Fits 2005-2007



Shock Absorbers Mounting Kit

Chrome plated spacers, allen screws, washers and nut. Fit 2002-05 VRSCA.

Stock No. 2158-11 Knurled Allen

Stock No. 2158-11-P Polished Allen



Front Brake Rotors Mounting Kit

Custom button head style chrome plated torx screws replace OEM 3762M. Fit 2002-up VRSC *except* VRSCAW, VRSCAWA. Contains 10 pieces.

Stock No. 2157-10



Motor Oil Filler Plug/Dipstick

Custom knurled and decorative chrome plated plug with O-ring replaces OEM 26541-01K.

Fits 2002-up VRSCA.

Stock No. 2160-1



Upper Crankcase Plug and Gasket Kit

Custom knurled and decorative chrome plated plug with gasket replaces OEM 1034M and 6298M.

Fits 2002-up VRSC.

Stock No. 2167-2



Front Axle Covers

Decorative chrome plated covers add a smooth, finished look. Easily installed with set screw. Fit 2002-04 VRSC.

Stock No. 2161-2



Rear Axle Covers

Decorative chrome plated covers add a smooth, finished look. Easily installed with set screw. Fit 2002-04 VRSC.

Stock No. 2163-2

Description	Knurled Stock No.	Polished Stock No.
Complete Motor Allen Show Bike Kit 2002-2006	1021	1021-P
Complete Motor Allen Show Bike Kit 2007-Up	1027	1027-P
Alternator Cover and Derby Cover Mounting Kit	2172-15	2172-16-P
Brake Caliper Mounting Kit, Front	2080-4	
Brake Caliper Mounting Kit, Rear	2081-3	
Cam Cover Mounting Kit	2168-22	2168-22-P
Clutch Cover and Secondary Clutch Actuator Cover Mounting Kit to 2005	2171-17	2171-17-P
Footrest and Gear Shifter Mounting Kit	2177-8	2177-8-P
Frame Assembly Kit	2176-8	2176-8-P
Fender Mounting Kit, Front	2174-8 (Button Allen)	
Headlight Mounting Kit	2178-4	2178-4-P
Handlebar Lever Mount and Master Cylinder Cover Mounting Kit to 2005	2180-12 (Button Allen)	
Handlebar Lever and Master Cylinder Cover Mount Kit 2006-up	2553-10 (Button Allen)	
Oil Pan Mounting Kit	2169-15	2169-15-P
Sprocket Cover Mounting Kit—to 2006	2173-3	2173-3-P
Sprocket Cover Mounting Kit—2007-Up	3090-3	3090-3-P
Upper and Lower Front Fork Bracket Mounting Kit	2175-4	2175-4-P
Water Pump Cover and Thermostat Housing Mounting Kit	2170-9	2170-9-P
Windshield Mounting Kit	2179-7	2179-7-P

Complete Motor Kit and Individual Kits for 2002-Up VRSCA Models



Colony T-Shirts



Sizes available: Men's S,M,L,XL, 2XL, and 3XL

\$12.99 each

Colony

OEM and Custom
Hardware

where
excellence
is a standard

MADE
IN THE
U.S.A.

|| OEM Restoration Quality and Custom Hardware ||

Side Valve | Flathead | Knucklehead
WLA | Servi-Car | Panhead
Shovelhead | Evolution | Twin Cam

Over 50 years of excellent service, top quality, and a large selection make Colony the first choice for custom motorcycle builders and restorers around the world.

Buy With Confidence • Buy COLONY • Because We Care

330.225.3410 phone
800.321.3412 toll free
330.225.9412 fax

www.colonymachine.com
info@colonymachine.com