

PFAFF

PFAFF-INDUSTRIAL@ddition.de

Deutsch

English

Français

Español



PFAFF

Nähen

Sewing
Couture
Costura

1

Zuschneiden

Cutting
La coupe
Corte

2

Messen und markieren

Measuring and Marking
Mesures et Marques
Medir y marcar

3

Nachbearbeitung

Postprocessing
Retouches
Repaso

4

Verbrauchsmaterialien und Werkzeuge

Consumption Items and Tools
Materiel de consommation et Outillage
Material de consumo y herramientas

5

Nadeln

Needles
Aiguilles
Agujas

6

Verschleißteile

High mortality parts
Pièces d'usures
Piezas de desgaste

7

Greifer, Spulenkapseln und Spulen

Hooks, Loopers, Bobbin Cases and Bobbins
Crochets, boîte à canettes et canettes
Garfios, cápsulas de bobina y bobinas

8

Formulare

Forms
Formulaire
Formularios

9

Index

Index
Indice
Indice

10

Sehr geehrte Kundin,
sehr geehrter Kunde

wir freuen uns Ihnen den neuen PFAFF-industrial@ddition Katalog zu übergeben.

In diesem Katalog finden Sie ein ausgewähltes Sortiment an Nähmaschinenersatzteilen zu den weltweit gängigsten Nähmaschinen-Typen.

Die Fertigung der von uns angebotenen Ersatzteile erfolgt durch renommierte Hersteller, die sich auf die Produktion fabrikatsübergreifender Teile spezialisiert haben. Zudem bieten wir auch Pfaff-Original-Teile zu den gängigsten Pfaff-Maschinen an. (Verschleißteile-Listen).

Darüber hinaus bieten wir eine Vielzahl von Artikel rund ums Nähen an. Sie haben somit die Möglichkeit in einer einzigen Bestellung eine Reihe von Bedarfen in Ihrem Betrieb decken zu können. Ein Bestellformular finden Sie in Kapitel 9.0. Verwenden Sie es bitte als Kopiervorlage.









Über das gesamte Artikelspektrum unseres Kataloges, bei Ersatzteilen, Nadeln oder Zubehör-Artikeln, haben wir unser besonderes Augenmerk auf die Auswahl kompetenter Lieferanten gelegt, um Ihnen eine gleichbleibende Qualität zu einem attraktiven Preis anbieten zu können.

Einen großen Teil der Artikel haben wir an Lager. Artikel, die nicht ab Lager verfügbar sind, können wir kurzfristig ausliefern.

Wir weisen nochmals ausdrücklich darauf hin, daß es sich bei den im Bereich „Universal- und Zubehörteile“ dargestellten Artikeln nicht um Originalteile der verschiedenen Nähmaschinenhersteller handelt.

Wenn Sie uns Ihre Anregungen zum PFAFF-industrial@ddition Katalog zusenden wollen, bitten wir Sie das Formular zu verwenden, das Sie in Kapitel 9.1 finden. Wir freuen uns darauf Ihre Meinung zu erfahren.

Ihr PFAFF-Industrial Team

Universal- u. Zubehörteile		<p>1: Nähen</p> <p>1.0 Symbolerläuterungen</p> <p>1.1 Nähwerkzeuge für Einnadelmaschinen mit Untertransport</p> <p>1.2 Nähwerkzeuge für Einnadelmaschinen mit Nadeltransport</p> <p>1.3 Nähwerkzeuge für Zweinadel-Stepstichmaschinen</p> <p>1.4 Umlauf- und CB-Greifer, Ringschiffchen, Spulenkapseln und Spulen</p> <p>1.5 Fabrikatsspezifische Nähwerkzeuge und Ersatzteile</p> <p>1.6 Verschleißteile für PEGASUS Kettenstichmaschinen</p> <p>1.7 Verschleißteile für MAUSER-SPEZIAL Kettenstichmaschinen</p> <p>1.8 Apparate und Apparatehalterungen</p> <p>1.9 Cutter und Absaugungen</p> <p>1.10 Kantenführungen</p> <p>1.11 Bandabzugsgeräte und Puller</p> <p>1.12 Leuchten und Zubehör</p> <p>1.13 Motore und Zubehör</p> <p>1.14 Nähtische und Zubehör</p> <p>1.15 Haushaltsnähmaschinenbedarf</p> <p>1.16 Nähzubehör</p>
		<p>2: Zuschneiden</p> <p>2.0 Symbolerläuterungen</p> <p>2.1 Messer und Schleifsteine für Cutter</p> <p>2.2 Messer und Schleifsteine für Kreismessermaschinen</p> <p>2.3 Messer und Schleifmittel für Stoßmessermaschinen</p> <p>2.4 Messer und Schleifsteine für Bandmessermaschinen</p> <p>2.5 Ersatzteile für Zuschneidemaschinen</p> <p>2.6 Stoffklammern und sonstige Hilfsmittel</p> <p>2.7 Scheren und Trennmesser</p>
		<p>3: Messen und markieren</p> <p>3.0 Symbolerläuterungen</p> <p>3.1 Bohrmarkiernadeln, Kerbschnitt- und Lochzangen</p> <p>3.2 Lupen, Stückzähler, Maßbänder und Lineale</p> <p>3.3 Kreide und Markierstifte</p> <p>3.4 Heißsiegelbügelleisen, Rockabrunder und Schneiderbüsten</p> <p>3.5 Markier-, Sicherheits- und Stecknadeln</p>
		<p>4: Nachbearbeitung</p> <p>4.0 Symbolerläuterungen</p> <p>4.1 Wendegeräte</p> <p>4.2 Fadenschergeräte und Zubehör</p> <p>4.3 Bügelbedarf</p> <p>4.4 Etikettieren</p> <p>4.5 Atelierausstattung</p>
		<p>5: Verbrauchsmaterialien und Werkzeuge</p> <p>5.0 Symbolerläuterungen</p> <p>5.1 Öle und Sprays</p> <p>5.2 Teflonprodukte</p> <p>5.3 Schleifmittel und Werkzeuge</p>
Nadeln		<p>6: Nadeln</p> <p>6.0 Nadeln zur Lederverarbeitung</p> <p>6.1 Nadeln zur Textilverarbeitung</p>
PFAFF Originalteile		<p>7: Verschleißteile</p> <p>7.0 PFAFF Stepstichmaschinen</p> <p>7.1 PFAFF Schweißmaschinen</p>
		<p>8: Greifer, Spulenkapseln und Spulen</p> <p>8.0 Greifer, Spulenkapseln und Spulen geordnet nach PFAFF-Maschinenklassen</p> <p>8.1 Schiffchen und Greiferarten</p>
Anhang		<p>9: Formulare</p> <p>9.0 Bestellformular</p> <p>9.1 Ihre Anregungen</p> <p>10: Index</p>

Dear Customers,

We are pleased to deliver to you the new PFAFF-industrial@ddition catalogue.

In this catalogue you will find a selected assortment of sewing machine spare parts for the most popular sewing machines models worldwide.

The spare parts we are offering are produced by highly reputed manufacturers, who have specialised in the production of single parts for various brands. In addition we are also offering original Pfaff parts for the most common Pfaff machines (wearing parts lists).

Furthermore we are offering several articles connected with sewing work, which gives you the possibility of satisfying a number of requirements in your company with one single order. You will find an order form to copy in Chapter 9.0.









To be able to offer you constant quality at an attractive price, we paid special attention to the selection of competent suppliers for the entire range of articles in our catalogue, for spare parts, needles or other accessories.

We have most of the articles on stock and can deliver those articles, which are not on stock, at short notice.

We should like to expressly point out once again that the articles described in the sector "Universal parts and accessories" are not original parts from the various sewing machine manufacturers.

If you would like to send us your comments and suggestions about the PFAFF-industrial@ddition catalogue, please use the form in Chapter 9.1. We look forward to hearing your opinion.

Your PFAFF- Industrial Team

Universal Parts And Accessories		<p>1: Sewing</p> <p>1.0 Symbol Descriptions</p> <p>1.1 Sewing Parts for Single-Needle machines with bottom feed</p> <p>1.2 Sewing Parts for Single-Needle machines with needle feed</p> <p>1.3 Sewing Parts for Double-Needle Lockstitch machines</p> <p>1.4 Rotary Hooks, CB-Shuttles, Beak Shuttles, Bobbin Cases and Bobbins</p> <p>1.5 Brand depending sewing and spare parts</p> <p>1.6 High Mortality Parts for PEGASUS chainstitch machines</p> <p>1.7 High Mortality Parts for MAUSER-SPEZIAL chainstitch machines</p> <p>1.8 Attachments and Attachments Brackets</p> <p>1.9 Cutter and Vacuum Devices</p> <p>1.10 Edge Guides</p> <p>1.11 Metering Devices and Puller</p> <p>1.12 Sewing Lamps and accessories</p> <p>1.13 Motors and accessories</p> <p>1.14 Table Tops and accessories</p> <p>1.15 Parts for domestic machines</p> <p>1.16 Sewing accessories</p>
		<p>2: Cutting</p> <p>2.0 Symbol Descriptions</p> <p>2.1 Knives and Sharpening Stones for Cutter</p> <p>2.2 Knives and Sharpening Stones for Circular Knife Cutting machines</p> <p>2.3 Knives and Sharpening Stones for Straight Knife Cutting machines</p> <p>2.4 Knives and Sharpening Stones for Band Knife Cutting machines</p> <p>2.5 Spare parts for Cutting Machines</p> <p>2.6 Cloth Clamps and other aids</p> <p>2.7 Scissors, Shears and Cutting knives</p>
		<p>3: Measuring and Marking</p> <p>3.0 Symbol Descriptions</p> <p>3.1 Pins and Punch-Pliers</p> <p>3.2 Magnifier, Counter, Measuring Tapes and Guides</p> <p>3.3 Chalk and Marking Pins</p> <p>3.4 Heat Seal Irons, Skirt Markers and Dummies</p> <p>3.5 Marking and Fixing Pins</p>
		<p>4: Postprocessing</p> <p>4.0 Symbol Descriptions</p> <p>4.1 Turning Devices</p> <p>4.2 Thread Trimmers and accessories</p> <p>4.3 Ironing Equipment</p> <p>4.4 Labeling</p> <p>4.5 Studio Equipment</p>
		<p>5: Consumption Items and Tools</p> <p>5.0 Symbol Descriptions</p> <p>5.1 Oils and Sprays</p> <p>5.2 Teflon- Products</p> <p>5.3 Grinding Material and Tools</p>
Needles		<p>6: Needles</p> <p>6.0 Needles for stitching leather</p> <p>6.1 Needles for stitching textiles</p>
PFAFF Genuine Parts		<p>7: High mortality parts</p> <p>7.0 PFAFF Lockstitch machines</p> <p>7.1 PFAFF Welding machines</p>
		<p>8: Hooks, Loopers, Bobbin Cases and Bobbins</p> <p>8.0 Hooks, Loopers, Bobbin Cases and Bobbins sorted by PFAFF machine classes</p> <p>8.1 Shuttles and Hook types</p>
Attachment		<p>9: Forms</p> <p>9.0 Order Form</p> <p>9.1 Your Suggestions</p> <p>10: Index</p>

Chère cliente,
cher client

Nous sommes très heureux de vous remettre le nouveau catalogue PFAFF-industrial@ddition.

Ce catalogue propose un assortiment de pièces de rechange pour les machines à coudre des marques les plus connues.

La fabrication des pièces de rechange que nous proposons est confiée à des fabricants renommés et spécialisés dans la production de pièces pour plusieurs marques. Nous fournissons également les pièces d'origine Pfaff pour les principales machines Pfaff (listes de pièces d'usure).

En outre, nous proposons une multitude d'articles de couture. Vous pouvez ainsi, en une seule commande, vous approvisionner pour tous les besoins de votre entreprise. Photocopiez le formulaire de commande se trouvant dans le chapitre 9.0.

Nous avons particulièrement veillé à regrouper un choix de fournisseurs compétents pour toute la gamme d'articles de notre catalogue, pièces de rechange, aiguilles et accessoires, afin de vous offrir une qualité constante à prix attractifs.









La plupart de nos articles sont en stock. Les autres peuvent être livrés sous de brefs délais.

Nous insistons à nouveau sur le fait que les articles de la section « Pièces universelles et accessoires » ne sont pas des pièces d'origine des différents fabricants de machines à coudre.

Le catalogue n'est disponible qu'en allemand et en anglais. Quand c'est possible, nous présentons les articles à l'aide des symboles utilisés dans nos catalogues de salons. Ces symboles sont expliqués en plusieurs langues au début de chaque chapitre principal.

Pour nous faire part de vos suggestions sur le catalogue PFAFF-industrial@ddition, utilisez le formulaire se trouvant au chapitre 9.1. Votre avis nous est précieux !

Votre équipe PFAFF-Industrial

Pièces universelles et accessoires		1: Couture 1.0 Clarification des symboles 1.1 Equipements pour machines à coudre, à une aiguille, et entraînement par griffe 1.2 Equipements pour machines à coudre, à une aiguille, et entraînement par griffe et aiguille 1.3 Equipements pour machines à coudre, double aiguille, point noué 1.4 Crochet rotatif, crochet oscillant, crochet à lunette, boîte à canette et canette 1.5 Equipement et pièce de rechange pour des fabricants spécifique 1.6 Pièces d'usures pour machines à point chaînette PEGASUS 1.7 Pièces d'usures pour machines à point chaînette MAUSER-SPEZIAL 1.8 Guides et supports de guides 1.9 Coupeuse et aspiration dechette 1.10 Guides bord 1.11 Distributeur de bande et puller 1.12 Lampes et accessoires 1.13 Moteurs et accessoires 1.14 Tables et accessoires 1.15 Accessoires pour machines domestiques 1.16 Accessoires couture
		2: La coupe 2.0 Clarification des symboles 2.1 Couteaux et pierres d'affûtage pour coupeuse 2.2 Lame, et pierre d'affûtage pour coupeuse à lame rotative 2.3 Lame, et pierre d'affûtage pour coupeuse à lame verticale 2.4 Lame, et pierre d'affûtage pour scie à ruban 2.5 Pièces détachées pour matériel de coupe 2.6 Pincés tissus et divers remèdes d'utilisation 2.7 Ciseau et cutter
		3: Mesures et Marques 3.0 Clarification des symboles 3.1 Aiguilles pour perceuse de marquage, cranteurs et pincés de perçages 3.2 Loupes, mopteur pièces, mesures et réglettes 3.3 Craie et marqueurs 3.4 Fer pour impression à chaud, arrondisseur de jupe, mannequin 3.5 Aiguilles à marquer, aiguille de sécurité, et épingles à nourrice
		4: Retouches 4.0 Clarification des symboles 4.1 Appareil à retourner 4.2 Raseuse de fils et accessoires 4.3 Accessoires de repassage 4.4 Appareil d'étiquetage 4.5 Fournitures d'atelier
		5: Matériel de consommation et Outillage 5.0 Clarification des symboles 5.1 Huile et spray 5.2 Produits téflon 5.3 Produit d'affûtage et outils
Aiguilles		6: Aiguilles 6.0 Aiguilles pour travaux de cuir 6.1 Aiguilles pour travaux textile
PFAFF Pièces d'origine		7: Pièces d'usures 7.0 Machines à point noué PFAFF 7.1 Machines à souder PFAFF
		8: Crochets, boîte à canettes et canettes 8.0 Crochets, boîte à canettes et canettes dans l'ordre des classes des machines PFAFF 8.1 Navette et sortes de crochets
Annexe		9: Formulaires 9.0 Formulaire de commande par fax 9.1 Vos suppositions
		10: Indice

Distinguida cliente,
Distinguido cliente

Nos complace poder entregarles el nuevo catálogo PFAFF-industrial@ddition.

En este catálogo encontrarán un surtido selecto de repuestos para los tipos de máquinas de coser más corrientes mundialmente.

Los repuestos ofrecidos por nosotros son elaborados por fabricantes renombrados, los cuales también se han especializado en la producción de piezas para incorporar en otros productos. Además de eso, nosotros ofrecemos también piezas originales Pfaff para las máquinas Pfaff más corrientes (listas de piezas de desgaste).

Aparte de eso, ofrecemos también un gran número de productos en torno a la costura. De esa forma, con un sólo pedido usted tiene la posibilidad de poder cubrir una serie de necesidades en su empresa. En el capítulo 9.0 encontrará un formulario de pedidos, del cual deberá hacer una copia cada vez que haga un pedido.

A través de la totalidad de la gama de artículos, ya sean piezas de recambio, agujas o accesorios, hemos fijado la atención especialmente en la selección de proveedores competentes, para poder ofrecerles una calidad siempre igual a un precio atractivo.

La mayoría de los artículos los tenemos en almacén. Los que no estén disponibles en almacén podemos suministrarlos en breve plazo.









Hacemos observar de nuevo de forma expresa que los artículos representados en el sector "piezas universales y accesorios" no son piezas originales de los diferentes fabricantes de máquinas de coser.

Como pueden comprobar, el contenido del catálogo sólo se ha redactado en los idiomas alemán e inglés. En aquellos casos en los que ha sido posible, hemos hecho una aclaración al artículo en cuestión partiendo de símbolos, de la misma forma que ustedes ya lo conocen de nuestros catálogos de ferias. Una aclaración a esos símbolos en varias lenguas la encontrará al comienzo de cada capítulo principal.

Si fueran tan amables de enviarnos su sugerencias sobre el catálogo PFAFF-industrial@ddition, sírvanse utilizar el formulario que se halla en el capítulo 9.1. Será un placer para nosotros poder recibir sus opiniones al respecto.

Muy atentamente

su PFAFF- Industrial-Team

Piezas universales y accesorios		<p>1: Costura</p> <p>1.0 Explicación de los signos</p> <p>1.1 Órganos de costura para máquinas de una aguja con arrastre inferior</p> <p>1.2 Órganos de costura para máquinas de una aguja con arrastre por aguja acompañante</p> <p>1.3 Órganos de costura para máquinas de pespunte de dos agujas</p> <p>1.4 Garfios rotatorios, garfios de bobina central, garfios oscilante, cápsulas de bobina y bobinas</p> <p>1.5 Órganos de costura y repuestos específico a la marca</p> <p>1.6 Piezas de desgaste paramáquinas de punto cadeneta, marca PEGASUS</p> <p>1.7 Piezas de desgaste paramáquinas de punto cadeneta, marca MAUSER-SPEZIAL</p> <p>1.8 Aparatos y soportes de aparatos</p> <p>1.9 „Cutter“ y Aspiradores</p> <p>1.10 Guías para cantos</p> <p>1.11 Aparatos distribuidor de cinta y „Puller“</p> <p>1.12 Lámparas y accesorios</p> <p>1.13 Motores y accesorios</p> <p>1.14 Mesas de costura (bancadas) y accesorios</p> <p>1.15 Artículos para máquinas de coser domesticas</p> <p>1.16 Accesorios de costura</p>
		<p>2: Corte</p> <p>2.0 Explicación de los signos</p> <p>2.1 Cuchillas y piedras de afilar para „Cutter“</p> <p>2.2 Cuchillas y piedras de afilar para máquinas de cortar por cuchilla circular</p> <p>2.3 Cuchillas y piedras de afilar para máquinas de cortar por cuchilla de impacto</p> <p>2.4 Cuchillas y piedras de afilar para máquinas de cortar por cuchilla de cinta</p> <p>2.5 Repuestos para máquinas de corte</p> <p>2.6 Pinzas sujetatelas y otros medios auxiliares</p> <p>2.7 Tijeras y cuchillas de corte</p>
		<p>3: Medir y marcar</p> <p>3.0 Explicación de los signos</p> <p>3.1 Agujas para marcar por perforación, tijeras de estriado y de calado</p> <p>3.2 Lupas, cuentapiezas, cintas metricas y guías</p> <p>3.3 Tiza y lapices de marcar</p> <p>3.4 Plancha de sellar a calor, aparato marcador del bajo de la falda y maniquí de sastre</p> <p>3.5 Agujas de marcar, agujas de seguridad y alfileres</p>
		<p>4: Repaso</p> <p>4.0 Explicación de los signos</p> <p>4.1 Dispositivos de volver</p> <p>4.2 Dispositivos de tijeras para hilos y accesorios</p> <p>4.3 Auxiliares de planchado</p> <p>4.4 Etiquetado</p> <p>4.5 Equipo de la sala de costura</p>
		<p>5: Material de consumo y herramientas</p> <p>5.0 Explicación de los signos</p> <p>5.1 Lubrificantes y sprays</p> <p>5.2 Productos de teflon</p> <p>5.3 Abrasivos y herramientas</p>
Agujas		<p>6: Agujas</p> <p>6.0 Agujas para trabajos en cuera</p> <p>6.1 Agujas para tela</p>
PFAFF Piezas originales		<p>7: Piezas de desgaste</p> <p>7.0 Máquinas de pespunte, marca PFAFF</p> <p>7.1 Máquinas de soldar, marca PFAFF</p>
		<p>8: Garfios, cápsulas de bobina y bobinas</p> <p>8.0 Garfios, cápsulas de bobina y bobinas ordenados según clases de máquinas PFAFF</p> <p>8.1 Lanzaderas y tipos de garfios</p>
Anexo		<p>9: Formularios</p> <p>9.0 Pedido por formulario Fax</p> <p>9.1 Vuestra sugerencias</p> <p>10: Indice</p>

1: NÄHEN *SEWING*

1.0 SYMBOLERLÄUTERUNGEN *SYMBOL DESCRIPTIONS*

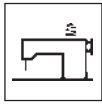
Symbolerklärungen
Symbol Descriptions
Clarification des symboles
Explicación de los signos

Einnadel-Flachbett-Nähmaschine
Single needle flatbed sewing machine
 Machine à coudre à plateau à 1 aiguille
 Máquina de coser de base plana de una aguja



Zweinnadel-Flachbett-Nähmaschine
Double needle flatbed sewing machine
 Machine à coudre à plateau à 2 aiguilles
 Máquina de coser de base plana de dos agujas



Viernadel-Flachbett-Nähmaschine
Four needle flatbed sewing machine
 Machine à coudre à plateau à 4 aiguilles
 Máquina de coser de base plana de cuatro agujas

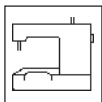

Kettenstichmaschine mit Untertransport
Chainstitch machines with bottom feed
 Piqueuse à point chaînette avec entraînement par griffe
 Máquina de punta cadeneta con transporte inferior

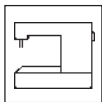

Kettenstichmaschine mit geschlossenem Flachbett
Chainstitch machine with closed flatbed
 Piqueuse à point chaînette avec plateau fermé
 Máquina de punta cadeneta con base plana cerrada

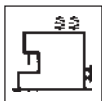

Block-Nähmaschine
Monobloc sewing machine
 Machine à coudre monobloc
 Máquina de coser monobloque



Freiarmmaschine
Cylinderbed sewing machine
 Machine à coudre à bras libre
 Máquina de coser de brazo al aire

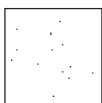

Armabwärtsmaschine
Feed-off the arm machine
 Machine à bras-deporté
 Máquina de brazo acodado



Blindstichmaschine
Blindstitch machine
 Machine à point invisible
 Máquina de puntada invisible

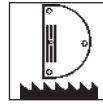

Standard Nähwerkzeuge
Standard sewing parts
 Pièces de rechange en standard
 Organos de costura estandar

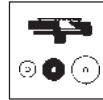

Vertikalgreifer
Vertical hook
 Crochet sur arbre vertical
 Garfio sobre eje vertical

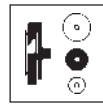

Horizontalgreifer
Horizontal hook
 Crochet sur arbre horizontal
 Garfio sobre eje horizontal



Kettenstichgreifer
Looper
 Boucleur
 Garfio para punta cadeneta



CB-Greifer
CB-Shuttle
 Navette centrale
 Garfio de bobina central



Ringschiffchen
Beak shuttle
 Navette oscillante
 Garfio oscilante



Spulenkapsel
Bobbin case
 Boîte à canette
 Càpsula de bobina



Spule
Bobbin
 Canette
 Bobina



Nähfuß mit Fingerschutz
Sewing Foot with Finger Guard
 Pied avec garde-doigts
 Pie prensatelas con guarda dedos

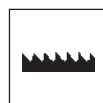

Untertransport
Bottom feed
 Entraînement par griffe
 Arrastre inferior normal

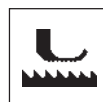

Ober- und Untertransport
Upper and bottom feed
 Entraînement par griffe et pied
 Arrastre inferior y superior

Symbolerklärungen
Symbol Descriptions

Clarification des symboles
Explicación de los signos



Unter- und Nadeltransport
Compound feed
 Entraînement par griffe et aiguille
Arrastre inferior y por aguja acompañante



Dreifachtransport
Unison feed
 Entraînement par griffe, pieds et aiguille
Arrastre inferior, superior y aguja acompañante



Rollfuß (angetrieben)
Roller presser (driven)
 Pied à roulette (entraînée)
Pie rodante (accionado)

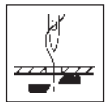

Fadenabschneider
Thread trimmer
 Coupe-fil
Cortahilos automático



Kantenbeschneider
Edge trimmer
 Couteau raseur
Recordador de bordes

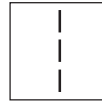

Gerad-Stich
Straight Stitch
 Point-droite
Punta recto

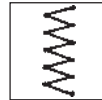

Zick-Zack-Stich
Zig-Zag Stitch
 Point zig-zag
Puntada zigzag

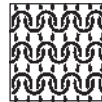

Strickware
Knitted material
 Tricotage
Géneros de punta



Reißverschluss
Zipper
 Fermeture à glissière
Cremallera

1: NÄHEN *SEWING*

1.1 NÄHWERKZEUGE FÜR EINNADEL- MASCHINEN MIT UNTERTRANSPORT *SEWING PARTS FOR SINGLE-NEEDLE MACHINES WITH DROP FEED*

Einleitung *Introduction*

Die Nähwerkzeuge in diesem Kapitel eignen sich zur Verwendung in sämtlichen Einnadel-Steppstichmaschinen mit Untertransport und standardisierter Nähgarnitur. Nachfolgend finden Sie eine Auswahl der gängigsten Maschinentypen, bei denen die Nähwerkzeuge eingesetzt werden können:

The sewing parts in this chapter are suitable for all single needle lockstitch machines with drop feed and standardized gauge sets. Below please find a selection of the most popular sewing machine types in which the sewing parts can be used:

ADLER

196, 296, 396 ohne FA / *without TC*

ALTIN

8332, 8333 mit Untertransport / *with drop feed*

BROTHER

DB1-B760, DB2-B700-Serie mit Untertransport / *with drop feed*

DÜRKOPP

211 ohne FA / *without TC*, 271

JUKI

DDL-227 - DDL-5550

MITSUBISHI

DB-120, DB-130, DB-189, DB-320

NECCHI

885 ohne FA / *without TC*

PFAFF

463, 563, 953, 1053 ohne FA, *without TC*

SINGER

31, 44, 95, 96, 191, 195K, 196K, 241, 251, 281, 291U, 331K, 366K, 391, 400W, 451K, 491, 591, 600W, 660A mit Untertransport / *with drop feed*

UNION SPECIAL

61200, 61300, 61400, 61900

Gelenkfüße
Hinged Presser Feet



Gelenkpresserfuß, rechte Zehe verkürzt
Hinged Presser Foot, right toe shorter

Sohlenlänge <i>sole length</i>	Sohlenbreite in mm <i>Sole Width in mm</i>	Artikelnummer <i>Part No.</i> Standard	Artikelnummer <i>Part No.</i> SUISEI
standard	9,0	BA-1152F	
lang/long	10,0	B51742F	
standard	11,0	BB1524012OBOF	BA-1150AFs
lang/long	12,0	B211-9797F	
standard	13,0	BA-1155aF	
standard	14,0	BA-1156F	
lang/long	14,0	BD-4354F	

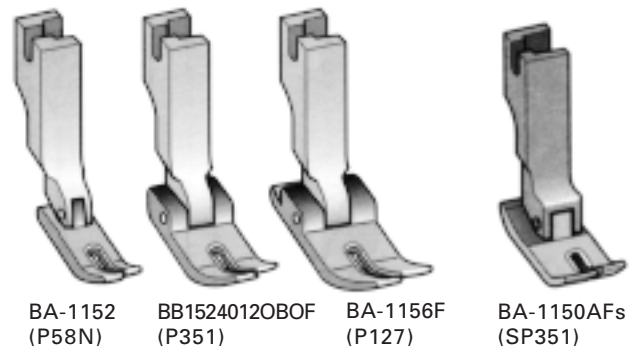

Gelenkpresserfuß, rechte Zehe verkürzt
Hinged Presser Foot, right toe shorter



Bemerkungen <i>Remarks</i>	Sohlenbreite <i>sole width</i>	Artikelnummer <i>Part No.</i>
für feine Materialien und Strickwaren <i>for fine fabrics and knitted materials</i>	11,0	BA-1151F



BA-1151F (P351K)



Verhindert hochziehen feiner Stoffe durch die Nadel.

Lifting of fine fabric with the needle is prevented.

GelenkfüÙe Hinged Presser Feet



Gelenkpresserfuß mit gleichlangen Zehen
Hinged Presser Foot, double toe even

Sohlenbreite in mm Sole Width in mm	Artikelnummer Part No.
8,0	BA-1157F
10,0	BA-1157AF

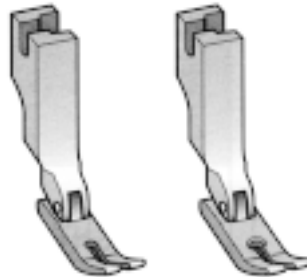

BA-1157F
(P946)

BA-1157AF
(P58W)

Gelenkfuß mit hochgezogener Sohle
Hinged Presser Foot with turned up front



Sohlenbreite sole width	Artikelnummer Part No.
10,0	BA-1158F



BA-1158F
(P144HL)

ZZ-Gelenkpresserfuß
Hinged Zig-Zag Presser Foot



Überstichbreite in mm Stitch Width in mm	Artikelnummer Part No.
6,0	BZZ-049F
10,0	B541566



BZZ-049F

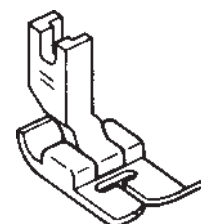

B541566

Ausgleichsgelenkfüße
Compensating Feet



Ausgleichsgelenkfuß, rechtsfedernd, metrisch
Compensating Foot, right, metrical

Steppbreite in mm <i>Stepping width in mm</i>	Artikelnummer <i>Part No.</i> Standard	Artikelnummer <i>Part No.</i> SUISEI
1,0	BD-4078F	BD-4078Fs
1,5	BD-4079F	BD-4079Fs
2,0	BD-4080F	BD-4080Fs
2,5	BD-4081F	BD-4081Fs
3,0	BD-4123F	BD-4123Fs
4,0	BD-4108F	
5,0	BD-4109F	
6,0	BD-4111F	BD-4111Fs
6,5		BD-4111AFs
7,0	BD-4112F	BD-4112Fs
8,0	BD-4113F	BD-4113Fs
10,0	BD-4113AF	BD-4113AFs

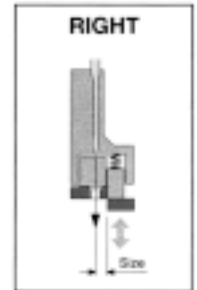

BD-4078Fs – BD-4113AFs
(SR10 – SR100)

Ausgleichsgelenkfuß, links federnd, metrisch
Compensating Foot, left, metrical



Steppbreite in mm <i>Stepping width in mm</i>	Artikelnummer <i>Part No.</i> Standard	Artikelnummer <i>Part No.</i> SUISEI
1,0	BD-4082F	BD-4082Fs
1,5	BD-4083F	BD-4083Fs
2,0	BD-4084F	BD-4084Fs
2,5	BD-4085F	
3,0	BD-4114F	
4,0	BD-4116F	
5,0	BD-4117F	
6,0	BD-4118F	
7,0	BD-4119F	
8,0	BD-4121F	
10,0	BD-4122F	

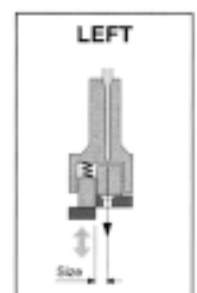

BD-4082Fs – BD-4084Fs
(SL10 – SL20)

Ausgleichsgelenkfüße Compensating Feet



Ausgleichsgelenkfuß, rechtsfedernd, metrisch, mit schmaler Sohlenbreite
Compensating Foot, right, metrical, narrow sole width

Stebbreite in mm Stepping width in mm	Artikelnummer Part No. Standard	Artikelnummer Part No. SUISEI
1,0	BNR-1,0NF	BA-1072Fs
1,5	BNR-1,5NF	BA-1072AFs
2,0	BNR-2,0NF	



BA-1072Fs
(SR10N)

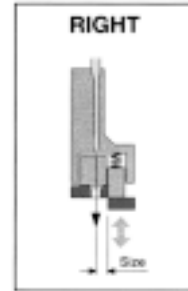

Ausgleichsgelenkfuß, links federnd, metrisch, mit schmaler Sohlenbreite
Compensating Foot, left, metrical, narrow sole width



Stebbreite in mm Stepping Width in mm	Artikelnummer Part No. Standard	Artikelnummer Part No. SUISEI
1,0	BNL-1,0NF	BA-1073Fs
1,5	BNL-1,5NF	BA-1073AFs



BA-1073Fs
(SL10N)

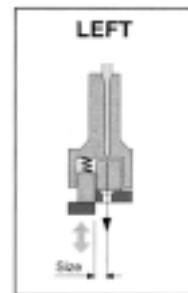

Ausgleichsgelenkfuß, doppelt federnd, metrisch
Compensating Foot, double, metrical



Stebbreite in mm Stepping Width in mm	Artikelnummer Part No. Standard	Artikelnummer Part No. SUISEI
0,0	BD-4074F	
1,0	BD-4075F	
1,5	BD-4076F	BD-4076Fs
2,0	BD-4077F	BD-4077Fs
3,0		BD-4077AFs

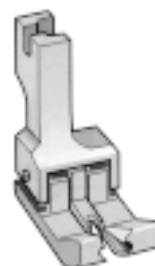

BD-4077Fs
(SD20)

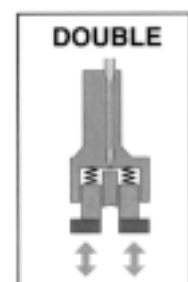

Ausgleichsgelenkfüße
Compensating Feet



ZZ-Ausgleichsfuß, doppelt federnd
Compensating Zig-Zag Foot, double

Übersichtsbreite in mm <i>Stitch width in mm</i>	Artikelnummer <i>Part No.</i>
5,0	BD-3570F

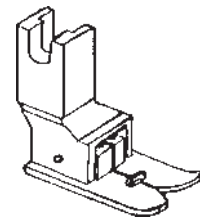

BD-3570F

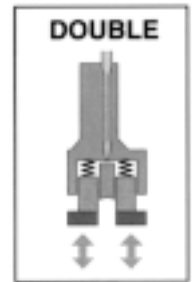

Ausgleichsgelenkfuß, rechts federnd, Zollmaße
Compensating Foot, right, inch sizes

Steppbreite in Zoll <i>Stepping Width in inch</i>	Steppbreite in mm <i>Stepping Width in mm</i>	Artikelnummer <i>Part No.</i>
1/32	0,8	BA-1051F
1/16	1,6	BA-1052F
3/32	2,4	BA-1053F
1/8	3,2	BA-1054F
5/32	4,0	BA-1055F
3/16	4,8	BA-1056F
1/4	6,4	BA-1057F
5/16	8,0	BA-1058F
3/8	9,5	BA-1059F
1/2	12,7	BA-1060F



BA-1055F
(CR5/32E)

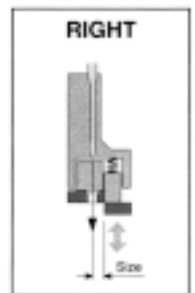

Ausgleichsgelenkfuß, links federnd, Zollmaße
Compensating Foot, left, inch sizes

Steppbreite in Zoll <i>Stepping width in inch</i>	Steppbreite in mm <i>Stepping width in mm</i>	Artikelnummer <i>Part No.</i>
1/32	0,8	BA-1061F
1/16	1,6	BA-1062F
3/32	2,4	BA-1062AF
1/8	3,2	BA-1063F
3/16	4,8	BA-1064F
1/4	6,4	BA-1065F
5/16	8,0	BA-1066F
1/2	12,7	BA-1068F



BA-1064F
(CL3/16E)



Ausgleichsgelenkfüße Compensating Feet



Ausgleichsgelenkfuß, rechts federnd, Zollmaße, schmale Sohlenbreite
Compensating Foot, right, inch sizes, narrow sole width

Stebbreite in Zoll <i>Stepping Width in inch</i>	Stebbreite in mm <i>Stepping Width in mm</i>	Artikelnummer <i>Part No.</i>
1/32	0,8	BA-1072F
1/16	1,6	BA-1072AF



BA-1072F
(CR-1/32N)

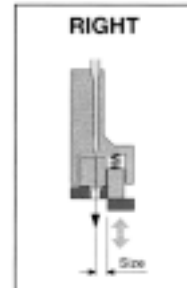

Ausgleichsgelenkfuß, links federnd, Zollmaße, schmale Sohlenbreite
Compensating Foot, left, inch sizes, narrow sole width

Stebbreite in Zoll <i>Stepping width in inch</i>	Stebbreite in mm <i>Stepping width in mm</i>	Artikelnummer <i>Part No.</i>
1/32	0,8	BA-1073F
1/16	1,6	BA-1073AF



BA-1073F
(CL-1/32N)

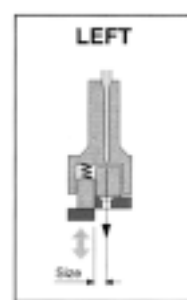

Ausgleichsgelenkfuß, rechts federnd, Zollmaße,
für feine Materialien und Strickwaren
*Compensating Foot, right, inch sizes,
for fine fabrics and knitted materials*



Stebbreite in Zoll <i>Stepping width in inch</i>	Stebbreite in mm <i>Stepping width in mm</i>	Artikelnummer <i>Part No.</i>
1/32	0,8	BA-1080F
1/16	1,6	BA-1081F
3/32	2,4	BA-1082F
1/8	3,2	BA-1083F
5/32	4,0	BA-1084F
3/16	4,8	BA-1085F
1/4	6,4	BA-1086F
5/16	8,0	BA-1087F
3/8	9,5	BA-1088F
1/2	12,7	BA-1089F



Verhindert hochziehen feiner Stoffe durch die Nadel.

Lifting of fine fabric with the needle is prevented.



BA-1086F
(CR-1/4K)



Ausgleichsgelenkfüße
Compensating Feet



Ausgleichsgelenkfuß, rechts federnd, Zollmaße, für zwei Steppbreiten
Compensating Foot, right, inch sizes, narrow sole width, for two stepping widths

Steppbreite in Zoll <i>Stepping width in inch</i>	Steppbreite in mm <i>Stepping width in mm</i>	Artikelnummer <i>Part No.</i>
1/32 + 1/4	0,8 + 6,4	BA-1186F
1/32 + 5/16	0,8 + 7,9	BA-1187F
1/16 + 1/4	1,6 + 6,4	BA-1188F
1/16 + 5/16	1,6 + 7,9	BA-1189F

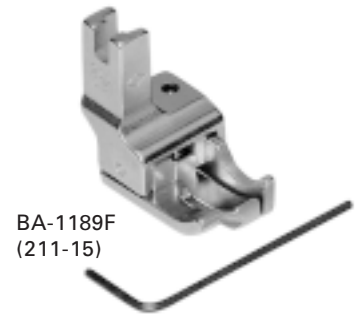
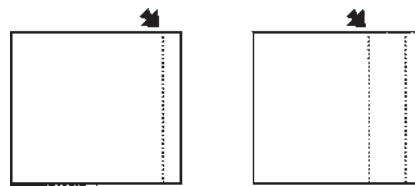

BA-1189F
(211-15)

Ausgleichsgelenkfuß, rechts federnd, Zollmaße, mit niedrigem Schaft
Compensating Foot, right, inch sizes, with low shank



Steppbreite in Zoll <i>Stepping width in inch</i>	Steppbreite in mm <i>Stepping width in mm</i>	Artikelnummer <i>Part No.</i>
1/16	1,5	BHH-1926/1
3/32	2,4	BHH-1926/2



BHH-1926/1



Ausgleichsgelenkfuß, doppelt federnd, Zollmaße
Compensating Foot, double, inch sizes



Steppbreite in Zoll <i>Stepping width in inch</i>	Steppbreite in mm <i>Stepping width in mm</i>	Artikelnummer <i>Part No.</i>
1/32	0,8	BA-1070F
1/16	1,6	BA-1071F

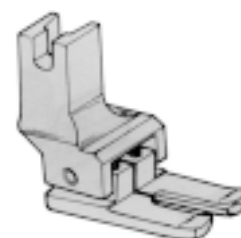

BA-1071F
(231)

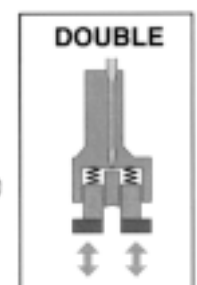

Kantennähfüße Edge Sewing Feet



Kantengelenkfuß, rechts
Hinged Raising Foot, right

Steppbreite in Zoll Stepping width in inch	Steppbreite in mm Stepping width in mm	Artikelnummer Part No.
1/32	0,8	BA-1090F
1/16	1,6	BA-1091F
1/8	3,2	BA-1092F
3/16	4,8	BA-1093F
1/4	6,4	BA-1094F
5/16	8,0	BA-1095F
3/8	9,5	BA-1096F
1/2	12,7	BA-1097F



BA-1094F
(P814)

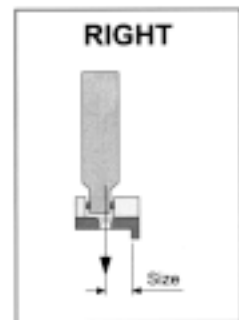

Kantengelenkfuß, links
Hinged Raising Foot, left



Steppbreite in Zoll Stepping width in inch	Steppbreite in mm Stepping width in mm	Artikelnummer Part No.
1/32	0,8	BA-1101F
1/16	1,6	BA-1102F
1/8	3,2	BA-1103F
3/16	4,8	BA-1104F
1/4	6,4	BA-1105F
5/16	8,0	BA-1106F
3/8	9,5	BA-1107F
1/2	12,7	BA-1108F



BA-1105F
(P814L)

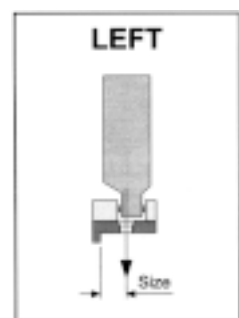

Kantennähfüße
Edge Sewing Feet



Kantenfuß mit Feder, rechts
Top Stitch Guide Foot with Spring, right

Steppbreite in Zoll <i>Stepping width in inch</i>	Steppbreite in mm <i>stepping width in mm</i>	Artikelnummer <i>Part No.</i>
1/32	0,8	BA-1111F
1/16	1,6	BA-1112F
3/32	2,4	BA-1113F
1/8	3,2	BA-1113AF
3/16	4,8	BA-1114F
1/4	6,4	BA-1115F
5/16	8,0	BA-1116F
3/8	9,5	BA-1117F
1/2	12,7	BA-1118F

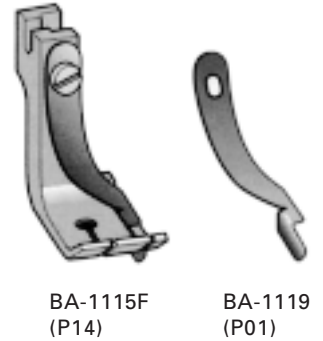

Ersatzfeder für Kantenfüße
Spring for Stitch Guide Foot

geeignet für Steppbreite in mm <i>suitable for stepping width in mm</i>	Artikelnummer <i>Part No.</i>
0,8 - 4,8	BA-1119
6,4 - 12,7	BA-1120

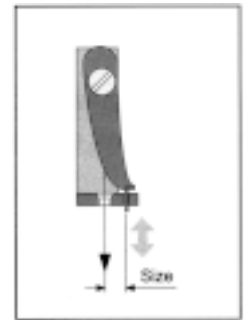

Presserfüße mit Lineal
Presser Feet with guide



Bemerkungen <i>Remarks</i>	Artikelnummer <i>Part No.</i> Standard	Artikelnummer <i>Part No.</i> SUISEI
Gelenkpresserfuß 5 - 45 mm, mit Lineal rechts und links <i>Hinged Presser Foot 5 - 45 mm, with guide right and left</i>	BA-1130F	BA-1130Fs
Gelenkkantenfuß 1,6 - 25 mm, mit Lineal rechts <i>Hinged Cording Foot 1,6 - 25 mm, with guide right</i>	BA-1131F	
Kantenfuß 1,6 - 25 mm, mit Lineal rechts <i>Cording Foot 1,6 - 25 mm, with guide right</i>	BA-1133F	

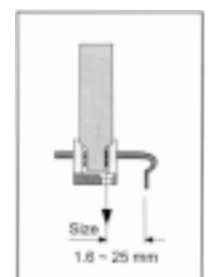
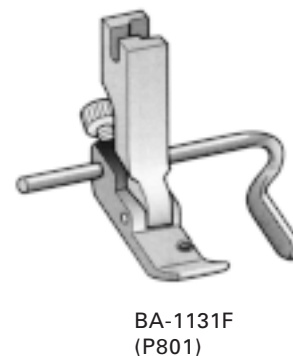
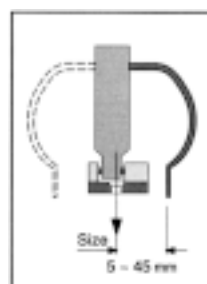
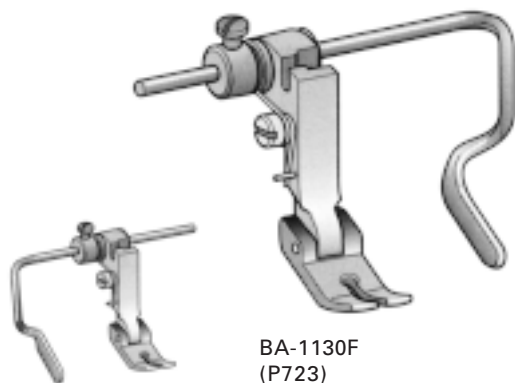

Kantennähfüße Edge Sewing Feet



Kantengelenkfuß, rechts
Hinged Cording Foot, right

Sohlenbreite in mm Sole Width in mm	Artikelnummer Part No. Standard	Artikelnummer Part No. SUISEI
8/0	BA-1136F	BA-1136Fs
5/0	BA-1137F	BA-1137Fs
6/1		BA-1154BFs
6/2	BA-1154F	BA-1154Fs

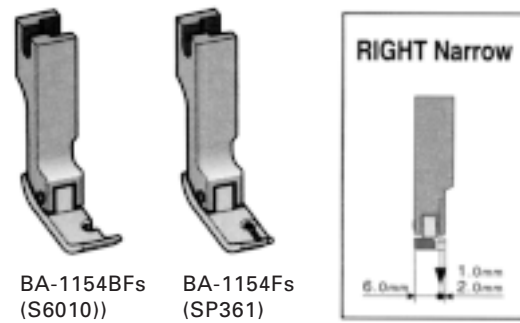
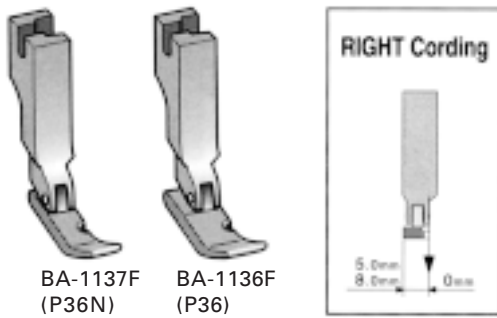

Kantengelenkfuß, links
Hinged Cording Foot, left



Sohlenbreite in mm Sole width in mm	Artikelnummer Part No. Standard	Artikelnummer Part No. SUISEI
8/0	BA-1138F	BA-1138Fs
5/0	BA-1139F	BA-1139Fs
6/1		BA-1153BFs
6/2	BA-1153F	BA-1153Fs

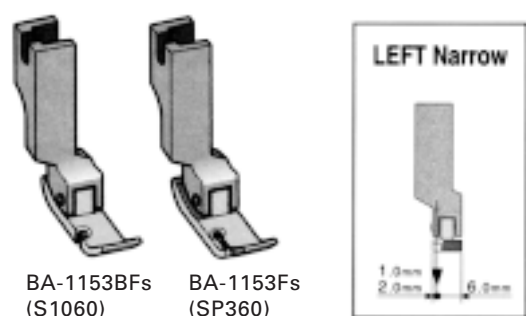
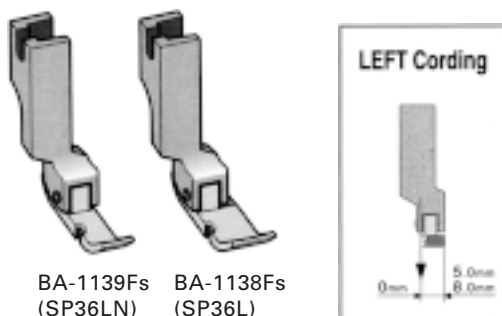

Kantennähfüße
Edge Sewing Feet



Kantenfuß, starr, rechts frei
Cording Foot, solid, right

Bemerkungen <i>Remarks</i>	Sohlenbreite in mm <i>Sole Width in mm</i>	Artikelnummer <i>Part No.</i>
	5,0	BA-1142F
mit Ausschnitt vorne <i>with front cut</i>	7,0	BA-1140F
	8,0	BA-1141F



BA-1142F
(P311N)



BA-1141F
(P31)

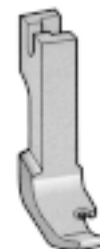

BA-1140F
(P311)



Kantenfuß, starr, links frei
Cording Foot, solid, left



Sohlenbreite in mm <i>Sole Width in mm</i>	Artikelnummer <i>Part No.</i>
5,0	BA-1144F
8,0	BA-1143F



BA-1144F
(P301N)



BA-1143F
(P301)

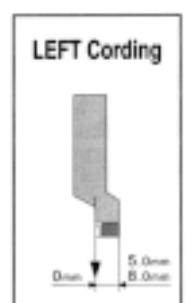

Reißverschlußfüße Zipper Feet



Bemerkungen Remarks	Sohlenbreite in mm Sole width in mm	Artikelnummer Part No. Standard	Artikelnummer Part No. SUISEI
starr <i>solid</i>	5,0	BA-1145F	
beweglich <i>hinged</i>	5,0	BA-1146F	BA-1146Fs
mit hochgezogener Sohle <i>with turned up front</i>	5,0	BA-1147F	
beweglich <i>hinged</i>	6,0		BA-1146AFs
rechts und links <i>right and left</i>		BA-1534	



BA-1146Fs
(S2525)



BA-1146AFs
(SP363)



BA-1147F
(P363V)

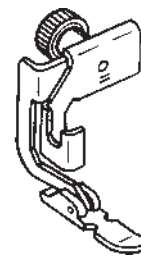

BA-1534
(4351H)



Füße für verdeckten Reißverschluß Feet for concealed zipper



Bemerkungen Remarks	Artikelnummer Part No.
starr, breite Sohle <i>solid, wide sole</i>	BA-1535AF
beweglich, breite Sohle <i>hinged, wide sole</i>	BA-1535F
beweglich, schmal, mit verlängertem Mittelsteg <i>hinged, narrow sole, with longer centre guide</i>	BA-1535CF
beweglich, mit niedriger Schafthöhe <i>hinged, low shank</i>	BS518-HH



BA-1535CF

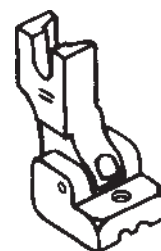

BA-1535F
(S518)

Kederfüße
Piping Feet



Gelenk-Kederfuß, rechts
Hinged Piping Foot, right

Kederdurchmesser in Zoll <i>Cord diametre in inch</i>	Kederdurchmesser in mm <i>Cord diametre in mm</i>	Artikelnummer <i>Part No.</i>
1/8	3,2	BA-1173F
3/16	4,8	BA-1174F
1/4	6,4	BA-1175F

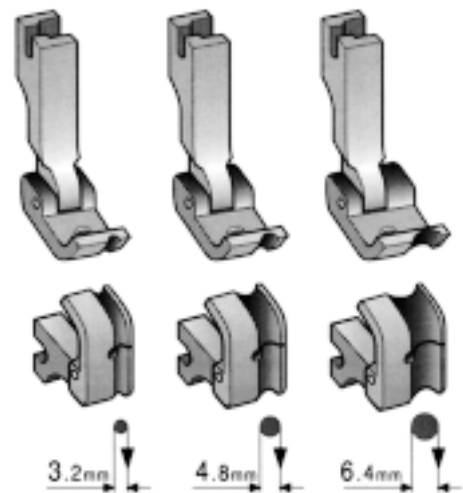

BA-1173F – BA-1175F
(P69RH)

Gelenk-Kederfuß, links
Hinged Piping Foot, left



Kederdurchmesser in Zoll <i>Cord diametre in inch</i>	Kederdurchmesser in mm <i>Cord diametre in mm</i>	Artikelnummer <i>Part No.</i>
1/8	3,2	BA-1176F
3/16	4,8	BA-1177F
1/4	6,4	BA-1178F

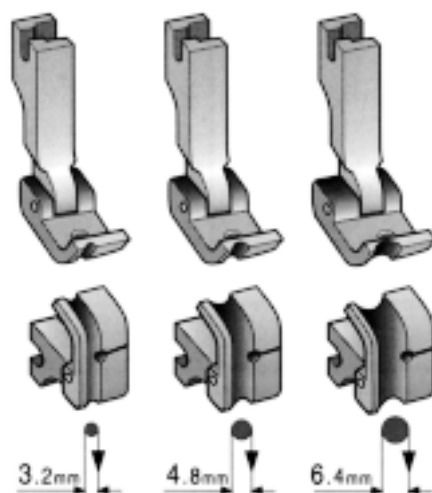

BA-1176F – BA-1178F
(P69LH)

Kederfüße Piping Feet



Kederfuß, starr, rechts
Solid Piping Foot, right

Kederdurchmesser in Zoll Cord diameter in inch	Kederdurchmesser in mm Cord diameter in mm	Artikelnummer Part No.
1/8	3,2	BA-1160F
3/16	4,8	BA-1161F
1/4	6,4	BA-1162F
3/8	9,5	BA-1163F
1/2	12,7	BA-1164F

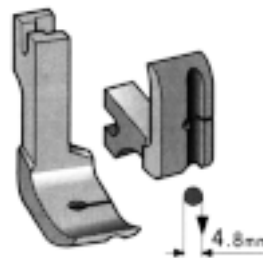

BA-1161F
(P69R-3/16)

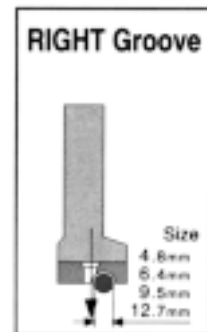

Kederkantenfuß, starr, rechts
Cording Piping Foot, solid, right



Kederdurchmesser in Zoll Cord diameter in inch	Kederdurchmesser in mm Cord diameter in mm	Artikelnummer Part No.
1/8	3,2	BA-1183F
3/16	4,8	BA-1184F
1/4	6,4	BA-1185F

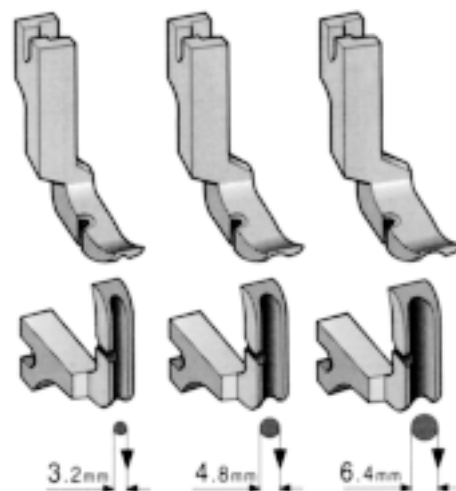

BA-1183F – BA-1185F
(P301C)

Kederfüße
Piping Feet



Starrer Kederfuß, links
Solid Piping Foot, left

Kederdurchmesser in Zoll <i>Cord diametre in inch</i>	Kederdurchmesser in mm <i>Cord diametre in mm</i>	Artikelnummer <i>Part No.</i>
1/8	3,2	BA-1165F
3/16	4,8	BA-1166F
1/4	6,4	BA-1167F
3/8	9,5	BA-1168F
1/2	12,7	BA-1169F

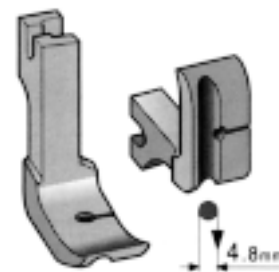

BA-1166F
(P69L-3/16)

Kederkantenfuß, links
Cording Piping Foot, left



Kederdurchmesser in Zoll <i>Cord diametre in inch</i>	Kederdurchmesser in mm <i>Cord diametre in mm</i>	Artikelnummer <i>Part No.</i>
1/8	3,2	BA-1180F
3/16	4,8	BA-1181F
1/4	6,4	BA-1182F

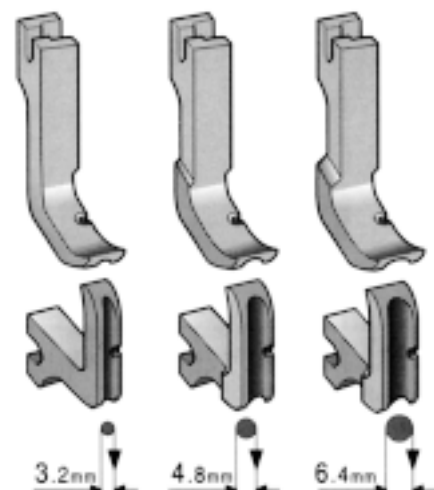

BA-1180F – BA-1182F
(P31C)

Kederfüße Piping Feet



Starrer Kederfuß mit doppelter Rille
Solid Piping Foot with double groove

Kederdurchmesser in mm <i>Cord diametre in mm</i>	Kederdurchmesser in mm <i>Cord diametre in mm</i>	Artikelnummer <i>Part No.</i>
1/8	3,2	BA-1170F
3/16	4,8	BA-1171F
1/4	6,4	BA-1172F

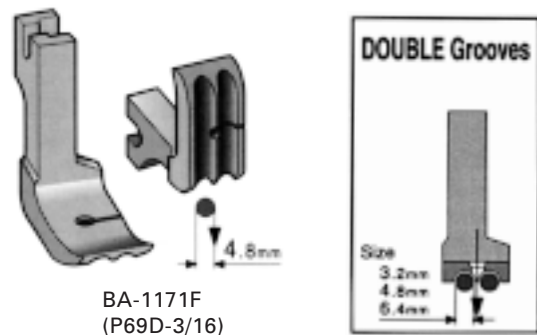

Apparate-Kederfuß, starr
Solid Attachment Piping Foot



Kederdurchmesser in mm <i>Cord diametre in mm</i>	Artikelnummer <i>Part No.</i>
2,0	BA-1241F
3,0	BA-1242F
4,0	BA-1243F

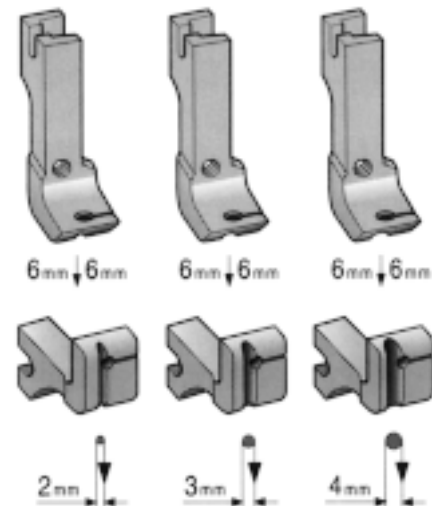

BA-1241F – BA-1243F
(P37)

Bandfüße
Tape Feet



Schlaufenfalterfuß für Schrägband
Bias Loop Piping Foot

Bandbreite in mm <i>Tape width in mm</i>	Fertigbreite in mm <i>Finished size in mm</i>	Artikelnummer <i>Part No.</i> SUISEI
12,0	3,0	BA-1228As
16,0	4,0	BA-1228s
20,0	5,0	BA-1229s
25,0	6,5	BA-1230s

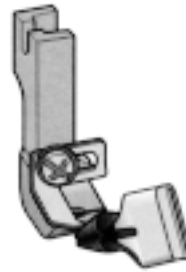

BA-1228As
(A21-3)



Verstellbarer Bandführungsfuß
Adjustable Tube Foot



Verstellbereich in mm <i>Range of adjustment in mm</i>	Artikelnummer <i>Part No.</i> Standard	Artikelnummer <i>Part No.</i> SUISEI
1-55	BA-1223	BA-1223s

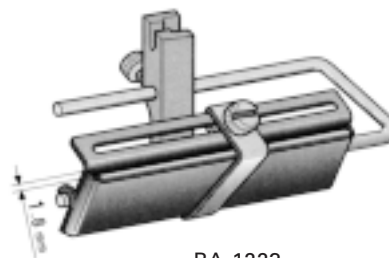

BA-1223
(A255)

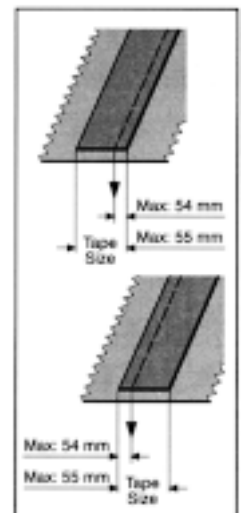

1.1

Bandfüße Tape Feet



Bandführungsfuß, mitte
Hinged Tube Foot, center

Bandbreite in Zoll <i>Tape width in inch</i>	Bandbreite in mm <i>Tape width in mm</i>	Artikelnummer <i>Part No. Standard</i>	Artikelnummer <i>Part No. SUISEI</i>
	3,0		BA-1214Fs
1/8	3,2	BA-1214	
3/16	4,8	BA-1214A	
	5,0		BA-1214AFs
1/4	6,4	BA-1215	
	6,5		BA-1215Fs
	8,0		BA-1215BFs
3/8	9,5	BA-1215A	
	10,0		BA-1215AFs
1/2	12,7	BA-1216	

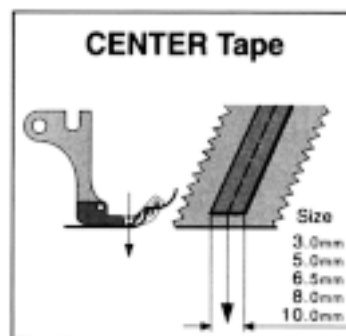
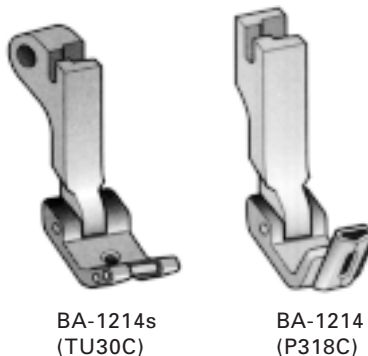

Bandführungsfuß, rechts
Hinged Tube Foot, right



Bandbreite in Zoll <i>Tape width in inch</i>	Bandbreite in mm <i>Tape width in mm</i>	Artikelnummer <i>Part No. Standard</i>	Artikelnummer <i>Part No. SUISEI</i>
1/8	3,2	BA-1216A	
3/16	4,8	BA-1216B	
	5,0		BA-1216BFs
1/4	6,4	BA-1217	
	6,5		BA-1217Fs
3/8	9,5	BA-1217A	
	10,0		BA-1217AFs
1/2	12,7	BA-1218	

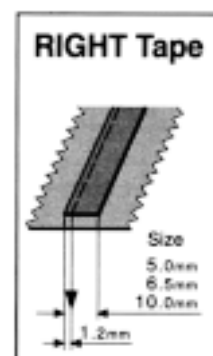
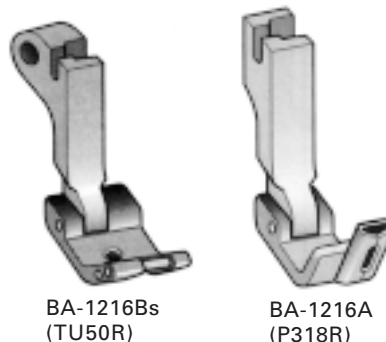

Bandfüße
Tape Feet



Bandführungsfuß, links
Hinged Tube Foot, left

Bandbreite in Zoll <i>Tape width in inch</i>	Bandbreite in mm <i>Tape width in mm</i>	Artikelnummer <i>Part No. Standard</i>	Artikelnummer <i>Part No. SUISEI</i>
1/8	3,2	BA-1218A	
3/16	4,8	BA-1218B	
	5,0		BA-1218BFs
1/4	6,4	BA-1219	
	6,5		BA-1219Fs
3/8	9,5	BA-1220A	
	10,0		BA-1220AFs
1/2	12,7	BA-1220	

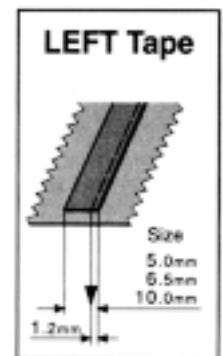
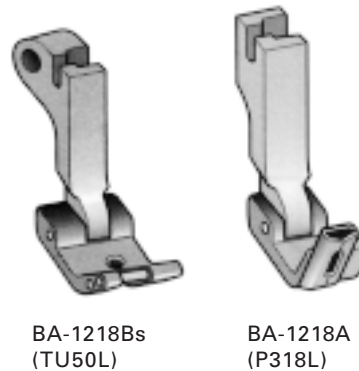

Bandführungsfuß mit Bremse
Elastic shirring foot with adjustable Tension



Bandbreite in Zoll <i>Tape width in inch</i>	Bandbreite in mm <i>Tape width in mm</i>	Artikelnummer <i>Part No.</i>
1/8	3,2	BA-1224
3/16	4,8	BA-1225
1/4	6,4	BA-1225A
3/8	9,5	BA-1226
1/2	12,7	BA-1227

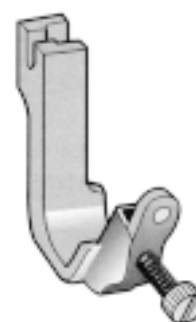

BA-1224
(A227-1/8)

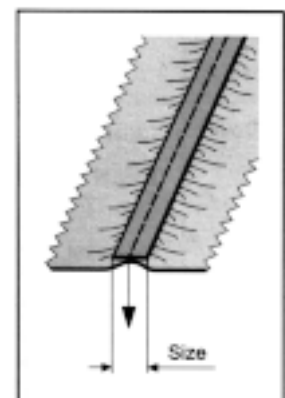

Apparatefüße Attachment Feet



Apparate-Gelenkfuß
Attachment Foot

geeignet für Fertigbreite suitable for finished size	Artikelnummer Part No.
< 9 mm	BA-1256F
9 - 20 mm	BA-1257F
> 20 mm	BA-1258F



BA-1256F
(P3613)

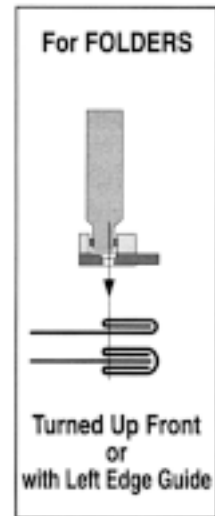

Apparate-Fuß mit Kantenführung
Attachment Foot with edge guide

geeignet für Fertigbreite suitable for finished size	Artikelnummer Part No.
< 9 mm	BA-1259F
9 - 20 mm	BA-1260F
> 20 mm	BA-1261F



BA-1260F
(P3819)

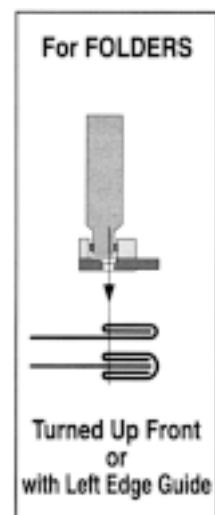

Apparate-Gelenkfuß für Schrägbandeinfasser SUISEI A10s
Hinged Attachment Foot for right angle bias tape binder SUISEI A10s



geeignet für Fertigbreite suitable for finished size	Artikelnummer Part No.
4,0 - 5,0 mm	BSA40Fs
4,5 - 5,0 mm	BSA45Fs
5,5 - 6,0 mm	BSA55Fs
6,5 - 7,0 mm	BSA65Fs
8,0 - 8,5 mm	BSA75Fs
9,5 mm	BSA85Fs
10,0 mm	BSA95Fs
11,5 mm	BSA105Fs
13,0 mm	BSA130Fs
15,0 - 18,0 mm	BSA150Fs
20,0 - 25,0 mm	BSA200Fs
über / over 25,0 mm	BSA250Fs



BSA105Fs
(SA105)

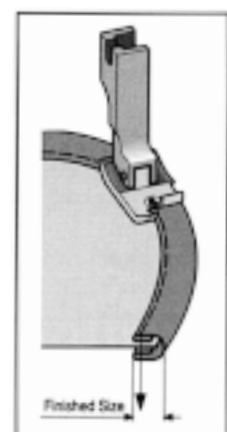

Apparatefüße
Attachment Feet



Ausgleichsgelenkfuß für Bandeffasser
Compensating Foot for tape binder

geeignet für Fertigbreite <i>suitable for finished size</i>	Artikelnummer <i>Part No.</i>
4,0 - 6,0 mm	BA-1247F
6,5 - 9,0 mm	BA-1248F
10,0 - 16,0 mm	BA-1249F



BA-1248F
(602)



Ausgleichsgelenkfuß für Apparate
Compensating Foot for attachments

geeignet für Fertigbreite <i>suitable for finished size</i>	Artikelnummer <i>Part No.</i>
< 19 mm	BA-1262F
> 19 mm	BA-1263F

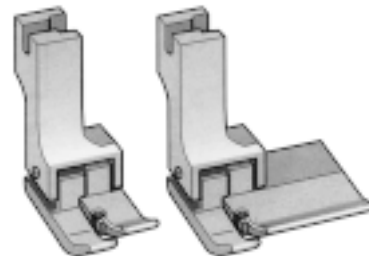

BA-1262F
(CHN)

BA-1263F
(CHW)

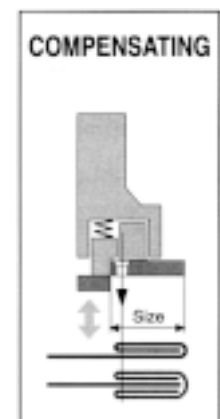

Ausgleichsgelenkfuß für Schrägbandeffasser
SUISEI A10C

*Attachment Compensating Foot for right angle
bias tape binder SUISEI A10C*

geeignet für Fertigbreite <i>suitable for finished size</i>	Artikelnummer <i>Part No.</i>
4,0 - 5,0 mm	BSC40Fs
5,0 - 5,5 mm	BSC45Fs
5,0 - 6,0 mm	BSC55Fs
6,5 - 7,0 mm	BSC65Fs
8,0 - 8,5 mm	BSC75Fs
9,5 mm	BSC85Fs
9,5 - 10,0 mm	BSC95Fs
11,5 - 16,0 mm	BSC105Fs



BSC65Fs
(SC65)

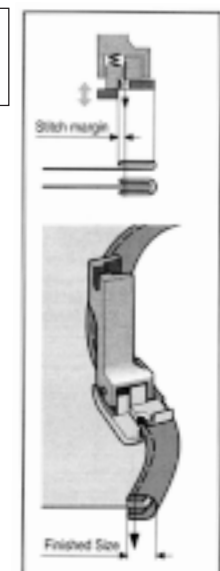

Apparatefüße Attachment Feet



ZZ-Ausgleichsgelenkfuß für Bandefasser
Zig-Zag Compensating Foot for tape binder

Überstichbreite in mm <i>Stitch width in mm</i>	Artikelnummer <i>Part No.</i>
3,0	BZZ-3.5F
5,0	BZZ-5.0F

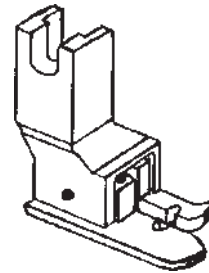

BZZ-3,5F

Presserfuß mit hochgezogener Sohle, starr
Presser Foot with turned up front, solid



Sohlenbreite in mm <i>Sole width in mm</i>	Artikelnummer <i>Part No.</i>
7,0	BA-1244F
9,0	BA-1245F



BA-1244F
(P34)

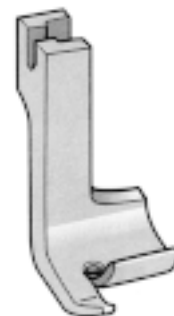

BA-1245F
(P344)

Apparatefuß, starr
Attachment Foot, solid



geeignet für Fertigbreite <i>suitable for finished size</i>	Artikelnummer <i>Part No.</i>
4,0 - 5,5 mm	BA-1250F
6,0 - 6,5 mm	BA-1251F
7,0 - 8,0 mm	BA-1252F
8,5 mm	BA-1253F
10,0 mm	BA-1254F
11,5 - 16,0 mm	BA-1255F

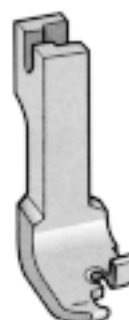

BA-1251
(A10-01x7/8)

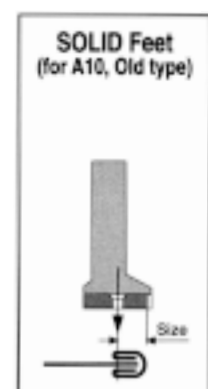

Säumer- und Kappfüße
Hemmer and Feller Feet



Säumerfuß, gefedert
Spring Wire Hemmer Foot

Saumbreite in Zoll <i>Hemming width in inch</i>	Saumbreite in mm <i>Hemming width in mm</i>	Artikelnummer <i>Part No.</i>
1/32	0,8	BA-1011AF
1/16	1,6	BA-1011F
1/8	3,2	BA-1012F
3/16	4,8	BA-1013F
1/4	6,4	BA-1014F



BA-1013F
(H5018-3/16)

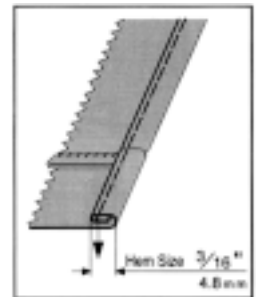

Rollsaumfuß
Ball Hemmer Foot



Saumbreite in Zoll <i>Hemming width in inch</i>	Saumbreite in mm <i>Hemming width in mm</i>	Artikelnummer <i>Part No.</i> Standard	Artikelnummer <i>Part No.</i> SUISEI
1/32	0,8	BA-1016AF	
1/16	1,6	BA-1016F	BA-1016Fs
1/8	3,2	BA-1017F	BA-1017Fs
3/16	4,8	BA-1018F	BA-1018Fs
1/4	6,4	BA-1019F	BA-1019Fs



BA-1018F
(H6010-3/16)

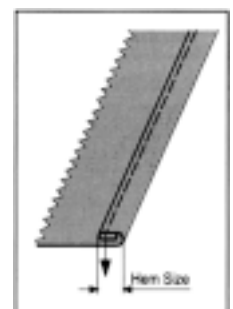

Säumer- und Kappfüße Hemmer and Feller Feet



Säumerfuß, starr
Hemmer Foot, solid

Saumbreite in Zoll Hemming width in inch	Saumbreite in mm Hemming width in mm	Artikelnummer Part No.
1/16	1,6	BA-1000F
5/64	2,0	BA-1001F
3/32	2,4	BA-1002F
1/8	3,2	BA-1003F
5/32	4,0	BA-1004F
3/16	4,8	BA-1005F
7/32	5,6	BA-1006F
1/4	6,4	BA-1007F
5/16	8,0	BA-1008F
3/8	9,5	BA-1009F
7/16	11,0	BA-1010F



BA-1005F
(4)

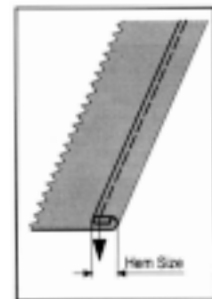

ZZ Säumerfuß
Zig-Zag Hemmer Foot



Saumbreite in mm Hemming width in mm	Artikelnummer Part No.
1,5	BNS151-Z-072
2,5	BNS2-21-75
3,0	BNS32-20-77
5,0	BNS43-206-77



BNS2-21-75

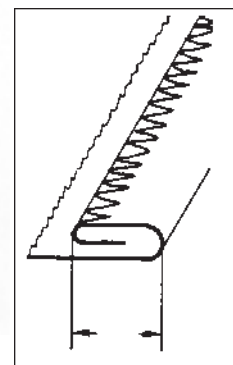

Säumer- und Kappfüße
Hemmer and Feller Feet



Kappfuß, mit Umbug oben
Feller Foot, with upper fold upturn

Kappbreite in Zoll <i>Fell size in inch</i>	Kappbreite in mm <i>Fell size in mm</i>	Artikelnummer <i>Part No. Standard</i>	Artikelnummer <i>Part No. SUISEI</i>
	3,0		BSHP30Fs
1/8	3,2	BA-1020F	
3/16	4,8	BA-1021F	
7/32	5,6	BA-1022F	
1/4	6,4	BA-1023F	
5/16	8,0	BA-1024F	
3/8	9,5	BA-1025F	



BSHP30F
(SHP30)

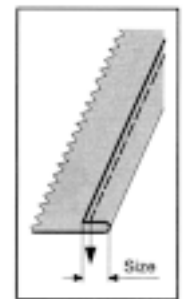

Kappfuss nach links unten
Downturn Top Stitch Feller Foot



Kappbreite in Zoll <i>Fell size in inch</i>	Kappbreite in mm <i>Fell size in mm</i>	Artikelnummer <i>Part No.</i>
3/16	4,8	BA-1032F
1/4	6,4	BA-1033F



BA-1032F
(H5019-3/16)

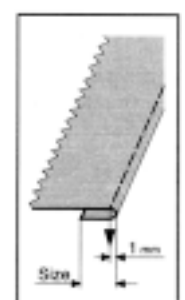

Säumer- und Kappfüße Hemmer and Feller Feet



Kappfuß nach rechts unten
Reverse Downturn Top Stitch Feller Foot

Kappbreite in Zoll Fell size in inch	Kappbreite in mm Fell size in mm	Artikelnummer Part No.
3/16	4,8	BA-1034F
1/4	6,4	BA-1035F



BA-1034F
(H5019R-3/16)

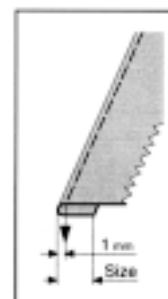

Kräuselfuß Shirring Foot



Bemerkungen Remarks	Artikelnummer Part No.
verstellbar adjustable	BA-1040F
mit Führung 5 mm with top ply guide 5 mm	BA-1041F
mit Führung 10 mm with top ply guide 10 mm	BA-1042F
leichte Kräuselung regular step	BA-1043F
mittlere Kräuselung medium step	BA-1044F
starke Kräuselung high step	BA-1045F
schmal, mittlere Kräuselung narrow, medium step	BA-1045AF



BA-1040F
(P953)



BA-1045F
(P50H)



BA-1040F
(P5)

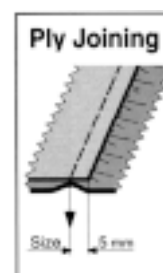

Rollfuß
Roller Foot



Bemerkungen Remarks	Artikelnummer Part No.
Einrollenfuß Spring Action Roller Foot	BA-1179F
mit 28 mm Rolle with 28 mm roller	BA-1530
mit 22 mm Rolle with 22 mm roller	BA-1531
SPK3	BA-1532F



BA-1179F
(R2E)

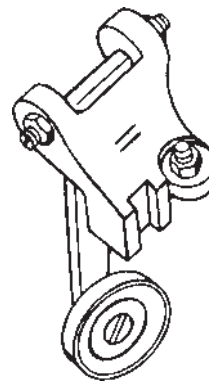

BA-1531
(12264)

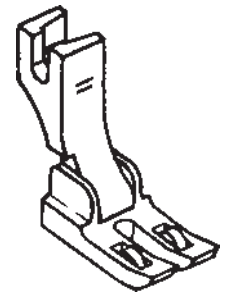

BA-1532F
(SPK3)

Rollbandfuß
Slide Ring Foot



Bemerkungen Remarks	Artikelnummer Part No.
Doppel-Rollbandfuß Double Slide Ring Foot	BD-4086
Ersatzring für Rollbandfuß BD-4086 Slide Ring for BD-4086	BD-4089

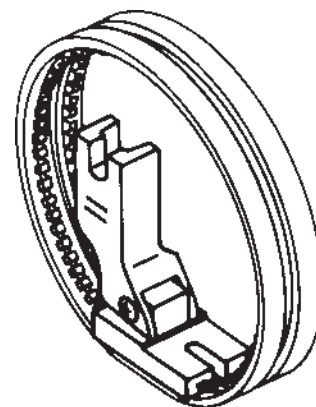

BD-4086
(DB-12)

Teflonfüße Teflon Feet



Teflon-Gelenkpresserfuß
Hinged Teflon Presser Foot

Bemerkungen Remarks	Sohlenbreite in mm Sole width in mm	Artikelnummer Part No. Standard	Artikelnummer Part No. SUISEI
rechte Zehe verkürzt right toe shorter	11,0	BA-1212F	
rechte Zehe verkürzt right toe shorter	11,0	BNT-18F	
gleichlange Zehen even toes	11,0	BA-1194F	
gleichlange Zehen even toes	13,0	BA-1196F	BA-1196Fs
geschlossene Sohle mit Stichloch closed sole with needle hole	11,0	BA-1206F	
geschlossene Sohle mit Stichloch closed sole with needle hole	13,0	BA-1208F	

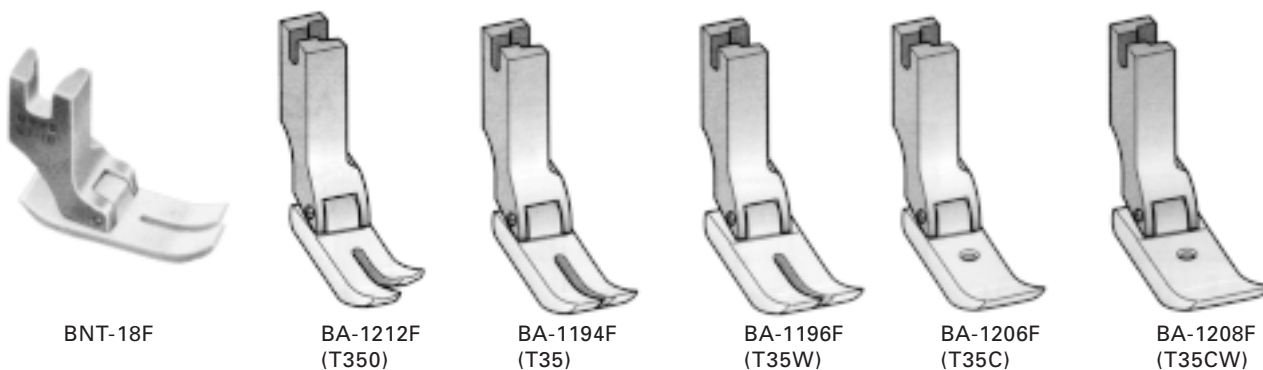

Teflon-ZZ-Fuß
Teflon Zig-Zag Foot



Überstichbreite in mm Stitch width in mm	Artikelnummer Part No.
8,0	BAZ16F



BAZ16F

Teflonfüße
Teflon Feet



Teflon-Kantenfuß
Teflon Cording Foot,

Bemerkungen Remarks	Sohlenbreite in mm Sole width in mm	Artikelnummer Part No. Standard	Artikelnummer Part No. SUISEI
rechts frei, breite Sohle <i>right, wide sole</i>	10,0	BA-1198F	
rechts frei, schmale Sohle <i>right, narrow sole</i>	6,0	BA-1200F	BA-1200Fs
links frei, breite Sohle <i>left, wide sole</i>	10,0	BA-1202F	
links frei, schmale Sohle <i>left, narrow sole</i>	7,0	BA-1204F	BA-1204Fs



BA-1200F
(T36N)



BA-1198F
(T36)



BA-1204F
(T36LN)

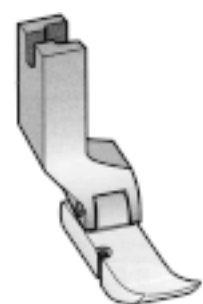

BA-1202F
(T36L)

Teflon-Reißverschußfuß
Teflon Zipper Foot



Sohlenbreite in mm Sole width in mm	Artikelnummer Part No. Standard	Artikelnummer Part No. SUISEI
6,0	BA-1210F	BA-1210Fs



BA-1210F
(T363)

Teflonfüße Teflon Feet



Teflon-Ausgleichsgelenkfuß, rechts federnd
Teflon Compensating Foot, right

Steppbreite in mm Stepping width in mm	Artikelnummer Part No.
1,0	BD-4384F
1,5	BD-4385F
2,0	BD-4386F
2,5	BD-4387F
3,0	BD-4388F



BD-4385F
(NRT-1.5)

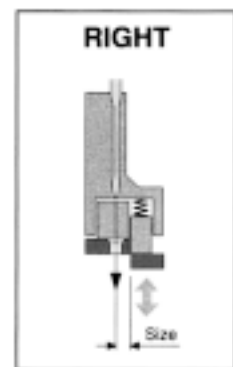

Teflon-Ausgleichsgelenkfuß, links
Teflon Compensating Foot, left



Steppbreite in mm Stepping width in mm	Artikelnummer Part No.
1,0	BD-4389F
1,5	BD-4390F
2,0	BD-4391F
2,5	BD-4392F
3,0	BD-4393F



BD-4390F
(NLT-1.5)

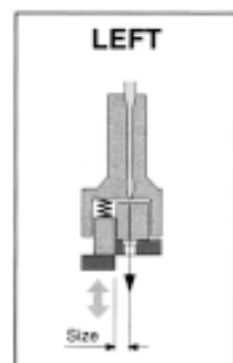

Teflonfüße
Teflon Feet

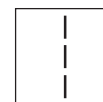

Teflonsohle
Teflon Sole

Bemerkungen Remarks	Sohlenbreite in mm Sole width in mm	Artikelnummer Part No. Standard	Artikelnummer Part No. SUISEI
Teflon-Presserfußsohle, für BA-1212 Teflon Presser Foot Sole, for BA-1212	11,0	BA-1213	
Teflon-Presserfußsohle, für BNT-18 Teflon Presser Foot Sole, for BNT-18	11,0	BNT-18B	
Teflon-Presserfußsohle mit gleichlangen Zehen, für BA-1194 Teflon Presser Foot Sole with even toes, for BA-1194	11,0	BA-1195	
Teflon-Presserfußsohle mit gleichlangen Zehen, breit, für BA-1196 Teflon Presser Foot Sole with even toes, wide, for BA-1196	13,0	BA-1197	
Teflon-Kantenfußsohle, rechts, breit, für BA-1198 Teflon Cording Foot Sole, right, wide, for BA-1198	10,0	BA-1199	
Teflon-Kantenfußsohle, rechts, schmal, für BA-1200 Teflon Cording Foot Sole, right, narrow, for BA-1200	7,0	BA-1201	BA-1201s
Teflon-Kantenfußsohle, links, breit, für BA-1202 Teflon Cording Foot Sole, left, wide, for BA-1202	10,0	BA-1203	
Teflon-Kantenfußsohle, links, schmal, für BA-1204 Teflon Cording Foot Sole, left, narrow, for BA-1204	7,0	BA-1205	BA-1205s
Teflon-Reißverschlussfußsohle, für BA-1210 Teflon Zipper Foot Sole, for BA-1210	6,0	BA-1211	BA-1211s
Teflon-Presserfußsohle, geschlossen, für BA-1206 Teflon Presser Foot Sole, closed, for BA-1206	11,0	BA-1207	
Teflon-Presserfußsohle, geschlossen, für BA-1208 Teflon Presser Foot Sole, closed, for BA-1208	13,0	BA-1209	



BA-1195
(T35B)

Bemerkungen Remarks	Überstich in mm Stitch width in mm	Artikelnummer Part No. Standard
Teflonsohle für ZZ-Fuß Teflon Sole for Zig-Zag Foot	8,0	BAZ16B

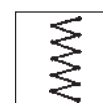

Bemerkungen Remarks	Stiepbreite in mm Stepping width in mm	Artikelnummer Part No. Standard
Teflon-AGF-Sohle, rechts, für BD-4384 Teflon Compensating Foot Sole, right, for BD-4384	1,0	BD-4384B
Teflon-AGF-Sohle, rechts, für BD-4385 Teflon Compensating Foot Sole, right, for BD-4385	1,5	BD-4385B

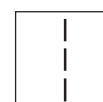

Teflee-GelenkfüÙe

Teflee Hinged Presser Feet

TEFLEE-FüÙe werden aus Hart-Aluminium gefertigt und in einem Tauchbad mit einer besonders haltbaren Teflonschicht überzogen.

Aufgrund des Herstellungsverfahrens bieten TEFLEE-FüÙe folgende Vorteile:

- kräuselfreies Nähen schwieriger Materialien durch reduzierten Anpressdruck und gleitfähige Oberfläche
- etwa zehnfache Standzeit im Vergleich zu herkömmlichen TeflonfüÙen

TEFLEE feet are manufactured of hard-alumina and coated with a special durable teflon film.

As result of the manufacturing procedure, TEFLEE feet offer following advantages:

- *puckering free sewing of difficult to handle materials because of reduced pressure and slipping foot surface*
- *ten times higher durability compared with standard teflon feet*

Teflee-Gelenkfuß
Teflee Hinged Presser Foot



Bemerkungen Remarks	Artikelnummer Part No.
für leichte bis mittlere Materialien <i>for light up to medium materials</i>	BPF-1F
für mittelschwere Materialien <i>for medium-heavy materials</i>	BPF-2F
für besonders leichte Materialien <i>for very light materials</i>	BPF-3F



BPF-1F

Passend für Maschinenklassen: s. Seite 1.1 - 2
Suitable for machine classes: see page 1.1 - 2

Teflee-Gelenkfüße
Teflee Hinged Presser Feet



Teflee-Ausgleichsgelenkfuß, rechts federnd
Teflee Compensating Foot, right

Steppbreite in mm <i>Stepping width in mm</i>	Artikelnummer <i>Part No.</i>
1,0	BCF-1,0R
1,5	BCF-1,5R
2,0	BCF-2,0R
2,5	BCF-2,5R
3,0	BCF-3,0R
4,0	BCF-4,0R
5,0	BCF-5,0R
6,0	BCF-6,0R
7,0	BCF-7,0R
8,0	BCF-8,0R



BCF-3,0R

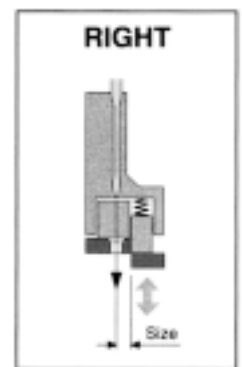

Teflee-Ausgleichsgelenkfuß, links federnd
Teflee Compensating Foot, left



Steppbreite in mm <i>Stepping width in mm</i>	Artikelnummer <i>Part No.</i>
1,0	BCF-1,0L
2,0	BCF-2,0L
3,0	BCF-3,0L



BCF-2,0L

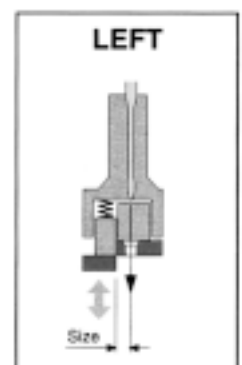

Verschleißteile für Nähfüße High Mortality Parts for Sewing Feet

Ersatzfedern für Nähfüße
Replacement Springs for sewing feet

geeignet für <i>suitable for</i>	Artikelnummer <i>Part No.</i>
Suisei SR, SL, SD, ST Ausgleichs- und Teflonfüße (neu) <i>Suisei SR, SL, SD, ST compensating and teflon feet (new)</i>	BB20s
Suisei CR, CL, CD Ausgleichsfüße (alte Ausführung) <i>Suisei CR, CL, CD compensating feet (old version)</i>	BB25s
Suisei T Teflonfüße (alte Ausführung) <i>Suisei T teflon feet (old version)</i>	BB30s



Ersatzschrauben für Nähfüße
Replacement Screws for sewing feet

geeignet für <i>suitable for</i>	Artikelnummer <i>Part No.</i>
Suisei S955, T35, T35C, T35CW, T35W, T36, T36L, T350	BC1s
Suisei CD00	BC02s
Suisei CR/CL10 - CR/CL30, CD10, CHN, CHW, CB3/4 - CB1-1/2	BC2s
Suisei CR/CL1/8, CD15	BC3s
Suisei CR/CL40 - CR/CL50, CD20	BC4s
Suisei CR/CL60 - CR/CL70	BC5s
Suisei T363	BC06s
Suisei CR/CL80	BC6s
Suisei T36N, T36LN	BC07s
Suisei CR/CL100	BC7s
Suisei CR/CL130	BC8s
Suisei S-Version Gelenkpresserfüße / <i>hinged presser feet</i>	BCPS07s
Suisei SR/SL10 - SR/SL15, SC40 - SC105	BCPS10s
Suisei SR/SL20 - SR40, SD15 + SD20	BCPS13s
Suisei SR50 - SR70, SD30	BCPS16s
Suisei SR80 - SR100	BCPS19s



Standardisierte Nähwerkzeuge
Standardized Sewing Parts



Nähgarnituren mit drei vollen Reihen, besonders zum Nähen gerader Bahnen geeignet.
Needle plates and feed dogs with three full rows, especially suitable for straight sewing.

fein fine	Artikelnummer Part No. Standard	Artikelnummer Part No. TQ
Stichplatte Needle plate	BD-3095	BD1109155WOO
Transporteur Feed dog	BD-3096	BD1613155WOO

mittel medium	Artikelnummer Part No. Standard	Artikelnummer Part No. TQ
Stichplatte Needle plate	B143272	BB1109012COO
Transporteur Feed dog	B149031	BB1613012COO

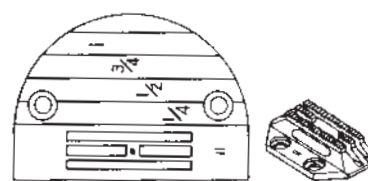

mittel-grob medium-coarse	Artikelnummer Part No. Standard
Stichplatte Needle plate	B20160LG
Transporteur Feed dog	B149159

grob coarse	Artikelnummer Part No. Standard
Stichplatte Needle plate	BD-3622
Transporteur Feed dog	BD-3623

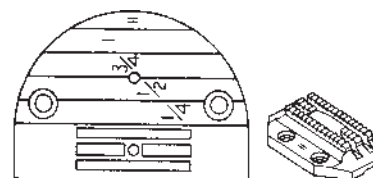

Standardisierte Nähwerkzeuge Standardized Sewing Parts

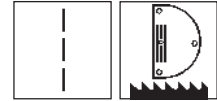

Nähgarnituren für Abkettarbeiten mit drei vollen Reihen, besonders zum Nähen gerader Bahnen geeignet.

Chaining-off needle plates and feed dogs with three full rows, especially suitable for straight sewing.

fein <i>fine</i>	Artikelnummer Part No. Standard	Artikelnummer Part No. TQ
Stichplatte <i>Needle plate</i>	B147158LG	BB1109012COO
Transporteur <i>Feed dog</i>	B149057	BB1613012COO

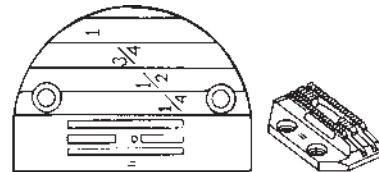

mittel <i>medium</i>	Artikelnummer Part No. Standard
Stichplatte <i>Needle plate</i>	B147150
Transporteur <i>Feed dog</i>	B149057

mittel-grob <i>medium-coarse</i>	Artikelnummer Part No. Standard
Stichplatte <i>Needle plate</i>	B142061LG
Transporteur <i>Feed dog</i>	B149062

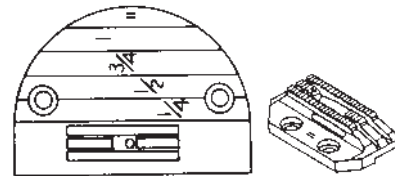

Nähgarnituren, dreireihig, besonders zum Kurvennähen geeignet.

Needle plates and feed dogs with three rows, especially suitable for curve sewing.



mittel <i>medium</i>	Artikelnummer Part No. Standard	Artikelnummer Part No. TQ
Stichplatte <i>Needle plate</i>	BD-3425C	BD-3425A
Transporteur <i>Feed dog</i>	BD-3426C	BD-3426A

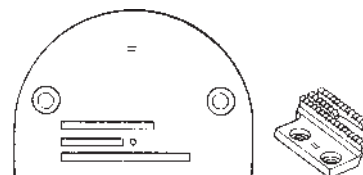

Standardisierte Nähwerkzeuge für spezielle Nähzwecke
Standardized Sewing Parts for special sewing purposes

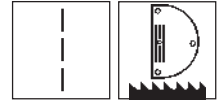

Nähgarnitur, dreireihig, für besonders schwere Materialien geeignet.
Needle plate and feed dog with three rows, especially suitable for heavy materials.

grob coarse	Artikelnummer Part No.
Stichplatte <i>Needle plate</i>	BB1109555HOB
Transporteur <i>Feed dog</i>	BB1613555HOO

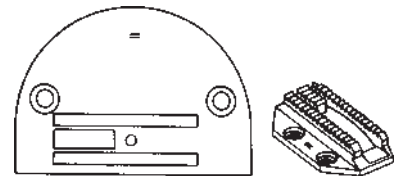

Nähgarnitur, einreihig, für Lederarbeiten mit Rollfuß geeignet.
Needle plate and feed dog with single row, suitable for leather sewing with roller foot.

grob coarse	Artikelnummer Part No.
Stichplatte <i>Needle plate</i>	BD-3429
Transporteur <i>Feed dog</i>	BD-3430

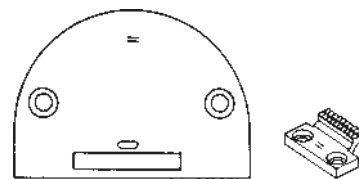

Anti-Kräusel-Nähgarnitur, für besonders feine Materialien geeignet.
Anti-puckering needle plate and feed dog, suitable for very fine materials.

fein fine	Artikelnummer Part No.
Stichplatte <i>Needle plate</i>	BAPS-11
Transporteur <i>Feed dog</i>	BAPS-12

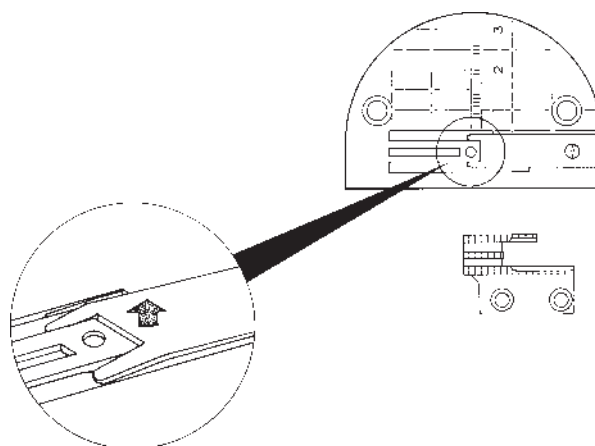

Ersatzteile für Anti-Kräusel-Nähgarnitur
Spare parts for anti-puckering set

Bemerkungen Remarks	Artikelnummer Part No.
Schraube <i>Screw</i>	BAPS-SC
Federblech <i>Spring plate</i>	BAPS-SP

Passend für Maschinenklassen: s. Seite 1.1 - 2
Suitable for machine classes: see page 1.1 - 2

Standardisierte Nähwerkzeuge für Arbeiten mit Nähapparaten Standardized Sewing Parts for works with sewing attachments

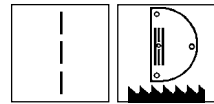

Nähgarnitur, fünfreiig, für Arbeiten mit Gürtelapparaten und Säumern geeignet.
Needle plate and feed dog with five rows, especially suitable for belt folders and hemmers.

Bemerkung Remarks	Artikelnummer Part No.
Stichplatte Needle plate	B149009
Transporteur Feed dog	B143402

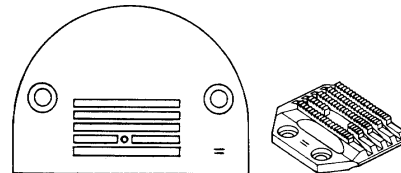

Nähgarnitur mit Blocktransporteur, für Arbeiten mit Gürtelapparaten und Säumern geeignet.
Needle plate and feed dog with block form, suitable for belt folders and hemmers.

Bemerkung Remarks	Artikelnummer Part No.
Stichplatte Needle plate	BA-1348s
Transporteur Feed dog	BA-1347s

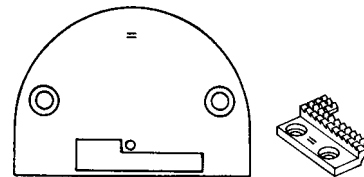

Nähgarnitur, dreireihig, für Arbeiten mit Einfassern geeignet.
Needle plate and feed dog with three rows, suitable for binders.

Bemerkung Remarks	Artikelnummer Part No.
Stichplatte Needle plate	BA-1350s
Transporteur Feed dog	BA-1349s

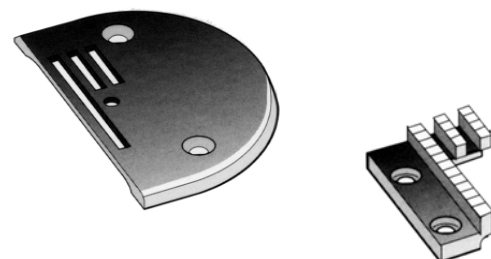

Standardisierte Nähwerkzeuge für Arbeiten mit Nähapparaten
 Standardized Sewing Parts for works with sewing attachments

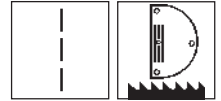

Stichplatte für Apparategarnitur SUISEI A10
 Needle plate for binder set SUISEI A10

Bemerkungen Remarks	Artikelnummer Part No. SUISEI A10S	Artikelnummer Part No. SUISEI A10
16 - 20 mm	BA-1350As	BA10-11s
22 - 28 mm		BA10-12As
22 - 32 mm	BA-1350Bs	
30 - 32 mm		BA10-12Cs
36 mm		BA10-12Bs
36 - 40 mm	BA-1350Cs	
45 - 50 mm	BA-1350Ds	



Stichplatte für Apparategarnitur FB60
 Needle plate for binder set FB60

Bemerkungen Remarks	Artikelnummer Part No.
16 - 50 mm	BA-1351

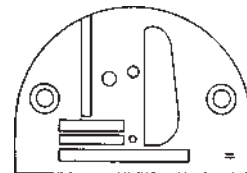

1: NÄHEN *SEWING*

1.2 NÄHWERKZEUGE FÜR EINNADEL- MASCHINEN MIT NADELTRANSPORT *SEWING PARTS FOR SINGLE-NEEDLE MACHINES WITH NEEDLE FEED*

Einleitung *Introduction*

Die Nähwerkzeuge in diesem Kapitel eignen sich zur Verwendung in sämtlichen Einnadel-Steppstichmaschinen mit Nadeltransport und standardisierter Nähgarnitur. Nachfolgend finden Sie eine Aufstellung der gängigsten Maschinentypen, bei denen die Nähwerkzeuge eingesetzt werden können:

The sewing parts in this chapter are suitable for single needle lockstitch machines with needle feed and standardized gauge sets. The following list presents a selection of the most popular sewing machine types in which the sewing parts can be used:

BROTHER

DB2-B700-Serie mit Nadeltransport / *with needle feed*

DÜRKOPP

272

JUKI

DLN-415, DLN-5410

mitsubishi

LS2-Serie

PFAFF

461, 561, 951, 1051 ohne FA, *without TC*

SINGER

251, 281, 366K, 391, 491, 591 mit Nadeltransport / *with needle feed*

Revolverkopf-Nähfußhalter
Turret Presser Foot Holder



Bemerkung <i>Remark</i>	Artikelnummer <i>Part No.</i>
zur Montage an vorhandenen Presserstangen <i>to be fixed at the existing presser bar</i>	BD-5029
komplett mit Presserstange 8,8 mm Ø <i>compl. with presser bar 8,8 mm Ø</i>	BD-5030

Der Revolverkopf-Nähfußhalter ermöglicht die Aufnahme von drei Nähfüßchen. Durch drehen der Halterung kann das benötigte Füßchen gewählt werden.

The turret presser foot holder offers three possibilities to fix sewing machine presser feet. The required sewing foot can be chosen by simple turning the turret bracket.

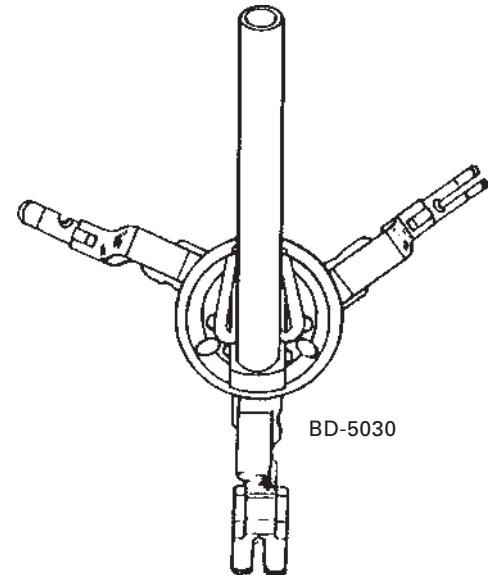

Gelenkpresserfuß für Standard-Nadeltransportmaschinen
Hinged Presser Foot for standard needle feed machines



Sohlenbreite <i>Sole width</i> in mm	Artikelnummer <i>Part No.</i> Standard	Artikelnummer <i>Part No.</i> SUISEI
10	BA-1155F	BA-1155Fs
11	BB1524412OBOF	BA-1155BFs
13	BB1524041EBOF	
14	B272-6807F	



BA-1155Fs



BA-1155BFs

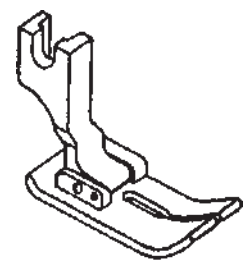

B272-6807F

Ausgleichsgelenkfüße für Nadeltransportmaschinen Compensating Feet for Needle Feed Machines



Ausgleichsgelenkfuß für Nadeltransportmaschinen, rechts, metrisch
Compensating foot for needle feed machines, right, metrical

Stepbreite Stepping width in mm	Artikelnummer Part No. Standard	Bemerkung Remark SUISEI
1,0	BDNR-1,0F	BDNR-1,0Fs
1,5	BDNR-1,5F	BDNR-1,5Fs
2,0	BDNR-2,0F	BDNR-2,0Fs
3,0	BDNR-3,0F	
5,0	BDNR-5,0F	

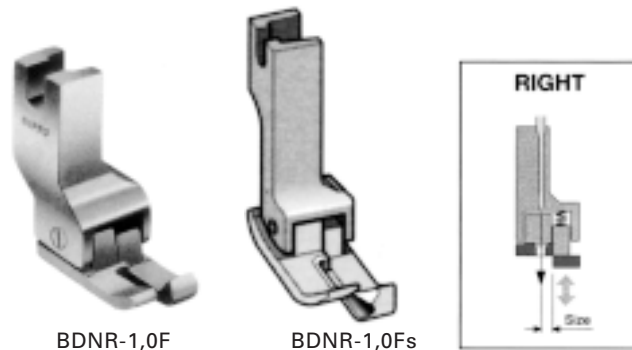

BDNR-1,0F

BDNR-1,0Fs

Ausgleichsgelenkfuß für Nadeltransportmaschinen, rechtsfedernd
Compensating foot for needle feed machines, right



Stepbreite in Zoll Stepping width in Inch	Stepbreite in mm Stepping width in mm	Artikelnummer Part No.
1/32	0,8	BD-3560F
1/16	1,6	BD-3561F
1/8	3,2	BD-3562F
3/16	4,8	BD-3563F
1/4	6,4	BD-3564F

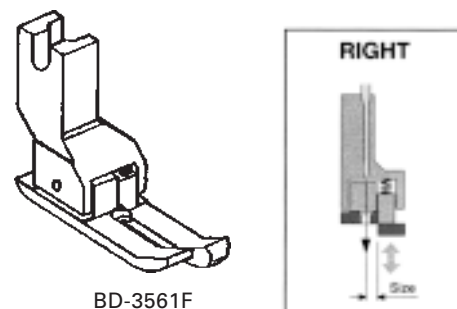

BD-3561F

Ausgleichsgelenkfüße für Nadeltransportmaschinen
Compensating Feet for Needle Feed Machines



Ausgleichsgelenkfuß für Nadeltransportmaschinen, links
Compensating foot for needle feed machines, left

Stebbreite in Zoll <i>Stepping width in Inch</i>	Stebbreite in mm <i>Stepping width in mm</i>	Artikelnummer <i>Part No.</i>
1/32	0,8	BD-3565F
1/16	1,6	BD-3566F
1/8	3,2	BD-3567F
3/16	4,8	BD-3568F
1/4	6,4	BD-3569F



BD-3565F



Ausgleichsgelenkfuß für Nadeltransportmaschinen, doppelt
Compensating foot for needle feed machines, double



Stebbreite in Zoll <i>Stepping width in Inch</i>	Stebbreite in mm <i>Stepping width in mm</i>	Artikelnummer <i>Part No.</i>
1/32	0,8	BD-3571F
1/16	1,6	BD-3572F



BD-3571F

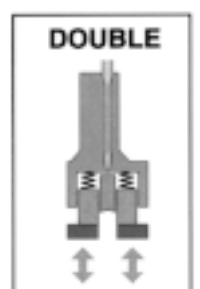

1.2

Kantengelenkfuß für Nadeltransportmaschinen Cording Feet for Needle Feed Machines



Kantengelenkfuß für Nadeltransportmaschinen, rechts
Hinged Cording Foot for needle feed machines, right

Sohlenbreite Sole width in mm	Artikelnummer Part No. Standard	Artikelnummer Part No. SUISEI
5/0	BD-3556F	BD-3556Fs
7/0	BD-3557F	
6/2		BA-1154AFs

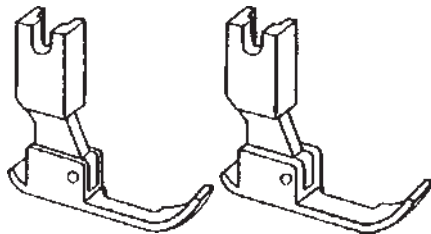

BD-3556F

BD-3557F

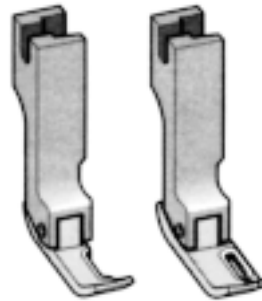

BD-3556Fs

BA-1154AFs



Kantengelenkfuß für Nadeltransportmaschinen, links
Hinged cording foot for needle feed machines, left



Sohlenbreite Sole width in mm	Artikelnummer Part No. Standard	Artikelnummer Part No. SUISEI
5/0	BD-3558F	BD-3558Fs
7/0	BD-3559F	
6/2		BA-1153AFs

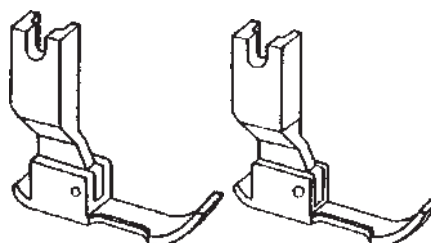

BD-3558F

BD-3559F



BD-3558Fs

BA-1153AFs



Reißverschußfüße
Zipper Feet

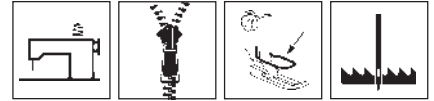

Reißverschußfuß für Nadeltransportmaschinen
Zipper Foot for needle feed machines

Bemerkungen Remarks	Sohlenbreite Sole width in mm	Artikelnummer Part No. Standard	Artikelnummer Part No. SUISEI
	5,4	BD-3554F	
	6,0	BA-1148F	BA-1148Fs
	7,0	BD-3555F	
verstellbar, für den Einsatz links oder rechts adjustable, suitable for left or right cording	7,0	B6648	

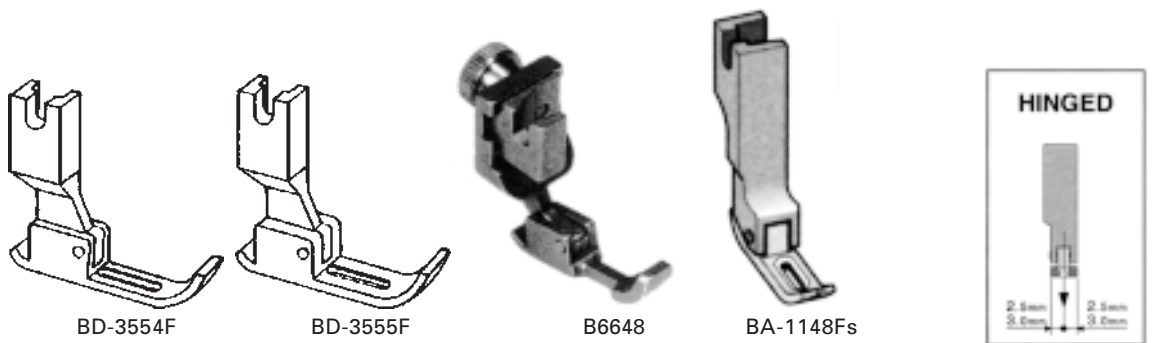

Füße für verdeckten Reißverschuß
Feet for concealed zipper



Bemerkungen Remarks	Artikelnummer Part No.
	BA-1535NF
schmal, mit verlängertem Mittelsteg narrow, with longer centre guide	BA-1535CNF

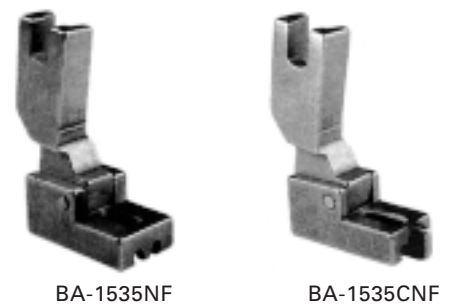

Teflonfuß für Nadeltransportmaschinen
Teflon Foot for needle feed machines



Bemerkungen Remarks	Sohlenbreite in mm Sole width in mm	Artikelnummer Part No.
Gelenkfuß, kompl. Hinged foot, compl.	13	BNT-24F
Ersatzsohle Replacement sole	13	BNT-24B



Teflee-GelenkfüÙe Teflee Hinged Presser Feet



TEFLEE-FüÙe werden aus Hart-Aluminium gefertigt und in einem Tauchbad mit einer besonders haltbaren Teflonschicht überzogen.

Aufgrund des Herstellungsverfahrens bieten TEFLEE-FüÙe folgende Vorteile:

- kräuselfreies Nähen schwieriger Materialien durch reduzierten Anpressdruck und gleitfähiger Oberfläche
- etwa zehnfache Standzeit im Vergleich zu herkömmlichen TeflonfüÙen

TEFLEE feet are manufactured of hard-alumina and coated with a special durable teflon film.

As result of the manufacturing procedure, TEFLEE feet offer following advantages:

- *puckering free sewing of difficult to handle materials because of reduced pressure and slipping foot surface*
- *ten times higher durability compared with standard teflon feet*

TEFLEE-Gelenkpresserfuß für Nadeltransportmaschinen
TEFLEE Hinged Presser Foot for needle feed machines



Bemerkungen <i>Remarks</i>	Artikelnummer <i>Part No.</i>
für leichte bis mittlere Materialien <i>for light up to medium materials</i>	BJN-1F



BJN-1F

Passend für Maschinenklassen: s. Seite 1.1 - 2
Suitable for machine classes: see page 1.1 - 2

Teflee-Gelenkfüße
Teflee Hinged Presser Feet



TEFLEE-Ausgleichsgelenkfuß für Nadeltransportmaschinen, rechts
TEFLEE Compensating Foot for needle feed machines, right

Stebbreite in mm <i>Stepping width in</i>	Artikelnummer <i>Part No.</i>
1,0	BCF-1,0RJN
1,5	BCF-1,5RJN
2,0	BCF-2,0RJN
2,5	BCF-2,5RJN
3,0	BCF-3,0RJN
4,0	BCF-4,0RJN
5,0	BCF-5,0RJN



BCF-3,0RJN

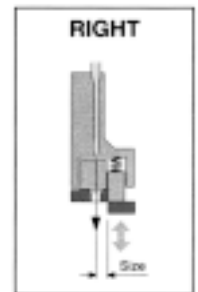

TEFLEE-Ausgleichsgelenkfuß für Nadeltransportmaschinen, links
TEFLEE Compensating Foot for needle feed machines, left



Stebbreite in mm <i>Stepping width in mm</i>	Artikelnummer <i>Part No.</i>
1,0	BCF-1,0LJN
2,0	BCF-2,0LJN
3,0	BCF-3,0LJN



BCF-2,0LJN



Standardisierte Nähwerkzeuge, dreireihig Standardized Sewing Parts, three full rows

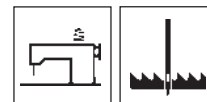

Nähgarnituren für Einnadelmaschinen mit Nadeltransport
Throat Plates and Feed Dogs for single needle machines with needle feed

Bemerkungen Remarks	fein fine	Artikelnummer Part No. TQ
für Synthetikmaterial for synthetic material	Stichplatte Needle Plate	BB1109415BOO
für Synthetikmaterial for synthetic material	Transporteur Feed Dog	BB1609415BOO



Bemerkungen Remarks	mittel medium	Artikelnummer Part No. TQ
	Stichplatte Needle Plate	BB1109041FOO
verstärkte Ausführung higher mechanical strength	Stichplatte Needle Plate	BB1109041FOB
	Transporteur Feed Dog	BB1609041FOO

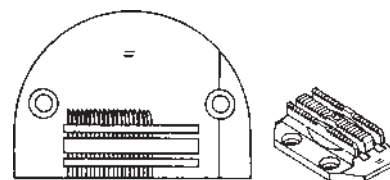

mittel-grob medium-coarse	Artikelnummer Part No. TQ
Stichplatte Needle Plate	BB1109041EEO
Transporteur Feed Dog	BB1609041EEO

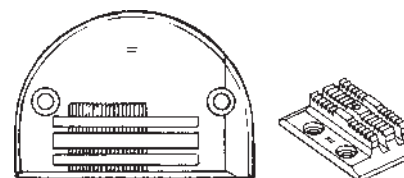

grob coarse	Artikelnummer Part No. TQ	Artikelnummer Part No. Standard
Stichplatte Needle Plate	BB1109415HOB	BD-3624
Transporteur Feed Dog	BD1609415HOB	BD-3625

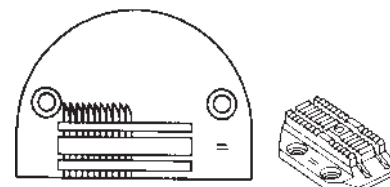

1: NÄHEN *SEWING*

1.3 NÄHWERKZEUGE FÜR ZWEINADEL-STEPSTICHMASCHINEN *SEWING PARTS FOR DOUBLE-NEEDLE LOCKSTITCH MACHINES*

Einleitung *Introduction*

Die Nähwerkzeuge in diesem Kapitel eignen sich zur Verwendung in sämtlichen Zweinadel-Stepstichmaschinen mit standardisierter Nähgarnitur. Nachfolgend finden Sie eine Auswahl der gängigsten Maschinentypen, bei denen die Nähwerkzeuge eingesetzt werden können:

The sewing parts in this chapter are suitable for all double needle lockstitch machines with standardized gauge sets. Below please find a selection of the most popular sewing machine types in which the sewing parts can be used:

BROTHER
LT2-B831, B832, B842, B872 ohne FA / *without TC*

CONSEW
139, 327, 332

DÜRKOPP
249, 380 ohne FA / *without TC*

JUKI
LH-512, 515, 1152 ohne FA / *without TC*

MITSUBISHI
DN-260, LT2-2220

SEIKO
LSW-27

SINGER
112G, 112W, 212G, 212W

Zweinadel-Umbaugarnituren
Double Needle Gauge Sets

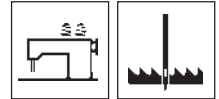

Nadelabstand / Size		Nadelhalter / Needle Clamp		Presserfuß Presser foot	Stichplatte Throat plate	Transporteur Feed dog
Zoll Inch	mm	Schraubbolzen Threaded chuck	Steckbolzen* Socket chuck*			
1/16	1,6	BD-3448/1A	BD-3448/1	BD-3448/2	BD-3448/3	BD-3448/4
3/32	2,4	BD-3449/1A	BD-3449/1	BD-3449/2	BD-3449/3	BD-3449/4
1/8	3,2	BD-3450/1A	BD-3450/1	BD-3450/2	BD-3450/3	BD-3450/4
5/32	4,0	BD-3451/1A	BD-3451/1	BD-3451/2	BD-3451/3	BD-3451/4
3/16	4,8	BD-3452/1A	BD-3452/1	BD-3452/2	BD-3452/3	BD-3452/4
7/32	5,6	BD-3453/1A	BD-3453/1	BD-3453/2	BD-3453/3	BD-3453/4
1/4	6,4	BD-3454/1A	BD-3454/1	BD-3454/2	BD-3454/3	BD-3454/4
9/32	7,1	BD-3455/1A	BD-3455/1	BD-3455/2	BD-3455/3	BD-3455/4
5/16	7,9	BD-3456/1A	BD-3456/1	BD-3456/2	BD-3456/3	BD-3456/4
11/32	8,7	BD-3457/1A	BD-3457/1	BD-3457/2	BD-3457/3	BD-3457/4
3/8	9,5	BD-3458/1A	BD-3458/1	BD-3458/2	BD-3458/3	BD-3458/4
7/16	11,1	BD-3459/1A	BD-3459/1	BD-3459/2	BD-3459/3	BD-3459/4
1/2	12,7	BD-3460/1A	BD-3460/1	BD-3460/2	BD-3460/3	BD-3460/4
9/16	14,3	BD-3461/1A	BD-3461/1	BD-3461/2	BD-3461/3	BD-3461/4
5/8	15,9	BD-3462/1A	BD-3462/1	BD-3462/2	BD-3462/3	BD-3462/4
3/4	19,1	BD-3463/1A	BD-3463/1	BD-3463/2	BD-3463/3	BD-3463/4
7/8	22,2	BD-3464/1A	BD-3464/1	BD-3464/2	BD-3464/3	BD-3464/4
1	25,4	BD-3465/1A	BD-3465/1	BD-3465/2	BD-3465/3	BD-3465/4
1-1/8	28,6	BD-3466/1A	BD-3466/1	BD-3466/2	BD-3466/3	BD-3466/4
1-1/4	31,8	BD-3467/1A	BD-3467/1	BD-3467/2	BD-3467/3	BD-3467/4
1-3/8	34,9	BD-3468/1A	BD-3468/1	BD-3468/2	BD-3468/3	BD-3468/4
1-1/2	38,1	BD-3469/1A	BD-3469/1	BD-3469/2	BD-3469/3	BD-3469/4
1-5/8	41,3	BD-3470/1A	BD-3470/1	BD-3470/2	BD-3470/3	BD-3470/4
1-3/4	44,5	BD-3471/1A	BD-3471/1	BD-3471/2	BD-3471/3	BD-3471/4

*Geeignet für Maschinen mit Steckaufnahme in der Nadelstange, z. B. für Dürkopp Kl. 249, Singer Kl. 112W140, 112W145, etc.

*Suitable for machines with socket chuck needle bars, e.g. for Dürkopp Cl. 249, Singer Cl. 112W140, 112W145, etc.

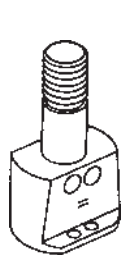

BD-3452/1A

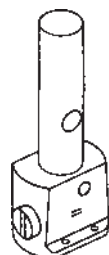

BD-3458/1

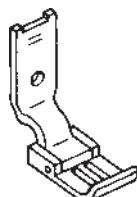

BD-3452/2

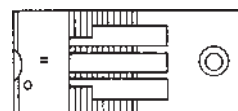

BD-3458/3

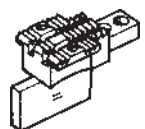

BD-3458/4

Nadelhalter Needle Clamps

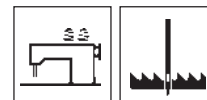

Nadelhalterpaar für Standard-Zweinadel-Maschinen
Needle Clamp Pair for Standard Double Needle Machines

Nadelabstand / Size		Nadelhalter Needle Clamp (Paar / pair)
Zoll Inch	mm	
1/8	3,2	BD-3450/380
3/16	4,8	BD-3452/380
1/4	6,4	BD-3454/380
5/16	7,9	BD-3456/380
3/8	9,5	BD-3458/380
1/2	12,7	BD-3460/380
5/8	15,9	BD-3462/380
3/4	19,1	BD-3463/380
7/8	22,2	BD-3464/380

Geeignet für Maschinen mit einzeln hochstellbarer Nadel, z.B. für
Consew Kl. 327 RB, Dürkopp Kl. 380, Seiko Kl. LSW-27

Suitable for machines with individual raiseable needles, e.g. for
Consew Cl. 327 RB, Dürkopp Cl. 380, Seiko Cl. LSW-27

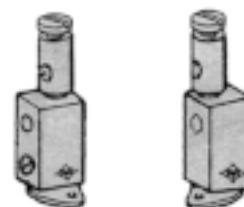

BD-3454/380

Flip-up - Nadelhalter Flip-up Needle Clamp



Nadelabstand / Size		Artikelnummer Part No.
Zoll Inch	mm	
1/8	3,2	BD-3403
3/16	4,8	BD-3405
1/4	6,4	BD-3407
5/16	7,9	BD-3408
3/8	9,5	BD-3409
1/2	12,7	BD-3411

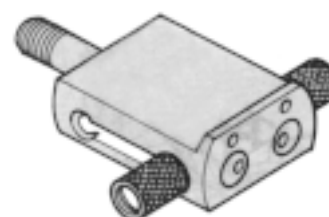

BD-3409

Passend für Maschinenklassen: s. Seite 1.1 - 2
Suitable for machine classes: see page 1.1 - 2

Nadelstangen
Needle Bars

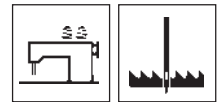

Nadelstange für Standard-Zweinadel-Maschinen
Needle Bar for Standard Double Needle Machines

Bemerkung <i>Remark</i>	Artikelnummer <i>Part No.</i>
mit Steckaufnahme <i>with socket connection</i>	B223686
mit Schraubaufnahme <i>with threaded connection</i>	B267267

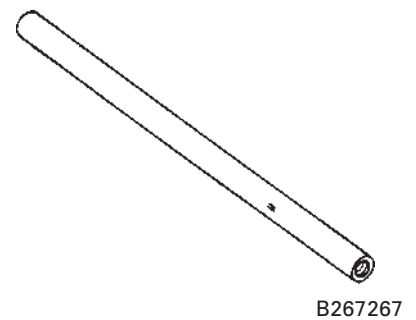
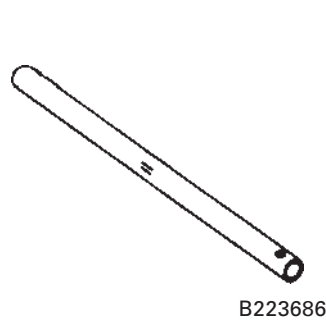

Nähfüße
Presser Feet

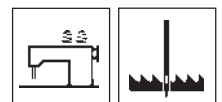

Zweinadelfuß mit Kantenanschlag rechts, für feine Materialien
Double Needle Foot with right guide, for fine materials

Nadelabstand / <i>Size</i>		Artikelnummer <i>Part No.</i>
Zoll <i>Inch</i>	mm	
1/8	3,2	B212GT-1/8
3/16	4,8	B212GT-3/16
1/4	6,4	B212GT-1/4
5/16	7,9	B212GT-5/16
3/8	9,5	B212GT-3/8

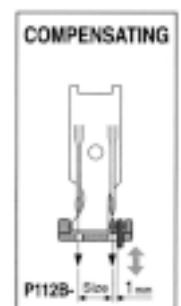

Nähfüße Presser Feet

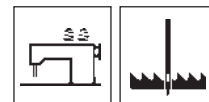

Zweinadelfuß mit Kantenanschlag links, für feine Materialien
Double Needle Foot with left guide, for fine materials

Nadelabstand / Size		Artikelnummer Part No.
Zoll Inch	mm	
3/16	4,8	B212GL-3/16
1/4	6,4	B212GL-1/4
5/16	7,9	B212GL-5/16
3/8	9,5	B212GL-3/8

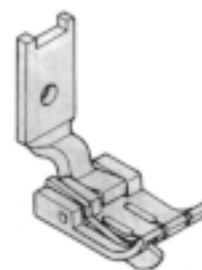

B212GL-1/4

Zweinadelfuß mit Kantenanschlag rechts, für Jeansstoffe
Double Needle Foot with right guide, for jeans materials

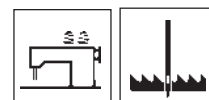

Nadelabstand / Size		Artikelnummer Part No.
Zoll Inch	mm	
1/8	3,2	B212G-1/8
3/16	4,8	B212G-3/16
1/4	6,4	B212G-1/4
5/16	7,9	B212G-5/16
3/8	9,5	B212G-3/8



B212G-1/4

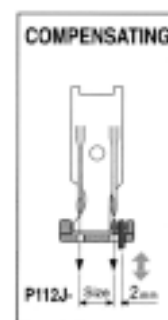

Nähfüße
Presser Feet

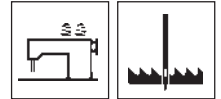

Zweinadel-Presserfuß mit Teflonsohle
Double Needle Presser Foot with Teflon Sole

Nadelabstand / Size		Artikelnummer <i>Part No.</i>
Zoll <i>Inch</i>	mm	
1/4	6,4	B605-112-1/4



B605-112-1/4

Schlaufenfaltefuß
Loop Folding Foot

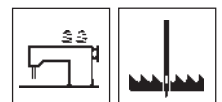

Nadelabstand / Size		Artikelnummer <i>Part No.</i>
Zoll <i>Inch</i>	mm	
3/16	4,8	BAT112-3/16
1/4	6,4	BAT112-1/4



BAT112-1/4

Nähfüße Presser Feet

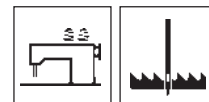

Zweinadel-Ausgleichsfuß
Double Needle Compensating Foot

Nadelabstand / Size		Artikelnummer Part No.
Zoll Inch	mm	
1/4	6,4	B112WC-9x1-1/4



B112WC-9x1-1/4

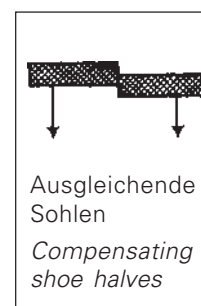

Schieberplatte für Standard-Zweinadel-Maschinen Slide Plate for Standard Double Needle Machines

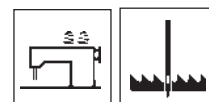

Bemerkung Remark	Artikelnummer Part No.
rechts right	B223852
links left	B223853
zur Apparatebefestigung for attachment fixation	B224144

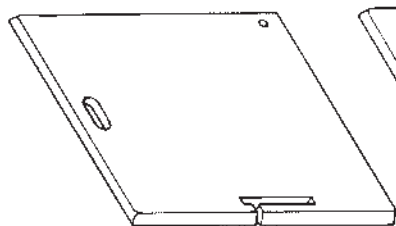

B223852

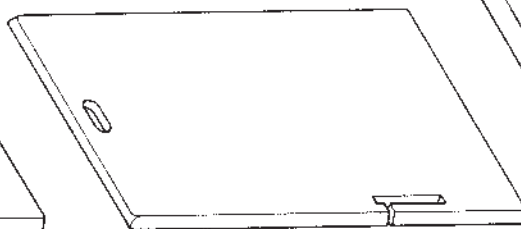

B223853

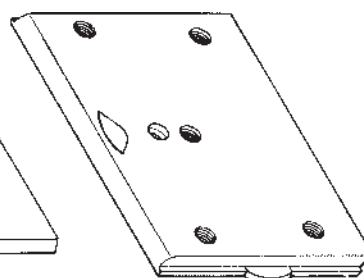

B224144

1: NÄHEN SEWING

1.4 UMLAUF- UND CB-GREIFER, RINGSCHIFFCHEN, SPULENKAPSELN UND SPULEN *ROTARY HOOKS, CB-SHUTTLES, BEAK SHUTTLES, BOBBIN CASES AND BOBBINS*

In diesem Kapitel finden Sie ausschließlich Umlauf- und CB-Greifer sowie Ringschiffchen, Spulenkapseln und Spulen.

Kettenstichgreifer finden Sie in den Kapiteln 1.5, 1.6 und 1.7.

Die Struktur der Teilenummern in diesem Kapitel ist wie folgt:

BD-3528*i* = Kennung für Greifer und Spulenkapseln aus italienischer Produktion

BD-3365*A* = Spulenkapsel mit Spulenbremsfeder

BD-3385*AL*/1 = Aluminiumspulen

This chapter includes rotary hooks, cb-shuttles, beak shuttles, bobbin cases and bobbins only.

You will find loopers for your machines in chapter 1.5, 1.6 and 1.7.

The structure of the item-numbers mentioned in this chapter is as follows:

BD-3528*i* = Hooks and bobbin cases of italian production

BD-3365*A* = bobbin case with break spring

BD-3385*AL*/1 = Bobbin made of aluminum

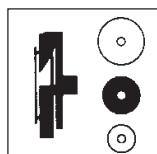
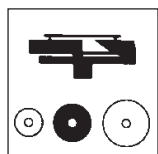

ADLER

siehe DUERKOPP - A D L E R / refer to DUERKOPP - A D L E R

ALTIN (Textima)

Klasse Class	Greifer / Hook		Spulenkapsel / Bobbin Case		Spule / Bobbin	
	Original-Nr. genuine no.	Artikelnummer Item number	Original-Nr. genuine no.	Artikelnummer Item number	Original-Nr. genuine no.	Artikelnummer Item number
8332	84270226	B84270226i	84020266	B84020266i	84003260	BD-3385
8334	84270232	B84270232i	84020266	B84020266i	84003260	BD-3385

BROTHER

Klasse Class	Greifer / Hook		Spulenkapsel / Bobbin Case		Spule / Bobbin	
	Original-Nr. genuine no.	Artikelnummer Item number	Original-Nr. genuine no.	Artikelnummer Item number	Original-Nr. genuine no.	Artikelnummer Item number
BAS-23	153131-901	BD-3628 BD-3628i	148350-101	BD-3365A BD-3365Ai	146290-001	BD-3385AL/1
BAS-301	148846-001	B148846-001	148350-101	BD-3365A BD-3365Ai	146290-001	BD-3385AL/1
BAS-302	153131-901	BD-3628 BD-3628i	148350-101	BD-3365A BD-3365Ai	146290-001	BD-3385AL/1
BAS-400	112041-901	BD-3270B	117596-001	BD-3342 BD-3342i	100376-001	BD-3385
BAS-400	112041-901	BD-3270B	117596-001NBL	BD-3342A	100376-001	BD-3385
BAS-500	159155-901	BD-3313B	143986-101	BD-3370A	159158-001	BD-3652AL
BAS-510	S19893-901	BD-3313C	143986-101	BD-3370A	159158-001	BD-3652AL
DB1-B760-5	112272-001	BDA1-A	100369-001 100369-001	BD-3365 BD-3365i	117132-001	BD-3619A
DB2-B705	153131-901	BD-3628 BD-3628i	148350-101	BD-3365A BD-3365Ai	146290-001	BD-3385AL/1
DB2-B705-1	153131-001	BD-3628 BD-3628i	148350-101	BD-3365A BD-3365Ai	146290-001	BD-3385AL/1
DB2-B705-3	153131-001	BD-3628 BD-3628i	148350-101	BD-3365A BD-3365Ai	146290-001	BD-3385AL/1
DB2-B705-5	153131-001	BD-3628 BD-3628i	148350-101	BD-3365A BD-3365Ai	146290-001	BD-3385AL/1
DB2-B706-3	116780-001	BD-3282 BD-3282i	100369-001	BD-3365 BD-3365i	117132-001	BD-3619A
DB2-B706-5	111275-901	BD-3283	100369-001 100369-001	BD-3365 BD-3365i	117132-001	BD-3619A
DB2-B707-3	153131-901	BD-3628 BD-3628i	148350-101	BD-3365A BD-3365Ai	146290-001	BD-3385AL/1
DB2-B707-3-0	153131-001	BD-3628 BD-3628i	148350-101	BD-3365A BD-3365Ai	146290-001	BD-3385AL/1
DB2-B707-5	148846-001	B148846-001	148350-101	BD-3365A BD-3365Ai	146290-001	BD-3385AL/1
DB2-B714-3	116780-001	BD-3282 BD-3282i	100369-001	BD-3365 BD-3365i	117132-001	BD-3619A

1.4

UMLAUF- UND CB-GREIFER, RINGSCHIFFCHEN, SPULENKAPSELN UND SPULEN ROTARY HOOKS, CB-SHUTTLES, BEAK SHUTTLES, BOBBIN CASES AND BOBBINS

BROTHER						
Klasse Class	Greifer / Hook		Spulenkapsel / Bobbin Case		Spule / Bobbin	
	Original-Nr. <i>genuine no.</i>	Artikelnummer <i>Item number</i>	Original-Nr. <i>genuine no.</i>	Artikelnummer <i>Item number</i>	Original-Nr. <i>genuine no.</i>	Artikelnummer <i>Item number</i>
DB2-B714-5	111275-901	BD-3283	100369-001	BD-3365 BD-3365i	117132-001	BD-3619A
DB2-B715-1	153131-901	BD-3628 BD-3628i	148350-101	BD-3365A BD-3365Ai	146290-001	BD-3385AL/1
DB2-B715-3	153131-001	BD-3628 BD-3628i	148350-101	BD-3365A BD-3365Ai	146290-001	BD-3385AL/1
DB2-B715-5	148846-001	B148846-001	148350-101	BD-3365A BD-3365Ai	146290-001	BD-3385AL/1
DB2-B716-1	153131-001	BD-3628 BD-3628i	148350-101	BD-3365A BD-3365Ai	146290-001	BD-3385AL/1
DB2-B716-3	153131-001	BD-3628 BD-3628i	148350-101	BD-3365A BD-3365Ai	146290-001	BD-3385AL/1
DB2-B716-5	148846-001	B148846-001	148350-101	BD-3365A BD-3365Ai	146290-001	BD-3385AL/1
DB2-B737-3	S02603-001	BD-3630 BD-3630i	148350-101	BD-3365A BD-3365Ai	146290-001	BD-3385AL/1
DB2-B737-5	148846-001	B148846-001	148350-101	BD-3365A BD-3365Ai	146290-001	BD-3385AL/1
DB2-B738-3	S02603-001	BD-3630 BD-3630i	148350-101	BD-3365A BD-3365Ai	146290-001	BD-3385AL/1
DB2-B738-5	148846-001	B148846-001	148350-101	BD-3365A BD-3365Ai	146290-001	BD-3385AL/1
DB2-B755-3	116780-001	BD-3282 BD-3282i	100369-001	BD-3365 BD-3365i	117132-001	BD-3619A
DB2-B755-5	111275-901	BD-3283	100369-001	BD-3365 BD-3365i	117132-001	BD-3619A
DB2-B757-103	153131-001	BD-3628 BD-3628i	148350-101	BD-3365A BD-3365Ai	146290-001	BD-3385AL/1
DB2-B757-105	153131-001	BD-3628 BD-3628i	148350-101	BD-3365A BD-3365Ai	146290-001	BD-3385AL/1
DB2-B757-3	116780-001	BD-3282 BD-3282i	100369-001	BD-3365 BD-3365i	117132-001	BD-3619A
DB2-B757-3-0	153131-001	BD-3628 BD-3628i	148350-101	BD-3365A BD-3365Ai	146290-001	BD-3385AL/1
DB2-B757-5	116780-001	BD-3282 BD-3282i	100369-001	BD-3365 BD-3365i	117132-001	BD-3619A
DB2-B758	116780-001	BD-3282 BD-3282i	100369-001	BD-3365 BD-3365i	117132-001	BD-3619A
DB2-B767	112272-001	BDA1-A	100369-001	BD-3365 BD-3365i	117132-001	BD-3619A
DB2-B771	143784-901	BD-3283A	100369-001	BD-3365 BD-3365i	117132-001	BD-3619A
DB2-B774	S02603-001	BD-3630 BD-3630i	148350-101	BD-3365A BD-3365Ai	146290-001	BD-3385AL/1
DB2-B778	S02603-001	BD-3630 BD-3630i	148350-101	BD-3365A BD-3365Ai	146290-001	BD-3385AL/1
DB2-B781	116780-001	BD-3282 BD-3282i	100369-001	BD-3365 BD-3365i	117132-001	BD-3619A
DB2-B781-103	153131-001	BD-3628 BD-3628i	148350-101	BD-3365A BD-3365Ai	146290-001	BD-3385AL/1
DB2-B781-104	153131-001	BD-3628 BD-3628i	148350-101	BD-3365A BD-3365Ai	146290-001	BD-3385AL/1
DB2-B781-204	153131-001	BD-3628 BD-3628i	148350-101	BD-3365A BD-3365Ai	146290-001	BD-3385AL/1

BROTHER						
Klasse Class	Greifer / Hook		Spulenkapsel / Bobbin Case		Spule / Bobbin	
	Original-Nr. genuine no.	Artikelnummer Item number	Original-Nr. genuine no.	Artikelnummer Item number	Original-Nr. genuine no.	Artikelnummer Item number
DB2-B781-3	116780-001	BD-3282 BD-3282i	100369-001	BD-3365 BD-3365i	117132-001	BD-3619A
DB2-B781-3-0	153131-001	BD-3628 BD-3628i	148350-101	BD-3365A BD-3365Ai	146290-001	BD-3385AL/1
DB2-B790-205	148846-001	B148846-001	148350-101	BD-3365A BD-3365Ai	146290-001	BD-3385AL/1
DB2-B790-3	143784-901	BD-3283A	100369-001	BD-3365 BD-3365i	117132-001	BD-3619A
DB2-B790-5-0	148846-001	B148846-001	148350-101	BD-3365A BD-3365Ai	146290-001	BD-3385AL/1
DB2-B790-505	148846-001	B148846-001	148350-101	BD-3365A BD-3365Ai	146290-001	BD-3385AL/1
DB2-B790-605	148846-001	B148846-001	148350-101	BD-3365A BD-3365Ai	146290-001	BD-3385AL/1
DB2-B791-3	143784-901	BD-3283A	100369-001	BD-3365 BD-3365i	117132-001	BD-3619A
DB2-B791-5-0	148846-001	B148846-001	148350-101	BD-3365A BD-3365Ai	146290-001	BD-3385AL/1
DB2-B792-3	116780-001	BD-3282 BD-3282i	100369-001	BD-3365 BD-3365i	117132-001	BD-3619A
DB2-B792-3-0	153131-001	BD-3628 BD-3628i	148350-101	BD-3365A BD-3365Ai	146290-001	BD-3385AL/1
DB2-B792-400	153131-001	BD-3628 BD-3628i	148350-101	BD-3365A BD-3365Ai	146290-001	BD-3385AL/1
DB2-B793-3	116780-001	BD-3282 BD-3282i	100369-001	BD-3365 BD-3365i	117132-001	BD-3619A
DB2-B793-303	153131-001	BD-3628 BD-3628i	148350-101	BD-3365A BD-3365Ai	146290-001	BD-3385AL/1
DB2-B793-305	153131-001	BD-3628 BD-3628i	148350-101	BD-3365A BD-3365Ai	146290-001	BD-3385AL/1
DB2-B795-013	116780-001	BD-3282 BD-3282i	100369-001	BD-3365 BD-3365i	117132-001	BD-3619A
DB2-B795-313	153131-001	BD-3628 BD-3628i	148350-101	BD-3365A BD-3365Ai	146290-001	BD-3385AL/1
DB2-DD7000	S02603-001	BD-3630 BD-3630i	148350-101	BD-3365A BD-3365Ai	146290-001	BD-3385AL/1
LE2-B861	117677-001	BD-3270 BD-3270i	117596-001	BD-3342 BD-3342i	146290-001	BD-3385AL/1
LE2-B861	117677-001	BD-3270 BD-3270i	117596-001NBL	BD-3342A	146290-001	BD-3385AL/1
LE2-B861-7	112041-901	BD-3270B	117596-001	BD-3342 BD-3342i	146290-001	BD-3385AL/1
LE2-B861-7	112041-901	BD-3270B	117596-001NBL	BD-3342A	146290-001	BD-3385AL/1
LH4-B814	143986-001	BD-3313A BD-3313Ai	143986-101	BD-3370A	146025-001	BD-3652BAL
LH4-B815	159155-901	BD-3313B	143986-101	BD-3370A	146025-001	BD-3652BAL
LH4-B816	S19893-901	BD-3313C	143986-101	BD-3370A	146025-001	BD-3652BAL
LH4-B817	S33032-901	BD-3313D	143986-101	BD-3370A	146025-001	BD-3652BAL
LK3 -B430	152685-001	BSH430	159610-101	BD-3340	159613-001	BD-3400BAL

1.4

UMLAUF- UND CB-GREIFER, RINGSCHIFFCHEN, SPULENKAPSELN UND SPULEN ROTARY HOOKS, CB-SHUTTLES, BEAK SHUTTLES, BOBBIN CASES AND BOBBINS

BROTHER						
Klasse Class	Greifer / Hook		Spulenkapsel / Bobbin Case		Spule / Bobbin	
	Original-Nr. genuine no.	Artikelnummer Item number	Original-Nr. genuine no.	Artikelnummer Item number	Original-Nr. genuine no.	Artikelnummer Item number
LK3-B430-1	152685-001	BSH430	159610-101	BD-3340	159613-001	BD-3400BAL
LK3-B430-2	152687-001	BSH430a	159610-101	BD-3340	159613-001	BD-3400BAL
LK3-B430-3	152687-001	BSH430a	159610-101	BD-3340	159613-001	BD-3400BAL
LK3-B430-4	152685-001	BSH430	159610-101	BD-3340	159613-001	BD-3400BAL
LK3-B430-5	152685-001	BSH430	159610-101	BD-3340	159613-001	BD-3400BAL
LK3-B430-6	152687-001	BSH430a	159610-101	BD-3340	159613-001	BD-3400BAL
LK3-B430-7	152687-001	BSH430a	159610-101	BD-3340	159613-001	BD-3400BAL
LK3-B430-8	152687-001	BSH430a	159610-101	BD-3340	159613-001	BD-3400BAL
LK3-B430-9	152687-001	BSH430a	159610-101	BD-3340	159613-001	BD-3400BAL
LK3-B431	152685-001	BSH430	159610-101	BD-3340	159613-001	BD-3400BAL
LK3-B432	152685-001	BSH430	159610-101	BD-3340	159613-001	BD-3400BAL
LK3-B433	152687-001	BSH430a	159610-101	BD-3340	159613-001	BD-3400BAL
LK3-B434	152687-001	BSH430a	159610-101	BD-3340	159613-001	BD-3400BAL
LK3-B435	152687-001	BSH430a	159610-101	BD-3340	159613-001	BD-3400BAL
LK3-B436	152687-001	BSH430a	159610-101	BD-3340	159613-001	BD-3400BAL
LK3-B438	152687-001	BSH430a	159610-101	BD-3340	159613-001	BD-3400BAL
LK3-B441	152687-001	BSH430a	159610-101	BD-3340	159613-001	BD-3400BAL
LT2-B831-1	112691-001	BD-3300 BD-3300i			112781-001	BD-3386
LT2-B831-3	112691-001	BD-3300 BD-3300i			112781-001	BD-3386
LT2-B832-1	112691-001	BD-3300 BD-3300i			148603-001	BD-3386AL
LT2-B832-3	112691-001	BD-3300 BD-3300i			148603-001	BD-3386AL
LT2-B833	112691-001	BD-3300 BD-3300i			148603-001	BD-3386AL
LT2-B841-3	S07425-901	BD-3300A			148603-001	BD-3386AL
LT2-B842	S07427-901	BD-3300B			148603-001	BD-3386AL
LT2-B842-3	S07425-901	BD-3300A			148603-001	BD-3386AL
LT2-B847	S07425-901 S07427-901	BD-3300A BD-3300B			148603-001	BD-3386AL
LZ2-B852	S34847-901	BD-3318A	158471-001	BD-3372	158205-001	BD-3397AL

BROTHER						
Klasse Class	Greifer / Hook		Spulenkapsel / Bobbin Case		Spule / Bobbin	
	Original-Nr. genuine no.	Artikelnummer Item number	Original-Nr. genuine no.	Artikelnummer Item number	Original-Nr. genuine no.	Artikelnummer Item number
LZ2-B853	S34847-901	BD-3318A	158471-001	BD-3372	158205-001	BD-3397AL
LZ2-B854	S34847-901	BD-3318A	158471-001	BD-3372	158205-001	BD-3397AL
TZ1-B651	112041-901	BD-3270B	117596-001	BD-3342 BD-3342i	100376-001	BD-3385
TZ1-B651	112041-901	BD-3270B	117596-001NBL	BD-3342A	100376-001	BD-3385
TZ1-B652	112041-901	BD-3270B	117596-001	BD-3342 BD-3342i	100376-001	BD-3385
TZ1-B652	112041-901	BD-3270B	117596-001NBL	BD-3342A	100376-001	BD-3385

CONSEW						
Klasse Class	Greifer / Hook		Spulenkapsel / Bobbin Case		Spule / Bobbin	
	Original-Nr. genuine no.	Artikelnummer Item number	Original-Nr. genuine no.	Artikelnummer Item number	Original-Nr. genuine no.	Artikelnummer Item number
100	127119FG	BD-3268 BD-3268i	2110104-301C	BD-3365 BD-3365i	2110104-321	BD-3385
101	127119FG	BD-3268 BD-3268i	2110104-301C	BD-3365 BD-3365i	2110104-321	BD-3385
133A	279	BD-3270 BD-3270i	284	BD-3356B	2110104-321	BD-3385
139	10655	BD-3320 BD-3320i			10656	BD-3386
139R-1	10655	BD-3320 BD-3320i			10656	BD-3386
224	10655	BD-3320 BD-3320i			10656	BD-3386
224R-1	10655	BD-3320 BD-3320i			10656	BD-3386
225	10655	BD-3320 BD-3320i			10656	BD-3386
225VM	10655	BD-3320 BD-3320i			10656	BD-3386
225VMG	10655	BD-3320 BD-3320i			10656	BD-3386
226	10655	BD-3320 BD-3320i			10656	BD-3386
226R-2	10655	BD-3320 BD-3320i			10656	BD-3386
226RVM-2	10655	BD-3320 BD-3320i			10656	BD-3386
228	12032	B238250 B238250i			10656	BD-3386
228-11	12032	B238250 B238250i			10656	BD-3386
228R-1	12032	B238250 B238250i			10656	BD-3386
228R-11	12032	B238250 B238250i			10656	BD-3386

BROTHER						
Klasse Class	Greifer / Hook		Spulenkapsel / Bobbin Case		Spule / Bobbin	
	Original-Nr. genuine no.	Artikelnummer Item number	Original-Nr. genuine no.	Artikelnummer Item number	Original-Nr. genuine no.	Artikelnummer Item number
LZ2-B853	S34847-901	BD-3318A	158471-001	BD-3372	158205-001	BD-3397AL
LZ2-B854	S34847-901	BD-3318A	158471-001	BD-3372	158205-001	BD-3397AL
TZ1-B651	112041-901	BD-3270B	117596-001	BD-3342 BD-3342i	100376-001	BD-3385
TZ1-B651	112041-901	BD-3270B	117596-001NBL	BD-3342A	100376-001	BD-3385
TZ1-B652	112041-901	BD-3270B	117596-001	BD-3342 BD-3342i	100376-001	BD-3385
TZ1-B652	112041-901	BD-3270B	117596-001NBL	BD-3342A	100376-001	BD-3385

CONSEW						
Klasse Class	Greifer / Hook		Spulenkapsel / Bobbin Case		Spule / Bobbin	
	Original-Nr. genuine no.	Artikelnummer Item number	Original-Nr. genuine no.	Artikelnummer Item number	Original-Nr. genuine no.	Artikelnummer Item number
100	127119FG	BD-3268 BD-3268i	2110104-301C	BD-3365 BD-3365i	2110104-321	BD-3385
101	127119FG	BD-3268 BD-3268i	2110104-301C	BD-3365 BD-3365i	2110104-321	BD-3385
133A	279	BD-3270 BD-3270i	284	BD-3356B	2110104-321	BD-3385
139	10655	BD-3320 BD-3320i			10656	BD-3386
139R-1	10655	BD-3320 BD-3320i			10656	BD-3386
224	10655	BD-3320 BD-3320i			10656	BD-3386
224R-1	10655	BD-3320 BD-3320i			10656	BD-3386
225	10655	BD-3320 BD-3320i			10656	BD-3386
225VM	10655	BD-3320 BD-3320i			10656	BD-3386
225VMG	10655	BD-3320 BD-3320i			10656	BD-3386
226	10655	BD-3320 BD-3320i			10656	BD-3386
226R-2	10655	BD-3320 BD-3320i			10656	BD-3386
226RVM-2	10655	BD-3320 BD-3320i			10656	BD-3386
228	12032	B238250 B238250i			10656	BD-3386
228-11	12032	B238250 B238250i			10656	BD-3386
228R-1	12032	B238250 B238250i			10656	BD-3386
228R-11	12032	B238250 B238250i			10656	BD-3386

CONSEW						
Klasse Class	Greifer / Hook		Spulenkapsel / Bobbin Case		Spule / Bobbin	
	Original-Nr. genuine no.	Artikelnummer Item number	Original-Nr. genuine no.	Artikelnummer Item number	Original-Nr. genuine no.	Artikelnummer Item number
332 R	15875	BD-3300 BD-3300i			10656	BD-3386
332 R-1	15875	BD-3300 BD-3300i			10656	BD-3386
332 RK-1	15875	BD-3300 BD-3300i			10656	BD-3386
357	12032	B238250 B238250i			10656	BD-3386
357 R-1	12032	B238250 B238250i			10656	BD-3386
358	12032	B238250 B238250i			10656	BD-3386
358 R-1	12032	B238250 B238250i			10656	BD-3386
359	12032	B238250 B238250i			10656	BD-3386
359R-1	12032	B238250 B238250i			10656	BD-3386
722	279	BD-3270 BD-3270i	284	BD-3356B	2110104-321	BD-3385
733R	35224	BD-3323A BD-3323Ai			35226	BD-3380

DUERKOPP - A D L E R						
Klasse Class	Greifer / Hook		Spulenkapsel / Bobbin Case		Spule / Bobbin	
	Original-Nr. genuine no.	Artikelnummer Item number	Original-Nr. genuine no.	Artikelnummer Item number	Original-Nr. genuine no.	Artikelnummer Item number
30-1	030000594	BD-3321			030000610	BD-3381
37	037001514	BD-3331 BD-3331i	037001610	BD-3327	037001620	BD-3400
104	005001954	BD-3323 BD-3323i			005007420	BD-3378
105	005001954	BD-3323 BD-3323i			005007420	BD-3378
165	005002904	BD-3323A BD-3323Ai			005007420	BD-3378
166	005002904	BD-3323A BD-3323Ai			005007420	BD-3378
167 mit Gegenspitze / with gib	167150084	BD-3296i	167001784	BD-3345 BD-3345i	167001800	BD-3383
167 ohne Gegenspitze / without gib	167001814	BD-3298 BD-3298i	167001784	BD-3345 BD-3345i	167001800	BD-3383
167 FA ohne Gegenspitze / TC without gib	167150204	BD-3298A BD-3298Ai	167150194	BD-3345A BD-3345Ai	167152700	BD-3383AL
169	169001814	B169001814i	167001784	BD-3345 BD-3345i	167001800	BD-3383
196	396152814	BD-3289 BD-3289i	396150784	BD-3343i	061000560	BD-3385

1.4

UMLAUF- UND CB-GREIFER, RINGSCHIFFCHEN, SPULENKAPSELN UND SPULEN ROTARY HOOKS, CB-SHUTTLES, BEAK SHUTTLES, BOBBIN CASES AND BOBBINS

DUERKOPP - A D L E R						
Klasse Class	Greifer / Hook		Spulenkapsel / Bobbin Case		Spule / Bobbin	
	Original-Nr. genuine no.	Artikelnummer Item number	Original-Nr. genuine no.	Artikelnummer Item number	Original-Nr. genuine no.	Artikelnummer Item number
196	396152814	BD-3289 BD-3289i	396150824	BD-3343Ai	204000230A	BD-3385AL
199	199152814	BD-3270 BD-3270i	089001784	BD-3342 BD-3342i	061000560	BD-3385
220	220001814	BD-3299			220001800	BD-3384
265	265211423	BD-3316			021001510	B97949
267 mit Gegenspitze / with gib	167150084	BD-3296i	167001784	BD-3345 BD-3345i	167001800	BD-3383
267 ohne Gegenspitze / without gib	167001814	BD-3298 BD-3298i	167001784	BD-3345 BD-3345i	167001800	BD-3383
267 FA ohne Gegenspitze / TC without gib	167150204	BD-3298A BD-3298Ai	167150194	BD-3345A BD-3345Ai	167152700	BD-3383AL
268 mit Gegenspitze / with gib	167150084	BD-3296i	167001784	BD-3345 BD-3345i	167001800	BD-3383
268 ohne Gegenspitze / without gib	167001814	BD-3298 BD-3298i	167001784	BD-3345 BD-3345i	167001800	BD-3383
269	169001814	B169001814i	167001784	BD-3345 BD-3345i	167001800	BD-3383
289	199152814	BD-3270 BD-3270i	089001784	BD-3342 BD-3342i	061000560	BD-3385
296	396152814	BD-3289 BD-3289i	396150784	BD-3343i	061000560	BD-3385
296	396152814	BD-3289 BD-3289i	396150824	BD-3343Ai	204000230A	BD-3385AL
396	396152814	BD-3289 BD-3289i	396150784	BD-3343i	061000560	BD-3385
396	396152814	BD-3289 BD-3289i	396150824	BD-3343Ai	204000230A	BD-3385AL
396H	396150814	BD-3290 BD-3290i	396150824	BD-3343Ai	204000230A	BD-3385AL
467	467150014	B467150014			167001800	BD-3383
467 FA/ TC	467150094 467150494 467150854	B467150094 B467150494 B467150854			245001660A	BD-3402AL
489	199152814	BD-3270 BD-3270i	089001784	BD-3342 BD-3342i	061000560	BD-3385
767	467150014	B467150014			167001800	BD-3383
767 FA/ TC	467150094 467150494 467150854	B467150094 B467150494 B467150854			245001660A	BD-3402AL

DUERKOPP-ADLER						
Klasse Class	Greifer / Hook		Spulenkapsel / Bobbin Case		Spule / Bobbin	
	Original-Nr. genuine no.	Artikelnummer Item number	Original-Nr. genuine no.	Artikelnummer Item number	Original-Nr. genuine no.	Artikelnummer Item number
203	204325	BD-3267i	204335	BD-3365 BD-3365i	204230	BD-3385
204	204325	BD-3267i	204335	BD-3365 BD-3365i	204230	BD-3385
205	204325	BD-3267i	204335	BD-3365 BD-3365i	204230	BD-3385
206	204695	BD-3268 BD-3268i	204335	BD-3365 BD-3365i	204230	BD-3385
207	204695	BD-3268 BD-3268i	204335	BD-3365 BD-3365i	204230	BD-3385
211	2111102	BD-3284i	2111115	BD-3348i	204230	BD-3385
211	211912	BD-3285	211926	BD-3349	204230	BD-3385
211 FA / TC	2111102	BD-3284i	2111115a	BD-3348A BD-3348BAi	204230A	BD-3385AL
211 FA / TC	211912	BD-3285	21110772	BD-3349A	204230A	BD-3385AL
212	2111102	BD-3284i	2111115	BD-3348i	204230	BD-3385
212 FA / TC	2111102	BD-3284i	2111115a	BD-3348A BD-3348BAi	204230A	BD-3385AL
213	2111102	BD-3284i	2111115	BD-3348i	204230	BD-3385
214	2111102	BD-3284i	2111115	BD-3348i	204230	BD-3385
215	2111102	BD-3284i	2111115	BD-3348i	204230	BD-3385
218	2111102	BD-3284i	2111115	BD-3348i	204230	BD-3385
221	249624	BD-3301	249369	BD-3616	249372	BD-3387
221	249591	BD-3315			249378	BD-3386
222	249624	BD-3301	249369	BD-3616	249372	BD-3387
222	249591	BD-3315			249378	BD-3386
237	249624	BD-3301	249369	BD-3616	249372	BD-3387
237	249591	BD-3315			249378	BD-3386
238	249624	BD-3301	249369	BD-3616	249372	BD-3387
238	249591	BD-3315			249378	BD-3386
239	249624	BD-3301	249369	BD-3616	249372	BD-3387
239	249591	BD-3315			249378	BD-3386
241	249624	BD-3301	249369	BD-3616	249372	BD-3387
241	249591	BD-3315			249378	BD-3386

1.4

UMLAUF- UND CB-GREIFER, RINGSCHIFFCHEN, SPULENKAPSELN UND SPULEN
 ROTARY HOOKS, CB-SHUTTLES, BEAK SHUTTLES, BOBBIN CASES AND BOBBINS

DUERKOPP-ADLER						
Klasse Class	Greifer / Hook		Spulenkapsel / Bobbin Case		Spule / Bobbin	
	Original-Nr. <i>genuine no.</i>	Artikelnummer <i>Item number</i>	Original-Nr. <i>genuine no.</i>	Artikelnummer <i>Item number</i>	Original-Nr. <i>genuine no.</i>	Artikelnummer <i>Item number</i>
242	249624	BD-3301	249369	BD-3616	249372	BD-3387
242	249591	BD-3315			249378	BD-3386
245	249624	BD-3301	249369	BD-3616	245001660A	BD-3402AL
245	249591	BD-3315			249378	BD-3386
249	249624	BD-3301	249369	BD-3616	249372	BD-3387
249	249591	BD-3315			249378	BD-3386
252	252781	BD-3313 BD-3313i	252368	BD-3370 BD-3370i	251277	BD-3397
253	252781	BD-3313 BD-3313i	252368	BD-3370 BD-3370i	251277	BD-3397
254	252781	BD-3313 BD-3313i	252368	BD-3370 BD-3370i	251277	BD-3397
255	252781	BD-3313 BD-3313i	252368	BD-3370 BD-3370i	251277	BD-3397
264	252781	BD-3313 BD-3313i	252368	BD-3370 BD-3370i	251277	BD-3397
265	26512787	BD-3286i	2111115	BD-3348i	204230	BD-3385
265 FA / TC	26512787	BD-3286i	2111115a	BD-3348BAi	204230A	BD-3385AL
265-203	26512322	B265-12322i	2111115a	BD-3348A BD-3348BAi	204230A	BD-3385AL
265, 265-203 ohne FA / <i>without</i> TC			2111115 <i>offen / open</i>	BD-3348i		
265-108	265-771	BD-3286B	265776	BD-3354	265790	BD-3391
265-208	265-771	BD-3286B	265776	BD-3354	265790	BD-3391
265-301	265-771	BD-3286B	265772	BD-3354A	265789A	BD-3391AL
265-305	265-771	BD-3286B	265772	BD-3354A	265789A	BD-3391AL
270	204695	BD-3268 BD-3268i	204335	BD-3365 BD-3365i	204230	BD-3385
271	271751	B271-751 B271-753i	2111115a 271771	BD-3348A B271-771Ai	204230A	BD-3385AL
271	271150124	B271150124	271150144	B271150144	204230A	BD-3385AL
271	2711024	B271-1024i	2711034	B271-1034i	245001660A	BD-3402AL
272	2721123	B272-1123i	271771	B271-771Ai	204230A	BD-3385AL
380	249624	BD-3301	249369	BD-3616	249372	BD-3387
380	249591	BD-3315			249378	BD-3386
541	249624	BD-3301	249369	BD-3616	249372	BD-3387

DUERKOPP-ADLER						
Klasse Class	Greifer / Hook		Spulenkapsel / Bobbin Case		Spule / Bobbin	
	Original-Nr. genuine no.	Artikelnummer Item number	Original-Nr. genuine no.	Artikelnummer Item number	Original-Nr. genuine no.	Artikelnummer Item number
541	249591	BD-3315			249378	BD-3386
542	249624	BD-3301	249369	BD-3616	249372	BD-3387
542	249591	BD-3315			249378	BD-3386
543	249624	BD-3301	249369	BD-3616	249372	BD-3387
543	249591	BD-3315			249378	BD-3386
549	249624	BD-3301	249369	BD-3616	249372	BD-3387
549	249591	BD-3315			249378	BD-3386
560	5701242	BD-3337i	5701243a	BD-3341i	5701015	BD-3400CAL
570	5701242	BD-3337i	5701243a	BD-3341i	5701015	BD-3400CAL

JUKI						
Klasse Class	Greifer / Hook		Spulenkapsel / Bobbin Case		Spule / Bobbin	
	Original-Nr. genuine no.	Artikelnummer Item number	Original-Nr. genuine no.	Artikelnummer Item number	Original-Nr. genuine no.	Artikelnummer Item number
ACF-161-981	B1818-280-000	BD-3334A BD-3334Ai	B1828-980-OAO	BD-3617 BD-3617i	B1827-280-000	BD-3642AL
ADU-1852	B1830-555-DAC	BD-3292i	D1837-555-BAA	BD-3365A BD-3365Ai	B9117-012-000	BD-3619A
ADU-1853	B1830-555-DAC	BD-3292i	D1837-555-BAA	BD-3365A BD-3365Ai	B9117-012-000	BD-3619A
ADU-1854	B1830-555-DAC	BD-3292i	D1837-555-BAA	BD-3365A BD-3365Ai	B9117-012-000	BD-3619A
ADU-332	B1830-555-DAC	BD-3292i	D1837-555-BAA	BD-3365A BD-3365Ai	B9117-012-000	BD-3619A
ADU-992	B1830-555-DAC	BD-3292i	D1837-555-BAA	BD-3365A BD-3365Ai	B9117-012-000	BD-3619A
AMS-210A	B1818-280-000	BD-3334A BD-3334Ai	B1828-980-OAO	BD-3617 BD-3617i	B1827-280-000	BD-3642AL
AMS-212A	B1818-280-000	BD-3334A BD-3334Ai	B1828-980-OAO	BD-3617 BD-3617i	B1827-280-000	BD-3642AL
DDL-115	B1830-009-OAO	BD-3268 BD-3268i	B1837-012-OAO	BD-3365 BD-3365i	B9117-012-000	BD-3619A
DDL-127	B1830-127-OAO	BD-3282 BD-3282i	B1837-012-OAO	BD-3365 BD-3365i	B9117-012-000	BD-3619A
DDL-227	B1830-127-OAO	BD-3282 BD-3282i	B1837-012-OAO	BD-3365 BD-3365i	B9117-012-000	BD-3619A
DDL-227A	B1830-127-OAO	BD-3282 BD-3282i	B1837-012-OAO	BD-3365 BD-3365i	B9117-012-000	BD-3619A
DDL-227M	B1830-127-OAO	BD-3282 BD-3282i	B1837-012-OAO	BD-3365 BD-3365i	B9117-012-000	BD-3619A
DDL-227W	B1830-127-OAO	BD-3282 BD-3282i	B1837-012-OAO	BD-3365 BD-3365i	B9117-012-000	BD-3619A

1.4

UMLAUF- UND CB-GREIFER, RINGSCHIFFCHEN, SPULENKAPSELN UND SPULEN ROTARY HOOKS, CB-SHUTTLES, BEAK SHUTTLES, BOBBIN CASES AND BOBBINS

JUKI						
Klasse Class	Greifer / Hook		Spulenkapsel / Bobbin Case		Spule / Bobbin	
	Original-Nr. genuine no.	Artikelnummer Item number	Original-Nr. genuine no.	Artikelnummer Item number	Original-Nr. genuine no.	Artikelnummer Item number
DDL-500	B1830-555-BAO	BD-3292 BD-3304i	D1837-555-BAA	BD-3365A BD-3365Ai	B9117-012-000	BD-3619A
DDL-500A	B1830-555-BAO	BD-3292 BD-3304i	D1837-555-BAA	BD-3365A BD-3365Ai	B9117-012-000	BD-3619A
DDL-501	B1830-555-BAO	BD-3292 BD-3304i	D1837-555-BAA	BD-3365A BD-3365Ai	B9117-012-000	BD-3619A
DDL-501A	B1830-555-BAO	BD-3292 BD-3304i	D1837-555-BAA	BD-3365A BD-3365Ai	B9117-012-000	BD-3619A
DDL-505	B1830-555-BAO	BD-3292 BD-3304i	D1837-555-BAA	BD-3365A BD-3365Ai	B9117-012-000	BD-3619A
DDL-506	B1830-555-BAO	BD-3292 BD-3304i	D1837-555-BAA	BD-3365A BD-3365Ai	B9117-012-000	BD-3619A
DDL-541	B1830-127-OAO	BD-3282 BD-3282i	B1837-012-OAO	BD-3365 BD-3365i	B9117-012-000	BD-3619A
DDL-541W	B1830-127-OAO	BD-3282 BD-3282i	B1837-012-OAO	BD-3365 BD-3365i	B9117-012-000	BD-3619A
DDL-542	B1830-127-OAO	BD-3282 BD-3282i	B1837-012-OAO	BD-3365 BD-3365i	B9117-012-000	BD-3619A
DDL-543	B1830-127-OAO	BD-3282 BD-3282i	B1837-012-OAO	BD-3365 BD-3365i	B9117-012-000	BD-3619A
DDL-545	B1830-127-OAO	BD-3282 BD-3282i	B1837-012-OAO	BD-3365 BD-3365i	B9117-012-000	BD-3619A
DDL-545W	B1830-127-OAO	BD-3282 BD-3282i	B1837-012-OAO	BD-3365 BD-3365i	B9117-012-000	BD-3619A
DDL-552-2	B1830-555-BAO	BD-3292 BD-3304i	D1837-555-BAA	BD-3365A BD-3365Ai	B9117-012-000	BD-3619A
DDL-555	B1830-127-OAO	BD-3282 BD-3282i	B1837-012-OAO	BD-3365 BD-3365i	B9117-012-000	BD-3619A
DDL-555-2	B1830-555-BAO	BD-3292 BD-3304i	D1837-555-BAA	BD-3365A BD-3365Ai	B9117-012-000	BD-3619A
DDL-555-2T	B1830-555-BAO	BD-3292 BD-3304i	D1837-555-BAA	BD-3365A BD-3365Ai	B9117-012-000	BD-3619A
DDL-555-4	B1830-555-BAO	BD-3292 BD-3304i	D1837-555-BAA	BD-3365A BD-3365Ai	B9117-012-000	BD-3619A
DDL-5550	B1830-127-OAO	BD-3282 BD-3282i	B1837-012-OAO	BD-3365i BD-3365	B9117-012-000	BD-3619A
DDL-555H-4-5	D1830-415-BAH	BD-3305	D1837-555-BAA	BD-3365A BD-3365Ai	B9117-012-000	BD-3619A
DDL-555W	B1830-127-OAO	BD-3282 BD-3282i	B1837-012-OAO	BD-3365 BD-3365i	B9117-012-000	BD-3619A
DDL-5570M	B1830-555-BAO	BD-3292 BD-3304i	D1837-555-BAA	BD-3365A BD-3365Ai	B9117-012-000	BD-3619A
DDL-5580H	D1830-415-BAH	BD-3305	D1837-555-BAA	BD-3365A BD-3365Ai	B9117-012-000	BD-3619A
DDW-226	B1830-127-OAO	BD-3282 BD-3282i	B1837-012-OAO	BD-3365 BD-3365i	B9117-012-000	BD-3619A
DDW-226A	B1830-127-OAO	BD-3282 BD-3282i	B1837-012-OAO	BD-3365 BD-3365i	B9117-012-000	BD-3619A
DDW-226W	B1830-127-OAO	BD-3282 BD-3282i	B1837-012-OAO	BD-3365 BD-3365i	B9117-012-000	BD-3619A
DDW-9	B1830-009-OAO	BD-3268 BD-3268i	B1837-012-OAO	BD-3365 BD-3365i	B9117-012-000	BD-3619A
DDW-92	B1830-009-OAO	BD-3268 BD-3268i	B1837-012-OAO	BD-3365 BD-3365i	B9117-012-000	BD-3619A

JUKI						
Klasse Class	Greifer / Hook		Spulenkapsel / Bobbin Case		Spule / Bobbin	
	Original-Nr. genuine no.	Artikelnummer Item number	Original-Nr. genuine no.	Artikelnummer Item number	Original-Nr. genuine no.	Artikelnummer Item number
DDW-9A	B1830-009-OAO	BD-3268 BD-3268i	B1837-012-OAO	BD-3365 BD-3365i	B9117-012-000	BD-3619A
DLD-432	B1830-127-OAO	BD-3282 BD-3282i	B1837-012-OAO	BD-3365 BD-3365i	B9117-012-000	BD-3619A
DLD-432-2	B1830-555-BAO	BD-3292 BD-3304i	D1837-555-BAA	BD-3365A BD-3365Ai	B9117-012-000	BD-3619A
DLD-432-3	B1830-555-BAO	BD-3292 BD-3304i	D1837-555-BAA	BD-3365A BD-3365Ai	B9117-012-000	BD-3619A
DLD-432-4	B1830-555-BAO	BD-3292 BD-3304i	D1837-555-BAA	BD-3365A BD-3365Ai	B9117-012-000	BD-3619A
DLD-432-5	B1830-555-BAO	BD-3292 BD-3304i	D1837-555-BAA	BD-3365A BD-3365Ai	B9117-012-000	BD-3619A
DLD-432A	B1830-127-OAO	BD-3282 BD-3282i	B1837-012-OAO	BD-3365 BD-3365i	B9117-012-000	BD-3619A
DLD-432B	B1830-127-OAO	BD-3282 BD-3282i	B1837-012-OAO	BD-3365 BD-3365i	B9117-012-000	BD-3619A
DLD-5430	B1830-127-OAO	BD-3282 BD-3282i	B1837-012-OAO	BD-3365 BD-3365i	B9117-012-000	BD-3619A
DLM-52	B1830-009-OAO	BD-3268 BD-3268i	B1837-012-OAO	BD-3365 BD-3365i	B9117-012-000	BD-3619A
DLM-5200	B1830-127-OAO	BD-3282 BD-3282i	B1837-012-OAO	BD-3365 BD-3365i	B9117-012-000	BD-3619A
DLM-522	B1830-127-OAO	BD-3282 BD-3282i	B1837-012-OAO	BD-3365 BD-3365i	B9117-012-000	BD-3619A
DLM-523	B1830-127-OAO	BD-3282 BD-3282i	B1837-012-OAO	BD-3365 BD-3365i	B9117-012-000	BD-3619A
DLN-412-2	B1830-555-BAO	BD-3292 BD-3304i	D1837-555-BAA	BD-3365A BD-3365Ai	B9117-012-000	BD-3619A
DLN-415H-2	D1830-415-BAH	BD-3305	B1837-041-OAO B1837-415-DAL	BD-3355 BD-3355A	B9117-012-000	BD-3619A
DLN-415H-4	D1830-415-BAH	BD-3305	B1837-041-OAO B1837-415-DAL	BD-3355 BD-3355A	B9117-012-000	BD-3619A
DLN-415L-4-1	D1830-415-DAL	BD-3304	B1837-041-OAO B1837-415-DAL	BD-3355 BD-3355A	B9117-012-000	BD-3619A
DLN-415L-4-5	B1830-555-BAO	BD-3292 BD-3304i	D1837-555-BAA	BD-3365A BD-3365Ai	B9117-012-000	BD-3619A
DLU-450	B1830-127-OAO	BD-3282 BD-3282i	B1837-012-OAO	BD-3365 BD-3365i	B9117-012-000	BD-3619A
DLU-450-2	B1830-555-BAO	BD-3292 BD-3304i	D1837-555-BAA	BD-3365A BD-3365Ai	B9117-012-000	BD-3619A
DLU-450-3	B1830-555-BAO	BD-3292 BD-3304i	D1837-555-BAA	BD-3365A BD-3365Ai	B9117-012-000	BD-3619A
DLU-450-4	B1830-555-BAO	BD-3292 BD-3304i	D1837-555-BAA	BD-3365A BD-3365Ai	B9117-012-000	BD-3619A
DLU-490-BB	B1830-127-OAO	BD-3282 BD-3282i	B1837-012-OAO	BD-3365 BD-3365i	B9117-012-000	BD-3619A
DLU-591-5	B1830-555-BAO	BD-3292 BD-3304i	D1837-555-BAA	BD-3365A BD-3365Ai	B9117-012-000	BD-3619A
DMN-530	B1830-555-BAO	BD-3292 BD-3304i	D1837-555-BAA	BD-3365A BD-3365Ai	B9117-012-000	BD-3619A
DMN-530-5	B1830-555-BAO	BD-3292 BD-3304i	D1837-555-BAA	BD-3365A BD-3365Ai	B9117-012-000	BD-3619A

1.4

UMLAUF- UND CB-GREIFER, RINGSCHIFFCHEN, SPULENKAPSELN UND SPULEN
 ROTARY HOOKS, CB-SHUTTLES, BEAK SHUTTLES, BOBBIN CASES AND BOBBINS

JUKI						
Klasse Class	Greifer / Hook		Spulenkapsel / Bobbin Case		Spule / Bobbin	
	Original-Nr. genuine no.	Artikelnummer Item number	Original-Nr. genuine no.	Artikelnummer Item number	Original-Nr. genuine no.	Artikelnummer Item number
DMN-531	B1830-555-BAO	BD-3292 BD-3304i	D1837-555-BAA	BD-3365A BD-3365Ai	B9117-012-000	BD-3619A
DMN-531-5	B1830-555-BAO	BD-3292 BD-3304i	D1837-555-BAA	BD-3365A BD-3365Ai	B9117-012-000	BD-3619A
LBH-761	B1808-761-OAO	BD-3636	B1810-761-OAO	BD-3370 BD-3370i	B1809-761-000	BD-3397AL
LBH-761	B1808-761-OAO	BD-3636	B1810-761-OBO	BD-3370A BD-3370Ai	B1809-761-000	BD-3397AL
LBH-762	B1808-761-OAO	BD-3636	B1810-761-OAO	BD-3370 BD-3370i	B1809-761-000	BD-3397AL
LBH-762	B1808-761-OAO	BD-3636	B1810-761-OBO	BD-3370A BD-3370Ai	B1809-761-000	BD-3397AL
LBH-763	B1808-761-OAO	BD-3636	B1810-761-OAO	BD-3370 BD-3370i	B1809-761-000	BD-3397AL
LBH-763	B1808-761-OAO	BD-3636	B1810-761-OBO	BD-3370A BD-3370Ai	B1809-761-000	BD-3397AL
LBH-771	B1808-771-OAC	BD-3309	B1810-771-OAO B1810-771-OBA	BD-3369 BD-3369A	B1811-771-000	BD-3652AL
LBH-772	B1808-771-OAC	BD-3309	B1810-771-OAO B1810-771-OBA	BD-3369 BD-3369A	B1811-771-000	BD-3652AL
LBH-773	B1808-771-OAC	BD-3309	B1810-771-OAO B1810-771-OBA	BD-3369 BD-3369A	B1811-771-000	BD-3652AL
LBH-774	B1808-771-OAC	BD-3309	B1810-771-OAO B1810-771-OBA	BD-3369 BD-3369A	B1811-771-000	BD-3652AL
LBH-781	B1808-771-OAC	BD-3309	B1810-771-OAO B1810-771-OBA	BD-3369 BD-3369A	B1811-771-000	BD-3652AL
LBH-782	B1808-771-OAC	BD-3309	B1810-771-OAO B1810-771-OBA	BD-3369 BD-3369A	B1811-771-000	BD-3652AL
LBH-783	B1808-771-OAC	BD-3309	B1810-771-OAO B1810-771-OBA	BD-3369 BD-3369A	B1811-771-000	BD-3652AL
LBH-784	B1808-771-OAC	BD-3309	B1810-771-OAO B1810-771-OBA	BD-3369 BD-3369A	B1811-771-000	BD-3652AL
LH-1150	101-10062	BD-3662	101-10252	B101-10252	101-11300	BD-3353AL
LH-1152-4	101-10062	BD-3662	101-10252	B101-10252	101-11300	BD-3353AL
LH-1152-4	101-95154	BD-3663			101-11300	BD-3353AL
LH-1152-5	101-10062	BD-3662	101-10252	B101-10252	101-11300	BD-3353AL
LH-1152-5	101-95154	BD-3663			101-11300	BD-3353AL
LH-1162	102-07751	BD-3664	102-08254	B102-08254	101-11300	BD-3353AL
LH-1162-4	102-07751	BD-3664	102-08254	B102-08254	101-11300	BD-3353AL
LH-1162-4	102-07851	BD-3665			101-11300	BD-3353AL
LH-1162-5	102-07751	BD-3664	102-08254	B102-08254	101-11300	BD-3353AL
LH-1162-5	102-07851	BD-3665			101-11300	BD-3353AL
LH-1182	102-31058	BD-3661	102-31553	B102-31553	102-31603	BD-3354AL

JUKI						
Klasse Class	Greifer / Hook		Spulenkapsel / Bobbin Case		Spule / Bobbin	
	Original-Nr. genuine no.	Artikelnummer Item number	Original-Nr. genuine no.	Artikelnummer Item number	Original-Nr. genuine no.	Artikelnummer Item number
LH-1182-4	102-31058	BD-3661	102-31553	B102-31553	102-31603	BD-3354AL
LH-1182-4	102-31157	BD-3660			102-31603	BD-3354AL
LH-1182-5	102-31058	BD-3661	102-31553	B102-31553	102-31603	BD-3354AL
LH-1182-5	102-31157	BD-3660			102-31603	BD-3354AL
LH-51	B1830-051-OAO	BD-3315			B9117-051-000	BD-3386
LH-51-10	B1830-051-OAO	BD-3315			B9117-051-000	BD-3386
LH-513	B1830-563-OAO	BD-3637			B9117-563-000	BD-3621
LH-516	B1830-051-OAO	BD-3315			B9117-051-000	BD-3386
LH-517	B1830-051-OAO	BD-3315			B9117-051-000	BD-3386
LH-518	B1830-051-OAO	BD-3315			B9117-051-000	BD-3386
LK-1850	B1818-280-000	BD-3334A BD-3334Ai	B1828-980-OAO	BD-3617 BD-3617i	B1827-280-000	BD-3642AL
LK-232	B1818-280-000	BD-3334A BD-3334Ai	B1828-980-OAO	BD-3617 BD-3617i	B1827-280-000	BD-3642AL
LK-280	B1818-280-000	BD-3334A BD-3334Ai	B1828-980-OAO	BD-3617 BD-3617i	B1827-280-000	BD-3642AL
LK-284	B1818-280-000	BD-3334A BD-3334Ai	B1828-980-OAO	BD-3617 BD-3617i	B1827-280-000	BD-3642AL
LK-287	B1818-280-000	BD-3334A BD-3334Ai	B1828-980-OAO	BD-3617 BD-3617i	B1827-280-000	BD-3642AL
LK-289	B1818-280-000	BD-3334A BD-3334Ai	B1828-980-OAO	BD-3617 BD-3617i	B1827-280-000	BD-3642AL
LK-291	B1818-280-000	BD-3334A BD-3334Ai	B1828-980-OAO	BD-3617 BD-3617i	B1827-280-000	BD-3642AL
LK-980	B1818-280-000	BD-3334A BD-3334Ai	B1828-980-OAO	BD-3617 BD-3617i	B1827-280-000	BD-3642AL
LK-981	B1818-280-000	BD-3334A BD-3334Ai	B1828-980-OAO	BD-3617 BD-3617i	B1827-280-000	BD-3642AL
LK-982	B1818-280-000	BD-3334A BD-3334Ai	B1828-980-OAO	BD-3617 BD-3617i	B1827-280-000	BD-3642AL
LK-987-510	B1818-280-000	BD-3334A BD-3334Ai	B1828-980-OAO	BD-3617 BD-3617i	B1827-280-000	BD-3642AL
LU-2210	107-22551	B467150094				BD-3402AL
LU-2260	107-22551	B467150094				BD-3402AL
LU-53	B1830-055-OAO	BD-3320 BD-3320i			B9117-051-000	BD-3386
LU-53-7	B1830-051-OAO	BD-3315			B9117-051-000	BD-3386
LU-55-2	B1830-055-OAO	BD-3320 BD-3320i			B9117-051-000	BD-3386
LU-55-3	B1830-055-OAO	BD-3320 BD-3320i			B9117-051-000	BD-3386

1.4

UMLAUF- UND CB-GREIFER, RINGSCHIFFCHEN, SPULENKAPSELN UND SPULEN ROTARY HOOKS, CB-SHUTTLES, BEAK SHUTTLES, BOBBIN CASES AND BOBBINS

JUKI						
Klasse Class	Greifer / Hook		Spulenkapsel / Bobbin Case		Spule / Bobbin	
	Original-Nr. genuine no.	Artikelnummer Item number	Original-Nr. genuine no.	Artikelnummer Item number	Original-Nr. genuine no.	Artikelnummer Item number
LU-562	B1830-055-OAO	BD-3320 BD-3320i			B9117-051-000	BD-3386
LU-562A	B1830-051-OAO	BD-3315			B9117-051-000	BD-3386
LU-563	B1830-563-OAO	BD-3637			B9117-563-000	BD-3621
LZ-1280	100-32555	BD-3310	100-34056	BD-3372	B1809-761-000	BD-3397AL
LZ-1285	100-32555	BD-3310	100-34056	BD-3372	B1809-761-000	BD-3397AL
LZ-1286	100-32555	BD-3310	100-34056	BD-3372	B1809-761-000	BD-3397AL
LZ-1287	100-32555	BD-3310	100-34056	BD-3372	B1809-761-000	BD-3397AL
LZ-27	B1830-027-OAO	BD-3270 BD-3270i	B1837-027-OAO B1837-027-NBL	BD-3342 BD-3342A	B9117-012-000	BD-3619A
LZ-271	B1830-027-OAO	BD-3270 BD-3270i	B1837-027-OAO B1837-027-NBL	BD-3342 BD-3342A	B9117-012-000	BD-3619A
LZ-29	B1830-027-OAO	BD-3270 BD-3270i	B1837-027-OAO B1837-027-NBL	BD-3342 BD-3342A	B9117-012-000	BD-3619A
LZ-40	B1830-027-OAO	BD-3270 BD-3270i	B1837-027-OAO B1837-027-NBL	BD-3342 BD-3342A	B9117-012-000	BD-3619A
LZ-403	B1830-027-OAO	BD-3270 BD-3270i	B1837-027-OAO B1837-027-NBL	BD-3342 BD-3342A	B9117-012-000	BD-3619A
LZ-405	B1830-405-OAO	BD-3314A	B1837-405-OAO B1837-405-NBL	BD-3371 BD-3371A	B9117-405-000	BD-3399
LZ-407	B1830-405-OAO	BD-3314A	B1837-405-OAO B1837-405-NBL	BD-3371 BD-3371A	B9117-405-000	BD-3399
TL-72	B1830-009-OAO	BD-3268 BD-3268i	B1837-012-OAO	BD-3365 BD-3365i	B9117-007-000	BD-3385
TL-82	B1830-009-OAO	BD-3268 BD-3268i	B1837-012-OAO	BD-3365 BD-3365i	B9117-007-000	BD-3385
TR-7	B1830-009-OAO	BD-3268 BD-3268i	B1837-012-OAO	BD-3365 BD-3365i	B9117-007-000	BD-3385

MITSUBISHI						
Klasse Class	Greifer / Hook		Spulenkapsel / Bobbin Case		Spule / Bobbin	
	Original-Nr. genuine no.	Artikelnummer Item number	Original-Nr. genuine no.	Artikelnummer Item number	Original-Nr. genuine no.	Artikelnummer Item number
CU-865	MF62B0120 P975003X01	BDA1-A	P976012X01 MN35A0125	BD-3355 BD-3355A	MF36A0123	BD-3385/1
CU-865-12	MF62B0120 P975003X01	BDA1-A	P976012X01 MN35A0125	BD-3355 BD-3355A	MF36A0123	BD-3385/1
DB-120	MF16A0120 P975007X01	BD-3282 BD-3282i	MF10E0125	BD-3365 BD-3365i	MF36A0123	BD-3385/1
DB-126-10	MF16A0120 P975007X01	BD-3282 BD-3282i	MF10E0125	BD-3365 BD-3365i	MF36A0123	BD-3385/1
DB-130-10	MF16A0120 P975007X01	BD-3282 BD-3282i	MF10E0125	BD-3365 BD-3365i	MF36A0123	BD-3385/1
DB-130-11	MF16A0120 P975007X01	BD-3282 BD-3282i	MF10E0125	BD-3365 BD-3365i	MF36A0123	BD-3385/1
DB-130-12	MF22B0120 P975010X01	BD-3283	MF10E0125	BD-3365 BD-3365i	MF36A0123	BD-3385/1
DB-130-13	MF22B0120 P975010X01	BD-3283	MF10E0125	BD-3365 BD-3365i	MF36A0123	BD-3385/1
DB-130G-10	MF16A0120 P975007X01	BD-3282 BD-3282i	MF10E0125	BD-3365 BD-3365i	MF36A0123	BD-3385/1
DB-130G-12	MF22B0120 P975010X01	BD-3283	MF10E0125	BD-3365 BD-3365i	MF36A0123	BD-3385/1
DB-130GM-10	MF16A0120 P975007X01	BD-3282 BD-3282i	MF10E0125	BD-3365 BD-3365i	MF36A0123	BD-3385/1
DB-130GM-127	MF22B0120 P975010X01	BD-3283	MF10E0125	BD-3365 BD-3365i	MF36A0123	BD-3385/1
DB-132G-10	MF16A0120 P975007X01	BD-3282 BD-3282i	MF10E0125	BD-3365 BD-3365i	MF36A0123	BD-3385/1
DB-132G-12	MF22B0120 P975010X01	BD-3283	MF10E0125	BD-3365 BD-3365i	MF36A0123	BD-3385/1
DB-170-10	MF16A0120 P975007X01	BD-3282 BD-3282i	MF10E0125	BD-3365 BD-3365i	MF10A0123	BD-3385
DB-170-11	MF16A0120 P975007X01	BD-3282 BD-3282i	MF10E0125	BD-3365 BD-3365i	MF10A0123	BD-3385
DB-171	MF16A0120 P975007X01	BD-3282 BD-3282i	MF10E0125	BD-3365 BD-3365i	MF10A0123	BD-3385
DB-189-12	MF42B0120 P975025X01	BD-3305	MF40E0125	BD-3365A BD-3365Ai	MF41D0123	BD-3385AL/1
DB-189-13	MF42B0120 P975025X01	BD-3305	MF40E0125	BD-3365A BD-3365Ai	MF41D0123	BD-3385AL/1
DN-260	MN10A0120 A190D110P01	BD-3604			MN40A0123	BD-3386
DN-260-10	MN10A0120 A190D110P01	BD-3604			MN40A0123	BD-3386
DN-260-22	MN12B0120 A190D111P01	BD-3603			MN12B0123	BD-3621
DN-260-7	MN10A0120 A190D110P01	BD-3604			MN40A0123	BD-3386
DN-262	MN12B0120 A190D111P01	BD-3603			MN12B0123	BD-3621
DN-265	MN10A0120 A190D110P01	BD-3604			MN40A0123	BD-3386
DN-265-10	MN10A0120 A190D110P01	BD-3604			MN40A0123	BD-3386
DX-370	MF60A0120 P975012X01	BD-3268 BD-3268i	MF10E0125	BD-3365 BD-3365i	MF10A0123	BD-3385

1.4

UMLAUF- UND CB-GREIFER, RINGSCHIFFCHEN, SPULENKAPSELN UND SPULEN
 ROTARY HOOKS, CB-SHUTTLES, BEAK SHUTTLES, BOBBIN CASES AND BOBBINS

MITSUBISHI						
Klasse Class	Greifer / Hook		SpulenkapSEL / Bobbin Case		Spule / Bobbin	
	Original-Nr. genuine no.	Artikelnummer Item number	Original-Nr. genuine no.	Artikelnummer Item number	Original-Nr. genuine no.	Artikelnummer Item number
DX-370-10	MF60A0120 P975012X01	BD-3268 BD-3268i	MF10E0125	BD-3365 BD-3365i	MF10A0123	BD-3385
DY-253	MG23E0121 P975003X01	BD-3316				B97949
DY-253-00	MG23E0121 P975003X01	BD-3316				B97949
DY-330	MF62B0120 P975003X01	BDA1-A	MF10E0125	BD-3365 BD-3365i	MF10A0123	BD-3385
DY-330-12	MF62B0120 P975003X01	BDA1-A	MF10E0125	BD-3365 BD-3365i	MF10A0123	BD-3385
DY-340-12	MF22B0120 P975010X01	BD-3283	MF10E0125	BD-3365 BD-3365i	MF10A0123	BD-3385
DY-350-12	MF22B0120 P975010X01	BD-3283	MF10E0125	BD-3365 BD-3365i	MF10A0123	BD-3385
LS2-1130-M	MF16A0120 P975007X01	BD-3282 BD-3282i	MF10E0125	BD-3365 BD-3365i	MF10A0123	BD-3385
LS2-1130-MOB	MF16A0120 P975007X01	BD-3282 BD-3282i	MF10E0125	BD-3365 BD-3365i	MF10A0123	BD-3385
LS2-1180-H	MF42B0120 P975025X01	BD-3305	MF40E0125	BD-3365A BD-3365Ai	MF41D0123	BD-3385AL/1
LS2-1180-L	MF01E0120 A190D359P02	BD-3292 BD-3304i	MF40E0125	BD-3365A BD-3365Ai	MF41D0123	BD-3385AL/1
LS2-1180-L1T	MF01E0120 A190D359P02	BD-3292 BD-3304i	MF40E0125	BD-3365A BD-3365Ai	MF41D0123	BD-3385AL/1
LS2-130-M	MF16A0120 P975007X01	BD-3282 BD-3282i	MF10E0125	BD-3365 BD-3365i	MF10A0123	BD-3385
LS2-130-MOB	MF16A0120 P975007X01	BD-3282 BD-3282i	MF10E0125	BD-3365 BD-3365i	MF10A0123	BD-3385
LS2-150-MOB	MF16A0120 P975007X01	BD-3282 BD-3282i	MF10E0125	BD-3365 BD-3365i	MF10A0123	BD-3385
LS2-180-H	MF42B0120 P975025X01	BD-3305	MF40E0125	BD-3365A BD-3365Ai	MF41D0123	BD-3385AL/1
LS2-180-H1T	MF42B0120 P975025X01	BD-3305	MF40E0125	BD-3365A BD-3365Ai	MF41D0123	BD-3385AL/1
LS2-180-L	MF01E0120 A190D359P02	BD-3292 BD-3304i	MF40E0125	BD-3365A BD-3365Ai	MF41D0123	BD-3385AL/1
LS2-190-H1TZ	MF42B0120 P975025X01	BD-3305	MF40E0125	BD-3365A BD-3365Ai	MF41D0123	BD-3385AL/1
LS2-190-H1TZ2	MF42B0120 P975025X01	BD-3305	MF40E0125	BD-3365A BD-3365Ai	MF41D0123	BD-3385AL/1
LS2-190-M1TZ	MF01E0120 A190D359P02	BD-3292 BD-3304i	MF40E0125	BD-3365A BD-3365Ai	MF41D0123	BD-3385AL/1
LS2-190-M1TZ2	MF01E0120 A190D359P02	BD-3292 BD-3304i	MF40E0125	BD-3365A BD-3365Ai	MF41D0123	BD-3385AL/1
LT2-220-B	MN12B0120 A190D111P01	BD-3603			MN12B0123	BD-3621
LT2-220-BOB	MN12B0120 A190D111P01	BD-3603			MN12B0123	BD-3621
LT2-220-M	MN10A0120 A190D110P01	BD-3604			MN40A0123	BD-3386
LT2-220-MOB	MN10A0120 A190D110P01	BD-3604			MN40A0123	BD-3386
LT2-2220-B	MN12B0120 A190D111P01	BD-3603			MN12B0123	BD-3621

MITSUBISHI						
Klasse Class	Greifer / Hook		Spulenkapsel / Bobbin Case		Spule / Bobbin	
	Original-Nr. genuine no.	Artikelnummer Item number	Original-Nr. genuine no.	Artikelnummer Item number	Original-Nr. genuine no.	Artikelnummer Item number
LT2-2220-BOB	MN12B0120 A190D111P01	BD-3603			MN12B0123	BD-3621
LT2-2220-L	MN10A0120 A190D110P01	BD-3604			MN40A0123	BD-3386
LT2-2220-LOB	MN10A0120 A190D110P01	BD-3604			MN40A0123	BD-3386
LT2-2220-M	MN10A0120 A190D110P01	BD-3604			MN40A0123	BD-3386
LT2-2220-MOB	MN10A0120 A190D110P01	BD-3604			MN40A0123	BD-3386
LX2-317-MO	MF60A0120 P975012X01	BD-3268 BD-3268i	MF10E0125	BD-3365 BD-3365i	MF10A0123	BD-3385
LZ-720	MT70A0120 P975002X03	BD-3318	MT70E0125	BD-3372	MT70E0125	BD-3397AL
LZ-720-11	MT70A0120 P975002X03	BD-3318	MT70E0125	BD-3372	MT70E0125	BD-3397AL
LZ-780	MT70A0120 P975002X03	BD-3318	MT70E0125	BD-3372	MT70E0125	BD-3397AL
LZ-780-11	MT70A0120 P975002X03	BD-3318	MT70E0125	BD-3372	MT70E0125	BD-3397AL
PLK-0303	MS01A0120	BSH430	MS01A0125	BD-3340	MS01A0123	BD-3400BAL
PLK-03BTA	MS01A0120	BSH430	MS01A0125	BD-3340	MS01A0123	BD-3400BAL
PLK-0804	MS01A0120	BSH430	MS01A0125	BD-3340	MS01A0123	BD-3400BAL
PLK-109	MS01A0120	BSH430	MS01A0125	BD-3340	MS01A0123	BD-3400BAL
PLK-1210	MS01A0120	BSH430	MS01A0125	BD-3340	MS01A0123	BD-3400BAL
PLK-2520	MS01A0120	BSH430	MS01A0125	BD-3340	MS01A0123	BD-3400BAL

1.4

UMLAUF- UND CB-GREIFER, RINGSCHIFFCHEN, SPULENKAPSELN UND SPULEN ROTARY HOOKS, CB-SHUTTLES, BEAK SHUTTLES, BOBBIN CASES AND BOBBINS

SINGER						
Klasse Class	Greifer / Hook		Spulenkapsel / Bobbin Case		Spule / Bobbin	
	Original-Nr. genuine no.	Artikelnummer Item number	Original-Nr. genuine no.	Artikelnummer Item number	Original-Nr. genuine no.	Artikelnummer Item number
15-30	2515	BD-3330	15277	BD-3325	2996 2996A	BD-3400 BD-3400AL
16-188	2515	BD-3330	15277	BD-3325	2996 2996A	BD-3400 BD-3400AL
20U13	541674 541968	BD-3270A BD-3324	541678	BD-3356	55623	BD-3385
20U23	541674 541968	BD-3270A BD-3324	541678	BD-3356	55623	BD-3385
20U33, 53	541674 541968	BD-3270A BD-3324	541678	BD-3356	55623	BD-3385
20U33, 53	541674 541968	BD-3270A BD-3324	541678	BD-3356	55623	BD-3385
21W180	238250	B238250 B238250i			203470	BD-3386
21W182	238250	B238250 B238250i			203470	BD-3386
29-K171	8603	BD-3321			8604	BD-3381
29-K71	8603	BD-3321			8604	BD-3381
29-K73	8603	BD-3321			8604	BD-3381
31-15	12393	BD-3331 BD-3331i	62740	BD-3327	2996 2996A	BD-3400 BD-3400AL
31-19	12393	BD-3331 BD-3331i	62740	BD-3327	2996 2996A	BD-3400 BD-3400AL
312U	CH319995	BD-3604			244750	BD-3386AL
31-K15	12393	BD-3331 BD-3331i	62740	BD-3327	2996 2996A	BD-3400 BD-3400AL
44	12393	BD-3331 BD-3331i	62740	BD-3327	2996 2996A	BD-3400 BD-3400AL
44-K2	12393	BD-3331 BD-3331i	62740	BD-3327	2996 2996A	BD-3400 BD-3400AL
45K	98623	BD-3323C			95093	BD-3626
45-K11	98623	BD-3323C			95093	BD-3626
45-K31	98623	BD-3323C			95093	BD-3626
45-K33	98623	BD-3323C			95093	BD-3626
45-K37	98623	BD-3323C			95093	BD-3626
45-K42	98623	BD-3323C			95093	BD-3626
45-K44	98623	BD-3323C			95093	BD-3626
45-K46	98623	BD-3323C			95093	BD-3626
45-K48	98623	BD-3323C			95093	BD-3626
45-K50	98623	BD-3323C			95093	BD-3626

SINGER						
Klasse Class	Greifer / Hook		Spulenkapsel / Bobbin Case		Spule / Bobbin	
	Original-Nr. genuine no.	Artikelnummer Item number	Original-Nr. genuine no.	Artikelnummer Item number	Original-Nr. genuine no.	Artikelnummer Item number
45-K52	98623	BD-3323C			95093	BD-3626
45-K57	98623	BD-3323C			95093	BD-3626
45-K58	98623	BD-3323C			95093	BD-3626
45-K65	98623	BD-3323C			95093	BD-3626
45-K67	98623	BD-3323C			95093	BD-3626
45-K68	98623	BD-3323C			95093	BD-3626
45-K69	98623	BD-3323C			95093	BD-3626
45-K70	98623	BD-3323C			95093	BD-3626
45-K71	98623	BD-3323C			95093	BD-3626
45-K72	98623	BD-3323C			95093	BD-3626
45-K74	98623	BD-3323C			95093	BD-3626
45-K78	98623	BD-3323C			95093	BD-3626
45-K80	98623	BD-3323C			95093	BD-3626
45-K82	98623	BD-3323C			95093	BD-3626
45-K84	98623	BD-3323C			95093	BD-3626
45-K86	98623	BD-3323C			95093	BD-3626
45-K87	98623	BD-3323C			95093	BD-3626
45-K92	98623	BD-3323C			95093	BD-3626
45-K93	98623	BD-3323C			95093	BD-3626
45-KSV102	98623	BD-3323C			95093	BD-3626
45-KSV43	98623	BD-3323C			95093	BD-3626
45-KSV99	98623	BD-3323C			95093	BD-3626
46W	238250	B238250 B238250i			203470	BD-3386
46-W122	238250	B238250 B238250i			203470	BD-3386
46-W125	238250	B238250 B238250i			203470	BD-3386
46-W13	238250	B238250 B238250i			203470	BD-3386
46-W130	238250	B238250 B238250i			203470	BD-3386

1.4

UMLAUF- UND CB-GREIFER, RINGSCHIFFCHEN, SPULENKAPSELN UND SPULEN ROTARY HOOKS, CB-SHUTTLES, BEAK SHUTTLES, BOBBIN CASES AND BOBBINS

SINGER						
Klasse Class	Greifer / Hook		Spulenkapsel / Bobbin Case		Spule / Bobbin	
	Original-Nr. genuine no.	Artikelnummer Item number	Original-Nr. genuine no.	Artikelnummer Item number	Original-Nr. genuine no.	Artikelnummer Item number
46-W131	238250	B238250 B238250i			203470	BD-3386
46-W200	238250	B238250 B238250i			203470	BD-3386
46-W27	238250	B238250 B238250i			203470	BD-3386
46-W5	238250	B238250 B238250i			203470	BD-3386
46-W51	238250	B238250 B238250i			203470	BD-3386
46-W52	238250	B238250 B238250i			203470	BD-3386
46-W6	238250	B238250 B238250i			203470	BD-3386
46-W61	238250	B238250 B238250i			203470	BD-3386
46-W62	238250	B238250 B238250i			203470	BD-3386
52-W30	238250	B238250 B238250i			203470	BD-3386
52-W31	238250	B238250 B238250i			203470	BD-3386
68-39	2515	BD-3330	33942	BD-3341i	2996 2996A	BD-3400 BD-3400AL
69	2515	BD-3330	15277	BD-3325	2996 2996A	BD-3400 BD-3400AL
71	40028	BD-3334	43725 43725NBL	BD-3338 BD-3338A	2996 2996A	BD-3400 BD-3400AL
71 - 30	40028	BD-3334	43725 43725NBL	BD-3338 BD-3338A	2996 2996A	BD-3400 BD-3400AL
7-31	58668	BD-3323B			16901	BD-3380
7-33	58668	BD-3323B			16901	BD-3380
7-56	58668	BD-3323B			16901	BD-3380
95-10	52089	BD-3267i	52237	BD-3365 BD-3365i	40246	BD-3385/1
95-40	127119 127119FG	BDA1-A BD-3268	52237	BD-3365 BD-3365i	40246	BD-3385/1
96-10	52089	BD-3267i	52237	BD-3365 BD-3365i	40246	BD-3385/1
96-40	127119 127119FG	BDA1-A BD-3268	52237	BD-3365 BD-3365i	40246	BD-3385/1
103K	127239	BD-3267i	52237	BD-3365 BD-3365i	40264	BD-3385
107G	210533	BD-3313 BD-3313i	224441	BD-3370 BD-3370i	263099	BD-3397
107G	210533	BD-3313 BD-3313i	224441NBL	BD-3370A BD-3370Ai	502526	BD-3397AL
107W1	210533	BD-3313 BD-3313i	224441	BD-3370 BD-3370i	263099	BD-3397
107W1	210533	BD-3313 BD-3313i	224441NBL	BD-3370A BD-3370Ai	502526	BD-3397AL

SINGER						
Klasse Class	Greifer / Hook		Spulenkapsel / Bobbin Case		Spule / Bobbin	
	Original-Nr. genuine no.	Artikelnummer Item number	Original-Nr. genuine no.	Artikelnummer Item number	Original-Nr. genuine no.	Artikelnummer Item number
107W100	224325	BD-3314A	224418	BD-3371	263099	BD-3397
107W100	224325	BD-3314A	224418NBL	BD-3371A	502526	BD-3397AL
107W102	224325	BD-3314A	224418	BD-3371	263099	BD-3397
107W102	224325	BD-3314A	224418NBL	BD-3371A	502526	BD-3397AL
107W103	224325	BD-3314A	224418	BD-3371	263099	BD-3397
107W103	224325	BD-3314A	224418NBL	BD-3371A	502526	BD-3397AL
107W17	210533	BD-3313 BD-3313i	224441	BD-3370 BD-3370i	263099	BD-3397
107W17	210533	BD-3313 BD-3313i	224441NBL	BD-3370A BD-3370Ai	502526	BD-3397AL
107W5	210533	BD-3313 BD-3313i	224441	BD-3370 BD-3370i	263099	BD-3397
107W5	210533	BD-3313 BD-3313i	224441NBL	BD-3370A BD-3370Ai	502526	BD-3397AL
111W155	240558	BD-3320 BD-3320i			203470	BD-3386
111W156	240558	BD-3320 BD-3320i			203470	BD-3386
112W115	237204	BD-3315			203470	BD-3386
112W140	248463	BD-3328			203470	BD-3386
112W145	248463	BD-3328			203470	BD-3386
112W146	248463	BD-3328			203470	BD-3386
1300	127239	BD-3268 BD-3268i	52237	BD-3365 BD-3365i	40264	BD-3385
131W	238250	B238250 B238250i			203470	BD-3386
132K	103123	BD-3316			97949	B97949
133K12	103123	BD-3316			97949	B97949
133K13	103123	BD-3316			97949	B97949
133K14	103123	BD-3316			97949	B97949
133K15	103123	BD-3316			97949	B97949
133K17	103123	BD-3316			97949	B97949
144W	265361	BD-3299			264645	BD-3399
145W	265361	BD-3299			264645	BD-3399
153K	238250	B238250 B238250i			203470	BD-3386

1.4

UMLAUF- UND CB-GREIFER, RINGSCHIFFCHEN, SPULENKAPSELN UND SPULEN ROTARY HOOKS, CB-SHUTTLES, BEAK SHUTTLES, BOBBIN CASES AND BOBBINS

SINGER						
Klasse Class	Greifer / Hook		Spulenkapsel / Bobbin Case		Spule / Bobbin	
	Original-Nr. genuine no.	Artikelnummer Item number	Original-Nr. genuine no.	Artikelnummer Item number	Original-Nr. genuine no.	Artikelnummer Item number
153-K102	238250	B238250 B238250i			203470	BD-3386
153-K103	238250	B238250 B238250i			203470	BD-3386
153-K104	238250	B238250 B238250i			203470	BD-3386
153W	238250	B238250 B238250i			203470	BD-3386
188K	143342	BD-3282 BD-3282i	52237	BD-3365 BD-3365i	40264	BD-3385
191D200A	414126	BD-3336	52237	BD-3365 BD-3365i	55623	BD-3385
191D200AA	414126	BD-3336	52237	BD-3365 BD-3365i	55623	BD-3385
191D200BA	414126	BD-3336	52237	BD-3365 BD-3365i	55623	BD-3385
191D240AA	414126	BD-3336	52237	BD-3365 BD-3365i	55623	BD-3385
191D300AA	414126	BD-3336	52237	BD-3365 BD-3365i	55623	BD-3385
191D300BA	414126	BD-3336	52237	BD-3365 BD-3365i	55623	BD-3385
191DX250A	414424	BD-3283	52237	BD-3365 BD-3365i	55623	BD-3385
191DX258A	414424	BD-3283	52237	BD-3365 BD-3365i	55623	BD-3385
195K	174045	BD-3346	52237	BD-3365 BD-3365i	272152	BD-3385AL/1
196K	174045	BD-3346	52237	BD-3365 BD-3365i	272152	BD-3385AL/1
211A157JA	CH319995	BD-3604			244750	BD-3386AL
211A165JA	CH319995	BD-3604			244750	BD-3386AL
211A166JA	CH319995	BD-3604			244750	BD-3386AL
211A166KA	CH319995	BD-3604			244750	BD-3386AL
211G146	267357	BD-3308A			244750	BD-3386AL
211G151	267357	BD-3308A			244750	BD-3386AL
211G155	240558	BD-3320 BD-3320i			244750	BD-3386AL
211G156	240558	BD-3320 BD-3320i			244750	BD-3386AL
211G157	267357	BD-3308A			244750	BD-3386AL
211G157A	267357	BD-3308A			244750	BD-3386AL
211G158	267357	BD-3308A			244750	BD-3386AL
211G166	267357	BD-3308A			244750	BD-3386AL

SINGER						
Klasse Class	Greifer / Hook		Spulenkapsel / Bobbin Case		Spule / Bobbin	
	Original-Nr. genuine no.	Artikelnummer Item number	Original-Nr. genuine no.	Artikelnummer Item number	Original-Nr. genuine no.	Artikelnummer Item number
211G256	267357	BD-3308A			244750	BD-3386AL
211G265	267357	BD-3308A			244750	BD-3386AL
211G266	267357	BD-3308A			244750	BD-3386AL
211G451	34804	BD-3319	512551	BD-3360B	244750	BD-3386AL
211G457	34804	BD-3319	512551	BD-3360B	244750	BD-3386AL
211GX110	267357	BD-3308A			244750	BD-3386AL
211GX115	267357	BD-3308A			244750	BD-3386AL
211U157	267357	BD-3308A			244750	BD-3386AL
211U165	240558	BD-3320 BD-3320i			244750	BD-3386AL
211U166	240558	BD-3320 BD-3320i			244750	BD-3386AL
211U257	267357	BD-3308A			244750	BD-3386AL
211U341	240558	BD-3320 BD-3320i			244750	BD-3386AL
211U365	240558	BD-3320 BD-3320i			244750	BD-3386AL
211UX157	267357	BD-3308A			244750	BD-3386AL
211UX165	240558	BD-3320 BD-3320i			244750	BD-3386AL
211UX166	240558	BD-3320 BD-3320i			244750	BD-3386AL
211W151	240558	BD-3320 BD-3320i			244750	BD-3386AL
211W155	240558	BD-3320 BD-3320i			244750	BD-3386AL
212A141BA	CH319995	BD-3604			244750	BD-3386AL
212A141GA	CH319995	BD-3604			244750	BD-3386AL
212G140	267357	BD-3308A			244750	BD-3386AL
212G140	34804	BD-3319	512551	BD-3360B	244750	BD-3386AL
212G141	267357	BD-3308A			244750	BD-3386AL
212G141	34804	BD-3319	512551	BD-3360B	244750	BD-3386AL
212G145	267357	BD-3308A			244750	BD-3386AL
212G145	34804	BD-3319	512551	BD-3360B	244750	BD-3386AL
212G440	267357	BD-3308A			244750	BD-3386AL

1.4

UMLAUF- UND CB-GREIFER, RINGSCHIFFCHEN, SPULENKAPSELN UND SPULEN ROTARY HOOKS, CB-SHUTTLES, BEAK SHUTTLES, BOBBIN CASES AND BOBBINS

SINGER						
Klasse Class	Greifer / Hook		Spulenkapsel / Bobbin Case		Spule / Bobbin	
	Original-Nr. genuine no.	Artikelnummer Item number	Original-Nr. genuine no.	Artikelnummer Item number	Original-Nr. genuine no.	Artikelnummer Item number
212G440	34804	BD-3319	512551	BD-3360B	244750	BD-3386AL
212GX4	267357	BD-3308A			244750	BD-3386AL
212GX5	267357	BD-3308A			244750	BD-3386AL
212GX6	267357	BD-3308A			244750	BD-3386AL
212LX670	267357	BD-3308A			244750	BD-3386AL
212U41	267357	BD-3308A			244750	BD-3386AL
212U441	34804	BD-3319	512551	BD-3360B	244750	BD-3386AL
212U442	267357	BD-3308A			244750	BD-3386AL
212W140	267357	BD-3308A			244750	BD-3386AL
212W145	267357	BD-3308A			244750	BD-3386AL
212W146	267357	BD-3308A			244750	BD-3386AL
220U22	414126	BD-3336	52237	BD-3365 BD-3365i	55623	BD-3385
220U23	414126	BD-3336	52237	BD-3365 BD-3365i	55623	BD-3385
241	143342	BD-3282 BD-3282i	52237	BD-3365 BD-3365i	270010	BD-3619
251	143342	BD-3282 BD-3282i	52237	BD-3365 BD-3365i	270010	BD-3619
269W	40028	BD-3334	43725 43725NBL	BD-3338 BD-3338A	418046	BD-3400CAL
281-81	143342	BD-3282 BD-3282i	52237	BD-3365 BD-3365i	270010	BD-3619
281-83	143342	BD-3282 BD-3282i	52237	BD-3365 BD-3365i	270010	BD-3619
331-K	12393	BD-3331 BD-3331i	62740	BD-3327	2996 2996A	BD-3400 BD-3400AL
366	143342	BD-3282 BD-3282i	52237	BD-3365 BD-3365i	270010	BD-3619
366-K	143342	BD-3282 BD-3282i	52237	BD-3365 BD-3365i	270010	BD-3619
400W	143342	BD-3282 BD-3282i	52237	BD-3365 BD-3365i	270010	BD-3619
402W	143342	BD-3282 BD-3282i	52237	BD-3365 BD-3365i	270010	BD-3619
431	12393	BD-3331 BD-3331i	62740	BD-3327	2996 2996A	BD-3400 BD-3400AL
431-D200A	12393	BD-3331 BD-3331i	62740	BD-3327	2996 2996A	BD-3400 BD-3400AL
431-D201A	12393	BD-3331 BD-3331i	62740	BD-3327	2996 2996A	BD-3400 BD-3400AL
431-F200A	12393	BD-3331 BD-3331i	62740	BD-3327	2996 2996A	BD-3400 BD-3400AL

SINGER						
Klasse Class	Greifer / Hook		Spulenkapsel / Bobbin Case		Spule / Bobbin	
	Original-Nr. genuine no.	Artikelnummer Item number	Original-Nr. genuine no.	Artikelnummer Item number	Original-Nr. genuine no.	Artikelnummer Item number
431-T200A	12393	BD-3331 BD-3331i	62740	BD-3327	2996 2996A	BD-3400 BD-3400AL
451K	143342	BD-3282 BD-3282i	52237	BD-3365 BD-3365i	270010	BD-3619
457G	502718	BD-3318	502530NBL	BD-3372A	272152	BD-3397AL
469U	418045	BSH469	418047	BD-3617	418046	BD-3400CAL
491-D	414126	BD-3336	52237	BD-3365 BD-3365i	270010	BD-3619
491D100GA	414126	BD-3336	52237	BD-3365 BD-3365i	270010	BD-3619
491D200GA	414126	BD-3336	52237	BD-3365 BD-3365i	270010	BD-3619
491D300GA	414126	BD-3336	52237	BD-3365 BD-3365i	270010	BD-3619
491D308GA	414126	BD-3336	52237	BD-3365 BD-3365i	270010	BD-3619
491DX201GA	414126	BD-3336	52237	BD-3365 BD-3365i	270010	BD-3619
491UX100	540733	BD-3336A	540735	BD-3365A BD-3365Ai	272152	BD-3385AL/1
491UX110B	540733	BD-3336A	540735	BD-3365A BD-3365Ai	272152	BD-3385AL/1
491UX110G	540733	BD-3336A	540735	BD-3365A BD-3365Ai	272152	BD-3385AL/1
491UX110H	540733	BD-3336A	540735	BD-3365A BD-3365Ai	272152	BD-3385AL/1
491UX200	540733	BD-3336A	540735	BD-3365A BD-3365Ai	272152	BD-3385AL/1
491UX210B	540733	BD-3336A	540735	BD-3365A BD-3365Ai	272152	BD-3385AL/1
491UX210G	540733	BD-3336A	540735	BD-3365A BD-3365Ai	272152	BD-3385AL/1
491UX210H	540733	BD-3336A	540735	BD-3365A BD-3365Ai	272152	BD-3385AL/1
491UX300	540733	BD-3336A	540735	BD-3365A BD-3365Ai	272152	BD-3385AL/1
491UX310B	540733	BD-3336A	540735	BD-3365A BD-3365Ai	272152	BD-3385AL/1
491UX310G	540733	BD-3336A	540735	BD-3365A BD-3365Ai	272152	BD-3385AL/1
491UX310H	540733	BD-3336A	540735	BD-3365A BD-3365Ai	272152	BD-3385AL/1
591D200	544784	BD-3336B B544784i	540735	BD-3365A BD-3365Ai	272152	BD-3385AL/1
591D200BD	544784	BD-3336B B544784i	540735	BD-3365A BD-3365Ai	272152	BD-3385AL/1
591D200BF	544784	BD-3336B B544784i	540735	BD-3365A BD-3365Ai	272152	BD-3385AL/1
591D200GD	544784	BD-3336B B544784i	540735	BD-3365A BD-3365Ai	272152	BD-3385AL/1
591D200GF	544784	BD-3336B B544784i	540735	BD-3365A BD-3365Ai	272152	BD-3385AL/1

1.4

UMLAUF- UND CB-GREIFER, RINGSCHIFFCHEN, SPULENKAPSELN UND SPULEN ROTARY HOOKS, CB-SHUTTLES, BEAK SHUTTLES, BOBBIN CASES AND BOBBINS

SINGER						
Klasse Class	Greifer / Hook		Spulenkapsel / Bobbin Case		Spule / Bobbin	
	Original-Nr. genuine no.	Artikelnummer Item number	Original-Nr. genuine no.	Artikelnummer Item number	Original-Nr. genuine no.	Artikelnummer Item number
591D203	540733	BD-3336A	540735	BD-3365A BD-3365Ai	272152	BD-3385AL/1
591D205	540733	BD-3336A	540735	BD-3365A BD-3365Ai	272152	BD-3385AL/1
591D210BD	544784	BD-3336B B544784i	540735	BD-3365A BD-3365Ai	272152	BD-3385AL/1
591D210BF	544784	BD-3336B B544784i	540735	BD-3365A BD-3365Ai	272152	BD-3385AL/1
591D210GD	544784	BD-3336B B544784i	540735	BD-3365A BD-3365Ai	272152	BD-3385AL/1
591D210GF	544784	BD-3336B B544784i	540735	BD-3365A BD-3365Ai	272152	BD-3385AL/1
591D215	544784	BD-3336B B544784i	540735	BD-3365A BD-3365Ai	272152	BD-3385AL/1
591D215BD	544784	BD-3336B B544784i	540735	BD-3365A BD-3365Ai	272152	BD-3385AL/1
591D215BF	544784	BD-3336B B544784i	540735	BD-3365A BD-3365Ai	272152	BD-3385AL/1
591D215GD	544784	BD-3336B B544784i	540735	BD-3365A BD-3365Ai	272152	BD-3385AL/1
591D215GF	544784	BD-3336B B544784i	540735	BD-3365A BD-3365Ai	272152	BD-3385AL/1
591D240AD	540733	BD-3336A	540735	BD-3365A BD-3365Ai	272152	BD-3385AL/1
591D240AF	540733	BD-3336A	540735	BD-3365A BD-3365Ai	272152	BD-3385AL/1
591D240BD	544784	BD-3336B B544784i	540735	BD-3365A BD-3365Ai	272152	BD-3385AL/1
591D240BF	544784	BD-3336B B544784i	540735	BD-3365A BD-3365Ai	272152	BD-3385AL/1
591D240GD	544784	BD-3336B B544784i	540735	BD-3365A BD-3365Ai	272152	BD-3385AL/1
591D240GF	544784	BD-3336B B544784i	540735	BD-3365A BD-3365Ai	272152	BD-3385AL/1
591D300	544784	BD-3336B B544784i	540735	BD-3365A BD-3365Ai	272152	BD-3385AL/1
591D300BD	544784	BD-3336B B544784i	540735	BD-3365A BD-3365Ai	272152	BD-3385AL/1
591D300BF	544784	BD-3336B B544784i	540735	BD-3365A BD-3365Ai	272152	BD-3385AL/1
591D300GD	544784	BD-3336B B544784i	540735	BD-3365A BD-3365Ai	272152	BD-3385AL/1
591D300GF	544784	BD-3336B B544784i	540735	BD-3365A BD-3365Ai	272152	BD-3385AL/1
591D301	414126	BD-3336	52237	BD-3365 BD-3365i	270010	BD-3619
591D302AF	414126	BD-3336	52237	BD-3365 BD-3365i	270010	BD-3619
591D303	414126	BD-3336	52237	BD-3365 BD-3365i	270010	BD-3619
591D305AD	414126	BD-3336	52237	BD-3365 BD-3365i	270010	BD-3619
591D305AF	414126	BD-3336	52237	BD-3365 BD-3365i	270010	BD-3619

SINGER						
Klasse Class	Greifer / Hook		Spulenkapsel / Bobbin Case		Spule / Bobbin	
	Original-Nr. genuine no.	Artikelnummer Item number	Original-Nr. genuine no.	Artikelnummer Item number	Original-Nr. genuine no.	Artikelnummer Item number
591D310BD	544784	BD-3336B B544784i	540735	BD-3365A BD-3365Ai	272152	BD-3385AL/1
591D310BF	544784	BD-3336B B544784i	540735	BD-3365A BD-3365Ai	272152	BD-3385AL/1
591D310GD	544784	BD-3336B B544784i	540735	BD-3365A BD-3365Ai	272152	BD-3385AL/1
591D310GF	544784	BD-3336B B544784i	540735	BD-3365A BD-3365Ai	272152	BD-3385AL/1
591D315	544784	BD-3336B B544784i	540735	BD-3365A BD-3365Ai	272152	BD-3385AL/1
591D315BD	544784	BD-3336B B544784i	540735	BD-3365A BD-3365Ai	272152	BD-3385AL/1
591D315BF	544784	BD-3336B B544784i	540735	BD-3365A BD-3365Ai	272152	BD-3385AL/1
591D315GD	544784	BD-3336B B544784i	540735	BD-3365A BD-3365Ai	272152	BD-3385AL/1
591D315GF	544784	BD-3336B B544784i	540735	BD-3365A BD-3365Ai	272152	BD-3385AL/1
591D318BD	544784	BD-3336B B544784i	540735	BD-3365A BD-3365Ai	272152	BD-3385AL/1
591D318BF	544784	BD-3336B B544784i	540735	BD-3365A BD-3365Ai	272152	BD-3385AL/1
591D318GD	544784	BD-3336B B544784i	540735	BD-3365A BD-3365Ai	272152	BD-3385AL/1
591D318GF	544784	BD-3336B B544784i	540735	BD-3365A BD-3365Ai	272152	BD-3385AL/1
591DUX100	414126	BD-3336	52237	BD-3365 BD-3365i	270010	BD-3619
591E	143342	BD-3282 BD-3282i	52237	BD-3365 BD-3365i	270010	BD-3619
591UF220	143342	BD-3282 BD-3282i	52237	BD-3365 BD-3365i	270010	BD-3619
591UX100	143342	BD-3282 BD-3282i	52237	BD-3365 BD-3365i	270010	BD-3619
591UX100BF	544784	BD-3336B B544784i	540735	BD-3365A BD-3365Ai	272152	BD-3385AL/1
591UX100GF	544784	BD-3336B B544784i	540735	BD-3365A BD-3365Ai	272152	BD-3385AL/1
591UX220	544784	BD-3336B B544784i	540735	BD-3365A BD-3365Ai	272152	BD-3385AL/1
591UX220GF	544784	BD-3336B B544784i	540735	BD-3365A BD-3365Ai	272152	BD-3385AL/1
591UX301	143342	BD-3282 BD-3282i	52237	BD-3365 BD-3365i	270010	BD-3619
591UX302AF	143342	BD-3282 BD-3282i	52237	BD-3365 BD-3365i	270010	BD-3619
591UX312	544784	BD-3336B B544784i	540735	BD-3365A BD-3365Ai	272152	BD-3385AL/1
591UX312BF	544784	BD-3336B B544784i	540735	BD-3365A BD-3365Ai	272152	BD-3385AL/1
591UX312GF	544784	BD-3336B B544784i	540735	BD-3365A BD-3365Ai	272152	BD-3385AL/1
591UX313BF	544784	BD-3336B B544784i	540735	BD-3365A BD-3365Ai	272152	BD-3385AL/1

1.4

UMLAUF- UND CB-GREIFER, RINGSCHIFFCHEN, SPULENKAPSELN UND SPULEN
 ROTARY HOOKS, CB-SHUTTLES, BEAK SHUTTLES, BOBBIN CASES AND BOBBINS

SINGER						
Klasse Class	Greifer / Hook		Spulenkapsel / Bobbin Case		Spule / Bobbin	
	Original-Nr. genuine no.	Artikelnummer Item number	Original-Nr. genuine no.	Artikelnummer Item number	Original-Nr. genuine no.	Artikelnummer Item number
591UX313GF	544784	BD-3336B B544784i	540735	BD-3365A BD-3365Ai	272152	BD-3385AL/1
591UX320GF	544784	BD-3336B B544784i	540735	BD-3365A BD-3365Ai	272152	BD-3385AL/1
600W	143342	BD-3282 BD-3282i	52237	BD-3365 BD-3365i	270010	BD-3619
601D100AD	544784	BD-3336B B544784i	540735	BD-3365A BD-3365Ai	272152	BD-3385AL/1
601D100AF	544784	BD-3336B B544784i	540735	BD-3365A BD-3365Ai	272152	BD-3385AL/1
601D100BD	544784	BD-3336B B544784i	540735	BD-3365A BD-3365Ai	272152	BD-3385AL/1
601D100BF	544784	BD-3336B B544784i	540735	BD-3365A BD-3365Ai	272152	BD-3385AL/1
601D100GD	544784	BD-3336B B544784i	540735	BD-3365A BD-3365Ai	272152	BD-3385AL/1
601D100GF	544784	BD-3336B B544784i	540735	BD-3365A BD-3365Ai	272152	BD-3385AL/1
691D	368132	BD-3292 BD-3304i	540735	BD-3365A BD-3365Ai	272152	BD-3385AL/1

TEXTIMA

siehe ALTIN / refer to ALTIN

Spulenkapselersatzteile Spare parts for Bobbin Cases

Artikelbezeichnung Item description	Originalnummer genuine number	Artikelnummer Item number
Spulenkapselbremse für Artikelnummer BD-3365a NBL-Spring for item number BD-3365a		BNBL406
Spulenkapselbremse für Artikelnummer BD-3342a NBL-Spring for item number BD-3342a		BNBL409
Spulenkapselspannfeder-Regulierschraube Tension Spring Regulating Screw	591L	BD-4381
Spulenkapselspannfeder-Regulierschraube Tension Spring Regulating Screw	591	BD-4382
Spulenkapselspannfeder-Befestigungsschraube Tension Spring Screw	1380L	BD-5020
Spulenkapselspannfeder-Befestigungsschraube Tension Spring Screw	1380	BD-5021
Spulenkapselbremsscheiben Star Discs for Bobbin Cases		B490468
Spulenkapselbremsscheiben, groß Star Discs, large		B490468LB

1: NÄHEN *SEWING*

1.5 FABRIKATIONSSPEZIFISCHE NÄHWERKZEUGE UND ERSATZTEILE *BRAND DEPENDING SEWING AND SPARE PARTS*

Altin

CT = Hartmetall
 Carbide Tip

8515		
	Originalnummer Genuine no.	Artikelnummer Item-no. PREMIUM QUALITY
Messer Knife	81000669	BD-2669Am
	81000670	BD-2669Bm



BD-2669Am



BD-2669Bm

8516		
	Originalnummer Genuine no.	Artikelnummer Item-no. PREMIUM QUALITY
Stichplatte Needle Plate	81073087	B81073087m
Transporteur Feed Dog	81073002	B81073002m
	81073034	B81073034m
	81073371	B81073371m
Messer Knife	81071606	B81071606m
	81071614	B81071614m
	81071628	B81071628m
	81074012CT	BCT81074012m
	81074018CT	BCT81074018m
	81077008	B81077008m
	81077009CT	BCT81077009m
	81077012CT	B81077012m
Kettenstichgreifer Looper	81070808	B81070808m
	81071401	B81071401m
	81071415	B81071415m
Messerhalter Knife holder	81071609	B81071609m

Altin

CT = Hartmetall
Carbide Tip

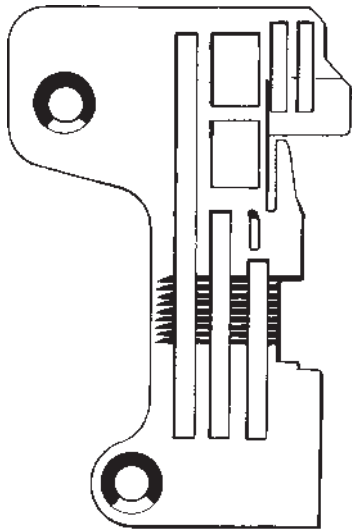

B81073087m



B81073002m

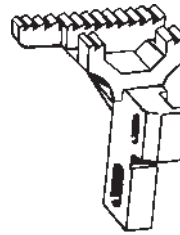

B81073034m

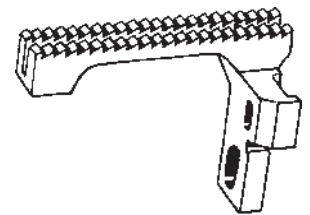

B81073371m



B81071606m



B81071614m

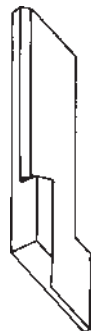

B81071628m

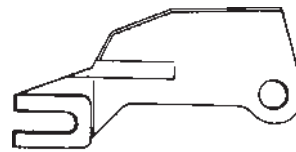

BCT81074012m

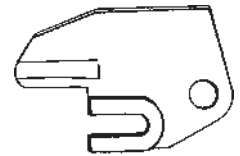

BCT81074018m



BCT81077009m

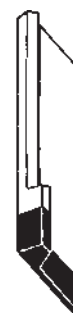

B81077012m



B81077008m

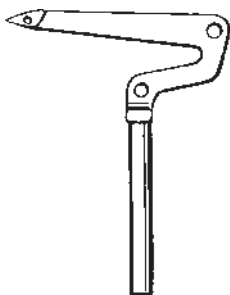

B81070808m



B81071415m



B81071401m

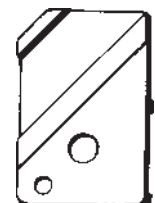

B81071609m

Bernina

CT = Hartmetall
 Carbide Tip

BERNETTE OVERLOCK MO 334 D, 335		
	Originalnummer <i>Genuine no.</i>	Artikelnummer <i>Item-no.</i> PREMIUM QUALITY
Messer <i>Knife</i>	50143403CT	BA4142-335-000CTm
	50145403	BA4145-335-000m



BA4142-335-000CTm



BA4145-335-000m

Brother

BAS-310, -311		
	Originalnummer <i>Genuine no.</i>	Artikelnummer <i>Item-no.</i> PREMIUM QUALITY
Messer <i>Knife</i>	S10205-001	BS10205-001m
	S10210-001	BS10210-001m



BS10205-001m



BS10210-001m

BAS-322		
	Originalnummer <i>Genuine no.</i>	Artikelnummer <i>Item-no.</i> PREMIUM QUALITY
Messer <i>Knife</i>	S02375-001	BS02375-001m



BS02375-001m

BAS-760, DB2-B791		
	Originalnummer <i>Genuine no.</i>	Artikelnummer <i>Item-no.</i> PREMIUM QUALITY
Messer <i>Knife</i>	159540-001	B159540-001m
	159541-001	B159541-001m
	159799-001	B159799-001m



B159540-001m

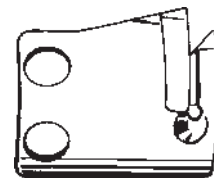

B159541-001m

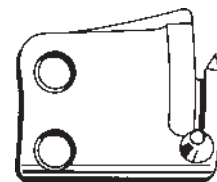

B159799-001m

Brother

CT = Hartmetall
 Carbide Tip

CB3-B912, -B913, -B915			
	Originalnummer <i>Genuine no.</i>	Artikelnummer <i>Item-no.</i> STANDARD	Artikelnummer <i>Item-no.</i> PREMIUM QUALITY
Ösenknopfklammer <i>Shank Button Clamp</i>	142570-001	B142570-0-01	
Flachknopfklammer <i>Straight Button Clamp</i>	115167-001	B115167-0-01	
Kettenstichgreifer <i>Looper</i>	115069-001		B115069-001m

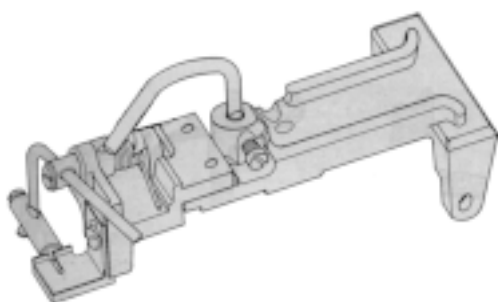

B142570-0-01

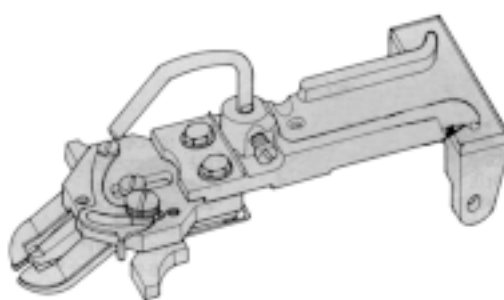

B115167-0-01



B115069-001m

CB3-B916, -B917			
	Originalnummer <i>Genuine no.</i>	Artikelnummer <i>Item-no.</i> STANDARD	Artikelnummer <i>Item-no.</i> PREMIUM QUALITY
Flachknopfklammer <i>Straight Button Clamp</i>	S03599-001	BS03599-001	
Ösenknopfklammer <i>Shank Button Clamp</i>	S07877-001	BS07877-001	
Messer <i>Knife</i> (nur / only CB3- B917)	S03627-001		BS03627-001m
	S03629-001		BS03629-001m

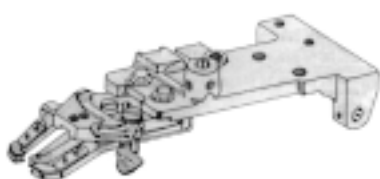

BS03599-001

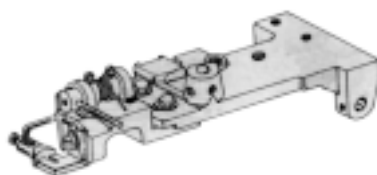

BS07877-001



BS03627-001m



BS03629-001m

Brother

CT = Hartmetall
 Carbide Tip

CM2-B931, -B932		
	Originalnummer <i>Genuine no.</i>	Artikelnummer <i>Item-no.</i> STANDARD
Blindstichgreifer <i>Blindstitch Loper</i>	110121-001	BD-2725



BD-2725

DB2-B716		
	Originalnummer <i>Genuine no.</i>	Artikelnummer <i>Item-no.</i> PREMIUM QUALITY
Messer <i>Knife</i>	154568-001	B154568-001m
	154575-001	B154575-001m



B154568-001m

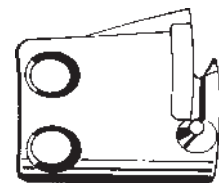

B154575-001m

DB2-B737, -738		
	Originalnummer <i>Genuine no.</i>	Artikelnummer <i>Item-no.</i> PREMIUM QUALITY
Messer <i>Knife</i>	S02637-001	BS02637-001m
	S02645-001	BS02645-001m



BS02637-001m

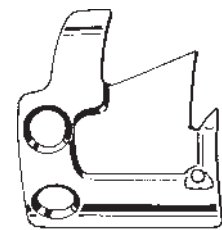

BS02645-001m

DB2-B772		
	Originalnummer <i>Genuine no.</i>	Artikelnummer <i>Item-no.</i> PREMIUM QUALITY
Messer <i>Knife</i>	S10605-001	BS10605-001m
	S32474-001	BS32474-001m
	S32477-001	BS32477-001m



BS10605-001m



BS32474-001m



BS32477-001m

Brother

CT = Hartmetall
 Carbide Tip

DBZ-B755			
	Originalnummer <i>Genuine no.</i>	Artikelnummer <i>Item-no.</i> STANDARD	Artikelnummer <i>Item-no.</i> PREMIUM QUALITY
Messer <i>Knife</i>	142058-001	BD-2712	BD-2712m
	142061-001	BD-2713	BD-2713m



BD-2712
 BD-2712m

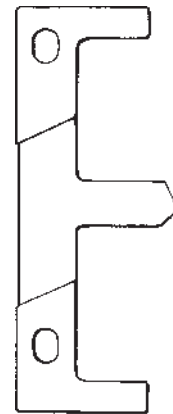

BD-2713
 BD-2713m

DH4-B980		
	Originalnummer <i>Genuine no.</i>	Artikelnummer <i>Item-no.</i> PREMIUM QUALITY
Messer <i>Knife</i>	S35480-101	BS35480-101m
Kettenstichgreifer <i>Looper</i>	S35410-001	BS35410-001m
	S35411-001	BS35411-001m
	S35412-101	BS35412-101m
	S35413-101	BS35413-101m

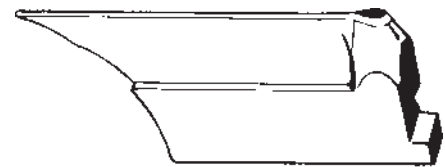

BS35480-101m



BS35410-001m



BS35411-001m

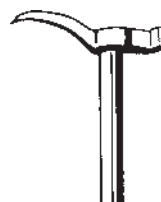

BS35412-101m

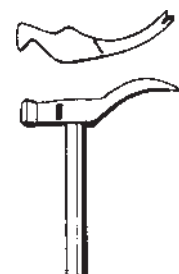

BS35413-101m

Brother

CT = Hartmetall
Carbide Tip

DT4-B281		
	Originalnummer <i>Genuine no.</i>	Artikelnummer <i>Item-no.</i> PREMIUM QUALITY
Kettenstichgreifer Looper	S12842-001	BS12842-001m
	S12865-001	BS12865-001m

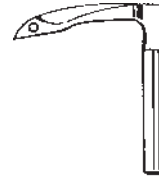

BS12842-001m



BS12865-001m

DT6-B924, -B928		
	Originalnummer <i>Genuine no.</i>	Artikelnummer <i>Item-no.</i> PREMIUM QUALITY
Kettenstichgreifer Looper	SY0069084	BSY0069084m
	SY0069085	BSY0069085m
	SY0069086	BSY0069086m

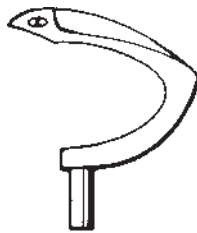

BSY0069084m

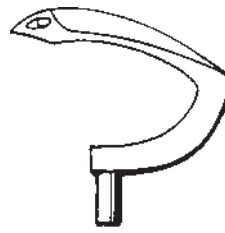

BSY0069085m



BSY0069086m

DT6-B926			
		Originalnummer <i>Genuine no.</i>	Artikelnummer <i>Item-no.</i> STANDARD
3-Nadel-Nähwerk- zeuge für schwere Materialien <i>Triple Needle Gauge parts for heavy materials 1/8"+1/8"</i>	Nadelhalter <i>Needle Clamp</i>	181079-001	B128215-501
	Standardfuß <i>Standard Foot</i>	111143-001	B139405-501
	Stichplatte <i>Needle Plate</i>	111130-001	B139500-501
	Transporteur <i>Feed Dog</i>	111154-001	B139499-501



B128215-501



B139405-501



B139500-501



B139499-501

Brother

CT = Hartmetall
 Carbide Tip

EF4-/MA4- B511, B531, B551, B561, B571, B581, B611, B621, B631, B641, B651, B661, B671, B681, B691, B672, B682, B692, B953, B955, B956, B957, B958, B959, B972			
	Originalnummer Genuine no.	Artikelnummer Item-no. STANDARD	Artikelnummer Item-no. PREMIUM QUALITY
Messer Knife	112376-001	BD-2678	BD-2678m
	112436-001	BD-2679	BD-2679m
	112436-001CT		BD-2679CTm
	118527-001		BD-2676m
	140242-001CT		BD-2673CTm
	140567-001		BD-2670m
	140567-001CT		BD-2670CTm
	144074-001CT	BD-2675CT	BD-2675CTm
	144077-001	BD-2677	BD-2677m
	144077-001CT		BD-2677CTm
	148198-001		BD-2782m
	148815-001CT		BD-2674CTm
Keramikkmesser Ceramic Knife	112436-001BAK	BD-5510	
Kettenstichgreifer Looper	110736-001		BD-2681m
	110737-001		BD-2682m
	143733-001		BD-2686m
	143734-001		BD-2687m
	144042-001		B144042-001m
	146635-001		BD-2689m
	147934-001		BD-2683m
	147935-001		BD-2683Am
	147936-001		BD-2684m
	147937-001		BD-2685m
	155240-001		B155240-001m
	155241-001		B155241-001m
	155242-001		B155242-001m
	155243-001		B155243-001m
	159434-001		B159434-001m
	159686-001		B159686-001m
	S01248-001		BD-2688m
Schraube Screw	146427-001	B3637	

Brother

CT = Hartmetall
 Carbide Tip

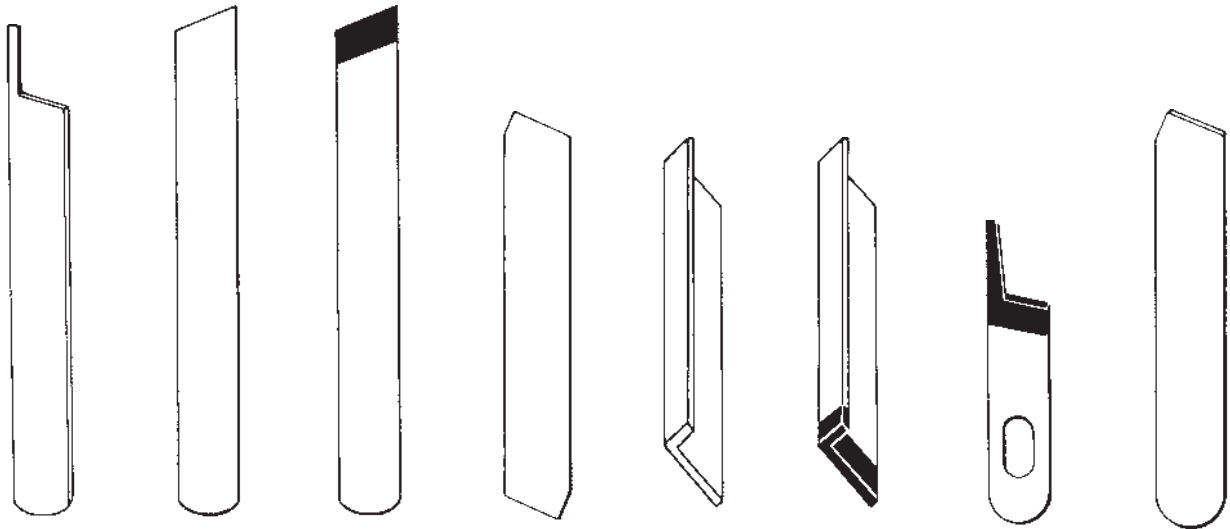

BD-2678
BD-2678m

BD-2679
BD-2679m

BD-2679CTm

BD-2676m

BD-2670m

BD-2670CTm

BD-2675CT
BD-2675CTm

BD-2677
BD-2677m

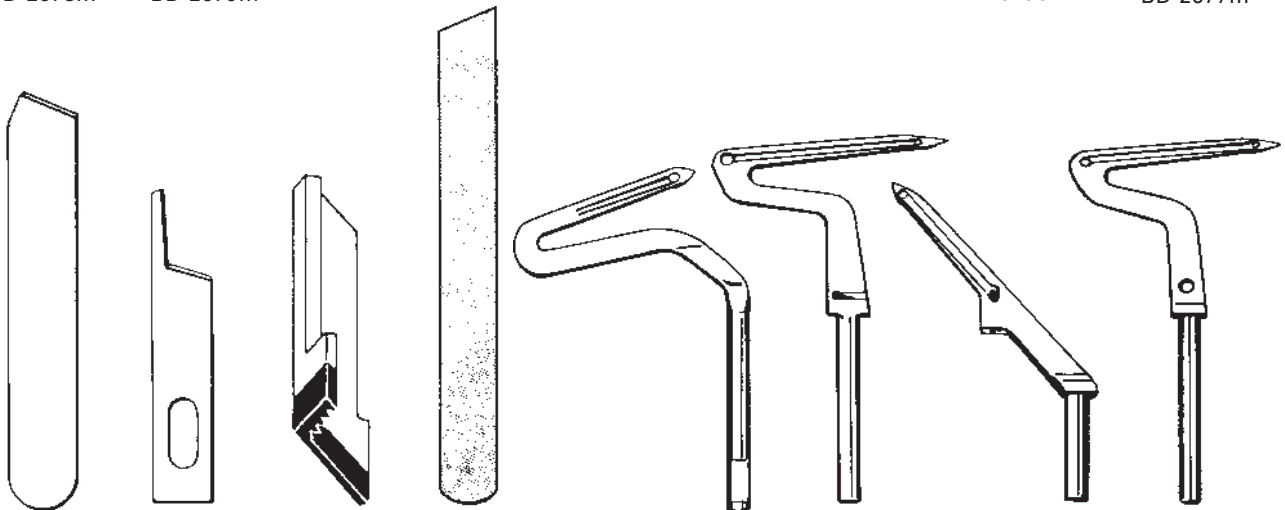

BD-2677CTm

BD-2782m

BD-2674CTm

BD-5510

BD-2681m

BD-2688m

BD-2686m

BD-2687m

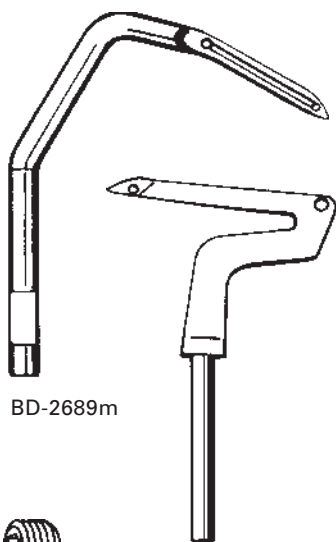

BD-2689m

B159434-001m



B3637

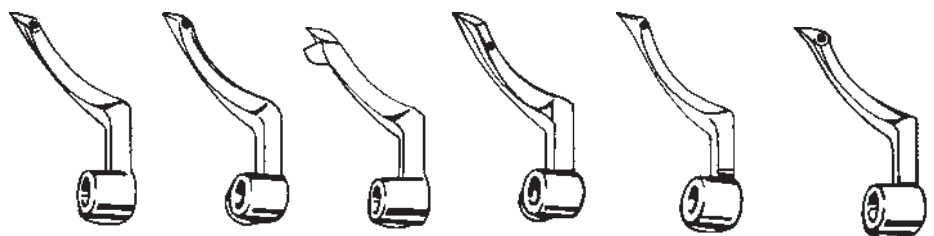

B144042-001m

BD-2683m

BD-2683Am

BD-2684m

BD-2685m

B159686-001m

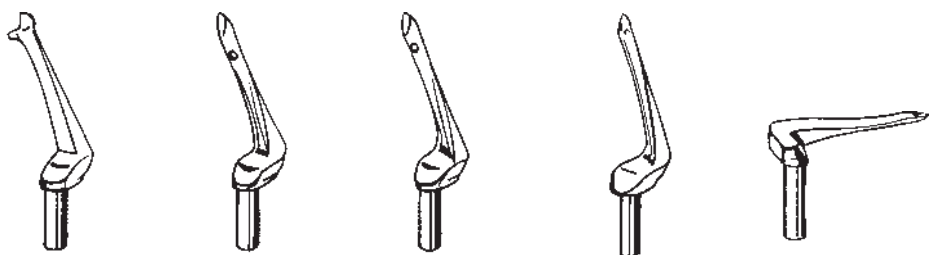

B155241-001m

B155242-001m

B155243-001m

B155240-001m

BD-2682m

Brother

CT = Hartmetall
 Carbide Tip

EF4-/MA4- V41, V51, V61, V71, V72, V81, V82, V91, V92			
	Originalnummer <i>Genuine no.</i>	Artikelnummer <i>Item-no.</i> STANDARD	Artikelnummer <i>Item-no.</i> PREMIUM QUALITY
Messer <i>Knife</i>	144074-001CT	BD-2675CT	BD-2675CTm
	144074-200		BD-2675ACTm
	S20579-101		BS20579-101m
	S20582-001		BS20582-001m
	S20582-001CT		BCTS20582-001m
	S20583-001		BS20583-001m
	S20896-101		BS20896-101m
	S20897-101		BS20897-101m
	S20898-001		BS20898-001m
	S20899-001		BS20899-001m
Kettenstichgreifer <i>Looper</i>	S20421-001		BS20421-001m
	S20422-001		BS20422-001m
	S20423-001		BS20423-001m
	S20424-001		BS20424-001m
	S20428-001		BS20428-001m
	S20429-001		BS20429-001m
	S20430-001		BS20430-001m
	S20434-001		BS20434-001m
	S20436-001		BS20436-001m
	S20438-001		BS20438-001m
	S20440-001		BS20440-001m
	S20442-001		BS20442-001m
	S20626-001		BS20626-001m
	S20653-001		BS20653-001m
Schraube <i>Screw</i>	146427-001	B3637	

Brother

CT = Hartmetall
 Carbide Tip

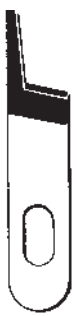

BD-2675CT
 BD-2675CTm

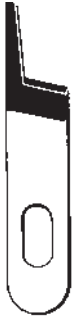

BD-2675ACTm



BS20579-101m



BS20582-001m



BCTS20582-001m



BS20896-101m



BS20897-101m



BS20898-001m



BS20899-001m



BS20421-001m



BS20422-001m

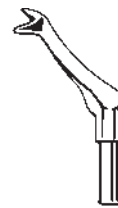

BS20423-001m



BS20424-001m

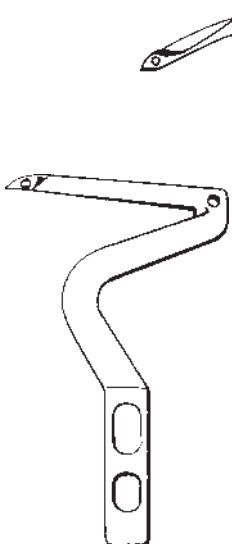

BS20626-001m



BS20653-001m



B3637



BS20428-001m



BS20429-001m



BS20430-001m



BS20434-001m



BS20436-001m



BS20438-001m



BS20440-001m



BS20442-001m

Brother

CT = Hartmetall
 Carbide Tip

FD4-B271, -B272		
	Originalnummer Genuine no.	Artikelnummer Item-no. PREMIUM QUALITY
Messer Knife	S09075-001	BS09075-001m
	S09080-001	BS09080-001m
	S09093-001	BCTS09093-001m
	S09094-001	BCTS09094-001Tm
	S09101-001	BS09101-001m
Kettenstichgreifer Looper	S08913-001	BS08913-001m
	S08934-001	BS08934-001m



BS09075-001m



BS09101-001m



BS09080-001m

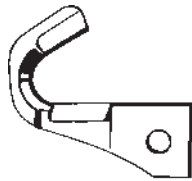

BCTS09093-001m

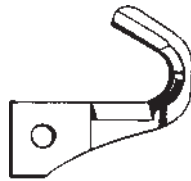

BCTS09094-001Tm

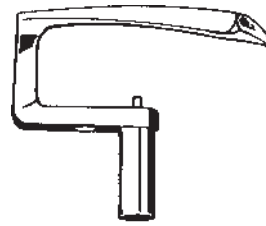

BS08913-001m

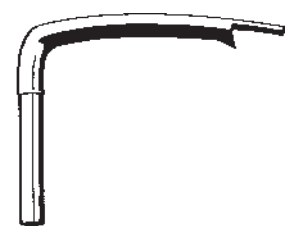

BS08934-001m

Brother

CT = Hartmetall
 Carbide Tip

LH4-B812, B814, B815, B816, B860			
	Originalnummer Genuine no.	Artikelnummer Item-no. STANDARD	Artikelnummer Item-no. PREMIUM QUALITY
Knopflochmesser Button Hole Knife	1/8"		BD-2692m
	1/4"		BD-2693m
	5/16"		BD-2694m
	3/8" = 109837-001		BD-2695m
	7/16" = 107204-001		BD-2696m
	1/2" = 107200-001	BD-2697	BD-2697m
	9/16" = S03278-001	BD-2698	BD-2698m
	5/8" = 107205-001	BD-2699	BD-2699m
	11/16" = S25641-001	BD-2701	BD-2701m
	3/4" = 107207-001	BD-2702	BD-2702m
	13/16" = S25642-001		BD-2703m
	7/8" = 109838-001	BD-2700	BD-2700m
	15/16"	BD-2704	BD-2704m
	1" = 107210-001	BD-2705	BD-2705m
	1-1/16"		BD-2706m
	1-1/8"	BD-2707	BD-2707m
	1-3/16"		BD-2708m
	1-1/4"	BD-2709	BD-2709m
	1-3/8"	BD-2710	
	1-1/2"	BD-2711	BD-2711m
Knopflochmesser Buttonhole Knife 90°	1/8"		B71-90-1/8m
	1/4"		B71-90-1/4m
	5/16"		B71-90-5/16m
	3/8" = 151837-001		B71-90-3/8m
	7/16" = 151838-001		B71-90-7/16m
	1/2" = 151839-001		B71-90-1/2m
	9/16" = S03279-001		B71-90-9/16m
	5/8" = 151840-001		B71-90-5/8m
	11/16"		B71-90-11/16m
	3/4" = 151841-001		B71-90-3/4m
	13/16"		B71-90-13/16m
	7/8" = 153340-001		B71-90-7/8m
	15/16"		B71-90-15/16m
	1" = 159722-001		B71-90-1m
	1-1/8"		B71-90-1-1/8m
	1-1/4"		B71-90-1-1/4m

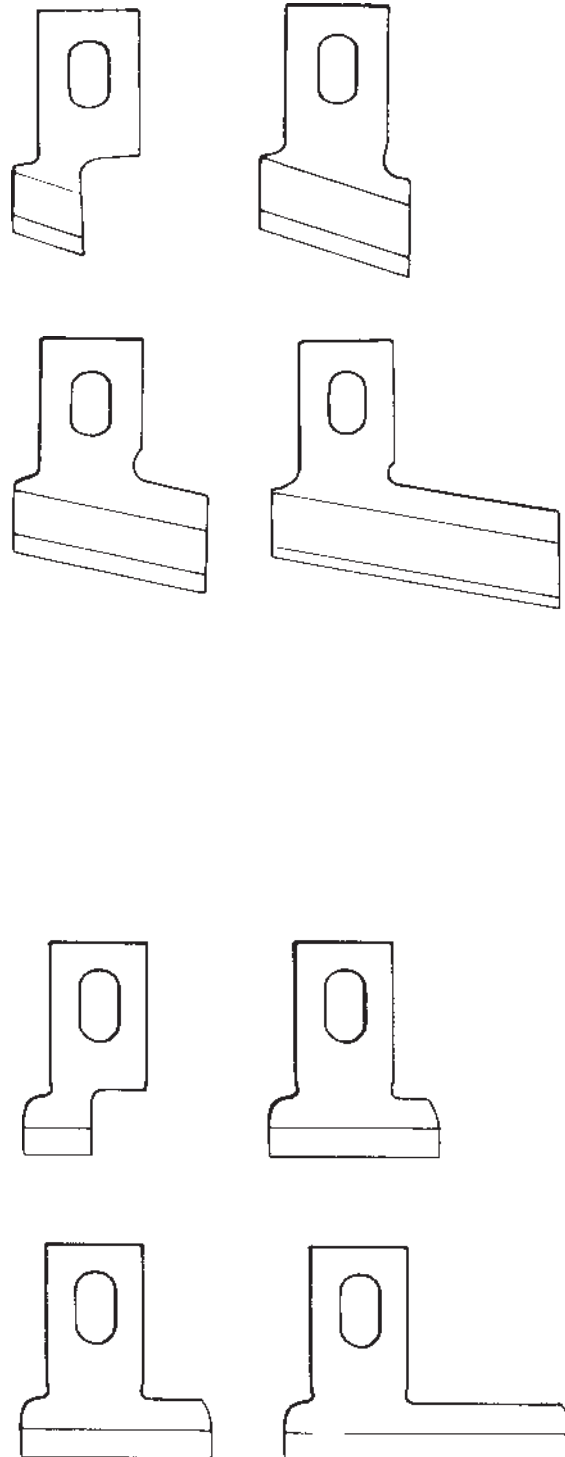

Brother

CT = Hartmetall
 Carbide Tip

LK3-B430, -B433, -B434, -B441		
	Originalnummer <i>Genuine no.</i>	Artikelnummer <i>Item-no.</i> PREMIUM QUALITY
Messer <i>Knife</i>	152901-001	B152901-001m
	152905-001	B152905-001m
	152906-001	B152906-001m
	154176-001	B154176-001m

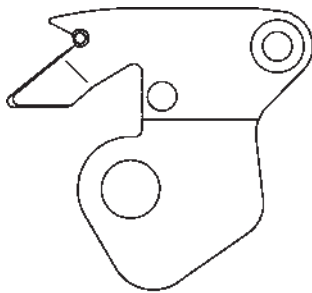

B152901-001m



B152905-001m

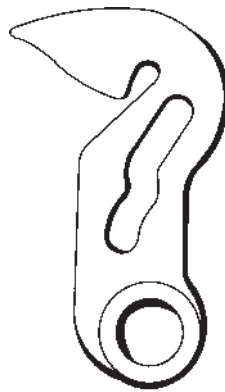

B152906-001m

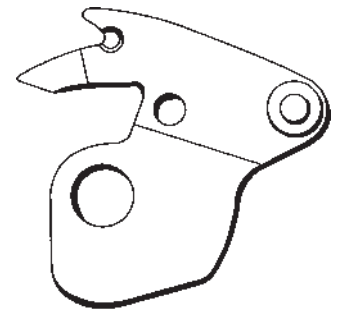

B154176-001m

LK3-B484		
	Originalnummer <i>Genuine no.</i>	Artikelnummer <i>Item-no.</i> PREMIUM QUALITY
Messer <i>Knife</i>	S00706-201	BS00706-201m
	S00713-001	BS00713-001m

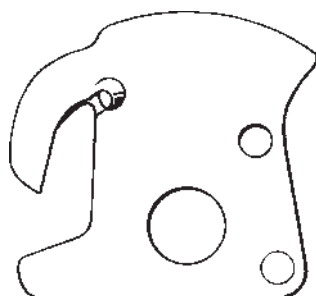

BS00706-201m



BS00713-001m

Brother

CT = Hartmetall
Carbide Tip

LS2-B837			
		Originalnummer <i>Genuine no.</i>	Artikelnummer <i>Item-no.</i> STANDARD
Nähgarnitur für Standardarbeiten <i>Gauge set for standard operations</i>	Standardfuß <i>Standard Foot</i>	150962-001	B240148
		183007-001	B240149
Kantenfuß <i>Cording Foot</i>		151568-001	BD-4368
		183032-001	BD-4367
Kederfußsatz für <i>Piping foot set for x4,8 mm</i>	Kederfuß <i>Piping Foot</i>	151548-001	BD-3445H/1
		183022-001	BD-3445H/2
Kederfußsatz für <i>Piping foot set for x6,4 mm</i>	Kederfuß <i>Piping Foot</i>	151550-001	BD-3445I/1
		183023-001	BD-3445I/2



B240148



B240149



BD-4368

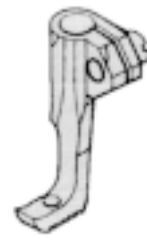

BD-4367

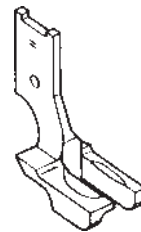

BD-3445H/1
BD-3445I/1



BD-3445H/2
BD-3445I/2

LS2/LT2-B832, B833, B837		
	Originalnummer <i>Genuine no.</i>	Artikelnummer <i>Item-no.</i> PREMIUM QUALITY
Messer <i>Knife</i>	153019-001	B21-4001m
	159365-001	B159365-001m



B21-4001m



B159365-001m

Brother

CT = Hartmetall
 Carbide Tip

LS5-P73/P81+B13		
	Originalnummer <i>Genuine no.</i>	Artikelnummer <i>Item-no.</i> PREMIUM QUALITY
Messer <i>Knife</i>	S27634-001	B119202m



B119202m

LT2-B842		
	Originalnummer <i>Genuine no.</i>	Artikelnummer <i>Item-no.</i> PREMIUM QUALITY
Messer <i>Knife</i>	S07527-001	BS07527-001m
Fänger <i>Catcher</i>	S07526-001	BS07526-001m



BS07527-001m

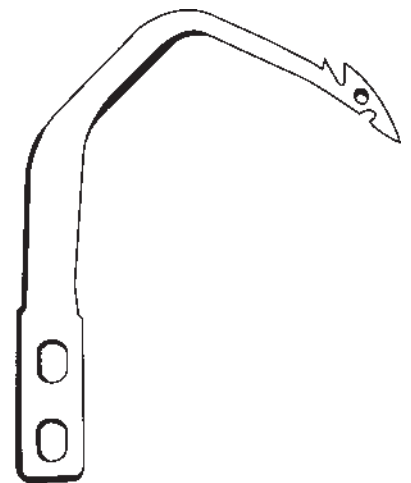

BS07526-001m

HOMELock		
	Originalnummer <i>Genuine no.</i>	Artikelnummer <i>Item-no.</i> PREMIUM QUALITY
Kettenstichgreifer <i>Looper</i>	127814-001	B127814-001m
	127815-001	B127815-001m
Spreizer <i>Spreader</i>	127260-001	B127260-001m

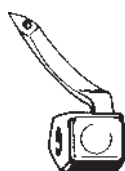

B127814-001m

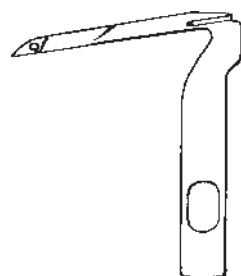

B127815-001m

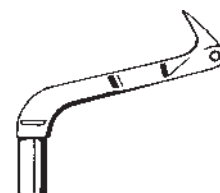

B127260-001m

Clinton

CT = Hartmetall
 Carbide Tip

UNION SPECIAL 39500, 39600 / W & G 504, 514		
	Originalnummer Genuine no.	Artikelnummer Item-no. PREMIUM QUALITY
Messer Knife	01-4434-01	B01-4434-01m
	01-4435-01	B01-4435-01m

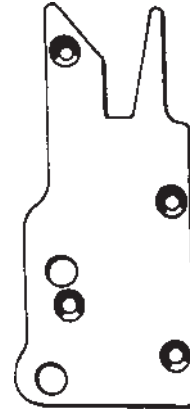

B01-4434-01m

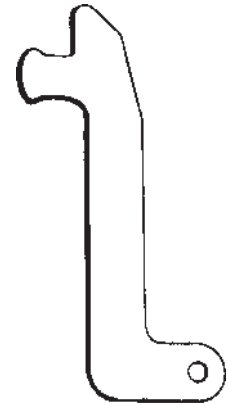

B01-4435-01m

Consew

225, 226, 255			
		Originalnummer Genuine no.	Artikelnummer Item-no. STANDARD
Nähgarnitur für Standardarbeiten Gauge set for standard operations	Standardfuß Standard Foot	10661	B240149
		10663	B240148
	Stichplatte Needle Plate	10863	B240025
	Transporteur Feed Dog	10864	B240075
Kantenfuß Cording Foot			BD-4367
			BD-4368
Kederfußsatz Piping foot set x4,8mm	Kederfüße Piping Feet	C31x3/16	BD-3445H/1
		C301x3/16	BD-3445H/2
Kederfußsatz Piping foot set x6,4mm	Kederfüße Piping Feet	C31x1/4	BD-3445I/1
		C301x1/4	BD-3445I/2



B240149



B240148



B240025

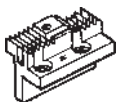

B240075

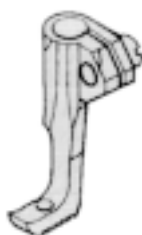

BD-4367



BD-4368

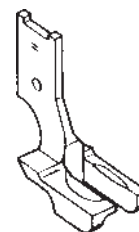

BD-3445H/1
 BD-3445I/1



BD-3445H/2
 BD-3445I/2

Consew

CT = Hartmetall
 Carbide Tip

240			
	Originalnummer <i>Genuine no.</i>	Artikelnummer <i>Item-no.</i> STANDARD	
Heftknopfklammer <i>Tacking Button Clamp</i>	5300A	BD-5003	
Flachknopfklammer <i>Straight Button Clamp</i>	585-N	BD-5002	
Ösenknopfklammer <i>Shank Button Clamp</i>	623-N	BD-5001	
Ösenknopfklammer (neu) <i>Shank Button Clamp (new)</i>		BD-5004	
Ersatzteile <i>Spare parts</i> für / for BD-5001	Transportplatte <i>Feed Plate</i>	5621	B24-281
	Knopfauflage, niedrig <i>Support Block, low</i>	5624	B115-128
	Knopfauflage, mittel <i>Support Block, med.</i>	5623	B115-125
	Knopfauflage, hoch <i>Support Block, high</i>		B115-133
	Klammerkopf, kpl. <i>Button Holder Set, cpl</i>	622-3	B175890
Ersatzteile <i>Spare parts</i> für / for BD-5002	Knopfklammerträger <i>Button Clamp Arch</i>	5086	BD-5008
	Klammerbacke, links <i>Jaw, left</i>	5090-N	B45-347
	Klammerbacke, re. <i>Jaw, right</i>	5089-N	B45-346
	Klemmfeder, links <i>Jaw Spring, left</i>	5092-N	B21-337
	Klemmfeder, rechts <i>Jaw Spring, right</i>	5091-N	B21-336
Ersatzteile <i>Spare parts</i> für / for BD-5004	Knopfauflage, niedrig <i>Support Block, low</i>		B115-128N
	Knopfauflage, mittel <i>Support Block, med.</i>		B115-125N
	Knopfauflage, hoch <i>Support Block, high</i>		B115-133N
	Klammerblech, unten <i>Lower Holder Clamp Blade</i>	162-20	B162-20
	Klammerblech, oben <i>Upper Holder Clamp Blade</i>	162-21	B162-21
	Klammerkopf, kpl. <i>Button Holder Set,</i>	200-20	B200-20

1.5

Consew

CT = Hartmetall
 Carbide Tip

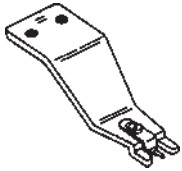

BD-5003

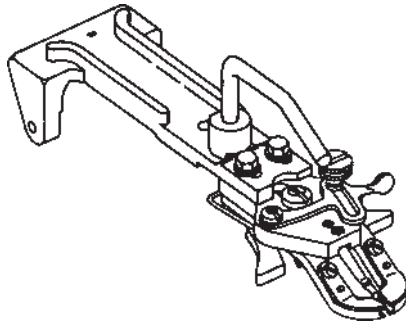

BD-5002

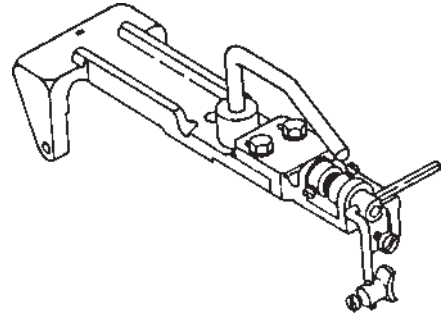

BD-5001

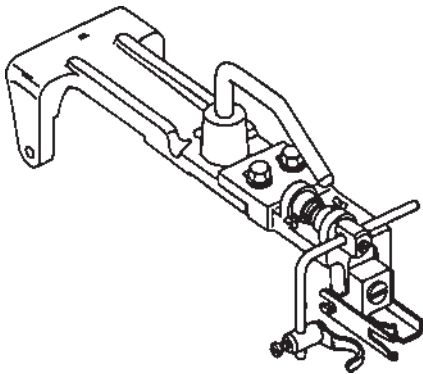

BD-5004

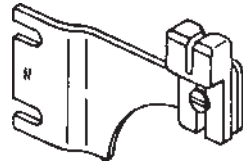

B24-281



B115-128



B115-125



B115-133

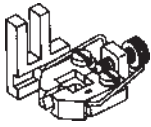

B175890

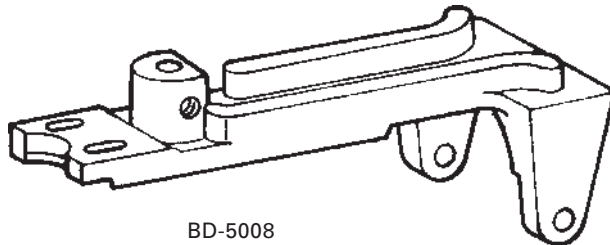

BD-5008

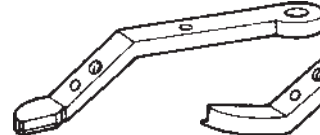

B45-347

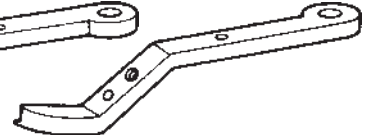

B45-346



B21-337



B21-336



B115-128N



B115-125N

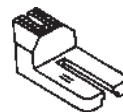

B115-133N

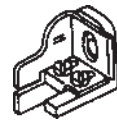

B200-20

260, 261		
	Originalnummer Genuine no.	Artikelnummer Item-no. PREMIUM QUALITY
Kettenstichgreifer Looper	175085	BD-3068m
	175547	BD-3069m



BD-3068m



BD-3069m

Duerkopp-Adler (Adler)

CT = Hartmetall
 Carbide Tip

67, 167, 267			
		Originalnummer Genuine no.	Artikelnummer Item-no. STANDARD
Nähgarnitur, 2 Zehen Gauge Set, 2 toes	Standardfuß Standard Foot	067220633	BD-3446F/2
	Standardfuß Standard Foot	067220723	BD-3446F/1
Nähgarnitur, 2 Zehen Gauge Set, 2 toes	Standardfuß Standard Foot	167220183	BD-3446D/2
	Standardfuß Standard Foot	167220193	BD-3446D/1
Kantenfußsatz Cording Foot Set	Kantenfuß, li. Zehe Cording Foot, le. toe	067220706	BD-3444B/2
	Kantenfuß, li. Zehe Cording Foot, le. toe	067220780	BD-3444B/1
Kantenfußsatz Cording Foot Set	Kantenfuß, re. Zehe Cording Foot, ri. toe	067220700	BD-3444/2
	Kantenfuß, re. Zehe Cording Foot, ri. toe	067220790	BD-3444/1
Kederfußsatz Piping Foot Set x4,8 mm	Kederfüße Piping Feet	067220683	BD-3445/2
		067220760	BD-3445/1
Kederfußsatz Piping Foot Set x6,4 mm	Kederfüße Piping Feet	067220693	BD-3445A/2
		067220770	BD-3445A/1
Nähgarnitur Gauge Set	Stichplatte Needle Plate	067200360	BD-3433
	Transporteur Feed Dog	067210280	BD-3434
Nähgarnitur Gauge Set	Stichplatte Needle Plate	167200070	BD-3433A
	Transporteur Feed Dog	167210100	BD-3434A
Apparate- Nähgarnitur Attachment Gauge Set	Apparatefüße Attachment Feet	067220803	B067220803
	Apparatefüße Attachment Feet	067220810	B067220810
	Stichplatte Needle Plate	067200390	B067200390
	Transporteur Feed Dog	067210300	B067210300
	Apparateträger Attachment Bracket	067241083	B067241083
Umbaugarnitur, kpl. wie zuvor beschrieben Conversion Kit, cpl. as described before			BAD67

1.5

Duerkopp-Adler (Adler)

CT = Hartmetall
Carbide Tip



BD-3446F/2



BD-3446F/1



BD-3446D/2



BD-3446D/1



BD-3444B/2



BD-3444B/1



BD-3444/2



BD-3444/1



BD-3445/2
BD-3445A/2



BD-3445/1
BD-3445A/1



BD-3433



BD-3434



BD-3433A



BD-3434A



B067220803



B067220810

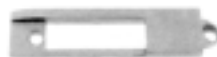

B067200390



B067210300



B067241083

Duerkopp-Adler (Adler)

CT = Hartmetall
 Carbide Tip

68, 268, 368		
	Originalnummer Genuine no.	Artikelnummer Item-no. PREMIUM QUALITY
Messer Knife	068000460	BD-2626m
	068000668-3.1	BD-2629m
	268330470	BD-2627m
	268350030	B0268350030m
Fänger Catcher	268350010	B0268350010m

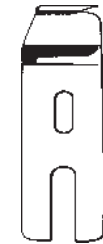

BD-2626m



BD-2629m

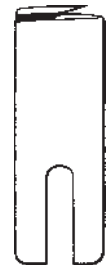

BD-2627m



B0268350030m



B0268350010m

69			
		Originalnummer Genuine no.	Artikelnummer Item-no. STANDARD
Nähwerkzeuge Gauge Set	Standardfuß Standard Foot	069003943	B069003943
	Standardfuß Standard Foot	069221213	B069221213
	Stichplatte Needle Plate	069001330	B069001330
	Transporteur Feed Dog	069002680	B069002680
Apparate- Nähgarnitur Attachment Gauge Set	Apparatefüße Attachment Feet	069003910	B069003910
	Apparatefüße Attachment Feet	069221003	B069221003
	Stichplatte Needle Plate	069201000	B069201000
	Transporteur Feed Dog	069211000	B069211000
	Apparateträger Attachment Bracket	069001494	B069001494
Umbaugarnitur, kpl. wie zuvor beschrieben Conversion Kit, cpl. as described before			BAD69



B069003943



B069221213



B069001330



B069002680



B069003910



B069221003



B069201000



B069211000



B069001494

Duerkopp-Adler (Adler)

CT = Hartmetall
Carbide Tip

67, 167, 267, 367, 467, 477, 550, 767, 768		
	Originalnummer Genuine no.	Artikelnummer Item-no. PREMIUM QUALITY
Messer Knife	067000460HSS	BD-2648m
	067000462HSS	BD-2644HSSm
	067009360	BD-2649m
	067330570	BD-2639m
	067330580	BD-2640m
	067330580CT	BD-2640CTm
	067330700	BD-2642HSSm
	067351220	BD-2645m
	067351230	BD-2647m
	167000461	BD-2651m
	167000462	BD-2652m
	167033002(CT)	BD-2653CTm
	167350010	BD-2646m
	367210240CT	BD-2654CTm
	367210240HSS	BD-2654HSSm
	367330780	BD-2650m
	367331300HSS	BD-2641m
	367350050	B0367350050m
	367350070	B0367350070m
	370221570	B0370221570m
	467200220	B0467200220m
	467350330	B0467350330m
	467350450	B0467350450m
	477200140	B0477200140m
	477330240	B0477330240m
	767350260	B0767350260m
767350280	B0767350280m	

Duerkopp-Adler (Adler)

CT = Hartmetall
 Carbide Tip



BD-2648m



BD-2644HSSm



BD-2649m



BD-2639m



BD-2640m



BD-2640CTm



BD-2645m



BD-2647m



BD-2651m



BD-2652m



BD-2653CTm



BD-2642HSSm



BD-2646m



BD-2641m

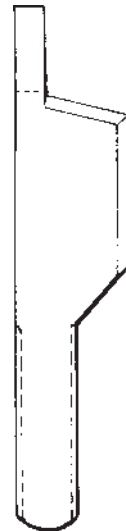

BD-2650m

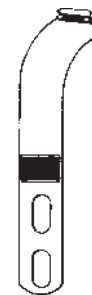

B0367350070m



B0367350050m



BD-2654CTm



BD-2654HSSm



B0370221570m



B0467200220m



B046350330m



B0467350450m



B0477200140m

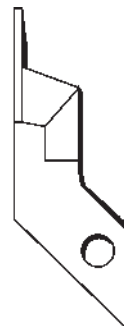

B0477330240m



B0767350260m



B0767350280m

Duerkopp-Adler (Adler)

77			
	Originalnummer <i>Genuine no.</i>	Artikelnummer <i>Item-no.</i> STANDARD	Artikelnummer <i>Item-no.</i> PREMIUM QUALITY
Kettenstichgreifer <i>Looper</i>	077150500	BD-3083	BD-3083m

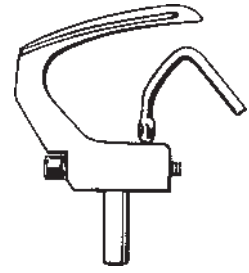

BD-3083
BD-3083m

81			
	Originalnummer <i>Genuine no.</i>	Artikelnummer <i>Item-no.</i> STANDARD	Artikelnummer <i>Item-no.</i> PREMIUM QUALITY
Messer <i>Knife</i>	081000582CT		BD-2633CTm
	081000660		BD-2631m
	081000820		BD-2630m
	083000660	BD-2634	BD-2634m
	083000820	BD-2632	BD-2632m
Kettenstichgreifer <i>Looper</i>	081001480	BD-2637	
	081001520	BD-2638	

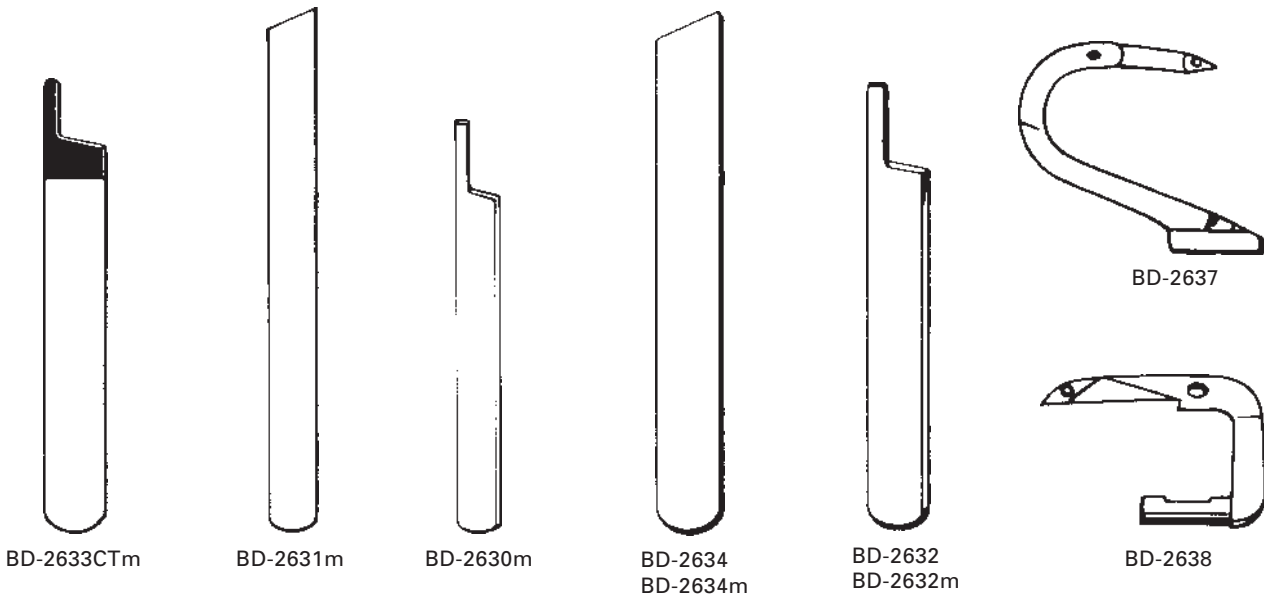

BD-2633CTm

BD-2631m

BD-2630m

BD-2634
BD-2634m

BD-2632
BD-2632m

BD-2638

296		
	Originalnummer <i>Genuine no.</i>	Artikelnummer <i>Item-no.</i> PREMIUM QUALITY
Messer <i>Knife</i>	296200020	BD-2655m
	296330430CT	BD-2656CTm



BD-2655m



BD-2656CTm

Duerkopp-Adler (Adler)

CT = Hartmetall
 Carbide Tip

367, 467, 767			
		Originalnummer Genuine no.	Artikelnummer Item-no. STANDARD
Nähgarnitur Gauge Set	Standardfuß Standard Foot	167220183	BD-3446D/2
	Standardfuß Standard Foot	367220993	B367220993
	Stichplatte Needle Plate	467200090	B467200090
	Transporteur Feed Dog	467210060	B467210060
Kantenfußsatz Cording Foot Set	Kantenfuß, li. Zehe Cording Foot, le. toe	067220706	BD-3444B/2
	Kantenfuß, li. Zehe Cording Foot, le. toe	367220283	B367220283
Kantenfußsatz Cording Foot Set	Kantenfuß, re. Zehe Cording Foot, ri. toe	067220700	BD-3444/2
	Kantenfuß, re. Zehe Cording Foot, ri. toe	367220343	B367220343
Kederfußsatz Piping Foot Set x5,0 mm	Kederfüße Piping Feet	067220683	BD-3445/2
	Kederfüße Piping Feet	367220123	B367220123
Kederfußsatz Piping Foot Set x6,0 mm	Kederfüße Piping Feet	067220693	BD-3445A/2
	Kederfüße Piping Feet	367220133	B367220133
Apparate- Nähgarnitur (rechts) Attachment Gauge Set (right)	Apparatefüße Attachment Feet	067220803	B067220803
	Apparatefüße Attachment Feet	367220503	B367220503
	Stichplatte Needle Plate	367200220	B367200220
	Transporteur Feed Dog	367210160	B367210160
	Apparateträger Attachment Bracket	367240264	B367240264
	Trägerplatte Bracket Base Plate	367240423	B367240423
Umbaugarnitur, kpl. wie oben beschrieben Conversion Kit, cpl. as described above			BAD467
Apparate- Nähgarnitur (links) Attachment Gauge Set (left)	Apparatefüße Attachment Feet	067220993	B067220993
	Apparatefüße Attachment Feet	367220103	B367220103
	Stichplatte Needle Plate	367200290	B367200290
	Transporteur Feed Dog	367210200	B367210200
	Apparateträger Attachment Bracket	367240264	B367240264
	Trägerplatte Bracket Base Plate	367240423	B367240423

1.5

Dürkopp-Adler (Adler)

CT = Hartmetall
 Carbide Tip

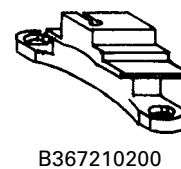
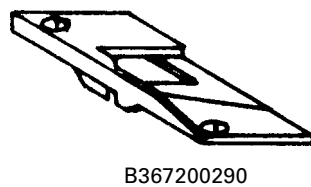
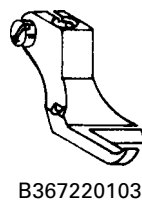
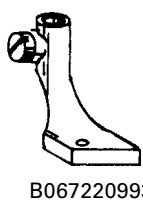
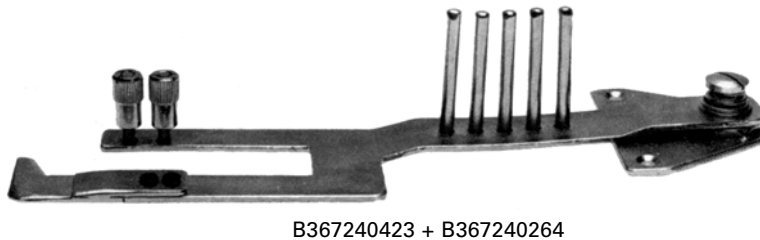
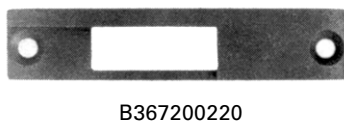
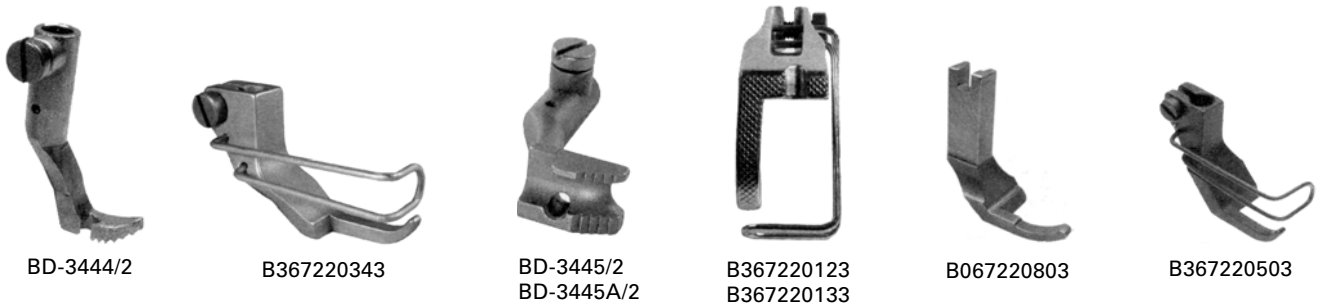

Duerkopp-Adler (Adler)

CT = Hartmetall
 Carbide Tip

396, 550		
	Originalnummer Genuine no.	Artikelnummer Item-no. PREMIUM QUALITY
Messer Knife	170200190	BD-2663Am
	396200090	BD-2661m
	396330690	BD-2662m
	396330700	BD-2663m
	396331600	BD-2663Bm
	396350750	BD-2660m



BD-2663Am



BD-2661m

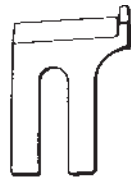

BD-2662m



BD-2663m



BD-2663Bm



BD-2660m

971		
	Originalnummer Genuine no.	Artikelnummer Item-no. PREMIUM QUALITY
Messer Knife	971440140CT	BD-2664CTm
	971440180	BD-2665m
	971440180CT	BD-2665CTm
	971440140	BD-2664m

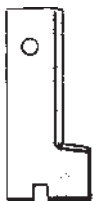

BD-2664CTm



BD-2665m



BD-2665CTm

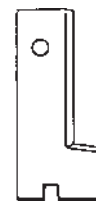

BD-2664m

Duerkopp-Adler (Adler)

CT = Hartmetall
 Carbide Tip

1296			
	Originalnummer <i>Genuine no.</i>	Artikelnummer <i>Item-no.</i> STANDARD	Artikelnummer <i>Item-no.</i> PREMIUM QUALITY
Messer Knife	129171853	BD-2889	BD-2889m
	129175540	BD-2886	BD-2886m



BD-2889
 BD-2889m



BD-2886
 BD-2886m

Duerkopp-Adler (Duerkopp)

211 mit FA / with TC			
	Originalnummer <i>Genuine no.</i>	Artikelnummer <i>Item-no.</i> STANDARD	
Stichplatte <i>Needle Plate</i>	GP11	BD-3421	
Transporteur <i>Feed Dog</i>	GP12	BD-3422	
Nähgarnitur, fein <i>Gauge Set, fine</i>	Stichplatte <i>Needle Plate</i>	211009795	B211-9795
	Transporteur <i>Feed Dog</i>	211050511	B211-50511
Nähgarnitur, mittel <i>Gauge Set, medium</i>	Stichplatte <i>Needle Plate</i>	211009795	B211-9795
	Transporteur <i>Feed Dog</i>	211050505	B211-50505
Nähgarnitur, grob <i>Gauge Set,</i>	Stichplatte <i>Needle Plate</i>	211009823	B211-9823
	Transporteur <i>Feed Dog</i>	211009824	B211-9824



BD-3421

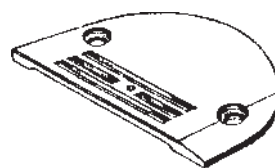

B211-9795

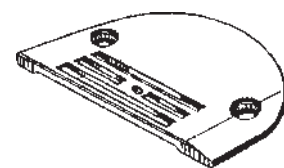

B211-9823

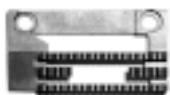

BD-3422

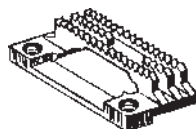

B211-50511

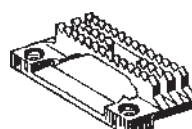

B211-50505

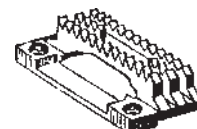

B211-9824

Duerkopp-Adler (Duerkopp)

CT = Hartmetall
 Carbide Tip

211, 212, 219, 227, 237, 238, 249, 265, 370, 380 271, 272, 273, 274, 275, 697, 739-23			
	Originalnummer <i>Genuine no.</i>	Artikelnummer <i>Item-no.</i> STANDARD	Artikelnummer <i>Item-no.</i> PREMIUM QUALITY
Messer <i>Knife</i>	211050366		BD-2714m
	212004931CT		BD-2715CTm
	212011368		BD-2716CTm
	227000682		B0227000682m
	227000683		B227683m
	238016496		B0238016496m
	265002197		B0265002197m
	265008772		B0265008772m
	265012265		B0265012265m
	272007042		B0272007042m
	272007045		B0272007045m
	272076157		B0272076157m
	697002075		B0697002075m
	211009685	BD-2713	BD-2713m
	219006708A	BD-2712	BD-2712m
	219003963		BCT219-3963m
	238001417HSS		BD-2720Am
	238001418HSS		BD-2720m
	238006549		B238-6549m
	380007293		B380-7293m
	271001483		B271-1483m
271001497		B271-1497m	
Fadenanzugsfeder <i>Take-up Spring</i> (211, 212, 219)	204000135	BD-3419	
Feder <i>Spring</i> (211, 212, 219)	004000790	BD-3420	

Duerkopp-Adler (Duerkopp)

CT = Hartmetall
 Carbide Tip

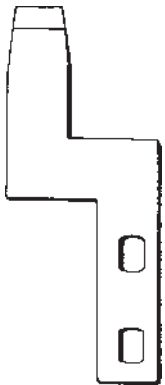

BD-2714m



BD-2715CTm

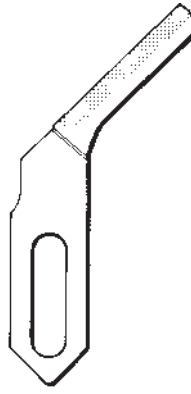

BD-2716CTm



B0227000682m



B0238016496m



B227683m



B0265002197m



B0265008772m



B0265012265m

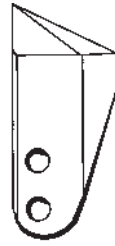

B0272007042m



B0272007045m



B0272076157m



B0697002075m

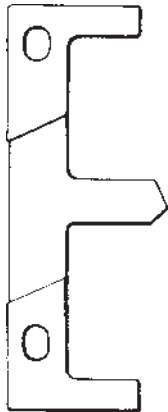

BD-2713
 BD-2713m

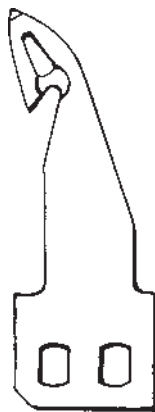

BD-2712
 BD-2712m



BCT219-3963m



BD-2720Am

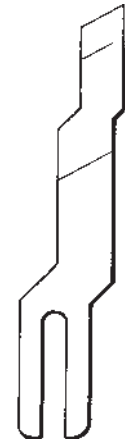

BD-2720m

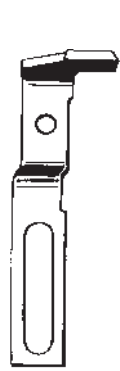

B238-6549m

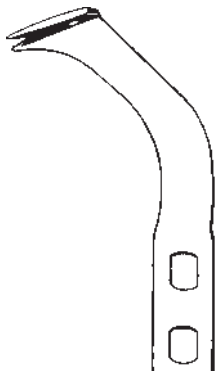

B380-7293m

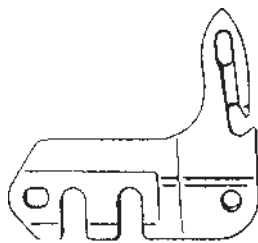

B271-1483m

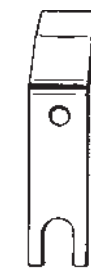

B271-1497m

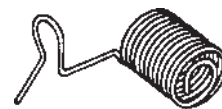

BD-3419



BD-3420

Duerkopp-Adler (Duerkopp)

CT = Hartmetall
 Carbide Tip

212			
		Originalnummer <i>Genuine no.</i>	Artikelnummer <i>Item-no.</i> STANDARD
Standardfuß <i>Standard Foot</i>		212000903	B212-903
		212001643	BD-4153F
Ausgleichsfuß <i>Compensating Foot</i> 1/32"	Links <i>Left</i>	212001612	B720F
	Rechts <i>Right</i>	212001613	B710F
Ausgleichsfuß <i>Compensating Foot</i> 1/16"	Links <i>Left</i>	212001614	B721F
	Rechts <i>Right</i>	212001615	B711F
Ausgleichsfuß <i>Compensating Foot</i> 1/8"	Links <i>Left</i>	212001617	B722F
	Rechts <i>Right</i>	212001618	B712F
Ausgleichsfuß <i>Compensating Foot</i> 3/16"	Links <i>Left</i>	212001619	B723F
	Rechts <i>Right</i>	212001620	B713F
Ausgleichsfuß <i>Compensating Foot</i> 1/4"	Links <i>Left</i>	212001621	B724F
	Rechts <i>Right</i>	212001622	B714F
Kantenfuß <i>Cording Foot</i>	Links 7,0mm <i>Left 7,0mm</i>	212001734	BD-3547F
	Links 5,5mm <i>Left 5,5mm</i>	212001734N	BD-3545F
	Rechts 7,0mm <i>Right 7,0mm</i>	212001738	BD-3548F
	Rechts 5,5mm <i>Right 5,5mm</i>	212001738N	BD-3546F
Reißverschlußfuß <i>Zipper Foot</i>	5,5mm	212002013	BD-3549F
	7,0mm	212002013W	BD-3550F
Teflonfuß <i>Teflon Foot</i>		212001605	B700TF
Teflonsohle für B700TF <i>Teflon sole for B700TF</i>		212001605B	BD-3551A

Duerkopp-Adler (Duerkopp)

CT = Hartmetall
 Carbide Tip



B212-903



BD-4153F



B710F
 B711F
 B712F
 B713F
 B714F



BD-3547F



BD-3545F



BD-3548F



BD-3546F



BD-3549F



BD-3550F



B700TF



BD-3551A

Duerkopp-Adler (Duerkopp)

CT = Hartmetall
 Carbide Tip

212 mit FA / with TC			
		Originalnummer Genuine no.	Artikelnummer Item-no. STANDARD
Nähgarnitur für GP- Fadenabschneider Gauge Set for GP thread cutter	Stichplatte Needle Plate	GP13	BD-3423
	Transporteur Feed Dog	GP14	BD-3424
Nähgarnitur, grob Gauge Set, rough	Stichplatte Needle Plate	212083284	B212-83284
	Transporteur Feed Dog	212083288	B212-83288



BD-3423



BD-3424

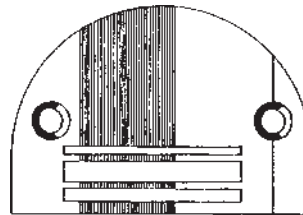

B212-83284

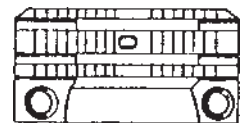

B212-83288

237-22, -23		
	Originalnummer Genuine no.	Artikelnummer Item-no. PREMIUM QUALITY
Messer Knife	204001065	BD-2717m



BD-2717m

Duerkopp-Adler (Duerkopp)

CT = Hartmetall
 Carbide Tip

239, 241			
		Originalnummer Genuine no.	Artikelnummer Item-no. STANDARD
Nähgarnitur für Standardarbeiten <i>Gauge Set for standard operations</i>	Standardfuß <i>Standard Foot</i>	241000892	B240149
		241000897	B240148
Nähfußsatz, links <i>Cording Foot Set, left</i>	Kantenfuß, 1 Zehe <i>Cording Foot, 1 toe</i>	241000645	BD-4367
		241000646	BD-4368
Nähfußsatz, rechts <i>Cording Foot Set, right</i>	Kantenfuß, 1 Zehe <i>Cording Foot, 1 toe</i>	241000643	B240158
		241000644	B240135
Kederfußsatz <i>Piping Foot Set x4,8 mm</i>	Kederfuß <i>Piping Foot</i>	241000048	BD-3445H/1
		241000148	BD-3445H/2
Kederfußsatz <i>Piping Foot Set x6,4 mm</i>	Kederfuß <i>Piping Foot</i>	241000064	BD-3445I/1
		241000164	BD-3445I/2

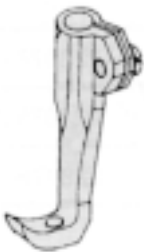

B240149



B240148

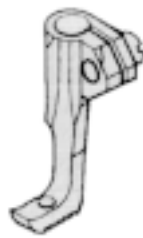

BD-4367



BD-4368

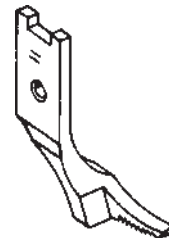

B240158



B240135

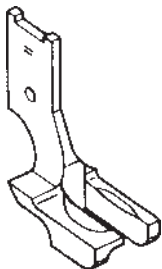

BD-3445H/1
BD-3445I/1



BD-3445H/2
BD-3445I/2

239, 241, 245, 249, 380		
	Originalnummer Genuine no.	Artikelnummer Item-no. STANDARD
Fadenspannung <i>Thread Tension</i>	249000142	B240446
Fadenanzugsfeder <i>Take-up Spring</i>	249000162	BD-3419A

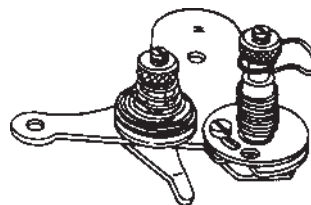

B240446



BD-3419A

Duerkopp-Adler (Duerkopp)

CT = Hartmetall
 Carbide Tip

244, 245, 246, 247, 291, 292, 745		
	Originalnummer Genuine no.	Artikelnummer Item-no. PREMIUM QUALITY
Messer Knife	244014157	B244-14157m
	291003002	B291-03002m
	291003004	B291-03004m



B244-14157m



B291-03002m

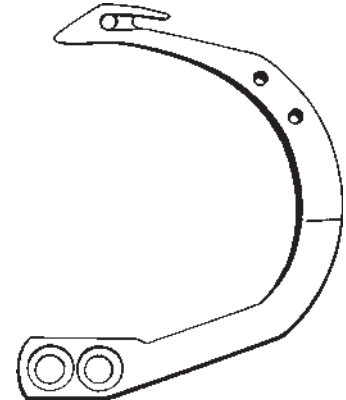

B291-03004m

245		
	Originalnummer Genuine no.	Artikelnummer Item-no. STANDARD
Standardfuß Standard Foot	245000067	BD-3435A
Kantenfuß Cording Foot	245000076	BD-3436A
	245000077	BD-3437A
Kederfüße Piping Feet	1/8" = 3,2 mm	BS560-1/8
	3/16" = 4,8 mm	BS560-3/16
	1/4" = 6,4 mm	BS560-1/4
	3/8" = 9,6 mm	BS560-3/8
Teflonfuß Teflon Foot	245000067T	BD-3439

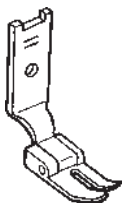

BD-3435A

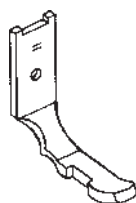

BD-3436A

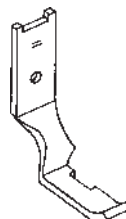

BD-3437A

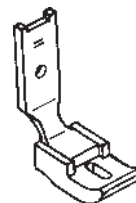

BS560-1/8
 BS560-3/16
 BS560-1/4
 BS560-3/8

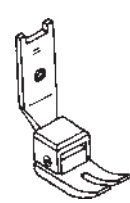

BD-3439

Duerkopp-Adler (Duerkopp)

CT = Hartmetall
Carbide Tip

252		
	Originalnummer <i>Genuine no.</i>	Artikelnummer <i>Item-no.</i> STANDARD
Standardfuß <i>Standard Foot</i>	251000501	BDP-2H
		B210568
Teflonfuß <i>Teflon Foot</i>		B604-107

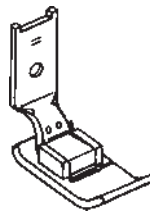

BDP-2H

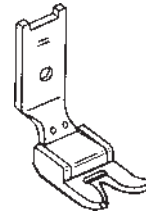

B210568



B604-107

272			
		Originalnummer <i>Genuine no.</i>	Artikelnummer <i>Item-no.</i> STANDARD
Nähgarnitur, fein <i>Gauge Set, fine</i>	Stichplatte <i>Needle Plate</i>	272006501	B272-06501
	Transporteur <i>Feed Dog</i>	272006601	B272-06601
Nähgarnitur, mittel <i>Gauge Set, medium</i>	Stichplatte <i>Needle Plate</i>	272006502	B272-06502
	Transporteur <i>Feed Dog</i>	272006602	B272-06602
Nähgarnitur, grob <i>Gauge Set, rough</i>	Stichplatte <i>Needle Plate</i>	272006503	B272-224NF
	Transporteur <i>Feed Dog</i>	272006603	B272-205NF



B272-06501



B272-06601

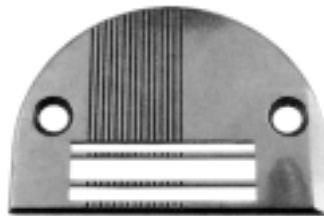

B272-06502



B272-06602



B272-224NF



B272-205NF

Duerkopp-Adler (Duerkopp)

CT = Hartmetall
 Carbide Tip

551, 555, 556, 576, 577			
	Originalnummer Genuine no.	Artikelnummer Item-no. STANDARD	Artikelnummer Item-no. PREMIUM QUALITY
Knopflochmesser Button Hole Knife	55000613 1/4"		BD-2693m
	55000614 5/16"		BD-2694m
	55000601 3/8"		BD-2695m
	55000615 7/16"		BD-2696m
	55000602 1/2"	BD-2697	BD-2697m
	055000604 9/16"	BD-2698	BD-2698m
	055000603 5/8"	BD-2699	BD-2699m
	055000610 7/8"	BD-2700	BD-2700m
	055000605 11/16"	BD-2701	BD-2701m
	055000606 3/4"	BD-2702	BD-2702m
	055000611 13/16"		BD-2703m
	055000612 15/16"	BD-2704	BD-2704m
	055000607 1"	BD-2705	BD-2705m
	055000616 1-1/16"		BD-2706m
	055000617 1-1/8"	BD-2707	BD-2707m
	055000618 1-3/16"		BD-2708m
	055000608 1-1/4"	BD-2709	BD-2709m
	055000620 1-3/8"	BD-2710	
	055000609 1-1/2"	BD-2711	BD-2711m
	576005701 6mm		B0576005701m
	576005702 8mm		B0576005702m
	576005703 10mm		B0576005703m
	576005704 12mm		B0576005704m
	576005705 14mm		B0576005705m
	576005706 16mm		B0576005706m
	576005707 18mm		B0576005707m
576005708 20mm		B0576005708m	
576005709 22mm		B0576005709m	

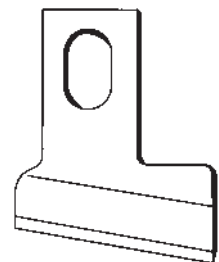
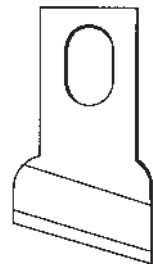

Duerkopp-Adler (Duerkopp)

CT = Hartmetall
Carbide Tip

551, 555, 556, 576, 577			
	Originalnummer Genuine no.	Artikelnummer Item-no. STANDARD	Artikelnummer Item-no. PREMIUM QUALITY
Knopflochmesser Button Hole Knife	576005710 24mm		B0576005710m
	576005711 26mm		B0576005711m
	576005712 28mm		B0576005712m
	576005713 30mm		B0576005713m
Knopflochmesser Buttonhole Knife 90°	556007143 3/8"		B71-90-3/8m
	556007144 7/16"		B71-90-7/16m
	556007146 9/16"		B71-90-9/16m
	556007148 11/16"		B71-90-11/16m
	556007149 3/4"		B71-90-3/4m
	556007150 13/16"		B71-90-13/16m
	556007151 7/8"		B71-90-7/8m
	556007152 15/16"		B71-90-15/16m
	556007157 1-1/4"		B71-90-1-1/4m
	576005721 6mm		B0576005721m
	576005722 8mm		B0576005722m
	576005723 10mm		B0576005723m
	576005724 12mm		B0576005724m
	576005725 14mm		B0576005725m
	576005726 16mm		B0576005726m
	576005727 18mm		B0576005727m
	576005728 20mm		B0576005728m
	576005729 22mm		B0576005729m
	576005730 24mm		B0576005730m
	576005731 26mm		B0576005731m
576005732 28mm		B0576005732m	
576005733 30mm		B0576005733m	
576005734 34mm		B0576005734m	

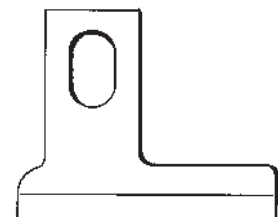

Duerkopp-Adler (Duerkopp)

CT = Hartmetall
 Carbide Tip

551, 555, 556, 576, 577			
	Originalnummer Genuine no.	Artikelnummer Item-no. STANDARD	Artikelnummer Item-no. PREMIUM QUALITY
Messer Knife	556012772		B0556012772m
	556012783		B0556012783m
	556013536		B0556013536m
	577350080		B0577350080m
	577350230		B0577350230m
	577350240		B0577350240m
	577350250		B0577350250m

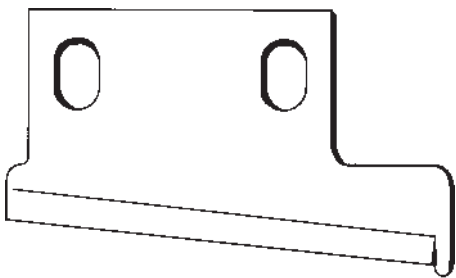

B0556012772m

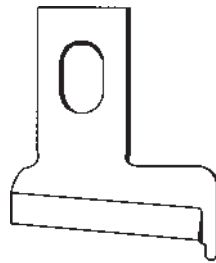

B0556012783m



B0556013536m



B0577350080m

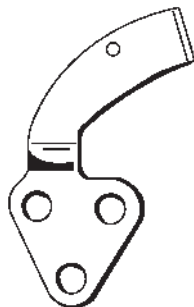

B0577350230m



B0577350240m

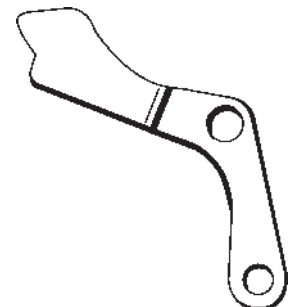

B0577350250m

Duerkopp-Adler (Duerkopp)

CT = Hartmetall
Carbide Tip

557, 558, 578, 579		
	Originalnummer <i>Genuine no.</i>	Artikelnummer <i>Item-no.</i> PREMIUM QUALITY
Messer <i>Knife</i>	557001041	B0557001041m
	557001671	B0557001671m
	558002561	B5582561m
	558002562	B5582562m
	558002564	B5582564m
	558002567	B5582567m
	558008816	B0558008816m
	558008817	B0558008817m
	558008858	B0558008858m
	558008859	B0558008859m
	558008868	B0558008868m
	558008869	B0558008869m
	558008878	B0558008878m
	558008879	B0558008879m
	558009011	B5589011m
	578003363	B0578003363m
	578003365	B0578003365m
	578003366	B0578003366m
Block <i>Cutting Block</i>	557001684MS 25mm	B0557001684MSm
	557001686MS 21mm	B0557001686MSm
	558002405 16mm	B5582405m
	558002406 18mm	B5582406m
	558002408 22mm	B5582408m
	558002410 26mm	B5582410m
	578003281 10mm	B0578003281m
	578003282 12mm	B0578003282m
	578003283 14mm	B0578003283m
	578003284 16mm	B0578003284m

Duerkopp-Adler (Duerkopp)

CT = Hartmetall
 Carbide Tip

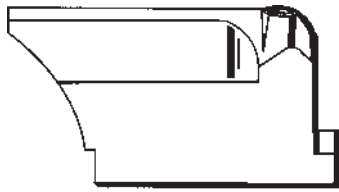

B0557001041m

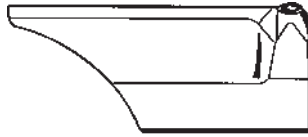

B0557001671m

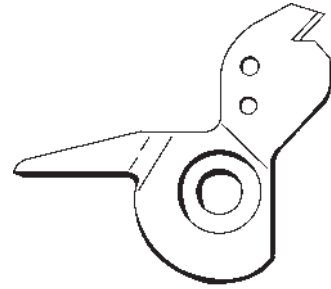

B0558008858m

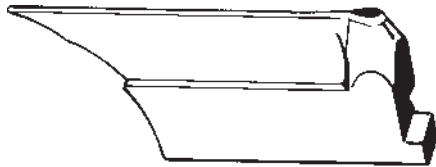

B5582561m
 B5582562m

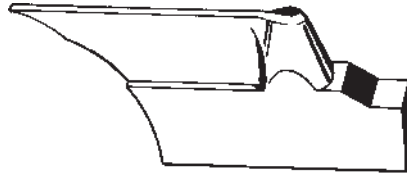

B5582564m
 B5582567m

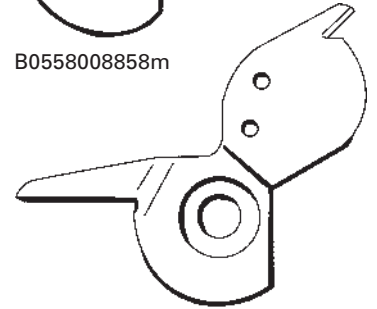

B0558008816m

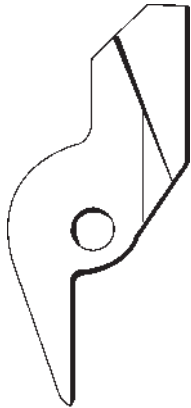

B0558008817m



B0558008859m

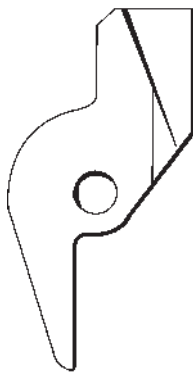

B0558008869m



B0558008879m

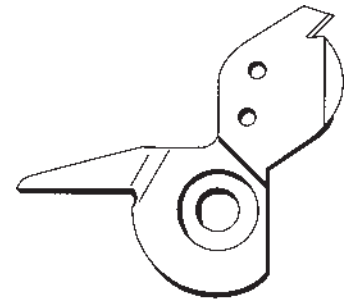

B0558008868m



B0578003363m



B0578003366m

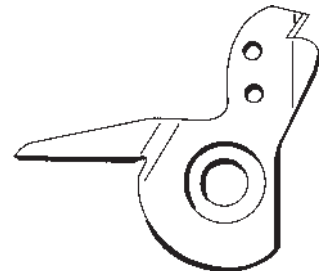

B0558008878m



B5589011m

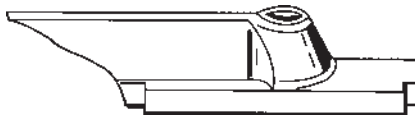

B0578003365m

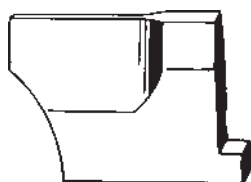

B5582405m
 B5582406m
 B5582408m
 B5582410m

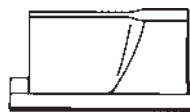

B0578003281m 10mm
 B0578003282m 12mm
 B0578003283m 14mm
 B0578003284m 16mm
 B0578003285m 18mm
 B0578003286m 20mm
 B0578003287m 22mm
 B0578003288m 24mm



B0557001684MSm
 B0557001686MSm

Duerkopp-Adler (Duerkopp)

CT = Hartmetall
 Carbide Tip

557, 558, 578, 579		
	Originalnummer Genuine no.	Artikelnummer Item-no. PREMIUM QUALITY
Block Cutting Block	578003285 18mm	B0578003285m
	578003286 20mm	B0578003286m
	578003287 22mm	B0578003287m
	578003288 24mm	B0578003288m
	578003289 26mm	B0578003289m
	578003290 28mm	B0578003290m
	578003291 30mm	B0578003291m
	578003292 32mm	B0578003292m
	578003293 34mm	B0578003293m
	578003295 38mm	B0578003295m
	578003323 20mm	B0578003323m
	578003324 22mm	B0578003324m
Kettenstichgreifer Looper	557000602A	BD-2722m
	557002035	B0557002035m
	557002872	BD-2721m
	557002872A	BD-2721Am
	557003243	B0557003243m
	557003398	B0557003398m
Spreizer Spreader	557000611	BD-4057m
	557002876K	BD-4058Am
Spreizerplatte Spreader Plate	557000593	B0557000593m

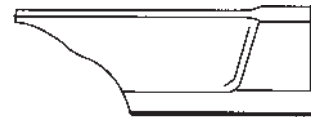

B0578003289m 26mm
 B0578003290m 28mm
 B0578003291m 30mm
 B0578003292m 32mm
 B0578003293m 34mm
 B0578003295m 38mm

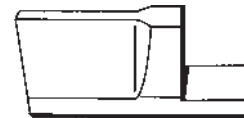

B0578003323m 20mm
 B0578003324m 22mm

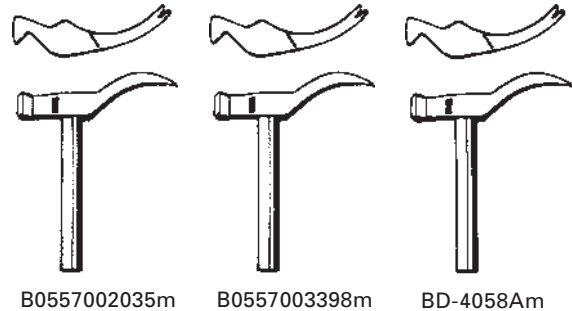

B0557002035m B0557003398m BD-4058Am



BD-2721m



BD-2721Am



B0557003243m



BD-2722m

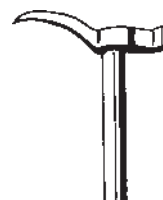

BD-4057m

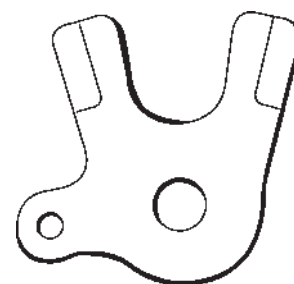

B0557000593m

Duerkopp-Adler (Duerkopp)

CT = Hartmetall
 Carbide Tip

564, 566		
	Originalnummer Genuine no.	Artikelnummer Item-no. PREMIUM QUALITY
Messer Knife	568350050	B0568350050m
	568330760	B119444HSSm
	568330770	B119202HSSm
Kettenstichgreifer Looper		B91-180614-05m



B0568350050m



B119444HSSm



B119202HSSm

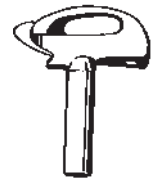

B91-180614-05m

570, 579		
	Originalnummer Genuine no.	Artikelnummer Item-no. PREMIUM QUALITY
Messer Knife	570000961	B0570000961m
	570000962	B0570000962m
	570092908A	B0570092908Am
	570092917A	B0570092917Am
	570092921	B0570092921m
	570092925	B0570092925m



B0570092925m



B0570000961m

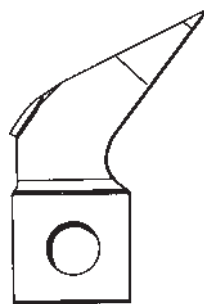

B0570000962m



B0570092908Am



B0570092917Am

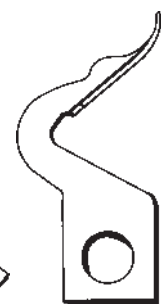

B0570092921m

Duerkopp-Adler (Duerkopp)

CT = Hartmetall
 Carbide Tip

745, 746, 748, 749		
	Originalnummer <i>Genuine no.</i>	Artikelnummer <i>Item-no.</i> PREMIUM QUALITY
Messer <i>Knife</i>	246002553	B2462553m
	246002706	B0246002706m
	746000995	BD-2731m
	746000995A	BD-2727m
	746000996	BD-2732m
	746000996A	BD-2728m
	746000997	BD-2733m
	746000997A	BD-2729m
	746060689	B746060689m
	746060690	B746060690m
	746060691	B746060691m
	746060692	B746060692m
	748000419	B0748000419m



B2462553m



B0246002706m

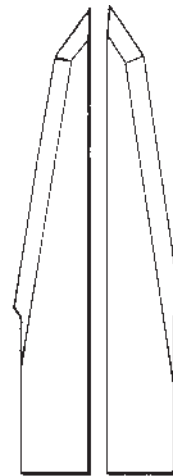

B746060689m B746060690m



B0748000419m

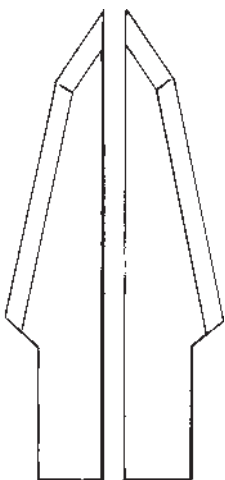

B746060691m B746060692m

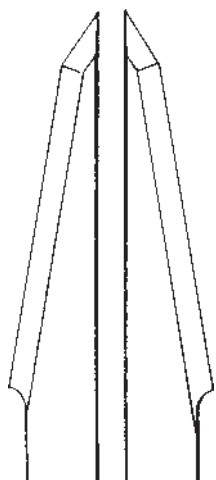

BD-2727m BD-2731m

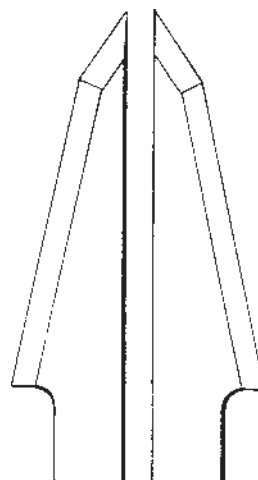

BD-2728m BD-2732m

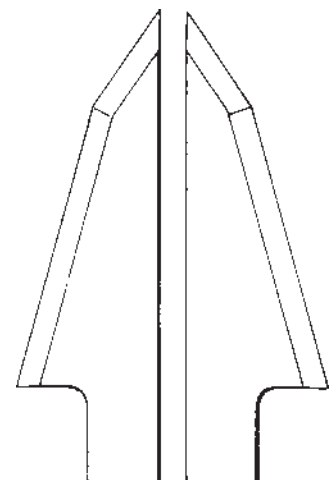

BD-2729m BD-2733m

Eagle

1002		
	Originalnummer <i>Genuine no.</i>	Artikelnummer <i>Item-no.</i> PREMIUM QUALITY
Messer <i>Knife</i>	21-3004	B21-3004m

1005F, 1005FZ		
	Originalnummer <i>Genuine no.</i>	Artikelnummer <i>Item-no.</i> PREMIUM QUALITY
Messer <i>Knife</i>	21-4001	B46-1125-5-581m



B46-1125-5-581m



B21-3004m

1010, 1020, 2001		
	Originalnummer <i>Genuine no.</i>	Artikelnummer <i>Item-no.</i> PREMIUM QUALITY
Messer <i>Knife</i>	21-5602	B21-5602m
Messer <i>Knife</i> (nur / only 2001)	21-3002	B21-3002m
	21-3003	B21-3003m
	21-4587	B21-4587m
Keramikkmesser <i>Ceramic Knife</i> (nur / only 2001)	21-3003-01	B15487m



B21-5602m



B21-3002m



B21-3003m



B15487m



B21-4587m

Juki

CT = Hartmetall
 Carbide Tip

AMS-210, 212		
	Originalnummer <i>Genuine no.</i>	Artikelnummer <i>Item-no.</i> PREMIUM QUALITY
Messer <i>Knife</i>	B2421-205-OAO	BB2421205OAOm
	B2424-210-OOO	BB2424210OOOm
	B2421-210-AAO	BB2421210AAOm
	B2421-210-AOO	BB2421210AOOm

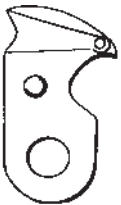

BB2421205OAOm

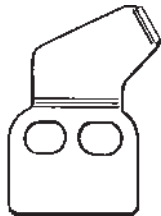

BB2424210OOOm

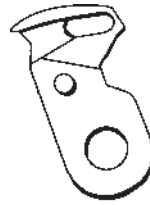

BB2421210AAOm



BB2421210AOOm

APW-192, 193, 321, LH-570		
	Originalnummer <i>Genuine no.</i>	Artikelnummer <i>Item-no.</i> PREMIUM QUALITY
Messer <i>Knife</i>	164-16109	B164-16109m
	166-07301	B166-07301m
	166-07400	B166-07400m
	164-18709	B164-18709m
	164-18600	B164-18600m
	164-18006	B164-18006m



B164-16109m
 B164-18600m



B164-18709m
 B164-18006m

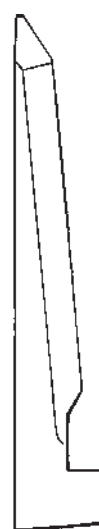

B166-07301m



B166-07400m

Juki

CT = Hartmetall
 Carbide Tip

DDL-227, 555, 5550, DLN-415		
	Originalnummer Genuine no.	Artikelnummer Item-no. STANDARD
Fadenanzugsfeder Take-up Spring	B3128-012-000	BD-3419B
Fadenführung Thread Guide	D2405-555-BOOB	BD2405555BOOB
Fadenführung Thread Guide (DDL-555 und / and DLN-415)	B1113-155-OAO	BB1113155OAO
	B1418-552-BOO	BB1418552BOO



BD-3419B



BD2405555BOOB



BB1113155OAO



BB1418552BOO

Juki

CT = Hartmetall
 Carbide Tip

DDL-555, 5550, DLN-415, 5410, DMN-54/20			
	Originalnummer Genuine no.	Artikelnummer Item-no. STANDARD	Artikelnummer Item-no. PREMIUM QUALITY
Messer Knife	110-40052	B110-40052	
	110-93259	B110-93259	
	113-13053		B113-13053m
	113-20108		B113-20108m
	114-08150		B114-08150m
	114-09257		B114-09257m
	114-09604		B114-09604m
	D2402-415-BAO	BD-2741	BD-2741m
	D2402-555-BAB	BD-2740	BD-2740m
	D2402-555-BAO	BD-2739	BD-2739m
	D2406-555-BOO	BD-2742	BD-2742m
	D2406-555-DOH	BD2406555DOH	BD2406555DOHm



B110-40052



B110-93259



B113-13053m

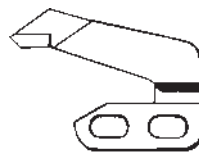

B113-20108m



B114-08150m

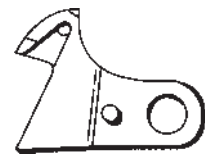

B114-09257m

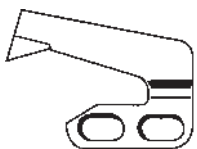

B114-09604m



BD-2741
BD-2741m



BD-2740
BD-2740m



BD-2739
BD-2739m

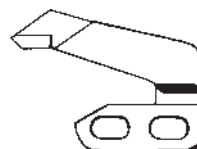

BD-2742
BD-2742m

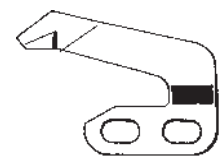

BD2406555DOH
BD2406555DOHm

Juki

CT = Hartmetall
 Carbide Tip

DLM-52, 522		
	Originalnummer <i>Genuine no.</i>	Artikelnummer <i>Item-no.</i> PREMIUM QUALITY
Messer <i>Knife</i>	B4121-522-000	BB4121522000m
	B4121-052-A00	BD-2743m



BB4121522000m



BD-2743m

DMN-530		
	Originalnummer <i>Genuine no.</i>	Artikelnummer <i>Item-no.</i> PREMIUM QUALITY
Messer <i>Knife</i>	B4145-530-B00	BB4145530B00m



BB4145530B00m

Juki

CT = Hartmetall
 Carbide Tip

EF-205, 405, 406, 434, 436, 605, 738 BL3-408, 418, BL4-605, BL-3200 SL-330, 500, 800, 803, 843		
	Originalnummer Genuine no.	Artikelnummer Item-no. PREMIUM QUALITY
Messer Knife	205-9102-01ACT	BD-2759CTm
	305248	BD-2760m
	305249	BD-2759m
	405-9102-01A	B405-9102-01Am
	408-9101-01B	B408-9101-01Bm
	408-9102-01A	B408-9102-01Am
	60507(CT)	B60507m
	60544	B60544m
	PL-Q11-01A	BPL-Q11-01Am
	PL-Q11-01C	BPL-Q11-01Cm
	PL-R11-01A	BPL-R11-01Am
	SE-R11-01A	BSE-R11-01Am
Kettenstichgreifer Looper	418-6101-02A	B418-6101-02Am
	714-6101-01A	B714-6101-01Am

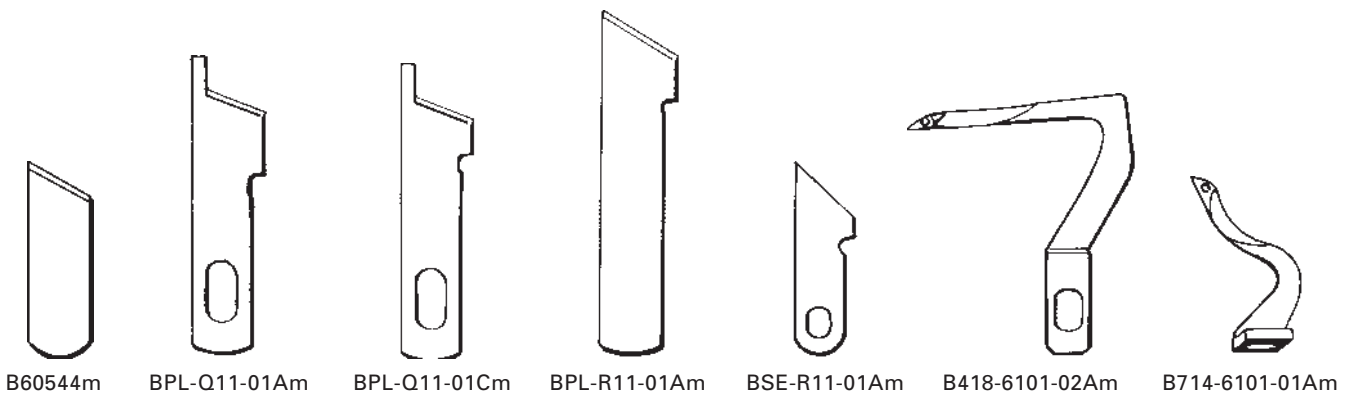
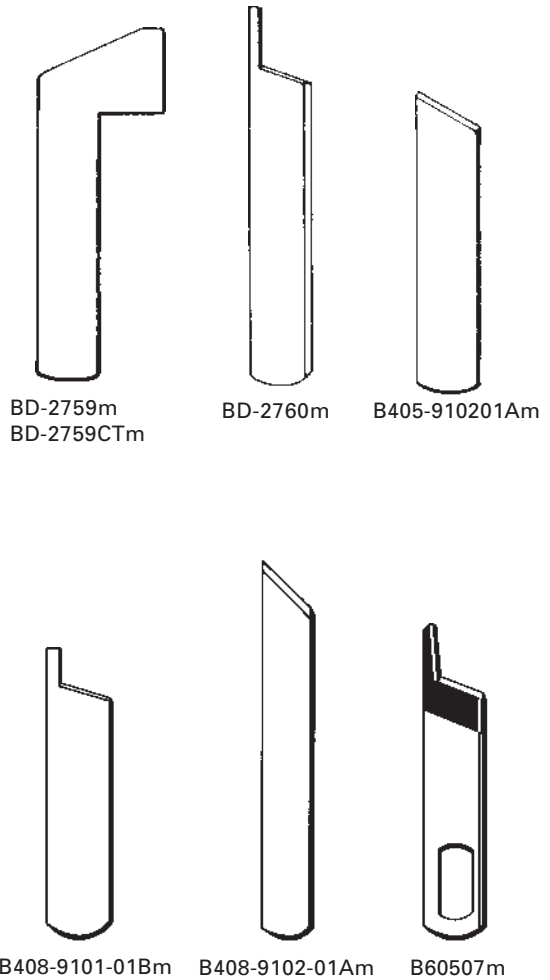

Juki

CT = Hartmetall
 Carbide Tip

LBH-761, 762, 763, 771, 772, 773, 781, 782, 783, 793, 1700			
	Originalnummer Genuine no.	Artikelnummer Item-no. STANDARD	Artikelnummer Item-no. PREMIUM QUALITY
Knopflochmesser Button Hole Knife	- 1/8"		BD-2692m
	B2702-047-FOO 1/4"		BD-2693m
	- 5/16"		BD-2694m
	B2702-047-KOO 3/8"		BD-2695m
	- 7/16"		BD-2696m
	B2702-047-LOO 1/2"	BD-2697	BD-2697m
	B2702-047-HOO 9/16"	BD-2698	BD-2698m
	B2702-047-MOO 5/8"	BD-2699	BD-2699m
	B2702-047-AOO 11/16"		BD-2701m
	B2702-047-NOO 3/4"	BD-2702	BD-2702m
	- 13/16"		BD-2703m
	B2702-047-POO 7/8"	BD-2700	BD-2700m
	- 15/16"		BD-2704m
	B2702-047-QOO 1"	BD-2705	BD-2705m
	- 1-1/16"		BD-2706m
	B2702-047-ROO 1-1/8"	BD-2707	BD-2707m
	- 1-3/16"		BD-2708m
	B2702-047-SOO 1-1/4"	BD-2709	BD-2709
	- 1-3/8"	BD-2710	
	- 1-1/2"	BD-2711	BD-2711m
Knopflochmesser Buttonhole Knife 90°	B2745-771-FOO 1/4"		B71-90-1/4m
	B2745-771-KOO 3/8"		B71-90-3/8m
	B2745-771-LOO 1/2"		B71-90-1/2m
	B2745-771-HOO 9/16"		B71-90-9/16m
	B2745-771-MOO 5/8"		B71-90-5/8m
	B2745-771-NOO 3/4"		B71-90-3/4m
	B2745-771-POO 7/8"		B71-90-7/8m
	B2745-771-QOO 1"		B71-90-1m

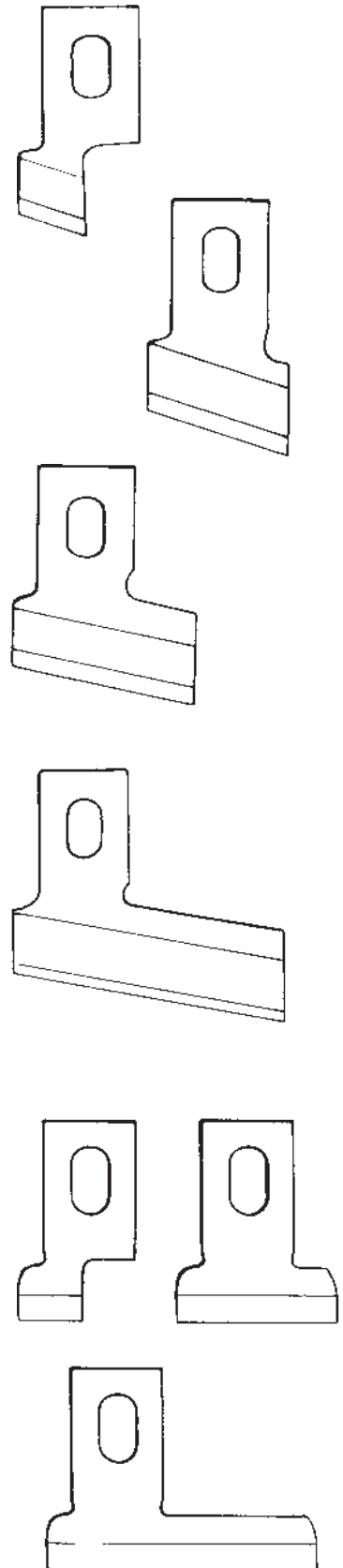

Juki

CT = Hartmetall
 Carbide Tip

LBH-761, 762, 763, 771, 772, 773, 781, 782, 783, 793, 1700			
	Originalnummer Genuine no.	Artikelnummer Item-no. STANDARD	Artikelnummer Item-no. MAIER
Knopflochmesser Buttonhole Knife 90°	- 1-1/8"		B71-90-1-1/8m
	- 1-1/4"		B71-90-1-1/4m
Messer Knife	B2406-761-OAO		BB2406761OAOm
	B2406-771-OAO		BB2406771OAOm
	B2408-761-OOO		BB2408761OOOm
	B2408-771-OOO		BB2408771OOOm
Fadenanzugsfeder Take-up Spring	B3112-761-OOO	BB3112761OOO	
Fadenschere Thread Scissor (nur / only LBH-771, 772, 773, 774)	B2001-771-OAO	BB2001771OAO	

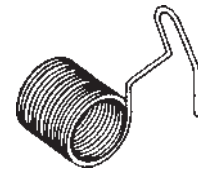

BB3112761OOO

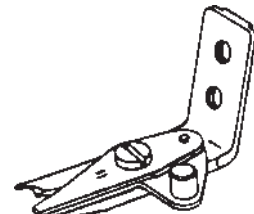

BB2001771OAO

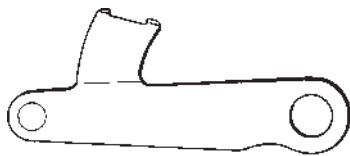

BB2406761OAOm

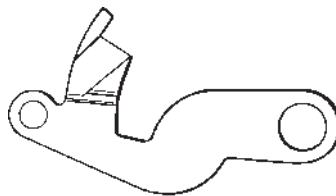

BB2406771OAOm



BB2408761OOOm

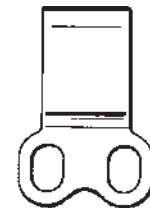

BB2408771OOOm

LH-1152, 1162, 1164		
	Originalnummer Genuine no.	Artikelnummer Item-no. PREMIUM QUALITY
Messer Knife	102-11100	B102-11100m
	102-11118	B102-11118m
	102-11209	B102-11209m
	102-32403	B102-32403m

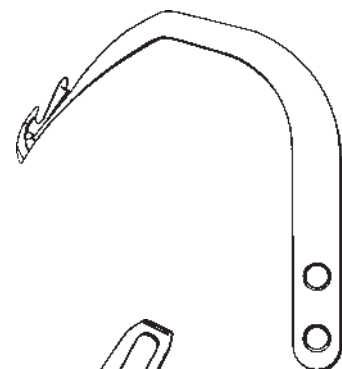

B102-11100m
 B102-11118m

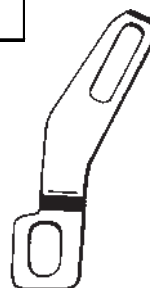

B102-11209m



B102-32403m

Juki

CT = Hartmetall
 Carbide Tip

LH-1152, 1152-5, 512, 515			
		Originalnummer Genuine no.	Artikelnummer Item-no. STANDARD
Fadenspannung Thread Tension (nicht / not LH-1152-5)		B3121-512-OAO	BB3121512OAO
Fadenanzugsfeder Take-up Spring (nicht / not LH-1152-5)		B3128-512-OOO	BB3128512OOO
Nähwerkzeuge x3/16" Gauge set x3/16" für / for LH-1152-5	Nadelhalter Needle Clamp	101-47858	B101-47858-3/16
	Standardfuß Standard Foot	101-52759	B101-52759-3/16
	Stichplatte Throat Plate	101-30300	B101-30300-3/16
	Transporteur Feed Dog	101-67708	B101-67708-3/16
Nähwerkzeuge x1/4" Gauge set x1/4" für / for LH-1152-5	Nadelhalter Needle Clamp	101-48054	B101-48054-1/4
	Standardfuß Standard Foot	101-52957	B101-52957-1/4
	Stichplatte Throat Plate	101-30508	B101-30508-1/4
	Transporteur Feed Dog	101-67906	B101-67906-1/4

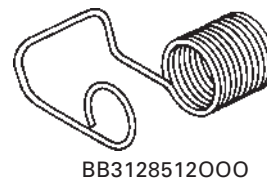
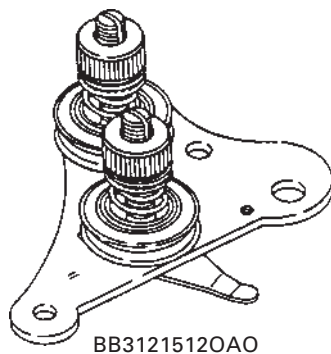

B101-48054-1/4



B101-52957-1/4

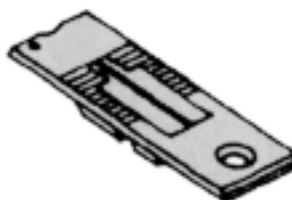

B101-30508-1/4

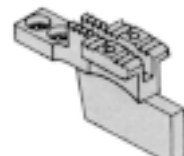

B101-67906-1/4

Juki

CT = Hartmetall
Carbide Tip

LH-1162, 1162-5, 1182, 1182-5			
		Originalnummer Genuine no.	Artikelnummer Item-no. STANDARD
Nähwerkzeuge x3/16" Gauge set x3/16" für / for LH-1162	Nadelhalter Needle Clamp	B1402-526-DALA	BB1402526DALA
	Nadelhalter Needle Clamp	B1402-526-DARA	BB1402526DARA
	Standardfuß Standard Foot	102-22453	B102-22453-3/16
	Stichplatte Throat Plate	101-30300	B101-30300-3/16
	Transporteur Feed Dog	101-67708	B101-67708-3/16
Nähwerkzeuge x1/4" Gauge set x1/4" für / for LH-1162	Nadelhalter Needle Clamp	B1402-526-FALA	BB1402526FALA
	Nadelhalter Needle Clamp	B1402-526-FARA	BB1402526FARA
	Standardfuß Standard Foot	102-22651	B102-22651-1/4
	Stichplatte Throat Plate	101-30508	B101-30508-1/4
	Transporteur Feed Dog	101-67906	B101-67906-1/4
Nähwerkzeuge x3/16" Gauge set x3/16" für / for LH-1162-5 / LH-1182-5	Nadelhalter Needle Clamp	B1402-526-DALA	BB1402526DALA
	Nadelhalter Needle Clamp	B1402-526-DARA	BB1402526DARA
	Standardfuß Standard Foot	102-22453	B102-22453-3/16
	Stichplatte Throat Plate	102-35000	B102-35000-3/16
	Transporteur Feed Dog	102-38103	B102-38103-3/16
Nähwerkzeuge x1/4" Gauge set x1/4" für / for LH-1162-5 / LH-1182-5	Nadelhalter Needle Clamp	B1402-526-FALA	BB1402526FALA
	Nadelhalter Needle Clamp	B1402-526-FARA	BB1402526FARA
	Standardfuß Standard Foot	102-22651	B102-22651-1/4
	Stichplatte Throat Plate	102-35208	B102-35208-1/4
	Transporteur Feed Dog	102-38202	B102-38202-1/4



BB1402526DALA
BB1402526FALA



BB1402526DARA
BB1402526FARA



B102-22453-3/16
B102-22651-1/4



B101-30300-3/16
B101-30508-1/4

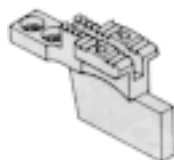

B101-67708-3/16
B101-67906-1/4



B102-35000-3/16
B102-35208-1/4

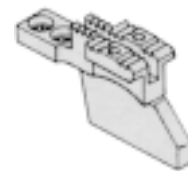

B102-38103-3/16
B102-38202-1/4

Juki

CT = Hartmetall
 Carbide Tip

LK-232		
	Originalnummer Genuine no.	Artikelnummer Item-no. STANDARD
Feder Spring	B3114-232-000	BD-3420B



BD-3420B

LK-280, 980, 1850			
	Originalnummer Genuine no.	Artikelnummer Item-no. STANDARD	Artikelnummer Item-no. PREMIUM QUALITY
Messer Knife	B2421-280-OAO		BB2421280OAOm
	B2424-280-000		BB2424280000m
Stichplatteneinsatz Needle plate insert	B2426-280-000	BB2426280000	
Fadenanzugsfeder Take-up Spring	B3112-761-000	BB3112761000	

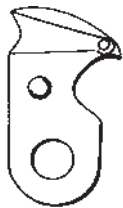

BB2421280OAOm

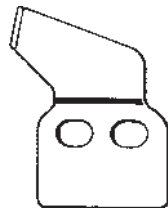

BB2424280000m



BB2426280000

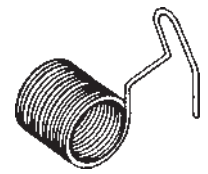

BB3112761000

LU-562, 563			
		Originalnummer Genuine no.	Artikelnummer Item-no. STANDARD
Nähgarnitur für Standardarbeiten Gauge set for standard operations	Standardfuß Standard Foot	B1470-053-000	B240149
		B1525-053-000	B240148
Fadenanzugsfeder Take-up Spring		B3128-051-000	BD-3419C
Feder Spring		B3129-053-000	BD-3420A

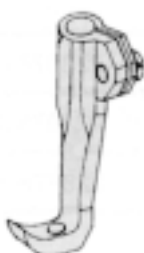

B240149



B240148

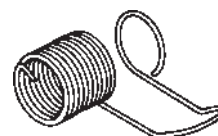

BD-3419C



BD-3420A

1.5

Juki

CT = Hartmetall
 Carbide Tip

LU 2210, 2260		
	Originalnummer Genuine no.	Artikelnummer Item-no. PREMIUM QUALITY
Messer Knife	107-26404	B0367350050m
Fänger Catcher	107-26305	B0367350070m



B0367350050m



B0367350070m

LUH-526, 527		
	Originalnummer Genuine no.	Artikelnummer Item-no. STANDARD
Fadenanzugsfeder Take-up Spring	B3128-527-000	BB3128527000



BB3128527000

LZ-2282		
	Originalnummer Genuine no.	Artikelnummer Item-no. PREMIUM QUALITY
Messer Knife	235-06009	B235-06009m
	235-06009CT	BCT235-06009m
	235-06108CT	BCT235-06108m



B235-06009m

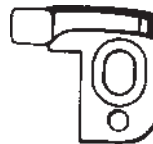

BCT235-06009m



BCT235-06108m

Juki

CT = Hartmetall
 Carbide Tip

MB-372, 373			
	Originalnummer Genuine no.	Artikelnummer Item-no. STANDARD	Artikelnummer Item-no. PREMIUM QUALITY
Ösenknopfflammer Shank Button Clamp	B2401-372-OBO	BB2401372OBO	
Flachknopfflammer Straight Button Clamp	B2547-372-OBO	BB2547372OBO	
Stielbilder (1. Arbeitsgang) Wrapped-around button clamp (1. process) (für / for MB-372)	B2447-372-OAO	BB2447-372-OAO	
Stielbilder (2. Arbeitsgang) Wrapped-around button clamp (2. process) (für / for MB-372)	B2440-372-OAO	BB2440372-OAO	
Stielbilder (1. Arbeitsgang) Wrapped-around button clamp (1. process) (für / for MB-373)	MAZ-04101-OAO	BMAZ-04101-OAO	
Stielbilder (2. Arbeitsgang) Wrapped-around button clamp (2. process) (für / for MB-373)	B2440-373-OAO	BB2440373-OAO	
Messer Knife	B2406-373-OAO		BB2406373OAOm
	B2410-373-OAO		BB2410373OOOm
Kettenstichgreifer Looper	B1239-372-OOO	BB1239372OOO	BB1239372OOOm
Positionsfinger Positioning Finger	B1237-372-OOO	BB1237372OOO	



BB2447-372-OAO



BB2440372-OAO

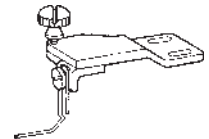

BMAZ-04101-OAO



BB2440373-OAO



BB2406373OAOm



BB1239372OOO
 BB1239372OOOm

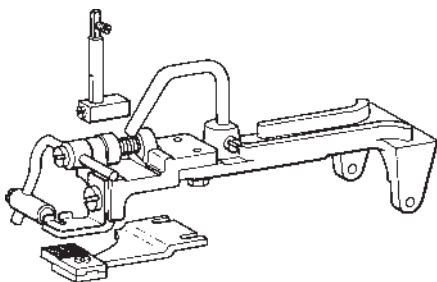

BB2401372OBO

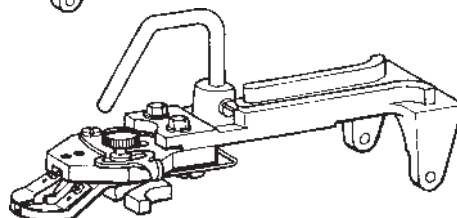

BB2547372OBO



BB2410373OOOm



BB1237372OOO

Juki

CT = Hartmetall
 Carbide Tip

MBH-180, MEB-1890			
	Originalnummer <i>Genuine no.</i>	Artikelnummer <i>Item-no.</i> STANDARD	Artikelnummer <i>Item-no.</i> PREMIUM QUALITY
Knopflochmesser <i>Button Hole Knife</i>	B2701-180-FOO 1/4"	BD-2940	BD-2940m
	- 5/16"	BD-2941	BD-2941m
	B2701-180-KOO 3/8"	BD-2942	BD-2942m
	- 7/16"	BD-2943	BD-2943m
	B2701-180-LOO 1/2"	BD-2944	BD-2944m
	B2701-180-VOO 9/16"	BD-2945	BD-2945m
	B2701-180-MOO 5/8"	BD-2946	BD-2946m
	B2701-180-NOO 3/4"	BD-2948	BD-2948m
	B2701-180-POO 7/8"	BD-2950	BD-2950m
	B2701-180-QOO 1"	BD-2952	BD-2952m
	- 1-1/16"	BD-2953	BD-2953m
	B2701-180-ROO 1-1/8"	BD-2954	BD-2954m
	B2701-180-SOO 1-3/16"	BD-2956	BD-2956m
	B2701-180-TOO 1-3/8"	BD-2958	BD-2958m
	1-1/2"	BD-2959	BD-2959m
Stichplatte <i>Needle Plate</i>	B1109-180-OOO		BD-2738m
Kettenstichgreifer <i>Looper</i>	B2523-180-OOO	BD-2736	
	B2524-180-OOO	BD-2737	

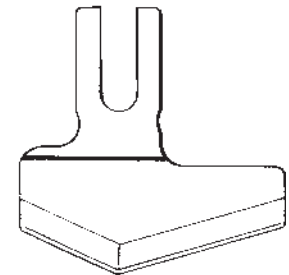
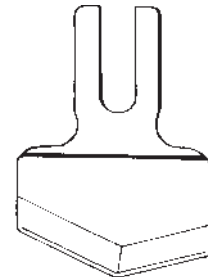
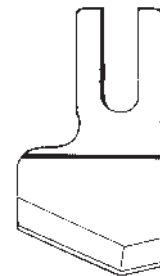
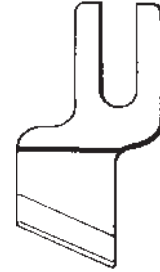

BD-2940 - BD-2959



BD-2738m



BD-2736



BD-2737

Juki

CT = Hartmetall
 Carbide Tip

MEB-2688, 3200		
	Originalnummer Genuine no.	Artikelnummer Item-no. PREMIUM QUALITY
Messer Knife	140-41206	B140-41206m
Kettenstichgreifer Looper	140-30803	B140-30803m
	140-30902	B140-30902m
	140-31009	B140-31009m
	140-31108	B140-31108m

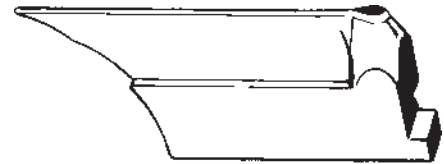

B140-41206m



B140-30803m

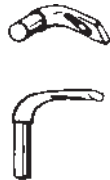

B140-30902m

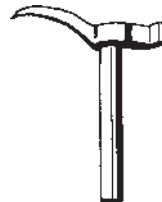

B140-31009m

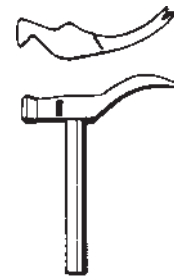

B140-31108m

MF-850, 860, 880, 890, 2600 MFB-860, 2600		
	Originalnummer Genuine no.	Artikelnummer Item-no. PREMIUM QUALITY
Messer Knife	MAS-11012-000	BMAS-11012-000m
	MAS-11013-000	BMAS-11013-000m
	MAS-11016-000	BMAS-11016-000m
	MAS-11017-000	BMAS-11017-000m
Kettenstichgreifer Looper	B2514-860-GOO	BB2514860GOOm
	B2514-860-000	BB251486000Om
	B3901-880-AOO	BB3901880AOOm

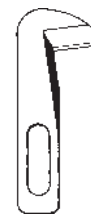

BMAS-11012-000m



BMAS-11013-000m



BMAS-11016-000m



BMAS-11017-000m

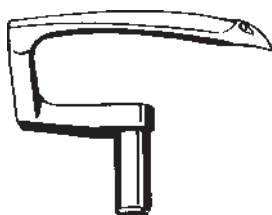

BB2514860GOOm

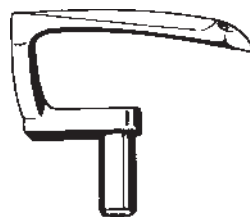

BB251486000Om

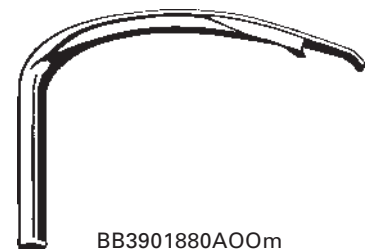

BB3901880AOOm

Juki

CT = Hartmetall
 Carbide Tip

MO 102, 103, 104, 202, 204, 234, 305, 335			
	Originalnummer Genuine no.	Artikelnummer Item-no. STANDARD	Artikelnummer Item-no. PREMIUM QUALITY
Messer Knife	A4113-102-000		BD-2756m
	A4142-335-00OCT		BA4142-335-00OCTm
	A4145-335-000		BA4145-335-000m
	B4108-352-00D	BD-2755CT	BD-2755CTm
Kettenstichgreifer Looper	A2511-202-000	BD-2750	BD-2750m
	A2512-102-000	BD-2747	BD-2747m
	A2512-103-000	BD-2748	BD-2748m
	A2517-103-000	BD-2749	BD-2749m



BD-2756m



BA4142-335-00OCTm



BA4145-335-000m



BD-2755CT
 BD-2755CTm

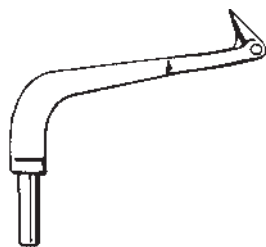

BD-2750
 BD-2750m

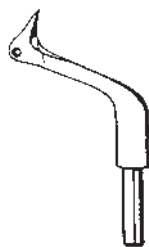

BD-2747
 BD-2747m

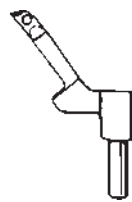

BD-2748
 BD-2748m

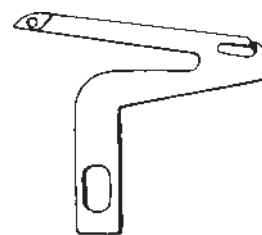

BD-2749
 BD-2749m

Juki

CT = Hartmetall
 Carbide Tip

MO 352, 357			
	Originalnummer Genuine no.	Artikelnummer Item-no. STANDARD	Artikelnummer Item-no. PREMIUM QUALITY
Messer Knife	B4108-352-OOD	BD-2755CT	BD-2755CTm
	B4122-352-OOA	BD-2758	BD-2758m
Kettenstichgreifer Looper	B2011-357-OOO	BD-2744	BD-2744m
	B2520-352-OOO	BD-2746	BD-2746m
	B2521-352-OOO	BD-2745	BD-2745m



BD-2755CT
 BD-2755CTm



BD-2758
 BD-2758m

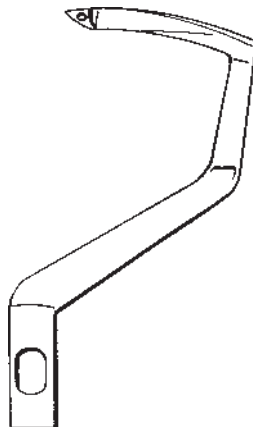

BD-2744
 BD-2744m

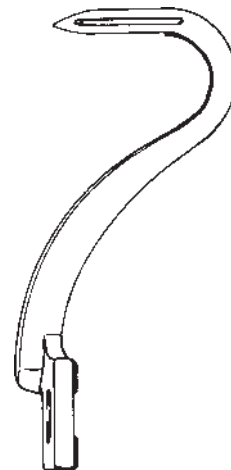

BD-2746
 BD-2746m

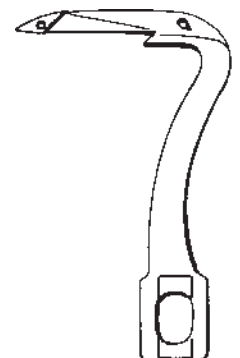

BD-2745
 BD-2745m

Juki

CT = Hartmetall
 Carbide Tip

MO-800, 1500, 2000, 2400, 2500, 3300, 3600, 3700, 3900 MOC-3904, 3914, MOR, MOJ-3916			
	Originalnummer Genuine no.	Artikelnummer Item-no. STANDARD	Artikelnummer Item-no. PREMIUM QUALITY
Messer Knife	115-65900CT	BCT115-65900	BCT115-65900m
	115-66502	B115-66502	B115-66502m
	115-98406		B115-98406m
	118-45609CT	BCT118-45609	BCT118-45609m
	118-45708CT	BCT118-45708	BCT118-45708m
	118-45807		B118-45807m
	118-45807CT	BCT118-45807	BCT118-45807m
	118-45807GCT		BCT118-45807Gm
	118-45906		B118-45906m
	118-45906CT	BCT118-45906	BCT118-45906m
	118-46003	B118-46003	B118-46003m
	118-47407		B118-47407m
	118-47506		B118-47506m
	118-97501		B118-97501m
	120-04909		B120-04909m
	122-20307		B122-20307m
	B4111-804-OOA	BD-2764CT	BD-2764CTm
	B4111-804-OOC	BD-2766CT	BD-2766CTm
	B4111-804-OOD		BD-2763m
	B4111-804-OOE	BD-2765CT	BD-2765CTm
	B4111-804-OOO		BD-2762m
	B4118-804-OOC		BB4118804OOCm
	B4118-804-OOO	BD-2767	BD-2767m
	B4118804OOOCT		BCTB4118804OOOm
	MAT-02203-OOOCT		BMAT-02203-OOOm
	MAT-02204-OOOCT		BMAT-02204-OOOm
	MAT-03505-OOOCT		BMAT-03505-OOOm

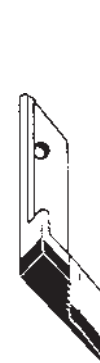

BCT115-65900
 BCT115-65900m



B115-66502
 B115-66502m



B115-98406m

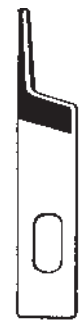

BCT118-45609
 BCT118-45609m



BCT118-45708
 BCT118-45708m



B118-45807m

Juki

CT = Hartmetall
 Carbide Tip



BCT118-45807
 BCT118-45807m



BCT118-45807Gm



B118-45906m



BCT118-45906
 BCT118-45906m



B118-46003
 B118-46003m

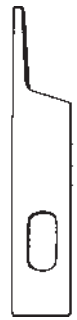

B118-47407m



B118-47506m



B118-97501m



B120-04909m



B122-20307m

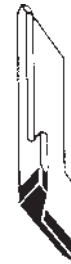

BD-2764CT
 BD-2764CTm



BD-2766CT
 BD-2766CTm



BD-2763m



BD-2765CT
 BD-2765CTm

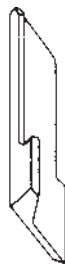

BD-2762m



BB4118804OOCm

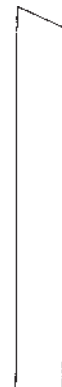

BD-2767
 BD-2767m



BCTB4118804OOOm



BMAT-02203-000m

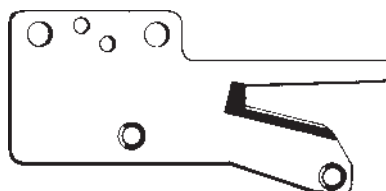

BMAT-02204-000m

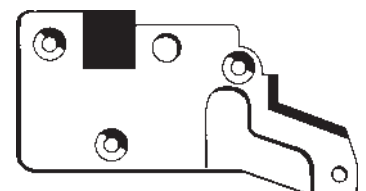

BMAT-03505-000m

Juki

CT = Hartmetall
Carbide Tip

MO-800, 1500, 2000, 2400, 2500, 3300, 3600, 3700, 3900 MOC-3904, 3914, MOR, MOJ-3916			
	Originalnummer <i>Genuine no.</i>	Artikelnummer <i>Item-no.</i> STANDARD	Artikelnummer <i>Item-no.</i> PREMIUM QUALITY
Messer <i>Knife</i>	MAT-03506-OOOCT		BMAT-03506-OOOm
Keramikmesser <i>Ceramic Knife</i>	118-46003BAK	BD-5512	
Kettenstichgreifer <i>Looper</i>	116-51908		B116-51908m
	116-81301		B116-81301m
	118-29405		B118-29405m
	118-88005	B118-88005	B118-88005m
	118-88104	B118-88104	B118-88104m
	118-88203		B118-88203m
	118-88302	B118-88302	B118-88302m
	118-88401	B118-88401	B118-88401m
	118-89904		B118-89904m
	119-95206		B119-95206m
	119-99208		B119-99208m
	119-99307		B119-99307m
	122-40107		B122-40107m
	122-47102		B122-47102m
	122-47300		B122-47300m
	122-47508		B122-47508m
	B2118-816-OOO	BD-2753	BD-2753m
	B2514-803-OOO	BB2514803OOO	BB2514803OOOm
	B2519-804-OOB	BB2519804OOB	BB2519804OOBm
	B2519-804-OOO	BD-2751	BD-2751m
B2519-814-OOO	BB2519814OOO	BB2519814OOOm	
B2521-804-OOB	BB2521804OOB	BB2521804OOBm	
B2521-804-OOO	BD-2752	BD-2752m	
Spreizer <i>Spreader</i>	118-88609	B118-88609	B118-88609m

Juki

CT = Hartmetall
 Carbide Tip

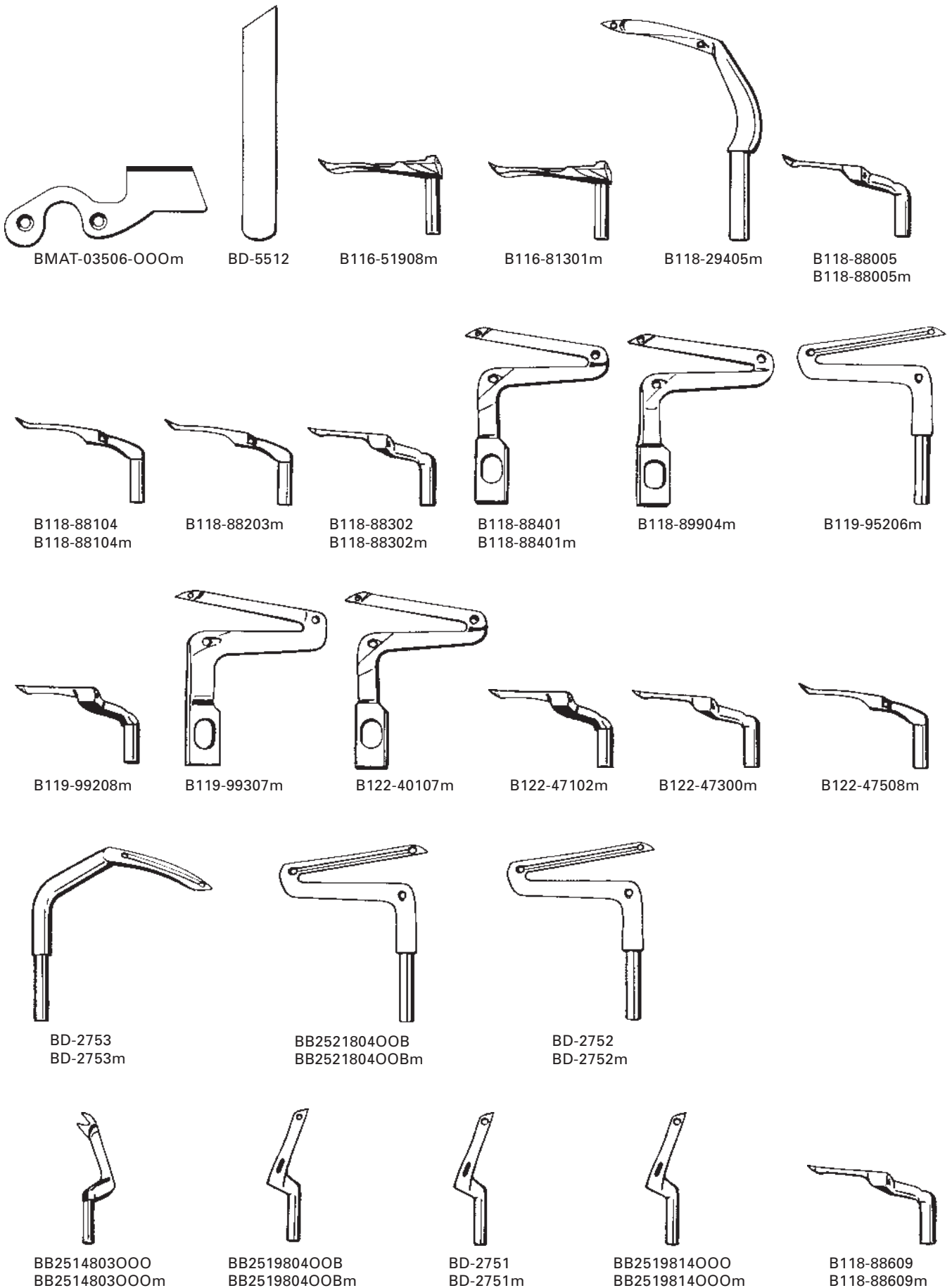

Juki

CT = Hartmetall
 Carbide Tip

MS-26			
		Originalnummer Genuine no.	Artikelnummer Item-no. STANDARD
3-Nadel-Nähwerkzeuge für schwere Materialien Triple Needle Gauge parts for heavy materials 1/8"+1/8"	Nadelhalter Needle Clamp	B1406-026-FOO	B128215-501
	Standardfuß Standard Foot	B1507-026-FAO	B139405-501
	Stichplatte Needle Plate	B1108-026-FOO	B139500-501
	Transporteur Feed Dog	B1604-026-AOO	B139499-501



B128215-501



B139405-501



B139500-501

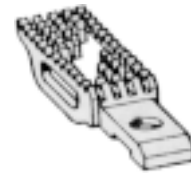

B139499-501

PLC 1610, 1660		
	Originalnummer Genuine no.	Artikelnummer Item-no. PREMIUM QUALITY
Messer Knife	230-05804	B0268350010m
	230-05903	B0268350030m



B0268350010m

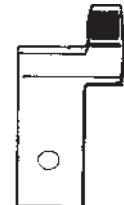

B0268350030m

PLW 1257		
	Originalnummer Genuine no.	Artikelnummer Item-no. PREMIUM QUALITY
Messer Knife	106-46909	B119202m
	106-50703	B119202HSSm



B119202m



B119202HSSm

Kansai

CT = Hartmetall
 Carbide Tip

DFB-1404P		
	Originalnummer <i>Genuine no.</i>	Artikelnummer <i>Item-no.</i> PREMIUM QUALITY
Kettenstichgreifer <i>Looper</i>	19-112	B19-112m
	19-431	B19-431m
	19-437	B19-437m



B19-112m

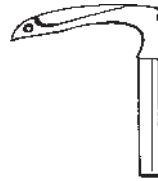

B19-431m



B19-437m

DLR-1500		
	Originalnummer <i>Genuine no.</i>	Artikelnummer <i>Item-no.</i> PREMIUM QUALITY
Kettenstichgreifer <i>Looper</i>	19-531	B19-531m
	19-535	B19-535m
	19-536	B19-536m

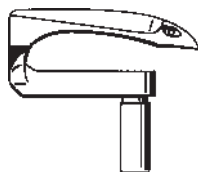

B19-531m

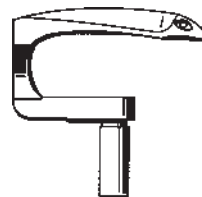

B19-535m

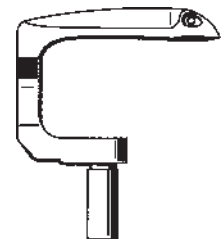

B19-536m

DLR-1508P		
	Originalnummer <i>Genuine no.</i>	Artikelnummer <i>Item-no.</i> PREMIUM QUALITY
Kettenstichgreifer <i>Looper</i>	19-581	B19-581m
	19-582	B19-582m

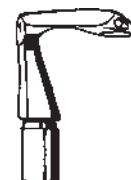

B19-581m

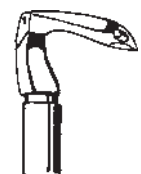

B19-582m

Kansai

CT = Hartmetall
 Carbide Tip

DPW-1300, PX-302		
	Originalnummer <i>Genuine no.</i>	Artikelnummer <i>Item-no.</i> PREMIUM QUALITY
Kettenstichgreifer <i>Looper</i>	19-351	B19-351m
	19-353	B19-353m

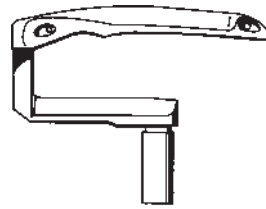

B19-351m

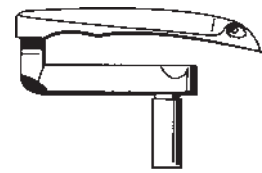

B19-353m

DVK 1700, 3200		
	Originalnummer <i>Genuine no.</i>	Artikelnummer <i>Item-no.</i> PREMIUM QUALITY
Messer <i>Knife</i>	07-124CT	BCT07-124m
	07-206	B07-206m
	07-406CT	BCT07-406m
Kettenstichgreifer <i>Looper</i>	19-7030-0	B19-7030-0m
	19-712	B19-712m
	19-713	B19-713m



BCT07-124m



B07-206m



BCT07-406m

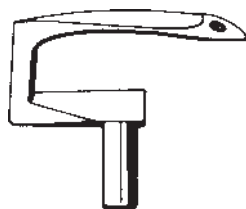

B19-7030-0m

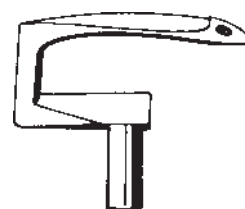

B19-712m

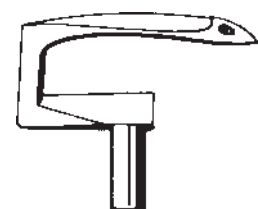

B19-713m

Kansai

CT = Hartmetall
 Carbide Tip

DVK-1700, DVKB-2000		
	Originalnummer <i>Genuine no.</i>	Artikelnummer <i>Item-no.</i> PREMIUM QUALITY
Messer <i>Knife</i>	07-702CT	BCT07-702m
	07-703CT	BCT07-703m
	07-707	B07-707m



BCT07-702m



BCT07-703m



B07-707m

DX-9900		
	Originalnummer <i>Genuine no.</i>	Artikelnummer <i>Item-no.</i> PREMIUM QUALITY
Kettenstichgreifer <i>Looper</i>	19-525	B19-525m



B19-525m

RX 8902, 8903, 9702, 9800, WX-8800		
	Originalnummer <i>Genuine no.</i>	Artikelnummer <i>Item-no.</i> PREMIUM QUALITY
Kettenstichgreifer <i>Looper</i>	19-505	B19-505m
	19-539	B19-539m



B19-505m

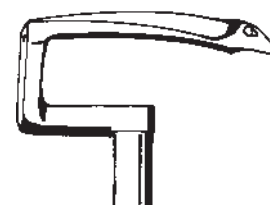

B19-539m

Kansai

CT = Hartmetall
 Carbide Tip

W-8002, -8003		
	Originalnummer <i>Genuine no.</i>	Artikelnummer <i>Item-no.</i> PREMIUM QUALITY
Kettenstichgreifer <i>Looper</i>	19-801	B19-801m
	19-807	B19-807m

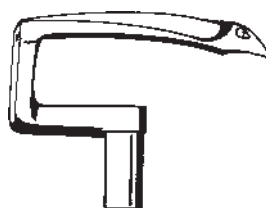

B19-801m



B19-807m

W-8100		
	Originalnummer <i>Genuine no.</i>	Artikelnummer <i>Item-no.</i> PREMIUM QUALITY
Messer <i>Knife</i>	07-168	B07-168m
	07-169	B07-169m



B07-169m



B07-168m

Lewis

CT = Hartmetall
 Carbide Tip

150		
	Originalnummer <i>Genuine no.</i>	Artikelnummer <i>Item-no.</i> PREMIUM QUALITY
Blindstichgreifer <i>Blindstitch Looper</i>	36-16	BD-3261m



BD-3261m

160-20			
	Originalnummer <i>Genuine no.</i>	Artikelnummer <i>Item-no.</i> STANDARD	Artikelnummer <i>Item-no.</i> PREMIUM QUALITY
Kettenstichgreifer <i>Looper</i>	36-19	BD-3191	BD-3191m



BD-3191
 BD-3191m

Lewis

CT = Hartmetall
Carbide Tip

200			
	Originalnummer <i>Genuine no.</i>	Artikelnummer <i>Item-no.</i> STANDARD	Artikelnummer <i>Item-no.</i> PREMIUM QUALITY
Ösenknopfklammer <i>Shank Button Clamp</i>	430-57-1	BD-5001	
Flachknopfklammer <i>Straight Button Clamp</i>	430-63-6	BD-5002	
Heftknopfklammer <i>Tacking Button Clamp</i>	430-75	BD-5003	
Ösenknopfklammer (neu) <i>Shank Button Clamp (new)</i>	430-90-1	BD-5004	
Ersatzteile <i>Spare parts</i> für / for BD-5002	Klemmfeder, rechts <i>Jaw Spring, right</i>	21-336	B21-336
	Klemmfeder, links <i>Jaw Spring, left</i>	21-337	B21-337
	Klammerbacke, re. <i>Jaw, right</i>	45-346	B45-346
	Klammerbacke, links <i>Jaw, left</i>	45-347	B45-347
	Knopfklammerträger <i>Button Clamp Arch</i>	99-270	BD-5008
Ersatzteile <i>Spare parts</i> für / for BD-5003	Heftklammerfinger <i>Breaking Finger</i>	122-45	BD-5000
Ersatzteile <i>Spare parts</i> für / for BD-5001	Knopfauflage, mittel <i>Support Block, med.</i>	115-125	B115-125
	Knopfauflage, niedrig <i>Support Block, low</i>	115-128	B115-128
	Klammerkopf, kpl. <i>Button Holder Set, cpl</i>	115-133	B115-133
	Transportplatte <i>Feed Plate</i>	24-281	B24-281
Ersatzteile <i>Spare parts</i> für / for BD-5004	Knopfklammerträger <i>Button Clamp Arch</i>	99-308	BD-5007
	Knopfauflage, mittel <i>Support Block, med.</i>	115-125N	B115-125N
	Knopfauflage, niedrig <i>Support Block, low</i>	115-128N	B115-128N
	Knopfauflage, hoch <i>Support Block, high</i>	115-133N	B115-133N
	Klammerblech, unten <i>L. holder clamp</i>	162-20	B162-20
	Klammerblech, oben <i>U. holder clamp</i>	162-21	B162-21
	Klammerkopf, kpl. <i>Button Holder Set, cpl</i>	200-20	B200-20
Kettenstichgreifer <i>Looper</i>	36-21	BD-3197	BD-3197m

Lewis

CT = Hartmetall
 Carbide Tip

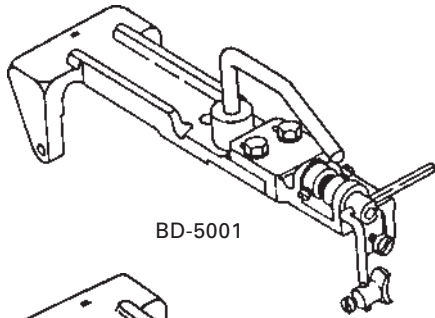

BD-5001

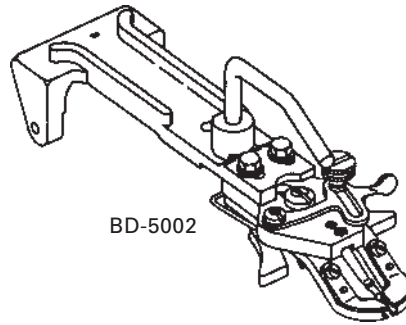

BD-5002

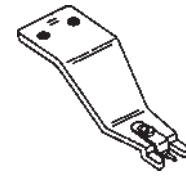

BD-5003

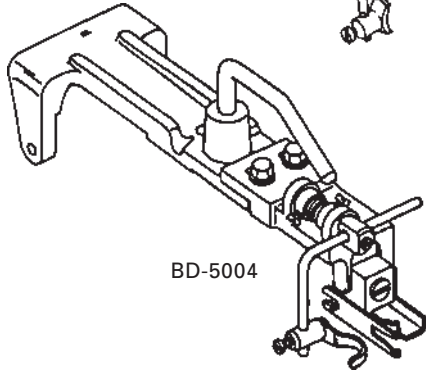

BD-5004



B21-336



B21-337

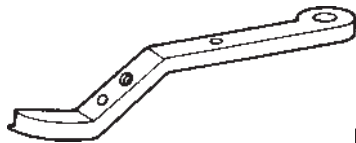

B45-346

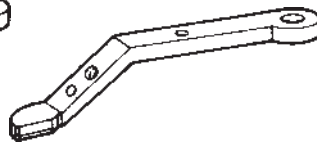

B45-347

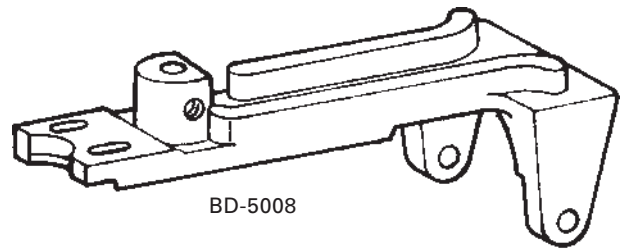

BD-5008

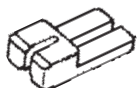

B115-125



B115-128



B115-133

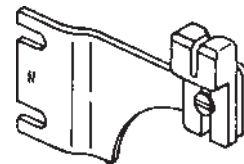

B24-281

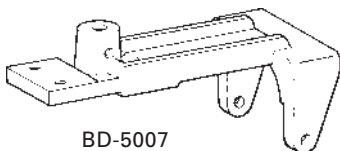

BD-5007



B115-125N



B115-128N

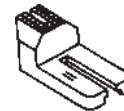

B115-133N



B200-20



BD-3197
 BD-3197m

Mauser

CT = Hartmetall
 Carbide Tip

10, 40, 50		
	Originalnummer Genuine no.	Artikelnummer Item-no. PREMIUM QUALITY
Messer Knife	700535CT	BD-2773CTm
	700591CT	BCT700591m
	705138CT	BD-2769CTm
	705142CT	BD-2770CTm
	96-700535-05	BD-2773m
	96-700591-05	BD-2774m
	96-705142-05	BD-2770m
Kettenstichgreifer Looper (nur / only 10, 50)	96-712082-05	BD-2768m
Kettenstichgreifer Looper (nur / only 40)	96-700565-05	BD-2771m
	96-722820-05	BD-2772am
Zunge Tongue	96-701080-05	B96-701080-05m



BD-2773CTm



BCT700591m

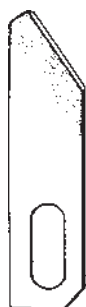

BD-2769CTm



BD-2770CTm



BD-2773m



BD-2774m

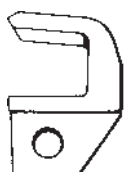

BD-2770m

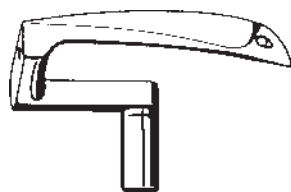

BD-2768m

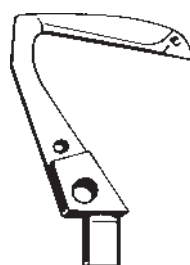

BD-2772am



B96-701080-05m

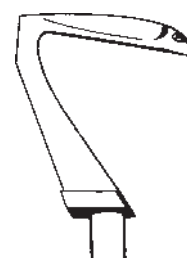

BD-2771m

Mauser

CT = Hartmetall
 Carbide Tip

63			
		Originalnummer Genuine no.	Artikelnummer Item-no. STANDARD
Flachknopfklammer <i>Straight Button Clamp</i>		96-795052-00	BD-5002
Ösenknopfklammer <i>Shank Button Clamp</i>		96-795061-00	BD-5001
Flachknopfklammer ersatzteile <i>Spare Parts for Flat Button Clamp (für / for BD-5002)</i>	Knopfklammerträger <i>Button Clamp Arch</i>	96-795240-00	BD-5008
	Klammerbacke, re. <i>Jaw, right</i>	96-795244-00	B45-346
	Klammerbacke, li. <i>Jaw, left</i>	96-795246-00	B45-347
	Klemmfeder, re. <i>Jaw Spring, right</i>	96-795247-00	B21-336
	Klemmfeder, li. <i>Jaw Spring, left</i>	96-795248-00	B21-337
Ösenknopfklammer ersatzteile <i>Spare Parts for Shank Button Clamp (für / for BD-5001)</i>	Klammerkopf, kpl. <i>Button Holder Set</i>	96-795059-00	B175890
	Transportplatte <i>Feed Plate</i>	96-795459-00	B24-281
	Knopfauflage, mittel <i>Support Plate, med.</i>	96-795460-00	B115-125
	Knopfauflage, niedrig <i>Support Plate, low</i>	96-795461-00	B115-128

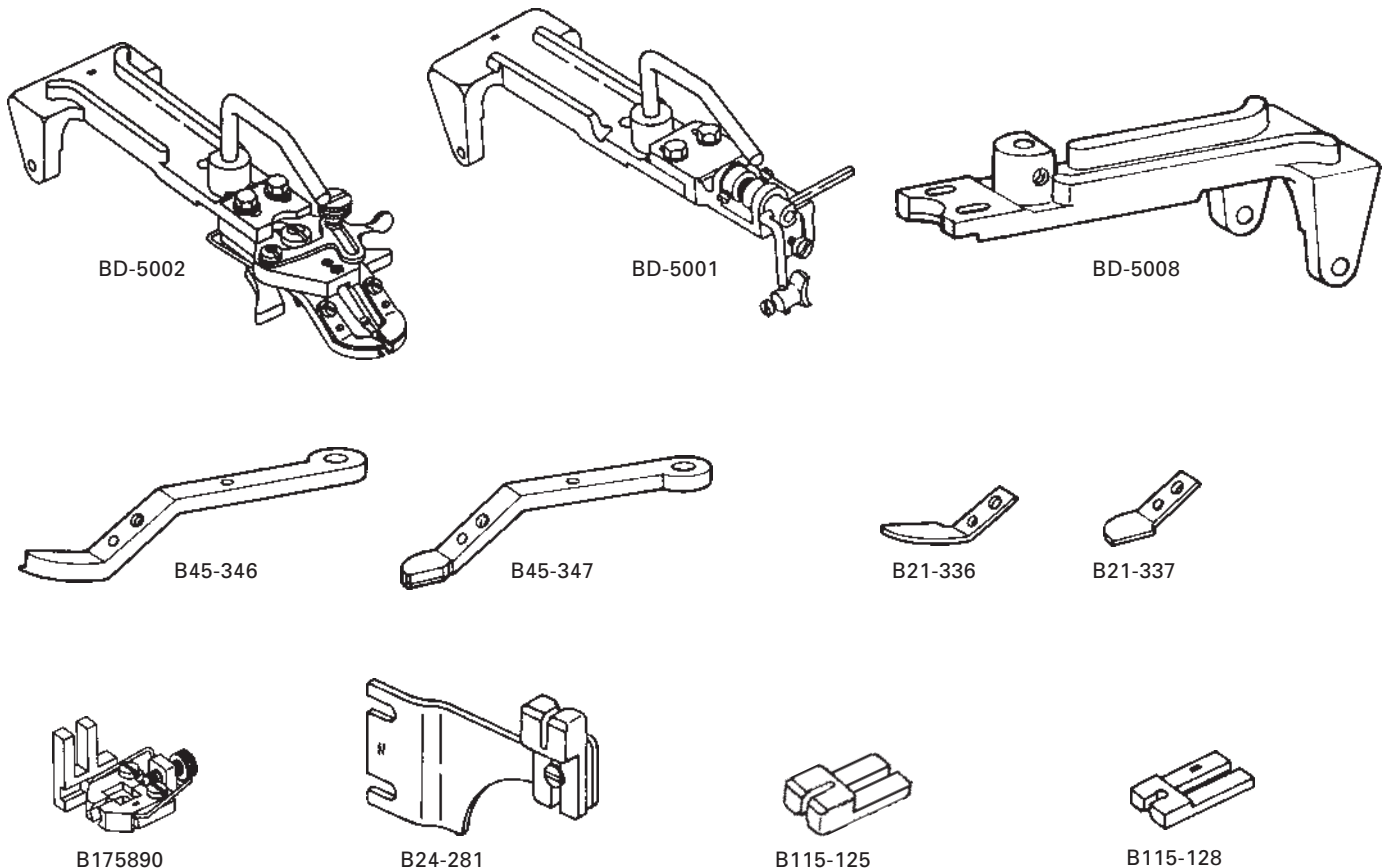

Mauser

CT = Hartmetall
Carbide Tip

500, 504, 2001, 2003, 2004, 2005, 2014, 2015, 2016, 9600, 9700			
	Originalnummer <i>Genuine no.</i>	Artikelnummer <i>Item-no.</i> STANDARD	Artikelnummer <i>Item-no.</i> PREMIUM QUALITY
Messer <i>Knife</i>	09-009050-06	BD-2783CT	BD-2783CTm
	09-009052-54	BD-2782	BD-2782m
	09-009052-55	BD-2784	BD-2784m
	09-009052-56	BD-2785A	BD-2785Am
	09-009053-33	BD-2788	BD-2788m
	09-009054-43	BD-2787	BD-2787m
	09-009065-29		B204152m
	09-009066-42	BD-2785	BD-2785m
	09-009070-82		BCT202527m
	09-009071-09		B204835m
	09-009606-90	BD-2789CT	BD-2789CTm
	09-009620-39		B210762m
	09-009621-64		BCT301006m
	09-009621-65		BCT301008m
	09-009732-15		BCT205890m
	09-009801-40		B205609m
	09-009801-41		BCT205607m
	09-009802-00		BCT211662m
	09-009803-45		B211661m
	09-009806-67		B211788m
	09-009806-72		BCT301035m
	09-009806-73		BCT301036m
	09-009807-78		BCT211771m
	09-009812-97		B213108m
	09-009819-09	BD-2786CT	BD-2786CTm
	09-009825-62		B211742m
	09-009831-32		B204161Am
	09-009842-89		B208393m

Mauser

CT = Hartmetall
 Carbide Tip

500, 504, 2001, 2003, 2004, 2005, 2014, 2015, 2016, 9600, 9700			
	Originalnummer Genuine no.	Artikelnummer Item-no. STANDARD	Artikelnummer Item-no. PREMIUM QUALITY
Messer Knife	09-009846-02		B277000m
	09-009846-08		B277009m
	09-009857-11		BCT211662Am
	91-179421-01		BCT210755m
Keramikkmesser Ceramic Knife	09-009066-42BAK	BD-5520	Nicht mehr lieferbar No longer available
	09-009053-33BAK	BD-5522	
Kettenstichgreifer Looper	09-009049-43	BD-2790	BD-2790m
	09-009049-56	BD-2795	BD-2795m
	09-009050-62	BD-2791	BD-2791m
	09-009053-29		B202861m
	09-009053-31	BD-2792	BD-2792m
	09-009054-19	BD-2793	BD-2793m
	09-009054-20	BD-2796	BD-2796m
	09-009065-25	BD-2798	BD-2798m
	09-009065-26	BD-2799	BD-2799m
	09-009065-89	BD-2803	BD-2803m
	09-009065-90	BD-2800	BD-2800m
	09-009067-68	BD-2805	BD-2805m
	09-009067-69	BD-2807	BD-2807m
	09-009067-70	BD-2804	BD-2804m
	09-009068-07	BD-2801	BD-2801m
	09-009068-98	BD-2806	BD-2806m
	09-009603-48	BD-2802	BD-2802m
	09-009603-49	BD-2797	BD-2797m
	09-009611-28		B204963m
	09-009611-29		B204964m
09-009618-12	BD-2810	BD-2810m	
09-009615-99	BD-2811	BD-2811m	

Mauser

CT = Hartmetall
Carbide Tip

500, 504, 2001, 2003, 2004, 2005, 2014, 2015, 2016, 9600, 9700			
	Originalnummer <i>Genuine no.</i>	Artikelnummer <i>Item-no.</i> STANDARD	Artikelnummer <i>Item-no.</i> PREMIUM QUALITY
Kettenstichgreifer <i>Looper</i>	09-009616-01	BD-2809	BD-2809m
	09-009616-03	BD-2813	BD-2813m
	09-009616-04	BD-2814	BD-2814m
	09-009617-06		B210512m
	09-009617-07		B210513m
	09-009617-97		B210729m
	09-009617-98		B210730m
	09-009618-08		B210360m
	09-009620-31	BD-2808	BD-2808m
	09-009620-33	BD-2815	BD-2815m
	09-009620-34		B210367m
	09-009621-60		B210515m
	09-009733-31		B211719m
	09-009733-37		B211845m
	09-009802-26		B211720m
	09-009802-28		B212215m
	09-009802-29		B211651m
	09-009804-51		B212644m
	09-009807-47		BD-2812m
	09-009811-92		B212092m
	09-009812-96		B213105m
	09-009833-45		B204949m
	09-009844-22		B277014Bm
	09-009846-09		B277010m
	09-009846-10		B277010Am
	09-009846-11		B277011m
	09-009846-12		B277014m
09-009846-13		B277014Am	

Mauser

CT = Hartmetall
 Carbide Tip

500, 504, 2001, 2003, 2004, 2005, 2014, 2015, 2016, 9600, 9700				
		Originalnummer Genuine no.	Artikelnummer Item-no. STANDARD	Artikelnummer Item-no. PREMIUM QUALITY
Kettenstichgreifer Looper		09-009846-14		B277015m
		09-009846-15		B277015Am
		09-009846-17		B277017m
		09-009846-18		B277018m
		09-009846-19		B277018Cm
		09-009846-20		B277019m
Schraube Screw		09-009064-89	B3637	
Nähgarnitur 0x4mm Gauge Set 0x4mm (für / for 9652)	Stichplatte Needle Plate	09-009620-45		B210787m
	Transporteur Feed Dog	09-009616-57		B210443m
		09-009617-26		B210568m
Nähgarnitur 0x5mm Gauge Set 0x5mm (für / for 9652)	Stichplatte Needle Plate	09-009620-46		B210788m
	Transporteur Feed Dog	09-009616-57		B210443m
		09-009617-26		B210568m
Nähgarnitur 3x4mm Gauge Set 3x4mm (für / for 9632)	Stichplatte Needle Plate	09-009620-09		B210846m
	Transporteur Feed Dog	09-009606-75		B210581m
		09-009616-98		B210494m
Nähgarnitur 2x5mm Gauge Set 2x5mm (für / for 9652)	Stichplatte Needle Plate	09-009620-66		B210810m
	Transporteur Feed Dog	09-009616-58		B210445m
		09-009617-33		B210575m
Nähgarnitur 5x5mm Gauge Set 5x5mm (für / for 9632)	Stichplatte Needle Plate	09-009620-14		B210851m
	Transporteur Feed Dog	09-009606-75		B210581m
		09-009616-98		B210494m
Nähgarnitur 4mm Gauge Set 4mm (für / for 500)	Stichplatte Needle Plate	09-009611-37		B205321m
	Transporteur Feed Dog	09-009068-97		B204907m
		09-009611-68		B208336m
		09-009611-70		B208338m

Mauser

CT = Hartmetall
Carbide Tip

500, 504, 2001, 2003, 2004, 2005, 2014, 2015, 2016, 9600, 9700				
		Originalnummer <i>Genuine no.</i>	Artikelnummer <i>Item-no.</i> STANDARD	Artikelnummer <i>Item-no.</i> PREMIUM QUALITY
Nähgarnitur 5mm <i>Gauge Set 5mm</i> (für / for 500)	Stichplatte <i>Needle Plate</i>	09-009070-90		B205322m
	Transporteur <i>Feed Dog</i>	09-009068-97		B204907m
		09-009611-68		B208336m
		09-009611-70		B208338m
Nähgarnitur 3x5mm <i>Gauge Set 3x5mm</i> (für / for 500)	Stichplatte <i>Needle Plate</i>	09-009065-65		B204252Bm
	Transporteur <i>Feed Dog</i>	09-009071-19		B208063m
		09-009071-27		B208215m
Nähgarnitur 5x5mm <i>Gauge Set 5x5mm</i> (für / for 500)	Stichplatte <i>Needle Plate</i>	09-009065-40		B204360Am
	Transporteur <i>Feed Dog</i>	09-009071-19		B208063m
		09-009071-27		B208215m

Abbildungen dieser Artikel finden Sie unter PEGASUS DCR 601 auf Seite 1.5-90 bis 1.5-99
For images of these items, please refer to PEGASUS DCR 601 at page 1.5-90 up to 1.5-99

68-16211-01,-17321-01		
	Originalnummer <i>Genuine no.</i>	Artikelnummer <i>Item-no.</i> PREMIUM QUALITY
Blindstichgreifer <i>Blindstitch Looper</i>	96-795104-00	BD-2775m



BD-2775m

Mauser

CT = Hartmetall
 Carbide Tip

4542, 4562		
	Originalnummer Genuine no.	Artikelnummer Item-no. PREMIUM QUALITY
Kettenstichgreifer Looper	257550	B257550m

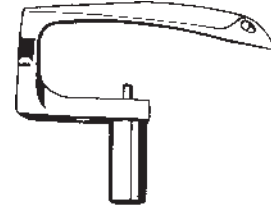

B257550m

F23100		
	Originalnummer Genuine no.	Artikelnummer Item-no. PREMIUM QUALITY
Kettenstichgreifer Looper	96-710414-05	BD-2777m

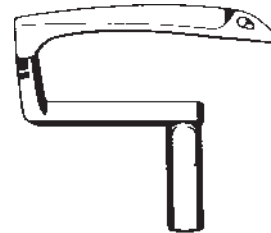

BD-2777m

S 1323		
	Originalnummer Genuine no.	Artikelnummer Item-no. PREMIUM QUALITY
Messer Knife	96-720735-05	BD-2829m
	96-720742-05	BD-2832m
	96-720744-05	BD-2833m
	96-720745-05	BD-2831m
Kettenstichgreifer Looper	96-720392-05	BD-2834m



BD-2829m



BD-2832m



BD-2833m



BD-2831m

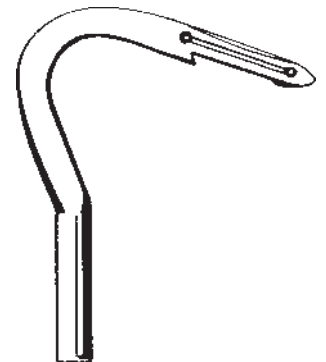

BD-2834m

Mauser

CT = Hartmetall
 Carbide Tip

AG		
	Originalnummer <i>Genuine no.</i>	Artikelnummer <i>Item-no.</i> PREMIUM QUALITY
Messer <i>Knife</i>	96-705307-05	BD-2836m



BD-2836m

ATA		
	Originalnummer <i>Genuine no.</i>	Artikelnummer <i>Item-no.</i> PREMIUM QUALITY
Kettenstichgreifer <i>Looper</i>	96-702748-05	BD-2776m

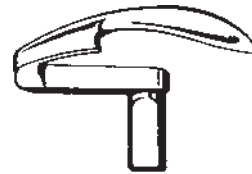

BD-2776m

OAH, ODA		
	Originalnummer <i>Genuine no.</i>	Artikelnummer <i>Item-no.</i> PREMIUM QUALITY
Messer <i>Knife</i>	96-705205-05	BD-2821m
	96-705438-05	BD-2827m
	96-705468-05	BD-2828m
	96-706135-05	BD-2822m
	96-706651-05	BD-2823m
	96-707786-05	BD-2825m
Kettenstichgreifer <i>Looper</i>	96-702414-05	BD-2816m
	96-702684-05	BD-2819m
	96-702692-05	BD-2817m
	96-702693-05	BD-2820m



BD-2821m



BD-2827m



BD-2828m



BD-2822m

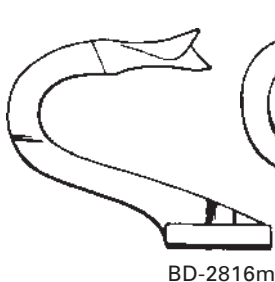

BD-2816m

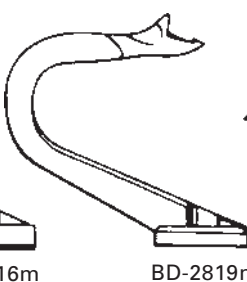

BD-2819m

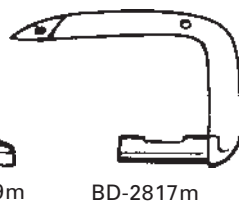

BD-2817m

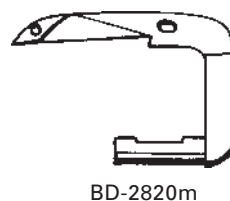

BD-2820m



BD-2823m



BD-2825m

Merrow

CT = Hartmetall
 Carbide Tip

MERROW			
	Originalnummer Genuine no.	Artikelnummer Item-no. STANDARD	Artikelnummer Item-no. PREMIUM QUALITY
Messer Knife (für / for 60)	6-91-C		BD-2849m
Messer Knife (für / for 60, 70, M)	6-91-ECT		BD-2848CTm
Messer Knife (für / for 60,70, M, MG)	6-91-E	BD-2848	BD-2848m
	A90-3	BD-2846	BD-2846m
Messer Knife (für / for 70)	6-91-H		BD-2850m
	6-91-K	BD-2851	BD-2851m
Messer Knife (für / for M, MG)	6-90	BD-2844	
	6-90-C	BD-2842	
	6-91	BD-2847	BD-2847m
	A90-1		BD-2845m
	6-90-DCT		BD-2843CTm
Kettenstichgreifer Looper (für / for 60)	69	BD-2852	BD-2852m
Kettenstichgreifer Looper (für / for 70)	105	BD-2854	BD-2854m
	72	BD-2855	BD-2855m

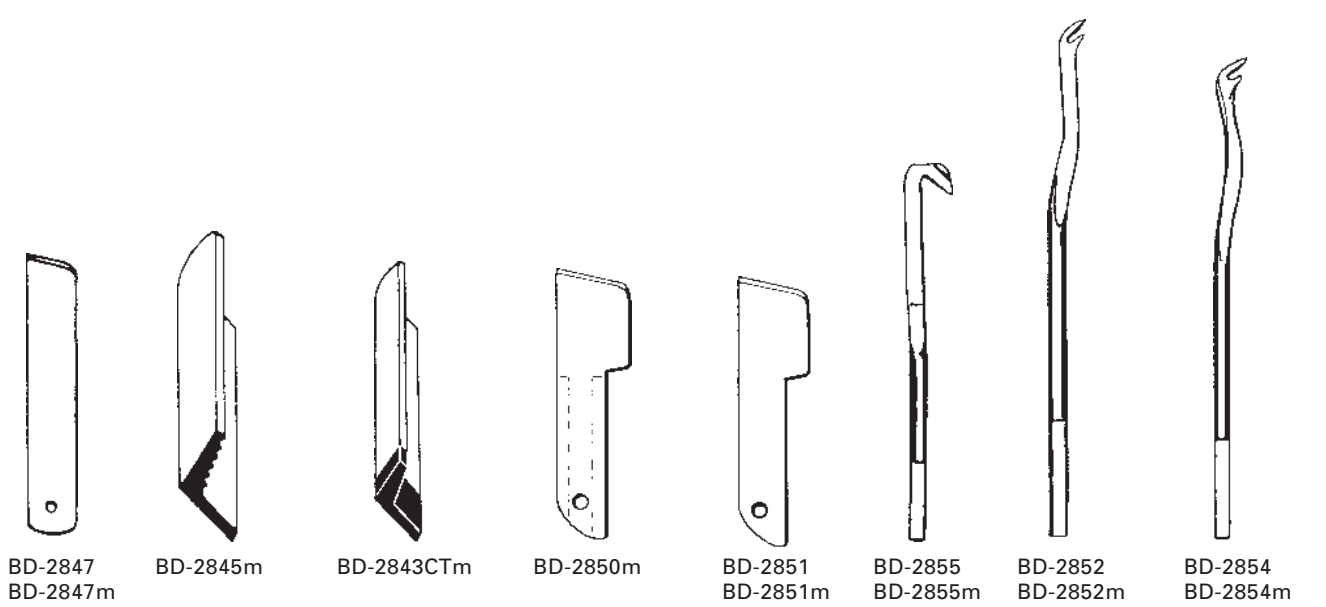
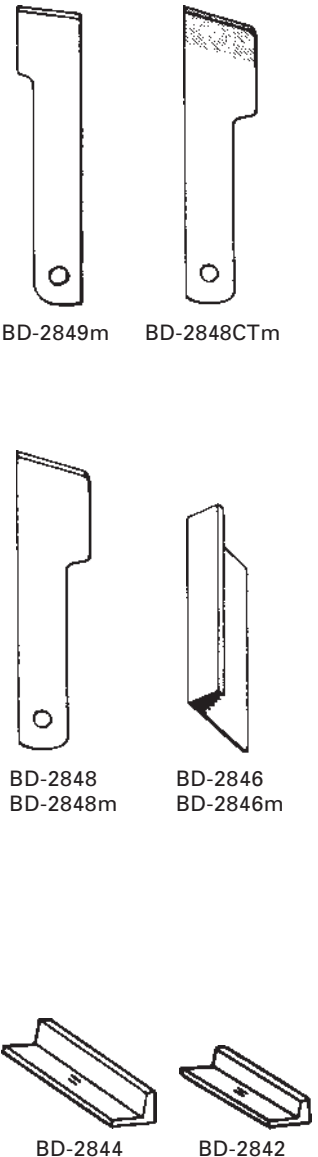

Mitsubishi

CT = Hartmetall
 Carbide Tip

DB-130, 189, 199 LS2-150, 180, 190, 210		
	Originalnummer Genuine no.	Artikelnummer Item-no. PREMIUM QUALITY
Messer Knife	MF16A0838	BMF16A0838m
Messer Knife (nur / only DB-189)	MF40A1834	BMF40A1834m
	MF40A2180	BMF40A2180m
	MF40A1835	BMF40A1835m
	MF40A2835	



BMF16A0838m

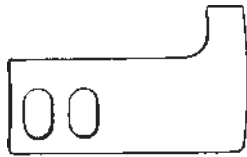

BMF40A1834m

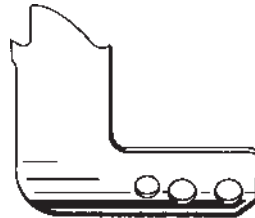

BMF40A2180m



BMF40A1835

DY-339, 349		
	Originalnummer Genuine no.	Artikelnummer Item-no. PREMIUM QUALITY
Messer Knife	MG40B0834	BMG40B0834m
	MG40B0835	BMG40B0835m



BMG40B0834m



BMG40B0835m

DY-359		
	Originalnummer Genuine no.	Artikelnummer Item-no. PREMIUM QUALITY
Messer Knife	MG52A0834	BMG52A0834m
	MG52A0838	BMG52A0838m

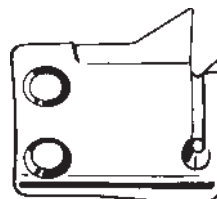

BMG52A0834m



BMG52A0838m

Mitsubishi

CT = Hartmetall
 Carbide Tip

LS2-180			
	Originalnummer Genuine no.	Artikelnummer Item-no. STANDARD	Artikelnummer Item-no. PREMIUM QUALITY
Messer Knife	MF00A0834	BMF00A0834	BMF00A0834m
	MF00A0838	BMF00A0838	BMF00A0838m

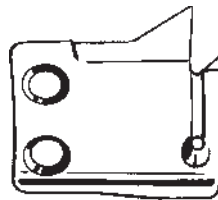

BMF00A0834
 BMF00A0834m



BMF00A0838
 BMF00A0838m

LS2-190, PLK-1210		
	Originalnummer Genuine no.	Artikelnummer Item-no. PREMIUM QUALITY
Messer Knife	MF90A0838	BMF90A0838m
	MF90B2838	BMF90B2838m
	MG44B0838	BMG44B0838m

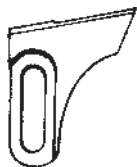

BMF90A0838m

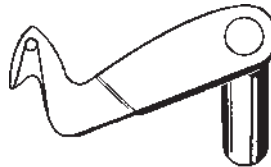

BMF90B2838m



BMG44B0838m

LS2-210		
	Originalnummer Genuine no.	Artikelnummer Item-no. STANDARD
Messer Knife	MN35A0838	BMN35A0838



BMN35A0838

Mitsubishi

CT = Hartmetall
 Carbide Tip

LS2-230, LT2-250			
	Originalnummer <i>Genuine no.</i>	Artikelnummer <i>Item-no.</i> STANDARD	Artikelnummer <i>Item-no.</i> PREMIUM QUALITY
Messer <i>Knife</i>	MN50A0838	BMN50A0838	BMN50A0838m
	MN50B0838		BMN50B0838m



BMN50A0838
 BMN50A0838m

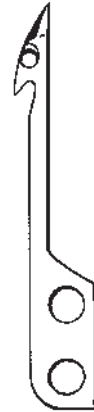

BMN50B0838m

LU2-410, 430		
	Originalnummer <i>Genuine no.</i>	Artikelnummer <i>Item-no.</i> PREMIUM QUALITY
Messer <i>Knife</i>	MP41B0838	BMP41B0838m



BMP41B0838m

PLK-0109, 0303		
	Originalnummer <i>Genuine no.</i>	Artikelnummer <i>Item-no.</i> PREMIUM QUALITY
Messer <i>Knife</i>	MS01A0838	BMS01A0838m
	MS01B0838	BMS01B0838m



BMS01A0838m



BMS01B0838m

Mitsubishi

CT = Hartmetall
 Carbide Tip

PLK-0504, 0604, 0804, B1006, B2516		
	Originalnummer Genuine no.	Artikelnummer Item-no. PREMIUM QUALITY
Messer Knife	MS03B0838	BMS03B0838m
	MS14A0838	BMS03A0838m



BMS03B0838m

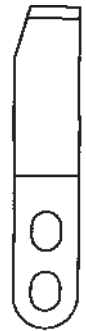

BMS03A0838m

PLK-1410, 1710		
	Originalnummer Genuine no.	Artikelnummer Item-no. PREMIUM QUALITY
Messer Knife	MF02A0834	BMF02A0834m
	MS10A0838	BMF02A0838m

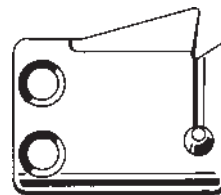

BMF02A0834m



BMF02A0838m

Pegasus

CT = Hartmetall
Carbide Tip

DCR601, 801, 901, 905 / E22, 22L, 32, 32L, 51, 52, 52L, 54, 256 ETS32, 32L, 51, 52 / EX/EXT 3200, 5200 L32, 52, R53, 57, S22, 32, 52, LX3200, 5200 M600, 700			
	Originalnummer <i>Genuine no.</i>	Artikelnummer <i>Item-no.</i> STANDARD	Artikelnummer <i>Item-no.</i> PREMIUM QUALITY
	179458-05		B179458-05m
	179459-05CT		BCT179459-05m
	201121A	BD-2783CT	BD-2783CTm
	201127	BD-2787	BD-2787m
	202295	BD-2785	BD-2785m
	202527CT		BCT202527m
	202570	BD-2782	BD-2782m
	202571	BD-2784	BD-2784m
	202572	BD-2785A	BD-2785Am
	202893CT	BD-2786CT	BD-2786CTm
	204152		B204152m
	204161	BD-2788	BD-2788m
	204161A		B204161Am
	204351	BD-2789CT	BD-2789CTm
	204835CT		B204835m
	205607CT		BCT205607m
	205609		B205609m
	205890CT		BCT205890m
	208393		B208393m
	210755		B210755m
	210755CT		BCT210755m
	210762		B210762m
	211661		B211661m
	211662A		BCT211662Am
	211662CT		BCT211662m
	211742		B211742m

Messer
Knife

Pegasus

CT = Hartmetall
 Carbide Tip



BCT179459-05m

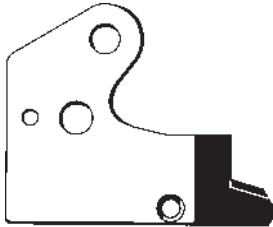

B179458-05m



BD-2783CT
 BD-2783CTm



BD-2787
 BD-2787m



BD-2785
 BD-2785m



BCT202527m



BD-2782
 BD-2782m



BD-2784
 BD-2784m



BD-2785A
 BD-2785Am



BD-2786CT
 BD-2786CTm



B204152m



BD-2788
 BD-2788m



B204161Am



BD-2789CT
 BD-2789CTm

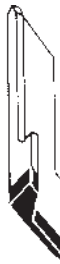

B204835m



BCT205607m



B205609m



BCT205890m



B208393m



B210755m

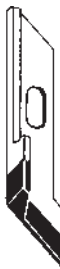

BCT210755m



B210762m



B211661m



BCT211662Am



BCT211662m



B211742m

Pegasus

CT = Hartmetall
Carbide Tip

DCR601, 801, 901, 905 / E22, 22L, 32, 32L, 51, 52, 52L, 54, 256 ETS32, 32L, 51, 52 / EX/EXT 3200, 5200 L32, 52, R53, 57, S22, 32, 52, LX3200, 5200 M600, 700			
	Originalnummer <i>Genuine no.</i>	Artikelnummer <i>Item-no.</i> STANDARD	Artikelnummer <i>Item-no.</i> PREMIUM QUALITY
Messer <i>Knife</i>	211771CT		BCT211771m
	211788		B211788m
	213108		B213108m
	277000CT		B277000m
	277009		B277009m
	301006CT		BCT301006m
	301008CT		BCT301008m
	301035CT		BCT301035m
	301036CT		BCT301036m
	308026-91CT		BCT308026-91m
	308030CT		BCT308030m
Keramikkmesser <i>Ceramic Knife</i>	202295BAK	BD-5520	
	204161BAK	BD-5522	
Kettenstichgreifer <i>Looper</i>	201067A	BD-2790	BD-2790m
	201085B	BD-2795	BD-2795m
	201234A	BD-2791	BD-2791m
	202703	BD-2803	BD-2803m
	202828(4)	BD-2800	BD-2800m
	202861		B202861m
	202874(1)	BD-2792	BD-2792m
	204062(2)	BD-2793	BD-2793
	204072	BD-2796	BD-2796m
	204314A	BD-2798	BD-2798m
	204431	BD-2799	BD-2799m
	204663(7)	BD-2801	BD-2801m
204702(4)	BD-2804	BD-2804m	

Pegasus

CT = Hartmetall
 Carbide Tip



BCT211771m



B211788m



B213108m



B277000m



B277009m



BCT301008m

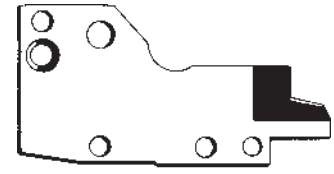

BCT301006m

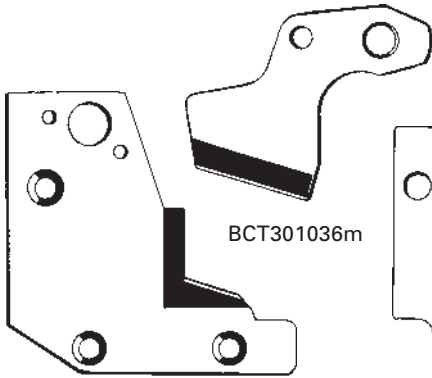

BCT301036m

BCT301035m

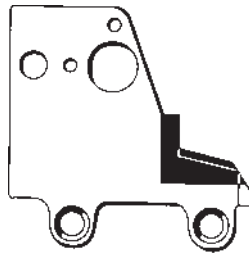

BCT308026-91m



BCT308030m



BD-5520



BD-5522

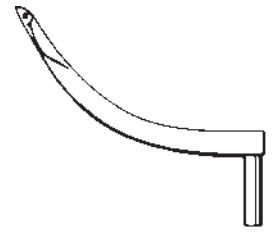

BD-2790
 BD-2790m

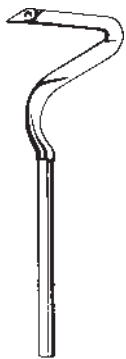

BD-2795
 BD-2795m

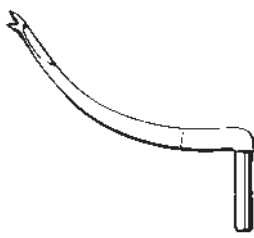

BD-2791
 BD-2791m

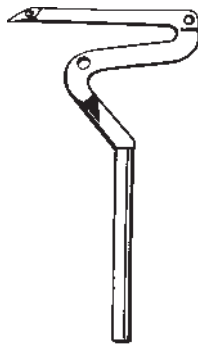

BD-2803
 BD-2803m



BD-2800
 BD-2800m



B202861m

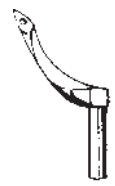

BD-2792
 BD-2792m

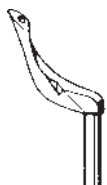

BD-2793
 BD-2793m

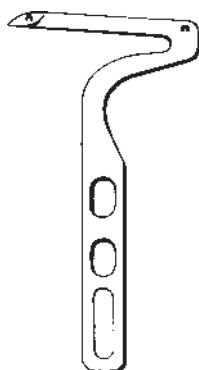

BD-2796
 BD-2796m

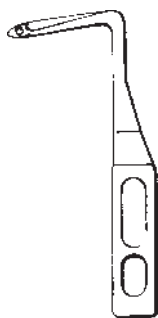

BD-2798
 BD-2798m



BD-2799
 BD-2799m



BD-2801
 BD-2801m



BD-2804
 BD-2804m

Pegasus

CT = Hartmetall
Carbide Tip

DCR601, 801, 901, 905 / E22, 22L, 32, 32L, 51, 52, 52L, 54, 256 ETS32, 32L, 51, 52 / EX/EXT 3200, 5200 L32, 52, R53, 57, S22, 32, 52, LX3200, 5200 M600, 700			
	Originalnummer <i>Genuine no.</i>	Artikelnummer <i>Item-no.</i> STANDARD	Artikelnummer <i>Item-no.</i> PREMIUM QUALITY
Kettenstichgreifer <i>Looper</i>	204703(6)	BD-2805	BD-2805m
	204704(3)	BD-2806	BD-2806m
	204705(5)	BD-2807	BD-2807m
	204949(11)		B204949m
	204963(8)		B204963m
	204964(9)		B204964m
	204990(12)	BD-2802	BD-2802m
	204991	BD-2797	BD-2797m
	210354	BD-2810	BD-2810m
	210356	BD-2811	BD-2811m
	210357		BD-2812m
	210358(2)	BD-2808	BD-2808m
	210359(4)	BD-2809	BD-2809m
	210360(6)		B210360m
	210364(22)	BD-2813	BD-2813m
	210365(24)	BD-2814	BD-2814m
	210366(26)	BD-2815	BD-2815m
	210367(28)		B210367m
	210512(21)		B210512m
	210513(23)		B210513m
	210515(27)		B210515m
	210729(30)		B210729m
	210730(32)		B210730m
	211651		B211651m
	211719(38)		B211719m
	211720(40)		B211720m

Pegasus

CT = Hartmetall
 Carbide Tip



BD-2805
 BD-2805m

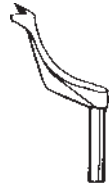

BD-2806
 BD-2806m



BD-2807
 BD-2807m



B204949m



B204963m



B204964m



BD-2802
 BD-2802m

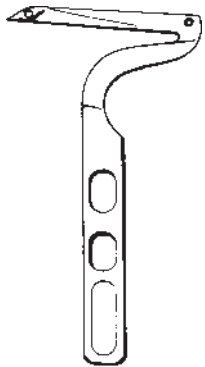

BD-2797
 BD-2797m

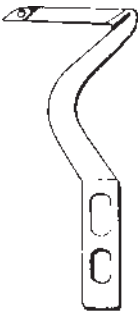

BD-2810
 BD-2810m

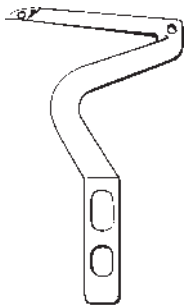

BD-2811
 BD-2811m

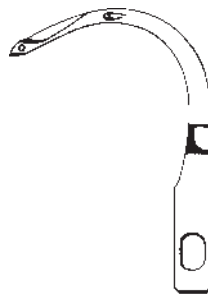

BD-2812m



BD-2808
 BD-2808m



BD-2809
 BD-2809m



B210360m



BD-2813
 BD-2813m



BD-2814
 BD-2814m



BD-2815
 BD-2815m



B210367m

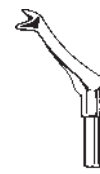

B210512m

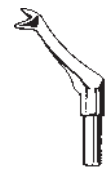

B210513m

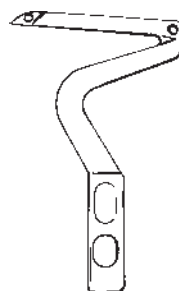

B211651m

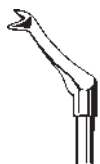

B210515m



B210729m



B210730m



B211719m



B211720m

Pegasus

CT = Hartmetall
Carbide Tip

DCR601, 801, 901, 905 / E22, 22L, 32, 32L, 51, 52, 52L, 54, 256 ETS32, 32L, 51, 52 / EX/EXT 3200, 5200 L32, 52, R53, 57, S22, 32, 52, LX3200, 5200 M600, 700			
	Originalnummer <i>Genuine no.</i>	Artikelnummer <i>Item-no.</i> STANDARD	Artikelnummer <i>Item-no.</i> PREMIUM QUALITY
Kettenstichgreifer <i>Looper</i>	211845(29)		B211845m
	212092(10)		B212092m
	212215		B212215m
	212644		B212644m
	213105		B213105m
	277010(2)		B277010m
	277010A(5)		B277010Am
	277010B		B277010Bm
	277011(3)		B277011m
	277012		B277012m
	277013		B277013m
	277014(1)		B277014m
	277014A(8)		B277014Am
	277014B(9)		B277014Bm
	277015		B277015m
	277015A		B277015Am
	277017(11)		B277017m
	277018		B277018m
	277018C		B277018Cm
	277019(12)		B277019m
Nähgarnitur 0x4mm <i>Gauge Set 0x4mm</i> (für / for E52)	Stichplatte <i>Needle Plate</i>	210787	B210787m
	Transporteur <i>Feed Dog</i>	210443	B210443m
		210568	*B210568
Schraube <i>Screw</i>	5292	B3637	

*Nicht mehr lieferbar
*No longer available

Pegasus

CT = Hartmetall
 Carbide Tip

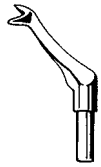

B211845m



B212092m

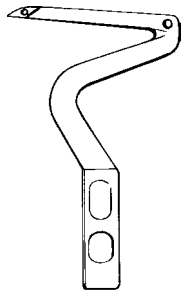

B212215m

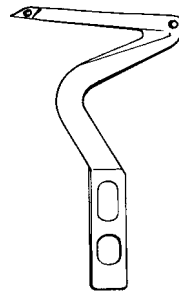

B212644m

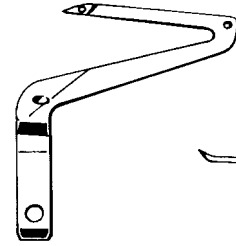

B213105m



B277010m



B277010Am



B277010Bm



B277011m



B277012m



B277013m



B277014m



B277014Am



B277014Bm

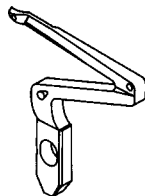

B277015m

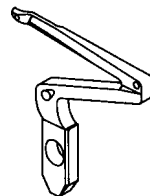

B277015Am



B277017m

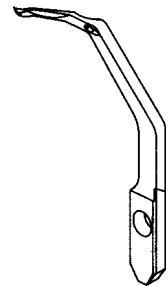

B277018m

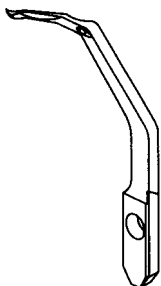

B277018Cm



B277019m

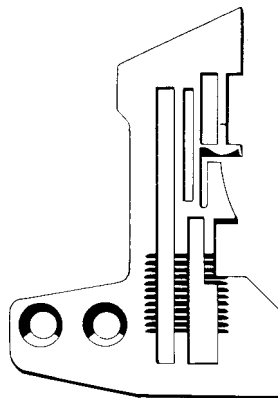

B210787m

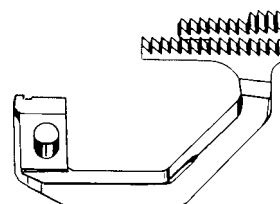

B210443m

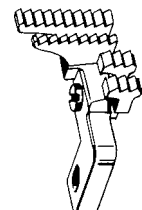

B210568m



B3637

Pegasus

CT = Hartmetall
Carbide Tip

DCR601, 801, 901, 905 / E22, 22L, 32, 32L, 51, 52, 52L, 54, 256 ETS32, 32L, 51, 52 / EX/EXT 3200, 5200 L32, 52, R53, 57, S22, 32, 52, LX3200, 5200 M600, 700				
		Originalnummer Genuine no.	Artikelnummer Item-no. STANDARD	Artikelnummer Item-no. PREMIUM QUALITY
Nähgarnitur 3x4mm Gauge Set 3x4mm (für / for E52)	Stichplatte Needle Plate	210846		B210846m
	Transporteur Feed Dog	210494		B210494m
	Transporteur Feed Dog	210581		B210581m
Nähgarnitur 0x5mm Gauge Set 0x5mm (für / for E52)	Stichplatte Needle Plate	210788		B210788m
	Transporteur Feed Dog	210443		B210443m
		210568	*B210568	B210568m
Nähgarnitur 2x5mm Gauge Set 2x5mm (für / for E52)	Stichplatte Needle Plate	210810		B210810m
	Transporteur Feed Dog	210445		B210445m
		210575		B210575m
Nähgarnitur 5x5mm Gauge Set 5x5mm (für / for E32)	Stichplatte Needle Plate	210851		B210851m
	Transporteur Feed Dog	210494		B210494m
	Transporteur Feed Dog	210581		B210581m
Nähgarnitur 4mm Gauge Set 4mm (für / for L32)	Stichplatte Needle Plate	205321		B205321m
	Transporteur Feed Dog	204907		B204907m
	Transporteur Feed Dog	208336		B208336m
	Transporteur Feed Dog	208338		B208338m
Nähgarnitur 5mm Gauge Set 5mm (für / for L32)	Stichplatte Needle Plate	205322		B205322m
	Transporteur Feed Dog	204907		B204907m
	Transporteur Feed Dog	208336		B208336m
	Transporteur Feed Dog	208338		B208338m
Nähgarnitur 3x5mm Gauge Set 3x5mm (für / for L32)	Stichplatte Needle Plate	204252B		B204252Bm
	Transporteur Feed Dog	208063		B208063m
	Transporteur Feed Dog	208215		B208215m
Nähgarnitur 5x5mm Gauge Set 5x5mm (für / for L32)	Stichplatte Needle Plate	204360A		B204360Am
	Transporteur Feed Dog	208063		B208063m
	Transporteur Feed Dog	208215		B208215m

*Nicht mehr lieferbar
*No longer available

Pegasus

CT = Hartmetall
 Carbide Tip

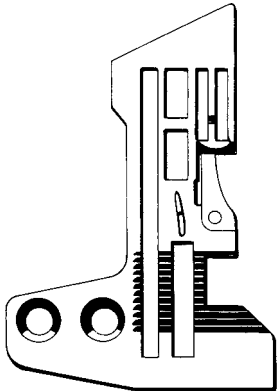

B210846m

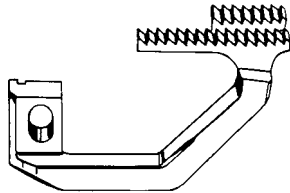

B210494m

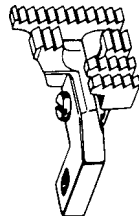

B210581m

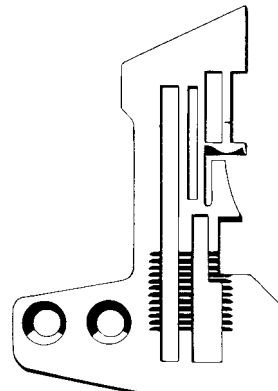

B210788m

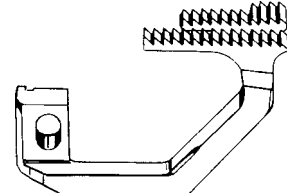

B210443m

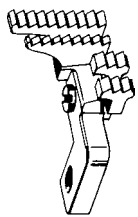

B210568m

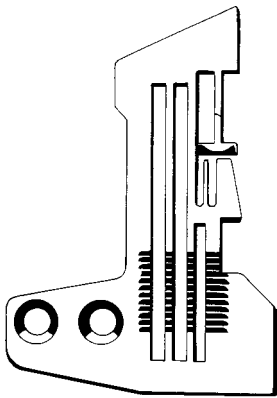

B210810m

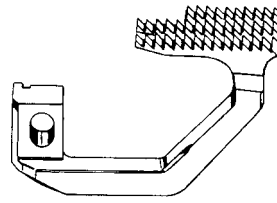

B210445m

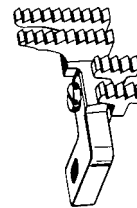

B210575m

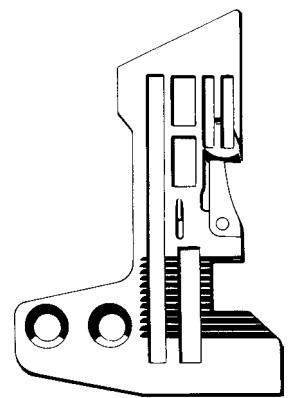

B210851m

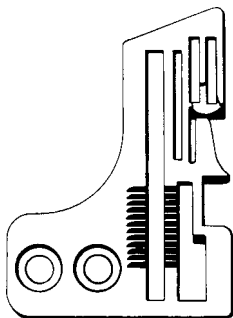

B205321m

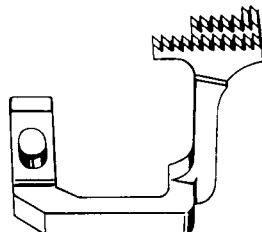

B204907m

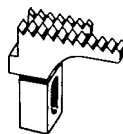

B208336m



B208338m

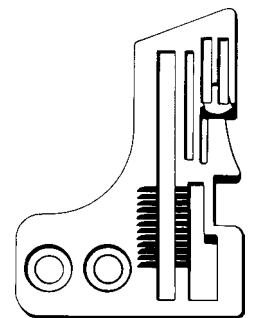

B205322m

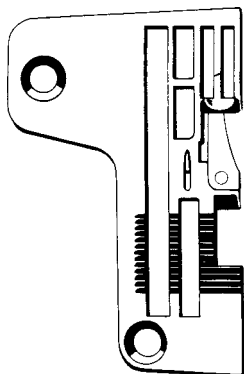

B204252Bm

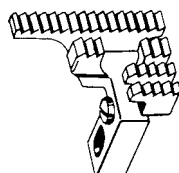

B208063m

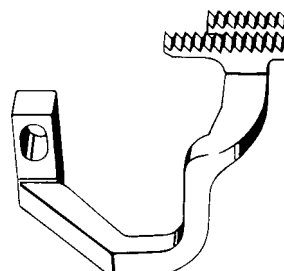

B208215m

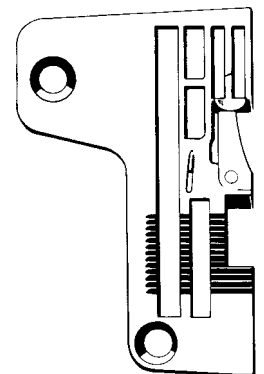

B204360Am

Pegasus

CT = Hartmetall
 Carbide Tip

DCM-203, 220, 230		
	Originalnummer Genuine no.	Artikelnummer Item-no. PREMIUM QUALITY
Messer Knife	137562	BD-2856m
	138559	BD-2857m



BD-2856m



BD-2857m

FS, FV, FW200		
	Originalnummer Genuine no.	Artikelnummer Item-no. PREMIUM QUALITY
Messer Knife	236606	B236606m
	236608	B236608m
Kettenstichgreifer Looper	236500	B236500m
	236500A	B236500Am
	236502A	B236502Am
	236503A	B236503Am
	236504A	B236504Am
Spreizer Spreader	236609	B236609m
	236610	B236610m
Zunge Tongue	236101	B236101m



B236606m



B236608m



B236500m

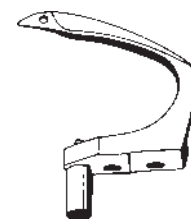

B236500Am

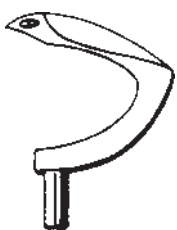

B236502Am



B236503Am

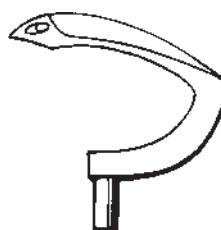

B236504Am



B236101m



B236609m

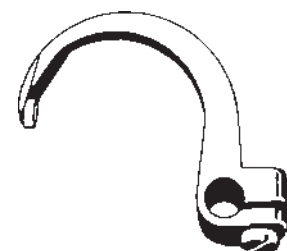

B236610m

Pegasus

CT = Hartmetall
 Carbide Tip

TM625		
	Originalnummer Genuine no.	Artikelnummer Item-no. PREMIUM QUALITY
Kettenstichgreifer Looper	188004	B188004m

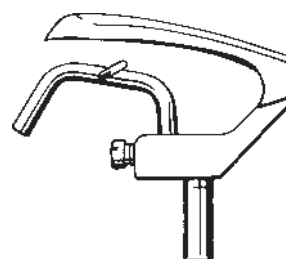

B188004m

W500			
	Originalnummer Genuine no.	Artikelnummer Item-no. STANDARD	Artikelnummer Item-no. PREMIUM QUALITY
Messer Knife	204161	BD-2788	BD-2788m
	204161A		B204161Am
	306394CT		BCT306394m
Kettenstichgreifer Looper	257550-91		B257550m
	257552		B257552m



BD-2788
 BD-2788m



B204161Am



BCT306394m

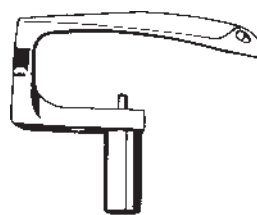

B257550m

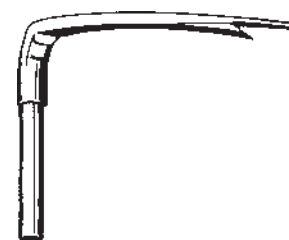

B257552m

Pegasus

CT = Hartmetall
 Carbide Tip

W600, WT600		
	Originalnummer <i>Genuine no.</i>	Artikelnummer <i>Item-no.</i> PREMIUM QUALITY
Messer <i>Knife</i>	350218	B350218m
	350220	B350220m
Kettenstichgreifer <i>Looper</i>	257566	B257566m



B350218m



B350220m



B257566m

W700		
	Originalnummer <i>Genuine no.</i>	Artikelnummer <i>Item-no.</i> PREMIUM QUALITY
Kettenstichgreifer <i>Looper</i>	257555	B257555m
	257565	B257565m

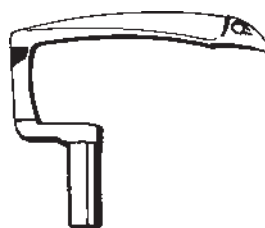

B257555m

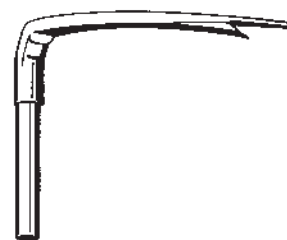

B257565m

Pegasus

CT = Hartmetall
 Carbide Tip

W4562			
	Originalnummer Genuine no.	Artikelnummer Item-no. STANDARD	Artikelnummer Item-no. PREMIUM QUALITY
Messer Knife	204161	BD-2788	BD-2788m
	204161A		B204161Am
	306394CT		BCT306394m
Kettenstichgreifer Looper	257552		B257552m

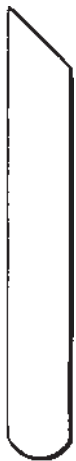

BD-2788
 BD-2788m



B204161Am



BCT306394m

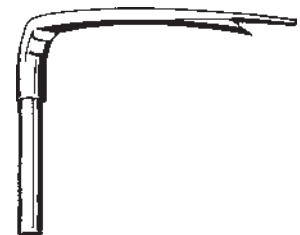

B257552m

Pfaff

CT = Hartmetall
 Carbide Tip

133, 134		
	Originalnummer Genuine no.	Artikelnummer Item-no. PREMIUM QUALITY
Messer Knife	15323	B15323m
Schneidbrücke Insert	15320-2.0CT	BCT15320-2.0m
	15320-3.0CT	BCT15320-3.0m
	15320-3.5CT	BCT15320-3.5m
	15320-4.0CT	BCT15320-4.0m
	15320-4.5CT	BCT15320-4.5m
	15320-5.0CT	BCT15320-5.0m
	15320-6.0CT	BCT15320-6.0m
	15320x2,0	B15320-2.0m
	15320x2,5	B15320-2.5m
	15320x3,0	B15320-3.0m
	15320x3,5	B15320-3.5m
	15320x4,0	B15320-4.0m
	15320x4,5	B15320-4.5m
	15320x5,0	B15320-5.0m



B15323m



BCT15320m
 B15320m

Pfaff

CT = Hartmetall
 Carbide Tip

134		
	Originalnummer Genuine no.	Artikelnummer Item-no. STANDARD
Standardfuß Standard Foot	46682	B46682F
Ausgleichsfuß, links gefedert Compensating Foot, left	9057 (1/32")	B620F
	9057-24 (1/16")	B621F
Ausgleichsfuß, rechts gefedert Compensating Foot, right suspension	9057 (1/32")	B610F
	9057-21 (1/16")	B611F
	9057 (1/8")	B613F
	9057 (1/4")	B614F
Ausgleichsfuß, doppelt gefedert Compensating Foot, double	9057 (1/32")	B630F
	9057 (1/16")	B631F
Kantenfuß Cording Foot	26473	B26473F
	26474	B26474F
Teflonfuß Teflon Foot	46682T	BD-3438
Teflonsohle Teflon sole für/for BD-3438	46682TB	BMT8



B46682F

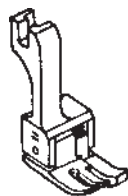

B610F
 B611F
 B613F
 B614F



B26473F



B26474F



BD-3438

Pfaff

CT = Hartmetall
Carbide Tip

138			
		Originalnummer <i>Genuine no.</i>	Artikelnummer <i>Item-no.</i> STANDARD
Nähgarnitur <i>Gauge Set</i>	Standardfuß <i>Standard Foot</i>	43522	BD-3440F
	Stichplatte <i>Needle Plate</i>	26512	B26512
	Transporteur <i>Feed Dog</i>	26505	B26505
Nähgarnitur x4,5mm Überstich <i>Gauge Set x4,5mm zig-zag stitch</i>	Standardfuß <i>Standard Foot</i>	43522	BD-3440F
	Stichplatte <i>Needle Plate</i>	46313	BD-3431
	Transporteur <i>Feed Dog</i>	26883	BD-3432
Nähgarnitur x6,0mm Überstich <i>Gauge Set x6,0mm zig-zag stitch</i>	Standardfuß <i>Standard Foot</i>	51998	BD-3440AF
	Stichplatte <i>Needle Plate</i>	26888	BD-3431A
	Transporteur <i>Feed Dog</i>	26891	BD-3432A
Rollfuß <i>Roller Foot</i>	43522R	BD-3443F	Nicht mehr lieferbar <i>No longer available</i>



BD-3440F
BD-3440AF

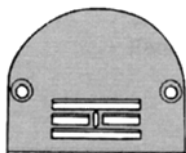

B26512

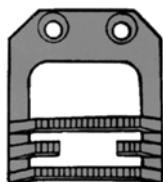

B26505

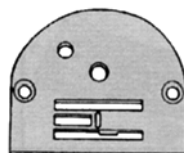

BD-3431
BD-3431A

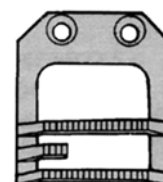

BD-3432
BD-3432A

138, 238, 437, 438		
	Originalnummer <i>Genuine no.</i>	Artikelnummer <i>Item-no.</i> STANDARD
Fadenanzugsfeder <i>Take-up Spring</i>	91-006814-05	BD-3419D

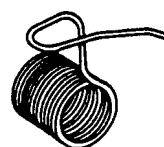

BD-3419D

Pfaff

CT = Hartmetall
 Carbide Tip

141, 143		
	Originalnummer Genuine no.	Artikelnummer Item-no. PREMIUM QUALITY
Messer Knife	19506x5.0	BD-2858m
	19506x7.0	BD-2859m
	19506x9.0	BD-2860m

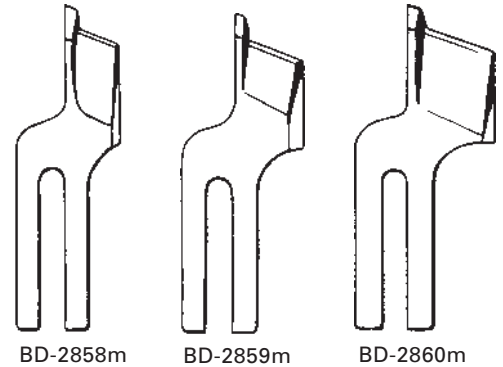

142, 242, 1242-732			
	Originalnummer Genuine no.	Artikelnummer Item-no. STANDARD	Artikelnummer Item-no. PREMIUM QUALITY
Stichplatte Needle Plate	91-048909-93/001CT		BD-2863m
Messer Knife	10192		BD-2862m
	113460		BD-2861m
Umbaugarnitur Conversion Set x4,8 mm	Nadelstange Needle Bar	710005x4,8	B710005x4,8
	Standardfuß Standard Foot	40811x4,8	B40811x4,8
	Stichplatte Needle Plate	46715x4,8	B46715x4,8
	Transporteur Feed Dog	46714x4,8	B46714x4,8
Umbaugarnitur Conversion Set x6,4 mm	Nadelstange Needle Bar	710005x6,4	B710005x6,4
	Standardfuß Standard Foot	40811x6,4	B40811x6,4
	Stichplatte Needle Plate	46715x6,4	B46715x6,4
	Transporteur Feed Dog	46714x6,4	B46714x6,4

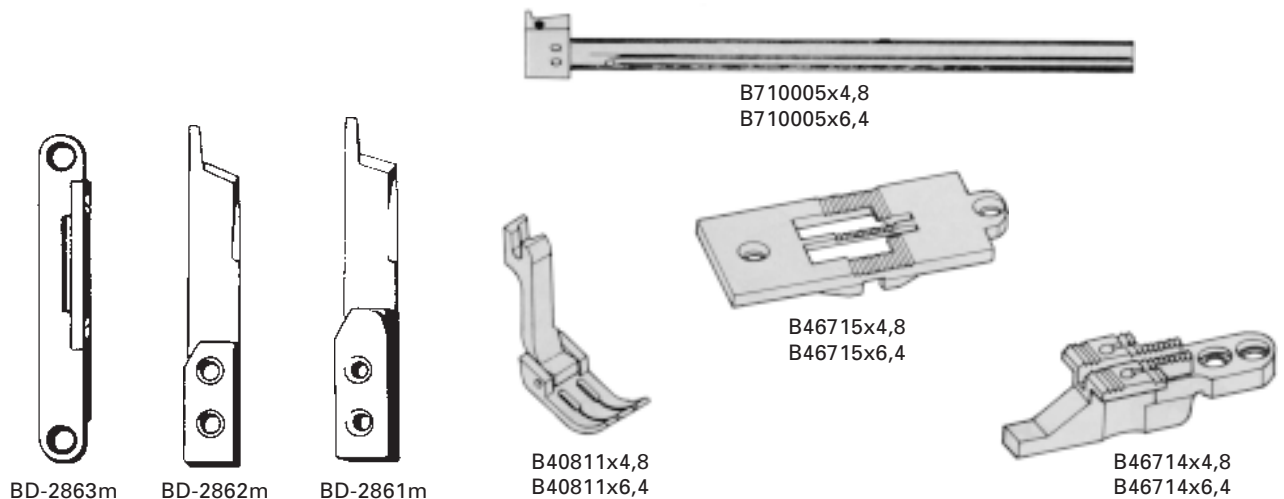

Pfaff

CT = Hartmetall
Carbide Tip

143, 191, 193, 471, 474, 491, 493 1471, 1474, 1491, 1493, 1494		
	Originalnummer <i>Genuine no.</i>	Artikelnummer <i>Item-no.</i> PREMIUM QUALITY
Stichplatte <i>Needle Plate</i>	58309-1.2Ax4.5	B91-058309-1.2Ax4.5m
Messer <i>Knife</i>	119714	B91-119714-05m
	91-011165-04/001	B11165x2.7m
	91-011165-04/002	B11165x3.0m
	91-011165-04/003	B11165x3.5m
	91-011165-04/011	B11165x2.7HSSm
	91-011165-04/013	B11165x3.5HSSm
	91-011165Fx2.7	B11165Fx2.7m
	91-011179-04/001	B11179x2.7m
	91-011179-04/003	B11179x3.5m
	91-011179-04/011	B11179x2.7HSSm
	91-011233-04/001	B11233x2.7m
	91-011233-04/011	B11233x2.7HSSm
	91-011324-04/001	B11324x2.7m
	91-011324-04/002	B11324x3.0m
	91-011324-04/003	B11324x3.5m
	91-011324-04/011	B11324x2.7HSSm
	91-011324-04/013	B11324x3.5HSSm
	91-119202-04/001	B119202m
	91-119202-04/011	B119202HSSm
	91-119444-04/001	B119444m
	91-119444-04/011	B119444HSSm
	91-119715-05	B91-119715-05m
Fadenschere <i>Thread Scissor</i>	119486	B91-119486-91m
	91-164672-91	B91-164672-91m

Pfaff

CT = Hartmetall
 Carbide Tip



B91-058309-1.2Ax4.5m



B91-119714-05m



B11165x2.7m
 B11165x3.0m
 B11165x3.5m
 B11165Fx2.7m

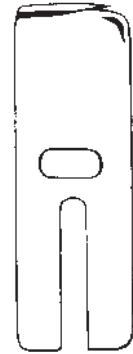

B11165x2.7HSSm
 B11165x3.5HSSm



B11179x2.7m
 B11179x3.5m



B11179x2.7HSSm

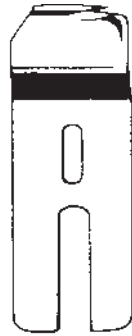

B11233x2.7m



B11233x2.7HSSm



B11324x2.7m
 B11324x3.0m
 B11324x3.5m



B11324x2.7HSSm
 B11324x3.5HSSm



B119202m



B119202HSSm



B119444m



B119444HSSm



B91-119715-05m



B91-119486-91m



B91-164672-91m

Pfaff

CT = Hartmetall
Carbide Tip

145, 545, 1245			
		Originalnummer Genuine no.	Artikelnummer Item-no. STANDARD QUALITY
Nadelstange Needle Bar		710650	B710650
Presserstange Presser Bar		11718	B11718
Nähgarnitur Gauge Set x5,0	Standardfuß Standard Foot	40474x5,0	BD-3446A/2
		40475x5,0	BD-3446A/1
Nähgarnitur Gauge Set x6,0	Standardfuß Standard Foot	40474x6,0	BD-3446B/2
		40475x6,0	BD-3446B/1
Nähgarnitur Gauge Set x8,0	Standardfuß Standard Foot	40474x8,0	BD-3446C/2
		40475x8,0	BD-3446C/1
Nähgarnitur, mit zwei Zehen Gauge Set with two toes	Standardfuß Standard Foot	40474x4,0	BD-3446E/2
		46970	BD-3446E/1
Kantenfußsatz, Zehe rechts Cording Foot Set, right toe	Kantenfuß Cording Foot	49085	BD-3444A/2
		49558C	BD-3444A/1
Kederfußsatz Piping Foot Set x3,0 mm	Kederfüße Piping Feet	49047x3,0	BD-3445B/2
		49544x3,0	BD-3445B/1
Kederfußsatz Piping Foot Set x4,0 mm	Kederfüße Piping Feet	49047x4,0	BD-3445C/2
		49544x4,0	BD-3445C/1
Kederfußsatz Piping Foot Set x5,0 mm	Kederfüße Piping Feet	49047x5,0	BD-3445D/2
		49544x5,0	BD-3445D/1
Kederfußsatz Piping Foot Set x6,0 mm	Kederfüße Piping Feet	49047x6,0	BD-3445E/2
		49544x6,0	BD-3445E/1
Kederfußsatz Piping Foot Set x8,0 mm	Kederfüße Piping Feet	49047x8,0	BD-3445F/2
		49544x8,0	BD-3445F/1
Kederfußsatz Piping Foot Set x9,5 mm	Kederfüße Piping Feet	49047x9,5	BD-3445G/2
		49544x9,5	BD-3445G/1
Nähgarnitur Gauge Set	Stichplatte Needle Plate	26746	BD-3433B
	Transporteur Feed Dog	26745B	BD-3434B

Pfaff

CT = Hartmetall
 Carbide Tip



B710650



B11718



BD-3446A/2
 BD-3446B/2
 BD-3446C/2



BD-3446A/1
 BD-3446B/1
 BD-3446C/1



BD-3446E/2



BD-3446E/1

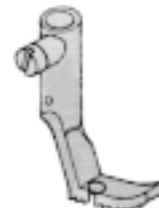

BD-3444A/2



BD-3444A/1



BD-3445B/2
 BD-3445C/2
 BD-3445D/2
 BD-3445E/2
 BD-3445F/2
 BD-3445G/2



BD-3445B/1
 BD-3445C/1
 BD-3445D/1
 BD-3445E/1
 BD-3445F/1
 BD-3445G/1



BD-3433B



BD-3434B

143, 191, 193, 471, 474, 491, 493 1471, 1474, 1491, 1493, 1494		
	Originalnummer Genuine no.	Artikelnummer Item-no. PREMIUM QUALITY
Fadenschere Thread Scissor	91-164673-01	B91-164673-01m
Klemme Clamp	119455	B91-119455-05m
Lineal Guide	91-156114-05	B91-156114-05m



B91-164673-01m

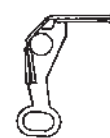

B91-119455-05m

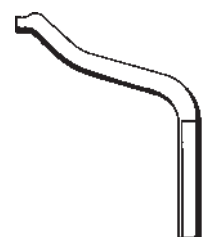

B91-156114-05m

1.5

Pfaff

CT = Hartmetall
Carbide Tip

145, 545, 1245			
		Originalnummer <i>Genuine no.</i>	Artikelnummer <i>Item-no.</i> STANDARD
Apparate- Umbaugarnitur <i>Attachment Conversion Set</i>	Apparatefüße <i>Attachment Feet</i>	42819	B42819
	Apparatefüße <i>Attachment Feet</i>	44227	B44227
	Stichplatte <i>Needle Plate</i>	45592C	B45592
	Transporteur <i>Feed Dog</i>	45591C	B45591
	Apparateträger <i>Attachment Bracket</i>	45607	B45607
Umbaugarnitur, kpl. wie oben beschrieben <i>Conversion Set, cpl. as described above</i>			BPF145

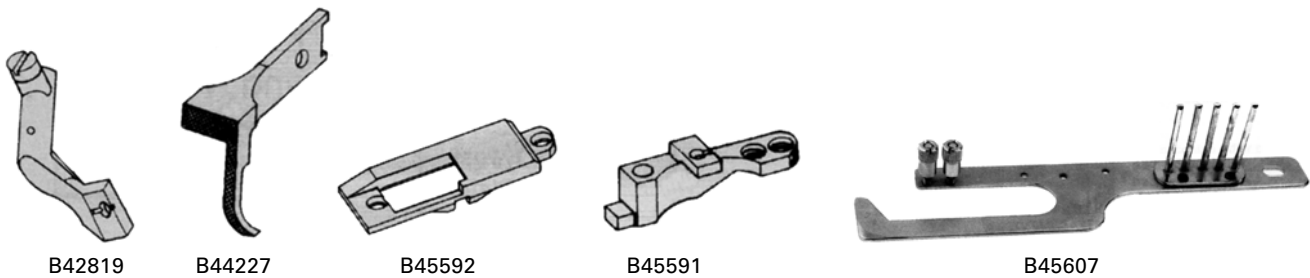

146, 546, 1246			
		Originalnummer <i>Genuine no.</i>	Artikelnummer <i>Item-no.</i> STANDARD
Nähfußsatz <i>Sewing Foot Set</i>	Standardfuß <i>Standard Foot</i>	40429x6.4	B40429x6.4
	Standardfuß <i>Standard Foot</i>	40430x6.4	B40430x6.4

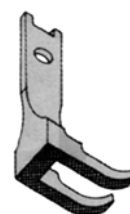

B40429x6.4



B40430x6.4

Pfaff

CT = Hartmetall
 Carbide Tip

151, 153		
	Originalnummer Genuine no.	Artikelnummer Item-no. PREMIUM QUALITY
Messer Knife	15435x4,0	BD-2866am
	15435x5,0	BD-2866m
	15435x7,0	BD-2867m
	15435x9,0	BD-2868m

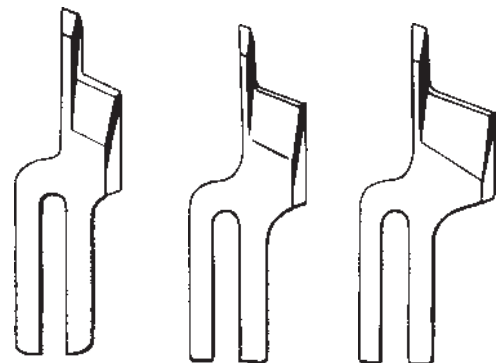

BD-2866am
BD-2866m

BD-2867m

BD-2868m

155, 175		
	Originalnummer Genuine no.	Artikelnummer Item-no. PREMIUM QUALITY
Messer Knife	19737x5,0	BD-2869m
	19737x7,0	BD-2870m
	19737x9,0	BD-2871m

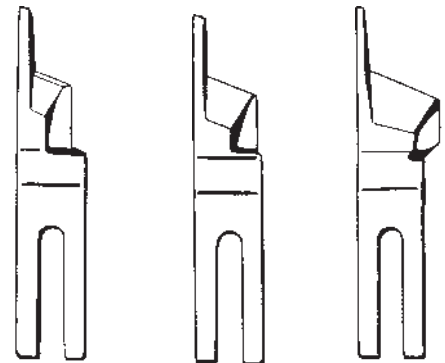

BD-2869m

BD-2870m

BD-2871m

194-900		
	Originalnummer Genuine no.	Artikelnummer Item-no. PREMIUM QUALITY
Messer Knife	91-011957-15	B91-011957-15m



B91-011957-15m

Pfaff

CT = Hartmetall
Carbide Tip

333, 335, 337			
	Originalnummer <i>Genuine no.</i>	Artikelnummer <i>Item-no.</i> STANDARD	Artikelnummer <i>Item-no.</i> PREMIUM QUALITY
<i>Messer Knife</i>	91-014046-05		B91-014046-05m
	91-175540-05	BD-2886	BD-2886m



B91-014046-05m

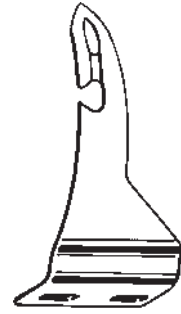

BD-2886
BD-2886m

335			
		Originalnummer <i>Genuine no.</i>	Artikelnummer <i>Item-no.</i> STANDARD
<i>Nähgarnitur Gauge Set</i>	<i>Stichplatte Needle Plate</i>	46009	B91-046009-04
	<i>Transporteur Feed Dog</i>	46008	B91-046008-04
<i>Apparate- Nähgarnitur Attachment Gauge Set</i>	<i>Apparatefüße Attachment Feet</i>	40431	B40431
		40432	B40432
	<i>Stichplatte Needle Plate</i>	46498	B46498
	<i>Transporteur Feed Dog</i>	46497	B46497
	<i>Apparateträger Attachment Bracket</i>	40895	B40895
<i>Umbaugarnitur, kpl. wie oben beschrieben Conversion Set, cpl. as described above</i>			BPF335

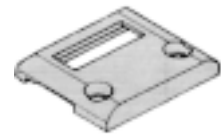

B91-046009-04



B91-046008-04



B40431



B40432



B46498



B46497



B40895

Pfaff

CT = Hartmetall
 Carbide Tip

418, 437, 438, 439, 917, 918, 937, 938, 939, 3568, 3704		
	Originalnummer <i>Genuine no.</i>	Artikelnummer <i>Item-no.</i> PREMIUM QUALITY
Messer <i>Knife</i>	91-150166-05	B91-150166-05m
	91-150446-05	BCT235-06108m
	91-167350-01	BCT235-06009m
	91-167973-05	B235-06009m
	91-168498-05	B91-168498-15m
	91-168499-05	B91-168499-05m
Spulenkapsellüfter <i>Bobbin Case Opener</i>	91-168300-12	B91-168300-12m

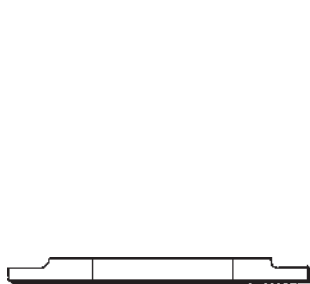

B91-150166-05m



BCT235-06108m

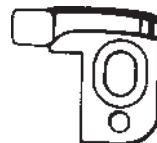

BCT235-06009m

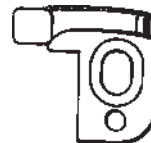

B235-06009m



B91-168498-15m



B91-168499-05m

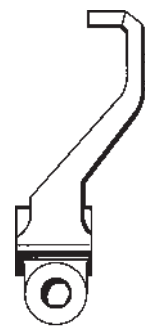

B91-168300-12m

Pfaff

CT = Hartmetall
 Carbide Tip

421, 422, 441, 1421, 1425, 1426, 1446, 3588		
	Originalnummer Genuine no.	Artikelnummer Item-no. PREMIUM QUALITY
Messer Knife	91-176357-05	B91-176357-05m
	91-176094-05	B91-176094-05m
	91-166700-04/001x7	B91-166700-04/001x7m
	91-166700-04/002	B91-166700-04/002x9m
	91-166700-04/003	B91-166700-04/003x12m
	91-166701-04/004	B91-166701-04/004x7m
	91-166701-04/005	B91-166701-04/005x9m
	91-166701-04/006	B91-166701-04/006x12m
	91-186659-05	B91-186659-05m
	91-186661-05	B91-186661-05m
	91-266584-05	B91-266584-05m

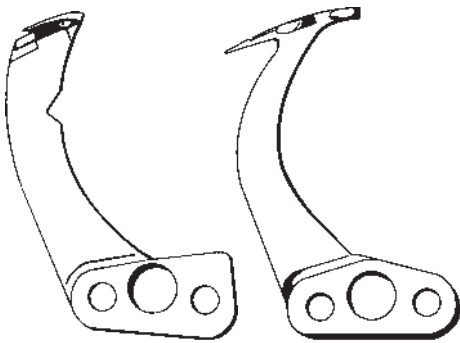

B91-176357-05m

B91-176094-05m



B91-166700-04/
001x7m



B91-166700-04/
002x9m



B91-166700-04/
003x12m



B91-166701-04/
004x7m

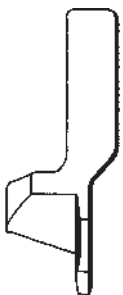

B91-166701-04/
005x9m

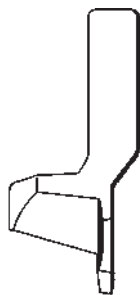

B91-166701-04/
006x12m



B91-186659-05m



B91-186661-05m

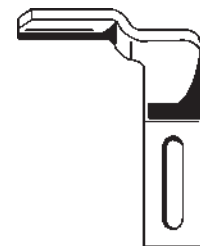

B91-266584-05m

Pfaff

CT = Hartmetall
 Carbide Tip

441, 442				
		Originalnummer Genuine no.	Artikelnummer Item-no. STANDARD	Artikelnummer Item-no. PREMIUM QUALITY
Messer Knife		91-173197-15		B91-173197-15m
Nähgarnitur Gauge Set für / for 442 x4,8mm	Stichplatte Needle Plate	58108x4,8mm	B58108x4.8	
	Transporteur Feed Dog	47574x4,8 mm	B47574x4.8	
Nähgarnitur Gauge Set für / for 442 x6,4mm	Stichplatte Needle Plate	58108x6,4mm	B58108x6.4	
	Transporteur Feed Dog	47574x6,4mm	B47574x6.4	

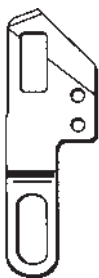

B91-173197-15m



B58108x4.8
 B58108x6.4



B47574x4.8
 B47574x6.4

461, 463, 469, 481, 483, 487, 489, 563, 951, 953 1051, 1053, 1181, 1183		
	Originalnummer Genuine no.	Artikelnummer Item-no. STANDARD
Fadenanzugsfeder Take-up Spring	91-006814-05	BD-3419D



BD-3419D

Pfaff

CT = Hartmetall
 Carbide Tip

461, 463, 469, 481, 483, 487, 489, 563, 951, 953 1051, 1053, 1181, 1183, 1481, 1483, 1487 3668, 3588, 3811, 3819, 3822, 3827 5463, 5483, 5489, 3566		
	Originalnummer Genuine no.	Artikelnummer Item-no. PREMIUM QUALITY
Messer Knife	91-165642-15	B91-165642-15m
	91-170440-05	B91-170440-05m
	91-170560-04/002	B91-170560-04/002x7m
	91-170560-04/003	B91-170560-04/003x9m
	91-189140-05	B91-189140-05m
Fänger Catcher	91-165641-05	B91-165641-05m
	91-262184-05	B91-262184-05m
Spulenkapsellüfter Bobbin Case Opener	91-171874-12	B91-171874-12m
	91-174481-12	B91-174481-12m



B91-165642-15m



B91-170440-05m



B91-170560-04/002x7m



B91-170560-04/003x9m



B91-189140-05m

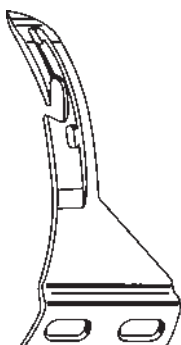

B91-165641-05m

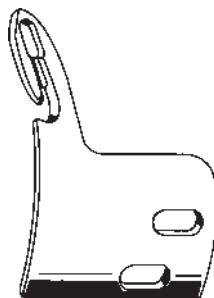

B91-262184-05m

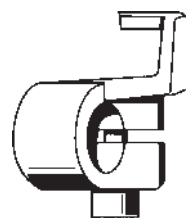

B91-171874-12m



B91-174481-12m

Pfaff

CT = Hartmetall
 Carbide Tip

461, 463, 469, 481, 483, 487, 489, 563, 951, 953, 1051, 1053, 1181, 1183 1481, 1483, 1487, 3566, 3668, 3588, 3811, 3819, 3822, 3827, 5463, 5483, 5489			
	Originalnummer Genuine no.	Artikelnummer Item-no. STANDARD	Artikelnummer Item-no. PREMIUM QUALITY
Messer Knife	069596x7.0CT		BD-2883CTm
	069596x9.0CT		BD-2883am
	169239x0.8	BD-2887	BD-2887m
	169239x1.0	BD-2888	BD-2888m
	169395x5.0HSS	BD-2880	BD-2880m
	169395x7.0CT		BD-2881CTm
	169395x7.0HSS		BD-2881m
	169395x9.0CT		BD-2882CTm
	169395x9.0HSS		BD-2882m
	171853	BD-2889	BD-2889m
	69595x5.0HSS		BD-2877m
	69595x7.0HSS		BD-2878m
	69595x9.0HSS		BD-2879m
	91-175540-05	BD-2886	BD-2886m

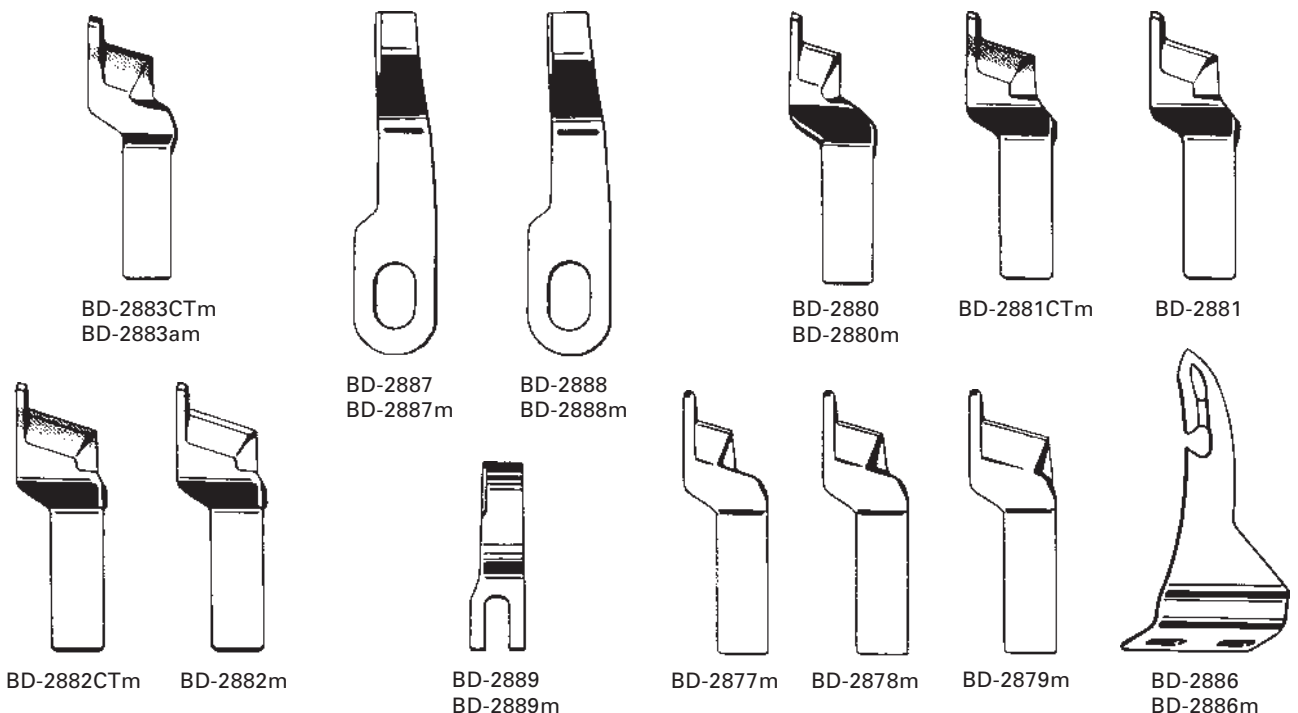

Pfaff

CT = Hartmetall
Carbide Tip

463, 563, 953, 1053			
		Originalnummer Genuine no.	Artikelnummer Item-no. STANDARD
Nähgarnitur, mittel, dreihreihig <i>Gauge Set, medium, 3 rows</i>	Stichplatte <i>Needle Plate</i>	91-026096-04/005	BD-3425B
	Transporteur <i>Feed Dog</i>	91-026095-04/003	BD-3426B
Nähgarnitur, mittel, drei volle Reihen <i>Gauge Set, medium, 3 full rows</i>	Stichplatte <i>Needle Plate</i>	91-026209-04/004	BD-2864
	Transporteur <i>Feed Dog</i>	91-026208-05/000	BD-2865
Nähgarnitur, mittel- grob, dreihreihig <i>Gauge Set, medium- heavy, 3 rows</i>	Stichplatte <i>Needle Plate</i>	91-026272-04/004	BD-3427A
	Transporteur <i>Feed Dog</i>	91-026271-04/002	BD-3428A
Nähgarnitur, grob, dreihreihig <i>Gauge Set, heavy, 3 rows</i>	Stichplatte <i>Needle Plate</i>	91-026272-04/004	BD-3427A
	Transporteur <i>Feed Dog</i>	27271C	BD-3428A/1
Nähgarnitur zur Hemdemproduktion <i>Gauge Set for Shirt Production</i>	Stichplatte <i>Needle Plate</i>	48522B	B91-048522
	Transporteur <i>Feed Dog</i>	47461	B91-047461
Apparate- Nähgarnitur <i>Attachment Gauge Set</i>	Stichplatte <i>Needle Plate</i>		B461FM
	Transporteur <i>Feed Dog</i>		B462FM



BD-3425B



BD-3426B



BD-2864
B91-048522

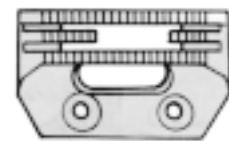

BD-2865
B91-047461



BD-3427A

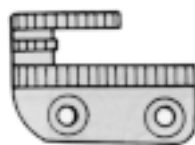

BD-3428A
BD-3428A/1

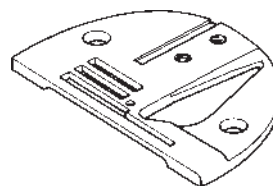

B461FM

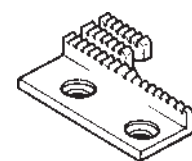

B462FM

Pfaff

CT = Hartmetall
 Carbide Tip

467, 487			
		Originalnummer Genuine no.	Artikelnummer Item-no. STANDARD
Apparate- Nähgarnitur Attachment Gauge Set	Apparatefüße Attachment Feet	55578x4.5	BGA55578/1
		55578x6.5	BGA55578/2
		55578x7.5	BGA55578/3
		55578x8.5	BGA55578/4
		55578x9.5	BGA55578/5
	Stichplatte Kl. 467 Needle Plate Cl. 467		BCF461
	Obertransporteur 467 Upper Feeder Cl. 467	49098	BGA49098
	Transporteur Kl. 467 Feed Dog Cl. 467		BCF462
	Stichplatte Kl. 487 Needle Plate Cl. 487	58234	BGA58234
	Obertransporteur 487 Upper Feeder Cl. 487	49155	BGA49155
Transporteur Kl. 487 Feed Dog Cl. 487	47671	BGA47671	

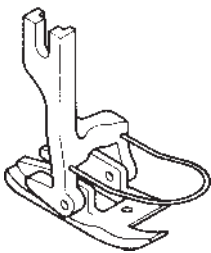

BGA55578/1
 BGA55578/2
 BGA55578/3
 BGA55578/4
 BGA55578/5

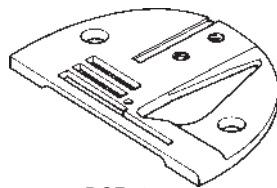

BCF461

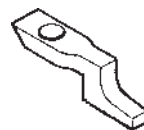

BGA49098

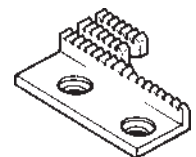

BCF462

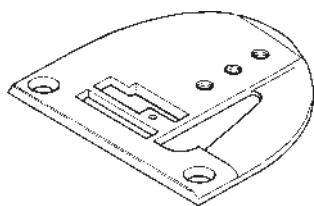

BGA58234



BGA49155

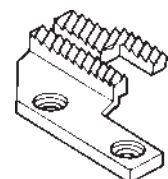

BGA47671

Pfaff

CT = Hartmetall
 Carbide Tip

483			
		Originalnummer <i>Genuine no.</i>	Artikelnummer <i>Item-no.</i> STANDARD
Nähgarnitur <i>Gauge Set</i>	Stichplatte <i>Needle Plate</i>	58132	B91-058132-04
	Transporteur <i>Feed Dog</i>	47547	B91-047547-1.5

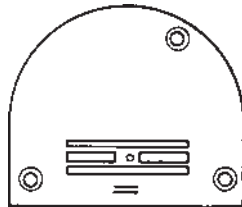

B91-058132-04

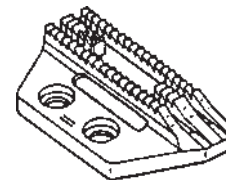

B91-047547-15

493-755-743-04		
	Originalnummer <i>Genuine no.</i>	Artikelnummer <i>Item-no.</i> PREMIUM QUALITY
Messer <i>Knife</i>	91-175952-05	B175952m



B175952m

Pfaff

CT = Hartmetall
 Carbide Tip

3114, 3116, 3117, 3527			
	Originalnummer Genuine no.	Artikelnummer Item-no. STANDARD	Artikelnummer Item-no. PREMIUM QUALITY
Knopflochmesser Button Hole Knife	20241x6.4	BD-2895	BD-2895m
	20241x9.5	BD-2896	BD-2896m
	20241x11.0		BD-2897m
	20241x12.7	BD-2898	BD-2898m
	20241x14.0	BD-2899	BD-2899m
	20241x16.0	BD-2900	BD-2900m
	20241x17.5	BD-2901	BD-2901m
	20241x19.0		BD-2902m
	20241x20.0		BD-2903m
	20241x22.2	BD-2904	BD-2904m
	20241x25.4	BD-2905	BD-2905m
	20241x28.6	BD-2906	BD-2906m
	20241x31.7		BD-2907m
	20241x33.3		BD-2908m
	20241x36.5		BD-2909m
	20241x38.1		BD-2910m
	20241x39.7		BD-2911m
	Knopflochmesser Buttonhole Knife 90°	120748-6.4	
120748-9.5			B71-90-3/8m
120748-11.0			B71-90-7/16m
120748x12.7			B71-90-1/2m
120748-14.0			B71-90-9/16m
120748x16.0			B71-90-5/8m
120748-17.5			B71-90-11/16m
120748-19.0			B71-90-3/4m
120748-22.2			B71-90-7/8m
120748-25.4			B71-90-1m
120748x28.6			B71-90-1-1/8m
120748-32.0			B71-90-1-1/4m

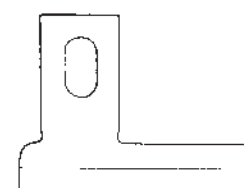
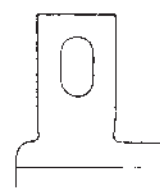
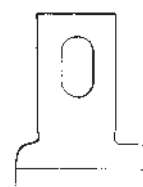
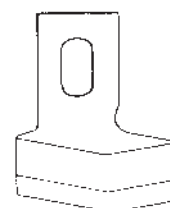
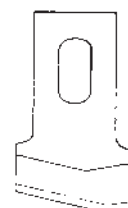

1.5

Pfaff

CT = Hartmetall
 Carbide Tip

3135		
	Originalnummer <i>Genuine no.</i>	Artikelnummer <i>Item-no.</i> PREMIUM QUALITY
Messer <i>Knife</i>	22096	B22096m
	22452	B22452m
	22453	B22453m

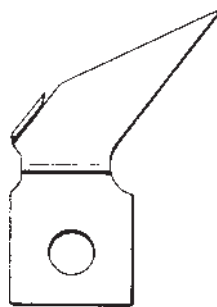

B22096m

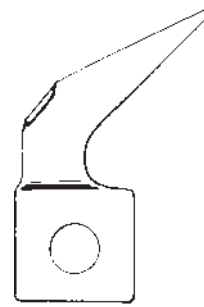

B22452m

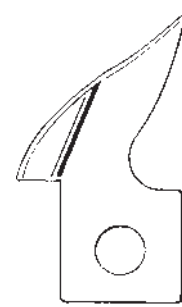

B22453m

3306, 3860		
	Originalnummer <i>Genuine no.</i>	Artikelnummer <i>Item-no.</i> PREMIUM QUALITY
Messer <i>Knife</i>	91-110482-05	B91-110482-05m
	91-132558-05	B91-132558-05m
	91-180295-05	B91-180295-05m
Kettenstichgreifer <i>Looper</i>	91-132577-92	B91-132577-92m
	91-132684-92	B91-132684-92m
	91-180614-05	B91-180614-05m



B91-110482-05m



B91-132558-05m



B91-180295-05m

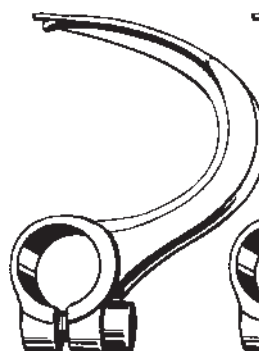

B91-132577-92m



B91-132684-92m



B91-180614-05m

Pfaff

CT = Hartmetall
 Carbide Tip

3334, 3335, 3336, 3337, 3338, 3339			
	Originalnummer Genuine no.	Artikelnummer Item-no. STANDARD	Artikelnummer Item-no. PREMIUM QUALITY
Messer Knife	22096		B22096m
	22452		B22452m
	22453		B22453m
	91-130182-05		B91-130182-05m
	91-130183-05		B91-130183-05m
	91-182344-05		B91-182344-05m
Einsatz Insert	91-065546-05		B91-065546-05m
Feder Spring	10183	BD-3420C	

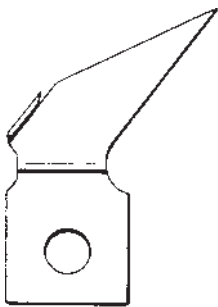

B22096m

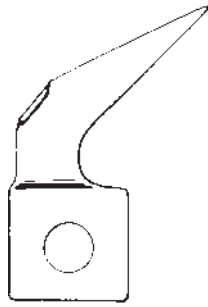

B22452m

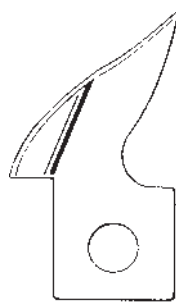

B22453m



B91-130182-05m

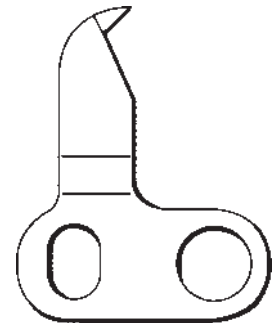

B91-130183-05m



B91-182344-05m



B91-065546-05m



BD-3420C

3822-1/24		
	Originalnummer Genuine no.	Artikelnummer Item-no. PREMIUM QUALITY
Messer Knife	91-265118-05	B91-265118-05m



B91-265118-05m

Pfaff

CT = Hartmetall
 Carbide Tip

3548, 5642, 5645, 5646		
	Originalnummer <i>Genuine no.</i>	Artikelnummer <i>Item-no.</i> PREMIUM QUALITY
Messer <i>Knife</i>	91-173792-05x7.0	B91-173792-05x7.0m
	91-173792-05x9.0	B91-173792-05x9.0m
	91-177919-05	B91-177919-05m
	91-178926-05	B91-178926-05m
Kettenstichgreifer <i>Looper</i>	91-176055-91	BD-2894m

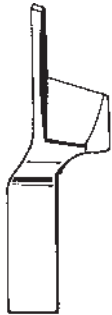

B91-173792-05x7.0m



B91-173792-05x9.0m



B91-177919-05



B91-178926-05m

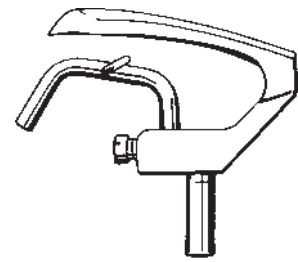

BD-2894m

3832		
	Originalnummer <i>Genuine no.</i>	Artikelnummer <i>Item-no.</i> PREMIUM QUALITY
Kettenstichgreifer <i>Looper</i>	91-169747-05	B91-169747-05m
	91-169864-05	B91-169864-05m
	91-169867-05	B91-169867-05m
	91-169874-05	B91-169874-05m

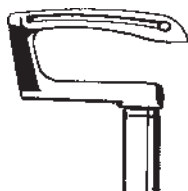

B91-169747-05m

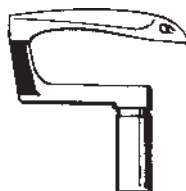

B91-169864-05m

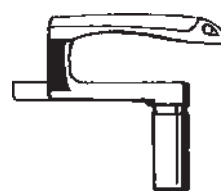

B91-169867-05m

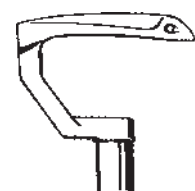

B91-169874-05m

Pfaff

CT = Hartmetall
 Carbide Tip

5463, 5467, 5483, 5487, 5489, 3801, 3806, 3811, 3832		
	Originalnummer Genuine no.	Artikelnummer Item-no. PREMIUM QUALITY
Messer Knife	91-054896-05	B91-054896-05m
	91-172071-05	BD-2891m
Kettenstichgreifer Looper	91-169711-05	BD-2893m
	91-169747-05	B91-169747-05m
	91-169864-05	B91-169864-05m
	91-169867-05	B91-169867-05m
	91-169874-05	B91-169874-05m
	91-169877-05	B91-169877-05m
	91-169990-05	B91-169990-05m
	91-170966-05	BD-2892m
	91-172376-05	B91-172376-05m
	91-176980-05	B91-176980-05m
	91-176981-05	B91-176981-05m
	91-176982-05	B91-176982-05m



B91-054896-05m



BD-2891m

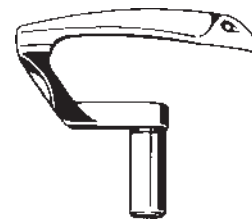

BD-2893m

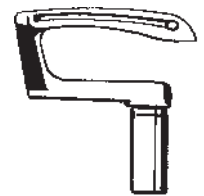

B91-169747-05m

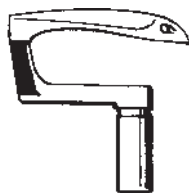

B91-169864-05m

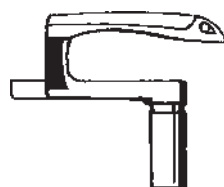

B91-169867-05m

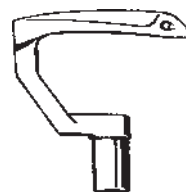

B91-169874-05m

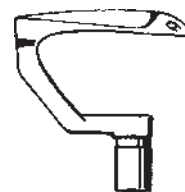

B91-169877-05m

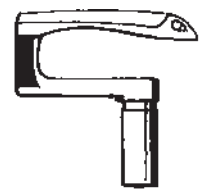

B91-169990-05m

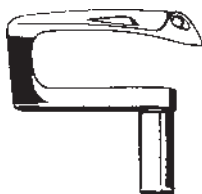

BD-2892m

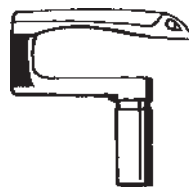

B91-172376-05m



B91-176980-05m

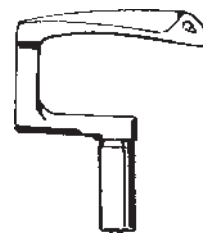

B91-176981-05m

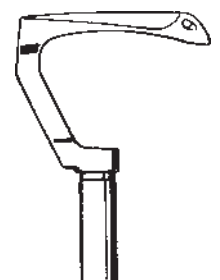

B91-176982-05m

Reece

CT = Hartmetall
 Carbide Tip

31, 32, 36, 38, 42, 46, 47, 48			
	Originalnummer Genuine no.	Artikelnummer Item-no. STANDARD	Artikelnummer Item-no. PREMIUM QUALITY
Stichplatte Needle Plate (nur / only 26,28,46,47)	48-1125-5-594CT		BCT48-1125-5-594m
Messer Knife	40-0127-0-001 TIN		B40-0127-0-001m
	40-0127-2-000	BD-2923	BD-2923m
	46-1001-4-136		BD-2923Am
Messer Knife (nur / only 36,38,46,47)	46-1004-9-073		B21-3003m
Messer Knife (nur / only 36,46,47)	46-1125-5-000		B46-1125-5-000m
Messer Knife (nur / only 38)	46-1125-5-581		B46-1125-5-581m
Messer Knife (nur / only 48)	48-1125-5-721		B21-5602m
Keramikkmesser Ceramic Knife (nur / only 36,38,46,47)	46-1001-5-487		B15487m
Kettenstichgreifer Looper	40-0057-6-000		B40-0057-6-000m
	40-0058-5-000		B40-0058-5-000m



BCT48-1125-5-594m

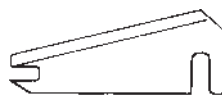

BD-2923
 BD-2923m
 B40-0127-0-001m



BD-2923Am

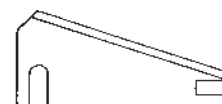

B21-3003m



B46-1125-5-000m



B46-1125-5-581m



B21-5602m



B15487m



B40-0057-6-000m



B40-0058-5-000m

Reece

CT = Hartmetall
 Carbide Tip

32		
	Originalnummer Genuine no.	Artikelnummer Item-no. PREMIUM QUALITY
Messer Knife	32-2019-1-000	B32-2019-1-000m
	32-2047-1-001	B32-2047-1-001m
	32-2047-1-002	B32-2047-1-002m
	32-2048-1-001	B32-2048-1-001m
	32-2048-1-002	B32-2048-1-002m



B32-2019-1-000m

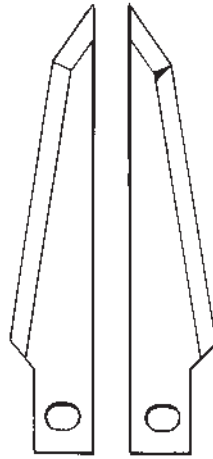

B32-2047-1-001m B32-2047-1-002m

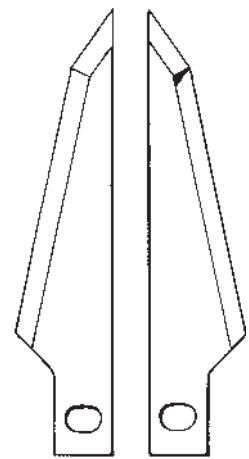

B32-2048-1-001m B32-2048-1-002m

42		
	Originalnummer Genuine no.	Artikelnummer Item-no. PREMIUM QUALITY
Messer Knife	40-0012-2-045	BD-2924m
	42-0012-0-000	BD-2922m



BD-2924m

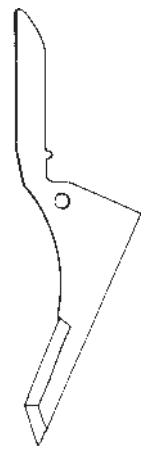

BD-2922m

Reece

CT = Hartmetall
Carbide Tip

101, 104, 11, XL-21				
		Originalnummer <i>Genuine no.</i>	Artikelnummer <i>Item-no.</i> STANDARD	Artikelnummer <i>Item-no.</i> PREMIUM QUALITY
Stichplatte <i>Needle Plate</i>		10-4012-0-020	B10-4012-0-020	
Messer <i>Knife</i>		14-1197-0-000		B14-1197-0-000m
Messer, vorschneidend <i>Knife, cut-before</i>	ohne Auge <i>no-eye</i>	10-3072-0-003 1-1/2"	B10-3072-0-003	
		10-3072-0-023 1-1/4"		B10-3072-0-023m
Messer, nachschnendend <i>Knife, cut-after</i>	normales Auge <i>regular eye</i>	10-3072-0-024 1-1/4"		B10-3072-0-024m
	Französisches Auge <i>French eye</i>	10-3072-0-035 1-1/2"	B10-3072-0-035	
Messer, nachschnendend mit Gimpen- abschneidung <i>Knife, after-cut with cord-trim</i>	normales Auge <i>regular eye</i>	10-3072-0-059 5/8"	B10-3072-0-059	B10-3072-0-059m
		10-3072-0-060 3/4"	B10-3072-0-060	B10-3072-0-060m
		10-3072-0-062 7/8"		B10-3072-0-062m
	großes Auge <i>large eye</i>	10-3072-0-067 5/8"		B10-3072-0-067m
Block <i>Cutting Block</i>	nachschnendend <i>cut-after</i>	10-1069-0-001 1/2"		B10-1069-0-001m
		10-1069-0-002 5/8"		B10-1069-0-002m
		10-1069-0-003 3/4"		B10-1069-0-003m
		10-1069-0-004 7/8"		B10-1069-0-004m
		10-1069-0-005 1"		B10-1069-0-005m
		10-1069-0-006 1-1/8"		B10-1069-0-006m
		10-1069-0-007 1-1/4"		B10-1069-0-007m
		10-1069-0-008 1-3/8"		B10-1069-0-008m
		10-1069-0-009 1-1/2"		B10-1069-0-009m
	nachschnendend mit Gimpen- abschneidung <i>cut-after, with cord- trim</i>	10-1069-0-020 5/8"		B10-1069-0-020m
		10-1069-0-021 3/4"		B10-1069-0-021m
		10-1069-0-022 7/8"		B10-1069-0-022m
	vorschneidend <i>cut-before</i>	10-1069-0-073 1/2"		B10-1069-0-073m
		10-1069-0-074 5/8"		B10-1069-0-074m
		10-1069-0-075 3/4"		B10-1069-0-075m
		10-1069-0-076 7/8"		B10-1069-0-076m
		10-1069-0-077 1"		B10-1069-0-077m

Reece

CT = Hartmetall
 Carbide Tip

101, 104, 11, XL-21				
		Originalnummer Genuine no.	Artikelnummer Item-no. STANDARD	Artikelnummer Item-no. PREMIUM QUALITY
Block Cutting Block	vorschneidend cut-before	10-1069-0-078 1-1/8"		B10-1069-0-078m
		10-1069-0-079 1-1/4"		B10-1069-0-079m
		10-1069-0-080 1-3/8"		B10-1069-0-080m
		10-1069-0-081 1-1/2"		B10-1069-0-081m
Fadenschere Thread Scissor		10-2206-1-000		B10-2206-1-000m
		10-2207-1-000		B10-2207-1-000m
		10-2207-1-600		B10-2207-1-600m
Kettenstichgreifer Looper		10-4004	BD-2936	
		10-4005	BD-2930	
		14-4004-0-000		BD-2937m
		14-4005-0-000		BD-2931m
Spreizer Spreader		10-4008	BD-2932	
		10-4009	BD-2933	
		14-4009-1-000		BD-2934m
		14-4008-1-000		BD-2932Am
Anschlag, rechts Stop, right		10-4006-0-000		B10-4006-0-000m
Anschlag, links Stop, left		10-4007-0-000		B10-4007-0-000m
Fadenanzugsfeder Take-up Spring (nur / only 101)		01-5027-0-000	BD-4061	
Feder Spring (nur / only 101)		01-5024-0-000	BD-4063	
		01-5025-0-000	BD-4064	
		01-5450-0-000	BD-4062	

Reece

CT = Hartmetall
 Carbide Tip

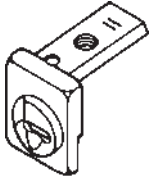

B10-4012-0-020



B14-1197-0-000m



- B10-3072-0-023m
- B10-3072-0-024m
- B10-3072-0-035
- B10-3072-0-059
- B10-3072-0-059m
- B10-3072-0-060
- B10-3072-0-060m
- B10-3072-0-062m
- B10-3072-0-067m

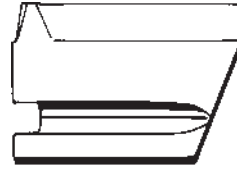

B10-1069-0-001m
 bis / up to
 B10-1069-0-009m

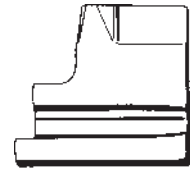

B10-1069-0-020m
 B10-1069-0-021m
 B10-1069-0-022m

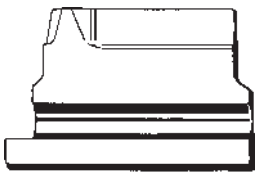

B10-1069-0-073m
 bis / up to
 B10-1069-0-081m



B10-2206-1-000m

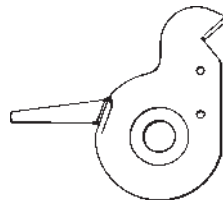

B10-2207-1-000m

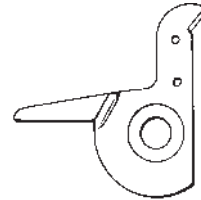

B10-2207-1-600m



BD-2936

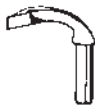

BD-2930



BD-2937m



BD-2931m

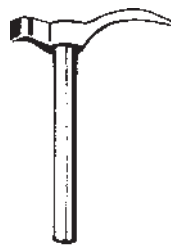

BD-2932

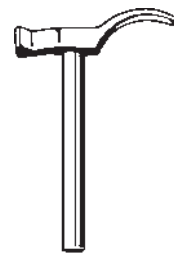

BD-2933

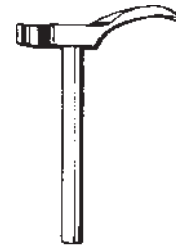

BD-2934m

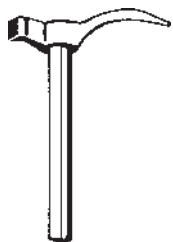

BD-2932Am



B10-4006-0-000m



B10-4007-0-000m



BD-4061



BD-4064



BD-4062

Reece

CT = Hartmetall
 Carbide Tip

S2, 200, 2000, 4000, 5000			
	Originalnummer <i>Genuine no.</i>	Artikelnummer <i>Item-no.</i> STANDARD	Artikelnummer <i>Item-no.</i> PREMIUM QUALITY
Knopflochmesser <i>Button Hole Knife</i>	23-2356 1/8	BD-2939A	
	23-2356 1/4	BD-2940	BD-2940m
	23-2356 5/16	BD-2941	
	23-2356 3/8	BD-2942	BD-2942m
	23-2356 7/16	BD-2943	BD-2943m
	23-2356 1/2	BD-2944	BD-2944m
	23-2356 9/16	BD-2945	BD-2945m
	23-2356 5/8	BD-2946	BD-2946m
	23-2356 11/16	BD-2947	
	23-2356 3/4	BD-2948	BD-2948m
	23-2356 13/16	BD-2949	
	23-2356 7/8	BD-2950	BD-2950m
	23-2356 15/16	BD-2951	
	23-2356 1	BD-2952	BD-2952m
	23-2356 1-1/16	BD-2953	
	23-2356 1-1/8	BD-2954	BD-2954m
	23-2356 1-1/4	BD-2956	BD-2956m
	23-2356 1-3/8	BD-2958	BD-2958m
	23-2356 1-1/2	BD-2959	BD-2959m
Stichplatte <i>Needle Plate</i>	20-0051-0-003		B20-0051-0-003m
	20-0051-1-002		BD-2928m
	20-0051-1-022 <i>Mitte/Center</i>		BD-2926m
	20-0051-1-023 <i>Links/Left</i>		BD-2927m
	20-0051-1-024 <i>Rechts/Right</i>		BD-2925m

Reece

CT = Hartmetall
 Carbide Tip

S2, 200, 2000, 4000, 5000			
	Originalnummer Genuine no.	Artikelnummer Item-no. STANDARD	Artikelnummer Item-no. PREMIUM QUALITY
Messer Knife	20-0094-0-000		B20-0094-0-000m
	20-0094-1-000		B20-0094-1-000m
	20-0356-0-003ED		B20-0356-0-003EDm
Kettenstichgreifer Looper	20-0116-3-000	BD-2929	BD-2929m
	20-0119-2-000	BD-2935	BD-2935m
Haken Hook	20-0093-0-004		B20-0093-0-000m
Fänger Catcher	20-0093-2-004		B20-0093-2-004m
Antriebsriemen Driving belt (nur / only S2)	05-0102-0-340	B05-0102-0-340	
	05-0102-1-340	B05-0102-1-340	



B20-0094-0-000m



B20-0094-1-000m

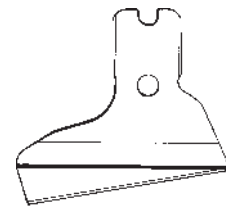

B20-0356-0-003EDm

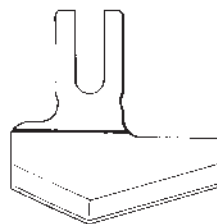
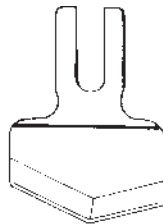
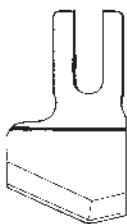
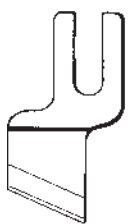

BD-2939A - BD-2959m



BD-2929
 BD-2929m



BD-2935
 BD-2935m



B20-0051-0-003m



BD-2928m



BD-2926m



BD-2927m



BD-2925m



B20-0093-2-004m

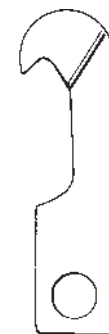

B20-0093-0-000m

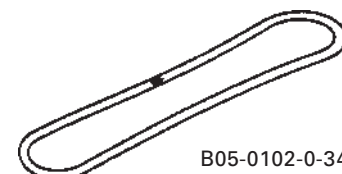

B05-0102-0-340
 B05-0102-1-340

Reece

CT = Hartmetall
 Carbide Tip

S100			
		Originalnummer Genuine no.	Artikelnummer Item-no. PREMIUM QUALITY
Messer Knife	vorschneidend <i>cut-before</i>	17-0064-5-950	B17-0064-5-950m
	nachschneidend <i>cut-after</i>	17-0064-5-864	B17-0064-5-864m
Kettenstichgreifer Looper		17-0004-9-894	B17-0004-9-894m
		17-0004-9-895	B17-0004-9-895m
		17-0069-4-048	B17-0069-4-048m
		17-0069-4-049	B17-0069-4-049m

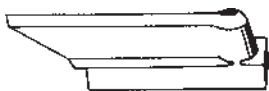

B17-0064-5-950m



B17-0064-5-864m

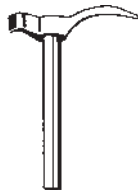

B17-0004-9-894m



B17-0004-9-895m



B17-0069-4-048m



B17-0069-4-049m

Rimoldi-Necci (Necci)

CT = Hartmetall
Carbide Tip

400-100 / 405-100 / 458-100			
	Originalnummer Genuine no.	Artikelnummer Item-no. STANDARD	Artikelnummer Item-no. PREMIUM QUALITY
Knopflochmesser Button Hole Knife	996448-0-00 1/4"	BD-2895	BD-2895m
	996449-0-00 3/8"	BD-2896	BD-2896m
	- 7/16"		BD-2897m
	996450-0-00 1/2"	BD-2898	BD-2898m
	- 9/16"	BD-2899	BD-2899m
	996451-0-00 5/8"	BD-2900	BD-2900m
	- 11/16"	BD-2901	BD-2901m
	996452-0-00 3/4"		BD-2902m
	- 20mm		BD-2903m
	996453-0-00 7/8"	BD-2904	BD-2904m
	996454-0-00 1"	BD-2905	BD-2905m
	996455-0-00 1-1/8"	BD-2906	BD-2906m
	996456-0-00 1-1/4"		BD-2907m
	- 1-5/16"		BD-2908m
	- 1-7/16"		BD-2909m
	996458-0-00 1-1/2"		BD-2910m
	- 1-9/16"	BD-2911	BD-2911m
Knopflochmesser Buttonhole Knife 90°	- 1/4"		B71-90-1/4m
	- 3/8"		B71-90-3/8m
	- 7/16"		B71-90-7/16m
	- 1/2"		B71-90-1/2m
	- 9/16"		B71-90-9/16m
	- 5/8"		B71-90-5/8m
	- 11/16"		B71-90-11/16m
	- 3/4"		B71-90-3/4m
	- 7/8"		B71-90-7/8m
	- 1"		B71-90-1m
	- 1-1/8"		B71-90-1-1/8m

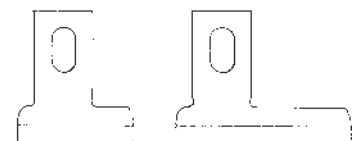
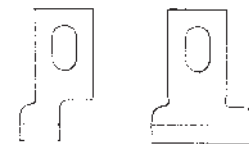
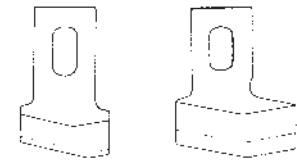
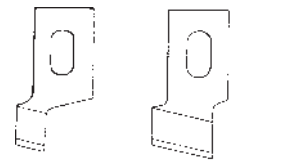

Rimoldi-Necci (Necci)

CT = Hartmetall
 Carbide Tip

400-100 / 405-100 / 458-100			
	Originalnummer Genuine no.	Artikelnummer Item-no. STANDARD	Artikelnummer Item-no. PREMIUM QUALITY
Knopflochmesser Buttonhole Knife 90°	- 1-1/4"		B71-90-1-1/4m
Messer Knife	154851-0-00		B154851000m
	154852-0-00		B154852000m

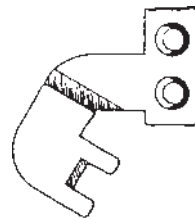

B154851000m

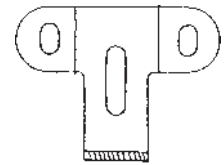

B154852000m

835-261, 263, UAN 2641, 2661		
	Originalnummer Genuine no.	Artikelnummer Item-no. PREMIUM QUALITY
Messer Knife	186185-0-07	B186185007m
	186188-2-02CT	B186188202m



B186185007m

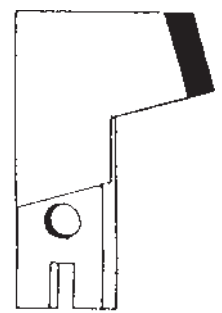

B186188202m

Rimoldi-Necci (Necci)

CT = Hartmetall
 Carbide Tip

UAN 1700, 1701			
	Originalnummer Genuine no.	Artikelnummer Item-no. STANDARD	Artikelnummer Item-no. PREMIUM QUALITY
Messer Knife	181812-0-00HSS		BD-2924m
	181814-0-03	BD-2923	BD-2923m



BD-2923
 BD-2923m

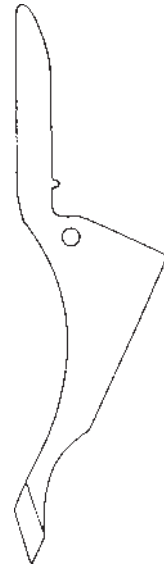

BD-2924m

Rimoldi-Necci (Rimoldi)

CT = Hartmetall
 Carbide Tip

27, 28, 29, 227, 228, 229, 327, 328, 329, 527, 529, 627, 629, 637, 639			
Orion, Omnitex, Vega			
	Originalnummer Genuine no.	Artikelnummer Item-no. STANDARD	Artikelnummer Item-no. PREMIUM QUALITY
Stichplatte Needle Plate	202148-0-10		BD-3006m
	202504-0-10		BD-3007m
	202507-0-10		B202507-0-10m
	202508-0-10		B202508-0-10m
	202590-0-10		B202590-0-10m
	203547-0-10		BD-3008m
	204026-0-10		BD-3009m
	204695-0-11		BD-3010m
	204809-0-00		B204809-0-00m
Messer Knife	202142-0-10	BD-2938	BD-2938m
	202143-0-10		BD-2938Am
	202145-0-10	BD-2961	BD-2961m
	202146-0-10	BD-2962	BD-2962m
	202932-0-10	BD-2965	BD-2965m
	203010-0-10	BD-2964	BD-2964m
	203012-0-10	BD-2966	BD-2966m
	203066-0-10	BD-2967	BD-2967m
	203068-0-10	BD-2968	BD-2968m
	203068-0-10CT		BCT203068-0-10m
	203144-0-10	BD-2963	BD-2963m
	203759-0-10		BD-2978m
	203783-0-10	BD-2979	BD-2979m
	204693-0-11	BD-2977	BD-2977m
	207000-2-00CT		BD-2938CTm
	207001-2-00CT		BCT207001-2-00m
	207002-2-00CT		BD-2964CTm
	207003-2-00CT		BD-2979CTm

Rimoldi-Necci (Rimoldi)

CT = Hartmetall
 Carbide Tip

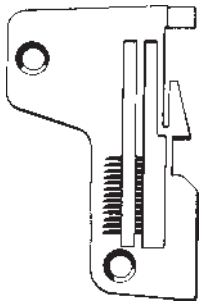

BD-3006m

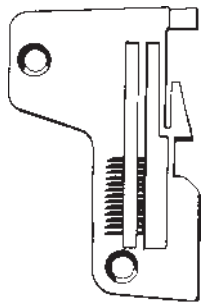

BD-3007m

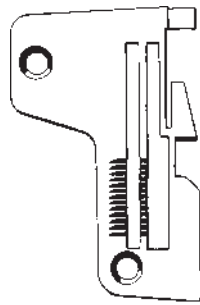

B202507-0-10m

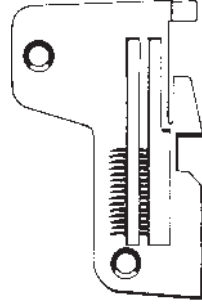

B202508-0-10m

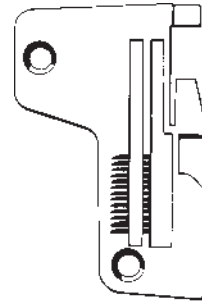

B202590-0-10m

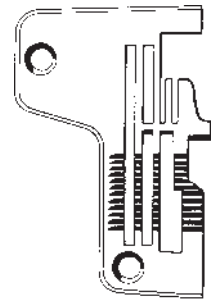

BD-3008m

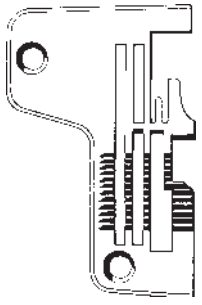

BD-3009m

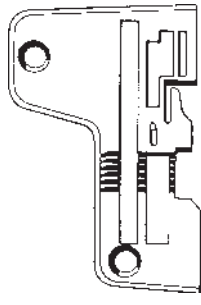

BD-3010m

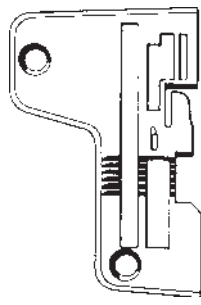

B204809-0-00m



BD-2938
 BD2938m

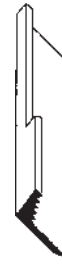

BD-2938Am



BD-2961
 BD-2961m



BD-2962
 BD-2962m



BD-2965
 BD-2965m



BD-2964
 BD-2964m



BD-2966
 BD-2966m



BD-2967
 BD-2967m



BD-2968
 BD-2968m



BCT203068-0-10m



BD-2963
 BD-2963m



BD-2978m



BD-2979
 BD-2979m



BD-2977
 BD-2977m



BD-2938CTm



BCT207001-2-00m

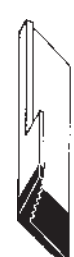

BD-2964m



BD-2979CTm

Rimoldi-Necci (Rimoldi)

CT = Hartmetall
 Carbide Tip

27, 28, 29, 227, 228, 229, 327, 328, 329, 527, 529, 627, 629, 637, 639			
Orion, Omnitex, Vega			
	Originalnummer <i>Genuine no.</i>	Artikelnummer <i>Item-no.</i> STANDARD	Artikelnummer <i>Item-no.</i> PREMIUM QUALITY
Messer <i>Knife</i>	207004-2-00CT		BCT207004-2-00m
	207006-2-00CT		BCT207006-2-00m
	207008-2-00CT		BCT207008-2-00m
	207011-0-00		B207011-0-00m
	207015-2-00CT		BCT207015-2-00m
	207016-2-00CT		BCT207016-2-00m
	207017-2-00CT		BCT207017-2-00m
	207020-2-01CT		BCT207020-2-01m
	207024-2-00CT		BCT207024-2-00m
	207651-0-00m		B207651-0-00m
	209593-0-00		B209593-0-00m
	920780-0-10		B920780-0-10m
	926754-2-01CT		BD-2980CTm
	926756-2-01CT		BD-2987CTm
	928530-2-00(CT)		B928530-2-00m
928531-2-00CT		B928531-2-00m	
Fadenschere <i>Thread Scissor</i>	926752-4-00		B926752-4-00m
	926753-2-01CT		BD-2986CTm
	926755-4-01		BD-2984m
	926757-4-01		BD-2985m
	928533-4-01CT		B928533-4-01m
Kettenstichgreifer <i>Looper</i>	202092-0-11		BD-3000m
	202094-0-13		BD-2988m
	202095-0-13		BD-2991m
	202413-0-13		BD-2992m
	203005-0-10		BD-3002m
	203755-0-10		BD-3003m

Rimoldi-Necci (Rimoldi)

CT = Hartmetall
 Carbide Tip



BCT207004-2-00m



BCT207006-2-00m



BCT207008-2-00m



B207011-0-00m



BCT207015-2-00m



BCT207016-2-00m



BCT207017-2-00m



BCT207020-2-01m



BCT207024-2-00m



B207651-0-00m



B209593-0-00m



B920780-0-10m



BD-2980CTm



BD-2987CTm

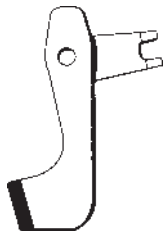

B928530-2-00m

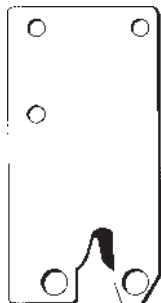

B928531-2-00m



B926752-4-00m



BD-2986CTm

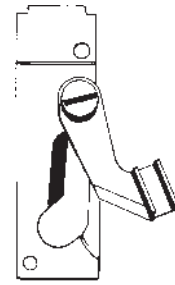

BD-2984m

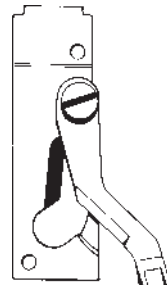

BD-2985m

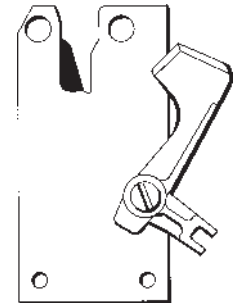

B928533-4-01m



BD-3000m



BD-2988m

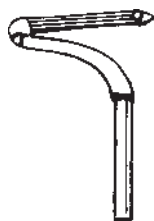

BD-2991m

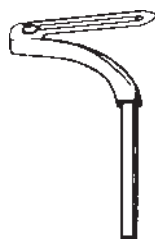

BD-2992m

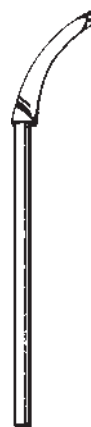

BD-3002m

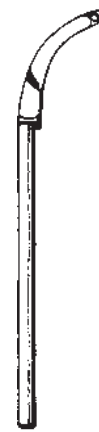

BD-3003m

Rimoldi-Necci (Rimoldi)

CT = Hartmetall
 Carbide Tip

27, 28, 29, 227, 228, 229, 327, 328, 329, 527, 529, 627, 629, 637, 639			
Orion, Omnitex, Vega			
	Originalnummer <i>Genuine no.</i>	Artikelnummer <i>Item-no.</i> STANDARD	Artikelnummer <i>Item-no.</i> PREMIUM QUALITY
Kettenstichgreifer <i>Looper</i>	204021-0-10		BD-2997m
	204022-0-10		BD-2999m
	204033-0-10		BD-2998m
	204676-0-11		BD-2994m
	206048-0-13		B206048-0-13m
	206208-0-00		BD-2989m
	206209-0-00		BD-2990m
	206512-0-02		BD-3001m
	207722-0-01		BD-2993m
	208011-0-01		B208011-0-01m
	209213-0-00		B209213-0-00m
	209223-0-00		B209223-0-00m
	209247-0-00		B209247-0-00m
	209248-0-00		B209248-0-00m
	209249-0-00		B209249-0-00m
	209264-0-00		B209264-0-00m
	209265-0-00		B209265-0-00m
	209266-0-00		B209266-0-00m
	209267-0-00		B209267-0-00m
Feder <i>Spring</i>	923918-0-01		BD-2983m
Buchse <i>Bushing</i>	923919-0-01		BD-2981m
Schraube <i>Screw</i>	745800-2-00	B745800-2-00	
	926758-0-01		BD-2982m

1.5

FABRIKATIONSSPEZIFISCHE NÄHWERKZEUGE UND ERSATZTEILE
BRAND DEPENDENT SEWING AND SPARE PARTS

Rimoldi-Necci (Rimoldi)

CT = Hartmetall
Carbide Tip



BD-2997m



BD-2999m



BD-2998m



BD-2994m

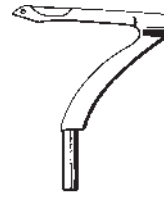

B206048-0-13m



BD-2989m



BD-2990m



BD-3001m

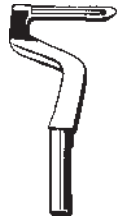

BD-2993m



B208011-0-01m

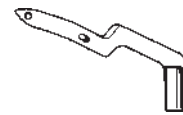

B209213-0-00m

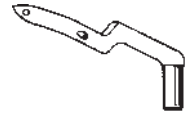

B209223-0-00m



B209247-0-00m



B209248-0-00m



B209249-0-00m

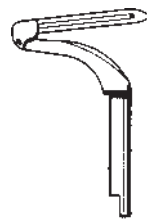

B209264-0-00m

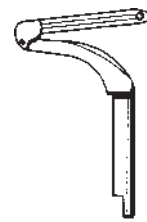

B209265-0-00m

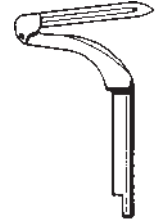

B209266-0-00m

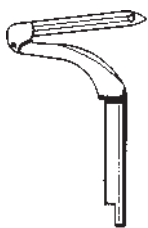

B209267-0-00m



BD-2983m



BD-2981m



B745800-2-00



BD-2982m

Rimoldi-Necci (Rimoldi)

CT = Hartmetall
 Carbide Tip

63, 64, 65, 73, 93, 94, 261, 262, 263, 264 Sirio		
	Originalnummer <i>Genuine no.</i>	Artikelnummer <i>Item-no.</i> PREMIUM QUALITY
Messer <i>Knife</i>	305671-2-00CT	BCT305671-2-00m
	302807-0-10	BD-3014m
	302808-0-10	BD-3015m
	303012-0-10	B303012-0-10m
	305670-0-00CT	BCT305670-2-00m
	306223-0-10	BD-3012m
	306224-0-10	BD-3013m
	306234-0-00	BD-3016m
	306235-0-00	BD-3017m
	306283-2-00CT	BCT306283-0-00m
	306284-2-00CT	BCT306284-2-00m
	306285-2-00CT	BCT306285-2-00m
	306286-2-00CT	BCT306286-2-00m
	315506-0-00	B315506-0-00m
	315506-2-00	B315506-2-00m
315507-0-00	B315507-0-00m	
Kettenstichgreifer <i>Looper</i>	302057-0-13	BD-3018m
	308080-0-00	B308080-0-00m
	312057-0-00	B312057-0-00m
	319093-0-00	B319093-0-00m

Rimoldi-Necchi (Rimoldi)

CT = Hartmetall
 Carbide Tip

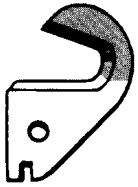

BCT305671-2-00m

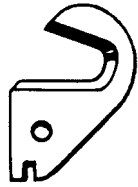

BD-3014m



BD-3015m
 BCT305670-2-00m

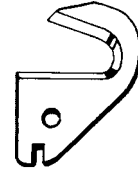

B303012-0-10m

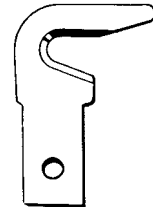

BD-3012m

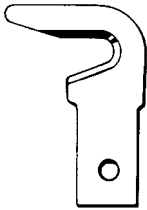

BD-3013m



BD-3016m



BD-3017m



BCT306283-0-00m



BCT306284-2-00m



BCT306285-2-00m

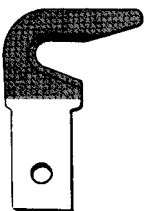

BCT306286-2-00m

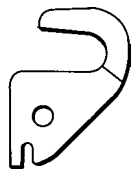

B315506-0-00m

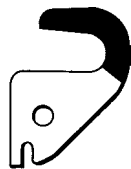

B315506-2-00m



B315507-0-00m

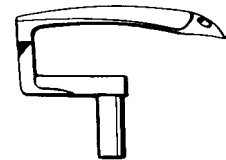

BD-3018m

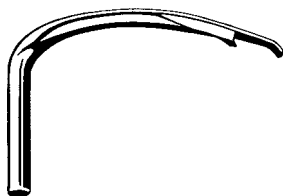

B308080-0-00m

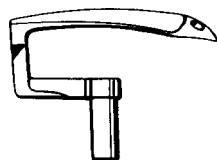

B312057-0-00m

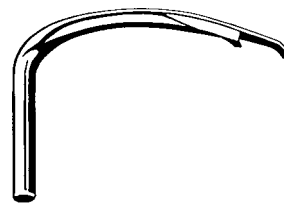

B319093-0-00m

Rimoldi-Necchi (Rimoldi)

CT = Hartmetall
 Carbide Tip

171, 177		
	Originalnummer Genuine no.	Artikelnummer Item-no. PREMIUM QUALITY
Messer Knife	924638-0-10	B924638-0-10m
	924670-0-20	B924670-0-20m
	944422-0-00	B944422-0-00m

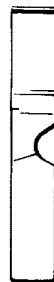

B944422-0-00m

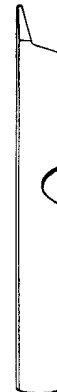

B924638-0-10m



B924670-0-20m

183-00-4MR 01-5,6mm		
	Originalnummer Genuine no.	Artikelnummer Item-no. PREMIUM QUALITY
Messer Knife	350069-0-00	BD-2995m
	350107-0-00	BD-2996m



BD-2995m



BD-2996m

Rimoldi-Necci (Rimoldi)

CT = Hartmetall
 Carbide Tip

183-00-4MR 04-6,0mm			
	Originalnummer <i>Genuine no.</i>	Artikelnummer <i>Item-no.</i> STANDARD	Artikelnummer <i>Item-no.</i> PREMIUM QUALITY
Messer <i>Knife</i>	350452-0-00	BD-3113	BD-3113m
	350453-0-00	BD-3112	BD-3112m
Kettenstichgreifer <i>Looper</i>	350145-0-10		B350145-0-10m



BD-3113
 BD-3113m



BD-3112
 BD-3112m

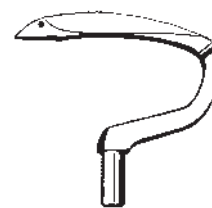

B350145-0-10m

184		
	Originalnummer <i>Genuine no.</i>	Artikelnummer <i>Item-no.</i> PREMIUM QUALITY
Kettenstichgreifer <i>Looper</i>	351161-0-10	B351161-0-10m
	351163-0-10	B351163-0-10m

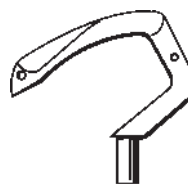

B351161-0-10m

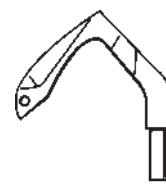

B351163-0-10m

264-22-4ML-01		
	Originalnummer <i>Genuine no.</i>	Artikelnummer <i>Item-no.</i> PREMIUM QUALITY
Kettenstichgreifer <i>Looper</i>	304186-0-13	B304186-0-13m

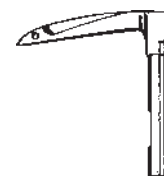

B304186-0-13m

Seiko

CT = Hartmetall
 Carbide Tip

LSW-8BL			
		Originalnummer Genuine no.	Artikelnummer Item-no. STANDARD
Nähgarnitur für Standardarbeiten Gauge Set for standard operations	Standardfuß Standard Foot	10661	B240149
		10663	B240148
	Stichplatte Needle Plate	10863	B240025
	Transporteur Feed Dog	10864	B240075
Kantenfuß Cording Foot			BD-4367
			BD-4368
Kederfußsatz Piping Foot Set x4,8 mm	Kederfüße Piping Feet	C301x3/16	BD-3445H/2
		C31x3/16	BD-3445H/1
Kederfußsatz Piping Foot Set x6,4 mm	Kederfüße Piping Feet	C301x1/4	BD-3445I/2
		C31x1/4	BD-3445I/1

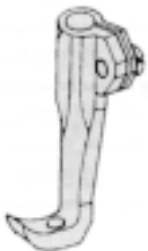

B240149



B240148



B240025

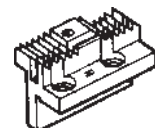

B240075

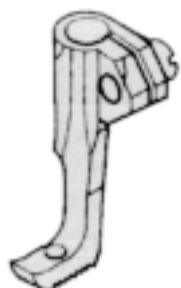

BD-4367



BD-4368

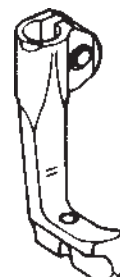

BD-3445H/2
 BD-3445I/2

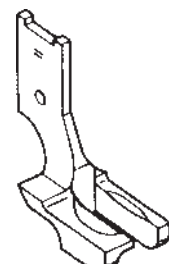

BD-3445H/1
 BD-3445I/1

1.5

Singer

CT = Hartmetall
 Carbide Tip

14U		
	Originalnummer Genuine no.	Artikelnummer Item-no. PREMIUM QUALITY
Messer Knife	410295	B410295m
	412585CT	B412585CTm
Kettenstichgreifer Looper	410262	B410262m
	410434	B410434m
	410452	B410452m
	412553	B412553m

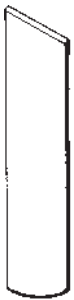

B410295m

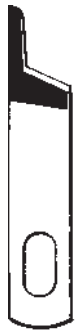

B412585CTm



B410262m



B410434m

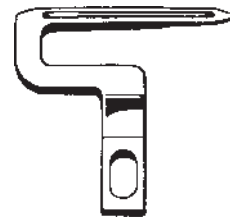

B410452m

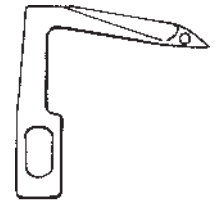

B412553m

20U			
		Originalnummer Genuine no.	Artikelnummer Item-no. STANDARD
Nähgarnitur Gauge Set	Stichplatte Needle Plate	541936	B541936
	Transporteur Feed Dog	541647	B541647
Fadenanzugsfeder Take-up Spring		32758	B32758

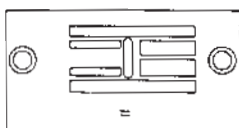

B541936

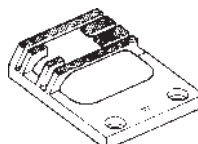

B541647

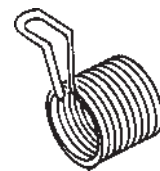

B32758

Singer

CT = Hartmetall
 Carbide Tip

47W, 51W, 52W, 52K 104W, 110W, 136W, 236G, 236U, 236W		
	Originalnummer Genuine no.	Artikelnummer Item-no. PREMIUM QUALITY
Messer Knife	233934	B233934m
	238508	B238508m
	238508HSS	B238508HSSm
	238543	B238543m
	238546	B238546m
	238548	B238548m
	241574HSS	B241574HSSm
	249191HSS	B249191HSSm
	249191x3,1	B249191-3.1m
	263735-3,1	B263735-3.1m
	8061A-3,1	BD-2629m



B233934m

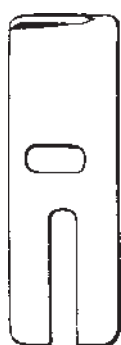

B238508m



B238508HSSm



B238543m

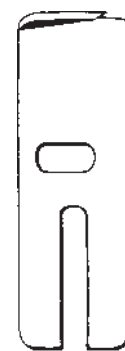

B238546m



B238548m



B241574HSSm



B249191HSSm



B249191-3.1m

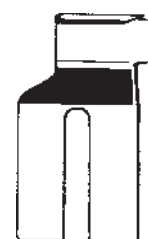

B263735-3.1m



BD-2629m

Singer

CT = Hartmetall
 Carbide Tip

68, 69, 269-W, 270		
	Originalnummer <i>Genuine no.</i>	Artikelnummer <i>Item-no.</i> PREMIUM QUALITY
Messer <i>Knife</i>	239367	BD-3025m
	239372	BD-3028m
	55458	BD-3027m
	55459	BD-3026m



BD-3025m



BD-3028m



BD-3027m

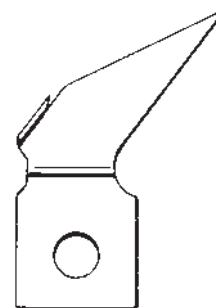

BD-3026m

71, 271		
	Originalnummer <i>Genuine no.</i>	Artikelnummer <i>Item-no.</i> STANDARD
Messer <i>Knife</i>	271926	BD-3024
	271941	B271941
	271942	B271942

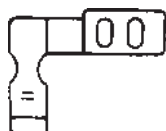

BD-3024



B271941



B271942

Singer

CT = Hartmetall
 Carbide Tip

71, 271, 371, 471			
	Originalnummer <i>Genuine no.</i>	Artikelnummer <i>Item-no.</i> STANDARD	Artikelnummer <i>Item-no.</i> PREMIUM QUALITY
Knopflochmesser <i>Button Hole Knife</i>	71-1/8		BD-2692m
	71-1/4		BD-2693m
	71-5/16		BD-2694m
	71-3/8		BD-2695m
	71-7/16		BD-2696m
	71-1/2	BD-2697	BD-2697m
	71-9/16	BD-2698	BD-2698m
	71-5/8	BD-2699	BD-2699m
	71-11/16	BD-2701	BD-2701m
	71-3/4	BD-2702	BD-2702m
	71-13/16		BD-2703m
	71-7/8	BD-2700	BD-2700m
	71-15/16	BD-2704	BD-2704m
	71-1	BD-2705	BD-2705m
	71-1-1/16		BD-2706m
	71-1-1/8	BD-2707	BD-2707m
	71-1-3/16		BD-2708m
	71-1-1/4	BD-2709	BD-2709m
	71-1-3/8	BD-2710	
	71-1-1/2	BD-2711	BD-2711m

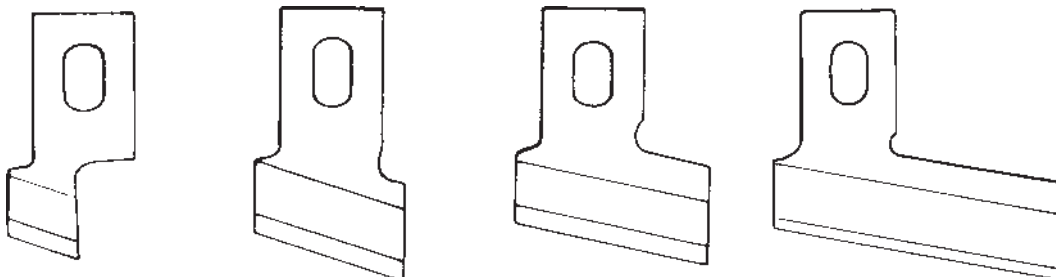

BD-2692m - BD-2711m

Singer

CT = Hartmetall
 Carbide Tip

71, 271, 371, 471			
	Originalnummer <i>Genuine no.</i>	Artikelnummer <i>Item-no.</i> STANDARD	Artikelnummer <i>Item-no.</i> PREMIUM QUALITY
Knopflochmesser <i>Buttonhole Knife</i> 90°	71-90-1/8		B71-90-1/8m
	71-90-1/4		B71-90-1/4m
	71-90-5/16		B71-90-5/16m
	71-90-3/8		B71-90-3/8m
	71-90-7/16		B71-90-7/16m
	71-90 1/2		B71-90-1/2m
	71-90-9/16		B71-90-9/16m
	71-90 5/8		B71-90-5/8m
	71-90-11/16		B71-90-11/16m
	71-90-3/4		B71-90-3/4m
	71-90-13/16		B71-90-13/16m
	71-90-7/8		B71-90-7/8m
	71-90-15/16		B71-90-15/16m
	71-90-1		B71-90-1m
	71-90-1-1/8		B71-90-1-1/8m
	71-90-1-1/4		B71-90-1-1/4m

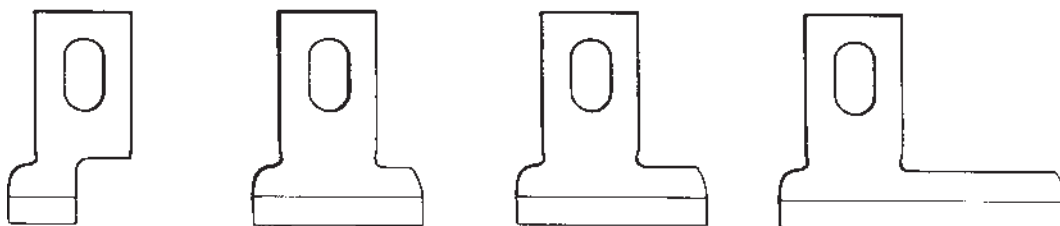

B71-90-1/8m - B71-90-1-1/4m

Singer

CT = Hartmetall
 Carbide Tip

71-30		
	Originalnummer Genuine no.	Artikelnummer Item-no. PREMIUM QUALITY
Stichplatte Needle Plate	39608	BD-3030m

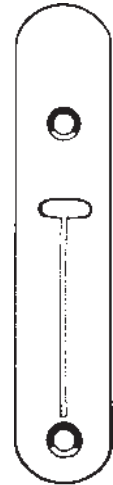

BD-3030m

71-48, -112			
	Originalnummer Genuine no.	Artikelnummer Item-no. STANDARD	Artikelnummer Item-no. PREMIUM QUALITY
Messer Knife	39867	BD-3022	BD-3022m



BD-3022
 BD-3022m

96, 451K-11, 245, 251		
	Originalnummer Genuine no.	Artikelnummer Item-no. PREMIUM QUALITY
Messer Knife	276489CT	BCT147211m
Schneidbrücke 3/32" Insert 3/32"	5730-3/32	B5730-3/32m
Schneidbrücke 1/8" Insert 1/8"	5730-1/8	B5730-1/8m
Schneidbrücke 3/16" Insert 3/16"	5730-3/16	B5730-3/16m



BCT147211m



B5730-1/8m
 B5730-3/16m
 B5730-3/32m

Singer

CT = Hartmetall
 Carbide Tip

81			
	Originalnummer <i>Genuine no.</i>	Artikelnummer <i>Item-no.</i> STANDARD	Artikelnummer <i>Item-no.</i> PREMIUM QUALITY
Messer <i>Knife</i>	42046	BD-3048	
	42111	BD-3046	
	42309		BD-3049m
	42305		BD-3050m
	42309CT		BD-3049CTm
	42305CT		BD-3050CTm
Kettenstichgreifer <i>Looper</i>	42072		BD-3056m
	42220		BD-3055m
	42239		BD-3054m



BD-3048



BD-3046



BD-3049m
 BD-3049CTm



BD-3050m
 BD-3050CTm



BD-3056m



BD-3055m

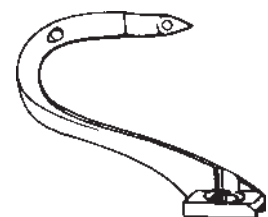

BD-3054m

Singer

CT = Hartmetall
 Carbide Tip

107G, 107W, 140W, 143W, 457G, 457W			
		Originalnummer Genuine no.	Artikelnummer Item-no. STANDARD
Standardfuß Standard Foot		210620	BDP-2H
Standard- Nähgarnitur Gauge Set, standard	Standardfuß Standard Foot	210568	B210568
	Stichplatte Needle Plate	210600	B210600
	Transporteur Feed Dog	210518	B210518
3-reihige Nähgarnitur Gauge Set, 3 rows	Standardfuß Standard Foot	210568	B210568
	Stichplatte Needle Plate	210603	B210603
	Transporteur Feed Dog	210523	B210523
Teflonfuß Teflon Foot		604107	B604-107
Antriebsgurt Kl. 107 Driving belt Cl. 107		210503	B210503
Antriebsgurt Kl. 457 Driving belt Cl. 457		502508	B502508

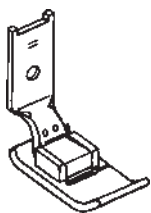

BDP-2H

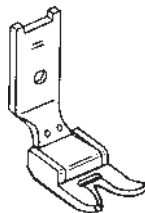

B210568

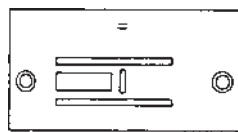

B210600

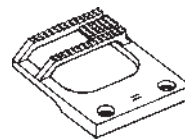

B210518

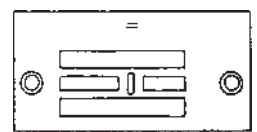

B210603

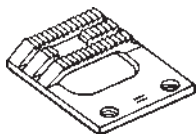

B210523



B604-107

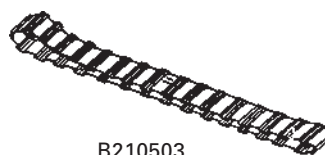

B210503



B502508

Singer

CT = Hartmetall
Carbide Tip

111G, 111W, 211G, 211W			
		Originalnummer Genuine no.	Artikelnummer Item-no. STANDARD
Nadeltransportausführung Needle feed version			
Standardfuß Standard Foot		229882	BD-3435A
Kantenfuß Cording Foot		S111ZL	BD-3436A
		S111ZR	BD-3437A
Kederfüße Piping Feet		S560x1/8"	BS560-1/8
		S560x3/16"	BS560-3/16
		S560x1/4"	BS560-1/4
		S560x3/8"	BS560-3/8
Teflonfuß Teflon Foot		MT5	BD-3439
Dreifachtransportausführung Unison feed version			
Nähgarnitur für Standardarbeiten Gauge Set for standard operations	Standardfuß Standard Foot	240148	B240148
		240149	B240149
	Stichplatte Needle Plate	240025	B240025
	Transporteur Feed Dog	240075	B240075
Kantenfußsatz Cording Foot Set	Kantenfuß, Zehe li. Cording Foot, toe left	240551	BD-4368
		240552	BD-4367
		240517	B240517
		240518	B240518
Kantenfußsatz Cording Foot Set	Kantenfuß, Zehe re. Cording Foot, toe right	240135	B240135
		240158	B240158
Kederfußsatz Piping Foot Set x4,8 mm	Kederfuß Piping Foot	240548x3/16	BD-3445H/1
		240549x3/16	BD-3445H/2
Kederfußsatz Piping Foot Set x6,4 mm	Kederfuß Piping Foot	240370x1/4	BD-3445I/1
		240371x1/4	BD-3445I/2
Fadenführung Thread Guide		240446	B240446

Singer

CT = Hartmetall
 Carbide Tip

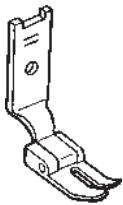

BD-3435A

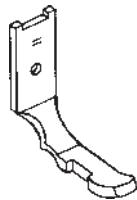

BD-3436A

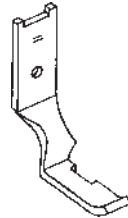

BD-3437A

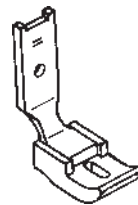

BS560-1/4
 BS560-1/8
 BS560-3/16
 BS560-3/8

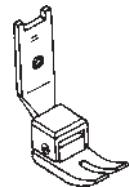

BD-3439



BD-4368

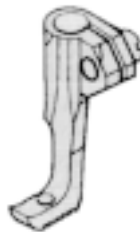

BD-4367



B240025

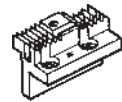

B240075



B240148

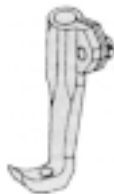

B240149



B240517

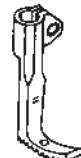

B240518



B240135

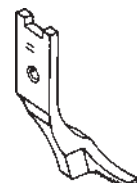

B240158

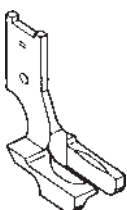

BD-3445H/1
 BD-3445I/1



BD-3445H/2
 BD-3445I/2

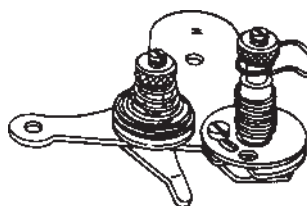

B240446

Singer

CT = Hartmetall
Carbide Tip

175, 375			
	Originalnummer <i>Genuine no.</i>	Artikelnummer <i>Item-no.</i> STANDARD	Artikelnummer <i>Item-no.</i> PREMIUM QUALITY
Flachknopfklammer <i>Straight Button Clamp</i>	175726	BD-5002A	
Ösenknopfklammer <i>Shank Button Clamp</i>	175684	BD-5001A	
Heftknopfklammer <i>Tacking Button Clamp</i>		BD-5003	
Knopfklammer- ersatzteile <i>Button Clamp</i> <i>Spare Parts</i> (für / for BD-5002A)	Knopfklammerträger <i>Button Clamp Arch</i>	175806	BD-5008A
	Klammerbacke, re. <i>Jaw, right</i>	175028	B175028
	Klammerbacke, li. <i>Jaw, left</i>	175022	B175022
	Klemmfeder, re. <i>Jaw Spring, right</i>	175030	B175030
	Klemmfeder, li. <i>Jaw Spring, left</i>	175026	B175026
Knopfklammer- ersatzteile <i>Button Clamp</i> <i>Spare Parts</i> (für / for BD-5001A)	Knopfklammerträger <i>Button Clamp Arch</i>	175797	BD-5007A
	Klammerkopf, kpl. <i>Button Holder Set,</i>	175890	B175890
	Klammerblech, unten <i>Lower Holder Clamp</i> <i>Blade</i>		B162-20
	Klammerblech, oben <i>Upper Holder Clamp</i> <i>Blade</i>		B162-21
	Klammerkopf, kpl. <i>Button Holder Set,</i>		B200-20
Knopfklammer- ersatzteile <i>Button Clamp</i> <i>Spare Parts</i> (für / for BD-5003)	Heftklammerfinger <i>Breaking Finger</i>	BD-5000	
Kettenstichgreifer <i>Looper</i>	175085		BD-3068m
	175547		BD-3069m

Singer

CT = Hartmetall
Carbide Tip

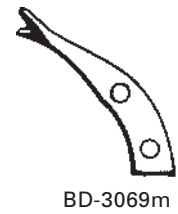
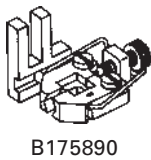
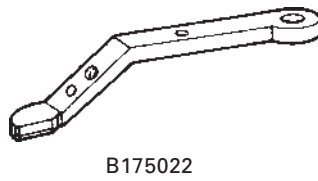
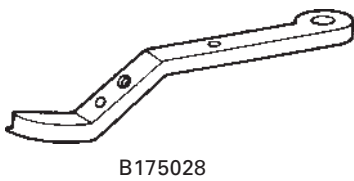
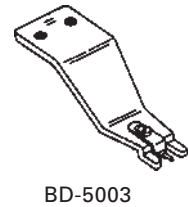
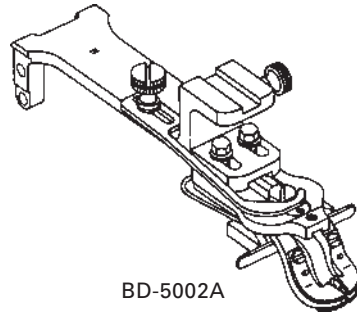
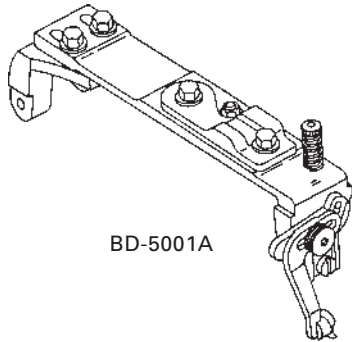

Singer

CT = Hartmetall
Carbide Tip

231, 261			
		Originalnummer Genuine no.	Artikelnummer Item-no. STANDARD
3-Nadel-Nähwerkzeuge für schwere Materialien <i>Triple Needle Gauge parts for heavy materials 1/8"+1/8"</i>	Nadelhalter <i>Needle Clamp</i>	128215-501	B128215-501
	Standardfuß <i>Standard Foot</i>	139405-501	B139405-501
	Stichplatte <i>Needle Plate</i>	139500-501	B139500-501
	Transporteur <i>Feed Dog</i>	139499-501	B139499-501
2-Nadel-Nähwerkzeuge für leichte bis mittlere Stoffe <i>Double Needle Gauge Set for light up to medium fabrics 3/16"</i>	Nadelhalter <i>Needle Clamp</i>	139116-3/16	B139116-3/16
	Standardfuß <i>Standard Foot</i>	139138-3/16	B139138-3/16
	Stichplatte <i>Needle Plate</i>	139540-3/16	B139540-3/16
	Transporteur <i>Feed Dog</i>	139541-3/16	B139541-3/16
2-Nadel-Nähwerkzeuge für leichte bis mittlere Stoffe <i>Double Needle Gauge Set for light up to medium fabrics 1/4"</i>	Nadelhalter <i>Needle Clamp</i>	139116-1/4	B139116-1/4
	Standardfuß <i>Standard Foot</i>	139138-1/4	B139138-1/4
	Stichplatte <i>Needle Plate</i>	139540-1/4	B139540-1/4
	Transporteur <i>Feed Dog</i>	139541-1/4	B139541-1/4
2-Nadel-Nähwerkzeuge für schwere Stoffe <i>Double Needle Gauge Set for heavy fabrics 1/4"</i>	Nadelhalter <i>Needle Clamp</i>	139116-1/4	B139116-1/4
	Standardfuß <i>Standard Foot</i>	139223-1/4	B139223-1/4
	Stichplatte <i>Needle Plate</i>	139385-1/4	B139385-1/4
	Transporteur <i>Feed Dog</i>	139414-1/4	B139414-1/4



B128215-501



B139405-501



B139500-501

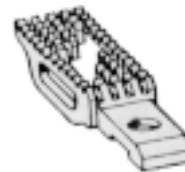

B139499-501



B139116-3/16
B139116-1/4

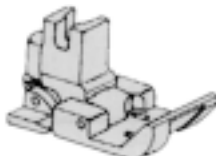

B139138-3/16
B139138-1/4



B139540-3/16
B139540-1/4



B139541-3/16
B139541-1/4

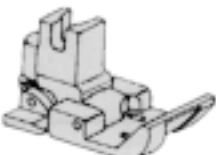

B139223-1/4



B139385-1/4



B139414-1/4

Singer

CT = Hartmetall
 Carbide Tip

231-33, -34		
	Originalnummer Genuine no.	Artikelnummer Item-no. STANDARD
Kettenstichgreifer Looper	139056	BD-3066
	139057	BD-3067
	139288	BD-3065

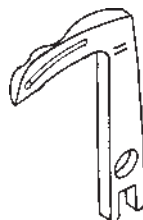

BD-3066



BD-3067

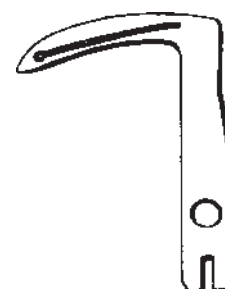

BD-3065

241, 245, 251, 281, 291U, 366K, 391U, 491D, 491U, 770		
	Originalnummer Genuine no.	Artikelnummer Item-no. STANDARD
Fadenanzugsfeder Take-up Spring	52394	BD-3419G
Feder Spring	147152	BD-3420D



BD-3419G



BD-3420D

Singer

CT = Hartmetall
Carbide Tip

246K, 460, 990			
	Originalnummer <i>Genuine no.</i>	Artikelnummer <i>Item-no.</i> STANDARD	Artikelnummer <i>Item-no.</i> PREMIUM QUALITY
Messer <i>Knife</i>	107797	BD-3064	BD-3064m
	164026	BD-3061	BD-3061m
	164026CT		BD-3061CTm
	164037	BD-3071	BD-3071m
	164308		BD-3059m
	164308CT		BD-3059CTm
	164550	BD-3060	BD-3060m
	164550CT		BD-3060CTm
	164556	BD-3062	BD-3062m
	164556CT		BD-3062CTm
	164728	BD-3070	BD-3070m
	164809CT		BD-3072CTm
	164813CT	BD-3073	BD-3073m
	82264	BD-3063	BD-3063m
	82264CT		BD-3063CTm
Kettenstichgreifer <i>Looper</i>	164045		BD-3074m
	164252		BD-3076m
	164375		BD-3077m
	164619		BD-3078m
Fadenanzugsfeder <i>Take-up Spring</i>	52394	BD-3419G	
Feder <i>Spring</i>	147152	BD-3420D	
Nähgarnitur für feste Nähte an leichten Stoffen <i>Gauge Set for strong seams at light fabrics</i>	Standardfuß <i>Standard Foot</i>	164150	B164150
	Stichplatte <i>Needle Plate</i>	164227	B164227
	Transporteur <i>Feed Dog</i>	164013	B164013
		164019	B164019

Singer

CT = Hartmetall
 Carbide Tip

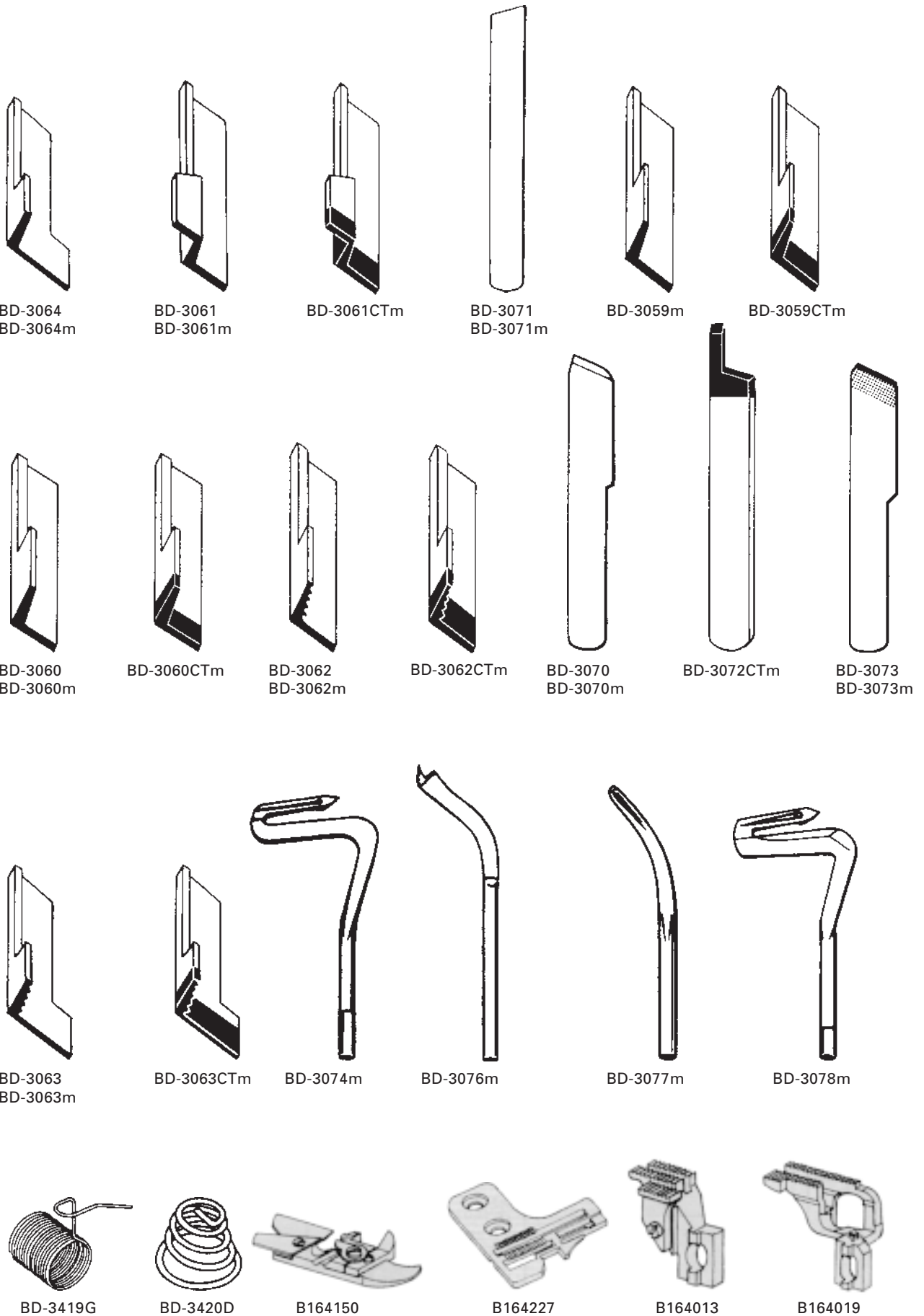

Singer

CT = Hartmetall
 Carbide Tip

246K, 460, 990				
		Originalnummer Genuine no.	Artikelnummer Item-no. STANDARD	Artikelnummer Item-no. PREMIUM QUALITY
Nähgarnitur zum Säumen von Bademode Gauge Set for hemming swimwear	Standardfuß Standard Foot	164627	B164627	
	Stichplatte Needle Plate	164632	B164632	
	Transporteur Feed Dog	164617	B164617	
		164618	B164618	



B164627



B164632



B164617



B164618

261-U		
	Originalnummer Genuine no.	Artikelnummer Item-no. PREMIUM QUALITY
Kettenstichgreifer Looper	32820	B32820m
	32821	B32821m
	32823	B32823m
	32824	B32824m

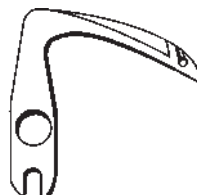

B32820m

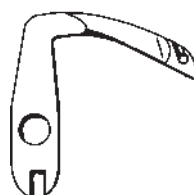

B32821m



B32823m

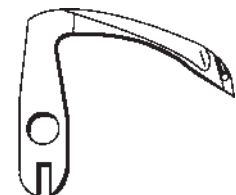

B32824m

281		
	Originalnummer Genuine no.	Artikelnummer Item-no. PREMIUM QUALITY
Messer Knife	785780001	BD-3092m



BD-3092m

Singer

CT = Hartmetall
 Carbide Tip

299U		
	Originalnummer Genuine no.	Artikelnummer Item-no. PREMIUM QUALITY
Kettenstichgreifer Looper	548205	B548205m
	548207	B548207m
	548231	B548231m
	548232	B548232m



B548205m



B548207m

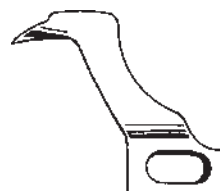

B548231m

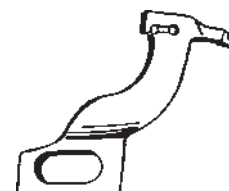

B548232m

300U, 300W, 302U			
	Originalnummer Genuine no.	Artikelnummer Item-no. STANDARD	Artikelnummer Item-no. PREMIUM QUALITY
Kettenstichgreifer Looper	268382	BD-3083	BD-3083m

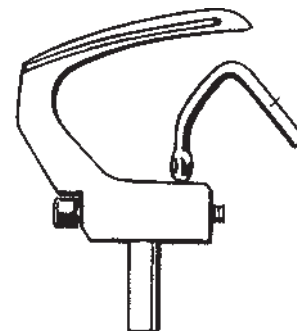

BD-3083
 BD-3083m

Singer

CT = Hartmetall
 Carbide Tip

300W			
		Originalnummer Genuine no.	Artikelnummer Item-no. STANDARD
4-Nadel- Umbaugarnitur 4-Needle Conversion Set 1/4x1x1/4"	Nadelhalter Needle Clamp	269193-506	B269193-506
	Ausgleichsfuß Compensating Foot	269240-509	B269240-509
	Stichplatte Needle Plate	269379-509	B269379-509
	Transporteur Feed Dog	269006-509	B269006-509
	Spreizer Spreader	269342-502	B269342-502
	Greiferhalter Looper Holder	269065-511	B269065-511
	Fadenführung Thread Guide		268373
		269138-512	B269138-512

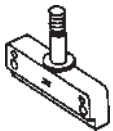

B269193-506

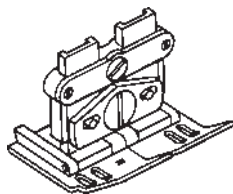

B269240-509

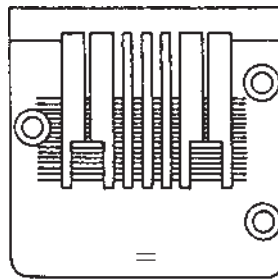

B269379-509

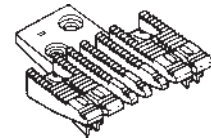

B269006-509

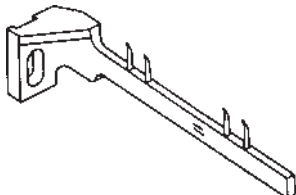

B269342-502

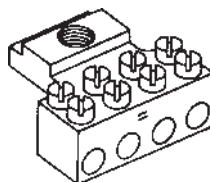

B269065-511



B268373



B269138-512

Singer

CT = Hartmetall
 Carbide Tip

369		
	Originalnummer Genuine no.	Artikelnummer Item-no. PREMIUM QUALITY
Messer Knife	239715	B239715m

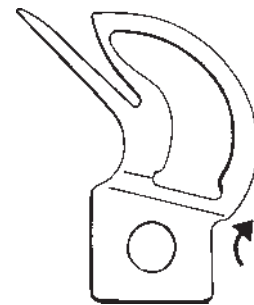

B239715m

375B		
	Originalnummer Genuine no.	Artikelnummer Item-no. PREMIUM QUALITY
Messer Knife	373537	B373537m
	373539	B373539m

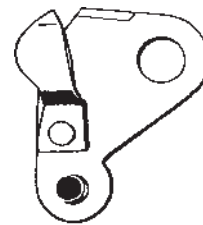

B373537m



B373539m

400W11		
	Originalnummer Genuine no.	Artikelnummer Item-no. PREMIUM QUALITY
Messer Knife	270616	BD-3094m
	270619	BD-3093m
	CT270616	BD-3090m
	CT270619	BD-3091m



BD-3094m



BD-3093m



BD-3090m



BD-3091m

460, 990B		
	Originalnummer Genuine no.	Artikelnummer Item-no. STANDARD
Kettenstichgreifer Looper	87025	BD-3080
	87026	B87026
	87027	BD-3079
	87028	B87028

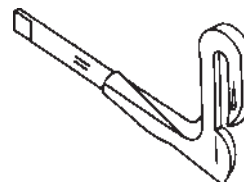

BD-3080

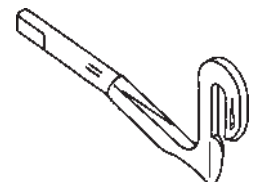

B87026

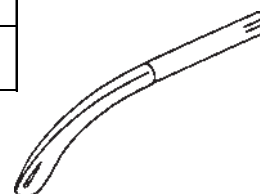

BD-3079

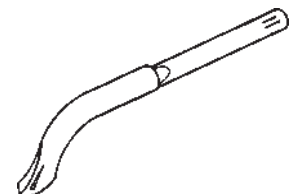

B87028

Singer

CT = Hartmetall
Carbide Tip

491D, 591D, 591E, 601D			
	Originalnummer <i>Genuine no.</i>	Artikelnummer <i>Item-no.</i> STANDARD	Artikelnummer <i>Item-no.</i> PREMIUM QUALITY
Messer <i>Knife</i>	414029		B414029m
	414030		B414030m
	540741		B540741m
	540760		B540760m
Fadenanzugsfeder <i>Take-up Spring</i> (nur / only 491)	32758	B32758	



B414029m

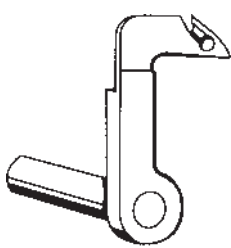

B414030m



B540741m



B540760m

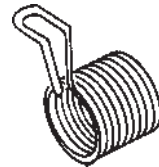

B32758

660AX2			
	Originalnummer <i>Genuine no.</i>	Artikelnummer <i>Item-no.</i> STANDARD	Artikelnummer <i>Item-no.</i> PREMIUM QUALITY
Stichplatte <i>Needle Plate</i>	GP11	BD-3421	
Transporteur <i>Feed Dog</i>	GP12	BD-3422	
Messer <i>Knife</i>	107519	BD-2713	BD-2713m
	GU3605		BD-3085m
	GU3606		BD-3084m



BD-3421

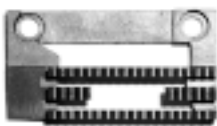

BD-3422

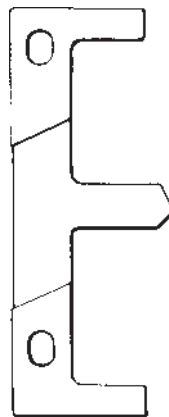

BD-2713
BD-2713m



BD-3085m

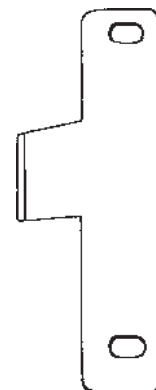

BD-3084m

Singer

CT = Hartmetall
 Carbide Tip

1831U, 1832U, 1842U			
	Originalnummer <i>Genuine no.</i>	Artikelnummer <i>Item-no.</i> STANDARD	Artikelnummer <i>Item-no.</i> PREMIUMQUALITY
Messer <i>Knife</i>	344559CT		BCT118-45906m
	377443	B118-46003	B118-46003m
	377465CT	BCT115-65900	BCT115-65900m
	377462CT	BCT118-45609	BCT118-45609m
	377559CT		BCT377559m
	377560	B115-66502	B115-66502m
Kettenstichgreifer <i>Looper</i>	377600		B377600m
	377601		B377601m
	377602		B377602m
	377638		B377638m
	377639		B377639m
	377640		B377640m
	377641		B377641m
	377691		B377691m
	377740		B377740m
	UL605294		BUL605294m

1.5

Singer

CT = Hartmetall
Carbide Tip



BCT118-45906m



B118-46003
B118-46003m



BCT115-65900
BCT115-65900m



BCT118-45609
BCT118-45609m



BCT377559m

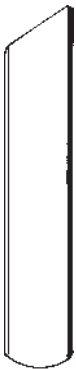

B115-66502
B115-66502m

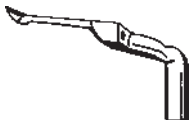

B377600m

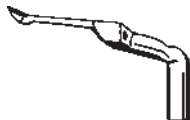

B377601m

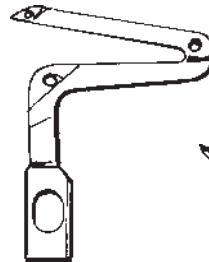

B377602m

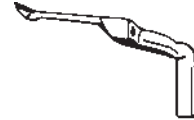

B377638m



B377639m

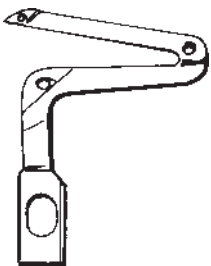

B377640m

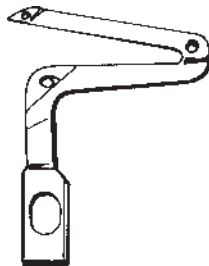

B377641m



B377691m

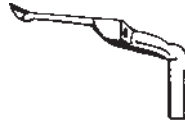

B377740m

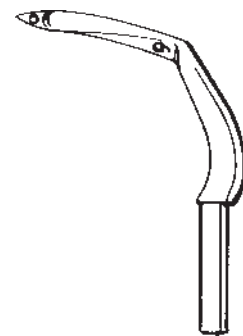

BUL605294m

Siruba

CT = Hartmetall
 Carbide Tip

727, 737, 747, 757			
	Originalnummer <i>Genuine no.</i>	Artikelnummer <i>Item-no.</i> STANDARD	Artikelnummer <i>Item-no.</i> PREMIUM QUALITY
Messer <i>Knife</i>	KR-23A		BKR-23Am
	KR-23C		BKR-23Cm
	KR23	BD-2783CT	BD-2783CTm
	KR35	BD-2785	BD-2785m
	KR35C		BKR-35Cm
Keramikmesser <i>Ceramic Knife</i>	KR35BAK	BD-5520	
Kettenstichgreifer <i>Looper</i>	KL25		BKL25m
	KL25A		BKL25Am
	KM04		BKM04m
	KM04A		BKM04Am
	LP21		BLP21m
	LP22		BLP22m
	LP24		BLP24m
	LP26		BLP26m
	LP36A		BLP36Am
	LP38	BLP38	

Siruba

CT = Hartmetall
 Carbide Tip



BKR-23Am



BKR-23Cm



BD-2783CT
 BD-2783CTm



BD-2785
 BD-2785m



BKR-35Cm



BD-5520

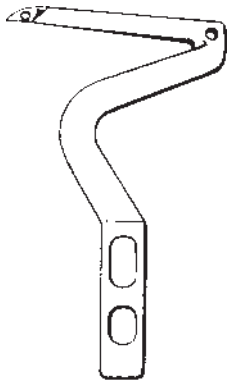

BKL25m

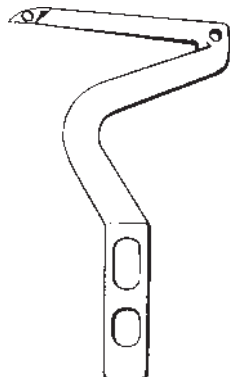

BKL25Am

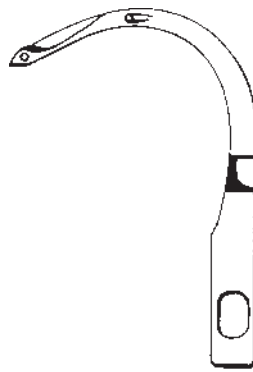

BKM04m

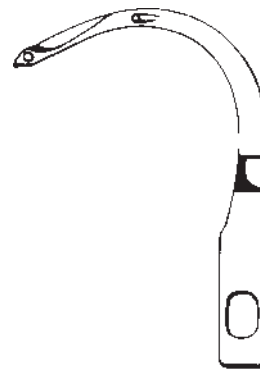

BKM04Am

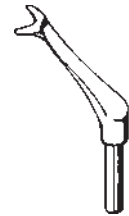

BLP21m



BLP22m



BLP24m



BLP26m



BLP36Am



BLP38

Strobel

CT = Hartmetall
 Carbide Tip

141-23, -28, 410, 415		
	Originalnummer <i>Genuine no.</i>	Artikelnummer <i>Item-no.</i> PREMIUM QUALITY
Kettenstichgreifer <i>Looper</i>	187047	B1870047m



B1870047m

141-21, -24, -27, -30, -40, -50		
	Originalnummer <i>Genuine no.</i>	Artikelnummer <i>Item-no.</i> PREMIUM QUALITY
Kettenstichgreifer <i>Looper</i>	187004	B1870004m



B1870004m

560-10D		
	Originalnummer <i>Genuine no.</i>	Artikelnummer <i>Item-no.</i> PREMIUM QUALITY
Kettenstichgreifer <i>Looper</i>	187052	B1870052m



B1870052m

BLINDSTICH		
	Originalnummer <i>Genuine no.</i>	Artikelnummer <i>Item-no.</i> PREMIUM QUALITY
Blindstichgreifer <i>Blindstitch Looper</i>	187053	B187053m
	VLA48-4	BD-3255m



B187053m



BD-3255m

Treasure

BS 800		
	Originalnummer <i>Genuine no.</i>	Artikelnummer <i>Item-no.</i> PREMIUM QUALITY
Blindstichgreifer <i>Blindstitch Loper</i>	11837(T830)	BD-2775m

CT = Hartmetall
 Carbide Tip



BD-2775m

Union

660			
	Originalnummer <i>Genuine no.</i>	Artikelnummer <i>Item-no.</i> STANDARD	Artikelnummer <i>Item-no.</i> PREMIUM QUALITY
Messer <i>Knife</i>	39549	BD-3132	BD-3132m
	G39549N		BD-3136CTm
Keramikmesser <i>Ceramic Knife</i>	39549BAK	BD-5517	



BD-3132
 BD-3132m



BD-3136CTm



BD-5517

Blindstich			
	Originalnummer <i>Genuine no.</i>	Artikelnummer <i>Item-no.</i> STANDARD	Artikelnummer <i>Item-no.</i> PREMIUM QUALITY
Blindstichgreifer <i>Blindstitch Loper</i>	36C22-1	BD-3257	BD-3257m



BD-3257
 BD-3257m

Union Special

CT = Hartmetall
 Carbide Tip

2000		
	Originalnummer Genuine no.	Artikelnummer Item-no. PREMIUM QUALITY
Kettenstichgreifer Looper	2008K (=UX)	BD-3097m
	2008Q (=UXA)	BD-3097Am



BD-3097m



BD-3097Am

2100, 2200		
	Originalnummer Genuine no.	Artikelnummer Item-no. PREMIUM QUALITY
Transporteur Feed Dog	2105	BD-3102m
	2126	BD-3100m
Messer Knife	2149 (=AB)	B2149-AB-m
	2170 (=AA)	B2170-AA-m
Kettenstichgreifer Looper	2108A	BD-3099m
Fadenzieher Loop Retainer	2111	B2111m

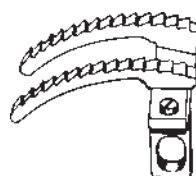

BD-3102m

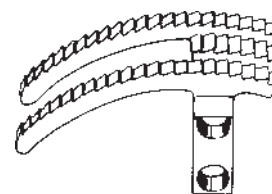

BD-3100m



B2149-AB-m



B2170-AA-m



BD-3099m



B2111m

Union Special

CT = Hartmetall
 Carbide Tip

15400		
	Originalnummer <i>Genuine no.</i>	Artikelnummer <i>Item-no.</i> PREMIUM QUALITY
Messer <i>Knife</i>	15449	B15449m
	15470	B15470m
Kettenstichgreifer <i>Looper</i>	15408A	B15408Am
	15408G	B15408Gm
	15460	B15460m



B15449m



B15470m



B15408Am



B15408Gm



B15460m

33700		
	Originalnummer <i>Genuine no.</i>	Artikelnummer <i>Item-no.</i> PREMIUM QUALITY
Kettenstichgreifer <i>Looper</i>	33709C	BD-3104m

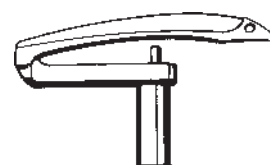

BD-3104m

Union Special

CT = Hartmetall
 Carbide Tip

34700, 34800, 92800, 93800, 94800		
	Originalnummer Genuine no.	Artikelnummer Item-no. PREMIUM QUALITY
Messer Knife	34749	BD-3105m
	34749K	BD-3106m
	34770	BD-3103m
	34770K	BD-3108m
Kettenstichgreifer Looper	34709 (=UR)	BD-3107m
	34709D (=URD)	B34709Dm



BD-3105m

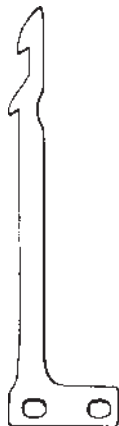

BD-3106m



BD-3103m



BD-3108m



BD-3107m



B34709Dm

35600, 35700, 35800			
	Originalnummer Genuine no.	Artikelnummer Item-no. STANDARD	Artikelnummer Item-no. PREMIUM QUALITY
Kettenstichgreifer Looper	35808AY (=AU)	BD-3110	BD-3110m
	35809AY (=AV)	BD-3109	BD-3109m
	35809BY (=AY)	BD-3111	BD-3111m



BD-3110
 BD-3110m

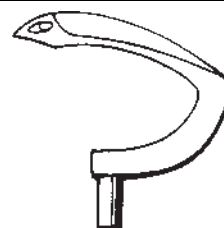

BD-3109
 BD-3109m

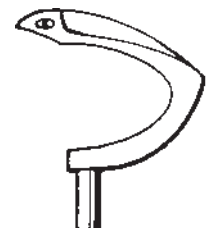

BD-3111
 BD-3111m

Union Special

CT = Hartmetall
Carbide Tip

36200 Flatseamer			
	Originalnummer <i>Genuine no.</i>	Artikelnummer <i>Item-no.</i> STANDARD	Artikelnummer <i>Item-no.</i> PREMIUM QUALITY
Messer <i>Knife</i>	36250 HSS	BD-3113	BD-3113m
	36250CT		BD-3113CTm
	36270 CT		BD-3112CTm
	36270 HSS	BD-3112	BD-3112m
Kettenstichgreifer <i>Looper</i>	36208A	BD-3114	BD-3114m
Spreizer <i>Spreader</i>	36251E (=A)		BD-3118m
	36251F		BD-3116m
Zunge <i>Tongue</i>	36240 (=D)		BD-3115Am
	36240 (=VD)		BD-3115m



BD-3113
BD-3113m



BD-3113CTm



BD-3112CTm



BD-3112
BD-3112m

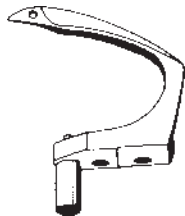

BD-3114
BD-3114m



BD-3118m



BD-3116m



BD-3115m
BD-3115Am

39200, 39600			
	Originalnummer <i>Genuine no.</i>	Artikelnummer <i>Item-no.</i> STANDARD	Artikelnummer <i>Item-no.</i> PREMIUM QUALITY
Messer <i>Knife</i>	39270E	BD-3119	BD-3119m



BD-3119
BD-3119m

Union Special

CT = Hartmetall
 Carbide Tip

39200			
	Originalnummer Genuine no.	Artikelnummer Item-no. STANDARD	Artikelnummer Item-no. PREMIUM QUALITY
Stichplatte Needle Plate	39224AA		B39224AAm
	39224AC-1/8		B39224AC-1/8m
	39224AC-3/32		B39224AC-3/32m
	39224J		B39224Jm
Messer Knife	39249	BD-3123	BD-3123m
	39249A	BD-3121	BD-3121m
	39249K	BD-3124	BD-3124m
	39270		BD-3117Am
	39270A		BD-3117Bm
	39270D	BD-3117	BD-3117m
Kettenstichgreifer Looper	39160		B39160m
	39208AA		B39208AAm
	39208B		B39208Bm

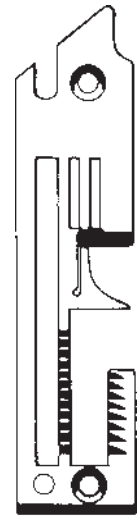

B39224AAm
 B39224AC-1/8m
 B39224AC-3/32m
 B39224Jm

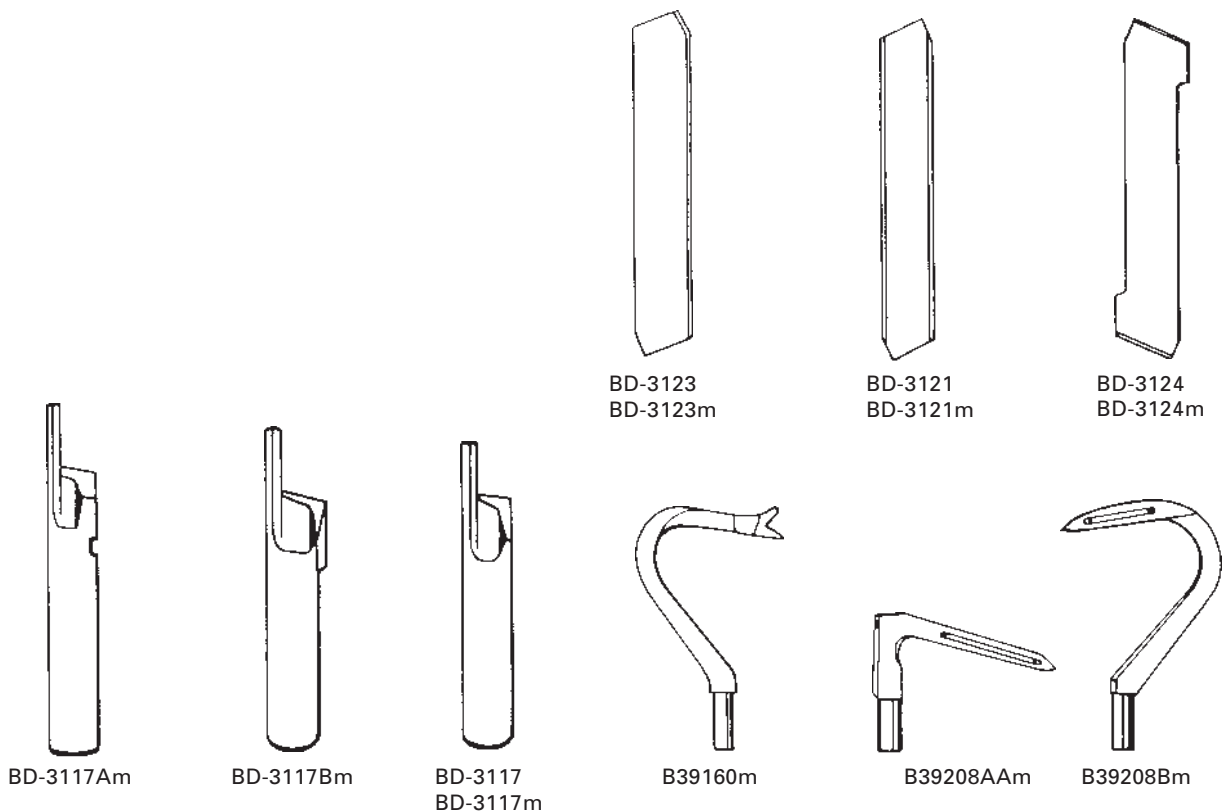

Union Special

CT = Hartmetall
Carbide Tip

39500			
	Originalnummer <i>Genuine no.</i>	Artikelnummer <i>Item-no.</i> STANDARD	Artikelnummer <i>Item-no.</i> PREMIUM QUALITY
Stichplatte Needle Plate	39524W (=AN)		BD-3152m
	39524AB1/8 (=AX1/8)		BD-3154Gm
	39524AB1/8 (=AX1/8)		BD-3154m
	39524AB5/32 (=AX5/32)		BD-3155m
	39524AS (=BE)		BD-3167Bm
	39524B1/8 (=V1/8)		BD-3157m
	39524B3/32 (=V3/32)		BD-3153m
	39524B5/32 (=BH)		BD-3158m
	39524BF1/8 (=BK)		BD-3166m
	39524C1/8 (=AC1/8)		BD-3160m
	39524D (=AM)		BD-3167Am
	39524J 3/16		BD-3165m
	39524N (=AH)		BD-3167Cm
	39524P (=AJ)		B39524Pm
	A9608B (=HG)		BD-3168m
	A9953-1/8 (=HV1/8)		BD-3161m
	G39524AV (=GB)		BD-3149m
	G39524AW (=GC)		BD-3150m
	G39524JU (=GI)		BD-3169m
	GA39524AW (=HH) 5/32		BD-3151m
	GA39524C1/8 (=HB)		BD-3163m
	GA39524C3/32 (=HA)		BD-3162m
	GA39524C-5/32 (=HC)		BD-3164m
GA39524JU (=HE)		BD-3170m	

Union Special

CT = Hartmetall
 Carbide Tip

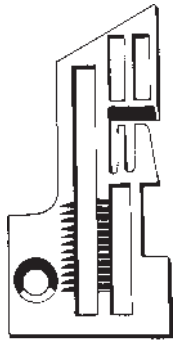

BD-3152m



BD-3154Gm

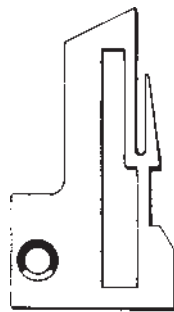

BD-3154m



BD-3155m

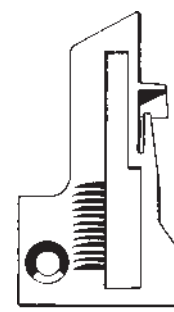

BD-3167Bm

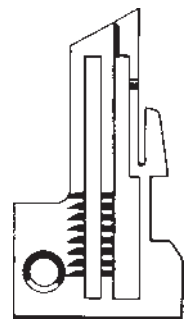

BD-3157m

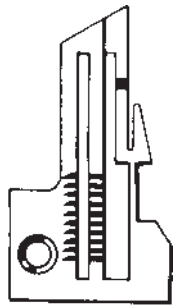

BD-3153m

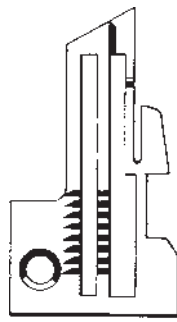

BD-3158m

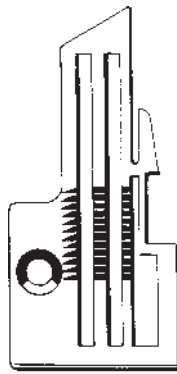

BD-3166m

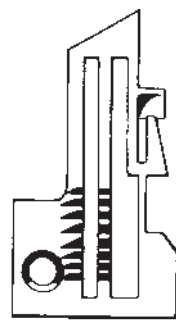

BD-3160m

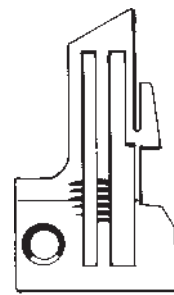

BD-3167Am

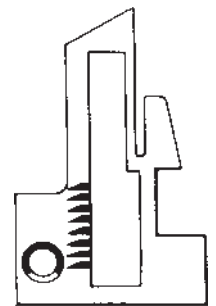

BD-3165m

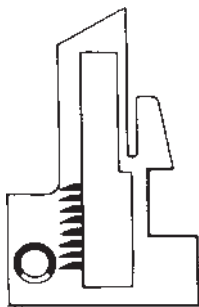

BD-3167Cm

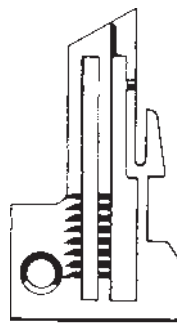

B39524Pm



BD-3168m

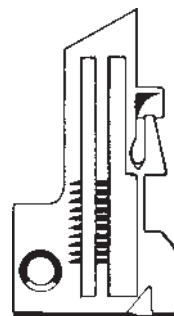

BD-3161m



BD-3149m

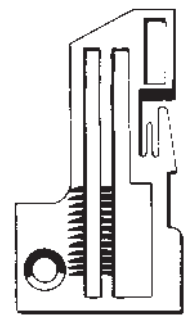

BD-3150m

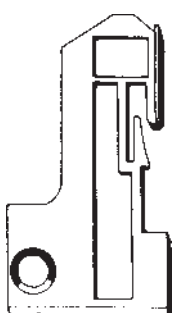

BD-3169m

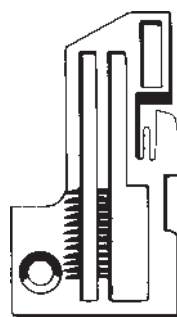

BD-3151m

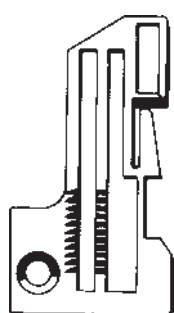

BD-3163m

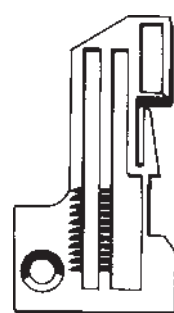

BD-3162m

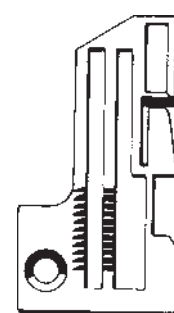

BD-3164m

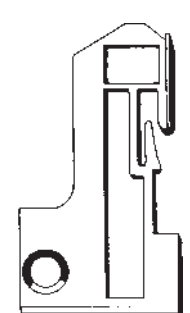

BD-3170m

Union Special

CT = Hartmetall
Carbide Tip

39500			
	Originalnummer <i>Genuine no.</i>	Artikelnummer <i>Item-no.</i> STANDARD	Artikelnummer <i>Item-no.</i> PREMIUM QUALITY
Transporteur <i>Feed Dog</i>	39505	B39505	
	39505B		BD-3171Cm
	39505C	B39505C	
	39526AW		BD-3171Am
	39526B		BD-3171Dm
Messer <i>Knife</i>	39549	BD-3132	BD-3132m
	39549J	BD-3133	BD-3133m
	39549JCT		BD-3133CTm
	39549SC		B39549SCm
	39556K		B39556Km
	39556L		B39556Lm
	39570J	BD-3129	BD-3129m
	39570JCT		BD-3129CTm
	39570K	BD-3128	BD-3128m
	39570L		BD-3127m
	39570LCT		BD-3127CTm
	39570SC		B39570SCm
	99669 (=GC)		BD-3143m
	99669K (=GM)		BD-3144m
	99670 (=GD)		BD-3137m
	99670L		BD-3138m
	A9392CT	BD-3130CT	BD-3130CTm
	G39549JU		BD-3134m
	G39549N		BD-3136CTm
	G39549SUCT		BD-3135CTm
	G39570	BD-3125	BD-3125m
	G39570A		BD-3126m
	G39570CT		BD-3125CTm
G39570JU		BD-3131m	



B39505

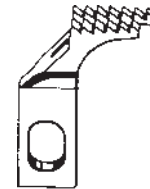

BD-3171Cm



B39505C

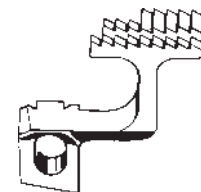

BD-3171Am

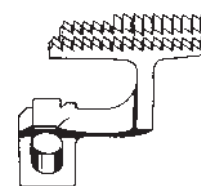

BD-3171Dm

Union Special

CT = Hartmetall
 Carbide Tip

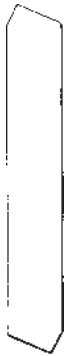

BD-3132
 BD-3132m

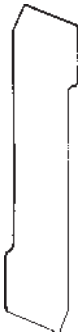

BD-3133
 BD-3133m

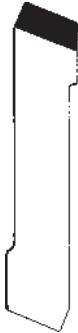

BD-3133CTm

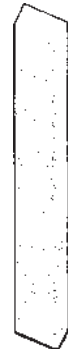

B39549SCm



B39556Km



B39556Lm

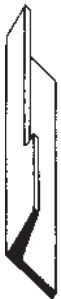

BD-3129
 BD-3129m



BD-3129CTm



BD-3128
 BD-3128m

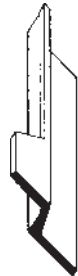

BD-3127m



BD-3127CTm



B39570SCm



BD-3143m

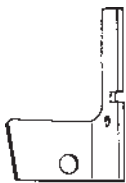

BD-3144m

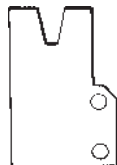

BD-3137m



BD-3138m

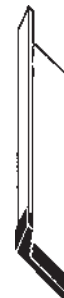

BD-3130CT
 BD-3130CTm



BD-3134m



BD-3136CTm



BD-3135CTm



BD-3125
 BD-3125m



BD-3126m



BD-3125CTm



BD-3131m

Union Special

CT = Hartmetall
Carbide Tip

39500			
	Originalnummer <i>Genuine no.</i>	Artikelnummer <i>Item-no.</i> STANDARD	Artikelnummer <i>Item-no.</i> PREMIUM QUALITY
Keramikmesser <i>Ceramic Knife</i>	39549BAK	BD-5517	
	39549JBAK	BD-5518	
Kettenstichgreifer <i>Looper</i>	39508B	BD-3139	BD-3139m
	39508C		B39508Cm
	39508D	BD-3140	BD-3140m
	39508E (=CK)	BD-3147	BD-3147m
	39508P		BD-3140Am
	39560A (=E)	BD-3142	BD-3142m
	39560B	BD-3145	BD-3145m
	G39508A (=UM)	BD-3146	BD-3146m
	G39508AV (=GC)	BD-3141	BD-3141m

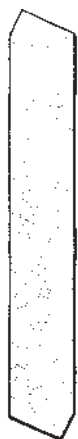

BD-5517

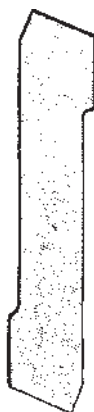

BD-5518

BD-3139
BD-3139m

B39508Cm

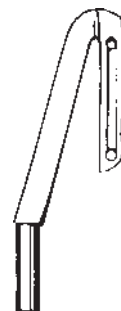
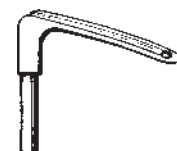
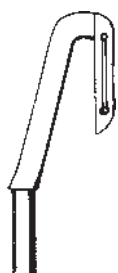
BD-3140
BD-3140mBD-3147
BD-3147m

BD-3140Am

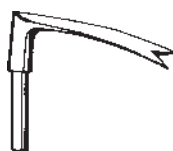
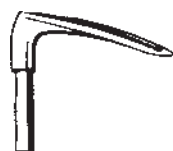
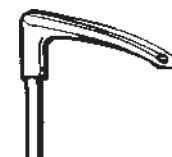
BD-3142
BD-3142mBD-3145
BD-3145mBD-3146
BD-3146mBD-3141
BD-3141m

Union Special

CT = Hartmetall
 Carbide Tip

39800			
	Originalnummer <i>Genuine no.</i>	Artikelnummer <i>Item-no.</i> STANDARD	Artikelnummer <i>Item-no.</i> PREMIUM QUALITY
Messer <i>Knife</i>	39849	BD-3172	BD-3172m
	39849CT		BD-3172CTm
	39870	BD-3173	BD-3173m
Kettenstichgreifer <i>Looper</i>	39808CY		BD-3175m
	39808D (=ACZ)		BD-3176m
	39860H	BD-3174	BD-3174m

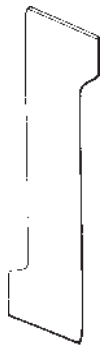

BD-3172
BD-3172m

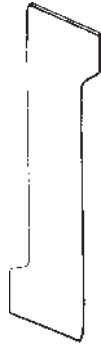

BD-3172CTm



BD-3173
BD-3173m

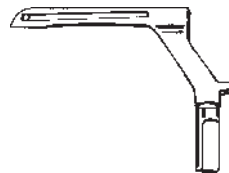

BD-3175m

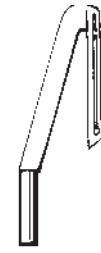

BD-3176m

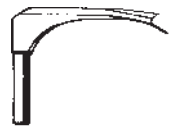

BD-3174
BD-3174m

41300		
	Originalnummer <i>Genuine no.</i>	Artikelnummer <i>Item-no.</i> PREMIUM QUALITY
Kettenstichgreifer <i>Looper</i>	41308B	B41308Bm
	41308BX	B41309Am



B41308Bm

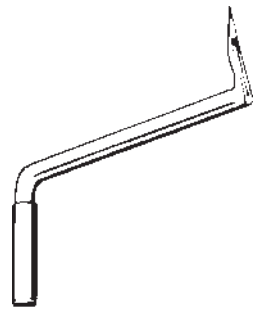

B41309Am

51200		
	Originalnummer <i>Genuine no.</i>	Artikelnummer <i>Item-no.</i> PREMIUM QUALITY
Messer <i>Knife</i>	51249B	B51249Bm
	51270S	B51270Sm



B51249Bm



B51270Sm

Union Special

CT = Hartmetall
 Carbide Tip

51400, 52300, 52900, XF-500, LF-611			
	Originalnummer <i>Genuine no.</i>	Artikelnummer <i>Item-no.</i> STANDARD	Artikelnummer <i>Item-no.</i> PREMIUM QUALITY
Messer <i>Knife</i>	51449	BD-3177	BD-3177m
	51449CT		BD-3177CTm
	51470	BD-3178	BD-3178m
	52949B		BD-3188Am
	A9540		BD-3180m
Kettenstichgreifer <i>Looper</i>	51408-12		B51408-12m
	51408-16		B51408-16m
	51409		B51409m
	G51409C		BD-3210Am



BD-3177
 BD-3177m



BD-3177CTm



BD-3178
 BD3178m



BD-3188Am

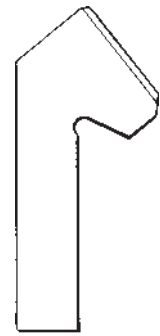

BD-3180m



B51408-12m

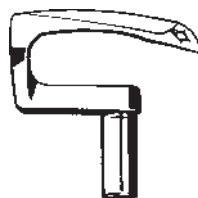

B51408-16m

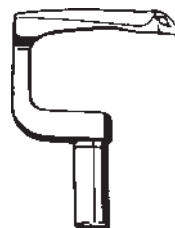

B51409m

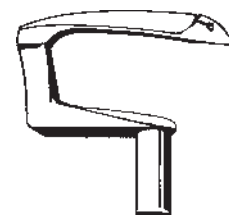

BD-3210Am

Union Special

CT = Hartmetall
 Carbide Tip

51700, 56700		
	Originalnummer <i>Genuine no.</i>	Artikelnummer <i>Item-no.</i> PREMIUM QUALITY
Kettenstichgreifer <i>Looper</i>	51708	B51708m
	51709	B51709m

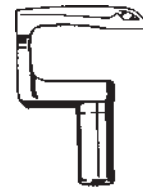

B51708m

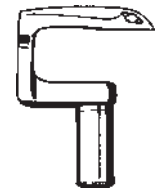

B51709m

51800		
	Originalnummer <i>Genuine no.</i>	Artikelnummer <i>Item-no.</i> PREMIUM QUALITY
Kettenstichgreifer <i>Looper</i>	51808	B51808m
	51808A	B51808Am
	51809	B51809m



B51808m



B51808Am

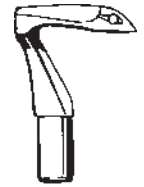

B51809m

51900, 56900, XF-500		
	Originalnummer <i>Genuine no.</i>	Artikelnummer <i>Item-no.</i> PREMIUM QUALITY
Kettenstichgreifer <i>Looper</i>	51908B-8	B51908B-8m
	51908B-9	B51908B-9m
	51909C	B51909Cm
	51909D-9	B51909D-9m

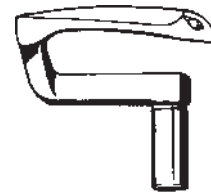

B51908B-8m

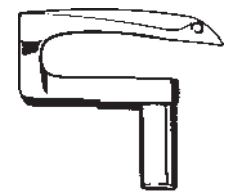

B51908B-9m

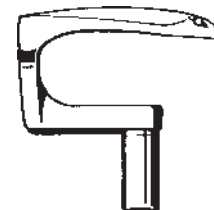

B51909Cm

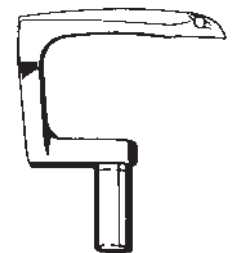

B51909D-9m

52700			
	Originalnummer <i>Genuine no.</i>	Artikelnummer <i>Item-no.</i> STANDARD	Artikelnummer <i>Item-no.</i> PREMIUM QUALITY
Messer <i>Knife</i>	52749A	BD-3181	BD-3181m
	52770C (=B)		BD-3211m



BD-3181
 BD-3181m

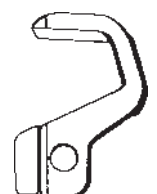

BD-3211m

Union Special

CT = Hartmetall
 Carbide Tip

52700, 52800, 52900, 57700, 57800			
	Originalnummer Genuine no.	Artikelnummer Item-no. STANDARD	Artikelnummer Item-no. PREMIUM QUALITY
Stichplatte Needle Plate	52924BH5-8		BD-3201m
	52928A-16-8		BD-3200m
	G52928A-5-8		BD-3199m
Messer Knife	52949	BD-3189	BD-3189m
	52949A	BD-3188	BD-3188m
	52970C	BD-3190	BD-3190m
	52970CCT		BD-3190CTm
	52970DCT		BD-3187CTm
	52970E	BD-3186	BD-3186m
Kettenstichgreifer Looper	52708B	BD-3194	BD-3194m
	52808E	BD-3193	BD-3193m
	52845A (=B)	BD-3196	BD-3196m
	G52908B	BD-3195	BD-3195m

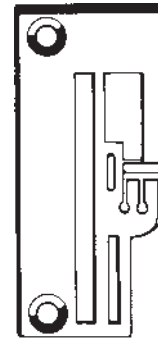

BD-3201m



BD-3200m

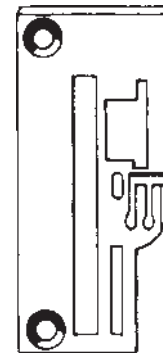

BD-3199m

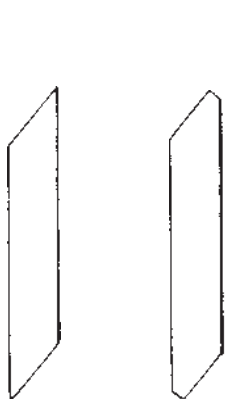

BD-3189
BD-3189m

BD-3188
BD-3188m



BD-3190
BD-3190m



BD-3190CTm



BD-3187CTm

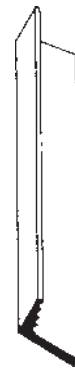

BD-3186
BD-3186m

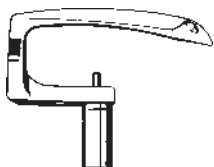

BD-3194
BD-3194m

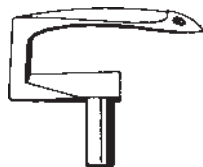

BD-3193
BD-3193m

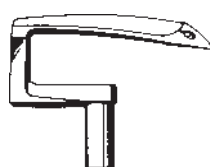

BD-3195
BD-3195m



BD-3196
BD-3196m

Union Special

CT = Hartmetall
 Carbide Tip

52700-BKZO		
	Originalnummer <i>Genuine no.</i>	Artikelnummer <i>Item-no.</i> PREMIUM QUALITY
Messer <i>Knife</i>	167L	BD-3183m
	167LCT	BD-3183CTm
	168R	BD-3184m
	168RCT	BD-3184CTm
	169	BD-3182m

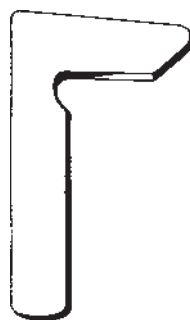

BD-3183m
 BD-3183CTm

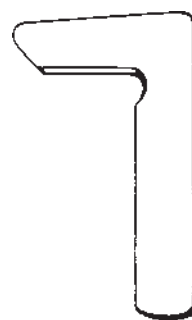

BD-3184m
 BD-3184CTm

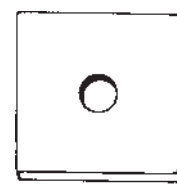

BD-3182m

53100		
	Originalnummer <i>Genuine no.</i>	Artikelnummer <i>Item-no.</i> PREMIUM QUALITY
Messer <i>Knife</i>	9949AR	BD-3206m
	G53170R	BD-3205m



BD-3206m



BD-3205m

53300, 53400		
	Originalnummer <i>Genuine no.</i>	Artikelnummer <i>Item-no.</i> PREMIUM QUALITY
Kettenstichgreifer <i>Looper</i>	53407	BD-3205Am
	53409	BD-3207m

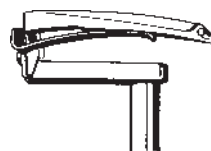

BD-3205Am

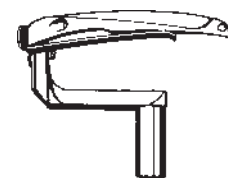

BD-3207m

Union Special

CT = Hartmetall
 Carbide Tip

54200, 54400		
	Originalnummer <i>Genuine no.</i>	Artikelnummer <i>Item-no.</i> PREMIUM QUALITY
Kettenstichgreifer <i>Looper</i>	54208 (=BZ)	BD-3209m
	54208A (=CB)	BD-3208m
	54208B	BD-3208Am
	54211A	B54211Am

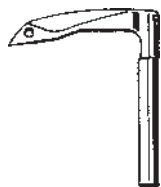

BD-3209m

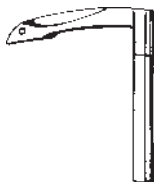

BD-3208m

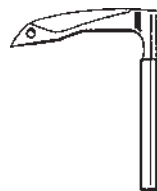

BD-3208Am



B54211Am

57700		
	Originalnummer <i>Genuine no.</i>	Artikelnummer <i>Item-no.</i> PREMIUM QUALITY
Messer <i>Knife</i>	57770A (=D)	BD-3213m
	57949	BD-3217m

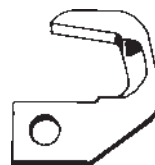

BD-3213m



BD-3217m

Union Special

CT = Hartmetall
 Carbide Tip

57700-BKZ		
	Originalnummer <i>Genuine no.</i>	Artikelnummer <i>Item-no.</i> PREMIUM QUALITY
Messer <i>Knife</i>	11109	BD-3214m
	11109CT	BD-3214CTm
	11110	BD-3215m
	11110CT	BD-3215CTm
	11111	BD-3216m
	11111CT	BD-3216CTm

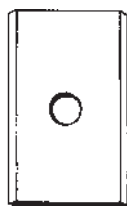

BD-3214m
 BD-3214CTm

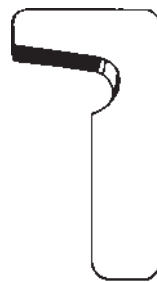

BD-3215m
 BD-3215CTm



BD-3216m
 BD-3216CTm

75400		
	Originalnummer <i>Genuine no.</i>	Artikelnummer <i>Item-no.</i> PREMIUM QUALITY
Messer <i>Knife</i>	75449	B75449m
	75449LA	B75449LAm
	75449LB	B75449LBm
	75470LA	B75470LAm



B75449m



B75449LAm



B75449LBm



B75470LAm

Union Special

CT = Hartmetall
 Carbide Tip

80200, 80600, 80800, 81200, 81300A, 81500			
	Originalnummer Genuine no.	Artikelnummer Item-no. STANDARD	Artikelnummer Item-no. PREMIUM QUALITY
Stichplatte Needle Plate	81224AB		BD-3212m
Kettenstichgreifer Looper	81208	BD-3198	BD-3198m
	81308B		B81308Bm
	81311B		B81311Bm
	81508		B81508m
	AS26XA		BD-3203m
Spreizer Spreader	81507		B81507m
Fadenzieher Loop Retainer	81511		B81511m

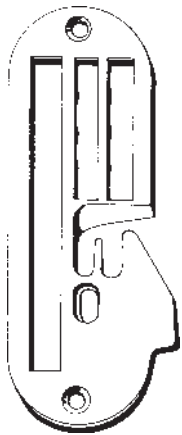

BD-3212m



BD-3198
 BD-3198m

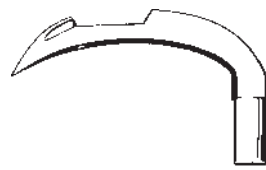

B81308Bm



B81311Bm



B81508m

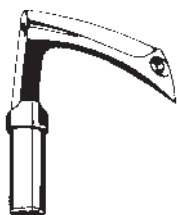

BD-3203m

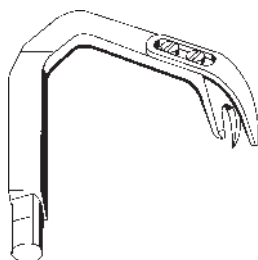

B81507m



B81511m

Union Special

CT = Hartmetall
 Carbide Tip

CS-122, 132 FS122, 123, 132, 133, 311, 312, 322, 323, 332 92800, 93800, 94800			
	Originalnummer Genuine no.	Artikelnummer Item-no. STANDARD	Artikelnummer Item-no. PREMIUM QUALITY
Messer Knife	34749K		BD-3106m
	34770K		BD-3108m
	34749EL		B34749ELm
	34770EL		B34770ELm
Kettenstichgreifer Looper	34709 (=UR)		BD-3107m
	34709D (=URD)		B34709Dm
	50309K		B50309Km
	50360E (= GF)		B50360Em
	52708B	BD-3194	BD-3194m

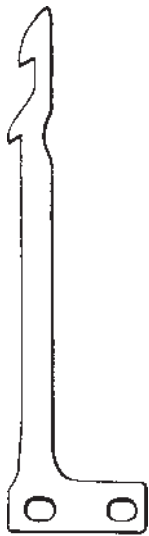

BD-3106m



BD-3108m



B34749ELm



B34770ELm



BD-3107m



B34709Dm

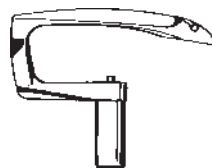

B50309Km

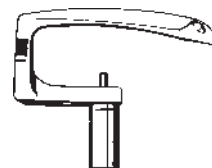

BD-3194
 BD-3194m

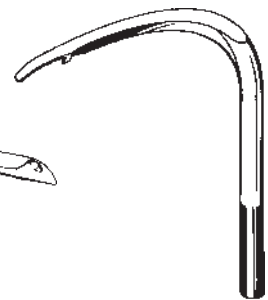

B50360Em

Union Special

CT = Hartmetall
 Carbide Tip

SP-151, 161, 172			
	Originalnummer Genuine no.	Artikelnummer Item-no. STANDARD	Artikelnummer Item-no. PREMIUM QUALITY
Messer Knife	118-45807		B118-45807m
	118-45807CT	BCT118-45807	BCT118-45807m
	118-45906		B118-45906m
	118-45906CT	BCT118-45906	BCT118-45906m
	122-20307		B122-20307m
Kettenstichgreifer Looper	122-40107		B122-40107m
	122-47102		B122-47102m
	122-47300		B122-47300m
	122-47508		B122-47508m



B118-45807m



BCT118-45807
 BCT118-45807m



B118-45906m



BCT118-45906
 BCT118-45906m



B122-20307m

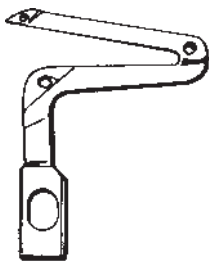

B122-40107m

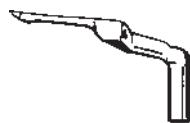

B122-47102m



B122-47300m



B122-47508m

Willcox & Gibbs

CT = Hartmetall
 Carbide Tip

503, 504, 514, 515, 516, E32, 52, 56			
	Originalnummer Genuine no.	Artikelnummer Item-no. STANDARD	Artikelnummer Item-no. PREMIUM QUALITY
Messer Knife	205890CT		BCT205890m
	323-870-200	BD-2782	BD-2782m
	323-870-201	BD-2784	BD-2784m
	323-870-202	BD-2785A	BD-2785Am
	323-870-207		BCT202527m
	323-870-210	BD-2785	BD-2785m
	323-870-211	BD-2787	BD-2787m
	323-870-213	BD-2788	B204161Am
	323-870-214	BD-2783CT	BD-2783CTm
	323-870-215	BD-2786CT	BD-2786CTm
	323-870-217		B204152m
	323-870-218	BD-2789CT	BD-2789CTm
	205607CT		BCT205607m
	205609		B205609m
	210755		B210755m
	210755CT		BCT210755m
	210762		B210762m
	211661		B211661m
	211662A		BCT211662Am
	211662CT		BCT211662m
	211742		B211742m
	211771CT		BCT211771m
	211788		B211788m
	213108		B213108m
	277000CT		B277000m
	277009		B277009m
	301006CT		BCT301006m

Willcox & Gibbs

CT = Hartmetall
Carbide Tip

503, 504, 514, 515, 516, E32, 52, 56			
	Originalnummer <i>Genuine no.</i>	Artikelnummer <i>Item-no.</i> STANDARD	Artikelnummer <i>Item-no.</i> PREMIUM QUALITY
Messer <i>Knife</i>	301008CT		BCT301008m
	301035CT		BCT301035m
	301036CT		BCT301036m
	308026-91CT		BCT308026-91m
	308030CT		BCT308030m
	179458-05		B179458-05m
	179459-05CT		BCT179459-05m
	208393		B208393m
	204835CT		B204835m
Keramikmesser <i>Ceramic Knife</i>	323-870-210BAK	BD-5520	
	323-870-213BAK	BD-5522	
Kettensichgreifer <i>Looper</i>	204949		B204949m
	204963		B204963m
	204964		B204964m
	210512		B210512m
	210513		B210513m
	210515		B210515m
	210730		B210730m
	211719	BLP38	B211719m
	211720		B211720m
	211845		B211845m
	212092		B212092m
	323-810-001	BD-2790	BD-2790m
	323-810-002	BD-2795	BD-2795m
	323-810-003	BD-2791	BD-2791m
	323-810-008	BD-2801	BD-2801m
	323-810-009	BD-2804	BD-2804m

Willcox & Gibbs

CT = Hartmetall
 Carbide Tip

503, 504, 514, 515, 516, E32, 52, 56			
	Originalnummer <i>Genuine no.</i>	Artikelnummer <i>Item-no.</i> STANDARD	Artikelnummer <i>Item-no.</i> PREMIUM QUALITY
Kettenstichgreifer <i>Looper</i>	323-810-010	BD-2805	BD-2805m
	323-810-011	BD-2806	BD-2806m
	323-810-012	BD-2807	BD-2807m
	323-810-018	BD-2810	BD-2810m
	323-810-019	BD-2811	BD-2811m
	323-810-021	BD-2808	BD-2808m
	323-810-022	BD-2809	BD-2809m
	323-810-023		B210360m
	323-810-025	BD-2813	BD-2813m
	323-810-026	BD-2814	BD-2814m
	323-810-027	BD-2815	BD-2815m
	323-810-031		B210729m
	323-810-211	BD-2792	BD-2792m
	323-810-212		B202861m
	323-810-216	BD-2796	BD-2796m
	323-810-217	BD-2798	BD-2798m
	323-810-218	BD-2793	BD-2793m
	323-810-219	BD-2799	BD-2799m
	323-810-224	BD-2800	BD-2800m
	323-810-231	BD-2802	BD-2802m
	323-810-232	BD-2797	BD-2797m
	202703	BD-2803	BD-2803m
	210367(28)		B210367m
	210357		BD-2812m
	211651		B211651m
	212215		B212215m
	212644		B212644m

Willcox & Gibbs

CT = Hartmetall
Carbide Tip

503, 504, 514, 515, 516, E32, 52, 56			
	Originalnummer <i>Genuine no.</i>	Artikelnummer <i>Item-no.</i> STANDARD	Artikelnummer <i>Item-no.</i> PREMIUM QUALITY
Kettenstichgreifer <i>Looper</i>	213105		B213105m
	277010(2)		B277010m
	277010A(5)		B277010Am
	277010B		B277010Bm
	277011(3)		B277011m
	277012		B277012m
	277013		B277013m
	277014(1)		B277014m
	277014A(8)		B277014Am
	277014B(9)		B277014Bm
	277015		B277015m
	277015A		B277015Am
	277017(11)		B277017m
	277018		B277018m
	277018C		B277018Cm
277019(12)		B277019m	
Nähgarnitur <i>Gauge Set</i> 4mm	Stichplatte <i>Needle Plate</i>	205321	B205321m
	Transporteur <i>Feed Dog</i>	204907	B204907m
	Transporteur <i>Feed Dog</i>	208336	B208336m
	Transporteur <i>Feed Dog</i>	208338	B208338m
Nähgarnitur <i>Gauge Set</i> 0x4mm	Stichplatte <i>Needle Plate</i>	210787	B210787m
	Transporteur <i>Feed Dog</i>	210443	B210443m
	Transporteur <i>Feed Dog</i>	210568	*B210568 B210568m
Nähgarnitur <i>Gauge Set</i> 3x4mm	Stichplatte <i>Needle Plate</i>	210846	B210846m
	Transporteur <i>Feed Dog</i>	210494	B210494m
	Transporteur <i>Feed Dog</i>	210581	B210581m

*Nicht mehr lieferbar
*No longer available

Willcox & Gibbs

CT = Hartmetall
 Carbide Tip

503, 504, 514, 515, 516, E32, 52, 56				
		Originalnummer Genuine no.	Artikelnummer Item-no. STANDARD	Artikelnummer Item-no. PREMIUM QUALITY
Nähgarnitur Gauge Set 5mm	Stichplatte Needle Plate	205322		B205322m
	Transporteur Feed Dog	204907		B204907m
	Transporteur Feed Dog	208336		B208336m
	Transporteur Feed Dog	208338		B208338m
Nähgarnitur Gauge Set 0x5mm	Stichplatte Needle Plate	210788		B210788m
	Transporteur Feed Dog	210443		B210443m
	Transporteur Feed Dog	210568	*B210568	B210568m
Nähgarnitur Gauge Set 2x5mm	Stichplatte Needle Plate	210810		B210810m
	Transporteur Feed Dog	210445		B210445m
	Transporteur Feed Dog	210575		B210575m
Nähgarnitur Gauge Set 3x5mm	Stichplatte Needle Plate	204252B		B204252Bm
	Transporteur Feed Dog	208063		B208063m
	Transporteur Feed Dog	208215		B208215m
Nähgarnitur Gauge Set 5x5mm	Stichplatte Needle Plate	204360A		B204360Am
	Transporteur Feed Dog	208063		B208063m
	Transporteur Feed Dog	208215		B208215m
	Stichplatte Needle Plate	210851		B210851m
	Transporteur Feed Dog	210494		B210494m
	Transporteur Feed Dog	210581		B210581m
Schraube Screw		323-600-341	B3637	

*Nicht mehr lieferbar
 *No longer available

Abbildungen dieser Artikel finden Sie unter PEGASUS DCR 601 auf Seite 1.5-90 bis 1.5-99
 For images of these items, please refer to PEGASUS DCR 601 at page 1.5-90 up to 1.5-99

Willcox & Gibbs

CT = Hartmetall
 Carbide Tip

800, 1412 Superlock		
	Originalnummer Genuine no.	Artikelnummer Item-no. PREMIUM QUALITY
Stichplatte Needle Plate	313-801-025	BD-3225m
	313-801-036	BD-3228m
	D250-17B	BD-3227m
Messer Knife	313-870-002	BD-3221m
	313-870-003	BD-3218m
	313-870-005	BD-3222m
	313-870-015	BD-3220m
	D110-10CT	BD-3218CTm
	D110-8ACT	BD-3220CTm
	D119-10	BD-3219m
	D119-10CT	BD-3219CTm
	D119-7CT	BD-3221CTm
Kettenstichgreifer Looper	313-810-001	BD-3229m
	313-810-010	BD-3230m
	313-810-012	BD-3223m

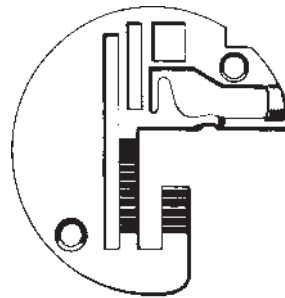

BD-3225m

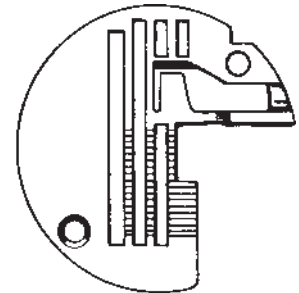

BD-3228m

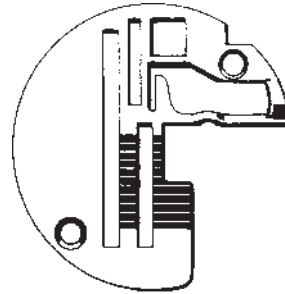

BD-3227m



BD-3221m
BD-3221CTm



BD-3218m
BD-3218CTm



BD-3222m



BD-3220m
BD-3220CTm



BD-3219m
BD-3219CTm



BD-3229m



BD-3230m



BD-3223m

Willcox & Gibbs

CT = Hartmetall
 Carbide Tip

1301, 1311		
	Originalnummer <i>Genuine no.</i>	Artikelnummer <i>Item-no.</i> PREMIUM QUALITY
Messer <i>Knife</i>	312-870-001	B312-870-001m
	312-870-002	B312-870-002m
	312-870-003	B312-870-003m
	312-870-004	B312-870-004m
Zunge <i>Tongue</i>	312-800-026	B312-800-026m



B312-870-003m



B312-870-004m



B312-870-001m



B312-870-002m



B312-800-026m

Overlock			
	Originalnummer <i>Genuine no.</i>	Artikelnummer <i>Item-no.</i> STANDARD	Artikelnummer <i>Item-no.</i> PREMIUM QUALITY
Messer <i>Knife</i>	1655		B1655m
	1657		B1657m
	1662		B1662m
	1662A		B1662Am
	5350	B611515	B5350m



B1655m



B1657m

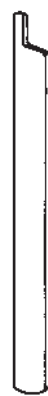

B1662m



B1662Am



B611515
 B5350m

Yamato

CT = Hartmetall
Carbide Tip

46, 47		
	Originalnummer <i>Genuine no.</i>	Artikelnummer <i>Item-no.</i> PREMIUM QUALITY
Keramikmesser <i>Ceramic Knife</i>	15487	B15487m



B15487m

CB-201 - 234, 501 - 544		
	Originalnummer <i>Genuine no.</i>	Artikelnummer <i>Item-no.</i> PREMIUM QUALITY
Kettenstichgreifer <i>Looper</i>	85168	B85168m



B85168m

CM-263, 268, 364		
	Originalnummer <i>Genuine no.</i>	Artikelnummer <i>Item-no.</i> PREMIUM QUALITY
Blindstichgreifer <i>Blindstitch Looper</i>	80413	B80413m



B80413m

Yamato

CT = Hartmetall
 Carbide Tip

DC-, DCY-, DCZ-331, 341, 361, 428, 520, 521 DCZ-203, 220, 222 Z-610, 830, 831, 833		
	Originalnummer <i>Genuine no.</i>	Artikelnummer <i>Item-no.</i> PREMIUM QUALITY
Messer <i>Knife</i>	30421	BD-3234m
	30421CT	BD-3234CTm
	32914CT	BD-3237m
	35285	BD-3235m
	37514	BD-3231m
	37514CT	BD-3231CTm
	37538	BD-3232m
	37538CT	BD-3232CTm
	38332	BD-3233m
Kettenstichgreifer <i>Looper</i>	31877	B31877m
	32541	BD-3243m
	32807	BD-3245m
	32813	BD-3246m
	33059	BD-3244m
	34113	BD-3247m
	34392	BD-3242m
	34393	BD-3241m
	34730	BD-3240m
	35227	BD-3239m
	34519	B34519m
	34584	B34584m

1.5

Yamato

CT = Hartmetall
Carbide Tip

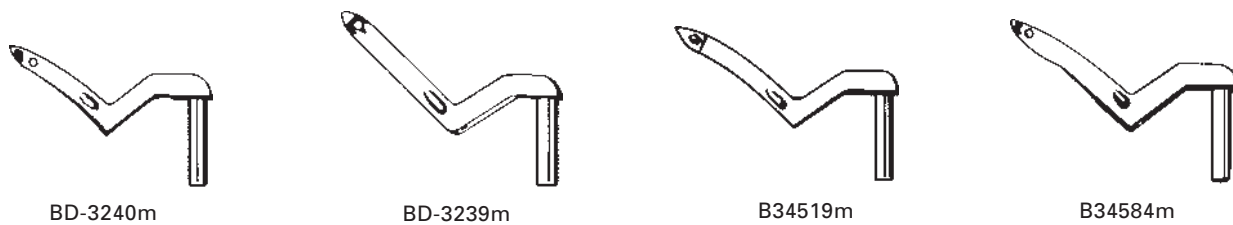
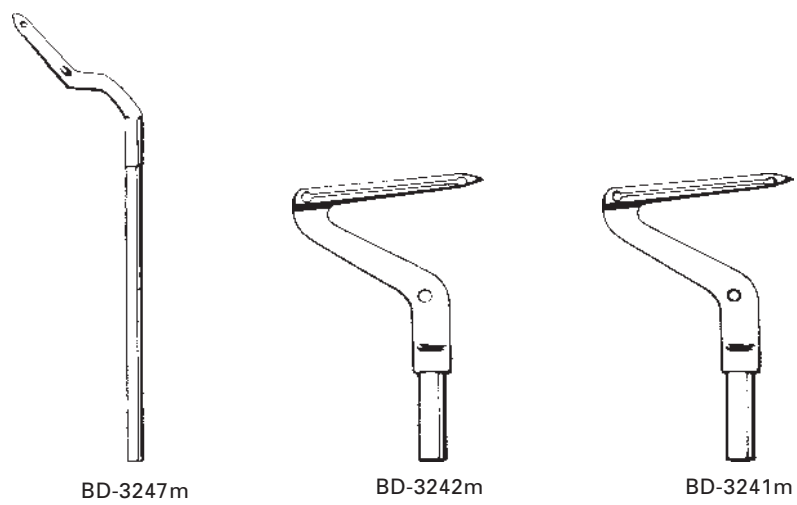
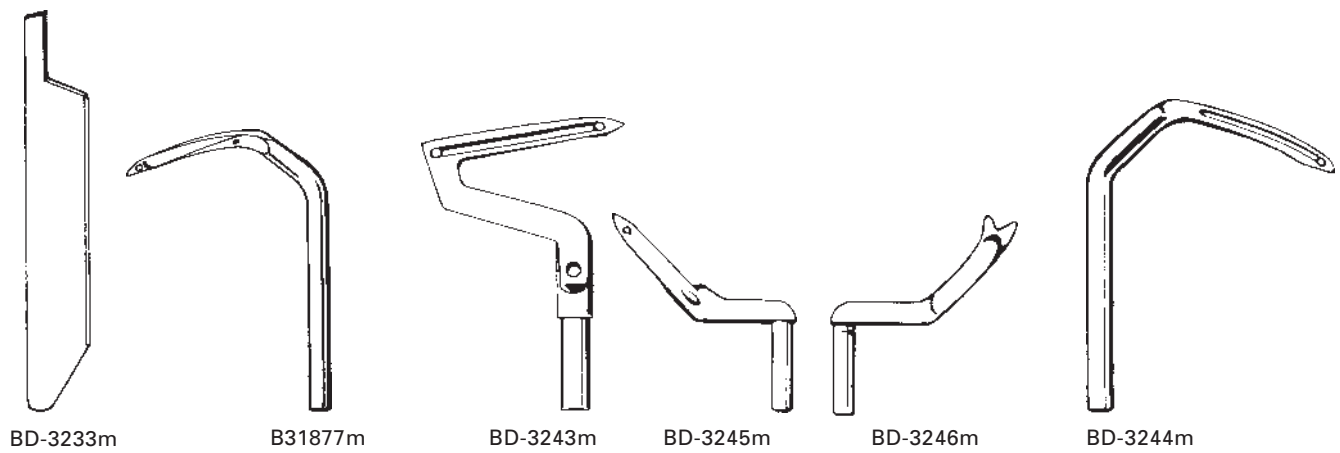
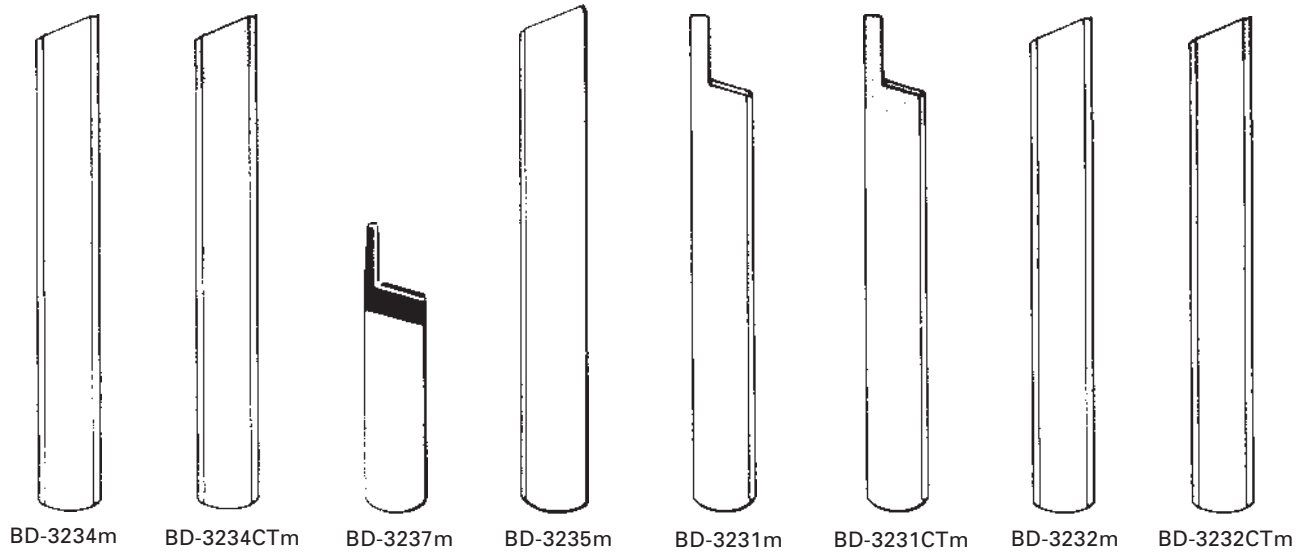

Yamato

CT = Hartmetall
 Carbide Tip

DCZ-203, 220, 222 DC-, DCY-, DCZ-331, 341, 361, 428, 520, 521 AZ-6000, AZ/AZF/AZG-8000, Z-610, 830, 831, 833		
	Originalnummer <i>Genuine no.</i>	Artikelnummer <i>Item-no.</i> STANDARD
Schraube <i>Screw</i>	3637	B3637



B3637

DCZ-428K		
	Originalnummer <i>Genuine no.</i>	Artikelnummer <i>Item-no.</i> PREMIUM QUALITY
Messer <i>Knife</i>	35897	B35897m
	35897CT	BCT35897m



B35897m



BCT35897m

DT-30 VX-2400, 2500		
	Originalnummer <i>Genuine no.</i>	Artikelnummer <i>Item-no.</i> PREMIUM QUALITY
Kettenstichgreifer <i>Looper</i>	69084	B69084m
	69085	B69085m
	69086	B69086m



B69084m

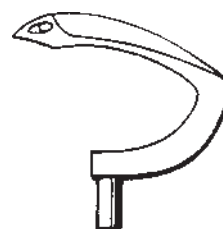

B69085m



B69086m

Yamato

CT = Hartmetall
 Carbide Tip

DV-1200, 1400 DW-1200, 1400		
	Originalnummer <i>Genuine no.</i>	Artikelnummer <i>Item-no.</i> PREMIUM QUALITY
Messer <i>Knife</i>	94417CT	BCT94417m
	95276CT	BCT95276m
	95277	B95277m
	95399	B95399m
Kettenstichgreifer <i>Looper</i>	94480	B94480m
	95499	B95499m



BCT94417m



B95277m



BCT95276m

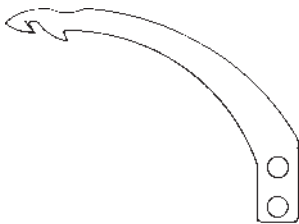

B95399m

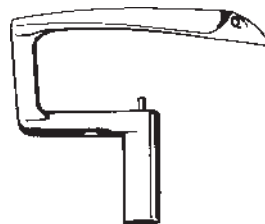

B94480m

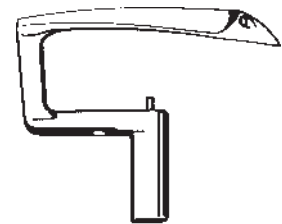

B95499m

DW-1802, 1804		
	Originalnummer <i>Genuine no.</i>	Artikelnummer <i>Item-no.</i> PREMIUM QUALITY
Kettenstichgreifer <i>Looper</i>	66601	B66601m
	66621	B66621m

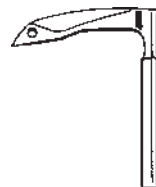

B66601m



B66621m

Yamato

CT = Hartmetall
 Carbide Tip

FD-62			
	Originalnummer Genuine no.	Artikelnummer Item-no. STANDARD	Artikelnummer Item-no. PREMIUM QUALITY
Messer Knife	68121HSS	BD-3113	BD-3113m
	68121CT		BD-3113CTm
	68184HSS	BD-3112	BD-3112m
	68184CT		BD-3112CTm
Kettenstichgreifer Looper	68217	BD-3114	BD-3114m
Spreizer Spreader	68123		BD-3118m
	68124		BD-3116m
Zunge Tongue	68491		BD-3115Am



BD-3113
BD-3113m



BD-3113CTm



BD-3112
BD-3112m



BD-3112CTm



BD-3114
BD-3114m



BD-3118m



BD-3116m



BD-3115Am

Yamato

CT = Hartmetall
Carbide Tip

VC-2400, 2600, 2700, 2800, 3600, 3700, 3800 VE-2700, VF-2400, 2800, VG-2700		
	Originalnummer <i>Genuine no.</i>	Artikelnummer <i>Item-no.</i> PREMIUM QUALITY
Messer <i>Knife</i>	3100512	B3100512m
	3100513	B3100513m
	3101026	B3101026m
	3101028CT	BCT3101028m
	3101465CT	BCT3101465m
	3101607	B3101607m
	3101633	B3101633m
	3101801	B3101801m
	3101802	B3101802m
	3110037CT	BCT3110037m
	3110038	B3110038m
	3110038CT	BCT3110038m
	3120015CT	BCT3120015m
	3120016	B3120016m
	3120150CT	B3120150m
	3120151	B3120151m
	3201062	B3201062m
	95276CT	BCT95276m
Kettenstichgreifer <i>Looper</i>	3109306	B3109306m
	3109310	B3109310m
	3209311	B3209311m
	3109300	B3109300m

Yamato

CT = Hartmetall
 Carbide Tip

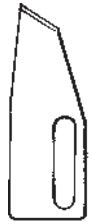

B3100512m



B3100513m



B3101026m



BCT3101028m



BCT3101465m



B3101607m



B3101633m



B3101801m

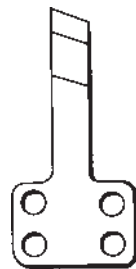

B3101802m

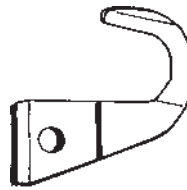

BCT3110037m



B3110038m



BCT3110038m

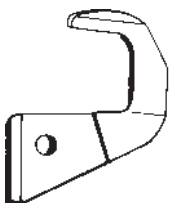

BCT3120015m



B3120016m



B3120150m



B3120151m



B3201062m



BCT95276m



B3109306m

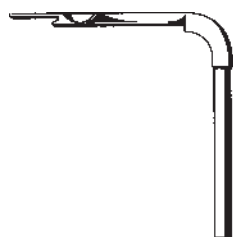

B3109310m

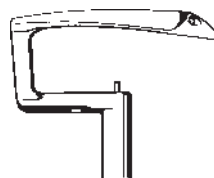

B3209311m



B3109300m

Yamato

CT = Hartmetall
Carbide Tip

Z/ZF-1000, Z-1500, Z-2000, Z-3000, Z-5000 Z-6000, AZ-6000, AZ/AZF/AZG-8000,			
	Originalnummer <i>Genuine no.</i>	Artikelnummer <i>Item-no.</i> STANDARD	Artikelnummer <i>Item-no.</i> PREMIUM QUALITY
Messer <i>Knife</i>	2020003		BCT2020003m
	20271		B20271m
	20491		BD-3250m
	20491GCT		BD-3250ACTm
	20496CT		BD-3251m
	20498		BD-3249m
	2100167	B2100167	B2100167m
	2101091		B2101091m
	2110305		B2110305m
	2111055CT		BCT2111055m
	2111056		BCT2111056m
	2121107CT		BCT2121107m
	2121111		B2121111m
	22195		BD-3248m
	23580CT		B23580CTm
	23582		B23582m
	20491CT		BD-3250CTm
	14136		B21-3003m
Keramikkmesser <i>Ceramic Knife</i>	2100167BAK	BD-5523	
Kettenstichgreifer <i>Looper</i>	2109300		B2109300m
	2109301		B2109301m
	2109302		B2109302m
	2109303		B2109303m
	2109304		B2109304m
	2109305		B2109305m
	2109308		B2109308m
	2109320		B2109320m

Yamato

CT = Hartmetall
 Carbide Tip



BCT2020003m



B20271m

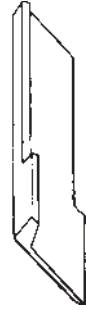

BD-3250m



BD-3250ACTm



BD-3251m



BD-3249m



B2100167
 B2100167m



B2101091m



B2110305m

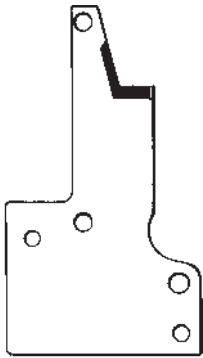

BCT2111055m

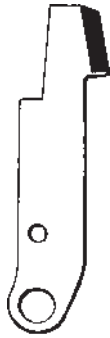

BCT2111056m

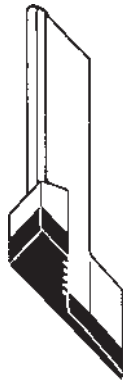

BCT2121107m



B2121111m



BD-3248m



B23580CTm



B23582m



BD-3250CTm

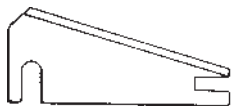

B21-3003m



BD-5523

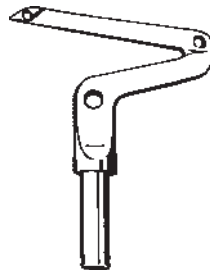

B2109300m



B2109301m

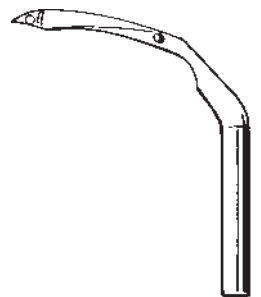

B2109302m



B2109303m



B2109304m



B2109305m

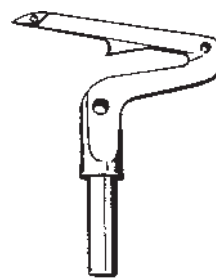

B2109308m



B2109320m

Yamato

CT = Hartmetall
Carbide Tip

Z/ZF-1000, Z-1500, Z-2000, Z-3000, Z-5000 Z-6000, AZ-6000, AZ/AZF/AZG-8000,			
	Originalnummer <i>Genuine no.</i>	Artikelnummer <i>Item-no.</i> STANDARD	Artikelnummer <i>Item-no.</i> PREMIUM QUALITY
Kettenstichgreifer <i>Looper</i>	2109322		B2109322m
	2109324		B2109324m
	2109326		B2109326m
	2109328		B2109328m
	2109331		B2109331m
	2109341		B2109341m
	2109342		B2109342m
	2109347		B2109347m
	2109348		B2109348m
	2119301(Y1)		B2119301m
	2119302(Y2)		B2119302m
	2119322(F3)		B2119322m
	2119323(F4)		B2119323m
	2119324		B2119324m
	2129300		B2129300m
	21700		B21700m
	21701		BD-3252m
	21752		B21752m
	21754		B21754m
	21756		B21756m
	21757		BD-3253m
	25046		B25046m
	27012		B27012m
	27013		B27013m
	20577		B20577m

Yamato

CT = Hartmetall
 Carbide Tip



B2109322m

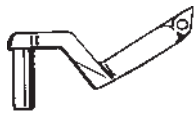

B2109324m

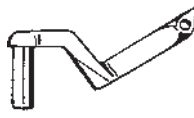

B2109326m



B2109328m

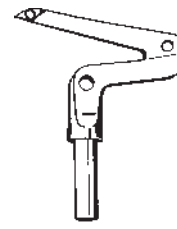

B2109331m



B2109341m



B2109342m

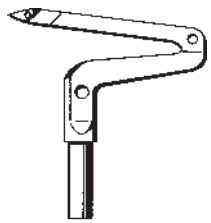

B2109347m

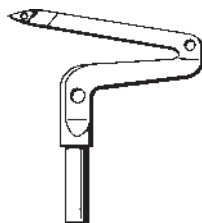

B2109348m

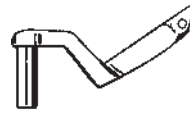

B2119301m



B2119302m



B2119322m



B2119323m

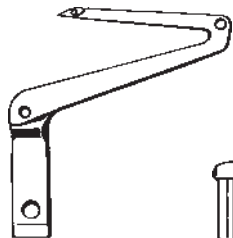

B2119324m



B2129300m

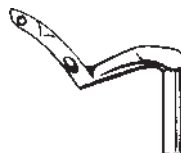

B21700m

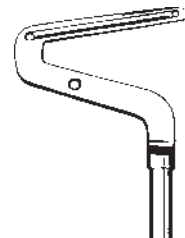

BD-3252m

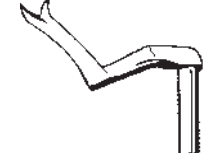

B21752m

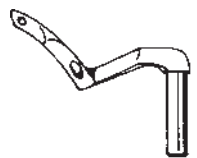

B27012m

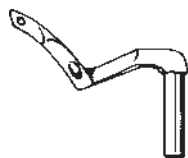

B27013m

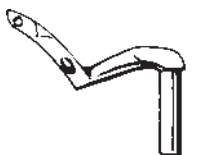

B21754m

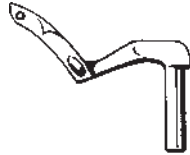

B21756m

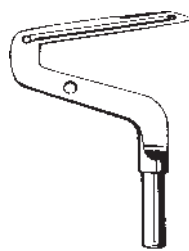

BD-3253m

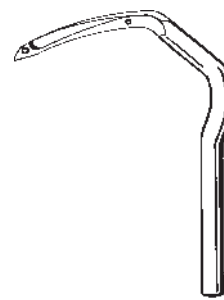

B25046m

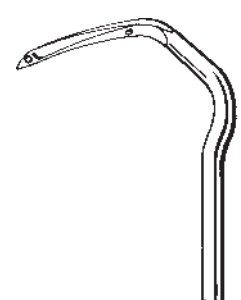

B20577m

1: NÄHEN SEWING

1.6 VERSCHLEISSTEILE FÜR PEGASUS KETTENSTICHMASCHINEN *HIGH MORTALITY PARTS FOR PEGASUS CHAINSTITCH MACHINES*

1.6 VERSCHLEISSTEILE FÜR PEGASUS KETTENSTICHMASCHINEN HIGH MORTALITY PARTS FOR PEGASUS CHAINSTITCH MACHINES

9732

-432FA2 16/453 3x5

-432FA2 16/453 5x5

<p>(Abb. ähnlich Image similar)</p>  <p>Nähfuß Sewing foot P-212662-50 (für/for 3x5) P-212665-50 (für/for 5x5)</p>	<p>(Abb. ähnlich Image similar)</p>  <p>Haupttransporteur Main feed dog P-212684-16</p>	 <p>Obertransporteur Upper feed dog P-212661-10F</p>	 <p>Differentialtransporteur Compound feed P-212686-13F (für/for 3x5) P-212687-13F (für/for 5x5)</p>
 <p>Stichplatte Needle plate P-212682-50 (für/for 3x5) P-212683-50 (für/for 5x5)</p>	 <p>Mitgehender Nadelschutz Synchronized needle guard P-210724</p>	 <p>Doppelkettenstichgreifer Double chainstitch looper P-210357</p>	 <p>Linker Greifer Looper, left P-212215</p>
 <p>Rechter Greifer Looper, right P-211719</p>	 <p>Abreißmesser Hook knife P-202451</p>	 <p>Obermesser Upper knife P-201121A</p>	 <p>Untermesser Lower knife P-202295</p>
 <p>Filter Filter P-206233</p>			

Befestigungsschrauben für: Retaining screws for:

Nähfuß Sewing foot P-005328	Haupttransporteur Main Feed dog P-001175-2	Hilfstransporteur Auxiliary feed dog P-005492	Obertransporteur Upper feed dog P-001175-2	Stichplatte Needle plate P-005484-HC
Nadel Needle P-005292	Kettenstichgreifer Looper P-001175-2	Linker Greifer Looper, left P-001175-2	Rechter Greifer Looper, right P-001998-2	Abreißmesser Hook knife P-002921

9752

-130FA2/04-363 x5

	(Abb. ähnlich Image similar) 		
Nähfuß Sewing foot P-212757-50	Haupttransporteur Main feed dog P-210574BF	Obertransporteur Upper feed dog P-212677-10F	Differentialtransporteur Compound feed P-212572BF
(Abb. ähnlich Image similar) 			
Stichplatte Needle plate P-210797	Mitgehender Nadelschutz Synchronized needle guard P-210724	Linker Greifer Looper, left P-212644	Rechter Greifer Looper, right P-210366
			
Abreißmesser Hook knife P-202451	Obermesser Upper knife P-201121A	Untermesser Lower knife P-202295	Filter Filter P-206233

Befestigungsschrauben für:
Retaining screws for:

Nähfuß Sewing foot P-005328	Haupttransporteur Main Feed dog P-001175-2	Hilftransporteur Auxiliary feed dog P-005492	Obertransporteur Upper feed dog P-001175-2	Stichplatte Needle plate P-005484-HC
Nadel Needle P-005292	Nadelschutz Needle guard P-005501	Linker Greifer Looper, left P-001175-2	Rechter Greifer Looper, right P-001998-2	Abreißmesser Hook knife P-002921

1.6 VERSCHLEISSTEILE FÜR PEGASUS KETTENSTICHMASCHINEN HIGH MORTALITY PARTS FOR PEGASUS CHAINSTITCH MACHINES

9752 -133FA2/14-363 2x4

 <p>Nähfuß Sewing foot P-212673-40</p>	 <p>Haupttransporteur Main feed dog P-210574-BF</p>	 <p>Obertransporteur Upper feed dog P-212677-10F</p>	 <p>(Abb. ähnlich Image similar)</p> <p>Differentialtransporteur Compound feed P-212572-BF</p>
 <p>Stichplatte Needle plate P-210805</p>	 <p>Mitgehender Nadelschutz Synchronized needle guard P-210724</p>	 <p>Linker Greifer Looper, left P-212644</p>	 <p>Rechter Greifer Looper, right P-210365</p>
 <p>Abreißmesser Hook knife P-202451</p>	 <p>Obermesser Upper knife P-201121A</p>	 <p>Untermesser Lower knife P-202295</p>	 <p>Filter Filter P-206233</p>

Befestigungsschrauben für: Retaining screws for:

Nähfuß Sewing foot P-005328	Haupttransporteur Main Feed dog P-001175-2	Hilfstransporteur Auxiliary feed dog P-005492	Obertransporteur Upper feed dog P-001175-2	Stichplatte Needle plate P-005484-HC
Nadel Needle P-005292	Nadelschutz Needle guard P-005501	Linker Greifer Looper, left P-001175-2	Rechter Greifer Looper, right P-001998-2	Abreißmesser Hook knife P-002921

E32

-430-516-233

 <p>Nähfuß Sewing foot P-208501 (für/for 3x5) P-208502 (für/for 5x5)</p>	 <p>Haupttransporteur Main feed dog P-210581</p>	 <p>Differentialtransporteur Compound feed P-210494</p>	 <p>Stichplatte Needle plate P-210847 (für/for 3x5) P-210851 (für/for 5x5)</p>
 <p>Mitgehender Nadelschutz Synchronized needle guard P-210724</p>	 <p>Doppelkettenstichgreifer Double chainstitch looper P-210357</p>	 <p>Linker Greifer Looper, left P-210356</p>	 <p>Rechter Greifer Looper, right P-210365</p>
 <p>Abreißmesser Hook knife P-202451</p>	 <p>Obermesser Upper knife P-201121A</p>	 <p>Untermesser Lower knife P-202295</p>	 <p>Filter Filter P-206233</p>

Befestigungsschrauben für:
Retaining screws for:

Nähfuß Sewing foot P-005328	Haupttransporteur Main Feed dog P-001175-2	Hilftransporteur Auxiliary feed dog P-005492	Stichplatte Needle plate P-005484-HC	Nadel Needle P-005292
Nadelschutz Needle guard P-005501	Kettenstichgreifer Looper P-001175-2	Linker Greifer Looper, left P-001175-2	Rechter Greifer Looper, right P-001998-2	Abreißmesser Hook knife P-001229

1.6 VERSCHLEISSTEILE FÜR PEGASUS KETTENSTICHMASCHINEN HIGH MORTALITY PARTS FOR PEGASUS CHAINSTITCH MACHINES

E52 -130/504-253 x5

 <p>Nähfuß Sewing foot P-205253</p>	 <p>Haupttransporteur Main feed dog P-210575</p>	 <p>Differentialtransporteur Compound feed P-210445</p>	 <p>Stichplatte Needle plate P-210801</p>
 <p>Mitgehender Nadelschutz Synchronized needle guard P-210724</p>	 <p>Linker Greifer Looper, left P-210356</p>	 <p>Rechter Greifer Looper, right P-210365</p>	 <p>Abreißmesser Hook knife P-202451</p>
 <p>Obermesser Upper knife P-201121A</p>	 <p>Untermesser Lower knife P-202295</p>	 <p>Filter Filter P-206233</p>	

Befestigungsschrauben für: Retaining screws for:

Nähfuß Sewing foot P-005328	Haupttransporteur Main Feed dog P-001175-2	Hilfstransporteur Auxiliary feed dog P-005492	Stichplatte Needle plate P-005484-HC	Nadel Needle P-005292
Nadelschutz Needle guard P-005501	Linker Greifer Looper, left P-001175-2	Rechter Greifer Looper, right P-001998-2	Abreißmesser Hook knife P-002921	

E52

-131M-514-353W2x5

			
Nähfuß Sewing foot P-205253	Haupttransporteur Main feed dog P-210575-BF	Differentialtransporteur Compound feed P-210445-BF	Stichplatte Needle plate P-210810
			
Mitgehender Nadelschutz Synchronized needle guard P-210724	Linker Greifer Looper, left P-210356	Rechter Greifer Looper, right P-210365	Abreißmesser Hook knife P-202451
			
Obermesser Upper knife P-201121A	Untermesser Lower knife P-202295	Filter Filter P-206233	

Befestigungsschrauben für:
Retaining screws for:

Nähfuß Sewing foot P-005328	Haupttransporteur Main Feed dog P-001175-2	Hilftransporteur Auxiliary feed dog P-005492	Stichplatte Needle plate P-005484-HC	Nadel Needle P-005292
Nadelschutz Needle guard P-005501	Linker Greifer Looper, left P-001175-2	Rechter Greifer Looper, right P-001998-2	Abreißmesser Hook knife P-001229	

1.6 VERSCHLEISSTEILE FÜR PEGASUS KETTENSTICHMASCHINEN HIGH MORTALITY PARTS FOR PEGASUS CHAINSTITCH MACHINES

EX3216 -03-233

 Nähfuß <i>Sewing foot</i> P-277118 (für/for 3x5) P-277119 (für/for 5x5)	 Haupttransporteur <i>Main feed dog</i> P-277327-16	 Differentialtransporteur <i>Compound feed</i> P-277330-16 (für/for 3x5) P-277329-16 (für/for 5x5)	 Stichplatte <i>Needle plate</i> P-277517-R50 (für/for 3x5) P-277516-R50 (für/for 5x5)
 Mitgehender Nadelschutz <i>Synchronized needle guard</i> P-277004	 Doppelkettenstichgreifer <i>Double chainstitch looper</i> P-277018	 Linker Greifer <i>Looper, left</i> P-277015	 Rechter Greifer <i>Looper, right</i> P-277010A
 Abreißmesser <i>Hook knife</i> P-202451	 Obermesser <i>Upper knife</i> P-201121A	 Winkelmesser <i>Angular knife</i> P-210755	 Untermesser <i>Lower knife</i> P-202295
 Filter <i>Filter</i> P-206233			

Befestigungsschrauben für: Retaining screws for:

Nähfuß <i>Sewing foot</i> P-007013	Haupttransporteur <i>Main Feed dog</i> P-007013	Hilfstransporteur <i>Auxiliary feed dog</i> P-007010	Stichplatte <i>Needle plate</i> P-007170	Nadel <i>Needle</i> P-004554
Nadelschutz <i>Needle guard</i> P-007259	Kettenstichgreifer <i>Looper</i> P-007168	Linker Greifer <i>Looper, left</i> P-007168	Rechter Greifer <i>Looper, right</i> P-007054	Abreißmesser <i>Hook knife</i> P-007003

EX5204
-02-233x5

			
Nähfußsohle Sewing foot sole P-201230-C	Haupttransporteur Main feed dog P-277303-16F	Differentialtransporteur Compound feed P-277305-16F	Stichplatte Needle plate P-277504-R50
			
Mitgehender Nadelschutz Synchronized needle guard P-277004	Linker Greifer Looper, left P-277015	Rechter Greifer Looper, right P-277010	Abreißmesser Hook knife P-202451
			
Obermesser Upper knife P-201121A	Winkelmesser Angular knife P-210755	Untermesser Lower knife P-202295	Filter Filter P-206233

Befestigungsschrauben für:
Retaining screws for:

Nähfuß Sewing foot P-007013	Haupttransporteur Main Feed dog P-007013	Hilfstransporteur Auxiliary feed dog P-007010	Stichplatte Needle plate P-007170	Nadel Needle P-004554
Nadelschutz Needle guard P-007259	Linker Greifer Looper, left P-007168	Rechter Greifer Looper, right P-007054	Abreißmesser Hook knife P-007008	

1.6 VERSCHLEISSTEILE FÜR PEGASUS KETTENSTICHMASCHINEN HIGH MORTALITY PARTS FOR PEGASUS CHAINSTITCH MACHINES

EX5214 -03-333 2x5

 <p>Nähfußsohle Sewing foot sole P-201230-C</p>	 <p>Haupttransporteur Main feed dog P-277303-16F</p>	 <p>Differentialtransporteur Compound feed P-277305-16F</p>	 <p>Stichplatte Needle plate P-277505-R40</p>
 <p>Mitgehender Nadelschutz Synchronized needle guard P-277004</p>	 <p>Linker Greifer Looper, left P-277015</p>	 <p>Rechter Greifer Looper, right P-277010A</p>	 <p>Abreißmesser Hook knife P-202451</p>
 <p>Obermesser Upper knife P-201121A</p>	 <p>Winkelmesser Angular knife P-210755</p>	 <p>Untermesser Lower knife P-202295</p>	 <p>Filter Filter P-206233</p>

Befestigungsschrauben für: Retaining screws for:

Nähfuß Sewing foot P-007013	Haupttransporteur Main Feed dog P-007013	Hilfstransporteur Auxiliary feed dog P-007010	Stichplatte Needle plate P-007170	Nadel Needle P-004554
Nadelschutz Needle guard P-007259	Linker Greifer Looper, left P-007168	Rechter Greifer Looper, right P-007054	Abreißmesser Hook knife P-007008	

EXT3216

-03-233

 <p>Nähfuß Sewing foot P-277154-50 (für/for 3x5) P-277155-50 (für/for 5x5)</p>	 <p>Haupttransporteur Main feed dog P-277327-16</p>	 <p>Obertransporteur Upper feed dog P-277320 (für/for 3x5) P-277321 (für/for 5x5)</p>	 <p>Differentialtransporteur Compound feed P-277330-16 (für/for 3x5) P-277329-16 (für/for 5x5)</p>
 <p>Stichplatte Needle plate P-277517-R50 (für/for 3x5) P-277516-R50 (für/for 5x5)</p>	 <p>Mitgehender Nadelschutz Synchronized needle guard P-277004</p>	 <p>Doppelkettenstichgreifer Double chainstitch looper P-277018</p>	 <p>Linker Greifer Looper, left P-277015</p>
 <p>Rechter Greifer Looper, right P-277010A</p>	 <p>Abreißmesser Hook knife P-202451</p>	 <p>Obermesser Upper knife P-201121A</p>	 <p>Winkelmesser Angular knife P-210755</p>
 <p>Untermesser Lower knife P-202295</p>	 <p>Filter Filter P-206233</p>		

Befestigungsschrauben für:
Retaining screws for:

Nähfuß Sewing foot P-007013	Haupttransporteur Main Feed dog P-007013	Hilftransporteur Auxiliary feed dog P-007010	Obertransporteur Upper feed dog P-007014	Stichplatte Needle plate P-007170
Nadel Needle P-004554	Kettenstichgreifer Looper P-007168	Linker Greifer Looper, left P-007168	Rechter Greifer Looper, right P-007054	Abreißmesser Hook knife P-007008

1.6 VERSCHLEISSTEILE FÜR PEGASUS KETTENSTICHMASCHINEN HIGH MORTALITY PARTS FOR PEGASUS CHAINSTITCH MACHINES

EXT5204 -02-233 x4

<p>(Abb. ähnlich Image similar)</p>  <p>Nähfuß Sewing foot P-277149-40</p>	 <p>Haupttransporteur Main feed dog P-277303-16F</p>	 <p>Obertransporteur Upper feed dog P-277344</p>	 <p>Differentialtransporteur Compound feed P-277305-16F</p>
 <p>Stichplatte Needle plate P-277504-R40</p>	 <p>Mitgehender Nadelschutz Synchronized needle guard P-277004</p>	 <p>Linker Greifer Looper, left P-277015</p>	 <p>Rechter Greifer Looper, right P-277010</p>
 <p>Abreißmesser Hook knife P-202451</p>	 <p>Obermesser Upper knife P-201121A</p>	 <p>Winkelmesser Angular knife P-210755</p>	 <p>Untermesser Lower knife P-202295</p>
 <p>Filter Filter P-206233</p>			

Befestigungsschrauben für: Retaining screws for:

Nähfuß Sewing foot P-007013	Haupttransporteur Main Feed dog P-007013	Hilfstransporteur Auxiliary feed dog P-007010	Obertransporteur Upper feed dog P-007014	Stichplatte Needle plate P-007170
Nadel Needle P-004554	Nadelschutz Needle guard P-007259	Linker Greifer Looper, left P-007168	Rechter Greifer Looper, right P-007054	Abreißmesser Hook knife P-007008

EXT5214

-03-333 2x4

 Nähfuß Sewing foot P-277150-40	 Haupttransporteur Main feed dog P-277303-16F	 Obertransporteur Upper feed dog P-277344	 Differentialtransporteur Compound feed P-277305-16F
 Stichplatte Needle plate P-277505-R40	 Mitgehender Nadelschutz Synchronized needle guard P-277004	 Linker Greifer Looper, left P-277015	 Rechter Greifer Looper, right P-277010A
 Abreißmesser Hook knife P-202451	 Obermesser Upper knife P-201121A	 Winkelmesser Angular knife P-210755	 Untermesser Lower knife P-202295
 Filter Filter P-206233			

Befestigungsschrauben für: Retaining screws for:



Nähfuß Sewing foot P-007013	Haupttransporteur Main Feed dog P-007013	Hilftransporteur Auxiliary feed dog P-007010	Obertransporteur Upper feed dog P-007014	Stichplatte Needle plate P-007170
Nadel Needle P-004554	Nadelschutz Needle guard P-007259	Linker Greifer Looper, left P-007168	Rechter Greifer Looper, right P-007054	Abreißmesser Hook knife P-007008

1.6 VERSCHLEISSTEILE FÜR PEGASUS KETTENSTICHMASCHINEN HIGH MORTALITY PARTS FOR PEGASUS CHAINSTITCH MACHINES

M632

-38 3x4

-70 5x5

 <p>Nähfuß Sewing foot P-208501 (für/for -38 3x4) P-208502 (für/for -70 5x5)</p>	 <p>Haupttransporteur Main feed dog P-208066 (für/for -38 3x4) P-208063 (für/for -70 5x5)</p>	 <p>Differentialtransporteur Compound feed P-208219 (für/for -38 3x4) P-208215 (für/for -70 5x5)</p>	 <p>Stichplatte Needle plate P-204367 (für/for -38 3x4) P-204360A(für/for -70 5x5)</p>
 <p>Doppelkettenstichgreifer Double chainstitch looper P-204314A</p>	 <p>Linker Greifer Looper, left P-204072</p>	 <p>Rechter Greifer Looper, right P-204702 P-204704 (für/for 515-33)</p>	 <p>Abreißmesser Hook knife P-202451</p>
 <p>Obermesser Upper knife P-201121A</p>	 <p>Untermesser Lower knife P-204161</p>		

Befestigungsschrauben für: Retaining screws for:

Nähfuß Sewing foot P-005328	Haupttransporteur Main Feed dog P-001175-2	Hilfstransporteur Auxiliary feed dog P-005492	Differential-transporteur Compound feed P-001175-3	Stichplatte Needle plate P-001732-HC
Nadel Needle P-005292-HU	Kettenstichgreifer Looper P-001189	Linker Greifer Looper, left P-001175-3	Rechter Greifer Looper, right P-001998-2	Abreißmesser Hook knife P-001229

M652
-01-4

 <p>Nähfußsohle Sewing foot sole P-201152-E</p>	<p>(Abb. ähnlich Image similar)</p>  <p>Haupttransporteur Main feed dog P-208090-BF</p>	 <p>Differentialtransporteur Compound feed P-204730-BF</p>	 <p>Stichplatte Needle plate P-205773</p>
 <p>Mitgehender Nadelschutz Synchronized needle guard P-209009</p>	 <p>Linker Greifer Looper, left P-204072</p>	 <p>Rechter Greifer Looper, right P-204062</p>	 <p>Abreißmesser Hook knife P-202451</p>
 <p>Obermesser Upper knife P-201121A</p>	 <p>Untermesser Lower knife P-202295</p>		

Befestigungsschrauben für:
Retaining screws for:

<p>Nähfuß Sewing foot P-005328</p>	<p>Haupttransporteur Main Feed dog P-001175-2</p>	<p>Hilfstransporteur Auxiliary feed dog P-005492</p>	<p>Differential- transporteur Compound feed P-001189</p>	<p>Stichplatte Needle plate P-004009-1HC</p>
<p>Nadel Needle P-003119</p>	<p>Nadelschutz Needle guard P-005501</p>	<p>Linker Greifer Looper, left P-001175-3</p>	<p>Rechter Greifer Looper, right P-001998-2</p>	<p>Abreißmesser Hook knife P-001229</p>

1.6 VERSCHLEISSTEILE FÜR PEGASUS KETTENSTICHMASCHINEN HIGH MORTALITY PARTS FOR PEGASUS CHAINSTITCH MACHINES

M652 -13 2x4

 <p>Nähfußsohle Sewing foot sole P-208730</p>	<p>(Abb. ähnlich Image similar)</p>  <p>Haupttransporteur Main feed dog P-203078-BF</p>	 <p>Differentialtransporteur Compound feed P-204676-BF</p>	 <p>Stichplatte Needle plate P-202554-E</p>
 <p>Mitgehender Nadelschutz Synchronized needle guard P-209009</p>	 <p>Linker Greifer Looper, left P-204072</p>	 <p>Rechter Greifer Looper, right P-204949</p>	 <p>Abreißmesser Hook knife P-202451</p>
 <p>Obermesser Upper knife P-201121A</p>	 <p>Untermesser Lower knife P-202295</p>		

Befestigungsschrauben für: Retaining screws for:

Nähfuß Sewing foot P-005328	Haupttransporteur Main Feed dog P-001175-2	Hilfs-transporteur Auxiliary feed dog P-005492	Differential- transporteur Compound feed P-001189	Stichplatte Needle plate P-004009-1HC
Nadel Needle P-005292-HU	Nadelschutz Needle guard P-005501	Linker Greifer Looper, left P-001175-3	Rechter Greifer Looper, right P-001998-2	Abreißmesser Hook knife P-001229

W562
-02BB x240

 Nähfuß Sewing foot P-257318-A40	 Haupttransporteur Main feed dog P-257215-16F	 Differentialtransporteur Compound feed P-257261-16F	 Stichplatte Needle plate P-257030-B40
 Vorderer Nadelschutz Needle guard P-257553	 Kettenstichgreifer Looper P-257550-91	 Fadenleger Cover-thread carrier P-257565	 Fadenführung Thread guide P-253511
 Fadenführung Thread guide P-253614	 Fadenbügel Thread bracket P-253613	 Fadenführung Thread guide P-253507	 Filter Filter P-206233

Befestigungsschrauben für:
Retaining screws for:

Nähfuß Sewing foot P-001170-3	Haupttransporteur Main Feed dog P-005590	Stichplatte Needle plate P-005373-HC	Nadel Needle P-004554	Nadelschutz Needle guard P-007031
Kettenstichgreifer Looper P-007086	Fadenleger Cover-thread carrier P-007020	Fadenführung Thread guide (für/for P-253511) P-004554	Fadenführung Thread guide (für/for P-253507) P-007009	

1.6 VERSCHLEISSTEILE FÜR PEGASUS KETTENSTICHMASCHINEN HIGH MORTALITY PARTS FOR PEGASUS CHAINSTITCH MACHINES

W562 -05BB-240

 <p>Nähfuß Sewing foot P-257318-A40</p>	 <p>Haupttransporteur Main feed dog P-257221-16F</p>	 <p>Differentialtransporteur Compound feed P-257267-16F</p>	 <p>Stichplatte Needle plate P-257050-B40</p>
 <p>Vorderer Nadelschutz Needle guard P-257553</p>	 <p>Kettenstichgreifer Looper P-257550-91</p>	 <p>Fadenleger Cover-thread carrier P-257565</p>	 <p>Fadenführung Thread guide P-253511</p>
 <p>Fadenführung Thread guide P-253614</p>	 <p>Fadenbügel Thread bracket P-253613</p>	 <p>Fadenführung Thread guide P-253507</p>	 <p>Filter Filter P-206233</p>

Befestigungsschrauben für: Retaining screws for:

Nähfuß Sewing foot P-001170-3	Haupttransporteur Main Feed dog P-005590	Stichplatte Needle plate P-005373-HC	Nadel Needle P-004554	Nadelschutz Needle guard P-007031
Kettenstichgreifer Looper P-007086	Fadenleger Cover-thread carrier P-007020	Fadenführung Thread guide (für/for P-253507) P-007009	Fadenführung Thread guide (für/for P-253511) P-004554	

W664
-01CB x356

 Nähfuß Sewing foot P-257461-56	 Haupttransporteur Main feed dog P-257243-16F	 Differentialtransporteur Compound feed P-257290-16F	 Stichplatte Needle plate P-257018B56
 Kettenstichgreifer Looper P-257566	 Fadenleger Cover-thread carrier P-257565	 Fadenführung Thread guide P-253595-91	 Fadenbügel Thread bracket P-253599
 Fadenführung Thread guide P-253507	 Fadenführung Thread guide P-253511	 Filter Filter P-206233	

Befestigungsschrauben für:
Retaining screws for:

Nähfuß Sewing foot P-001170-3	Haupttransporteur Main Feed dog P-007019	Stichplatte Needle plate P-005511-HC	Nadel Needle P-004554	Kettenstichgreifer Looper P-007129
Fadenleger Cover-thread carrier P-007020	Fadenführung Thread guide (für/for P-253507) P-007009	Fadenführung Thread guide (für/for P-253511) P-004554		

1.6 VERSCHLEISSTEILE FÜR PEGASUS KETTENSTICHMASCHINEN HIGH MORTALITY PARTS FOR PEGASUS CHAINSTITCH MACHINES

W664 -08AC x248

 <p>Nähfuß Sewing foot P-257460-48</p>	 <p>Haupttransporteur Main feed dog P-257242-16F</p>	 <p>Differentialtransporteur Compound feed P-257294-16F</p>	 <p>Stichplatte Needle plate P-257084-C48</p>
 <p>Kettenstichgreifer Looper P-257566</p>	 <p>Fadenleger Cover-thread carrier P-257565</p>	 <p>Fadenführung Thread guide P-253595-91</p>	 <p>Fadenbügel Thread bracket P-253593</p>
 <p>Fadenführung Thread guide P-253507</p>	 <p>Fadenführung Thread guide P-253511</p>	 <p>Filter Filter P-206233</p>	

Befestigungsschrauben für: Retaining screws for:

Nähfuß Sewing foot P-001170-3	Haupttransporteur Main Feed dog P-007013	Stichplatte Needle plate P-005511-HC	Nadel Needle P-004554	Kettenstichgreifer Looper P-007129
Fadenleger Cover-thread carrier P-007020	Fadenführung Thread guide (für/for P-253507) P-007009	Fadenführung Thread guide (für/for P-253511) P-004554		

1: NÄHEN *SEWING*

1.7 MAUSER-SPEZIAL KETTENSTICH- MASCHINEN *MAUSER-SPEZIAL CHAINSTITCH MACHINES*

SH-6003
 -052-M04

			
Nähfuß Sewing foot KPF603052	Haupttransporteur Main feed dog KFD60821	Hilfstransporteur Auxiliary feed dog KAF60871	Differentialtransporteur Compound feed KDF6040T
			
Stichplatte Needle plate KTP603052	Mitgehender Nadelschutz Synchronized needle guard K6030718E200	Linker Greifer Looper, left KLL603884	Rechter Greifer Looper, right KUL603880
			
Abreißmesser Hook knife K6031002D700	Obermesser Upper knife K6031314C500	Untermesser Lower knife K6031218P700	Filter Filter K6031521G700

Befestigungsschrauben für:
Retaining screws for:

Nähfuß Sewing foot KSJ36400606M	Haupttransporteur Main Feed dog KSK44400907A	Hilfstransporteur Auxiliary feed dog KSB32440705A	Stichplatte Needle plate KSF44400607C	Nadel Needle KSN32440300A
Nadelschutz Needle guard KSE32440405L	Linker Greifer Looper, left KSJ36400606M	Rechter Greifer Looper, right KSK44400505D	Abreißmesser Hook knife KSB24560405A	

SH-6004
-A43-M14

			
Nähfuß Sewing foot KPF604A32	Haupttransporteur Main feed dog KFD60824	Hilfstransporteur Auxiliary feed dog KAF60871	Differentialtransporteur Compound feed KDF86504
			
Stichplatte Needle plate KTP604A43	Linker Greifer Looper, left KLL603884	Rechter Greifer Looper, right KUL604883	Abreißmesser Hook knife K6031002D700
			
Obermesser Upper knife K6031314C500	Untermesser Lower knife K6031218P700	Filter Filter K6031521G700	

Befestigungsschrauben für:
Retaining screws for:

Nähfuß Sewing foot KSJ36400606M	Haupttransporteur Main Feed dog KSK44400907A	Hilfstransporteur Auxiliary feed dog KSB32440705A	Stichplatte Needle plate KSF44400607C	Nadel Needle KSN32440300A
Linker Greifer Looper, left KSJ36400606M	Rechter Greifer Looper, right KSK44400505D	Abreißmesser Hook knife KSB24560405A		

SH-6005
 -C52-M16

			
Nähfuß Sewing foot KPF605C32	Haupttransporteur Main feed dog KFD60828	Hilfstransporteur Auxiliary feed dog KAF60874	Differentialtransporteur Compound feed KDF85209
			
Stichplatte Needle plate KTP605C52	Doppelkettenstichgreifer Double chainstitch looper KCL605294	Linker Greifer Looper, left KLL603884	Rechter Greifer Looper, right KUL603880
			
Abreißmesser Hook knife K6031002D700	Obermesser Upper knife K6031314C500	Untermesser Lower knife K6031218P700	

Befestigungsschrauben für:
Retaining screws for:

Nähfuß Sewing foot KSJ36400606M	Haupttransporteur Main Feed dog KSK44400907A	Hilfstransporteur Auxiliary feed dog KSB32440705A	Stichplatte Needle plate KSF44400607C	Nadel Needle KSN32440300A
Kettenstichgreifer Looper KSN44400400A	Linker Greifer Looper, left KSJ36400606M	Rechter Greifer Looper, right KSK44400505D	Abreißmesser Hook knife KSB24560405A	

SH-6005
-D53-H16

			
Nähfuß Sewing foot KPF605D53	Haupttransporteur Main feed dog KFD60830	Hilfstransporteur Auxiliary feed dog KAF60873	Differentialtransporteur Compound feed KDF85407
			
Stichplatte Needle plate KTP605D53	Doppelkettenstichgreifer Double chainstitch looper KCL605294	Linker Greifer Looper, left KLL603884	Rechter Greifer Looper, right KUL603880
			
Abreißmesser Hook knife K6031002D700	Obermesser Upper knife K6031314C500	Untermesser Lower knife K6031218P700	Filter Filter K6031521G700

Befestigungsschrauben für:
Retaining screws for:

Nähfuß Sewing foot KSJ36400606M	Haupttransporteur Main Feed dog KSK44400907A	Hilfstransporteur Auxiliary feed dog KSB32440705A	Stichplatte Needle plate KSF44400607C	Nadel Needle KSN32440300A
Kettenstichgreifer Looper KSN44400400A	Linker Greifer Looper, left KSJ36400606M	Rechter Greifer Looper, right KSK44400505D	Abreißmesser Hook knife KSB24560405A	

CT-6500
 -0-56(M)



Artikelbezeichnung <i>Item description</i>	Artikelnummer <i>Item number</i>
Nähfuß <i>Sewing Foot</i>	KPFC00561
Haupttransporteur <i>Main Feed Dog</i>	KFDC00560
Differentialtransporteur <i>Compound Feed Dog</i>	KDFC00560
Nadelhalter <i>Needle Clamp</i>	KNCC00561
Stichplatte <i>Needle Plate</i>	KTPC00561
Kettenstichgreifer <i>Looper</i>	KLLC00560
Fadenleger <i>Cover-thread Carrier</i>	KSLC00560
Fadenführung <i>Thread Guide</i>	KF000710B700
Fadenführung <i>Thread Guide</i>	KC000703B700
Filter <i>Filter</i>	K60315210F
Befestigungsschrauben <i>Retaining Screws</i>	
für Nähfuß <i>for Sewing Foot</i>	KSC36400705A
für Haupttransporteur <i>for Main Feed Dog</i>	KMB85240806K
für Kettenstichgreifer <i>for Looper</i>	KMB85240605A
für Stichplatte <i>for Needle Plate</i>	KSF36400706A
für Nadel <i>for Needle</i>	KSH32440300A
für Fadenleger <i>for Cover-thread Carrier</i>	KMB04281207K
für Fadenführung <i>for Thread Guide</i>	KMB85240607K

FT-6503
 -0-56(M)

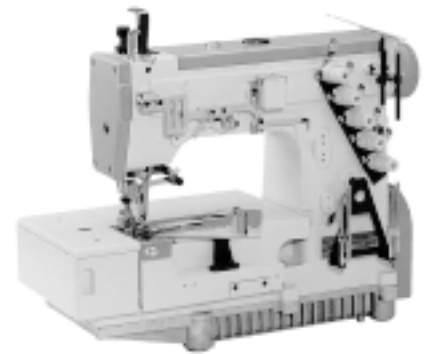

Artikelbezeichnung <i>Item description</i>	Artikelnummer <i>Item number</i>
Nähfuß <i>Sewing Foot</i>	KPFF03563
Haupttransporteur <i>Main Feed Dog</i>	KDFD03563
Differentialtransporteur <i>Compound Feed Dog</i>	KDFF03563
Nadelhalter <i>Needle Clamp</i>	KNCC00561
Stichplatte <i>Needle Plate</i>	KTPC03563
Nadelschutz <i>Needle Guard</i>	KNGF00D1
Kettenstichgreifer <i>Looper</i>	KLLF00560
Fadenleger <i>Cover-thread Carrier</i>	KSLF00560
Fadenführung <i>Thread Guide</i>	KF000710B700
Fadenführung <i>Thread Guide</i>	KC000701B700
Filter <i>Filter</i>	K60315210F
Befestigungsschrauben <i>Retaining Screws</i>	
für Nähfuß <i>for Sewing Foot</i>	KSC36400705A
für Haupttransporteur <i>for Main Feed Dog</i>	KMB85240807K
für Kettenstichgreifer <i>for Looper</i>	KMB04280705K
für Stichplatte <i>for Needle Plate</i>	KSF36400706A
für Nadel <i>for Needle</i>	KSH32440300A
für Nadelschutz <i>for Needle Guard</i>	KSB24560405A
für Fadenleger <i>for Cover-thread Carrier</i>	KMB04281207K
für Fadenführung <i>for Thread Guide</i>	KMB85240607K

1: NÄHEN *SEWING*

1.8 APPARATE UND APPARATEHALTERUNGEN *ATTACHMENTS AND ATTACHMENT BRACKETS*

Inhalt
Content

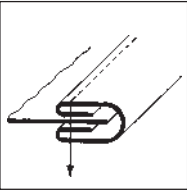
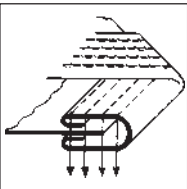
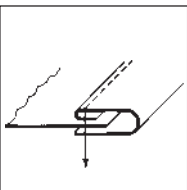
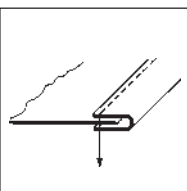
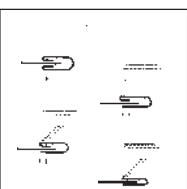
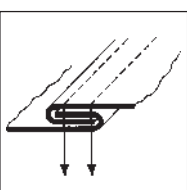
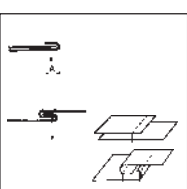
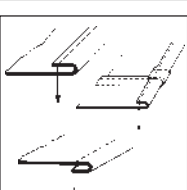
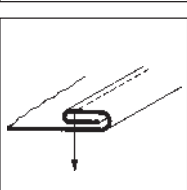
	Schrägbandeinfasser mit doppeltem Umbug	5-13	<i>Bias Tape Binder with double fold</i>	5-13
	Bandeinfasser mit doppeltem Umbug für Flachbettmaschinen	14-15	<i>Tape Binder with double fold for flatbed machines</i>	14-15
	Bandeinfasser mit doppeltem Umbug für Dreifach-Transport-Maschinen	16-18	<i>Tape Binder with double fold for unison feed machines</i>	16-18
	Bundapparate	19-20	<i>Waistband Binder</i>	19-20
	Gürtelapparate	21	<i>Belt Folder</i>	21
	Bandeinfasser mit Umbug oben für Flachbettmaschinen	21-24	<i>Tape Binder with upper fold for flatbed machines</i>	21-24
	Bandeinfasser mit Umbug oben für Dreifach-Transport-Maschinen	24-25	<i>Tape Binder with upper fold for unison feed machines</i>	24-25
	Bandeinfasser ohne Umbug für Flachbettmaschinen	26-33	<i>Tape Binder without fold for flatbed machines</i>	26-33
	Bandeinfasser ohne Umbug für Dreifach-Transport-Maschinen	34-36	<i>Tape Binder without fold for unison feed machines</i>	34-36
	Börtchenapparate mit doppeltem Umbug	37-38	<i>Split-tube Folder with double fold</i>	37-38
	Börtchenapparate mit versetztem Umbug oben	39-41	<i>Split-tube Folder with offset upper fold</i>	39-41
	Börtchenapparate mit Umbug oben	42-43	<i>Split-tube Folder with upper fold</i>	42-43
	Börtchenapparate ohne Umbug	44-46	<i>Split-tube Folder without fold</i>	44-46
	Börtchenapparate mit Gummibandzuführung	47-48	<i>Split-tube Folder with elastic tape guide</i>	47-48
	Doppelkapper für Arm-Abwärts-Maschinen	49	<i>Lap seam Feller for feed-off the arm machines</i>	49
	Doppelkapper für Flachbettmaschinen	50	<i>Lap seam Feller for flatbed machines</i>	50
	Spezialkapper für Einnadel-Flachbettmaschinen	51-53	<i>Special Feller for single needle flatbed machines</i>	51-53
	Kapper mit Umbug oben	54	<i>Feller with upper fold</i>	54
	Kapper mit Umbug unten	55-56	<i>Feller with lower fold</i>	55-56
	Säumer mit Umbug oben, starr	57-58	<i>Hemmer with upper fold, fixed</i>	57-58
	Säumer mit Umbug oben, abschwenkbar	59-62	<i>Swing-out Hemmer with upper fold</i>	59-62
	Säumer mit Umbug oben, aufklappbar	62	<i>Latch Hemmer with upper fold</i>	62

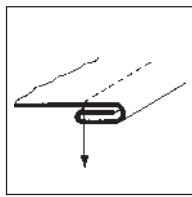

Säumer mit Umbug unten, starr 63
Säumer mit Umbug unten, abschwengbar 64

Hemmer with lower fold, fixed 63
Swing-out Hemmer with lower fold 64

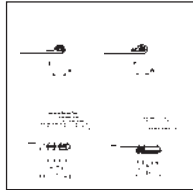

Kapper und Säumer mit
Kordelzuführung 64-65
Kapper und Säumer
mit Gummibandzuführung 65-67

*Feller and Hemmer with
cord guide 64-65*
*Feller and Hemmer
with elastic tape guide 65-67*

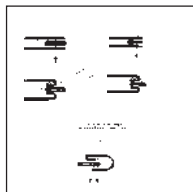

Paspelapparate für
Flachbettmaschinen 68-70
Paspelapparate für
Overlockmaschinen 70-71
Paspelführungen für Börtchenapparate,
Einfasser und Säumer 72

*Piping Attachment for
flatbed machines 68-70*
*Piping Attachment
for overlock machines 70-71*
*Piping Guide for Split-tube Folders,
Binder and Hemmer 72*

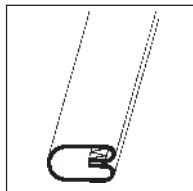

Spaghetti-Apparate
für Flachbettmaschinen 73
Spaghetti-Apparate
für Overlock-Maschinen 73

*Spaghetti- Attachment
for flatbed machines 73*
*Spaghetti- Attachment
for overlock-machines 73*

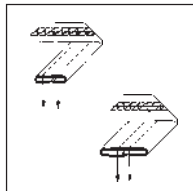

Schlaufenfalter 74-77

Belt Loop Attachments 74-77

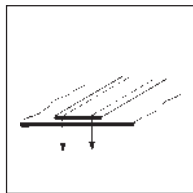

Bandführungen 78-79

Tape Guides 78-79

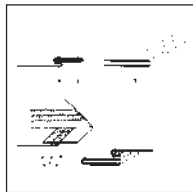

Spezialapparate 79-81

Special Attachments 79-81



Bandbremsen 81

Tape Retainer 81

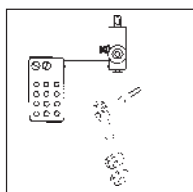

Apparatehalterungen 82-83

Attachment Brackets 82-83

Anmerkungen:

Notes:

Erläuterungen der Kennbuchstaben zur
Materialstärke:

L = leicht	= 1,5 mm
M = mittel	= 2,0 mm
MH = mittelschwer	= 2,5 mm
H = schwer	= 3,5 mm
XH = extra schwer	= 4,5 mm

Bei den angegebenen Fertigbreiten handelt es sich lediglich um Annäherungsmaße. Das tatsächliche Ergebnis kann, je nach Stoffart und Materialstärke, von den genannten Maßen abweichen.

Explanation of letter code with reference to the fabric thickness:

L = light	= 1,5 mm
M = medium	= 2,0 mm
MH = medium heavy	= 2,5 mm
H = heavy	= 3,5 mm
XH = extra heavy	= 4,5 mm

All mentioned finished sizes are indicative and may vary, depending on the fabric features and thickness.

Schrägbandeinfasser mit doppeltem Umbug
Bias Tape Binder with double fold



Bandbreite Tape Size in mm	Fertigbreite Finished Sizes in mm	SUISEI A1S
20.0	5.0	BA-1267s
22.0	5.5	BA-1268s
24.0	6.0	BA-1269s
26.0	6.5	BA-1270s
28.0	7.0	BA-1271s
30.0	7.5	BA-1272s
32.0	8.0	BA-1273s
36.0	9.5	BA-1274s
40.0	10.5	BA-1275s

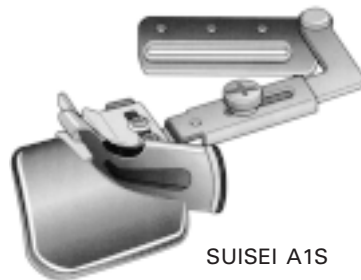

SUISEI A1S

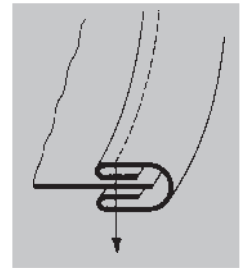

Bandbreite Tape Size in mm	Fertigbreite Finished Sizes in mm	SUISEI A9S
25.0	6.5	BA-1328s
28.0	7.5	BA-1329s
32.0	8.5	BA-1330s
38.0	10.5	BA-1331s

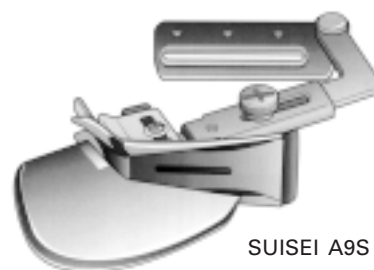

SUISEI A9S

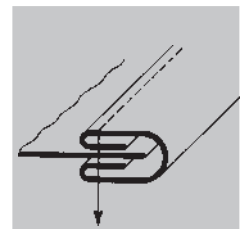

SUISEI A1S

Einfasser, ausschwenkbar, für leichte Textilbänder, geeignet für Einfassarbeiten an geraden Kanten bzw. Linksbögen.
Swing-out binder for light fabric tapes, suitable for straight and left-turn binding.

SUISEI A9S

Einfasser, ausschwenkbar, für normale bis steife Textilbänder, geeignet für Einfassarbeiten an geraden Kanten.
Swing-out binder for standard up to stiff fabric tapes, suitable for straight binding.

Geeignete Nähwerkzeuge finden Sie unter:
For suitable sewing parts please refer to:

Apparatefüße: Kap.1.1 Seite 22-24
Stichplatten/Transporteure: Kap.1.1 Seite 40
Attachment feet: Kap.1.1 Seite 22-24
Needle plates / Feed dogs: Kap.1.1 Seite 40

Schrägbandeinfasser mit doppeltem Umbug *Bias Tape Binder with double fold*

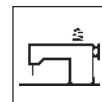

Bandbreite <i>Tape Size</i> <i>in mm</i>	Fertigbreite <i>Finished Size</i> <i>in mm</i>	BF1081	BF1081H	BF508
16.0	4.0			BF508/16
19.0	5.0	BF1081/19		BF508/19
22.0	5.5			BF508/22
22.0	6.0	BF1081/22		
25.0	6.0			BF508/25
25.0	7.0	BF1081/25		
28.0	7.0			BF508/28
30.0	8.0	BF1081/30	BF1081/30H	BF508/30
32.0	9.0			BF508/32
35.0	9.0	BF1081/35	BF1081/35H	
35.0	10.0			BF508/35
38.0	11.0			BF508/38
40.0	11.0	BF1081/40	BF1081/40H	
40.0	12.0			BF508/40
45.0	13.0	BF1081/45	BF1081/45H	BF508/45
50.0	15.0			BF508/50
50.0	17.0		BF1081/50H	

BF1081

Einfasser für leichte bis mittlere Textilbänder, geeignet für Einfassarbeiten an geraden Kanten bzw. weiten Linksbögen.

Binder for light up to medium fabric tapes, suitable for straight and left-turn binding.

BF1081H

Einfasser für mittlere bis starke Textilbänder, geeignet für Einfassarbeiten an geraden Kanten bzw. weiten Linksbögen

Binder for medium-heavy up to heavy fabric tapes, suitable for straight and left-turn binding.

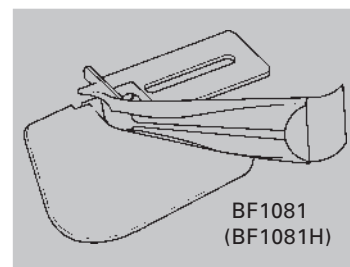

BF1081
(BF1081H)

BF508

Einfasser für normale bis steife Textilbänder, geeignet für Einfassarbeiten an geraden Kanten bzw. weiten Linksbögen.

Binder for standard and stiff fabric tapes, suitable for straight and left-turn binding.

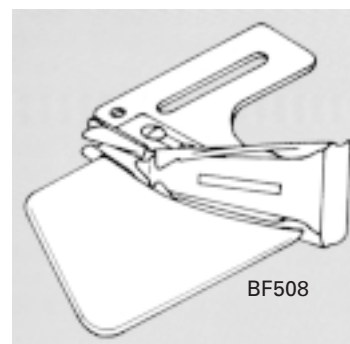

BF508

Geeignete Nähwerkzeuge finden Sie unter:
For suitable sewing parts please refer to:

Apparatefüße: Kap.1.1 Seite 22-24
Stichplatten/Transporteure: Kap.1.1 Seite 40
Attachment feet: Kap.1.1 Seite 22-24
Needle plates / Feed dogs: Kap.1.1 Seite 40



Schrägbandeinfasser mit doppeltem Umbug
Bias Tape Binder with double fold

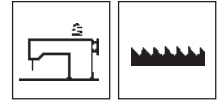

Bandbreite Tape Size in mm	Fertigbreite Finished Sizes in mm	SUISEI A10S
16.0	4.0	BA-1335s
18.0	4.5	BA-1336s
22.0	5.5	BA-1337as
20.0	5.0	BA-1337s
24.0	6.0	BA-1338s
26.0	6.5	BA-1339s
28.0	7.0	BA-1340s
30.0	8.0	BA-1341s
32.0	8.5	BA-1342s
36.0	10.0	BA-1343s
40.0	11.0	BA-1344s
45.0	13.0	BA-1345s
50.0	16.0	BA-1346s



Ausgleichsgelenkfuß
optional, siehe Seite 000
*Compensating foot
on request refer to page 000*



SUISEI A10S

SUISEI A10S

Einfassgarnitur für Textilbänder bis 1,5 mm Stärke, geeignet zum Einfassen enger Kurven, bestehend aus: Bandeinfasser, Stichplatte, Transporteur, Gelenkpresserfuß.

Geeignet für Schnellnäher mit standardisierter Nähgarnitur.

Binder set for fabric tapes up to 1,5 mm thickness, suitable for binding sharp curves, consisting of: binder, needle plate, feed dog, hinged presser foot.

Suitable for standard lockstitch machines.

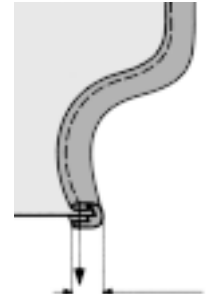

Geeignete Nähwerkzeuge finden Sie unter:
For suitable sewing parts please refer to:

Apparatefüße: Kap.1.1 Seite 22-24
Attachment feet: Kap.1.1 Seite 22-24

Schrägbandeinfasser mit doppeltem Umbug *Bias Tape Binder with double fold*

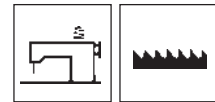

Bandbreite <i>Tape Width</i> <i>in mm</i>	Fertigbreite <i>Finished Size</i> <i>in mm</i>	Bandstärke <i>Tape Width</i> <i>in mm</i>	DAIKO D10-4	DAIKO D10-4SOH
16.0	4.0	1.2	BA-1335	
18.0	4.5	1.5	BA-1336	
20.0	5.0	1.5	BA-1337	BD10-4SOH/20
22.0	5.5	1.5	BA-1337A	
24.0	6.0	1.5	BA-1338	
26.0	6.5	1.5	BA-1339	BD10-4SOH/26
28.0	7.0	1.5	BA-1340	
30.0	8.0	1.5	BA-1341	BD10-4SOH/30
32.0	8.5	1.5	BA-1342	
34.0	9.0	1.5	BA-1342A	
36.0	10.0	1.5	BA-1343	BD10-4SOH/36
38.0	10.5	1.5	BA-1343A	
40.0	11.0	1.5	BA-1344	BD10-4SOH/40
42.0	12.0	1.5	BA-1344A	
45.0	13.0	1.5	BA-1345	
50.0	15.0	1.5	BA-1346	

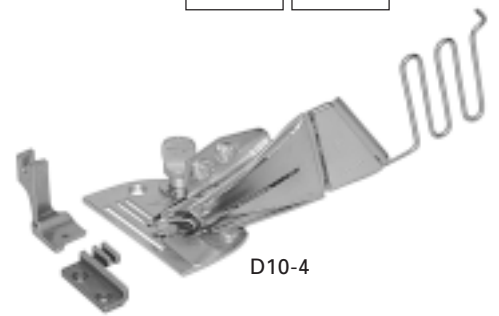

D10-4



D10-4SOH

DAIKO D10-4

Einfassgarnitur für Textilbänder bis 1,5 mm Stärke, geeignet zum Einfassen enger Kurven, mit verstellbaren Umbugführungen, sowie Nähgutzuführung für Bandbreiten ab 32mm; bestehend aus: Bandeinfasser, Stichplatte, Transporteur, starrer Presserfuß.

Geeignet für Schnellnäher mit standardisierter Nähgarnitur.

Binder Set for fabric tapes upto 1,5 mm thickness, suitable for binding sharp curves, with adjustable folding guides and material raising guide for smooth feeding;

consisting of: binder, needle plate, feed dog, solid presser foot.

Suitable for standard lockstitch machines.

DAIKO D10-4SOH

Einfassergarnitur wie unter D10-4 beschrieben, jedoch ausschwenkbar.

Binder set as described under D10-4, but with swing-out binder.

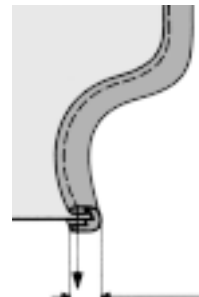

Anwendungsbeispiele für verstellbare Umbugführung.
Application examples for adjustable folding guides.

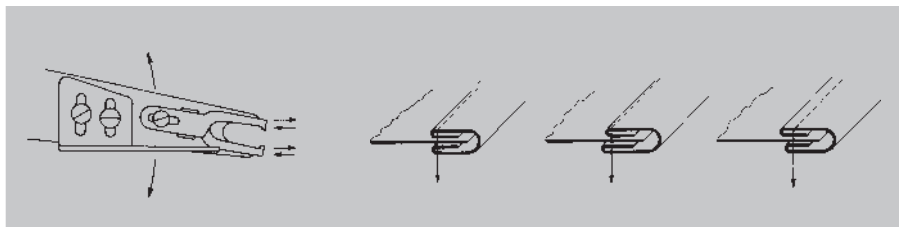

Geeignete Nähwerkzeuge finden Sie unter:
For suitable sewing parts please refer to:

Apparatefüße: Kap.1.1 Seite 22-24
Attachment feet: Kap.1.1 Seite 22-24

Schrägbandeinfasser mit doppeltem Umbug
Bias Tape Binder with double fold

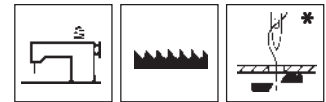

Bandbreite <i>Tape Size</i> <i>in mm</i>	Fertigbreite <i>Finished Size</i> <i>in mm</i>	Bandstärke <i>Tape Width</i> <i>in mm</i>	BF60	BF60PF138	BF60PF438	BF60PF463*	BF60PF483
14.0	3.0	1.0	BF60/14	BF60/14PF138	BF60/14PF438	BF60/14PF463	BF60/14PF483
16.0	4.0	1.2	BF60/16	BF60/16PF138	BF60/16PF438	BF60/16PF463	BF60/16PF483
18.0	4.5	1.2	BF60/18	BF60/18PF138	BF60/18PF438	BF60/18PF463	BF60/18PF483
19.0	4.7	1.5	BF60/19	BF60/19PF138	BF60/19PF438	BF60/19PF463	BF60/19PF483
20.0	5.0	1.5	BF60/20	BF60/20PF138	BF60/20PF438	BF60/20PF463	BF60/20PF483
22.0	6.0	1.5	BF60/22	BF60/22PF138	BF60/22PF438	BF60/22PF463	BF60/22PF483
25.0	7.0	1.5	BF60/25	BF60/25PF138	BF60/25PF438	BF60/25PF463	BF60/25PF483
28.0	8.0	1.5	BF60/28	BF60/28PF138	BF60/28PF438	BF60/28PF463	BF60/28PF483
30.0	9.0	1.5	BF60/30	BF60/30PF138	BF60/30PF438	BF60/30PF463	BF60/30PF483
32.0	10.0	1.5	BF60/32	BF60/32PF138	BF60/32PF438	BF60/32PF463	BF60/32PF483
34.0	10.2	1.5	BF60/34	BF60/34PF138	BF60/34PF438	BF60/34PF463	BF60/34PF483
35.0	11.0	1.5	BF60/35	BF60/35PF138	BF60/35PF438	BF60/35PF463	BF60/35PF483
36.0	11.2	1.5	BF60/36	BF60/36PF138	BF60/36PF438	BF60/36PF463	BF60/36PF483
38.0	11.5	1.5	BF60/38	BF60/38PF138	BF60/38PF438	BF60/38PF463	BF60/38PF483
40.0	12.0	1.5	BF60/40	BF60/40PF138	BF60/40PF438	BF60/40PF463	BF60/40PF483
42.0	13.0	1.5	BF60/42	BF60/42PF138	BF60/42PF438	BF60/42PF463	BF60/42PF483
45.0	14.0	1.5	BF60/45	BF60/45PF138	BF60/45PF438	BF60/45PF463	BF60/45PF483
48.0	15.0	1.5	BF60/48	BF60/48PF138	BF60/48PF438	BF60/48PF463	BF60/48PF483
50.0	16.0	1.5	BF60/50	BF60/50PF138	BF60/50PF438	BF60/50PF463	BF60/50PF483
55.0	17.5	1.5	BF60/55				
60.0	20.0	1.5	BF60/60				
65.0	22.5	1.5	BF60/65				
70.0	25.0	1.5	BF60/70				
90.0	35.0	1.5	BF60/90				

BF60

Einfassgarnitur für Textilbänder bis 1,5 mm Stärke, geeignet zum Einfassen enger Kurven, bestehend aus: Bändeinfasser, Stichplatte, Transporteur, Ausgleichsgelenkfuß. Geeignet für Schnellnäher mit standardisierter Nähgarnitur.

Binder set for fabric tapes up to 1,5 mm thickness, suitable for binding sharp curves, consisting of: binder, needle plate, feed dog, compensating foot. Suitable for standard lockstitch machines.

BF60PF138

Einfassgarnitur wie unter BF60 beschrieben, jedoch geeignet für Pfaff Kl. 138, 238.

Binder set as described under BF60, but suitable for Pfaff Cl. 138, 238.

BF60PF438

Einfassgarnitur wie unter BF60 beschrieben, jedoch geeignet für Pfaff Kl. 438.

Binder set as described under BF60, but suitable for Pfaff Cl. 438.

BF60PF463*

Einfassgarnitur wie unter BF60 beschrieben, jedoch geeignet für Pfaff Kl. 463 mit Fadenabschneider.

Binder set as described under BF60, but suitable for Pfaff Cl. 463 with thread cutter.

BF60PF483

Einfassgarnitur wie unter BF60 beschrieben, jedoch geeignet für Pfaff Kl. 483.

Binder set as described under BF60, but suitable for Pfaff Cl. 483.

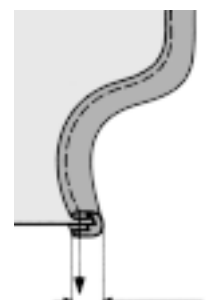
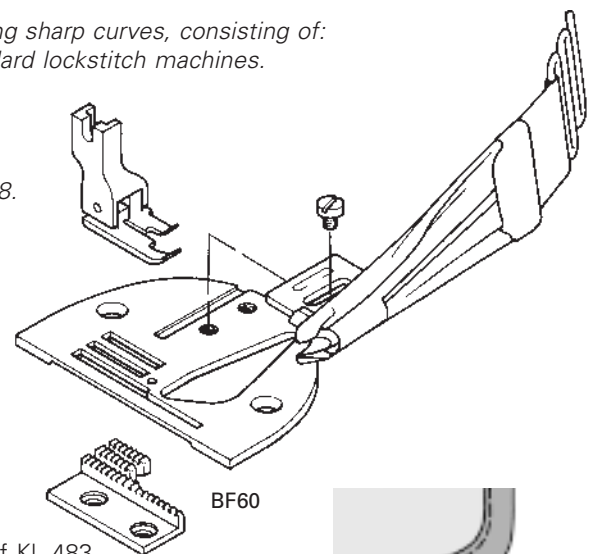

Geeignete Nähwerkzeuge finden Sie unter:
For suitable sewing parts please refer to:

Apparatefüße: Kap.1.1 Seite 22-24
Attachment feet: Kap.1.1 Seite 22-24

Die Apparate der Baureihe BF60 sind optional auch in den Ausführungen MH, H und HX lieferbar.

Binders style BF60 are also available in MH, H and HX version on request.

Schrägbandeinfasser mit doppeltem Umbug Bias Tape Binder with double fold

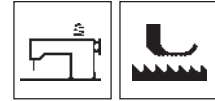

Bandbreite Tape Width in mm	Fertigbreite Finished Size in mm	Bandstärke Tape Width in mm	BF60PF467	BF60PF487
18.0	4.5	1.2		BF60/18PF487
20.0	5.0	1.5		BF60/20PF487
22.0	6.0	1.5	BF60/22PF467	BF60/22PF487
25.0	7.0	1.5	BF60/25PF467	BF60/25PF487
28.0	8.0	1.5		BF60/28PF487
30.0	9.0	1.5	BF60/30PF467	BF60/30PF487
32.0	10.0	1.5	BF60/32PF467	BF60/32PF487
35.0	11.0	1.5	BF60/35PF467	BF60/35PF487
40.0	12.0	1.5	BF60/40PF467	BF60/40PF487
45.0	14.0	1.5	BF60/45PF467	BF60/45PF487

BF60PF467

Einfassgarnitur für Textilbänder bis 1,5 mm Stärke, geeignet zum Einfassen enger Kurven, mit verstellbaren Umbügfürührungen, bestehend aus: Einfasser, Stichplatte, Transporteur, Presserfuß, Transportfuß.

Geeignet für Pfaff Kl. 467

Binder set for fabric tapes up to 1,5 mm thickness, suitable for binding sharp curves, with adjustable folding guides, consisting of: binder, needle plate, feed dog, presser foot, feed foot. Suitable for Pfaff Cl. 467.

BF60PF487

Einfassgarnitur wie unter BF60PF467 beschrieben, jedoch geeignet für Pfaff Kl. 487.

Binder set as described under BF60PF467, but suitable for Pfaff Cl. 487.

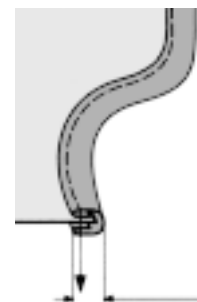
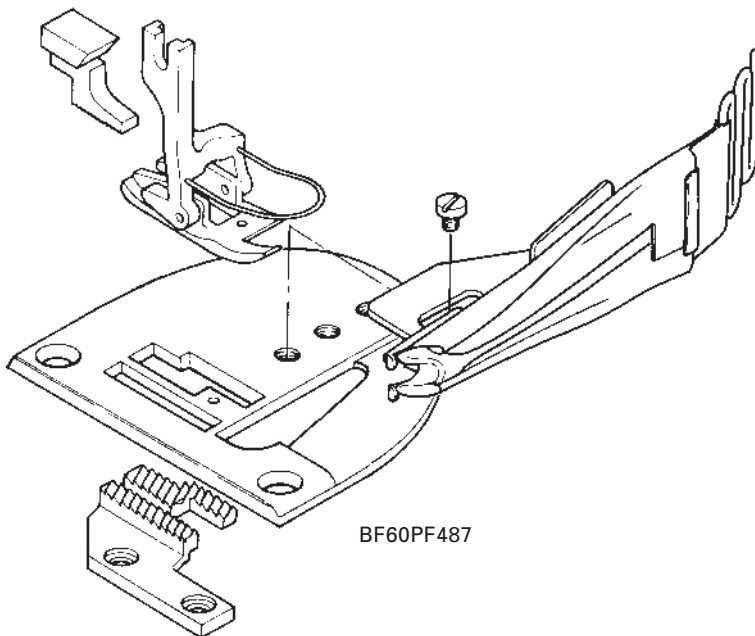

Anwendungsbeispiele für verstellbare Umbügfürührung.
Application examples for adjustable folding guides.

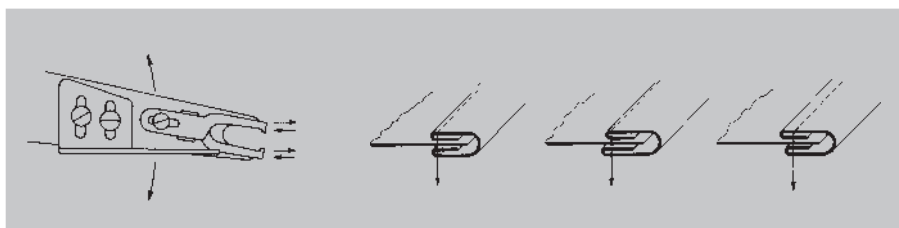

Schrägbandeinfasser mit doppeltem Umbug
Bias Tape Binder with double fold

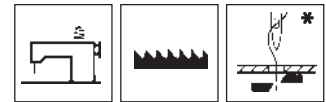

Bandbreite Tape Size in mm	Fertigbreite Finished Size in mm	Bandstärke Tape Width in mm	BF60DU211*	BF60DU265	BF60NE720	BF60NE885*
14	3.0	1.0	BF60/14DU211	BF60/14DU265	BF60/14NE720	BF60/14NE885
16	4.0	1.2	BF60/16DU211	BF60/16DU265	BF60/16NE720	BF60/16NE885
18	4.5	1.2	BF60/18DU211	BF60/18DU265	BF60/18NE720	BF60/18NE885
19	4.7	1.5	BF60/19DU211	BF60/19DU265	BF60/19NE720	BF60/19NE885
20	5.0	1.5	BF60/20DU211	BF60/20DU265	BF60/20NE720	BF60/20NE885
22	6.0	1.5	BF60/22DU211	BF60/22DU265	BF60/22NE720	BF60/22NE885
25	7.0	1.5	BF60/25DU211	BF60/25DU265	BF60/25NE720	BF60/25NE885
28	8.0	1.5	BF60/28DU211	BF60/28DU265	BF60/28NE720	BF60/28NE885
30	9.0	1.5	BF60/30DU211	BF60/30DU265	BF60/30NE720	BF60/30NE885
32	10.0	1.5	BF60/32DU211	BF60/32DU265	BF60/32NE720	BF60/32NE885
34	10.2	1.5	BF60/34DU211	BF60/34DU265	BF60/34NE720	BF60/34NE885
35	11.0	1.5	BF60/35DU211	BF60/35DU265	BF60/35NE720	BF60/35NE885
36	11.2	1.5	BF60/36DU211	BF60/36DU265	BF60/36NE720	BF60/36NE885
38	11.5	1.5	BF60/38DU211	BF60/38DU265	BF60/38NE720	BF60/38NE885
40	12.0	1.5	BF60/40DU211	BF60/40DU265	BF60/40NE720	BF60/40NE885
42	13.0	1.5	BF60/42DU211	BF60/42DU265	BF60/42NE720	BF60/42NE885
45	14.0	1.5	BF60/45DU211	BF60/45DU265	BF60/45NE720	BF60/45NE885
48	15.0	1.5	BF60/48DU211	BF60/48DU265	BF60/48NE720	BF60/48NE885
50	16.0	1.5	BF60/50DU211	BF60/50DU265	BF60/50NE720	BF60/50NE885

BF60DU211*

Einfassgarnitur für Textilbänder bis 1,5 mm Stärke, geeignet zum Einfassen enger Kurven, bestehend aus: Bändeinfasser, Stichplatte, Transporteur, Ausgleichsgelenkfuß. Geeignet für Dürkopp Kl. 211 mit Fadenabschneider.
Binder set for fabric tapes up to 1,5 mm thickness, suitable for binding sharp curves, consisting of: binder, needle plate, feed dog, compensating foot. Suitable for Dürkopp Cl. 211 with thread cutter.

BF60DU265

Einfassgarnitur wie unter BF60DU211 beschrieben, jedoch geeignet für Dürkopp Kl. 265.
Binder set as described under BF60DU211, but suitable for Dürkopp Cl. 265

BF60NE720

Einfassgarnitur wie unter BF60DU211 beschrieben, jedoch geeignet für Necchi Kl. 720.
Binder set as described under BF60DU211, but suitable for Necchi Cl. 720

BF60NE885*

Einfassgarnitur wie unter BF60DU211 beschrieben, jedoch geeignet für Necchi Kl. 885 mit Fadenabschneider.
Binder set as described under BF60DU211, but suitable for Necchi Cl. 885 with thread cutter.

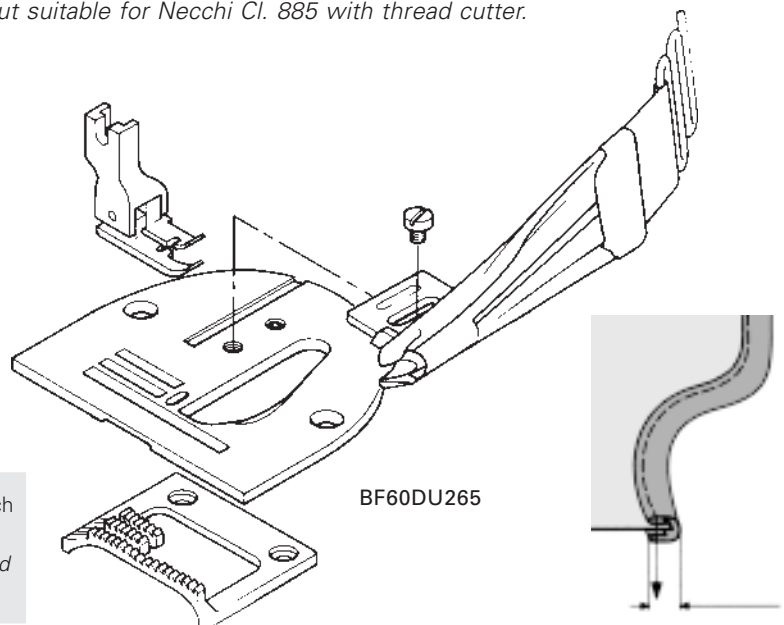

Die Apparate der Baureihe BF60 sind optional auch in den Ausführungen MH, H und HX lieferbar.
Binders style BF60 are also available in MH, H and HX version on request.

Schrägbandeinfasser mit doppeltem Umbug *Bias Tape Binder with double fold*

Bandbreite <i>Tape Size</i> <i>in mm</i>	Fertigbreite <i>Finished Size</i> <i>in mm</i>	Bandstärke <i>Tape Width</i> <i>in mm</i>	BF60B	BGA5130
14.0	3.0	1.0	BF60B/14	
16.0	4.0	1.2	BF60B/16	
18.0	4.5	1.2	BF60B/18	BGA5130B/18
19.0	4.7	1.5	BF60B/19	
20.0	5.0	1.5	BF60B/20	BGA5130B/20
22.0	6.0	1.5	BF60B/22	BGA5130B/22
25.0	7.0	1.5	BF60B/25	BGA5130B/25
28.0	8.0	1.5	BF60B/28	BGA5130B/28
30.0	9.0	1.5	BF60B/30	BGA5130B/30
32.0	10.0	1.5	BF60B/32	BGA5130B/32
35.0	11.2	1.5	BF60B/35	BGA5130B/35
36.0	11.2	1.5	BF60B/36	
38.0	11.5	1.5	BF60B/38	
40.0	12.0	1.5	BF60B/40	BGA5130B/40
42.0	13.0	1.5	BF60B/42	
45.0	14.0	1.5	BF60B/45	BGA5130B/45
48.0	15.0	1.5	BF60B/48	
50.0	16.0	1.5	BF60B/50	
55.0	17.5	1.5	BF60B/55	
60.0	20.0	1.5	BF60B/60	
65.0	22.5	1.5	BF60B/65	
70.0	25.0	1.5	BF60B/70	
90.0	35.0	1.5	BF60B/90	

BF60B

Einfasser, einzeln, passend zur Einfassgarnitur BF60
Binder, only, suitable for binder set BF60

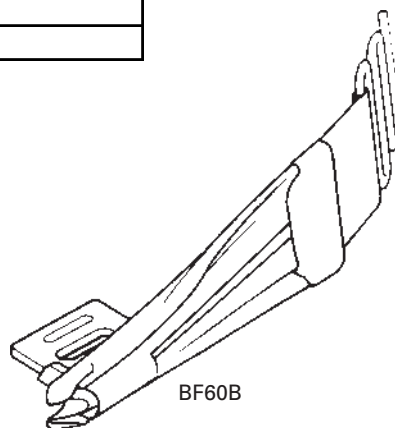

BGA5130

Einfasser mit verstellbaren Umbugführungen, einzeln,
für Einfassgarnitur BF60PF467/487.
*Binder with adjustable folding guides, only, for binder
set BF60PF467/487.*

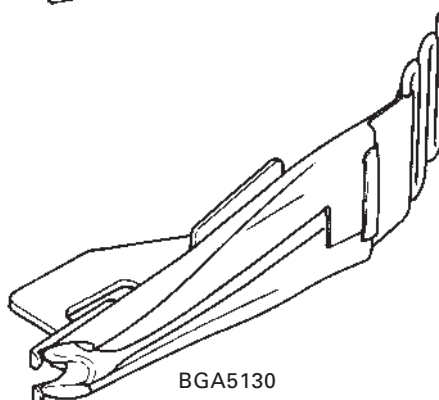

Schrägbandeinfasser mit doppeltem Umbug
Bias Tape Binder with double fold

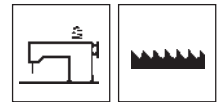

Bandbreite <i>Tape Size</i> <i>in mm</i>	Fertigbreite <i>Finished Size</i> <i>in mm</i>	Bandstärke <i>Tape Width</i> <i>in mm</i>	Gummibandbreite <i>Elastic Tape Size</i> <i>in mm</i>	BF185	BF186
22.0	5.0	1.5	4.0	BF185/22	BF186/22
25.0	5.5	1,5	4.0	BF185/25	BF186/25
28.0	6.5	1,5	6.0	BF185/28	BF186/28
30.0	7.0	1,5	6.0	BF185/30	BF186/30
32.0	7.5	1,5	7.0	BF185/32	BF186/32
35.0	10.0	1,5	8.0	BF185/35	BF186/35

BF185

Einfassgarnitur für Textilbänder bis 1,5 mm Stärke und zusätzlicher Gummibandzuführung, geeignet zum Einfassen enger Kurven, bestehend aus: Bänderfasser, Stichplatte, Transporteur, Ausgleichgelenkfuß. Passend für Schnellnäher mit standardisierten Nähwerkzeugen.

Binder set for fabric tapes up to 1,5 mm thickness and additional elastic tape insertion, suitable for binding sharp curves, consisting of: binder, needle plate, feed dog, compensating foot. Suitable for standard lockstitch machines.

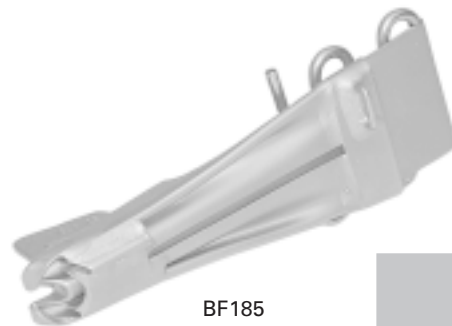

BF185

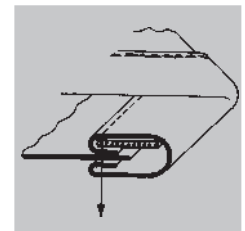

BF186

Einfassgarnitur wie unter BF185 beschrieben, jedoch mit regulierbarer Gummibandspannung.
Binder set as described under BF185, but with adjustable elastic tape guide tension.

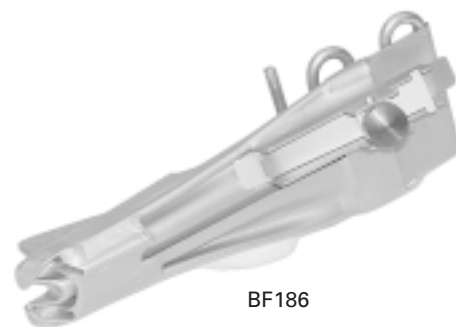

BF186

Geeignete Nähwerkzeuge finden Sie unter:
For suitable sewing parts please refer to:

Apparatefüße: Kap.1.1 Seite 22-24
Attachment feet: Kap.1.1 Seite 22-24

Lieferung erfolgt komplett mit Ausgleichgelenkfuß, Stichplatte und Transporteur.

Delivery will be effected as set with compensating foot, needle plate and feed dog.

Bandeinfasser mit doppeltem Umbug Tape Binder with double fold

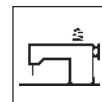

Bandbreite Tape Size in mm	Fertigbreite Finished Size in mm	BF508PL	BF508PP
19.0	5.0	BF508PL/19	BF508PP/19
22.0	5.5	BF508PL/22	BF508PP/22
25.0	6.0	BF508PL/25	BF508PP/25
26.0	6.5		BF508PP/26
28.0	7.0	BF508PL/28	BF508PP/28
30.0	8.0	BF508PL/30	
35.0	10.0	BF508PL/35	
40.0	12.0	BF508PL/40	
50.0	15.0	BF508PL/50	
60.0	18.0	BF508PL/60	

BF508PL

Einfasser für mittelschwere, steife Kunststoffbänder, geeignet für Einfassarbeiten an geraden Kanten.
Binder for medium heavy, stiff plastic tapes, suitable for straight edge binding.



BF508PL

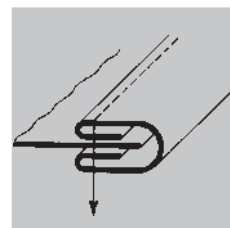

BF508PP

Einfasser für weiche Kunststoffbänder, geeignet für Einfassarbeiten an geraden Kanten und weiten Linksbögen.
Binder for soft plastic tapes, suitable for straight and left-turn binding.



BF508PP

Geeignete Nähwerkzeuge finden Sie unter:
For suitable sewing parts please refer to:

Apparatefüße: Kap.1.1 Seite 22-24
Stichplatten/Transporteure: Kap.1.1 Seite 40
Attachment feet: Kap.1.1 Seite 22-24
Needle plates / Feed dogs: Kap.1.1 Seite 40

Bandeinfasser mit doppeltem Umbug
Tape Binder with double fold



Bandbreite <i>Tape Size</i> <i>in mm</i>	Fertigbreite <i>Finished Size</i> <i>in mm</i>	SUISEI A5BS	BF50
26.0	8.0	BA-1316s	
30.0	10.0	BA-1317s	
35.0	12.0		BF50/35
36.0	14.0	BA-1318s	
40.0	14.0		BF50/40
45.0	15.0	BA-1319s	
45.0	16.0		BF50/45
50.0	18.0		BF50/50
52.0	18.0	BA-1320s	
55.0	20.0		BF50/55
58.0	20.0	BA-1321s	
58.0	21.0		BF50/58
60.0	22.0		BF50/60
65.0	24.0		BF50/65
70.0	24.0	BA-1323s	
70.0	26.0		BF50/70
75.0	28.0		BF50/75
80.0	30.0		BF50/80
85.0	32.0		BF50/85
90.0	35.0		BF50/90
95.0	37.0		BF50/95
100.0	40.0		BF50/100
105.0	42.0		BF50/105
110.0	45.0		BF50/110
120.0	50.0		BF50/120

SUISEI A5BS

Einfasser für leichte bis mittlere Textilbänder, geeignet für Einfassarbeiten an geraden Kanten, sowie Gürtelherstellung.
Binder for light up to medium fabric tapes, suitable for straight binding and for belt production.

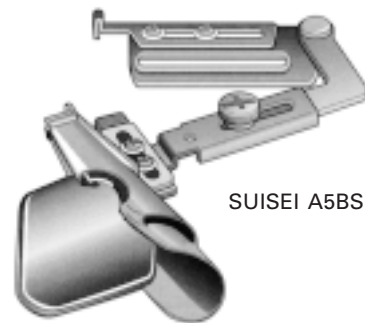

SUISEI A5BS

BF50

Einfasser für mittlere bis mittelschwere Textilbänder, geeignet für Einfassarbeiten an geraden Kanten mittleren Materials.
Binder for medium up to medium-heavy fabric tapes, suitable for straight binding of medium material.

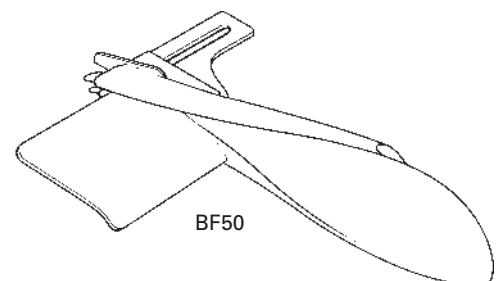

BF50

Geeignete Nähwerkzeuge finden Sie unter:
For suitable sewing parts please refer to:

Apparatefüße: Kap.1.1 Seite 22-24
Stichplatten/Transporteure: Kap.1.1 Seite 40
Attachment feet: Kap.1.1 Seite 22-24
Needle plates / Feed dogs: Kap.1.1 Seite 40

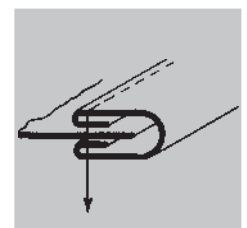

Bandeinfasser mit doppeltem Umbug Tape Binder with double fold

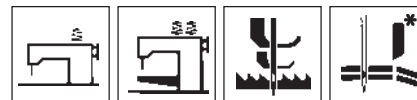

Bandbreite Tape Width in mm	Fertigbreite Finished Size in mm	Materialstärke Material Size in mm	Bandstärke Tape Size in mm	BF29002 (95°)	BF34002 (115°)	BF704*
20.0	5.0	4.0		BF29002/20x4	BF34002/20x4	
22.0	5.5	6.0			BF34002/22x6	
22.0	5.5	5.0			BF34002/22x5	
22.0	6.0	4.0		BF29002/22x4	BF34002/22x4	
25.0	6.0	6.0			BF34002/25x6	
25.0	6.5	5.0			BF34002/25x5	
25.0	7.0	4.0		BF29002/25x4	BF34002/25x4	
25.0	7.0	5.0		BF29002/25x5		
26.0	7.0	6.0		BF29002/26x6		
28.0	7.0	6.0			BF34002/28x6	
28.0	7.5	5.0			BF34002/28x5	
28.0	8.0	4.0		BF29002/28x4	BF34002/28x4	
28.0	8.0	6.0		BF29002/28x6		
30.0	8.5	5.0			BF34002/30x5	
30.0	8.5	6.0			BF34002/30x6	
30.0	9.0	4.0		BF29002/30x4	BF34002/30x4	
30.0	9.0	6.0		BF29002/30x6		
32.0	9.0	5.0			BF34002/32x5	
35.0	10.0		1.5			BF704/34
35.0	10.5	6.0			BF34002/35x6	
35.0	10.5	7.0			BF34002/35x7	
35.0	11.0	5.0		BF29002/35x5	BF34002/35x5	
35.0	11.0	7.0		BF29002/35x7		
38.0	12.0		1.7			BF704/38
40.0	11.5	7.0			BF34002/40x7	
40.0	11.5	8.0			BF34002/40x8	
40.0	12.5	5.0			BF34002/40x5	
40.0	13.0		2.0			BF704/40
40.0	13.0	7.0		BF29002/40x7		
42.0	14.0		2.0			BF704/42
45.0	16.0		2.0			BF704/45
48.0	17.0		2.0			BF704/48
50.0	18.0		2.0			BF704/50
55.0	21.0		2.0			BF704/55
65.0	26.0		2.0			BF704/65

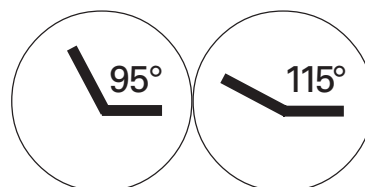

Geeignete Nähwerkzeuge finden Sie unter:
For suitable sewing parts please refer to:

Apparatefüße: Kap.1.5
Stichplatten/Transporteure: Kap.1.5
Attachment feet: Kap.1.5
Needle plates / Feed dogs: Kap.1.5

Fortsetzung siehe nächste Seite
To be continued next page

Bandeinfasser mit doppeltem Umbug
Tape Binder with double fold

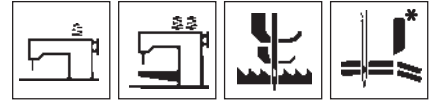

BF29002 (95°)

Einfasser für Dreifach-Transport-Maschinen, geeignet für Einfassarbeiten an mittelschwerer Ware mit weichen Bändern zur Montage auf mitgehendem Apparateträger.

Binder for unison feed machines, suitable for binding medium-heavy materials with soft tapes, to be fixed at synchronized moving attachment bracket.

BF34002 (115°)

Einfasser wie unter BF29002 beschrieben, jedoch für steife Bänder.

Binder set as described under BF29002, but for stiff tapes.

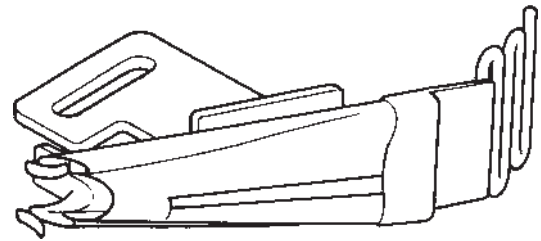

BF34002

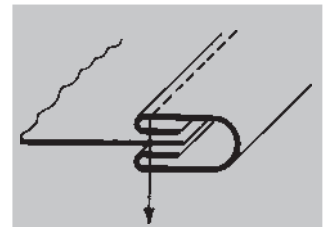

BF704*

Einfasser für Pfaff/Adler Dreifach-Transport-Maschinen mit Kantenbeschneidung, geeignet für Einfassarbeiten an mittelschwerer Ware mit weichen Bändern.

Binder for Pfaff/Adler unison feed machines with edge cutter, suitable for binding medium-heavy materials with soft tapes.

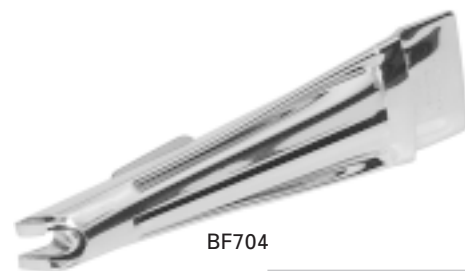

BF704

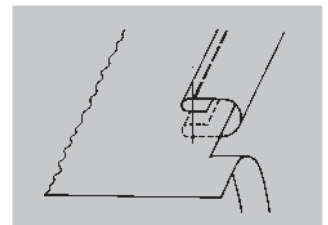

Bandeinfasser mit doppeltem Umbug Tape Binder with double fold



BA-1559

Einfasshülse geeignet für Dreifach-Transport-Maschinen, zur Montage auf mitgehendem Apparaträger
Binder for unison feed machines to be fixed at synchronized moving bracket

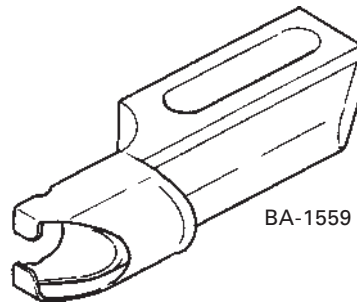

BA-1559

BA-1559-75

wie BA-1559 jedoch für steife Bänder geeignet
as described under BA-1559, but suitable for stiff tapes

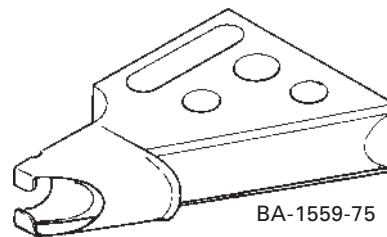

BA-1559-75

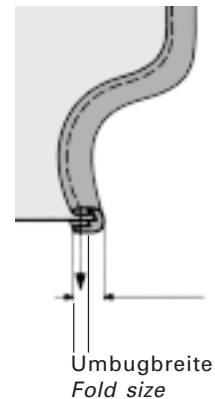

Umbugbreite
Fold size

Bei Bestellung von Einfasshülsen sind Angaben zur Maschinenklasse, Bandbreite, Materialstärke, Bandstärke und Umbugbreite erforderlich.

To order the binder please always indicate machine class, tape width, material thickness, tape thickness and fold size.

Fabrikat: Brand:	Maschinenklasse Machine class						
PFAFF	145	335	545	1245			
ADLER	67	69	167	169	267	467	767
NECCHI	840	902	958				

Benötigte Bestellangaben Necessary order details	Standardmaße (andere Abmessungen optional) Standard sizes (other sizes on request)								
Bandbreite/Tape size (mm)	12.0	14.0	16.0	18.0	20.0	22.0	25.0	28.0	30.0
Bandstärke/Tape thickness (mm)	0.8	1.0	1.2	1.5	1.8	2.0			
Materialstärke/Material thickness (mm)	4.0	4.5	5.0	5.5	6.0	7.0	8.0		
Umbugbreite/Fold size (mm)	3.0	4.0	5.0	6.0					

Geeignete Nähwerkzeuge finden Sie unter:
For suitable sewing parts please refer to:

Apparatefüße: Kap.1.5
Stichplatten/Transporteure: Kap.1.5
Attachment feet: Kap.1.5
Needle plates / Feed dogs: Kap.1.5

Bundapparate
Waistband Attachment

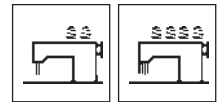

Bandbreite Tape Size in mm	Fertigbreite Finished Size in mm	BF31001
60.0	21.0	BF31001/60L
60.0	21.0	BF31001/60
60.0	21.0	BF31001/60H
70.0	25.0	BF31001/70L
70.0	25.0	BF31001/70
70.0	25.0	BF31001/70MH
75.0	27.0	BF31001/75L
75.0	27.0	BF31001/75
80.0	28.0	BF31001/80L
80.0	28.0	BF31001/80
80.0	28.0	BF31001/80MH
80.0	28.0	BF31001/80H
85.0	30.0	BF31001/85L
85.0	30.0	BF31001/85
85.0	30.0	BF31001/85MH
85.0	30.0	BF31001/85H
90.0	32.0	BF31001/90L
90.0	32.0	BF31001/90
90.0	32.0	BF31001/90MH
90.0	32.0	BF31001/90H
90.0	32.0	BF31001/90XH*
95.0	36.0	BF31001/95L
95.0	36.0	BF31001/95
95.0	36.0	BF31001/95MH
95.0	36.0	BF31001/95H
100.0	39.0	BF31001/100L
100.0	39.0	BF31001/100
100.0	39.0	BF31001/100MH
100.0	39.0	BF31001/100H
105.0	43.0	BF31001/105L
105.0	43.0	BF31001/105
105.0	43.0	BF31001/105MH
105.0	43.0	BF31001/105H
110.0	45.0	BF31001/110L
110.0	45.0	BF31001/110
110.0	45.0	BF31001/110MH
110.0	45.0	BF31001/110H
120.0	47.0	BF31001/120
120.0	47.0	BF31001/120H
120.0	47.0	BF31001/120XH*
130.0	50.0	BF31001/130
130.0	50.0	BF31001/130H
140.0	53.0	BF31001/140
140.0	53.0	BF31001/140H

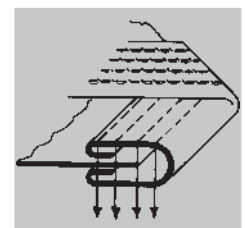
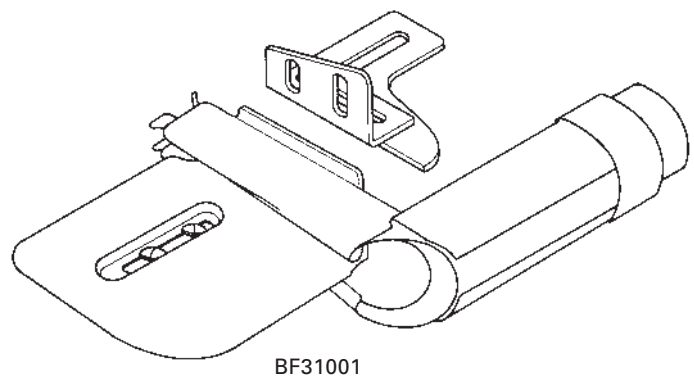

BF31001

Rechtwinkliger Bundapparat für Bundarbeiten an Hosen, Röcken, etc. in sämtlichen Materialstärken, sowie für die Fertigung von Gürteln und Hosenträgern.

Elbow Binder for waist band works at trousers, skirts, etc., as well as for production of belts and braces.

Available for all kind of material thickness.

*Durchgangshöhe XH wird speziell für Frotteewaren empfohlen. Geeignet für Zwei- und Viernadel-Flachbettmaschinen.

**XH-version especially recommended for bathing-wrap. Suitable for double- and four-needle-flatbed machines.*

Bundapparate Waistband Attachment

Bandbreite Tape Size in mm	Fertigbreite Finished Size in mm	BF1245
38.0	22.0	BF1245/38
52.0	30.0	BF1245/52
58.0	36.0	BF1245/58
65.0	43.0	BF1245/65

BF1245

Apparat für die Bundherstellung aus zwei Bändern mit mittlerer Stärke, geeignet für Zwei- und Viernadel-Flachbettmaschinen.

Folder for waist band works with two continuous tapes of medium thickness, suitable for double- and four-needle flatbed machines.

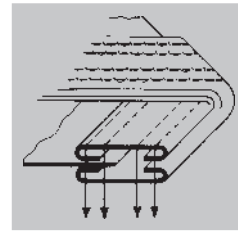
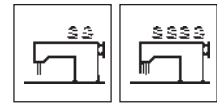
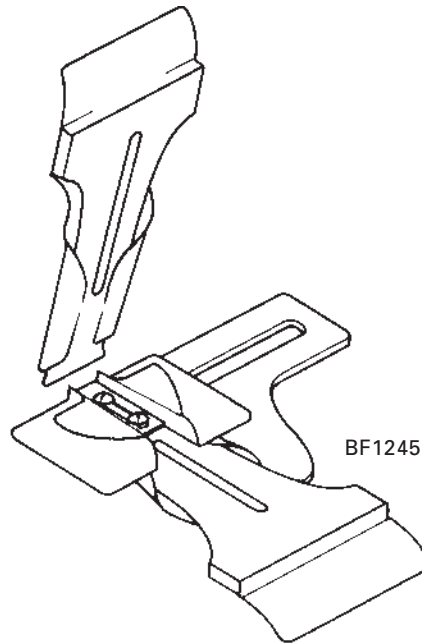

Bundapparate Waistband Attachment

Bandbreite Tape Size in mm	Fertigbreite Finished Size in mm	Gummibandbreite Elastic Tape Width in mm	BF1295	BF1296
90.0	32.0	30.0	BF1295/90x32	BF1296/90x32
120.0	42.0	40.0	BF1295/120x42	BF1296/120x42

BF1295

Apparat für die Elastikbuntherstellung auf Vier-Nadel-Maschinen mit Umbug oben, insbesondere für die Herstellung von Sporthosen mit eingearbeitetem Netzslip. Die Netzware kann in einem zweiten Arbeitsgang auf einer Overlock-Maschine am Bandvorstoß angenäht werden.

Binder with upper fold for production of elastic waist band on four-needle machines, especially recommended for sport shorts with net pants. The net material can be applied on the tape edge inside by a simple overlock operation, suitable for four-needle-machines.

BF1296

Apparat wie unter F1295 beschrieben, jedoch mit doppeltem Umbug für geschlossenen Elastikbund.

Binder as described under F1295, but with double fold for closed elastic waist band.

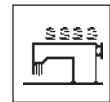

BF1295

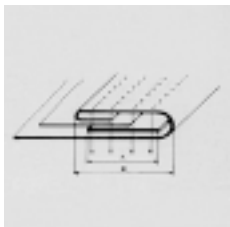

BF1296

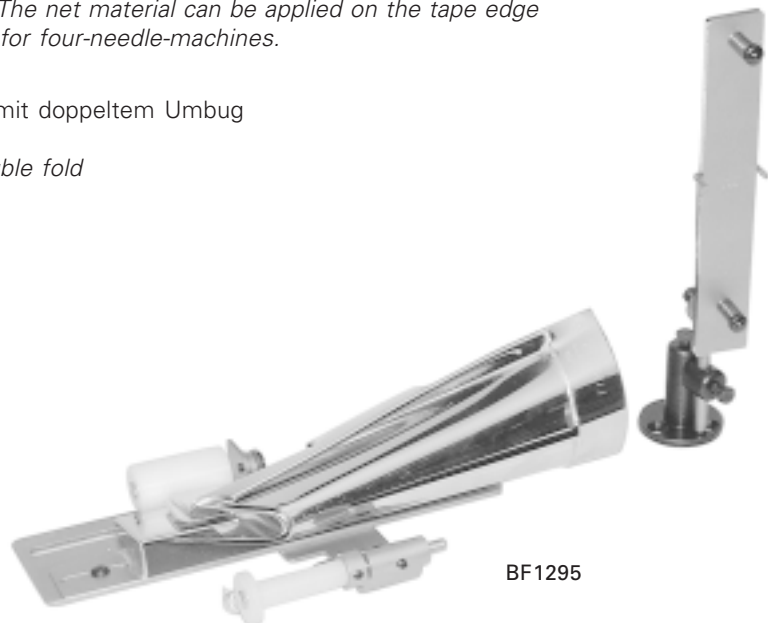
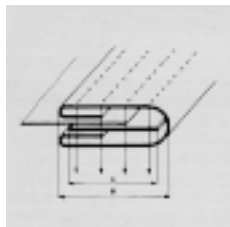

BF1295

Gürtelapparate
Belt Folder



Bandbreite Tape Size in mm	Fertigbreite Finished Size in mm	SUISEI A5S
18.0	5.0	BA-1300s
26.0	8.0	BA-1301s
30.0	10.0	BA-1302s
36.0	12.0	BA-1303s
45.0	15.0	BA-1304s
52.0	18.0	BA-1305s
58.0	20.0	BA-1306s
70.0	24.0	BA-1308s
82.0	30.0	BA-1309s
105.0	40.0	BA-1310s

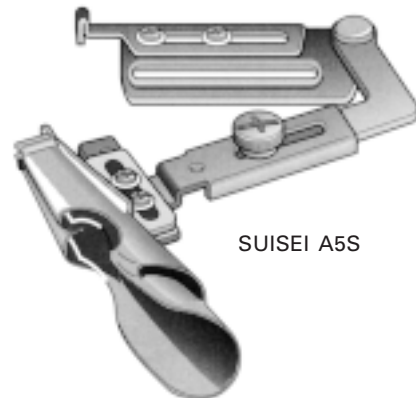

SUISEI A5S



SUISEI A5S

Apparat zur Herstellung von Gürteln bzw. Schlaufen.
Folder for belt and loop production.

Geeignete Nähwerkzeuge finden Sie unter:
For suitable sewing parts please refer to:

Apparatfüße:	Kap.1a	Seite ??
Stichplatten/Transporteure:	Kap.1a	Seite ??
Attachment feet:	Kap.1a	Seite ??
Needle plates / Feed dogs:	Kap.1a	Seite ??

Bandeinfasser mit Umbug oben
Tape Binder with upper fold



Bandbreite Tape Size in mm	Fertigbreite Finished Size in mm	BF2	SUISEI A2S
16.0	5.5	BF2/16	
18.0	6.0	BF2/18	
20.0	5.0		BA-1278s
20.0	7.0	BF2/20	
22.0	5.5		BA-1279s
22.0	8.0	BF2/22	
24.0	6.0		BA-1280s
24.0	9.0	BF2/24	
26.0	10.0	BF2/26	
28.0	11.0	BF2/28	
30.0	12.0	BF2/30	

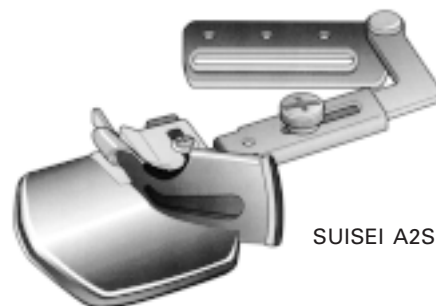

SUISEI A2S

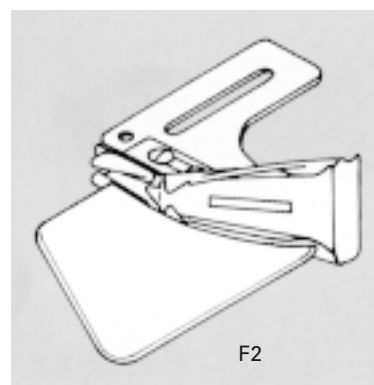

F2



SUISEI A2S

Einfasser für Textilbänder, ausschwenkbar, geeignet für Einfassarbeiten an geraden Kanten bzw. weiten Linksbögen.
Swing-out binder for fabric tapes, suitable for straight and left-turn binding.

BF2

Einfasser für Textilbänder, geeignet für Einfassarbeiten an geraden Kanten bzw. weiten Linksbögen.
Binder for fabric tapes, suitable for straight and left-turn binding.

Geeignete Nähwerkzeuge finden Sie unter:
For suitable sewing parts please refer to:

Apparatfüße:	Kap.1.1	Seite 22-24
Stichplatten/Transporteure:	Kap.1.1	Seite 40
Attachment feet:	Kap.1.1	Seite 22-24
Needle plates / Feed dogs:	Kap.1.1	Seite 40

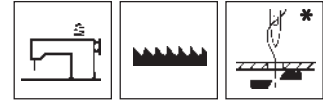
Bandeinfasser mit Umbug oben
Tape Binder with upper fold

Bandbreite Tape Size in mm	Fertigbreite Finished Size in mm	Bandstärke Tape Width in mm	BF62	BF62PF138	BF62PF438	BF62PF463*	BF62PF483
14.0	3.5	1.3	BF62/14	BF62/14PF138	BF62/14PF438	BF62/14PF463	BF62/14PF483
16.0	5.0	1.3	BF62/16	BF62/16PF138	BF62/16PF438	BF62/16PF463	BF62/16PF483
19.0	7.0	1.3	BF62/19	BF62/19PF138	BF62/19PF438	BF62/19PF463	BF62/19PF483
20.0	7.5	1.5	BF62/20	BF62/20PF138	BF62/20PF438	BF62/20PF463	BF62/20PF483
22.0	9.0	1.5	BF62/22	BF62/22PF138	BF62/22PF438	BF62/22PF463	BF62/22PF483
25.0	11.0	1.5	BF62/25	BF62/25PF138	BF62/25PF438	BF62/25PF463	BF62/25PF483
28.0	12.0	1.5	BF62/28	BF62/28PF138	BF62/28PF438	BF62/28PF463	BF62/28PF483
30.0	13.0	1.5	BF62/30	BF62/30PF138	BF62/30PF438	BF62/30PF463	BF62/30PF483
32.0	14.0	1.5	BF62/32	BF62/32PF138	BF62/32PF438	BF62/32PF463	BF62/32PF483
35.0	15.0	1.5	BF62/35	BF62/35PF138	BF62/35PF438	BF62/35PF463	BF62/35PF483
38.0	17.0	1.5	BF62/38	BF62/38PF138	BF62/38PF438	BF62/38PF463	BF62/38PF483

BF62

Einfassgarnitur für Textilbänder bis 1,5 mm Stärke, geeignet zum Einfassen enger Kurven, bestehend aus: Bandeinfasser, Stichplatte, Transporteur, Ausgleichsgelenkfuß, geeignet für Schnellnäher mit standardisierten Nähwerkzeugen.

Binder set for fabric tapes up to 1,5 mm thickness, suitable for binding sharp curves, consisting of: binder, needle plate, feed dog, compensating foot, suitable for standard lockstitch machines.

BF62PF138

Einfassgarnitur wie unter BF62 beschrieben, jedoch geeignet für Pfaff Kl. 138, 238
Binder set as described under BF62, but suitable for Pfaff Cl. 138, 238

BF62PF438

Einfassgarnitur wie unter BF62 beschrieben, jedoch geeignet für Pfaff Kl. 438
Binder set as described under BF62, but suitable for Pfaff Cl. 438

BF62PF463*

Einfassergarnitur wie unter BF62 beschrieben, jedoch geeignet für Pfaff Kl. 463
Binder set as described under BF62, but suitable for Pfaff Cl. 463

BF62PF483

Einfassgarnitur wie unter BF62 beschrieben, jedoch geeignet für Pfaff Kl. 483
Binder set as described under BF62, but suitable for Pfaff Cl. 483

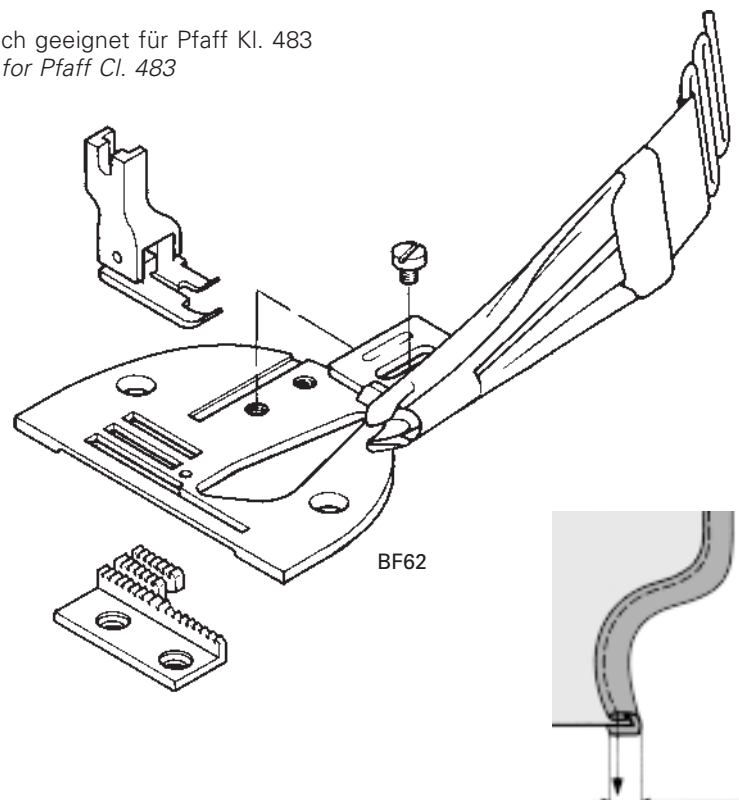

Geeignete Nähwerkzeuge finden Sie unter:
For suitable sewing parts please refer to:

Apparatefüße: Kap.1.1 Seite 22-24
Attachment feet: Kap.1.1 Seite 22-24

Bandeinfasser mit Umbug oben
Tape Binder with upper fold

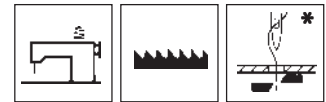

Bandbreite <i>Tape Size</i> <i>in mm</i>	Fertigbreite <i>Finished Size</i> <i>in mm</i>	Bandstärke <i>Tape Width</i> <i>in mm</i>	BF62DU211*	BF62DU265	BF62NE720	BF62NE885*
14.0	3.5	1.3	BF62/14DU211	BF62/14DU265	BF62/14NE720	BF62/14NE885
16.0	5.0	1.3	BF62/16DU211	BF62/16DU265	BF62/16NE720	BF62/16NE885
19.0	7.0	1.3	BF62/19DU211	BF62/19DU265	BF62/19NE720	BF62/19NE885
20.0	7.5	1.5	BF62/20DU211	BF62/20DU265	BF62/20NE720	BF62/20NE885
22.0	9.0	1.5	BF62/22DU211	BF62/22DU265	BF62/22NE720	BF62/22NE885
25.0	11.0	1.5	BF62/25DU211	BF62/25DU265	BF62/25NE720	BF62/25NE885
28.0	12.0	1.5	BF62/28DU211	BF62/28DU265	BF62/28NE720	BF62/28NE885
30.0	13.0	1.5	BF62/30DU211	BF62/30DU265	BF62/30NE720	BF62/30NE885
32.0	14.0	1.5	BF62/32DU211	BF62/32DU265	BF62/32NE720	BF62/32NE885
35.0	15.0	1.5	BF62/35DU211	BF62/35DU265	BF62/35NE720	BF62/35NE885
38.0	17.0	1.5	BF62/38DU211	BF62/38DU265	BF62/38NE720	BF62/38NE885

BF62DU211*

Einfassgarnitur für Textilbänder bis 1,5 mm Stärke, geeignet zum Einfassen enger Kurven, bestehend aus: Bandeinfasser, Stichplatte, Transporteur, Ausgleichgelenkfuß. Geeignet für Dürkopp Kl. 211 mit Fadenabschneider.
Binder set for fabric tapes up to 1,5 mm thickness, suitable for binding sharp curves, consisting of: binder, needle plate, feed dog, compensating foot. Suitable for Dürkopp Cl. 211 with thread cutter.

BF62DU265

Einfassgarnitur wie unter BF62DU211 beschrieben, jedoch geeignet für Dürkopp Kl. 265.
Binder set as described under BF62DU211, but suitable for Dürkopp Cl. 265.

BF62NE720

Einfassgarnitur wie unter BF62DU211 beschrieben, jedoch geeignet für Necchi Kl. 720.
Binder set as described under BF62DU211, but suitable for Necchi Cl. 720.

BF62NE885*

Einfassgarnitur wie unter BF62DU211 beschrieben, jedoch geeignet für Necchi Kl. 885 mit Fadenabschneider.
Binder set as described under BF62DU211, but suitable for Necchi Cl. 885 with thread cutter.

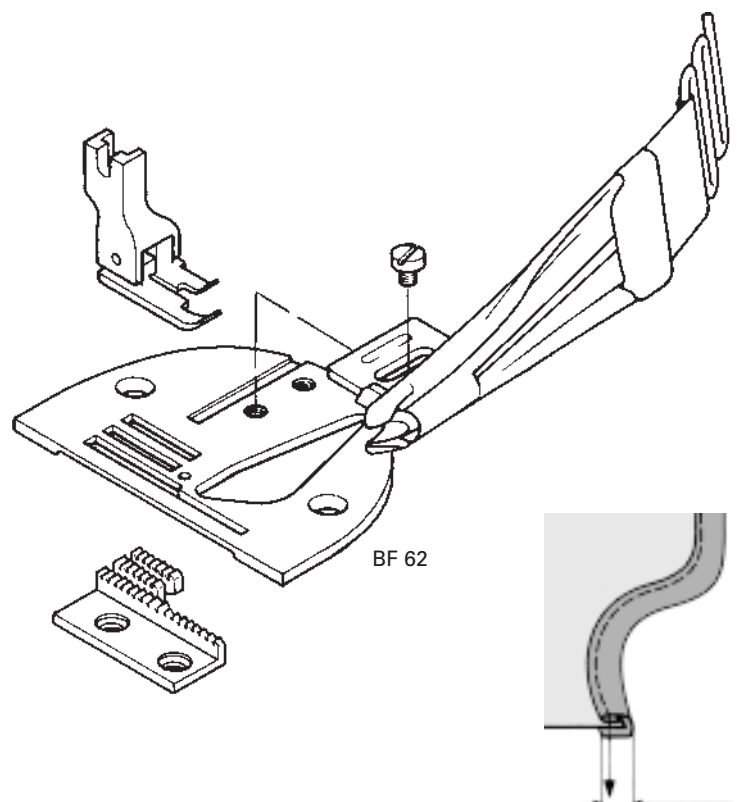

Geeignete Nähwerkzeuge finden Sie unter:
For suitable sewing parts please refer to:

Apparatefüße: Kap.1.1 Seite 22-24
Attachment feet: Kap.1.1 Seite 22-24

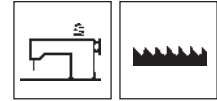
Bandeinfasser mit Umbug oben
Tape Binder with upper fold

Bandbreite <i>Tape Size</i> <i>in mm</i>	Fertigbreite <i>Finished Size</i> <i>in mm</i>	Bandstärke <i>Tape Width</i> <i>in mm</i>	BF62B
14.0	3.5	1.3	BF62B/14
16.0	5.0	1.3	BF62B/16
19.0	7.0	1.3	BF62B/19
20.0	7.5	1.5	BF62B/20
22.0	9.0	1.5	BF62B/22
25.0	11.0	1.5	BF62B/25
28.0	12.0	1.5	BF62B/28
30.0	13.0	1.5	BF62B/30
32.0	14.0	1.5	BF62B/32
35.0	15.0	1.5	BF62B/35
38.0	17.0	1.5	BF62B/38

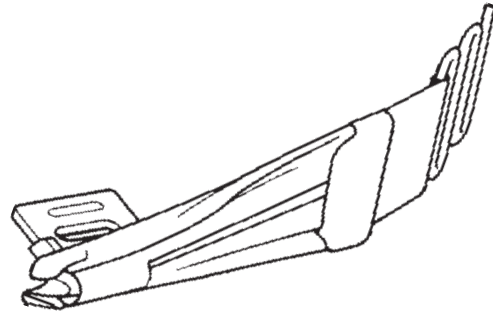
**BF62B**

Einfasser, einzeln,
passend zur Einfassgarnitur BF62
Binder, only, suitable for binder set BF62

Bandeinfasser mit Umbug oben
Tape Binder with upper fold

Bandbreite <i>Tape Size</i> <i>in mm</i>	Fertigbreite <i>Finished Size</i> <i>in mm</i>	Materialstärke <i>Material Size</i> <i>in mm</i>	BF34001
20.0	7.0	4.0	BF34001/20x4
20.0	7.0	5.0	BF34001/20x5
20.0	7.0	6.0	BF34001/20x6
22.0	8.0	4.0	BF34001/22x4
22.0	8.0	5.0	BF34001/22x5
22.0	8.0	6.0	BF34001/22x6
25.0	9.0	4.0	BF34001/25x4
25.0	9.0	5.0	BF34001/25x5
25.0	9.0	6.0	BF34001/25x6
28.0	10.0	4.0	BF34001/28x4
28.0	10.0	6.0	BF34001/28x6
28.0	10.0	7.0	BF34001/28x7
30.0	11.0	4.0	BF34001/30x4
30.0	11.0	6.0	BF34001/30x6
30.0	11.0	8.0	BF34001/30x8
35.0	13.0	5.0	BF34001/35x5
35.0	13.0	6.0	BF34001/35x6
35.0	13.0	8.0	BF34001/35x8

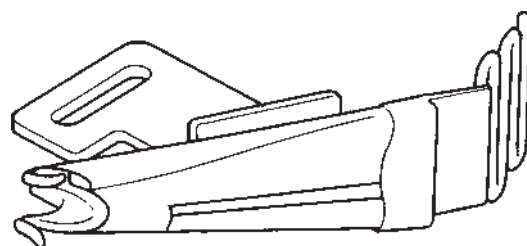

BF34001

BF34001

Einfasser für Dreifach-Transport-Maschinen, geeignet für Einfassarbeiten mit steifen Bändern an mittelschwerer Ware, zur Montage auf mitgehendem Apparateträger.

Binder for unison-feed machines, suitable for binding medium heavy materials with stiff tapes, to be fixed at synchronized moving attachment bracket.

Geeignete Nähwerkzeuge finden Sie unter:
For suitable sewing parts please refer to:

Apparatefüße: Kap.1.5
Attachment feet: Kap.1.5

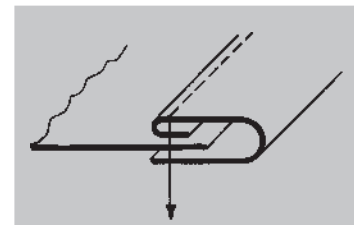

Bandeinfasser mit Umbug oben
Tape Binder with upper fold

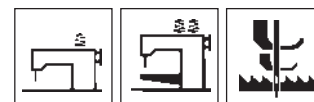

BA-1557

Einfasshülse geeignet für Dreifach-Transport-Maschinen, mit Umbug oben, zur Montage auf mitgehendem Apparateträger
Binder with upper fold for unison-feedmachines, to be fixed at synchronized moving bracket

BA-1557-75

wie BA-1557 jedoch für steife Bänder geeignet
as described under BA-1557, but suitable for stiff tapes

BA-1558

Einfasshülse geeignet für Dreifach-Transport-Maschinen, mit Umbug oben und Einfaß unten versetzt, zur Montage auf mitgehendem Apparateträger

Binder with upper fold for unison-feed-machines and shifted bottom binding, to be fixed at synchronized moving bracket

BA-1558-75

wie BA-1558 jedoch für steife Bänder geeignet
as described under BA-1558, but suitable for stiff tapes

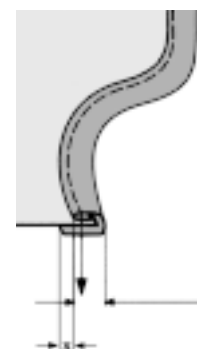
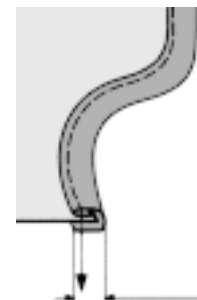

x = Überstand
x = Protruding edge

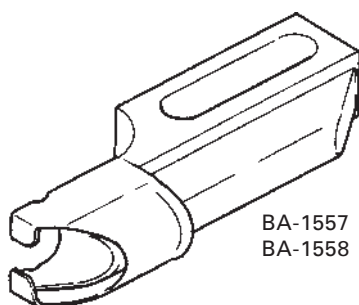

BA-1557
BA-1558

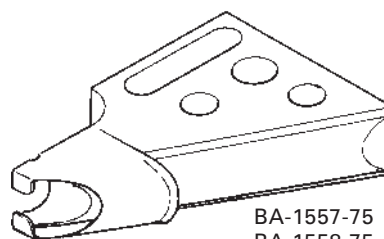

BA-1557-75
BA-1558-75

Bei Bestellung von Einfasshülsen sind Angaben zur Maschinenklasse, Bandbreite, Materialstärke, Bandstärke und Umbugbreite erforderlich

To order the binder please always indicate machine class, tape width, material thickness, tape thickness and fold size

Fabrikat: <i>Brand:</i>	Maschinenklasse <i>Machine class</i>						
PFAFF	145	335	545	1245			
ADLER	67	69	167	169	267	467	767
NECCHI	840	902	958				

Benötigte Bestellangaben <i>Necessary order details</i>	Standardmaße(andere Abmessungen optional) <i>Standard sizes (other sizes on request)</i>								
Bandbreite/Tape size (mm)	12.0	14.0	16.0	18.0	20.0	22.0	25.0	28.0	30.0
Bandstärke/Tape thickness (mm)	0.8	1.0	1.2	1.5	1.8	2.0			
Materialstärke/Material thickness (mm)	4.0	4.5	5.0	5.5	6.0	7.0	8.0		
Überstand/Protruding edge (mm) (x)	1.0	2.0	3.0	4.0					
Umbugbreite/Fold size (mm)	3.0	4.0	5.0	6.0					

(x) nur/only BA-1558 + BA-1558-75

Geeignete Nähwerkzeuge finden Sie unter:
For suitable sewing parts please refer to:

Apparatfüße: Kap.1.5
Attachment feet: Kap.1.5

Bandeinfasser ohne Umbug *Tape Binder without fold*

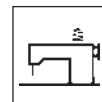

Bandbreite <i>Tape Size</i> <i>in mm</i>	Fertigbreite <i>Finished Size</i> <i>in mm</i>	SUISEI A4S
10.0	5.0	BA-1290S
13.0	6.5	BA-1291S
16.0	8.0	BA-1292S
20.0	10.0	BA-1293S
22.0	11.0	BA-1294S
25.0	12.0	BA-1295S

SUISEI A4S

Standardeinfasser für Textilbänder bis 1,5 mm Stärke, ausschwenkbar, geeignet für Einfaßarbeiten an geraden Kanten bzw. weiten Linksbögen.

Swing-out binder for fabric tapes up to 1,5 mm thickness, suitable for straight and left-turn binding.



SUISEI A4S

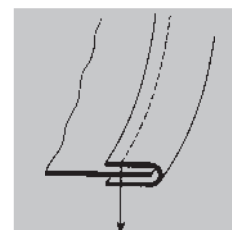

Geeignete Nähwerkzeuge finden Sie unter:
For suitable sewing parts please refer to:

Apparatefüße: Kap.1.1 Seite 22-24
Stichplatten/Transporteure: Kap.1.1 Seite 40
Attachment feet: Kap.1.1 Seite 22-24
Needle plates / Feed dogs: Kap.1.1 Seite 40

Bandeinfasser ohne Umbug
Tape Binder without fold



Bandbreite <i>Tape Size</i> <i>in mm</i>	Fertigbreite <i>Finished Size</i> <i>in mm</i>	Bandstärke <i>Tape Width</i> <i>in mm</i>	BF100	BF100 Spezial	BF100 H
10.0	5.0	1.5	BF100/10		
12.0	6.0	1.5	BF100/12		
12.0	6.0	2.0			BF100/12H
14.0	7.0	1.5	BF100/14		
14.0	7.0	2.0			BF100/14H
15.0	7.5	1.5	BF100/15		
16.0	8.0	1.5	BF100/16		
16.0	8.0	2.0			BF100/16H
17.0	8.5	1.5	BF100/17		
18.0	9.0	1.5	BF100/18		
19.0	9.5	1.5	BF100/19		
20.0	10.0	1.5	BF100/20	BF100/20Spez.	
20.0	10.0	2.0		BF100/20HSpez.	BF100/20H
22.0	11.0	1.5	BF100/22	BF100/22Spez.	
22.0	11.0	2.0		BF100/22HSpez.	BF100/22H
25.0	12.5	1.5	BF100/25	BF100/25Spez.	
28.0	14.0	1.5	BF100/28	BF100/28Spez.	
30.0	15.0	1.5	BF100/30	BF100/30Spez.	
32.0	16.0	1.5	BF100/32	BF100/32Spez.	
32.0	16.0	2.0		BF100/32HSpez.	BF100/32H
35.0	17.5	1.5	BF100/35	BF100/35Spez.	
35.0	17.5	2.0		BF100/35HSpez.	BF100/35H
40.0	20.0	1.5	BF100/40	BF100/40Spez.	
40.0	20.0	2.0		BF100/40HSpez.	BF100/40H
45.0	22.5	1.5	BF100/45	BF100/45Spez.	
45.0	22.5	2.0			BF100/45H
50.0	25.0	2.0	BF100/50	BF100/50Spez.	
50.0	25.0	3.0			BF100/50H
55.0	27.5	2.0	BF100/55	BF100/55Spez.	
60.0	30.0	2.0		BF100/60Spez.	
65.0	32.5	2.0	BF100/65		
70.0	35.0	2.0	BF100/70		

Geeignete Nähwerkzeuge finden Sie unter:
For suitable sewing parts please refer to:

Apparatefüße: Kap.1.1 Seite 22-24
Stichplatten/Transporteure: Kap.1.1 Seite 40
Attachment feet: Kap.1.1 Seite 22-24
Needle plates / Feed dogs: Kap.1.1 Seite 40

Fortsetzung siehe nächste Seite
To be continued next page

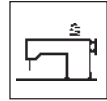
Bandeinfasser ohne Umbug
Tape Binder without fold**BF100**

Einfasser für Textilbänder bis 1,5 mm Stärke, geeignet für Einfassarbeiten an geraden Kanten bzw. weiten Linksbögen.

Binder for fabric tapes up to 1,5 mm thickness, suitable for straight and left-turn binding.

BF100 H

Einfasser für voluminöse Bänder, z.B. Strickware, geeignet für Einfassarbeiten an geraden Kanten bzw. weiten Linksbögen.

Binder for thick tapes like knitted materials, suitable for straight and left-turn binding.

BF100 Spezial

Einfasser mit zusätzlichem Bandniederhalter und verbesserter Bandzuführung, besonders geeignet für vorgefaltete Satinbänder und Bandbreiten über 30mm.

Binder with additional tape suppress finger and improved tape supply guide, suitable for pre-folded satin tapes and tape sizes over 30 mm.



BF100H

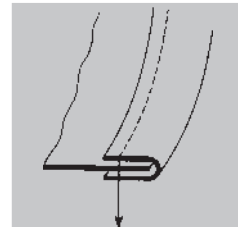
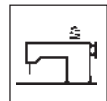

BF100 Spezial

**Bandeinfasser ohne Umbug**
Tape Binder without fold

Bandbreite Tape Size in mm	Fertigbreite Finished Size in mm	Bandstärke Tape Width in mm	BF100PL
12.0	6.5	1.5	BF100PL/12
14.0	7.0	1.5	BF100PL/14
15.0	7.5	1.5	BF100PL/15
16.0	8.0	1.5	BF100PL/16
19.0	9.5	1.5	BF100PL/19
20.0	10.0	1.5	BF100PL/20
22.0	11.0	1.5	BF100PL/22
25.0	12.5	1.5	BF100PL/25
30.0	15.0	1.5	BF100PL/30
35.0	17.5	1.5	BF100PL/35
40.0	20.0	1.5	BF100PL/40
45.0	22.5	1.5	BF100PL/45
50.0	25.5	1.5	BF100PL/50

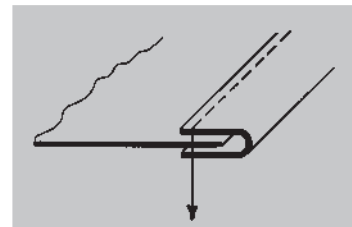

BF100PL

**BF100PL**

Einfasser für mittelschwere, steife Kunststoffbänder, geeignet für Einfassarbeiten an geraden Kanten.

Binder for medium heavy stiff plastic tapes, suitable for straight binding.

Geeignete Nähwerkzeuge finden Sie unter:
For suitable sewing parts please refer to:

Apparatefüße: Kap.1.1 Seite 22-24
Stichplatten/Transporteure: Kap.1.1 Seite 40
Attachment feet: Kap.1.1 Seite 22-24
Needle plates / Feed dogs: Kap.1.1 Seite 40

Bandeinfasser ohne Umbug
Tape Binder without fold



Bandbreite <i>Tape Size</i> <i>in mm</i>	Fertigbreite <i>Finished Size</i> <i>in mm</i>	BF1082
10.0	5.0	BF1082/10
12.0	6.0	BF1082/12
14.0	7.0	BF1082/14
16.0	8.0	BF1082/16
18.0	9.0	BF1082/18
20.0	10.0	BF1082/20
22.0	11.0	BF1082/22
24.0	12.0	BF1082/24
26.0	13.0	BF1082/26
28.0	14.0	BF1082/28
30.0	15.0	BF1082/30
32.0	16.0	BF1082/32
34.0	17.0	BF1082/34
36.0	18.0	BF1082/36
38.0	19.0	BF1082/38
40.0	20.0	BF1082/40

BF1082

Einfasser für leichte bis mittlere Textilbänder, geeignet für Einfassarbeiten an geraden Kanten bzw. weiten Linksbögen.
Binder for light up to medium fabric tapes, suitable for straight and left-turn binding.



BF1082

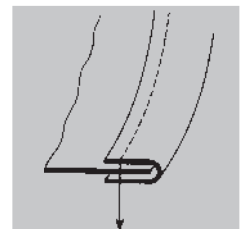

Geeignete Nähwerkzeuge finden Sie unter:
For suitable sewing parts please refer to:

- Apparatefüße: Kap.1.1 Seite 22-24
- Stichplatten/Transporteure: Kap.1.1 Seite 40
- Attachment feet: Kap.1.1 Seite 22-24
- Needle plates / Feed dogs: Kap.1.1 Seite 40

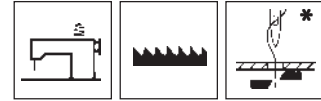
Bandeinfasser ohne Umbug
Tape Binder without fold

Bandbreite <i>Tape Size</i> in mm	Fertigbreite <i>Finished Size</i> in mm	Bandstärke <i>Tape Width</i> in mm	BF64	BF64PF138	BF64PF438	BF64PF463*	BF64PF483
10.0	5.0	1.0	BF64/10	BF64/10PF138	BF64/10PF438	BF64/10PF463	BF64/10PF483
12.0	6.0	1.0	BF64/12	BF64/12PF138	BF64/12PF438	BF64/12PF463	BF64/12PF483
14.0	7.0	1.0	BF64/14	BF64/14PF138	BF64/14PF438	BF64/14PF463	BF64/14PF483
15.0	7.5	1.0	BF64/15	BF64/15PF138	BF64/15PF438	BF64/15PF463	BF64/15PF483
16.0	8.0	1.5	BF64/16	BF64/16PF138	BF64/16PF438	BF64/16PF463	BF64/16PF483
18.0	9.0	1.5	BF64/18	BF64/18PF138	BF64/18PF438	BF64/18PF463	BF64/18PF483
19.0	9.5	1.5	BF64/19	BF64/19PF138	BF64/19PF438	BF64/19PF463	BF64/19PF483
20.0	10.0	1.5	BF64/20	BF64/20PF138	BF64/20PF438	BF64/20PF463	BF64/20PF483
22.0	11.0	1.5	BF64/22	BF64/22PF138	BF64/22PF438	BF64/22PF463	BF64/22PF483
24.0	12.0	1.5	BF64/24	BF64/24PF138	BF64/24PF438	BF64/24PF463	BF64/24PF483
25.0	12.5	1.5	BF64/25	BF64/25PF138	BF64/25PF438	BF64/25PF463	BF64/25PF483
26.0	13.0	1.5	BF64/26	BF64/26PF138	BF64/26PF438	BF64/26PF463	BF64/26PF483
28.0	14.0	1.5	BF64/28	BF64/28PF138	BF64/28PF438	BF64/28PF463	BF64/28PF483
30.0	15.0	1.5	BF64/30	BF64/30PF138	BF64/30PF438	BF64/30PF463	BF64/30PF483
32.0	16.0	1.5	BF64/32	BF64/32PF138	BF64/32PF438	BF64/32PF463	BF64/32PF483
34.0	17.0	1.5	BF64/34	BF64/34PF138	BF64/34PF438	BF64/34PF463	BF64/34PF483
35.0	17.5	1.5	BF64/35	BF64/35PF138	BF64/35PF438	BF64/35PF463	BF64/35PF483
36.0	18.0	1.5	BF64/36	BF64/36PF138	BF64/36PF438	BF64/36PF463	BF64/36PF483
38.0	19.0	1.5	BF64/38	BF64/38PF138	BF64/38PF438	BF64/38PF463	BF64/38PF483
40.0	20.0	1.5	BF64/40	BF64/40PF138	BF64/40PF438	BF64/40PF463	BF64/40PF483
45.0	22.5	1.5	BF64/45	BF64/45PF138	BF64/45PF438	BF64/45PF463	BF64/45PF483
50.0	25.0	1.5	BF64/50	BF64/50PF138	BF64/50PF438	BF64/50PF463	BF64/50PF483

BF64

Einfassgarnitur für Textilbänder bis 1,5 mm Stärke, geeignet zum Einfassen enger Kurven, bestehend aus: Bandeinfasser, Stichplatte, Transporteur, Ausgleichsgelenkfuß. Geeignet für Schnellnäher mit standardisierter Nähgarnitur.

Binder set for fabric tapes up to 1,5 mm thickness, suitable for binding sharp curves, consisting of: binder, needle plate, feed dog, compensating foot. Suitable for standard lockstitch machines.

BF64PF138

Einfassgarnitur wie unter BF64 beschrieben, jedoch geeignet für Pfaff Kl. 138, 238
Binder set as described under BF64, but suitable for Pfaff Cl. 138, 238

BF64PF438

Einfassgarnitur wie unter BF64 beschrieben, jedoch geeignet für Pfaff Kl. 438
Binder set as described under BF64, but suitable for Pfaff Cl. 438

BF64PF463*

Einfassgarnitur wie unter BF64 beschrieben, jedoch geeignet für Pfaff Kl. 463 mit Fadenabschneider
Binder set as described under BF64, but suitable for Pfaff Cl. 463 with thread cutter

BF64PF483

Einfassgarnitur wie unter BF64 beschrieben, jedoch geeignet für Pfaff Kl. 483
Binder set as described under BF64, but suitable for Pfaff Cl. 483

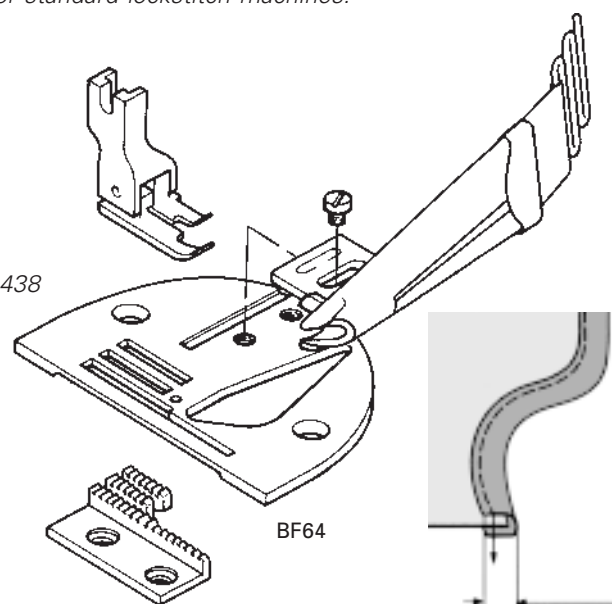

Geeignete Nähwerkzeuge finden Sie unter:
For suitable sewing parts please refer to:

Apparatefüße: Kap.1.1 Seite 22-24
Attachment feet: Kap.1.1 Seite 22-24

Die Apparate der Baureihe BF64 sind optional auch in der Ausführung H lieferbar.

Binders style BF64 are also available in H version on request.

Bandeinfasser ohne Umbug
Tape Binder without fold

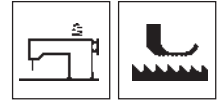

Bandbreite <i>Tape Size</i> <i>in mm</i>	Fertigbreite <i>Finished Size</i> <i>in mm</i>	Bandstärke <i>Tape Width</i> <i>in mm</i>	BF64PF467	BF64PF487
12.0	6.0	1.0	BF64/10	BF64/10PF138
14.0	7.0	1.0	BF64/12	BF64/12PF138
16.0	8.0	1.5	BF64/14	BF64/14PF138

BF64PF467

Einfassgarnitur für Textilbänder bis 1,5 mm Stärke, geeignet zum Einfassen enger Kurven, mit verstellbaren Umbugführungen, bestehend aus: Einfasser, Stichplatte, Transporteur, Presserfuß, Transportfuß.
Geeignet für Pfaff 467.

Binder set for fabric tapes upto 1,5 mm thickness, suitable for binding sharp curves, with adjustable folding guides, consisting of: binder, needle plate, feed dog, presser foot, feeding foot.
Suitable for Pfaff Cl. 467.

BF64PF487

Einfassgarnitur wie unter BF64PF467 beschrieben, jedoch geeignet für Pfaff 487.

Binder set as described under BF64PF467, but suitable for Pfaff Cl. 487.

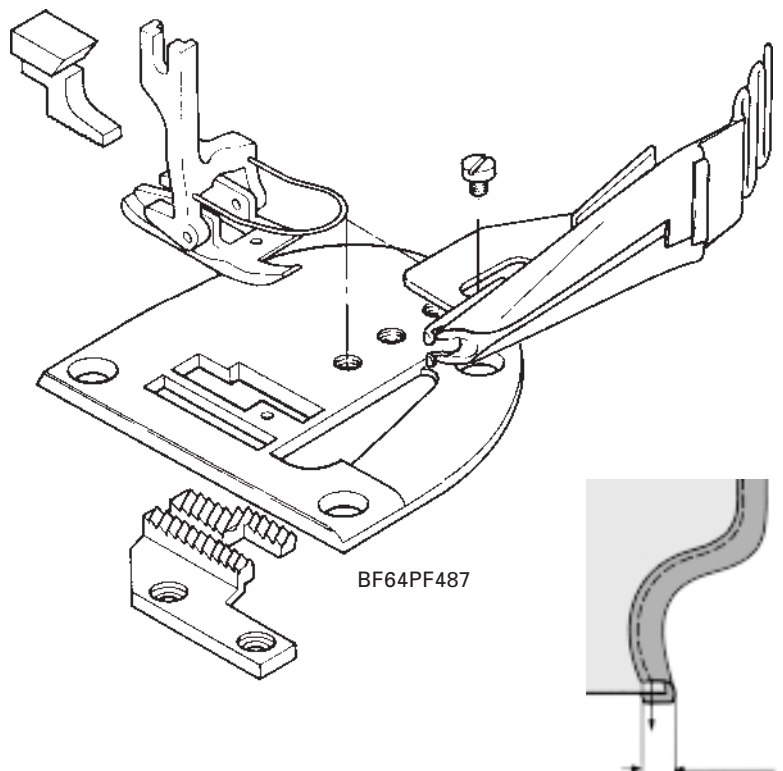

Anwendungsbeispiele für verstellbare Umbugführung.
Application examples for adjustable folding guides.

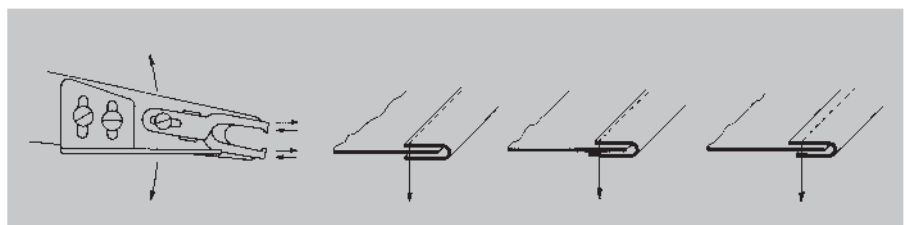

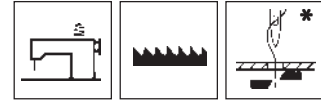
Bandeinfasser ohne Umbug
Tape Binder without fold

Bandbreite Tape Size in mm	Fertigbreite Finished Size in mm	Bandstärke Tape Width in mm	BF64DU211*	BF64DU265	BF64NE720	BF64NE885*
10.0	5.0	1.0	BF64/10DU211	BF64/10DU265	BF64/10NE720	BF64/10NE885
12.0	6.0	1.0	BF64/12DU211	BF64/12DU265	BF64/12NE720	BF64/12NE885
14.0	7.0	1.0	BF64/14DU211	BF64/14DU265	BF64/14NE720	BF64/14NE885
15.0	7.5	1.0	BF64/15DU211	BF64/15DU265	BF64/15NE720	BF64/15NE885
16.0	8.0	1.5	BF64/16DU211	BF64/16DU265	BF64/16NE720	BF64/16NE885
18.0	9.0	1.5	BF64/18DU211	BF64/18DU265	BF64/18NE720	BF64/18NE885
19.0	9.5	1.5	BF64/19DU211	BF64/19DU265	BF64/19NE720	BF64/19NE885
20.0	10.0	1.5	BF64/20DU211	BF64/20DU265	BF64/20NE720	BF64/20NE885
22.0	11.0	1.5	BF64/22DU211	BF64/22DU265	BF64/22NE720	BF64/22NE885
24.0	12.0	1.5	BF64/24DU211	BF64/24DU265	BF64/24NE720	BF64/24NE885
25.0	12.5	1.5	BF64/25DU211	BF64/25DU265	BF64/25NE720	BF64/25NE885
26.0	13.0	1.5	BF64/26DU211	BF64/26DU265	BF64/26NE720	BF64/26NE885
28.0	14.0	1.5	BF64/28DU211	BF64/28DU265	BF64/28NE720	BF64/28NE885
30.0	15.0	1.5	BF64/30DU211	BF64/30DU265	BF64/30NE720	BF64/30NE885
32.0	16.0	1.5	BF64/32DU211	BF64/32DU265	BF64/32NE720	BF64/32NE885
34.0	17.0	1.5	BF64/34DU211	BF64/34DU265	BF64/34NE720	BF64/34NE885
35.0	17.5	1.5	BF64/35DU211	BF64/35DU265	BF64/35NE720	BF64/35NE885
36.0	18.0	1.5	BF64/36DU211	BF64/36DU265	BF64/36NE720	BF64/36NE885
38.0	19.0	1.5	BF64/38DU211	BF64/38DU265	BF64/38NE720	BF64/38NE885
40.0	20.0	1.5	BF64/40DU211	BF64/40DU265	BF64/40NE720	BF64/40NE885
45.0	22.5	1.5	BF64/45DU211	BF64/45DU265	BF64/45NE720	BF64/45NE885
50.0	25.0	1.5	BF64/50DU211	BF64/50DU265	BF64/50NE720	BF64/50NE885

BF64DU211*

Einfassgarnitur für Textilbänder bis 1,5 mm Stärke, geeignet zum Einfassen enger Kurven, bestehend aus: Bandeinfasser, Stichplatte, Transporteur, Ausgleichsgelenkfuß. Geeignet für Dürkopp Kl. 211 mit Fadenabschneider.
Binder set for fabric tapes up to 1,5 mm thickness, suitable for binding sharp curves, consisting of: binder, needle plate, feed dog, compensating foot. Suitable for Dürkopp Cl. 211 with thread cutter.

BF64DU265

Einfassgarnitur wie unter BF64DU211 beschrieben, jedoch geeignet für Dürkopp Kl. 265.
Binder set as described under BF64DU211, but suitable for Dürkopp Cl. 265.

BF64NE720

Einfassgarnitur wie unter BF64DU211 beschrieben, jedoch geeignet für Necchi Kl. 720.
Binder set as described under BF64DU211, but suitable for Necchi Cl. 720.

BF64NE885*

Einfassgarnitur wie unter BF64DU211 beschrieben, jedoch geeignet für Necchi Kl. 885 mit Fadenabschneider.
Binder set as described under BF64DU211, but suitable for Necchi Cl. 885 with thread cutter.

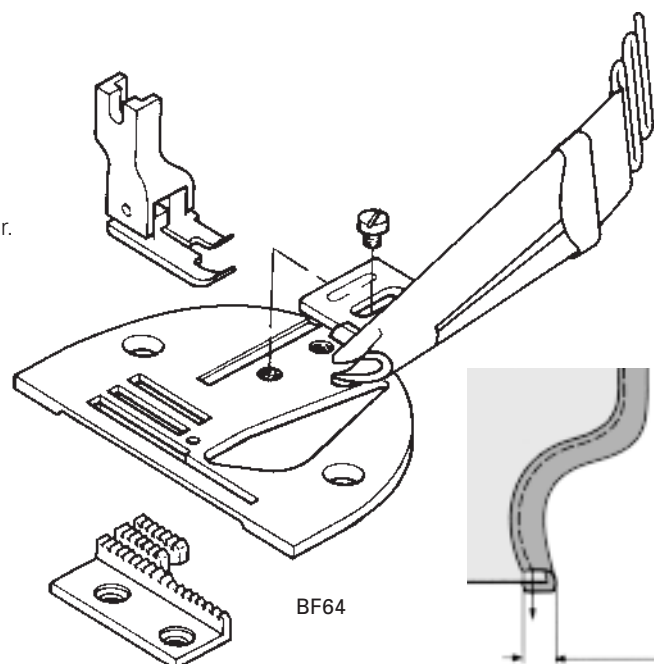

Geeignete Nähwerkzeuge finden Sie unter:
For suitable sewing parts please refer to:

Apparatefüße: Kap.1.1 Seite 22-24
Attachment feet: Kap.1.1 Seite 22-24

Bandeinfasser ohne Umbug
Tape Binder without fold

Bandbreite <i>Tape Size in mm</i>	Fertigbreite <i>Finished Size in mm</i>	Bandstärke <i>Tape Width in mm</i>	BF64B
10.0	5.0	1.0	BF64B/10
12.0	6.0	1.0	BF64B/12
14.0	7.0	1.0	BF64B/14
15.0	7.5	1.0	BF64B/15
16.0	8.0	1.5	BF64B/16
18.0	9.0	1.5	BF64B/18
19.0	9.5	1.5	BF64B/19
20.0	10.0	1.5	BF64B/20
22.0	11.0	1.5	BF64B/22
24.0	12.0	1.5	BF64B/24
25.0	12.5	1.5	BF64B/25
26.0	13.0	1.5	BF64B/26
28.0	14.0	1.5	BF64B/28
30.0	15.0	1.5	BF64B/30
32.0	16.0	1.5	BF64B/32
34.0	17.0	1.5	BF64B/34
35.0	17.5	1.5	BF64B/35
36.0	18.0	1.5	BF64B/36
38.0	19.0	1.5	BF64B/38
40.0	20.0	1.5	BF64B/40
45.0	22.5	1.5	BF64B/45
50.0	25.0	1.5	BF64B/50

BF64B

Einfasser, einzeln, passend zur Einfassergarnitur BF64
Binder, only, suitable for binder set BF64

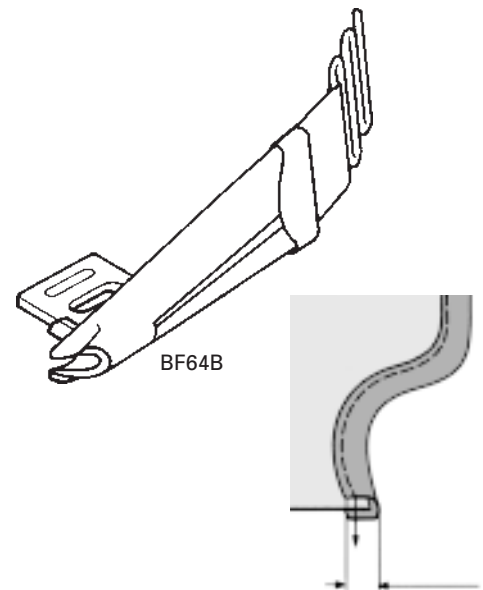

Bandeinfasser ohne Umbug
Tape Binder without fold

Bandbreite Tape Size in mm	Fertigbreite Finished Size in mm	Materialstärke Material Size in mm	BF29000 (95°)	BF34000 (115°)
12.0	6.0	3.0	BF29000/12x3	
14.0	4.5	5.0		BF34000/14x5
14.0	5.0	4.0		BF34000/14x4
14.0	7.0	4.0	BF29000/14x4	
16.0	5.5	6.0		BF34000/16x6
16.0	6.0	5.0		BF34000/16x5
16.0	6.5	4.0		BF34000/16x4
16.0	8.0	4.0	BF29000/16x4	
18.0	6.0	6.0		BF34000/18x6
18.0	6.5	5.0		BF34000/18x5
18.0	7.0	4.0		BF34000/18x4
18.0	9.0	4.0	BF29000/18x4	
19.0	9.5	6.0	BF29000/19x6	
20.0	10.0	4.0	BF29000/20x4	
20.0	10.0	6.0	BF29000/20x6	
20.0	6.5	7.0		BF34000/20x7
20.0	7.0	6.0		BF34000/20x6
20.0	7.5	5.0		BF34000/20x5
20.0	8.0	4.0		BF34000/20x4
22.0	11.0	4.0	BF29000/22x4	
22.0	11.0	6.0	BF29000/22x6	
22.0	7.5	7.0		BF34000/22x7
22.0	8.0	6.0		BF34000/22x6
22.0	8.5	5.0		BF34000/22x5
22.0	9.0	4.0		BF34000/22x4
24.0	12.0	4.0	BF29000/24x4	
24.0	12.0	6.0	BF29000/24x6	
25.0	10.0	6.0		BF34000/25x6
25.0	11.0	4.0		BF34000/25x4
26.0	13.0	4.0	BF29000/26x4	
26.0	13.0	6.0	BF29000/26x6	
28.0	11.0	6.0		BF34000/28x6
28.0	11.5	5.5		BF34000/28x5.5
28.0	12.0	4.0		BF34000/28x4
28.0	14.0	6.0	BF29000/28x6	
30.0	12.0	6.0		BF34000/30x6
30.0	12.5	5.0		BF34000/30x5
30.0	13.0	4.0		BF34000/30x4
30.0	15.0	6.0	BF29000/30x6	
35.0	14.0	6.0		BF34000/35x6
35.0	14.5	5.0		BF34000/35x5
35.0	15.0	4.0		BF34000/35x4
35.0	17.5	6.0	BF29000/35x6	
40.0	17.0	6.0		BF34000/40x6
40.0	17.5	5.0		BF34000/40x5
40.0	18.0	4.0		BF34000/40x4
40.0	20.0	6.0	BF29000/40x6	

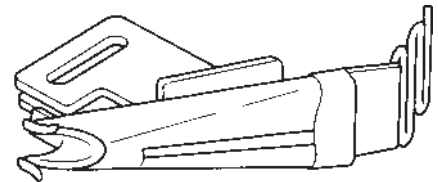

BF34000

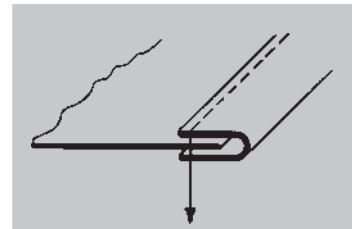
**BF29000 (95°)**

Einfasser für Dreifach-Transport-Maschinen, geeignet für Einfassarbeiten mit weiche Bänder an mittelschwerer Ware, zur Montage auf mitgehendem Apparaträger. *Binder for triple-feed-machines suitable for binding medium-heavy materials with soft tapes, to be fixed at synchr. moving attach. bracket.*

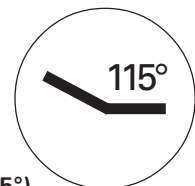
**BF34000 (115°)**

Einfasser wie unter BF29000 beschrieben, jedoch für steife Bänder. *Binder as described under BF29000, but for stiff tapes.*

Geeignete Nähwerkzeuge finden Sie unter:

For suitable sewing parts please refer to:

Apparatefüße: Kap.1.5

Attachment feet: Kap.1.5

Bandeinfasser ohne Umbug
Tape Binder without fold



BF705

Einfasser für Pfaff/Adler Dreifach-Transport-Maschinen mit Kantenbeschneidung, geeignet für Einfassarbeiten an mittelschwerer Ware mit weichen Bändern.

Binder for Pfaff/Adler unison-feed machines with edge cutter, suitable for binding medium-heavy materials with soft tapes.



BF705

Anfertigung auf Anfrage.
Manufactured on request.

Bandeinfasser ohne Umbug Tape Binder without fold



BA-1555 / BA-1555F

Einfäßhülse ohne Umbug, geeignet für Dreifach-Transport-Maschinen, zur Montage auf mitgehendem Apparateträger (BA-1555F = Einfäßhülse mit zusätzlichem Bandführungsbügel)

Binder without fold for unison-feed machines to be fixed at synchronized moving attachment bracket (BA-1555F = with additional tape guide loop)

BA-1555-75 / BA-1555F-75

wie A-1555 / A-1555F jedoch für steife Bänder geeignet
as described under A-1555 / A-1555F, but suitable for stiff tapes

BA-1556 / BA-1556F

Einfäßhülse ohne Umbug mit versetztem Einfäß unten, geeignet für Dreifach-Transport-Maschinen, zur Montage auf mitgehendem Apparateträger (BA-1556F = Einfäßhülse mit zusätzlichem Bandführungsbügel)

Binder without fold and shifted bottom binding for unison-feed machines to be fixed at synchronized moving attachment bracket (BA-1556F = with additional tape guide loop)

A-1556-75 / A-1556F-75

wie BA-1556 / BA-1556F jedoch für steife Bänder geeignet
as described under BA-1556 / BA-1556F, but suitable for stiff tapes

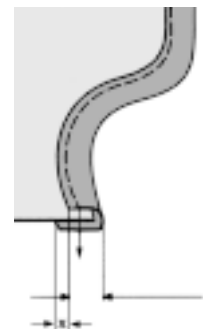
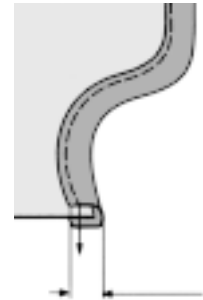

x = Überstand
x = Protruding edge

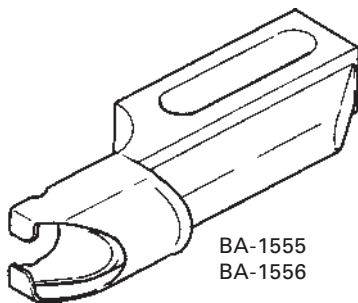

BA-1555
BA-1556



BA-1555F / BA-1555F-75
BA-1556F / BA-1556F-75

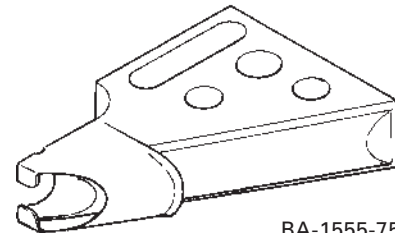

BA-1555-75
BA-1556-75

Bei Bestellung von Einfäßhülsen sind Angaben zur Maschinenklasse, Bandbreite, Materialstärke, Bandstärke erforderlich

To order the binder please always indicate machine class, tape width, material thickness, tape thickness

Fabrikat: Brand:	Maschinenklasse Machine class						
PFAFF	145	335	545	1245			
ADLER	67	69	167	169	267	467	767
NECCHI	840	902	958				

Benötigte Bestellangaben Necessary order details	Standardmaße (andere Abmessungen optional) Standard sizes (other sizes on request)									
Bandbreite/Tape size (mm)	12.0	14.0	16.0	18.0	20.0	22.0	25.0	28.0	30.0	
Bandstärke/Tape thickness (mm)	0.8	1.0	1.2	1.5	1.8	2.0				
Materialstärke/Material thickness (mm)	4.0	4.5	5.0	5.5	6.0	7.0	8.0			
Überstand/Protruding edge (mm) (x)	1.0	2.0	3.0	4.0						

(x) nur/only BA-1556 + BA-1556-75

Geeignete Nähwerkzeuge finden Sie unter:
For suitable sewing parts please refer to:

Apparatefüße: Kap. 1.5
Attachment feet: Kap. 1.5

Börtchenapparate mit doppeltem Umbug
Split-tube Folder with double fold

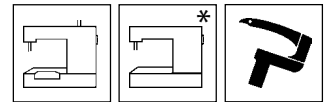

Bandbreite Tape Size in mm	Fertigbreite Finished Size in mm	Bandstärke Tape Width in mm	BF40	BF40H	BF604*	BF340
18.0	4.5	1.0	BF40/18x4.5x1			BF340/18
20.0	5.0	1.0	BF40/20x5x1			BF340/20
22.0	5.0	1.2	BF40/22x5x1.2			
22.0	5.5	1.0			BF604/22x5.5x1	
22.0	5.5	1.2				BF340/22
22.0	5.5	2.0			BF604/22x5.5x2	
25.0	6.0	1.2	BF40/25x6x1.2			BF340/25
25.0	6.0	2.0			BF604/25x6x2	
28.0	7.0	1.3	BF40/28x7x1.3			BF340/28
28.0	7.0	2.0	BF40/28x7x2		BF604/28x7x2	
30.0	8.0	1.5	BF40/30x8x1.5			BF340/30
30.0	8.0	2.5	BF40/30x8x2.5			
32.0	8.0	1.5	BF40/32x8x1.5		BF604/32x8x1.5	
32.0	8.0	3.0	BF40H/32x8x3			
32.0	9.0	1.5	BF40/32x9x1.5			BF340/32
35.0	10.0	1.5	BF40/35x10x1.5			BF340/35
35.0	10.0	2.0			BF604/35x10x2	
35.0	10.0	3.5		BF40H/35x10x3.5		
35.0	9.0	2.5	BF40/35x9x2.5			
38.0	11.0	2.5	BF40/38x11x2.5			
38.0	11.0	3.5		BF40H/38x11x3.5		
38.0	12.0	1.5	BF40/38x12x1.5			
38.0	12.0	1.7	BF40/38x12x1.7			BF340/38
38.0	12.0	2.0			BF604/38x12x2	
40.0	13.0	2.0	BF40/40x13x2			
42.0	14.0	2.0	BF40/42x14x2		BF604/42x14x2	
44.0	15.0	1.7	BF40/44x15x1.7			
45.0	14.0	3.5		BF40H/45x14x3.5		
46.0	16.0	2.0	BF40/46x16x2		BF604/46x16x2	
48.0	17.0	2.0	BF40/48x17x2			
50.0	16.0	3.5		BF40H/50x16x3.5		
50.0	18.0	2.0	BF40/50x18x2			
55.0	18.0	4.0		BF40H/55x18x4		
56.0	21.0	2.0	BF40/56x21x2			
56.0	21.0	2.5			BF604/56x21x2.5	
60.0	19.0	3.0	BF40/60x19x3			
60.0	20.0	4.0		BF40H/60x20x4		
60.0	22.0	2.0	BF40/60x22x2			
65.0	25.0	2.0			BF604/65x25x2	
66.0	24.0	3.0	BF40/66x24x3			
66.0	26.0	2.0	BF40/66x26x2			
66.0	26.0	3.5			BF604/66x26x3.5	
70.0	25.0	4.0		BF40H/70x25x4		
70.0	28.0	2.0	BF40/70x28x2			
75.0	29.0	2.0	BF40/75x29x2			
78.0	29.0	2.0	BF40/78x29x2			
78.0	31.0	1.5	BF40/78x31x1.5			
78.0	31.0	2.0	BF40/78x31x2			
78.0	32.0	1.5	BF40/78x32x1.5			
80.0	30.0	3.0	BF40/80x30x3			
80.0	32.0	2.0	BF40/80x32x2			
86.0	32.0	3.0	BF40/86x32x3			
86.0	35.0	2.0	BF40/86x35x2			
90.0	37.0	2.0	BF40/90x37x2			
92.0	38.0	2.0	BF40/92x38x2			
96.0	40.0	2.0	BF40/96x40x2			
100.0	40.0	3.0	BF40/100x40x3			
100.0	42.0	2.0	BF40/100x42x2			
110.0	47.0	2.0	BF40/110x47x2			
120.0	50.0	2.5	BF40/120x50x2.5			
120.0	52.0	2.5	BF40/120x52x2.5			
130.0	55.0	2.5	BF40/130x55x2.5			
130.0	57.0	2.5	BF40/130x57x2.5			

Fortsetzung siehe nächste Seite
To be continued next page

Börtchenapparate mit doppeltem Umbug *Split-tube Folder with double fold*

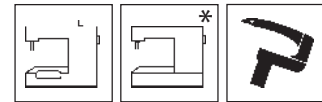

BF40

Börtchenapparat geeignet für Verarbeitung von leichter bis mittlerer Maschenware auf Kettenstichmaschinen mit senkrechter Apparatehalterung.

Split-tube folder suitable to work with light up to medium knit fabric on chainstitch machines with vertical attachment bracket.

BF40H

Börtchenapparat wie unter BF40 beschrieben, jedoch für voluminöse Maschenware geeignet. *Split-tube folder as described under BF40, but suitable for flatbed chainstitch machines.*

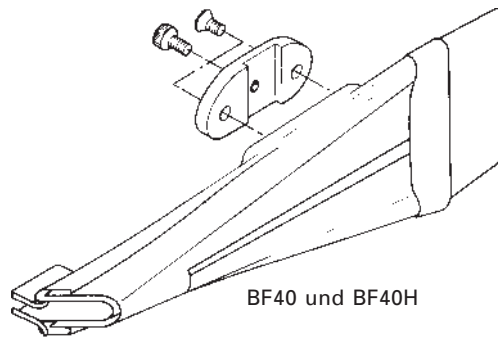

BF40 und BF40H

F604*

Börtchenapparat wie unter BF40 beschrieben, jedoch für Kettenstichmaschinen mit geschlossenem Flachbett geeignet.

Split-tube folder as described under BF40, but suitable for thick knit fabrics on chainstitch machines with closed flatbed.

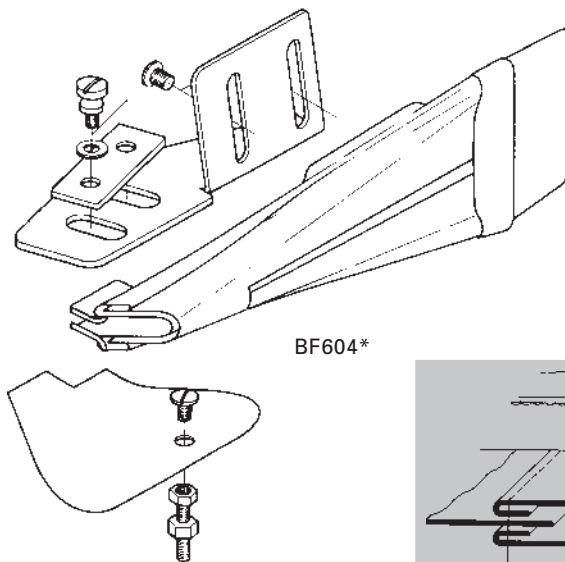

BF604*

BF340

Börtchenapparat wie unter BF40 beschrieben, jedoch mit verstellbarer Führung zur Regulierung der Auslaufkante.

Split-tube folder as described under BF40, but with vertical support bracket, with adjustable folding guides.

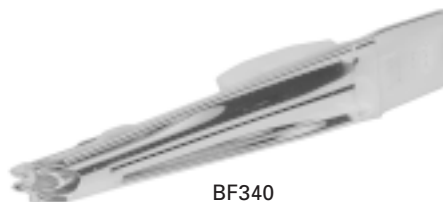

BF340

Anwendungsbeispiele für verstellbare Umbugführung.
Application examples for adjustable folding guides.

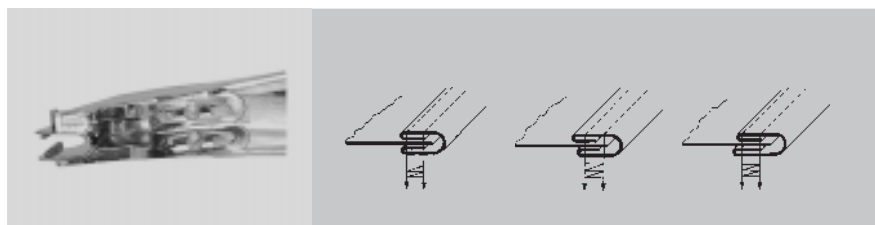

Börtchenapparate mit versetztem Umbug oben
Split-tube Folder with offset upper fold

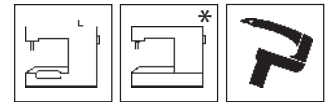

Bandbreite Tape Size in mm	Fertigbreite Finished Size in mm	Bandstärke Tape Width in mm	BF42	BF42H	BF602*	BF342
22.0	7.5	1.0	BF42/22x7.5x1			
22.0	7.5	1.2				BF342/22
25.0	9.0	1.3	BF42/25x9x1.3			BF342/25
27.0	10.0	1.3	BF42/27x10x1.3			BF342/27
27.0	10.0	2.0	BF42/27x10x2			
30.0	11.5	1.5	BF42/30x11.5x1.5			BF342/30
32.0	11.0	3.0		BF42H/32x11x3		
32.0	12.5	1.7	BF42/32x12.5x1.7			BF342/32
32.0	12.5	2.5	BF42/32x12.5x2.5			
33.0	12.5	1.7			BF602/33x12.5x1.7	
33.0	12.5	2.7			BF602/33x12.5x2.7	
35.0	14.0	1.7	BF42/35x14x1.7			BF342/35
35.0	14.0	2.5	BF42/35x14x2.5			
36.0	13.0	3.5		BF42H/36x13x3.5		
38.0	15.5	1.7	BF42/38x15.5x1.7			BF342/38
38.0	15.5	2.7	BF42/38x15.5x2.7			
40.0	15.0	3.5		BF42H/40x15x3.5		
40.0	16.0	1.7			BF602/40x16x1.7	
40.0	16.0	2.7			BF602/40x16x2.7	
40.0	17.0	2.0	BF42/40x17x2			
45.0	17.0	4.0		BF42H/45x17x4		
45.0	18.0	3.0	BF42/45x18x3			
45.0	19.0	2.0	BF42/45x19x2			
47.0	19.0	2.0			BF602/47x19x2	
47.0	19.0	3.0	BF42/47x19x3		BF602/47x19x3	
47.0	20.0	2.0	BF42/47x20x2			
50.0	19.0	4.0		BF42H/50x19x4		
51.0	21.0	3.0	BF42/51x21x3			
51.0	22.0	2.0	BF42/51x22x2			
53.0	22.0	2.0			BF602/53x22x2	
53.0	22.0	3.0			BF602/53x22x3	
55.0	22.0	4.0		BF42H/55x22x4		
57.0	24.0	3.0	BF42/57x24x3			
57.0	25.0	2.0	BF42/57x25x2			
59.0	25.0	2.0			BF602/59x25x2	
59.0	25.0	3.2			BF602/59x25x3.2	
59.0	25.5	2.0	BF42/59x25.5x2			
60.0	24.0	4.0		BF42H/60x24x4		
65.0	27.0	4.0		BF42H/65x27x4		
65.0	28.0	2.0	BF42/65x28x2			
70.0	29.0	4.0		BF42H/70x29x4		
70.0	30.0	3.0	BF42/70x30x3			
70.0	31.0	2.0	BF42/70x31x2			
70.0	31.0	3.0	BF42/70x31x3			
70.0	32.0	2.0	BF42/70x32x2			
72.0	32.0	2.0	BF42/72x32x2			
80.0	35.0	3.0	BF42/80x35x3			
80.0	36.0	2.0	BF42/80x36x2			
90.0	40.0	3.0	BF42/90x40x3			
90.0	41.0	2.0	BF42/90x41x2			
100.0	46.0	3.0	BF42/100x46x3			
110.0	50.0	3.0	BF42/110x50x3			
120.0	55.0	3.0	BF42/120x55x3			
130.0	60.0	3.0	BF42/130x60x3			

Fortsetzung siehe nächste Seite
To be continued next page

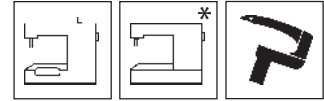
Börtchenapparate mit versetztem Umbug oben
Split-tube Folder with offset upper fold**BF42**

Börtchenapparat geeignet für Verarbeitung von leichter bis mittlerer Maschenware auf Kettenstichmaschinen mit senkrechter Apparatehalterung.

Split-tube folder suitable to work with light up to medium knit fabric on chainstitch machines with vertical attachment bracket.

BF42H

Börtchenapparat wie unter BF42 beschrieben, jedoch für voluminöse Maschenware geeignet.

Split-tube folder as described under BF42, but suitable for thick knit fabric.

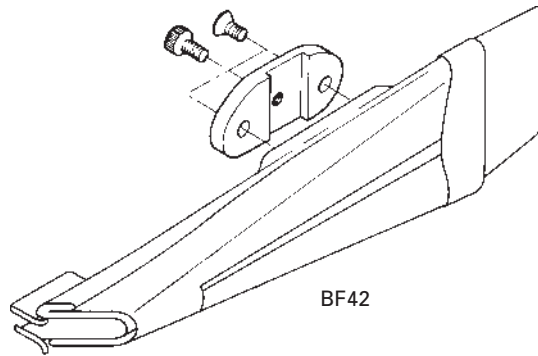

BF42

BF602*

Börtchenapparat wie unter BF42 beschrieben, jedoch für Kettenstichmaschinen mit geschlossenem Flachbett geeignet.

Split-tube folder as described under BF42, but suitable for chainstitch machines with closed flatbed.

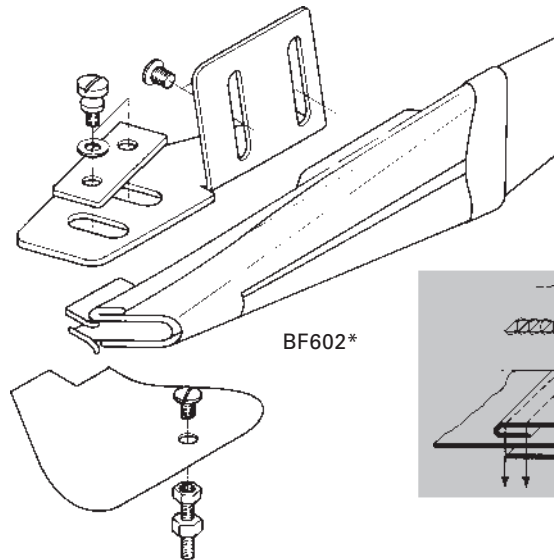

BF602*

BF342

Börtchenapparat wie unter BF42 beschrieben, jedoch mit verstellbarer Führung zur Regulierung der Auslaufkante.

Split-tube folder as described under BF42, but with adjustable folding guides.

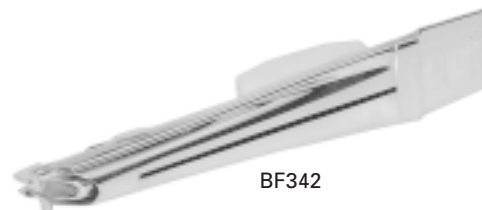

BF342

Anwendungsbeispiele für verstellbare Umbugführung.
Application examples for adjustable folding guides.

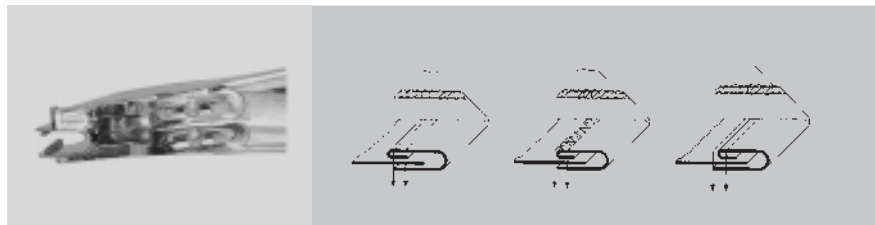

Börtchenapparate mit versetztem Umbug oben
Linking split-tube Folder with offset upper fold

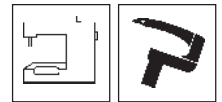

Bandbreite Tape Size in mm	Fertigbreite Finished Size in mm	Bandstärke Tape Width in mm	BF272
36.0	12.0	4.0	BF272/36
40.0	13.0	4.0	BF272/40
45.0	15.0	4.0	BF272/45
50.0	18.0	5.0	BF272/50
55.0	20.0	5.0	BF272/55
60.0	22.0	5.0	BF272/60
65.0	25.0	5.0	BF272/65
70.0	28.0	5.0	BF272/70
75.0	30.0	5.0	BF272/75
80.0	32.0	5.0	BF272/80
85.0	35.0	5.0	BF272/85
100.0	42.0	5.0	BF272/100
110.0	47.0	5.0	BF272/110
120.0	52.0	6.0	BF272/120
130.0	57.0	6.0	BF272/130
140.0	62.0	6.0	BF272/140
150.0	67.0	6.0	BF272/150
160.0	72.0	6.0	BF272/160
170.0	77.0	6.0	BF272/170
180.0	82.0	6.0	BF272/180

BF272

Börtchenapparat geeignet für Verarbeitung von voluminöser Maschenware auf Kettenstichmaschinen mit senkrechter Apparatehalterung.

Linking split-tube folder suitable for binding works with thick materials on chainstitch machines with vertical attachment bracket.

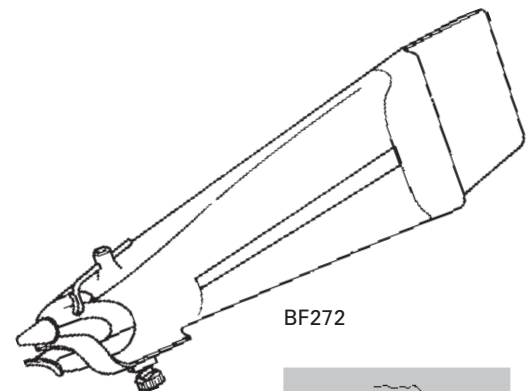

BF272

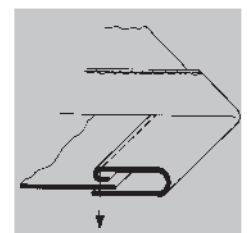

Börtchenapparate mit Umbug oben Split-tube Folder with upper fold

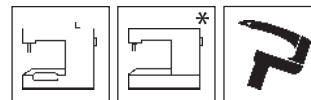

Bandbreite Tape Size in mm	Fertigbreite Finished Size in mm	Bandstärke Tape Width in mm	BF43	BF43H	BF603*
22.0	8.0	1.5			BF603/22x8x1.5
25.0	9.0	1.3	BF43/25x9x1.3		
27.0	10.0	1.3			BF603/27x10x1.3
27.0	10.0	1.5	BF43/27x10x1.5		
32.0	12.0	1.7			BF603/32x12x1.7
32.0	12.0	2.7			BF603/32x12x2.7
33.0	12.5	1.7	BF43/33x12.5x1.7		
33.0	12.5	2.7	BF43/33x12.5x2.7		
36.0	13.0	3.0		BF43H/36x13x3	
38.0	15.5	1.7	BF43/38x15.5x1.7		
38.0	16.0	1.7			BF603/38x16x1.7
38.0	16.0	2.7			BF603/38x16x2.7
40.0	15.0	3.0		BF43H/40x15x3	
40.0	16.0	1.7	BF43/40x16x1.7		
40.0	16.0	2.7	BF43/40x16x2.7		
45.0	17.0	4.0		BF43H/45x17x4	
45.0	19.0	2.0			BF603/45x19x2
45.0	19.0	3.0			BF603/45x19x3
46.0	19.0	2.0	BF43/46x19x2		
46.0	19.0	3.0	BF43/46x19x3		
50.0	19.0	4.0		BF43H/50x19x4	
51.0	21.0	2.0			BF603/51x21x2
51.0	21.0	3.0			BF603/51x21x3
52.0	22.0	2.0	BF43/52x22x2		
52.0	22.0	3.0	BF43/52x22x3		
55.0	22.0	4.0		BF43H/55x22x4	
57.0	25.0	2.0			BF603/57x25x2
57.0	25.0	3.2			BF603/57x25x3.2
59.0	25.0	3.2	BF43/59x25x3.2		
59.0	25.5	2.0	BF43/59x25.5x2		
59.0	25.5	3.2	BF43/59x25.5x3.2		
60.0	24.0	4.0		BF43H/60x24x4	
65.0	27.0	4.0		BF43H/65x27x4	
70.0	29.0	4.0		BF43H/70x29x4	
72.0	31.0	3.0	BF43/72x31x3		
72.0	32.0	2.0	BF43/72x32x2		
72.0	32.0	3.7	BF43/72x32x3.7		
82.0	36.0	3.0	BF43/82x36x3		
82.0	37.0	2.0	BF43/82x37x2		
82.0	37.0	3.7	BF43/82x37x3.7		
103.0	47.0	3.0	BF43/103x47x3		
123.0	57.0	3.0	BF43/123x57x3		
133.0	62.0	3.0	BF43/133x62x3		

Fortsetzung siehe nächste Seite
To be continued next page

Börtchenapparate mit Umbug oben
Split-tube Folder with upper fold

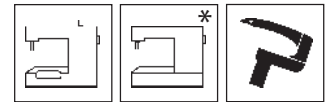

BF43

Börtchenapparat geeignet für Verarbeitung von leichter bis mittlerer Maschenware auf Kettenstichmaschinen mit senkrechter Apparatehalterung.

Split-tube folder suitable to work with light up to medium knit fabric on chainstitch machines with vertical attachment bracket.

BF43H

Börtchenapparat wie unter BF43 beschrieben, jedoch für voluminöse Maschenware geeignet.

Split-tube folder as described under BF43, but suitable for thick knit fabric.

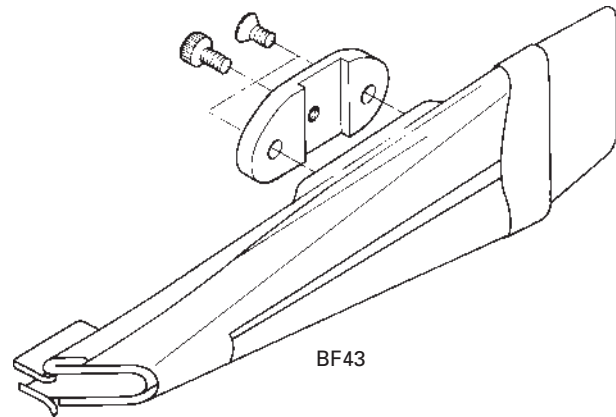

BF603*

Börtchenapparat wie unter BF43 beschrieben, jedoch für Kettenstichmaschinen mit geschlossenem Flachbett geeignet.

Split-tube folder as described under BF43, but suitable for chainstitch machines with closed flatbed.

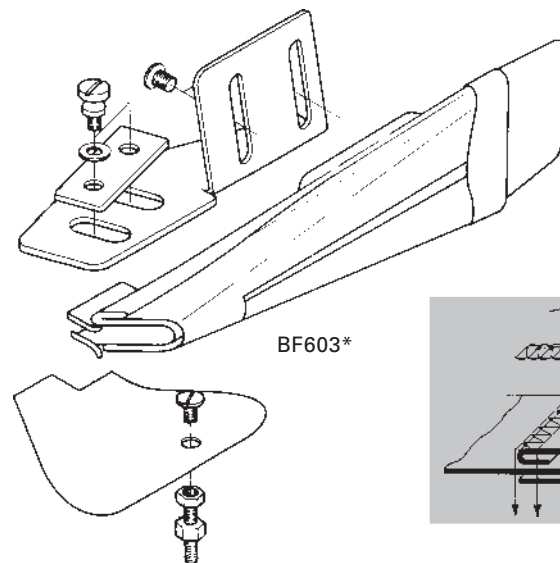

Börtchenapparate ohne Umbug Split-tube Folder without fold

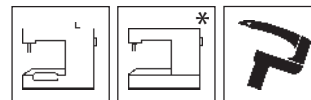

Bandbreite Tape Size in mm	Fertigbreite Finished Size in mm	Bandstärke Tape Width in mm	BF44	BF44H	BF601*	BF344
10.0	7.0	1.0	BF44/10x7x1			BF344/10
12.0	6.0	1.0	BF44/12x6x1			BF344/12
14.0	7.0	1.0	BF44/14x7x1			BF344/14
14.0	7.0	1.5	BF44/14x7x1.5			
15.0	7.5	1.0	BF44/15x7.5x1		BF601/15x7.5x1	BF344/15
16.0	8.0	1.0	BF44/16x8x1			BF344/16
16.0	8.0	1.5	BF44/16x8x1.5			
18.0	9.0	1.5	BF44/18x9x1.5			BF344/18
18.0	9.0	3.0		BF44H/18x9x3		
20.0	10.0	1.4			BF601/20x10x1.4	
20.0	10.0	1.5	BF44/20x10x1.5			BF344/20
20.0	10.0	3.0		BF44H/20x10x3		
25.5	12.5	1.5			BF601/25.5x12.5x1.5	
25.5	12.5	2.0			BF601/25.5x12.5x2	
26.0	13.0	1.5	BF44/26x13x1.5			BF344/26
26.0	13.0	2.0	BF44/26x13x2			
26.0	13.0	3.0		BF44H/26x13x3		
28.0	14.0	1.5	BF44/28x14x1.5			
28.0	14.0	2.0	BF44/28x14x2			
30.0	15.0	1.5	BF44/30x15x1.5			BF344/30
30.0	15.0	2.5	BF44/30x15x2.5			
30.0	15.0	4.0		BF44H/30x15x4		
32.0	16.0	1.5	BF44/32x16x1.5		BF601/32x16x1.5	BF344/32
32.0	16.0	2.0			BF601/32x16x2	
32.0	16.0	2.5	BF44/32x16x2.5			
35.0	17.5	4.0		BF44H/35x17.5x4		
36.0	18.0	1.5				BF344/36
36.0	18.0	2.0	BF44/36x18x2.0			
38.0	19.0	1.5	BF44/38x19x1.5			BF344/38
38.0	19.0	2.0			BF601/38x19x2	
38.0	19.0	2.5	BF44/38x19x2.5			
38.0	19.0	2.7			BF601/38x19x2.7	
40.0	20.0	2.0	BF44/40x20x2			
40.0	20.0	3.0	BF44/40x20x3			
40.0	20.0	4.0		BF44H/40x20x4		
44.5	22.0	2.0			BF601/44.5x22x2	
44.5	22.0	3.0			BF601/44.5x22x3	
45.0	22.5	2.0	BF44/45x22.5x2			
45.0	22.5	3.0	BF44/45x22.5x3			
48.0	24.0	2.0	BF44/48x24x2			
50.0	25.0	2.0	BF44/50x25x2			
50.0	25.0	4.0		BF44H/50x25x4		
51.0	22.5	2.0	BF44/51x22.5x2			
51.0	22.5	3.0	BF44/51x22.5x3			
51.0	25.5	2.0			BF601/51x25.5x2	
51.0	25.5	3.2			BF601/51x25.5x3.2	
60.0	30.0	2.0	BF44/60x30x2			
60.0	30.0	3.0	BF44/60x30x3			
60.0	30.0	4.0		BF44H/60x30x4		
63.5	32.0	2.0			BF601/63.5x32x2	
63.5	32.0	3.5			BF601/63.5x32x3.5	
70.0	35.0	2.0	BF44/70x35x2			
70.0	35.0	3.0	BF44/70x35x3			
70.0	35.0	4.0		BF44H/70x35x4		
80.0	40.0	2.5	BF44/80x40x2.5			
80.0	40.0	4.0		BF44H/80x40x4		
90.0	45.0	2.5	BF44/90x45x2.5			
90.0	45.0	5.0		BF44H/90x45x5		
100.0	50.0	2.5	BF44/100x50x2.5			
100.0	50.0	4.0		BF44H/100x50x4		
110.0	55.0	2.5	BF44/110x55x2.5			
120.0	60.0	2.5	BF44/120x60x2.5			
130.0	65.0	2.5	BF44/130x65x2.5			

Fortsetzung siehe nächste Seite
To be continued next page

Börtchenapparate ohne Umbug
Split-tube Folder without fold

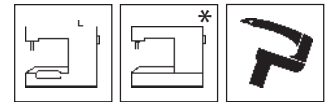

BF44

Börtchenapparat geeignet für Verarbeitung von leichter bis mittlerer Maschenware auf Kettenstichmaschinen mit senkrechter Apparatehalterung.

Split-tube folder suitable to work with light up to medium knit fabric on chainstitch machines with vertical attachment bracket.

BF44H

Börtchenapparat wie unter BF44 beschrieben, jedoch für voluminöse Maschenware geeignet.

Split-tube folder as described under BF44, but suitable for thick knit fabric.

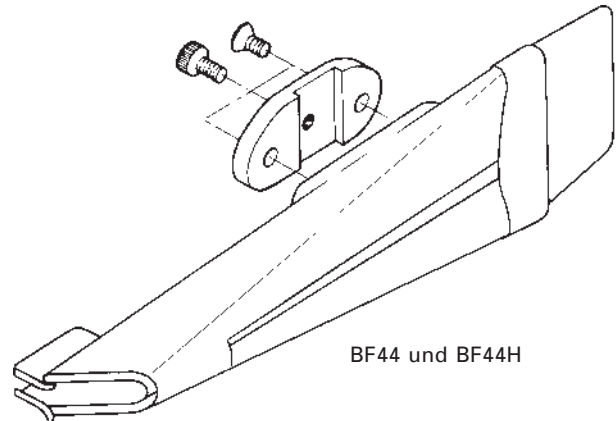

BF44 und BF44H

BF601*

Börtchenapparat wie unter BF44 beschrieben, jedoch für Kettenstichmaschinen mit geschlossenem Flachbett geeignet.

Split-tube folder as described under BF44, but suitable for chainstitch machines with closed flatbed.

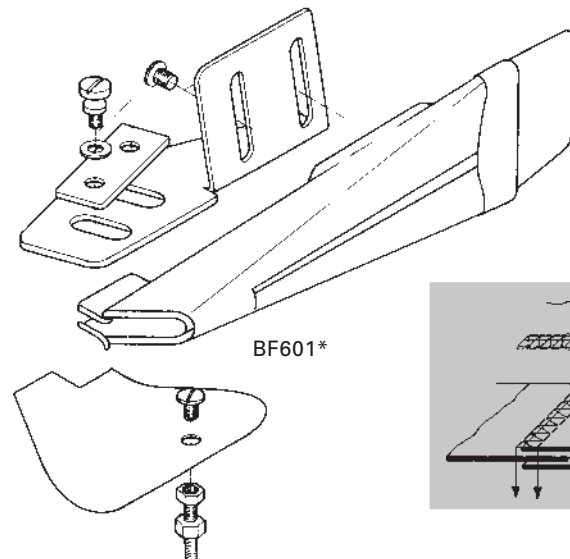

BF601*

BF344

Börtchenapparat wie unter BF44 beschrieben, jedoch mit verstellbarer Führung zur Regulierung der Auslaufkante.

Split-tube folder as described under BF44, but with adjustable folding guides.

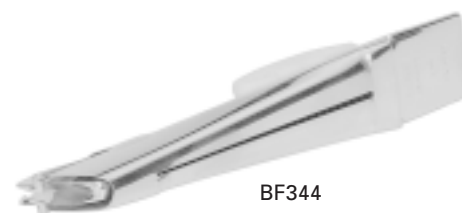

BF344

Anwendungsbeispiele für verstellbare Umbugführung.
Application examples for adjustable folding guides.

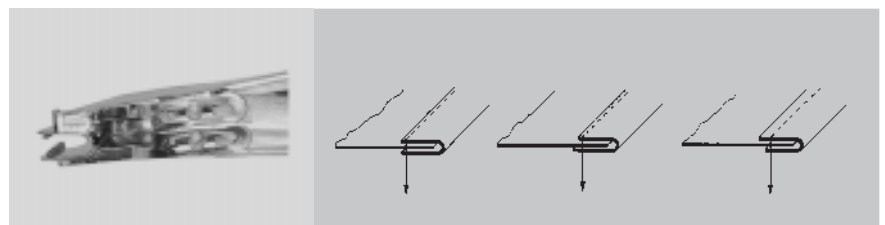

Börtchenapparate ohne Umbug Linking Split-tube Folder without fold

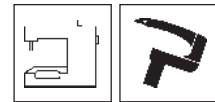

Bandbreite Tape Size in mm	Fertigbreite Finished Size in mm	Bandstärke Tape Width in mm	BF274
20.0	10.0	4.0	BF274/20
25.0	12.0	4.0	BF274/25
30.0	15.0	4.0	BF274/30
35.0	17.0	5.0	BF274/35
40.0	20.0	5.0	BF274/40
45.0	22.0	6.0	BF274/45
50.0	25.0	6.0	BF274/50
55.0	27.0	6.0	BF274/55
60.0	30.0	6.0	BF274/60
65.0	32.0	6.0	BF274/65
70.0	35.0	6.0	BF274/70
75.0	37.0	6.0	BF274/75
80.0	40.0	6.0	BF274/80
85.0	42.0	6.0	BF274/85
90.0	45.0	6.0	BF274/90
95.0	47.0	6.0	BF274/95
100.0	50.0	6.0	BF274/100
105.0	52.0	6.0	BF274/105
110.0	55.0	6.0	BF274/110
120.0	60.0	6.0	BF274/120
130.0	65.0	6.0	BF274/130
140.0	70.0	6.0	BF274/140
150.0	75.0	6.0	BF274/150
160.0	80.0	6.0	BF274/160
170.0	85.0	6.0	BF274/170
180.0	90.0	6.0	BF274/180

BF274

Börtchenapparat geeignet für Verarbeitung von voluminöser Maschenware auf Kettenstichmaschinen mit senkrechter Apparatehalterung, ausgestattet mit regulierbarer Kantenführung.
Linking split-tube folder suitable for binding works with thick materials on chainstitch machines with vertical attachment bracket and adjustable edge guides.



BF274

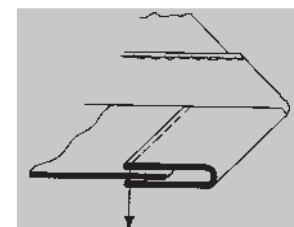

Börtchenapparate mit Gummibandzuführung
Split-tube Folder with elastic tape insertion

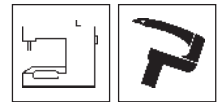

Bandbreite Tape Size in mm	Fertigbreite Finished Size in mm	Bandstärke Tape Width in mm	Gummibandbreite Elastic Tape Width in mm	BF265
20.0	10.0	1.3	4.0	BF265/20
25.0	12.5	1.3	5.0	BF265/25
28.0	14.0	1.5	6.0	BF265/28
30.0	15.0	1.5	7.0	BF265/30
32.0	16.0	1.5	8.0	BF265/32
35.0	17.5	1.7	9.0	BF265/35
38.0	19.0	1.7	10.0	BF265/38
40.0	20.0	1.7	12.0	BF265/40

BF265

Börtchenapparat mit doppeltem Umbug und Zuführung für elastisches Band innerhalb des oberen Umbugs, geeignet für Kettenstichmaschinen mit senkrechter Apparatehalterung.

Double fold split-tube folder with elastic insertion inside the upper fold, suitable for chainstitch machines with vertical attachment bracket.



BF265

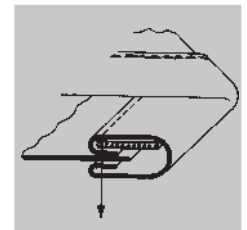

Gummibandeinfasser
Elastic Tape Binder

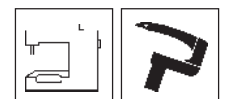

Bandbreite Tape Size in mm	Fertigbreite Finished Size in mm	Bandstärke Tape Width in mm	BF1084
12.0	6.0	1.5	BF1084/12
14.0	7.0	1.5	BF1084/14
16.0	8.0	1.5	BF1084/16

BF1184

Gummibandeinfasser, geeignet für Kettenstichmaschinen mit senkrechter Apparatehalterung.

Elastic tape binder, suitable for chainstitch machines with vertical attachment bracket.

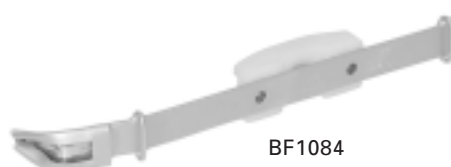

BF1084

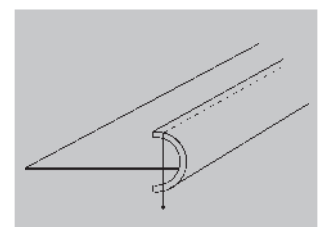

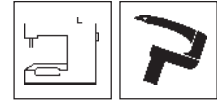
Börtchenapparate mit Gummibandzuführung
Split-tube Folder with elastic tape insertion

Sämtliche Apparate auf dieser Seite eignen sich für den Einsatz auf Kettenstichmaschinen mit senkrechter Apparatehalterung.
Die Fertigung der Apparate erfolgt gegen Einsendung von Mustermaterial.

All attachments on this page are suitable for chainstitch machines with vertical attachments bracket.

Attachment will be manufactured after receipt of sample materials.

BF46

Börtchenapparat ohne Umbug mit Gummibandzuführung.
Split-tube folder without fold, with elastic tape insertion.

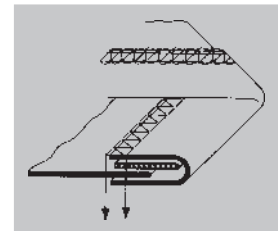
**BF47**

Börtchenapparat mit versetztem Umbug oben, elastisches Band unterhalb des Materials.
Shifted top fold split-tube folder , with elastic tape insertion below material.

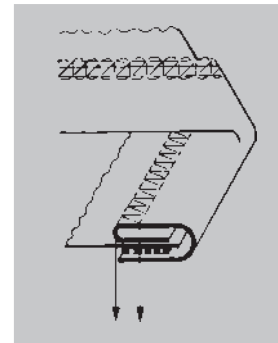
**BF48**

Börtchenapparat mit Umbug oben, elastisches Band unterhalb des Materials.
Top fold split-tube folder , with elastic tape insertion below material.

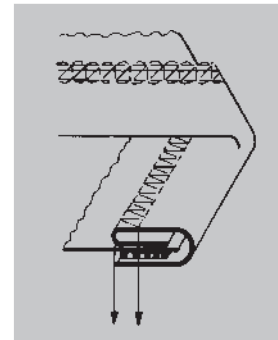
**BF49**

Börtchenapparat mit versetztem Umbug oben, elastisches Band innerhalb des oberen Umbugs.
Shifted top fold split-tube folder , with elastic tape insertion inside the top fold.

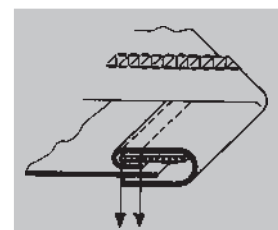

Doppelkapper für Arm-Abwärts-Maschinen
Lap-Seam Feller for feed-off the arm machines



Nadelabstand Needle gauge in mm	B23420Z	BF121586	BF121757	BN121586	BR121586
4.8		BF121586/4.8L	BF121757/4.8L	BN121586/4.8L	BR121586/4.8L
4.8	B23420Z-1/4M	BF121586/4.8	BF121757/4.8	BN121586/4.8	BR121586/4.8
4.8		BF121586/4.8MH	BF121757/4.8MH	BN121586/4.8MH	BR121586/4.8MH
4.8	B23420Z-3/16H	BF121586/4.8H	BF121757/4.8H	BN121586/4.8H	BR121586/4.8H
6.4	B23420Z-1/4L	BF121586/6.4L	BF121757/6.4L	BN121586/6.4L	BR121586/6.4L
6.4		BF121586/6.4	BF121757/6.4	BN121586/6.4	BR121586/6.4
6.4	B23420Z-1/4MH	BF121586/6.4MH	BF121757/6.4MH	BN121586/6.4MH	BR121586/6.4MH
6.4	B23420Z-1/4H	BF121586/6.4H	BF121757/6.4H	BN121586/6.4H	BR121586/6.4H
6.4	B23420Z-1/4XH	BF121586/6.4XH	BF121757/6.4XH	BN121586/6.4XH	
8.0				BN121586/8.0L	BR121586/8.0L
8.0		BF121586/8.0	BF121757/8.0	BN121586/8.0	BR121586/8.0
8.0		BF121586/8.0MH		BN121586/8.0MH	BR121586/8.0MH
8.0	B23420Z-5/16H	BF121586/8.0H		BN121586/8.0H	BR121586/8.0H
8.0	B23420Z-5/16XH	BF121586/8.0XH	BF121757/8.0XH	BN121586/8.0XH	

B23420Z

Doppelkapper für Union Special Kl. 35800.
Lap-Seam Feller for Union Special Cl. 35800.

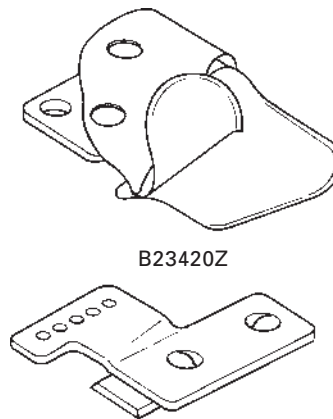

B23420Z

BF121586

Doppelkapper für Zweinadel-Arm-Abwärts-Maschinen wie Brother, Juki, Singer Kl. 231, 261 etc.
Lap-Seam Feller for double needle feed-off the arm machines like Brother, Juki, Singer Cl. 231, 261 etc.

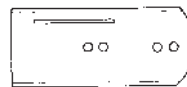

BF121757

Doppelkapper für Zweinadel-Arm-Abwärts-Maschinen wie Singer Kl. 231-25.
Lap-Seam Feller for double needle feed-off the arm machines like Singer Cl. 231-25.

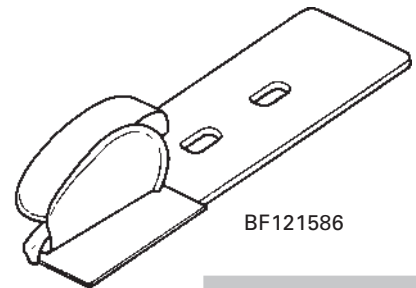

BF121586

BN121586

Doppelkapper für Necchi Arm-Abwärts-Maschinen.
Lap-Seam Feller for Necchi feed-off the arm machines.

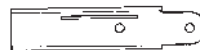

BR121586

Doppelkapper für Rimoldi Arm-Abwärts-Maschinen.
Lap-Seam Feller for Rimoldi feed-off the arm machines.

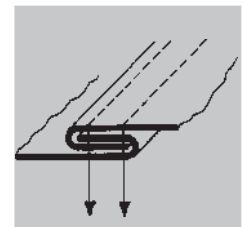

Doppelkapper für Flachbettmaschinen *Lap-Seam Feller for flatbed machines*

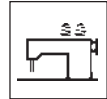

Nadelabstand Needle Gauge in mm	BF1135	BF1136
4.8	BF1135/4.8L	BF1136/4.8L
4.8	BF1135/4.8	BF1136/4.8
4.8	BF1135/4.8MH	BF1136/4.8MH
4.8	BF1135/4.8H	BF1136/4.8H
6.4	BF1135/6.4L	BF1136/6.4L
6.4	BF1135/6.4	BF1136/6.4
6.4	BF1135/6.4MH	BF1136/6.4MH
6.4	BF1135/6.4H	BF1136/6.4H
6.4	BF1135/6.4XH	BF1136/6.4XH
8.0	BF1135/8.0L	BF1136/8.0L
8.0	BF1135/8.0	BF1136/8.0
8.0	BF1135/8.0MH	
8.0	BF1135/8.0H	BF1136/8.0H
8.0	BF1135/8.0XH	

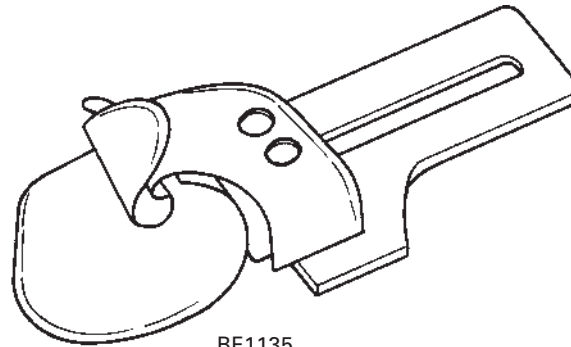

BF1135

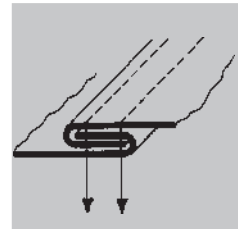
**BF1135**

Doppelkapper für Zwei- und Dreinadel-Flachbettmaschinen mit Apparatebefestigung rechts von der Stichplatte.

Lap-Seam Feller for double and triple needle flatbed machines with attachment fixing holes on the right side of the throat plate.

BF1136

Doppelkapper für Zweinadel-Flachbettmaschine UNION SPEZIAL Kl. 51400.

Lap-Seam Feller for double needle flatbed machine UNION SPECIAL Cl. 51400.

Doppelkapper für Flachbettmaschinen *Lap-Seam Feller for flatbed machines*

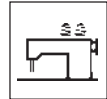

Nadelabstand Needle Gauge in mm	BF490361
4.8	BF490361/4.8L
4.8	BF490361/4.8
4.8	BF490361/4.8MH
4.8	BF490361/4.8H
4.8	BF490361/4.8XH
6.4	BF490361/6.4L
6.4	BF490361/6.4
6.4	BF490361/6.4MH
6.4	BF490361/6.4H
6.4	BF490361/6.4XH
8.0	BF490361/8.0L
8.0	BF490361/8.0
8.0	BF490361/8.0H
8.0	BF490361/8.0MH
8.0	BF490361/8.0XH

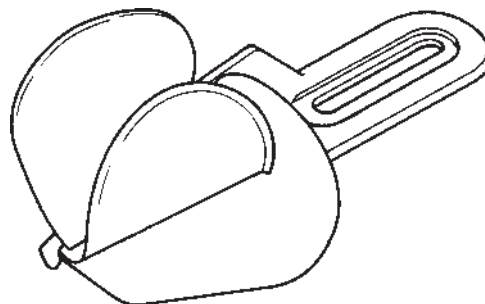

BF490361

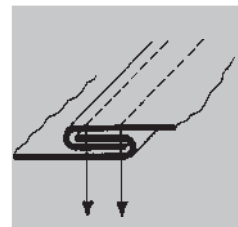
**BF490361**

Doppelkapper für Zweinadel-Flachbettmaschinen mit Apparatebefestigung vor der Stichplatte, wie Pfaff, Singer 112W, 212W.

Lap-Seam Feller for double needle flatbed machines with attachment fixing holes in front of the throat plate, like Pfaff, Singer 112W, 212W.

Spezialkapper für Hemdenproduktion
Special Feller for shirt production



Kappbreite Felling Width in mm	BF285
7.0	BF285/7L
7.0	BF285/7
10.0	BF285/10L
10.0	BF285/10
13.0	BF285/13L
13.0	BF285/13
15.0	BF285/15

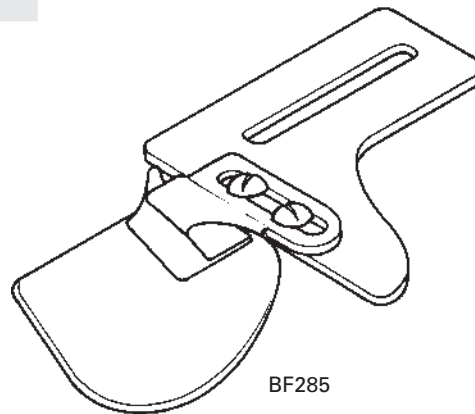

BF285

BF285

Kapper zum Nähen einer Doppelkappnaht für Einnadel-Maschinen in zwei Arbeitsgängen (Englische Naht).

Feller for lap seam sewing with single needle machines by two operations (english seam).

Geeignete Nähwerkzeuge finden Sie unter:
For suitable sewing parts please refer to:

Apparatefüße: Kap.1.1 Seite 22-24

Stichplatten/Transporteure: Kap.1.1 Seite 40

Attachment feet: Kap.1.1 Seite 22-24

Needle plates / Feed dogs: Kap.1.1 Seite 40

1. Arbeitsgang
1. Operation

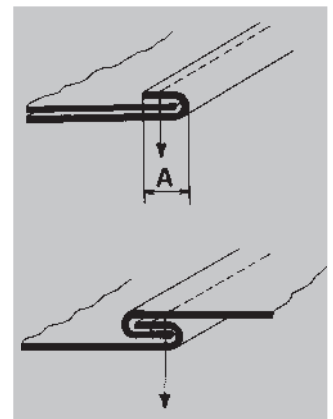

2. Arbeitsgang
2. Operation

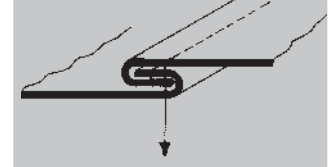

Spezialkapper für Hemdenproduktion
Special Feller for shirt production



Kappbreite Felling Width in mm	BF338
7.0	BF338/7
8.0	BF338/8
9.0	BF338/9
10.0	BF338/10
11.0	BF338/11
12.0	BF338/12

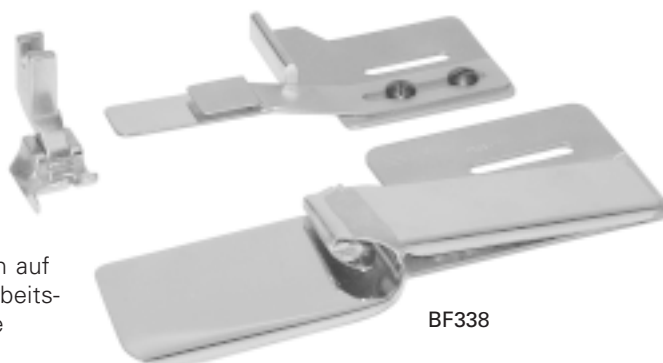

BF338

BF338

Kapper zum Einnähen von Hemdsärmeln auf Einnadel-Flachbettmaschinen in zwei Arbeitsgängen, geeignet für leichte bis mittlere Materialien.

Feller for attaching shirt sleeves in two operations on single needle machines, suitable for light up to medium fabric.

1. Arbeitsgang
1. Operation



2. Arbeitsgang
2. Operation



Spezialkapper für Hemdenproduktion *Special Feller for shirt production*

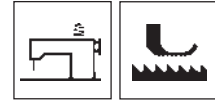

Kappbreite <i>Felling Width</i> <i>in mm</i>	Kapprichtung <i>Felling Direction</i> <i>in mm</i>	BF150
6.0	rechts/right	BF150D/6
6.0	links/left	BF150S/6

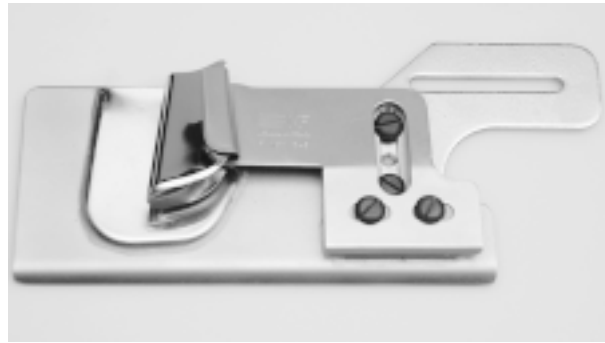

BF150S

BF150D/6

Kapper zum Einnähen von Schulterstücken auf Einnadelmaschinen mit Obertransport, geeignet für leichte bis mittlere Materialien.
Shoulder joint feller for single needle flatbed machines with upper feed, suitable for light up to medium fabric.

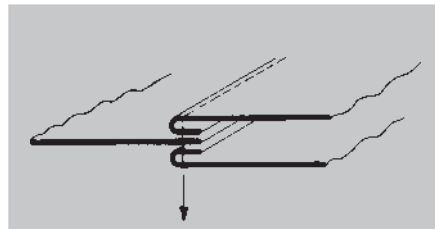

BF150S/6

Kapper wie unter BF150D/6 beschrieben, jedoch mit Kapprichtung links.
Feller as described under BF150D/6, but with leftturn fold.

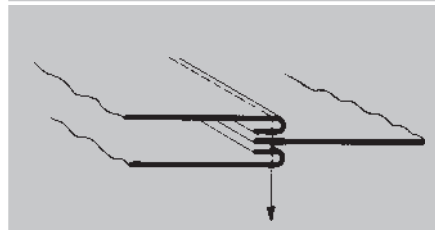

Spezialkapper für Hemdenproduktion *Special Feller for shirt production*

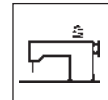

Kappbreite <i>Felling Width</i> <i>in mm</i>	BF51L	BF51R
6.0	BF51L/6	BF51R/6
13.0	BF51L/13	BF51R/13



BF51L

BF51L

Kapper zum Zusammenfügen von Hemdrücken und Schulterpartie, verstellbar, Kapprichtung links.
Adjustable top stitch joiner attachment with left downturn feller.

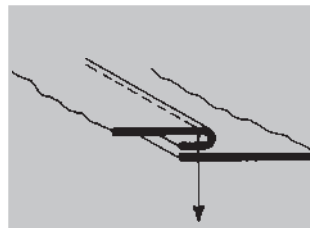

BF51R

Kapper wie unter BF51L beschrieben, jedoch Kapprichtung rechts.
Feller as described under BF51L, but with right downturn feller.

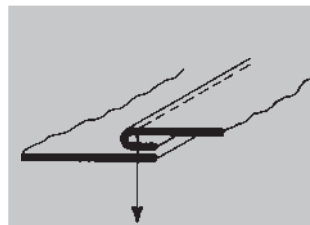

Spezialkapper für Hemdenproduktion
Special Feller for shirt production



Kappbreite <i>Felling Width</i> <i>in mm</i>	BF315
7.0	BF315/7L
10.0	BF315/10L

BF315

Kapper zum Nähen von Hemdrücken-Kappnähten (Imitierte Kappnaht).
Feller for shirt back seams (imitated lap seam).

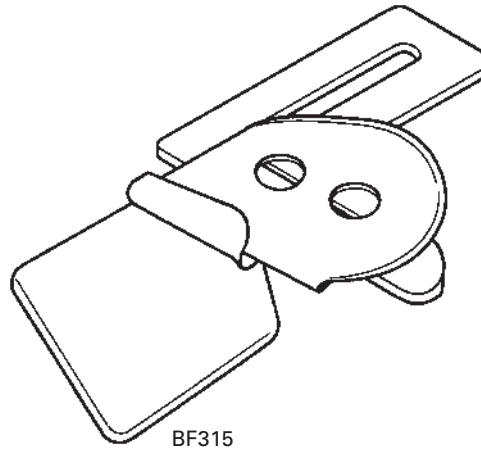

BF315

Geeignete Nähwerkzeuge finden Sie unter:
For suitable sewing parts please refer to:

Apparatefüße: Kap.1.1 Seite 22-24
Stichplatten/Transporteure: Kap.1.1 Seite 40
Attachment feet: Kap.1.1 Seite 22-24
Needle plates / Feed dogs: Kap.1.1 Seite 40

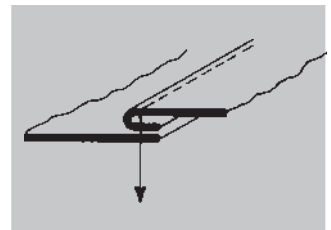

Spezialkapper
Special Feller



Kappbreite <i>Felling Width</i> <i>in mm</i>	BF145
8.0	BF145/8L
8.0	BF145/8
8.0	BF145/8H

BF145

Verstellbarer Zweifachkapper zum Fertigen von gegenläufigen Kappnähten auf Einnadel-Flachbettmaschinen.
Adjustable top stitch joining attachment for single-needle flatbed machines.

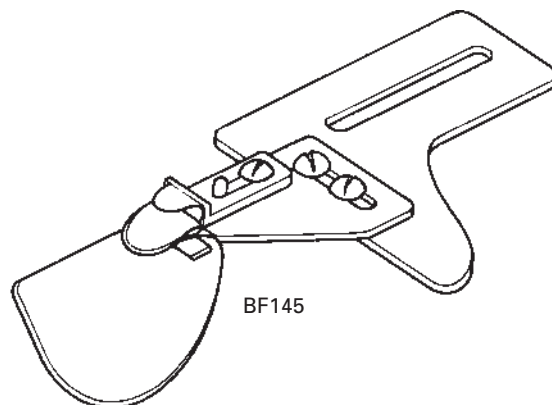

BF145

Geeignete Nähwerkzeuge finden Sie unter:
For suitable sewing parts please refer to:

Apparatefüße: Kap.1.1 Seite 22-24
Attachment feet: Kap.1.1 Seite 22-24

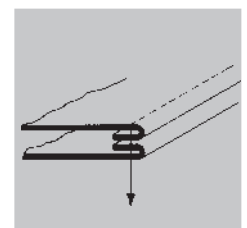

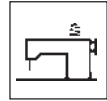
Kapper mit Umbug oben
Feller with upper fold

Kappbreite Felling Width in mm	SUISEI A7SU	BF75U	BF75UGA	BF76UGA
4.0		BF75U/4	BF75UGA/4	
5.0	BA-1396s	BF75U/5	BF75UGA/5	BF75UGA/5
6.0	BA-1397s	BF75U/6	BF75UGA/6	
7.0		BF75U/7	BF75UGA/7	BF76UGA/7
8.0	BA-1398s	BF75U/8	BF75UGA/8	
9.0		BF75U/9	BF75UGA/9	
10.0	BA-1399s	BF75U/10	BF75UGA/10	BF76UGA/10
12.0		BF75U/12	BF75UGA/12	BF76UGA/12
13.0	BA-1400s			
15.0	BA-1401s	BF75U/15	BF75UGA/15	
20.0	BA-1402s	BF75U/20	BF75UGA/20	
25.0	BA-1403as	BF75U/25M	BF75UGA/25	
30.0		BF75U/30M	BF75UGA/30	
35.0		BF75U/35M	BF75UGA/35	
40.0		BF75U/40M	BF75UGA/40	
45.0		BF75U/45	BF75UGA/45	
50.0		BF75U/50	BF75UGA/50	

SUISEI A7SU

Kapper, ausschwenkbar, für leichte bis mittlere Ware.
Swing-out feller for light up to medium fabric.

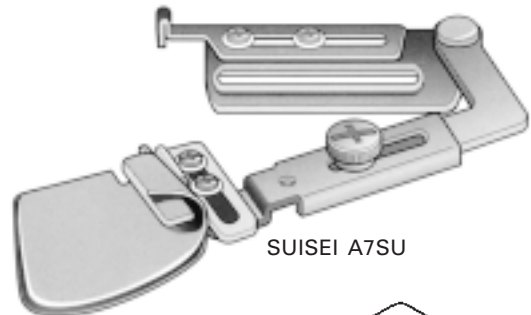

SUISEI A7SU

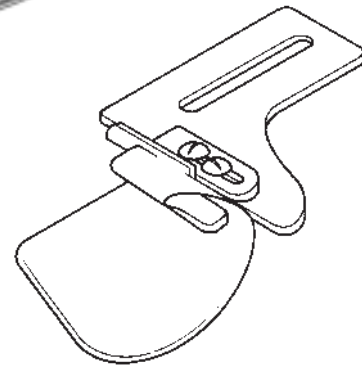

BF75U

BF75U

Kapper, starr, für leichte bis mittlere Ware
Fixed feller for light up to medium fabric.

BF75UGA

Kapper, ausschwenkbar, für leichte bis mittlere Ware.
Swing-out feller for light up to medium fabric.

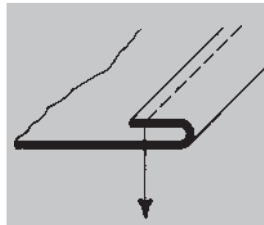

BF75UGA

BF76UGA

Kapper, ausschwenkbar, gefedert, für leichte bis mittlere Ware, geeignet zum Kappen über Quernähte hinweg.
Swing-out feller with spring suspension for light up to medium fabric, suitable to let cross-seams pass through.

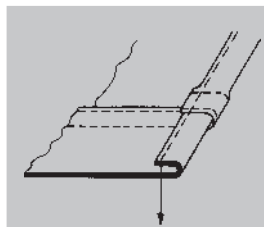

BF76UGA

Geeignete Nähwerkzeuge finden Sie unter:
For suitable sewing parts please refer to:

Apparatefüße: Kap.1.1 Seite 22-24
Stichplatten/Transporteure: Kap.1.1 Seite 40
Attachment feet: Kap.1.1 Seite 22-24
Needle plates / Feed dogs: Kap.1.1 Seite 40

Kapper mit Umbug unten
Feller with lower fold



Kappbreite Felling Width in mm	SUISEI A7SD	BF75D	BF75DGA
5.0	BA-1404s		
6.0	BA-1405s	BF75D/6	BF75DGA/6
8.0	BA-1406s	BF75D/8	BF75DGA/8
10.0	BA-1407s	BF75D/10	BF75DGA/10
12.0		BF75D/12	BF75DGA/12
13.0	BA-1408s		
15.0	BA-1409s		
20.0	BA-1410s		
25.0	BA-1412s		

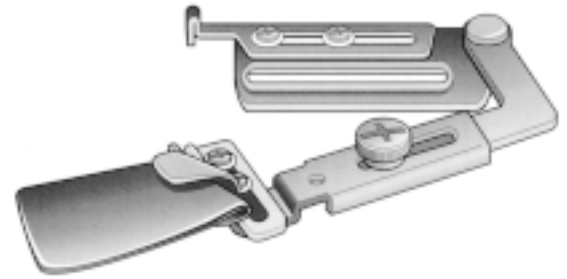

SUISEI A7SD

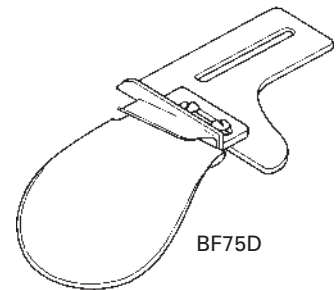

BF75D

SUISEI A7SD

Kapper, ausschwenkbar, für leichte bis mittlere Ware.
Swing-out feller for light up to medium fabric.

BF75D

Kapper, starr, für leichte bis mittlere Ware.
Fixed feller for light up to medium fabric.

BF75DGA

Kapper, ausschwenkbar, für leichte bis mittlere Ware.
Swing-out feller for light up to medium fabric.

Geeignete Nähwerkzeuge finden Sie unter:
For suitable sewing parts please refer to:
Apparatefüße: Kap.1.1 Seite 22-24
Stichplatten/Transporteure: Kap.1.1 Seite 40
Attachment feet: Kap.1.1 Seite 22-24
Needle plates / Feed dogs: Kap.1.1 Seite 40



BF75DGA



Kapper mit Umbug unten
Feller with lower fold

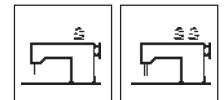

Kappbreite Felling Width in mm	BF1086	BF1087
8.0		BF1087/8
8.0		BF1087/8H
10.0		BF1087/10
10.0		BF1087/10H
15.0		BF1087/15
15.0		BF1087/15H
20.0	BF1086/20	BF1087/20
20.0	BF1086/20MH	
20.0	BF1086/20H	BF1087/20H
25.0	BF1086/25	BF1087/25
25.0	BF1086/25H	BF1087/25H
30.0	BF1086/30	BF1087/30
30.0	BF1086/30H	BF1087/30H
35.0	BF1086/35	
35.0	BF1086/35H	
40.0	BF1086/40	
40.0	BF1086/40H	

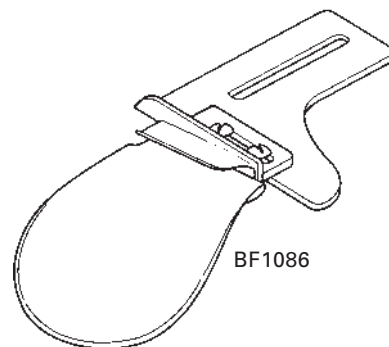

BF1086

BF1086

Kapper zum Fertigen von Halsausschnitten an mittleren bis voluminösen Strickwaren.
Neck feller for medium up to heavy knit materials.

BF1087

Kapper für gerade Kappnähte bei mittleren bis voluminösen Strickwaren.
Feller for straight sewing of medium up to heavy knit materials.

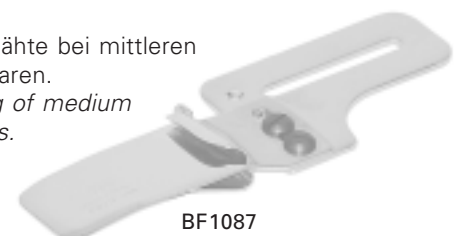

BF1087

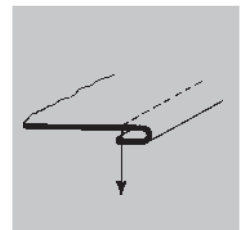

Kapper mit Umbug unten Feller with lower fold

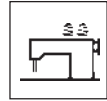

Kappbreite Felling Width in mm	BF45	BF65	BF80	BF85
10.0	BF45/10M			
8.0 - 15.0				BF85
10.0 - 20.0			BF80	
20.0 - 35.0		BF65		

BF45

Kapper für Zweinnadel-Flachbettmaschinen,
geeignet für feine Strickware und T-Shirts.
*Feller for double needle flatbed machines,
suitable for fine knitted material and T-shirts.*



BF45

BF65

Kapper, ausschwenkbar und verstellbar,
zum Erstellen geschlossener Rundkappnähte bei
mittelschweren Strickwaren.
*Swing-out adjustable feller for sewing tubular
knitted medium-heavy materials.*

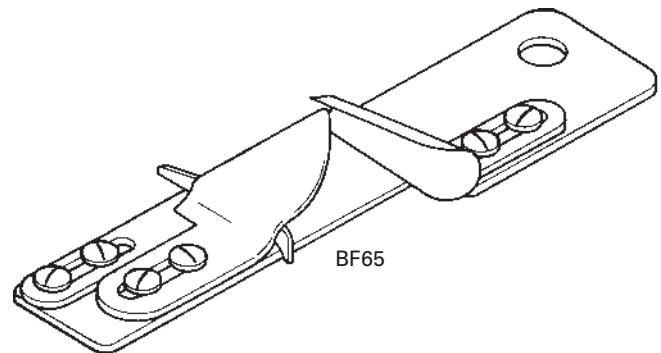

BF65

BF80

Kapper, verstellbar, für mittlere Strickwaren.
Adjustable Feller for medium knit fabrics.

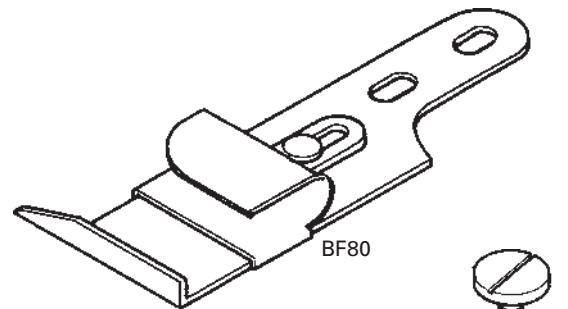

BF80

BF85

Kapper, ausschwenkbar und verstellbar,
zum Erstellen von Kappnähten an mittlerer Schlauchware.
*Swing-out adjustable feller for sewing tubular
knitted medium fabric.*

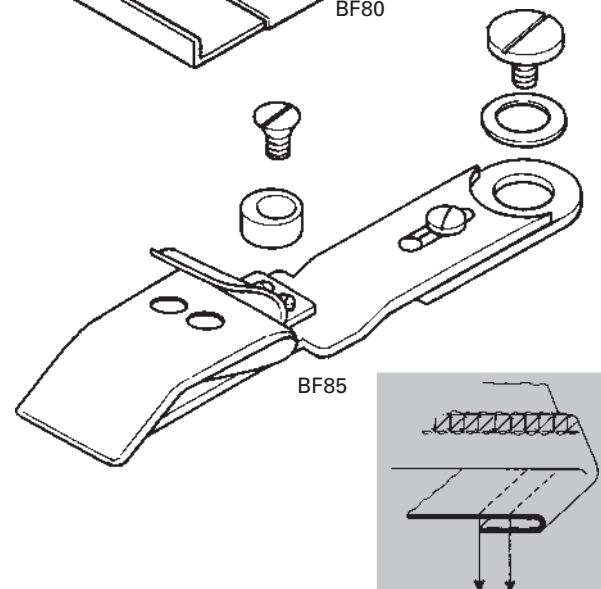

BF85

Säumer mit Umbug oben, starr
Hemmer with upper fold, fixed



Saumbreite <i>Hemming Width in mm</i>	BF106	BF400	BF450	BF470
1.6		BF400/1.6	BF450/1.6	
2.0			BF450/2.0	
3.2		BF400/3.2	BF450/3.2	
4.0				BF470/4
4.8		BF400/4.8	BF450/4.8	
5.0	BF106/5			BF470/5
6.0	BF106/6			BF470/6
6.4		BF400/6.4	BF450/6.4	
7.0	BF106/7			BF470/7
8.0	BF106/8			BF470/8
9.0	BF106/9			BF470/9
9.5		BF400/9.5	BF450/9.5	
10.0	BF106/10			BF470/10
11.0				BF470/11
12.0	BF106/12			BF470/12
12.7		BF400/12.7		
13.0				BF470/13
14.0	BF106/14			BF470/14
15.0				BF470/15
16.0				BF470/16
17.0				BF470/17
18.0	BF106/18			BF470/18
19.0				BF470/19
20.0				BF470/20



BF106

Säumer für leichte bis mittlere Ware, geeignet zum Säumen gerader Kanten oder weiter Linksbögen.

Hemmer for light up to medium fabrics, suitable for hemming straight or left-turn edges.

BF400

Säumer für leichte bis mittlere Ware, für gerade und weite Bogensäume geeignet.

Hemmer for light up to medium fabrics, suitable for straight or large curve hemming.

BF470

Säumer für leichte bis mittlere Ware mit verlängerter Stoffführung. Besonders zum Säumen kurzer Materialstreifen geeignet.

Hemmer for light up to medium fabric with long fabric guide for perfect straight hemming of short stripes.

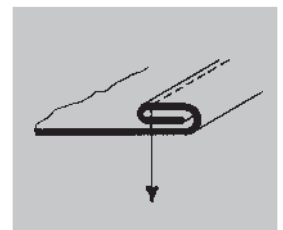

BF450

Säumer, gefedert, für leichte bis mittlere Ware, geeignet zum Säumen über Quernähte hinweg.

Hemmer for light up to medium fabrics, with additional spring suspension to let cross-seams pass through.

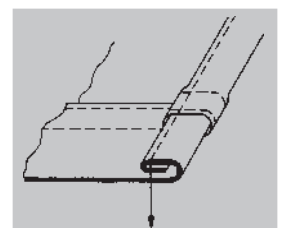
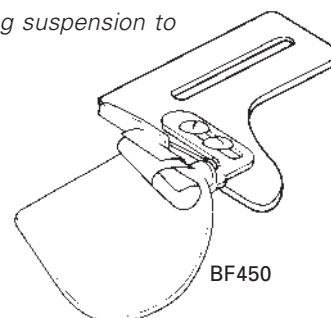

Geeignete Nähwerkzeuge finden Sie unter:
For suitable sewing parts please refer to:

Apparatefüße: Kap.1.1 Seite 22-24
Stichplatten/Transporteure: Kap.1.1 Seite 40
Attachment feet: Kap.1.1 Seite 22-24
Needle plates / Feed dogs: Kap.1.1 Seite 40

Säumer mit Umbug oben, starr *Hemmer with upper fold, fixed*

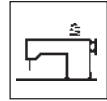

Saumbreite <i>Hemming Width</i> <i>in mm</i>	BF413
3.2+4.8	BF413/3.2-4.8
3.2+6.4	BF413/3.2-6.4
4.8+6.4	BF413/4.8-6.4
6.4+9.5	BF413/6.4-9.5



BF413

Säumer mit jeweils zwei Nahtbreiten je Apparat, geeignet für Flachbettmaschinen.
Hemmer with two hem sizes per attachment, suitable for flatbed sewing machines.

Geeignete Nähwerkzeuge finden Sie unter:
For suitable sewing parts please refer to:

Apparatefüße: Kap.1.1 Seite 22-24

Stichplatten/Transporteure: Kap.1.1 Seite 40

Attachment feet: Kap.1.1 Seite 22-24

Needle plates / Feed dogs: Kap.1.1 Seite 40

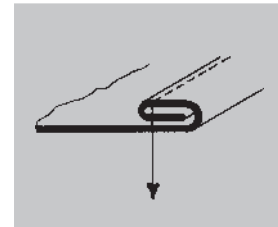

Säumer mit Umbug oben, starr *Hemmer with upper fold, fixed*

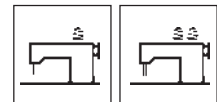

Saumbreite <i>Hemming Width</i> <i>in mm</i>	BF105	BF115
10.0	BF105/10	
10.0	BF105/10H	
12.0	BF105/12	
12.0	BF105/12H	
15.0		BF115/15XH
20.0		BF115/20XH
25.0		BF115/25XH
30.0		BF115/30XH
35.0		BF115/35XH
40.0		BF115/40XH

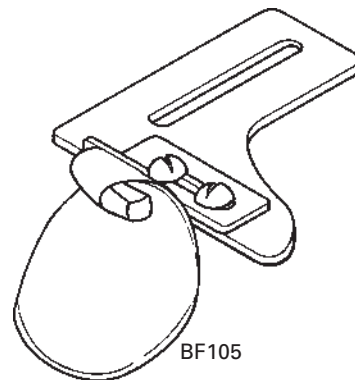

BF105

Säumer für mittlere bis schwere Materialien, gleichermaßen für gerade und geschwungene Taschensäume geeignet.

Hemmer for straight and curved pockets, suitable for medium up to heavy materials.

BF115

Säumer für besonders voluminöse Ware wie Frottee (Bademäntel, etc).

Hemmer for extra thick material like bath wraps.

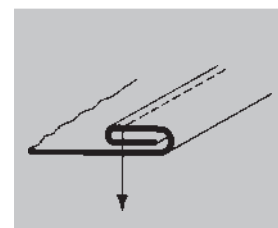

Säumer mit Umbug oben, abschwenkbar
Swing-out Hemmer with upper fold



Saumbreite <i>Hemming Width in mm</i>	SUISEI A11S	BF72B	BF106GA	BF70	SUISEI A50
1.6				BF70/1.6	
2.0				BF70/2.0L	
3.0					BA50/3s
3.2				BF70/3.2L	
4.0		BF72B/4			BA50/4s
4.8				BF70/4.8L	
4.8				BF70/4.8	
5.0		BF72B/5	BF106GA/5		BA50/5s
6.0	BA-1365s	BF72B/6	BF106GA/6		BA50/6s
6.4				BF70/6.4L	
6.4				BF70/6.4	
7.0		BF72B/7	BF106GA/7		BA50/7s
8.0				BF70/8.0L	BA50/8s
8.0	BA-1366s	BF72B/8	BF106GA/8	BF70/8.0	
9.0		BF72B/9	BF106GA/9		
9.5				BF70/9.5L	
9.5				BF70/9.5	
10.0	BA-1367s	BF72B/10	BF106GA/10		
12.0		BF72B/12	BF106GA/12		
12.7				BF70/12.7L	
12.7				BF70/12.7	
13.0	BA-1368s				
14.0				BF70/14.0L	
14.0				BF70/14.0	
14.0		BF72B/14	BF106GA/14		
15.0	BA-1369s				
16.0		BF72B/16			
18.0	BA-1370s		BF106GA/18		
19.0		BF72B/19			
20.0	BA-1371s	BF72B/20			
22.0		BF72B/22			
25.0	BA-1372s	BF72B/25			
28.0		BF72B/28			
30.0	BA-1373s	BF72B/30			
32.0		BF72B/32			
35.0	BA-1374s	BF72B/35			
38.0		BF72B/38			
40.0	BA-1375s	BF72B/40			
45.0	BA-1376s	BF72B/45			
50.0	BA-1377s	BF72B/50			
55.0		BF72B/55			
60.0		BF72B/60			
70.0		BF72B/70			
76.0		BF72B/76			
88.0		BF72B/88			
100.0		BF72B/100			

Fortsetzung siehe nächste Seite
To be continued next page

Säumer mit Umbug oben, abschwenkbar *Swing-out Hemmer with upper fold*

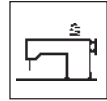

SUISEI A11S

Säumer für leichte bis mittlere Ware, für alle Saumarbeiten an Bekleidung, Gardinen, etc. geeignet.
Hemmer for light up to medium fabrics, suitable for hemming apparels, curtains, draperies, etc.

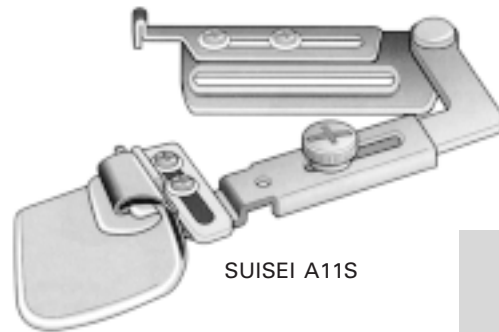

SUISEI A11S



BF72B

Säumer für leichte bis mittlere Ware, für alle Saumarbeiten an Bekleidung, Gardinen, etc. geeignet.
Hemmer for light up to medium fabrics, suitable for hemming apparels, curtains, draperies, etc.



BF72B

BF106GA

Säumer für leichte bis mittlere Ware, geeignet zum Säumen gerader Kanten oder weiter Linksbögen.
Hemmer for light up to medium fabrics, suitable for hemming straight or left-turn edges.



BF106GA

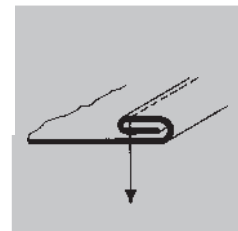

BF70

Säumer, gefedert, für leichte bis mittlere Materialien, geeignet für das Säumen über Quernähte hinweg.
Hemmer with spring-suspension for light up to medium fabrics, to let cross-seams pass through.

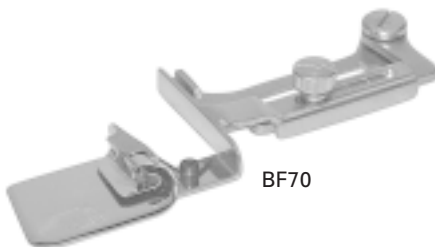

BF70

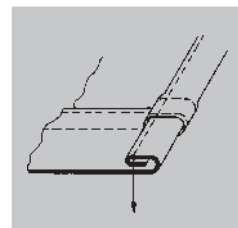

SUISEI A50

Kurvensäumer für besonders feine Materialien, komplett mit Ausgleichsgelenkfuß und zusätzlicher Materialzuführungsblech.
Curve edge swing hemmer set for extra light materials, complete with compensating foot and levelling plate.

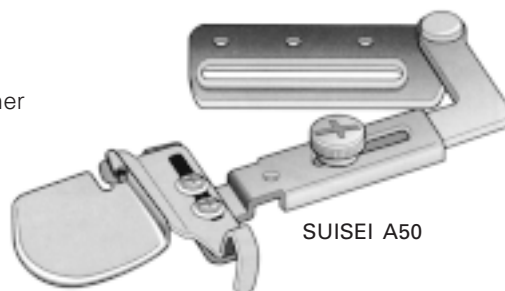

SUISEI A50

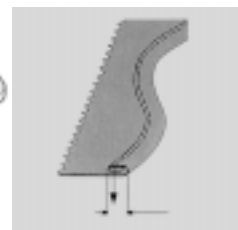

Geeignete Nähwerkzeuge finden Sie unter:
For suitable sewing parts please refer to:

Apparatefüße:	Kap.1.1 Seite 22-24
Stichplatten/Transporteure:	Kap.1.1 Seite 40
Attachment feet:	Kap.1.1 Seite 22-24
Needle plates / Feed dogs:	Kap.1.1 Seite 40

Säumer mit Umbug oben, abschwenkbar
Swing-out Hemmer with upper fold

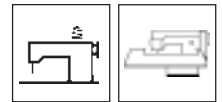

Saumbreite Hemming Width in mm	BF72PI
4.0	BF72PI/4
5.0	BF72PI/5
6.0	BF72PI/6
7.0	BF72PI/7
8.0	BF72PI/8
9.0	BF72PI/9
10.0	BF72PI/10
12.0	BF72PI/12
13.0	BF72PI/13
14.0	BF72PI/14
16.0	BF72PI/16
19.0	BF72PI/19
20.0	BF72PI/20
22.0	BF72PI/22
25.0	BF72PI/25
28.0	BF72PI/28
30.0	BF72PI/30
32.0	BF72PI/32
35.0	BF72PI/35
38.0	BF72PI/38
40.0	BF72PI/40
45.0	BF72PI/45
50.0	BF72PI/50
55.0	BF72PI/55
60.0	BF72PI/60
64.0	BF72PI/64
70.0	BF72PI/70
76.0	BF72PI/76
80.0	BF72PI/80
88.0	BF72PI/88
100.0	BF72PI/100
127.0	BF72PI/127

BF72PI

Ausschwenkbarer Säumer mit voll einschlagendem Umbug, besonders geeignet für Saumarbeiten an leichter Ware auf Blindstichmaschinen.

Swing-out hemmer with complete 3-way-fold, especially assigned for hemming light fabrics with blindstitch machines.

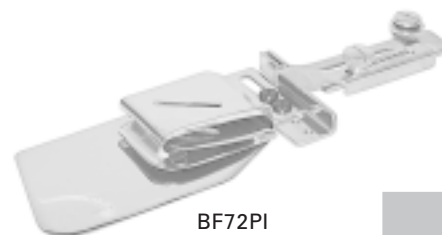

BF72PI

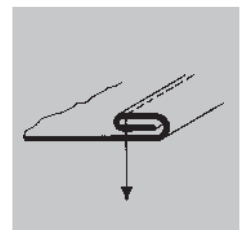

Säumer mit Umbug oben, abschwenkbar
Swing-out Hemmer with upper fold

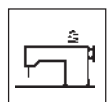

Saumbreite Hemming Width in mm	BF77
19.0	BF77/19
25.0	BF77/25
32.0	BF77/32
38.0	BF77/38
50.0	BF77/50



BF77



BF77

Säumer zum Erstellen von Knopflochleisten an Hemden und Blusen.

Hemmer for sewing button stays at shirts and blouses.

Geeignete Nähwerkzeuge finden Sie unter:

For suitable sewing parts please refer to:

Apparatefüße: Kap.1.1 Seite 22-24

Stichplatten/Transporteure: Kap.1.1 Seite 40

Attachment feet: Kap.1.1 Seite 22-24

Needle plates / Feed dogs: Kap.1.1 Seite 40

Säumer mit Umbug oben, abschwenkbar *Swing-out Hemmer with upper fold*

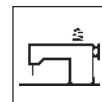

Saumbreite <i>Hemming Width</i> <i>in mm</i>	BF73
6.0-13.0	BF73/6-13
14.0-20.0	BF73/14-20
21.0-28.0	BF73/21-28

BF73

Ausschwenkbarer Säumer für leichte bis mittlere Ware, für Saumarbeiten an Bekleidung, Gardinen etc. Die Saumbreite kann bei diesem Säumer individuell eingestellt werden; es stehen drei Größenbereiche zur Verfügung.

Swing-out hemmer for light up to medium fabrics, for hemming apparels, curtains, etc. This hemmer offers the possibility to adjust the hem size individually; there are three different size ranges available.

Geeignete Nähwerkzeuge finden Sie unter:
For suitable sewing parts please refer to:

Apparatefüße: Kap.1.1 Seite 22-24
Stichplatten/Transporteure: Kap.1.1 Seite 40
Attachment feet: Kap.1.1 Seite 22-24
Needle plates / Feed dogs: Kap.1.1 Seite 40



BF73

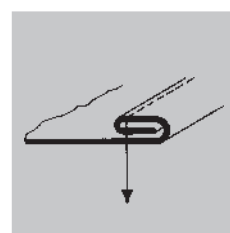

Säumer mit Umbug oben, aufklappbar *Latch Hemmer with upper fold*

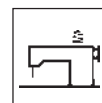

Saumbreite <i>Hemming Width</i> <i>in mm</i>	SUISEI A78S	BF78
6.0		BF78/6
6.4	BA-1390s	
8.0	BA-1390as	BF78/8
9.5	BA-1391s	
10.0		BF78/10
12.0		BF78/12
12.7	BA-1392s	
15.9	BA-1393s	
16.0		BF78/16
19.0	BA-1394s	
20.0		BF78/20
25.0		BF78/25
25.4	BA-1395s	
30.0		BF78/30
40.0		BF78/40

SUISEI A78S

Aufklappbarer, ausschwenkbarer Säumer für leichte bis mittlere Materialien, geeignet zum Erstellen geschlossener Rundsäume (Hosenbeine, Ärmel, etc.).

Swing-away latch hemmer for light up to medium fabrics, suitable to produce bottom hems on dresses, shorts, pyjama legs and any other circular garments.

BF78

Säumer, aufklappbar, für leichte bis mittlere Materialien, geeignet zum Erstellen geschlossener Rundsäume (Hosenbeine, Ärmel, etc.).

Latch hemmer for light up to medium fabrics, suitable to produce bottom hems on dresses, shorts, pyjama legs and any other circular garments.

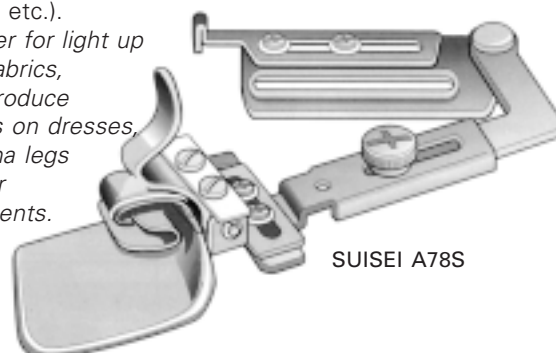

SUISEI A78S



BF78



Geeignete Nähwerkzeuge finden Sie unter:
For suitable sewing parts please refer to:

Apparatefüße: Kap.1.1 Seite 22-24
Stichplatten/Transporteure: Kap.1.1 Seite 40
Attachment feet: Kap.1.1 Seite 22-24
Needle plates / Feed dogs: Kap.1.1 Seite 40

Säumer mit Umbug unten, starr
Hemmer with lower fold, fixed

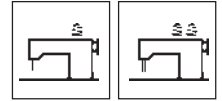

Saumbreite <i>Hemming Width</i> <i>in mm</i>	BF1120	BF1125	BF180
5.0		BF1125/5	
5.0		BF1125/5MH	
6.0		BF1125/6	
6.0		BF1125/6MH	
7.0		BF1125/7	
7.0		BF1125/7MH	
8.0	BF1120/8H		
8.0		BF1125/8MH	
9.0		BF1125/9MH	
10.0	BF1120/10H		
10.0		BF1125/10MH	
12.0			BF180/12
12.0	BF1120/12H		BF180/12H
12.0		BF1125/12MH	
14.0		BF1125/14MH	

BF1120

Säumer für mittlere bis schwere Materialien. Gleichmaßen für gerade und geschwungene Taschensäume geeignet.
Hemmer for straight and curved pockets, suitable for medium up to heavy materials.

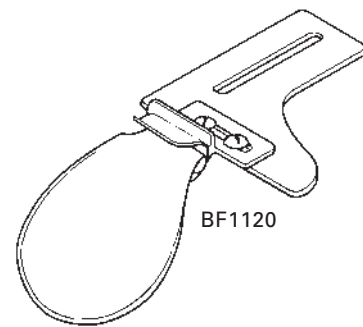

BF1120

BF1125

Säumer für mittlere bis mittelschwere Ware, geeignet zum Säumen gerader Kanten oder weiter Linksbögen.
Fixed hemmer for medium up to medium-heavy fabrics, suitable for straight or wide left-turn hemming.

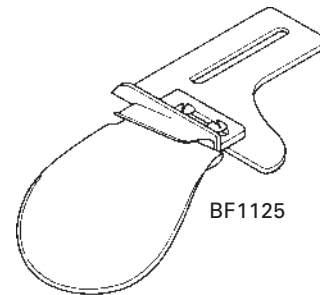

BF1125

BF180

Säumer für mittlere bis schwere Materialien, besonders geeignet zum Säumen der geraden Kanten an aufgesetzten Jeans-Taschen.
Hemmer for medium up to heavy materials, suitable for straight hems at jeans patch pockets.



BF180

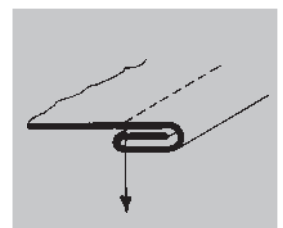

Säumer mit Umbug unten, abschwenkbar Swing-out Hemmer with lower fold

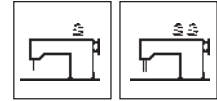

Saumbreite Hemming Width in mm	BF1125GA	BF125
5.0	BF1125GA/5	
6.0	BF1125GA/6	
7.0	BF1125GA/7	
8.0	BF1125GA/8	BF125/8
8.0		BF125/8H
9.0	BF1125GA/9	
10.0	BF1125GA/10	BF125/10
10.0		BF125/10H
10.0	BF1125GA/10MH	
12.0	BF1125GA/12	BF125/12
12.0		BF125/12H
12.0	BF1125GA/12MH	
14.0	BF1125GA/14MH	

BF1125GA

Säumer, ausschwenkbar, für mittlere bis mittelschwere Ware, geeignet zum Säumen gerader Kanten oder weiter Linksbögen.
Swing-out hemmer for medium up to medium-heavy fabrics, suitable for straight or wide left-turn hemming.

BF125

Säumer, ausschwenkbar, zum Säumen mittlerer bzw. schwerer Materialien auf Zweinadel-Flachbettmaschinen.
Swing-out hemmer for medium and heavy fabrics on double needle flatbed machines.



BF1125GA

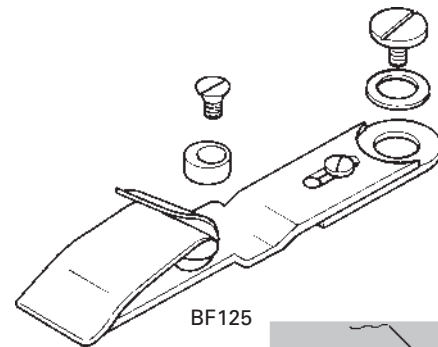

BF125

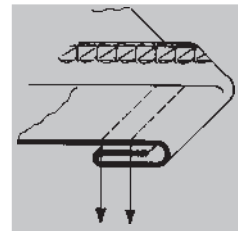

Kapper und Säumer mit Kordelzuführung Feller and Hemmer with cord guide

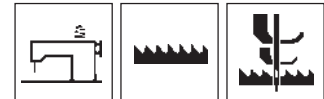

Saumbreite Hemming Width in mm	BF19	BF21
10.0	BF19/10	
16.0	BF19/16	
19.0	BF19/19	
25.0		BF21/25
30.0		BF21/30

BF19

Kapper für mittlere Ware, lieferbar für Kordelstärke 2,5 mm, geeignet für Flachbettmaschinen.
Feller for medium fabric, available for cord size 2,5 mm, suitable for flatbed machines.

BF21

Kapper für mittlere Ware, lieferbar für Kordelstärken bis zu 7 mm, geeignet für Flachbettmaschinen.
Feller for medium fabric, available for cord sizes up to 7 mm, suitable for flatbed machines.

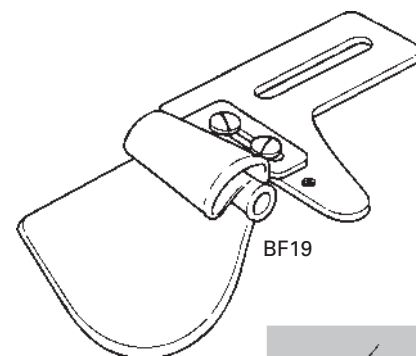

BF19

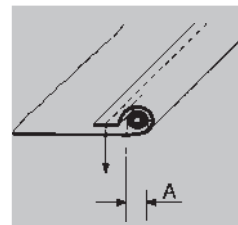

Geeignete Nähwerkzeuge finden Sie unter:
For suitable sewing parts please refer to:

Apparatefüße: Kap.1.1 Seite 15-18
Attachment feet: Kap.1.1 Seite 15-18

Kapper und Säumer mit Kordelzuführung
Feller and Hemmer with cord guide

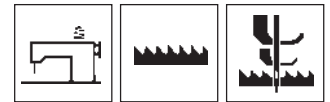

Saumbreite Hemming Width in mm	BF74	BF174
10.0	BF74/10	
12.0	BF74/12	
14.0	BF74/14	
16.0	BF74/16	
18.0	BF74/18	
20.0		BF174/20
25.0		BF174/25
30.0		BF174/30

BF74

Säumer für mittlere Ware, lieferbar für Kordelstärke 2,5 mm, geeignet für Flachbettmaschinen.

Hemmer for medium fabric, available for cord size 2,5 mm, suitable for flatbed machines.

BF174

Säumer für mittlere Ware, lieferbar für Kordelstärken bis zu 7 mm, geeignet für Flachbettmaschinen.

Hemmer for medium fabric, available for cord sizes up to 7 mm, suitable for flatbed machines.

Geeignete Nähwerkzeuge finden Sie unter:
For suitable sewing parts please refer to:

Apparatefüße: Kap.1.1 Seite 15-18
Attachment feet: Kap.1.1 Seite 15-18

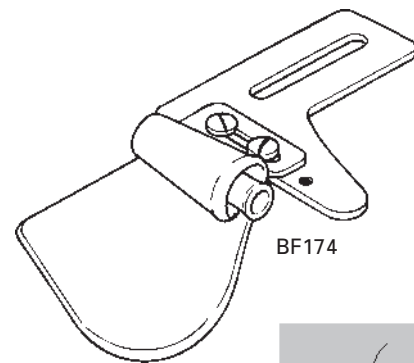

BF174

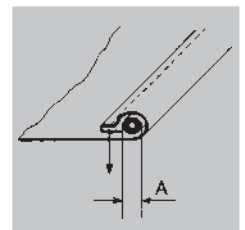

Kapper und Säumer mit Gummibandzuführung
Feller and Hemmer with elastic tape guide

Bandbreite Tape Size in mm	BF91	SUISEI A43L
6.0	BF91/6	
10.0	BF91/10	
16.0		BA-1437as
20.0		BA-1437s



SUISEI A43L

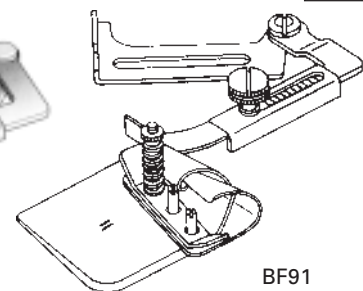

BF91

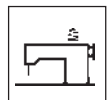

BF91

Säumer, ausschwenkbar, zum Säumen mit elastischen Bändern auf Einnadelmaschinen ohne Anfangs- oder Endverriegelung. Mit Hilfe der integrierten Gummibandbremse kann die Kräuselung des Saumes reguliert werden.

Swing-out hemmer that stitches elastic end-to-end while sewing and eliminates tacking at both ends. Amount of gathering is obtained by adjusting special tension bracket.

SUISEI A43L

Säumer, ausschwenkbar und aufklappbar, mit Gummibandzuführung, geeignet zur Herstellung elastischer Rundsäume auf Einnadel-Flachbettmaschinen.

Latch hemmer with elastic tape insertion, suitable for production of elastic round seams on single needle flatbed machines.

Geeignete Nähwerkzeuge finden Sie unter:
For suitable sewing parts please refer to:

Apparatefüße: Kap.1.1 Seite 22-24
Stichplatten/Transporteure: Kap.1.1 Seite 40
Attachment feet: Kap.1.1 Seite 22-24
Needle plates / Feed dogs: Kap.1.1 Seite 40

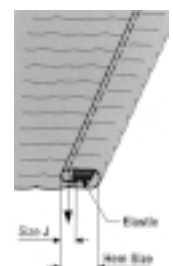

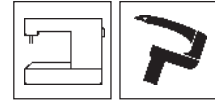
Kapper und Säumer mit Gummibandzuführung
Feller and Hemmer with elastic tape guide

Saumbreite <i>Hemming Width</i> <i>in mm</i>	Gummibandbreite <i>Elastic Tape Width</i> <i>in mm</i>	BF1182	BF1185
8.0	6.0		BF1185/8
10.0	6.0	BF1182/10L	
10.0	6.0	BF1182/10	BF1185/10
12.0	10.0		BF1185/12
13.0	10.0	BF1182/13L	
13.0	10.0	BF1182/13	
13.0	10.0	BF1182/13H	
16.0	12.0	BF1182/16L	
16.0	12.0	BF1182/16	
16.0	12.0	BF1182/16H	
20.0	16.0	BF1182/20L	
20.0	16.0	BF1182/20	
20.0	16.0	BF1182/20H	
23.0	20.0	BF1182/23L	
23.0	20.0	BF1182/23	
23.0	20.0	BF1182/23H	
25.0	23.0	BF1182/25	
25.0	23.0	BF1182/25H	
27.0	23.0	BF1182/27L	
30.0	27.0	BF1182/30L	
30.0	27.0	BF1182/30	
30.0	27.0	BF1182/30H	
35.0	30.0	BF1182/35L	
35.0	30.0	BF1182/35	
35.0	30.0	BF1182/35H	

BF1182

Kapper mit Gummibandzuführung zum Fertigen elastischer Kappnähte mit Zweinadel-Flachbett Kettenstichmaschinen.

Feller with elastic tape insertion on double-needle flatbed chainstitch machines.

BF1185

Kapper mit Gummibandzuführung zum Fertigen von schmale Kappnähte an Leggings bzw. langbeinigen Unterhosen.

Feller with elastic tape insertion on double-needle flatbed chainstitch machines, especially designed for legging pants.

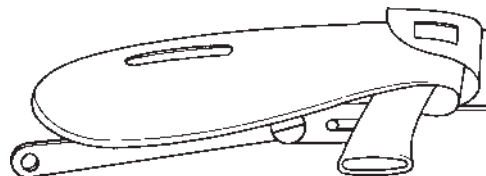

BF1182
BF1185

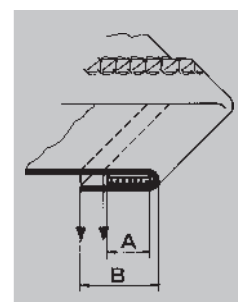

Kapper und Säumer mit Gummibandzuführung
Feller and Hemmer with elastic tape guide

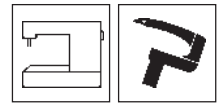

Saumbreite Hemming Width in mm	Gummibandbreite Elastic Tape Width in mm	BF385	BF387
8.0	6.0		BF387/8
10.0	6.0	BF385/10L	
10.0	8.0		BF387/10
12.0	6.0	BF385/12	
12.0	6.0	BF385/12H	
12.0	10.0		BF387/12
14.0	10.0	BF385/14	
14.0	10.0	BF385/14H	
18.0	16.0	BF385/18	
18.0	16.0	BF385/18H	

BF385

Säumer mit Gummibandzuführung zum Fertigen elastischer Säume mit Zweinadel-Flachbett Kettenstichmaschinen
Hemmer with elastic tape insertion on double-needle flatbed chainstitch machines.

BF387

Säumer mit Gummibandzuführung zum Fertigen von schmalen Säumen an Leggings bzw. langbeinigen Unterhosen mit Zweinadel-Flachbett Kettenstichmaschinen.
Hemmer with elastic tape insertion on double-needle flatbed chainstitch machines, especially designed for legging pants.

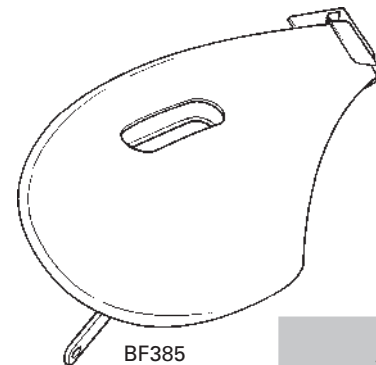

BF385

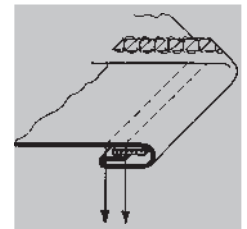

Kapper und Säumer mit Gummibandzuführung
Feller and Hemmer with elastic tape guide

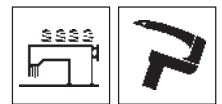

Saumbreite Hemming Width in mm	Gummibandbreite Elastic Tape Width in mm	BF1187	BF1292
25.0	23.0		BF1292/25
25.0	23.0		BF1292/25H
30.0	28.0		BF1292/30L
30.0	28.0		BF1292/30
30.0	28.0		BF1292/30H
33.0	25.0	BF1187/33	
36.0	34.0		BF1292/36L
36.0	34.0		BF1292/36
36.0	34.0		BF1292/36H
38.0	30.0	BF1187/38	
38.0	30.0	BF1187/38H	
41.0	33.0	BF1187/41	
41.0	33.0	BF1187/41H	
42.0	40.0		BF1292/42
44.0	36.0	BF1187/44	
44.0	36.0	BF1187/44H	
50.0	42.0	BF1187/50	

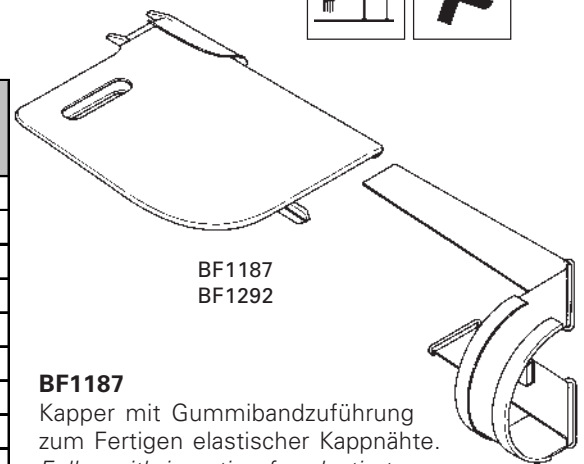

BF1187
BF1292

BF1187

Kapper mit Gummibandzuführung zum Fertigen elastischer Kappnähte.
Feller with insertion for elastic tape.

BF1292

Säumer mit Gummibandzuführung zum Fertigen elastischer Säume.
Hemmer with insertion for elastic tape.

BF1187

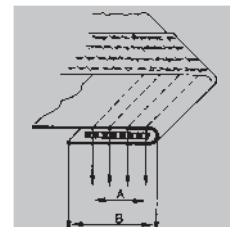

BF1292

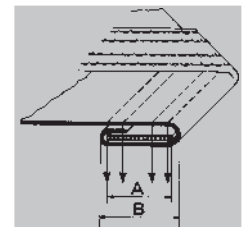

Paspelapparate für Flachbettmaschinen *Piping Attachment for flatbed machines*

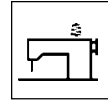

Paspelbreite <i>Piping Width</i> <i>in mm</i>	BF1025	BF1030
7.0		BF1030/7
8.0	BF1025/8	
9.0		BF1030/9
10.0	BF1025/10	BF1030/10
12.0	BF1025/12	
15.0	BF1025/15	
18.0	BF1025/18	
20.0	BF1025/20	

BF1025

Apparat zum Einnähen von Fertigpaspel mit Keder-
verstärkung.
Attachment for sewing ready-made cord piping.

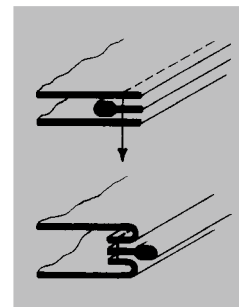
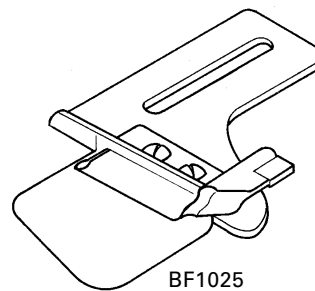

BF1030

Apparat zum Einnähen von Fertigpaspel.
Attachment for insertion of ready-made edging.

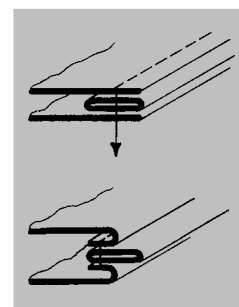
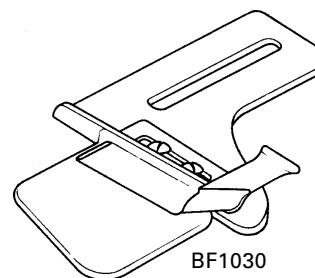

Geeignete Nähwerkzeuge finden Sie unter:
For suitable sewing parts please refer to:

Apparatefüße: Kap.1.1 Seite 15-18
Attachment feet: Kap.1.1 Seite 15-18

Paspelapparate für Flachbettmaschinen
Piping Attachment for flatbed machines



Bandbreite <i>Tape Size in mm</i>	Fertigbreite <i>Finished Size in mm</i>	BF1045	BF1050
12.0	6.0		BF1050/12
14.0	7.0	BF1045/14	
15.0	7.5		BF1050/15
19.0		BF1045/19	
19.0	9.5		BF1050/19
20.0	10.0		BF1050/20
20.0	10.0		BF1050/20H
22.0		BF1045/22	
22.0	11.0		BF1050/22
22.0	11.0		BF1050/22H
25.0		BF1045/25	
25.0	12.5		BF1050/25
25.0	12.5		BF1050/25H
30.0		BF1045/30	
30.0	15.0		BF1050/30
30.0	15.0		BF1050/30H
35.0	17.5		BF1050/35
35.0	17.5		BF1050/35H
40.0	20.0		BF1050/40
40.0	20.0		BF1050/40H
45.0	22.5		BF1050/45
45.0	22.5		BF1050/45H
50.0	25.0		BF1050/50
50.0	25.0		BF1050/50H
55.0	27.5		BF1050/55
55.0	27.5		BF1050/55H
60.0	30.0		BF1050/60
60.0	30.0		BF1050/60H
70.0	35.0		BF1050/70
70.0	35.0		BF1050/70H
90.0	45.0		BF1050/90

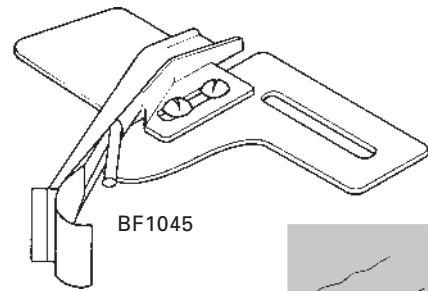

BF1045

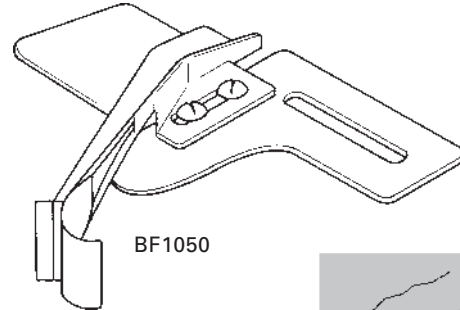
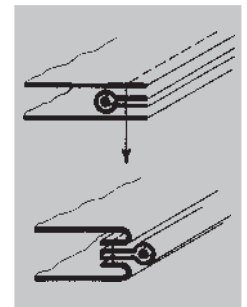

BF1050

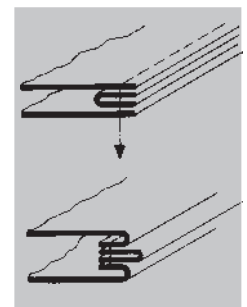

BF1045

Paspelapparat mit Kordelzuführung 2,5 mm zum Herstellen von Paspelvorstößen mit Kederkante.
Piping attachment with cord insertion 2.5 mm for sewing cord edge pipings.

BF1050

Apparat zum Herstellen von Paspelvorstößen.
Attachment for sewing edge pipings.

Geeignete Nähwerkzeuge finden Sie unter:
For suitable sewing parts please refer to:

Apparatefüße: Kap.1.1 Seite 15-18
Attachment feet: Kap.1.1 Seite 15-18

Paspelapparate für Flachbettmaschinen Piping Attachment for flatbed machines



Bandbreite Tape Size in mm	Kordelstärke Cord Size in mm	A46NP
26.0	5.0	BA46NP-26
28.0	5.0	BA46NP-28
30.0	5.0	BA46NP-30

A46NP

Paspelapparat mit Kordelzuführung, zum Herstellen von Paspelvorstößen mit Kederkante aus schweren Materialien auf Nadel- und Dreifach-Transport-Maschinen, wie Singer 111W, etc.

Cord edge piping attachment for heavy materials, suitable for needle feed and unison-feed machines like Singer 111W, etc.

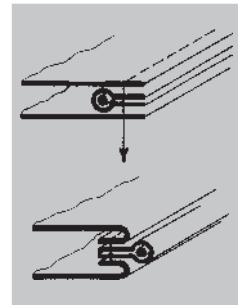
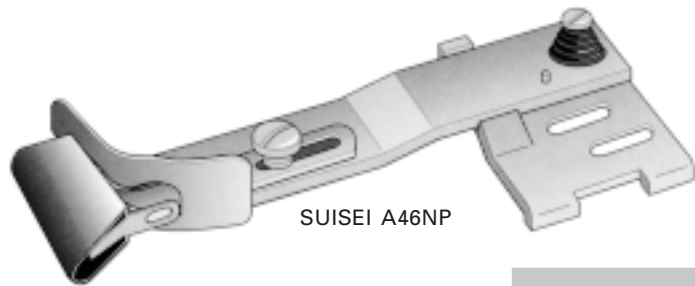

Paspelapparate für Overlockmaschinen Piping Attachment for overlock machines

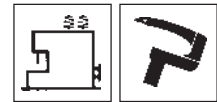

Paspelbreite Piping Width in mm	BF1015	BF1020	BF365
7.0			BF365/7
8.0		BF1020/8	BF365/8
9.0			BF365/9
10.0	BF1015/10	BF1020/10	BF365/10
10.0			BF365/10H
12.0	BF1015/12	BF1020/12	
12.0			BF365/12H
15.0	BF1015/15	BF1020/15	
18.0		BF1020/18	
20.0		BF1020/20	

BF1015

Apparat zum Einnähen von Fertigpaspel mit zusätzlicher Kederkante; Stoffanschlag verstellbar.

Attachment with adjustable fabric guide for ready-made piping with cord edge.

BF1020

Apparat zum Einnähen von Fertigpaspel mit zusätzlicher Kederkante.

Attachment for ready-made piping with cord edge.

BF365

Apparat zum Einnähen von Fertigpaspelvorstößen.

Attachment for insertion of ready-made edging.

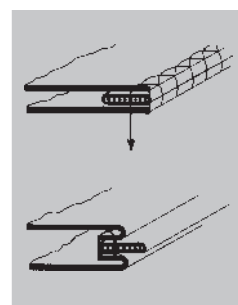
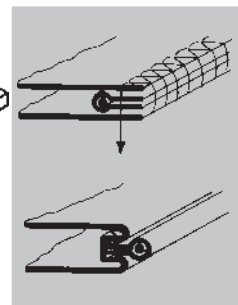
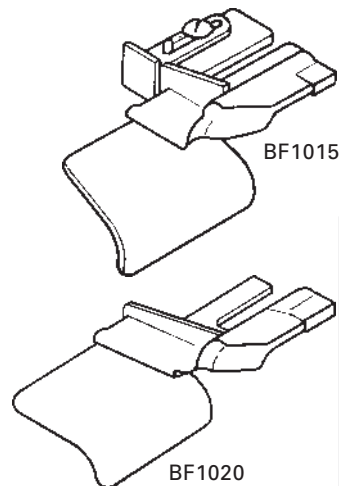

Paspelapparate für Overlockmaschinen
Piping Attachment for overlock machines

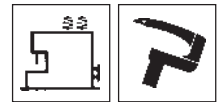

Bandbreite <i>Tape Size in mm</i>	Fertigbreite <i>Finished Size in mm</i>	BF1035	BF1040
12.0	6.0		BF1040/12
15.0	7.5		BF1040/15
19.0	9.5	BF1035/19	BF1040/19
20.0	10.0		BF1040/20
20.0	10.0		BF1040/20H
22.0	11.0	BF1035/22	BF1040/22
22.0	11.0		BF1040/22H
25.0	12.5	BF1035/25	BF1040/25
25.0	12.5		BF1040/25H
30.0	15.0	BF1035/30	BF1040/30
30.0	15.0		BF1040/30H
35.0	17.5		BF1040/35
35.0	17.5		BF1040/35H
40.0	20.0		BF1040/40
40.0	20.0		BF1040/40H
45.0	22.5		BF1040/45
45.0	22.5		BF1040/45H
50.0	25.0		BF1040/50
50.0	25.0		BF1040/50H
55.0	27.5		BF1040/55
55.0	27.5		BF1040/55H
60.0	30.0		BF1040/60
60.0	30.0		BF1040/60H
70.0	35.0		BF1040/70
70.0	35.0		BF1040/70H
90.0	45.0		BF1040/90

BF1035

Apparat mit Kordelzuführung 2,5 mm zum Herstellen von Paspelvorstößen mit Kederkante.
Attachment with cord insertion 2.5 mm for sewing cord edge pipings.

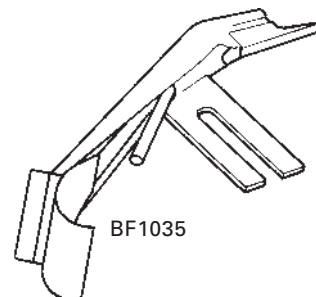

BF1035

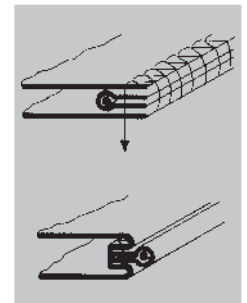

BF1040

Apparat zum Herstellen von Paspelvorstößen aus Web- bzw. Strickbändern.
Attachment for sewing edge pipings of fabric and knit tapes.

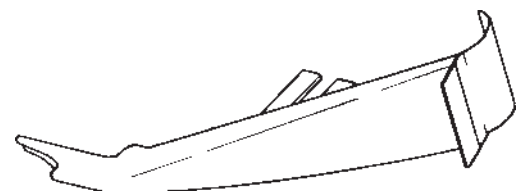

BF1040

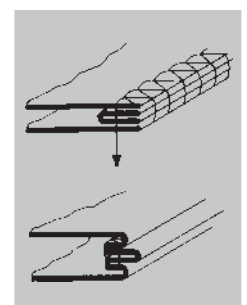

Paspelführungen für Börtchenapparate, Einfasser und Säumer Piping Guide for Split-tube Folder, Binder and Hemmer

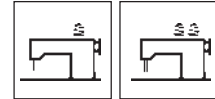

Paspelbreite Piping Width in mm	BF1060	BF1070
7.0		BF1070/7
8.0	BF1060/8	BF1070/8
9.0		BF1070/9
10.0	BF1060/10	BF1070/10
12.0	BF1060/12	
15.0	BF1060/15	

BF1060

Führung zum Einnähen von Fertigpaspelvorstößen mit Kederkante.

Guide for insertion of ready-made cord edge pipings.

BF1070

Führung zum Einnähen von Fertigpaspelvorstößen.

Guide for insertion of ready-made edge pipings.

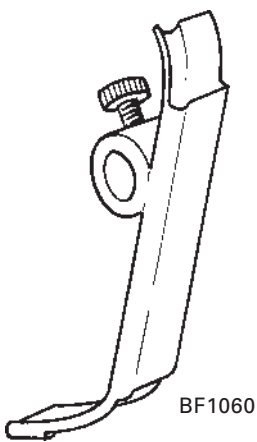

BF1060

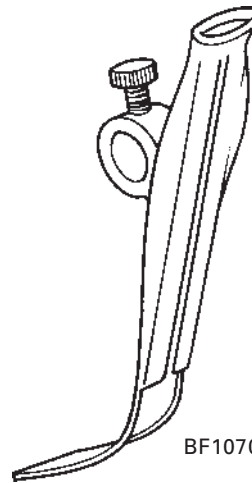
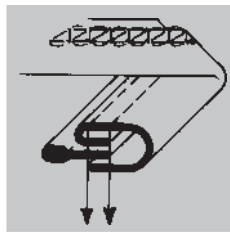

BF1070

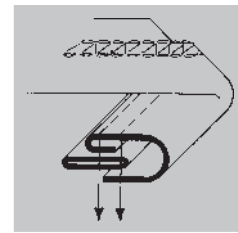

Paspelführungen für Börtchenapparate, Einfasser und Säumer Piping Guide for Split-tube Folder, Binder and Hemmer

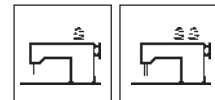

Bandbreite Tape Size in mm	Fertigbreite Finished Size in mm	BF1065
15.0	7.5	BF1065/15L
15.0	7.5	BF1065/15
20.0	10.0	BF1065/20L
20.0	10.0	BF1065/20
20.0	10.0	BF1065/20H
25.0	12.5	BF1065/25
30.0	15.0	BF1065/30
30.0	15.0	BF1065/30H
35.0	17.5	BF1065/35
35.0	17.5	BF1065/35H
40.0	20.0	BF1065/40
40.0	20.0	BF1065/40H

BF1065

Führung zum Fertigen von Paspelvorstößen aus Web- oder Strickbändern.

Guide for producing edge pipings of fabric or knit tapes.

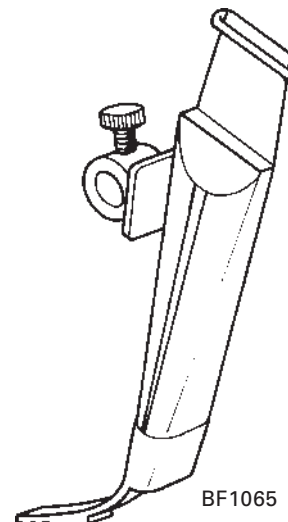

BF1065

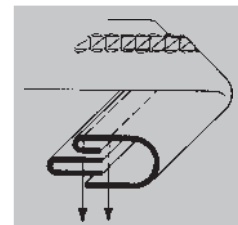

Spaghetti-Apparate für Flachbettmaschinen
Spaghetti-Attachment for flatbed machines



Bandbreite Tape Size in mm	Fertigbreite Finished Size in mm	BF53
16.0	4.0	BF53/16
19.0	5.0	BF53/19
22.0	5.5	BF53/22
25.0	6.0	BF53/25
28.0	8.0	BF53/28
32.0	9.5	BF53/32
38.0	11.0	BF53/38
45.0	15.0	BF53/45

BF53

Apparat zum Fertigen von Spaghettiträgern aus dünnem Bandmaterial.

Attachment for sewing spaghetti braces of light tape material.

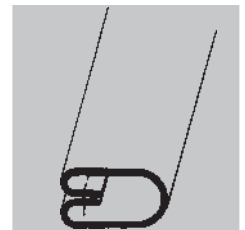
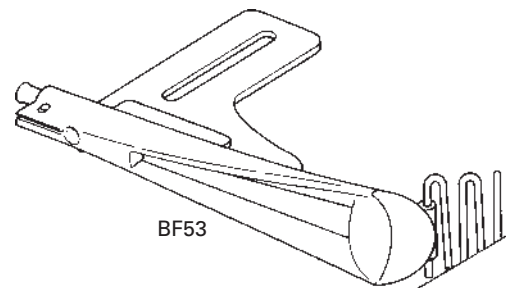

Spaghetti-Apparate für Overlock-Maschinen
Spaghetti-Attachment for overlock- machines

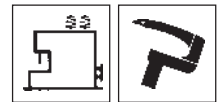

Bandbreite Tape Size in mm	Fertigbreite Finished Size in mm	BF54
14.0	3.5	BF54/14
16.0	4.0	BF54/16
18.0	4.5	BF54/18
20.0	5.0	BF54/20
22.0	5.5	BF54/22
24.0	6.0	BF54/24

BF54

Apparat zum Fertigen von Spaghettiträgern aus dünnem Bandmaterial auf Overlock-Maschinen.

Attachment for sewing spaghetti braces of light tape material on overlock machines.



BF54

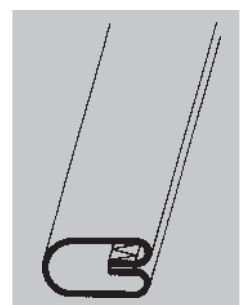

Schlaufenfalter Belt Loop Attachment

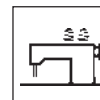

Bandbreite Tape Size in mm	Fertigbreite Finished Size in mm	Bandstärke Tape Width in mm	SUISEI A36	BF66	BF67	BF68
12.0	6.0	M	BA-1450s	BF66/12		
14.0	7.0	M	BA-1451s	BF66/14		
16.0	8.0	M	BA-1452s	BF66/16		
16.0	8.0	MH			BF67/16MH	BF68/16MH
18.0	9.0	M	BA-1453s			
18.0	9.0	MH			BF67/18MH	
19.0	9.5	M		BF66/19		
20.0	10.0	L			BF67/20L	
20.0	10.0	M	BA-1454s	BF66/20		
20.0	10.0	MH			BF67/20MH	BF68/20MH
20.0	10.0	H			BF67/20H	
22.0	11.0	M	BA-1455s	BF66/22		
25.0	12.5	L			BF67/25L	
25.0	12.5	M		BF66/25		
25.0	12.5	MH			BF67/25MH	BF68/25MH
25.0	12.5	H			BF67/25H	
26.0	13.0	M	BA-1456s			
28.0	14.0	M		BF66/28		
28.0	14.0	MH			BF67/28MH	BF68/28MH
30.0	15.0	L			BF67/30L	
30.0	15.0	M	BA-1457s	BF66/30		
30.0	15.0	MH			BF67/30MH	
32.0	16.0	M		BF66/32	BF67/32	
32.0	16.0	MH			BF67/32MH	
35.0	17.5	M		BF66/35		
36.0	18.0	L			BF67/36L	
36.0	18.0	M	BA-1457as			
36.0	18.0	MH			BF67/36MH	
38.0	19.0	M		BF66/38		
40.0	20.0	L			BF67/40L	
40.0	20.0	M	BA-1457bs	BF66/40		
40.0	20.0	MH			BF67/40MH	
40.0	20.0	H			BF67/40H	
45.0	22.5	M		BF66/45		
50.0	25.0	M		BF66/50		
55.0	27.5	M		BF66/55		
60.0	30.0	M		BF66/60		

Fortsetzung siehe nächste Seite
To be continued next page

Schlaufenfalter
Belt Loop Attachment



SUISEI A36

Apparat zum Fertigen von Schlaufen mit Stoßkante auf
Zweinadelmaschinen.

*Attachment for sewing butt edge belt loops on
double-needle machines.*

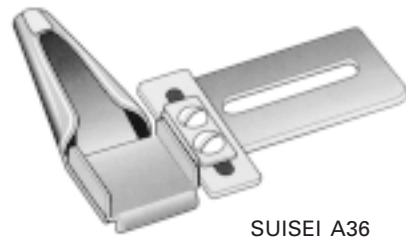

SUISEI A36

BF66

Apparat zum Fertigen von Schlaufen mit Stoßkante auf
Zweinadelmaschinen.

*Attachment for sewing butt edge belt loops on
double-needle machines.*

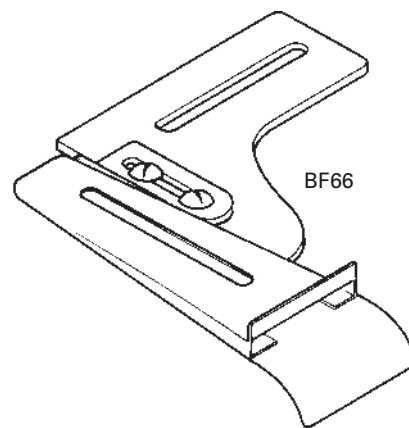

BF66

BF67

Apparat zum Fertigen von Schlaufen mit Stoßkante auf
KANSAI KI. DVK 1702BK.

*Attachment for sewing butt edge belt loops on
KANSAI CI. DVK 1702BK.*

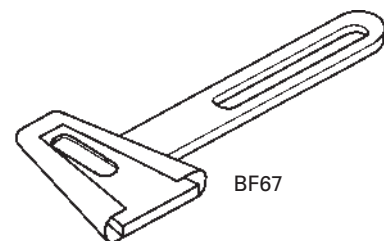

BF67

BF68

Apparat zum Fertigen von Schlaufen mit Stoßkante auf
KANSAI KI. DVK 1702BWK.

*Attachment for sewing butt edge belt loops on
KANSAI CI. DVK 1702BWK.*

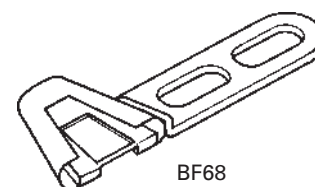

BF68

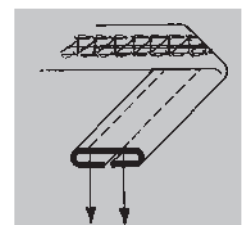

Schlaufenfalter Belt Loop Attachment

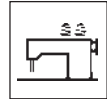

Bandbreite Tape Size in mm	Fertigbreite Finished Size in mm	BF1195
12.0	6.0	BF1195/12
14.0	7.0	BF1195/14
16.0	8.0	BF1195/16
18.0	9.0	BF1195/18
20.0	10.0	BF1195/20
22.0	11.0	BF1195/22
24.0	12.0	BF1195/24
26.0	13.0	BF1195/26
28.0	14.0	BF1195/28
30.0	15.0	BF1195/30
32.0	16.0	BF1195/32
35.0	17.5	BF1195/35
38.0	19.0	BF1195/38
40.0	20.0	BF1195/40
44.0	26.0	BF1195/44
47.0	29.0	BF1195/47
50.0	32.0	BF1195/50
54.0	36.0	BF1195/54
60.0	42.0	BF1195/60
73.0	55.0	BF1195/73

BF1195

Apparat zum Aufnähen von Schlaufen, zur Befestigung mit Apparatehalterung an der Stirnplatte.

Loop folder for attaching top loops, to be fixed at face plate bracket.

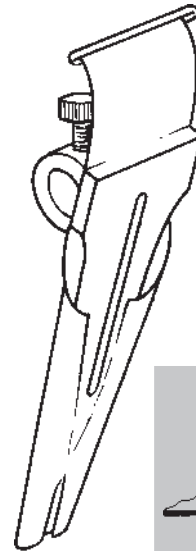

BF1195

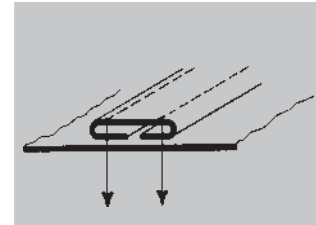

Schlaufenfalter Belt Loop Attachment

Bandbreite Tape Size in mm	Fertigbreite Finished Size in mm	Gummibandbreite Elastic Tape Width in mm	BF580	BF585
20.0	8.0		BF580/20	
20.0	9.0	8.0		BF585/20
22.0	9.0		BF580/22	
25.0	10.0		BF580/25	
25.0	11.5	10.0		BF585/25
30.0	14.0	13.0		BF585/30

BF580

Apparat zum Aufnähen von Kragenbändern in Polo-Shirts
Polo Shirt Neckline Attachment

BF585

Apparat mit Gummibandführung zur Herstellung elastischer Träger auf Zweinadelmaschinen.
Attachments with elastic tape insertion for production of elastic straps on double needle machines.

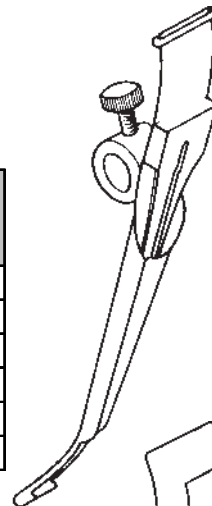

BF580

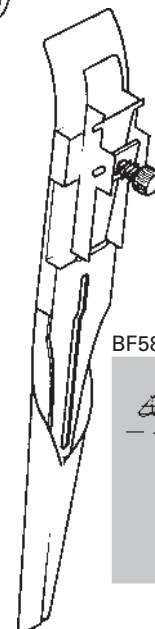
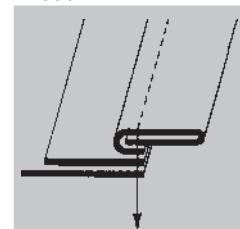

BF585

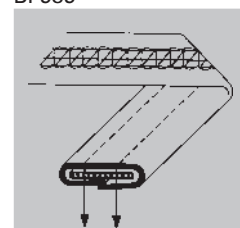

Schlaufenfalter
Belt Loop Attachment



Bandbreite <i>Tape Size</i> <i>in mm</i>	Fertigbreite <i>Finished Size</i> <i>in mm</i>	BF425
25.0	8.0	BF425/25
30.0	10.0	BF425/30
35.0	11.5	BF425/35
40.0	13.0	BF425/40
50.0	17.0	BF425/50

BF425

Apparat zum Fertigen geschlossener Schlaufen auf Einnadel-Stepstichmaschinen.
Attachment for sewing closed belt loops on single needle lockstitch machines.

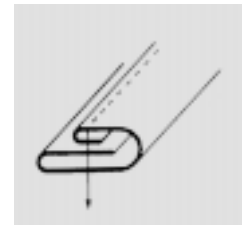
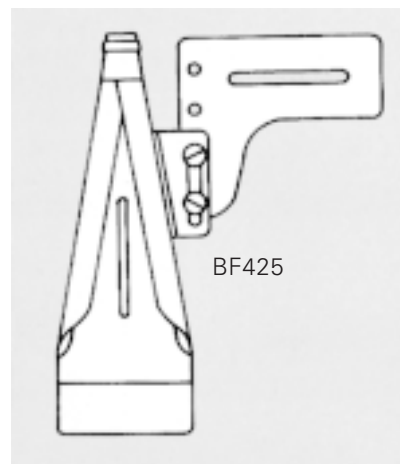

Schlaufenfalter
Belt Loop Attachment



Bandbreite <i>Tape Size</i> <i>in mm</i>	Fertigbreite <i>Finished Size</i> <i>in mm</i>	BF445
20.0	7.0	BF445/20
23.0	9.0	BF445/23
30.0	13.0	BF445/30
34.0	14.0	BF445/34
42.0	18.0	BF445/42
45.0	20.0	BF445/45
50.0	22.0	BF445/50
60.0	27.0	BF445/60
70.0	32.0	BF445/70
80.0	37.0	BF445/80

BF445

Apparat zum Fertigen von Gürteln bzw. Hosenträgern aus mittelschweren Bändern auf Zweinadelmaschinen.
Center stitch brace folder for medium heavy tapes on double needle machines.

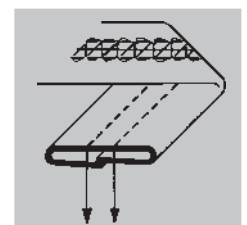
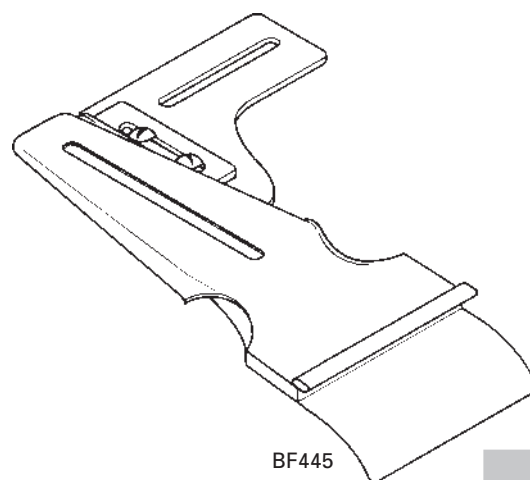

Bandführungen Tape Guides

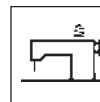

Bandbreite Tape Size in mm	SUISEI AG50S	BF52
0.0 - 50.0	BA-1477s	BF52

SUISEI AG50S

Bandführung, ausschwenkbar, verstellbar von 0 - 50 mm, zum Aufnähen von Bändern mit Flachbettmaschinen.

Swing-out attachment, adjustable from 0 - 50 mm, to apply stripes on flatbed machines.

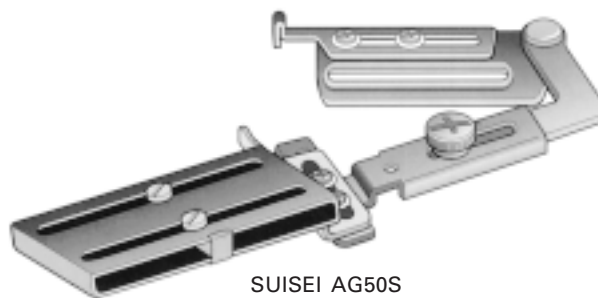

SUISEI AG50S

BF52

Bandführung, verstellbar von 0 - 50 mm, zum Aufnähen von Bändern mit Flachbettmaschinen.

Attachment, adjustable from 0 - 50 mm, to apply stripes on flatbed machines.

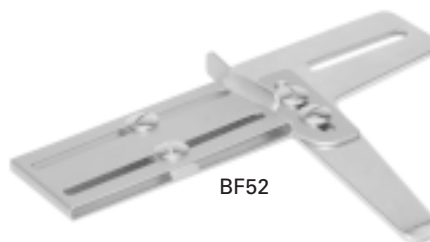

BF52

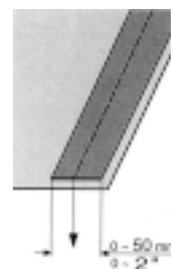

Bandführungen Tape Guides

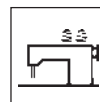

Max. Bandbreite Max. Tape Size in mm	BF465
0.0 - 40.0	BF465/40
0.0 - 60.0	BF465/60
0.0 - 100.0	BF465/100

BF465

Bandführung, verstellbar von 0 - 40 mm, zum Aufnähen von Applikationsbändern. Befestigung mit Apparateträger an der Stirnplatte der Maschinen.

Attachment, adjustable from 0 - 40 mm, to apply selvaged stripes, to be fixed with face plate bracket.

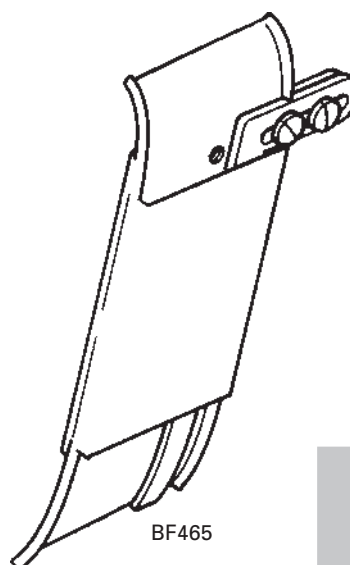

BF465

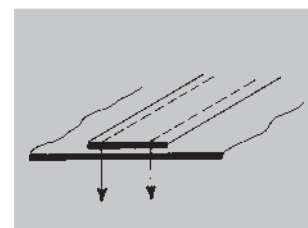

Bandführungen Tape Guides

Bandbreite Tape Size in mm	BF1240	BF1241
6.0	BF1240/6	BF1241/6
8.0	BF1240/8	BF1241/8
10.0	BF1240/10	BF1241/10
12.0	BF1240/12	BF1241/12
15.0	BF1240/15	BF1241/15
20.0	BF1240/20	BF1241/20
25.0	BF1240/25	BF1241/25
30.0	BF1240/30	BF1241/30
35.0	BF1240/35	BF1241/35
40.0	BF1240/40	BF1241/40

BF1240

Gummibandführung mit Bremse, geeignet zur Befestigung am Maschinenkopf, mit flachem Befestigungswinkel.

Elastic tape guide with plain support bracket, to be fixed at machine head.

BF1241

Gummibandführung mit Bremse, geeignet zur Befestigung am Maschinenkopf, mit runder Befestigungsbuchse.

Elastic tape guide with support bushing, to be fixed at machine head.

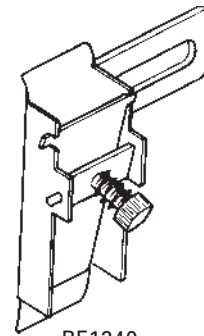

BF1240

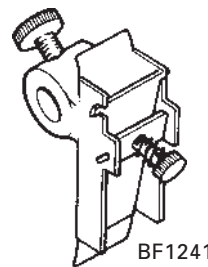

BF1241

Spezialapparate Special Attachments



Saumbreite Hemming Width in mm	BF95
25.0	BF95/25
30.0	BF95/30
35.0	BF95/35
37.0	BF95/37

BF95

Knopflochleistenapparat für Hemden und Blusen, geeignet für Zweinadel-Maschinen.
Button stay folder for double needle machines, suitable for medium fabric.



BF95

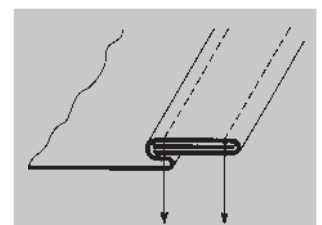

Spezialapparate Special Attachments

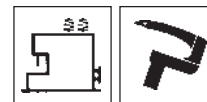

Bandbreite Tape Size in mm	Fertigbreite Finished Size in mm	BF1055
30.0	15.0	BF1055/30
35.0	17.5	BF1055/35
40.0	20.0	BF1055/40
50.0	25.0	BF1055/50
56.0	28.0	BF1055/56
56.0	28.0	BF1055/56H
64.0	32.0	BF1055/64
64.0	32.0	BF1055/64H
90.0	45.0	BF1055/90
90.0	45.0	BF1055/90H
120.0	60.0	BF1055/120
120.0	60.0	BF1055/120H
140.0	70.0	BF1055/140L
140.0	70.0	BF1055/140
140.0	70.0	BF1055/140H

BF1055

Bandfalter zum Annähen von Bündchen auf Overlockmaschinen.

Tape folder to apply neck and arm collars on overlock machines.

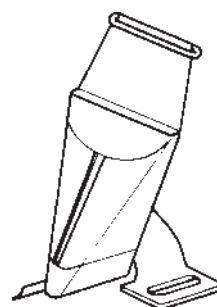

BF1055

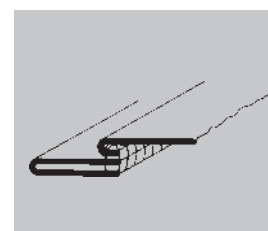

Spezialapparate Special Attachments

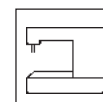

Verstellbereich Adjusting Area in mm	BF275
0.0 - 15.0	BF275/15
0.0 - 32.0	BF275/32

BF275

Verstellbarer Apparat zum Zusammenfügen von Stückenden auf Dreinadel-Flachbettmaschinen.

Adjustable attachment for assembling operations on triple needle flatbed machines.

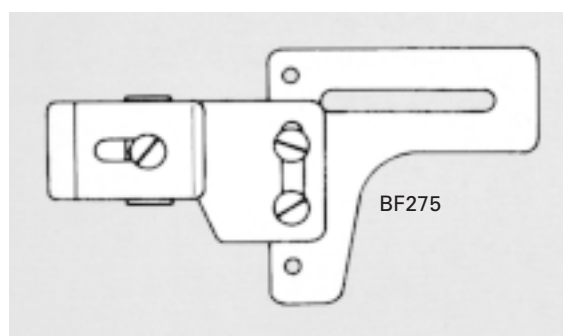

BF275

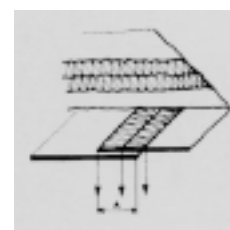

Spezialapparate
Special Attachments



BF1090

Ausschwenkbarer Kräuselapparat für Steppstichmaschinen mit Obertransport.
Swing-out ruffler for upper feed lockstitch machines.

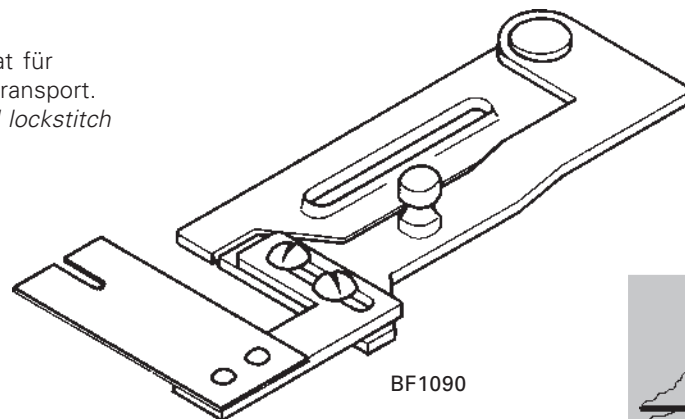

BF1090

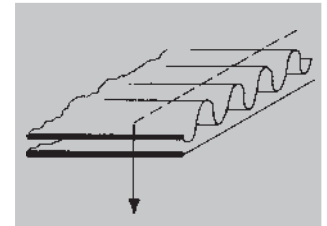

Bandbremsen
Tape Retainer

BA-1544

Verstellbare Gummibandbremse, zur Montage auf der Tischplatte vor der Nähmaschine.
Adjustable table type elastic tension bracket, to be fixed in front of the sewing machine.

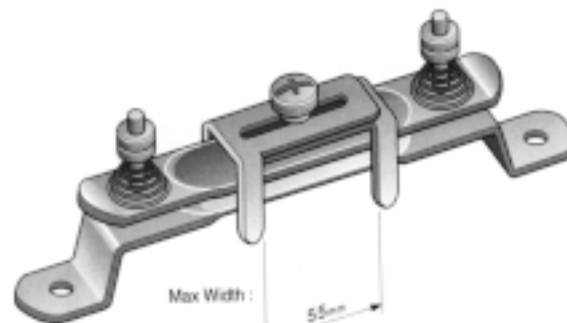

BA-1544

Max Width : 55mm
2"1/8

BF516

Verstellbare Bandbremse, zur Montage am Stirndeckel der Maschine.
Adjustable tape bracket, to be fixed at the face plate of the sewing machine.



BF516

BF517

Verstellbare Bandbremse für liegende Bandrollen, zur Montage an der Tischkante.
Adjustable tape bracket, to be fixed at the table border.

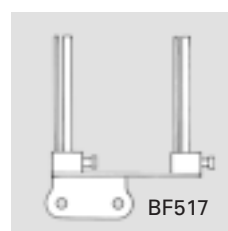

BF517

BF519

Verstellbare Bandbremse zur Montage seitlich der Maschine auf der Tischplatte.
Adjustable tape bracket, to be fixed on the table top at the side of the sewing machine.



BF519

Apparatehalterungen Attachment Brackets

BF1114

Apparate-Halter für W & G Overlock,
neue Version.
*Attachment bracket for W & G Overlock,
new style.*

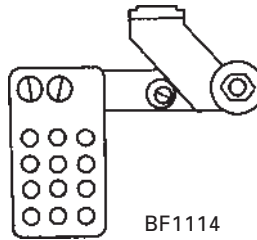

BF1114

BF1112

Apparate-Halter für W & G Overlock,
alte Version.
*Attachment bracket for W & G Overlock,
old style.*

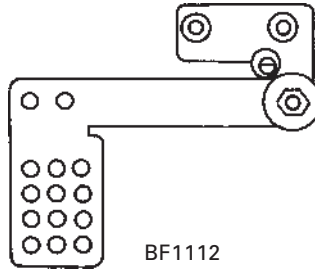

BF1112

BF1105

Apparate-Halter für Rimoldi Overlock
Attachment bracket for Rimoldi Overlock

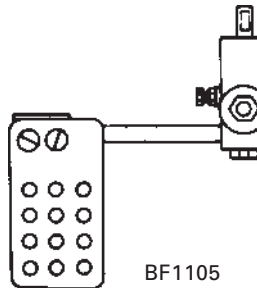

BF1105

BF1104

Apparate-Halter für Juki Overlock
Attachment bracket for Juki Overlock

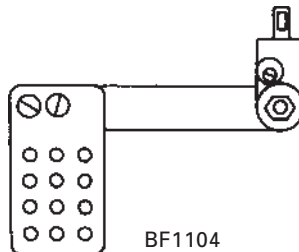

BF1104

BF1103

Apparate-Halter für Union Spezial Overlock
Attachment bracket for Union Special Overlock

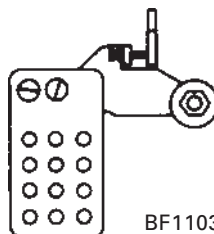

BF1103

BF1102

Apparate-Halter für Brother Overlock
Attachment bracket for Brother Overlock

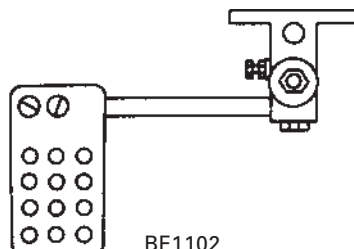

BF1102

Apparatehalterungen
Attachment Brackets

BF1100

Apparate-Halter für Yamato Overlock,
 regulierbar.
Attachment bracket for Yamato Overlock,
adjustable.

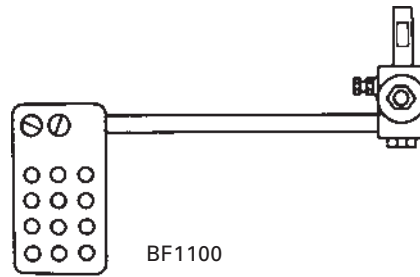

BF1100

BF1111

Apparate-Halterung zur Stirndeckelbefestigung,
 doppelt.
Attachment bracket to be fixed at the machine
face plate, double.

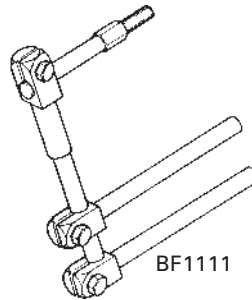

BF1111

BF1110

Apparate-Halterung zur Stirndeckelbefestigung,
 einfach.
Attachment bracket to be fixed at the machine
face plate, single.

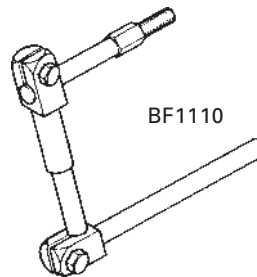

BF1110

BF72B/Halterung

Ausschwenkträger für Flachbettmaschinen.
Swing-out bracket for flatbed machines.



BF72B/Halterung

BF100 Sp.

Apparate-Halter für Schwenkträger.
Attachment bracket to adapt flatbed
attachments on swing-out brackets.



BF100SP

BF100 S.

Apparate-Halter für Flachbettbefestigung.
Attachment bracket for flatbed machines.



BF100S

1: NÄHEN *SEWING*

1.9 CUTTER UND ABFALLABSAUGUNGEN *CUTTER AND VACUUM DEVICES*

Vertikale Kettentrenner* Vertical Thread Cutter*

Artikelbezeichnung <i>Item description</i>	Artikelnummer <i>Item-no.</i>
Kettentrenner T042 für <i>Cutter T042 for</i> JUKI MO-3700, 3900	BT042
Kettentrenner SS023 für <i>Cutter SS023 for</i> Mauser Spezial SH-6000	BSS023
Kettentrenner KS371 für <i>Cutter KS371 for</i> PEGASUS EX	BKS371
Kettentrenner KS374 für <i>Cutter KS374 for</i> PEGASUS EXT	BKS374
Kettentrenner KS391 für <i>Cutter KS391 for</i> PEGASUS M	BKS391



BSS023

*Schneiden und Absaugung seitlich hinter dem Fuß
*Side suction type trimmer

Horizontale Kettentrenner* Horizontal Thread Cutter*

Artikelbezeichnung <i>Item description</i>	Artikelnummer <i>Item-no.</i>
Kettentrenner TO35 für <i>Cutter TO35 for</i> JUKI 2416, 2514	BT035
Kettentrenner TO41 für <i>Cutter TO41 for</i> JUKI MO-3900	BT041
Kettentrenner US-027 für <i>Cutter US-027 for</i> Mauser Spezial SHG-6000	BUS027
Kettentrenner US-035 für <i>Cutter US-035 for</i> Mauser Spezial SH-6000	BUS035
Kettentrenner US-036 für <i>Cutter US-036 for</i> Mauser Spezial SHF-6000	BUS036
Kettentrenner KH018A für <i>Cutter KH018A for</i> PEGASUS M	BKH018A
Kettentrenner KH020A für <i>Cutter KH020A for</i> PEGASUS EX	BKH020A
Kettentrenner KH021A für <i>Cutter KH021A for</i> PEGASUS EXT	BKH021A



BUS036

*Schneiden und Absaugung hinter der Nadel
*Under suction type trimmer

Bandtrenner für MAUSER-SPEZIAL SH-6000-Baureihe
Tape Cutter for MAUSER-SPEZIAL SH-6000-Series

Artikelbezeichnung <i>Item description</i>	Artikelnummer <i>Item-no.</i>
TC-007 elektro-magnetisch, über Handtaste gesteuert <i>electro-magnetic, operated by pushbutton</i>	BTC007



BTC007

Bandtrenner für PEGASUS EX-Baureihe
Tape Cutter for PEGASUS EX-Series

Artikelbezeichnung <i>Item description</i>	Artikelnummer <i>Item-no.</i>
TK022 pneumatisch, über Kniehebel gesteuert <i>pneumatic, operated by knee- lever</i>	BTK022
TK120 elektro-magnetisch, über Handtaste gesteuert <i>electro-magnetic, operated by pushbutton</i>	BTK120
TK121 elektro-magnetisch, über Kniehebel gesteuert <i>electro magnetic, operated by knee lever</i>	BTK121



BTK022
BTK023

Bandtrenner für PEGASUS EXT-Baureihe
Tape Cutter for PEGASUS EXT-Series

Artikelbezeichnung <i>Item description</i>	Artikelnummer <i>Item-no.</i>
TK023 pneumatisch, über Kniehebel gesteuert <i>pneumatic, operated by knee- lever</i>	BTK023
TK122 elektro-magnetisch, über Handtaste gesteuert <i>electro-magnetic, operated by pushbutton</i>	BTK122
TK123 elektro magnetisch, über Kniehebel gesteuert <i>electro-magnetic, operated by knee-lever</i>	BTK123

BTK121
BTK123



BTK120
BTK122

Abfallabsaugungen
Vacuum Devices

Artikelbezeichnung <i>Item description</i>	Artikelnummer <i>Item-no.</i>
PEGASUS Typ ON Abfallabsaugung über Ventilzugstange <i>Air valve for waste suction controlled by foot pedal</i>	B300464-91
MAUSER-SPEZIAL CV006 Betrieb durch Druckluft - kein Motor erforderlich, geeignet für Maschinen mit Kettentrenner und Kupplungsmotor <i>Operated by compressed air - no motor for vacuum required. Suitable for all machines with chain cutter and clutch motor</i>	BCV006
DIMAS VA/110 Schneid und Kettenabfallabsaugung über Zugstangenventil Wartungseinheit -925/03 erforderlich falls Maschine nicht bereits mit pneumatischer Presserfußlüftung ausgestattet ist <i>Waste suction controlled by valve-rod, conditioning unit -925/03 required if machine is not already equipped with pneumatic presser foot lift.</i>	BKSHVA02
DIMAS 910-EL925-VA320 Pneumatische Fußlüftung über Magnetventil Schneid und Abfallabsaugung über Luftspareinrichtung Elektronikmotor erforderlich <i>Pneumatic presser foot lift, waste suction by air saving device, electronic motor required</i>	BKSHPFA03VA03

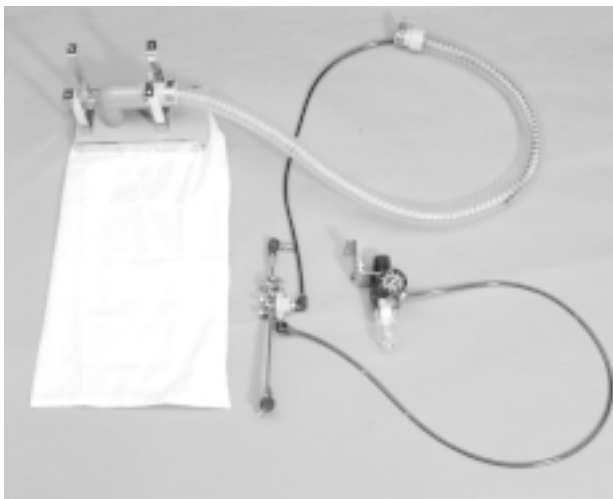

B300464-91

(Abb. ähnlich
Image similar)

BCV006

1: NÄHEN *SEWING*

1.10 KANTENFÜHRUNGEN *EDGE GUIDES*

Hochklappbare Lineale
Quilter Guides

Artikelbezeichnung <i>Item description</i>		Artikelnummer <i>Item-no.</i> STANDARD	Artikelnummer <i>Item-no.</i> PREMIUM QUALITY
Universal-Kantenführung für Dreifachtransportmaschinen, zur Befestigung am Maschinenkopf <i>Universal Quilter for unison feed machines, to be fixed at the machine head</i>			BA-1487
Führungsanschlag, passend für BA-1487 <i>Guide Stop, suitable for BA-1487</i>			BA-1487A
Wattierer mit Lineal rechts und links <i>Regular Quilter with right and left guide</i>	Für Presserstangendurchmesser 8,8 mm <i>Suitable for presser bar diameter 8,8 mm</i>	BA-1488	
	Für Presserstangendurchmesser 14 mm <i>Suitable for presser bar diameter 14 mm</i>	BA-1488A	
Wattierer mit Schnellverstellung, Lineal rechts <i>Regular Quilter with quick-adjustment, right guide</i>	Für Presserstangendurchmesser 8,8 mm <i>Suitable for presser bar diameter 8,8 mm</i>	BA-1489	
	Für Presserstangendurchmesser 14 mm <i>Suitable for presser bar diameter 14 mm</i>	BA-1490	
Wattierer, Lineal rechts <i>Wadding Guide, right guide</i>	Typ A, für Presserstangendurchmesser 8,8 mm <i>Type A, suitable for presser bar diameter 8,8 mm</i>		BA-1491m
	Typ B, für Presserstangendurchmesser 13,1 mm <i>Type B, suitable for presser bar diameter 13,1 mm</i>		BA-1492m
	Typ D, für Presserstangendurchmesser 8,8/13,3 mm <i>Type D, suitable for presser bar diameter 8,8/13,3 mm</i>		BA-1493m
	Typ E, für Presserstangendurchmesser 14 mm <i>Type E, suitable for presser bar diameter 14 mm</i>		BA-1494m
	Typ H <i>Type H</i> für / for Brother B835-900		BA-1491Hm
	Austauschlineal Typ G, mit Rollführung <i>Replacement Guide Type G, with wheel</i>		BA-1495m

Hochklappbare Lineale
Quilter Guides

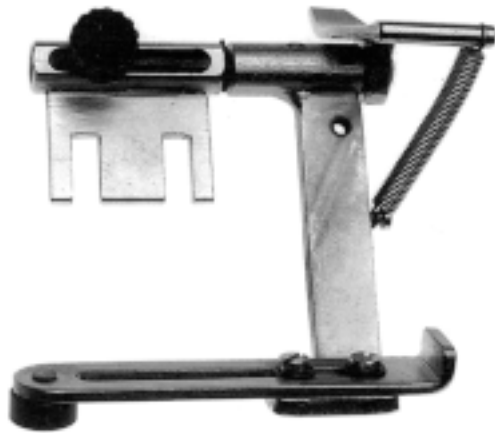

BA-1487

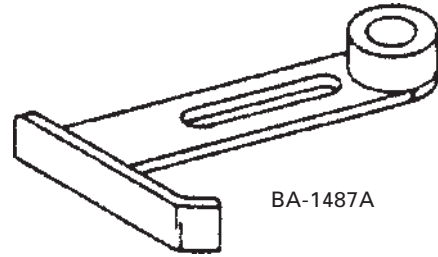

BA-1487A

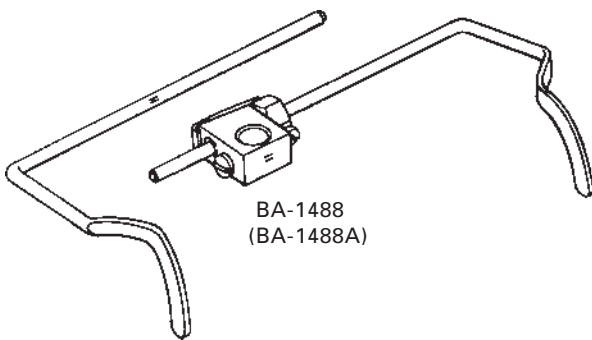

BA-1488
(BA-1488A)

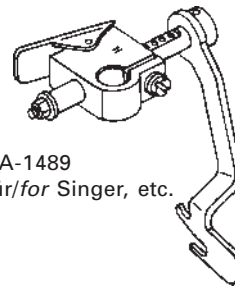

BA-1489
für/for Singer, etc.

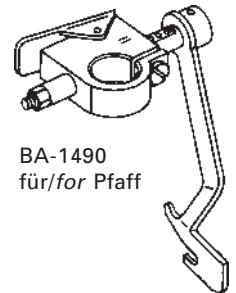

BA-1490
für/for Pfaff

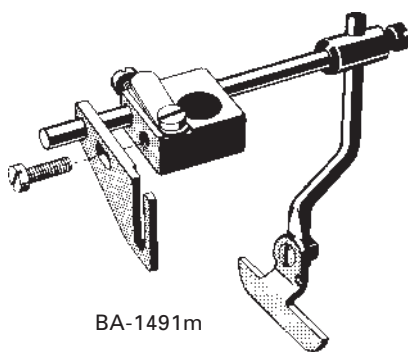

BA-1491m

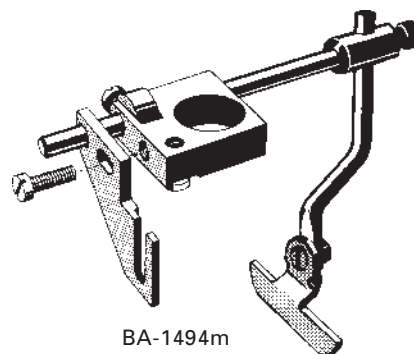

BA-1494m

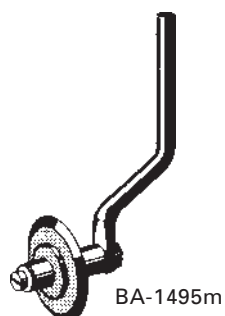

BA-1495m

Befestigungsmöglichkeiten / Possible attaching methods

1.) an der Presserfuß-
befestigungsschraube
with presser foot screw

2.) an der Presserstange
at the presser bar

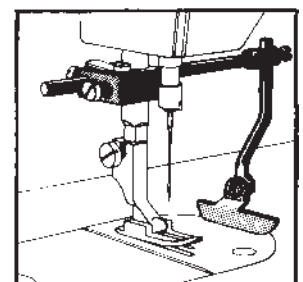
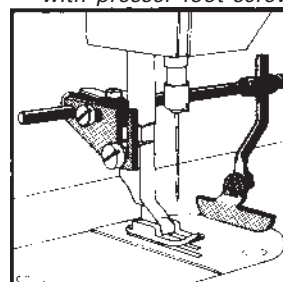

Magnetlineale Magnetic Guides

Artikelbezeichnung <i>Item description</i>	Artikelnummer <i>Item-no.</i> STANDARD	Artikelnummer <i>Item-no.</i> SUISEI
Magnetlineal, kleine Ausführung <i>Magnetic Gauge, small version</i>	BA-1486T	BA-1486s
Magnetlineal, große Ausführung <i>Magnetic Gauge, large version</i>	BHH-MG25873	



BA-1486s
BA-1486T

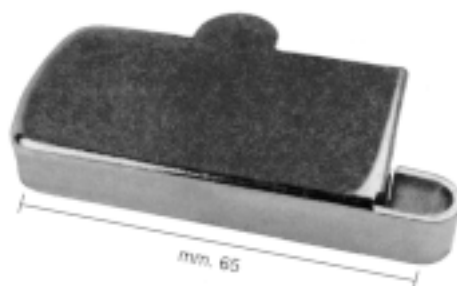

BHH-MG25873

Kantenlineale Edge Guides

Artikelbezeichnung <i>Item description</i>	Artikelnummer <i>Item-no.</i> STANDARD	Artikelnummer <i>Item-no.</i> SUISEI
Grundplattenlineal, L-förmig <i>Flatbed Gauge, L-shape</i>	BA-1482	
Grundplattenlineal, T-förmig <i>Flatbed Gauge, T-shape</i>	BA-1481	BA-1481s
Grundplattenlineal, mit ab- schwenkbarer Kantenführung <i>Flatbed Gauge with swing-out guide</i>	BA-1483	BA-1483s
Grundplattenlineal, mit abschwenkbarer Rollenführung <i>Flatbed Gauge, with swing roller guide</i>	BA-1484	
Grundplattenlineal, mit drei versch. Kantenführungen <i>Flatbed Gauge, with three different guide edges</i>	BA-1485	

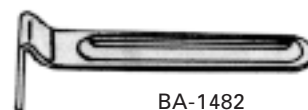

BA-1482

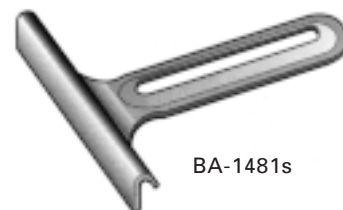

BA-1481s

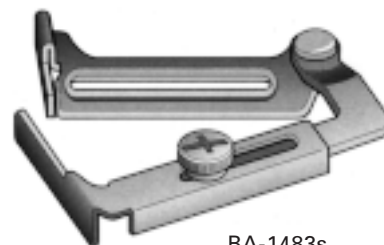

BA-1483s



BA-1484

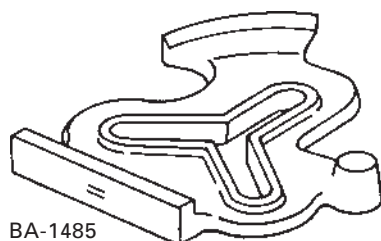

BA-1485

Befestigungsschrauben
Retaining Screws

Artikelbezeichnung <i>Item description</i>	Artikelnummer <i>Item-no.</i> STANDARD	Artikelnummer <i>Item-no.</i> SUISEI
Schraube 9/64" = 3,57 mm <i>Screw 9/64" = 3,57 mm</i>	BA-1355A	BA-1355As
Schraube M5 = 4,0 mm <i>Screw M5 = 4,0 mm</i>	BA-1355B	



BA-1355As

1: NÄHEN *SEWING*

1.11 BANDABZUGSGERÄTE UND PULLER *TAPE FEEDER AND PULLER*

Bandabzugsgerät
Tape Feeder

Artikelbezeichnung <i>Item description</i>	Artikelnummer <i>Item-no.</i>
Elektrisches Bandabzugsgerät, vertikaler Bandabzug <i>Electric Tape Feeder, vertical tape feed</i>	BA-1549
Elektrisches Bandabzugsgerät, horizontaler Bandabzug <i>Electric Tape Feeder, horizontal tape feed</i>	BA-1549A



BA-1549

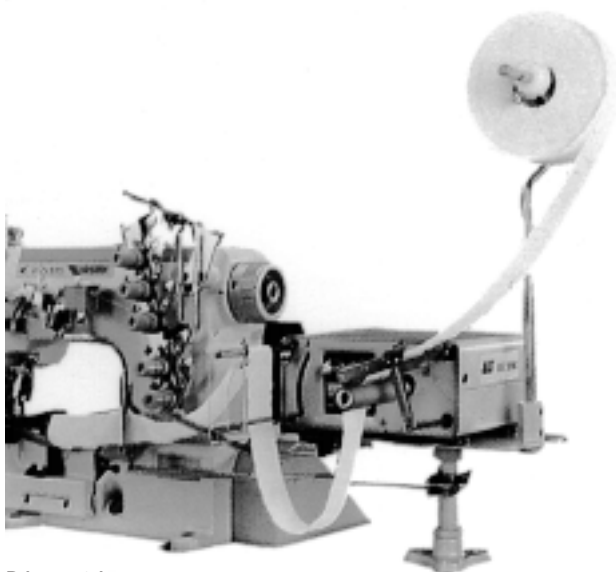

BA-1549A

Puller mit Rutschkupplung
Regular Cloth Puller

Artikelbezeichnung <i>Item description</i>	Artikelnummer <i>Item-no.</i>
Stoffpuller für Flachbettmaschinen <i>Regular Cloth Puller for Flatbed Machines</i>	BA-1560
Pullerwalze, gummiert, Breite = 76 mm, für Schaftdurchmesser 12,7 mm <i>Rubber roller, width = 3", suitable for puller with shaft dia. 1/2"</i>	BPR32



BPR32

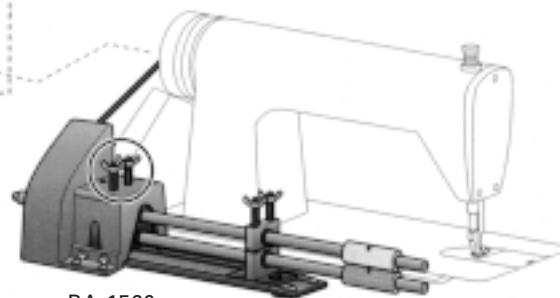
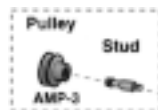
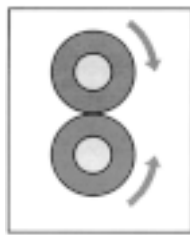

BA-1560

Puller, intermittierend
Puller, intermittent

Artikelbezeichnung <i>Item description</i>		Walzen- \varnothing <i>Roller-\varnothing</i> in mm	Walzenbreite <i>Roller width</i> in mm	Artikelnummer <i>Item-no.</i>
Puller für Flachbettmaschinen <i>Puller for Flatbed Machines</i>	Für Einnadel <i>For Single Needle</i>	25	10*	BPS
	Für Zweinadel <i>For Double Needle</i>	55	35**	BPL
	Für Mehrnadel <i>For Multi Needle</i>	55	50	BPLS1
	Mit Ober- und Unterwalzentransport <i>With Upper and Lower Drive Rollers</i>	55	50***	BPT
Puller für Mehrnadel-Freiarmmaschinen <i>Puller for Multi Needle Cylinder Arm Machines</i>		55	50	BPLS2
Puller mit Ober- und Unterwalzenantrieb für Overlock- Maschinen <i>Puller with Upper and Lower Drive Rollers for Overlock Machines</i>		55	35	BPK
Puller für Arm-Abwärts-Maschinen <i>Puller for Feed-off-the-arm Machines</i>		55	15	BPF

Auf Wunsch auch lieferbar mit Rollenbreite:
On request also available with roller width:

* = 15 mm

** = 15, 50, 75, 100 mm

*** = 15, 35, 75 mm

Puller, intermittierend
Puller, intermittent

Standardmäßig erfolgt die Lieferung der Puller geeignet für 230V / 50Hz, sowie mit polyurethanbeschichteten Walzen. Bei Bestellung ist unbedingt die vollständige Maschinenklasse anzugeben, für die der Puller vorgesehen ist.

As a standard, delivery includes Puller suitable for 230V / 50Hz and polyurethane-coated Rollers. You need to mention the complete machine class you want to use the Puller with.

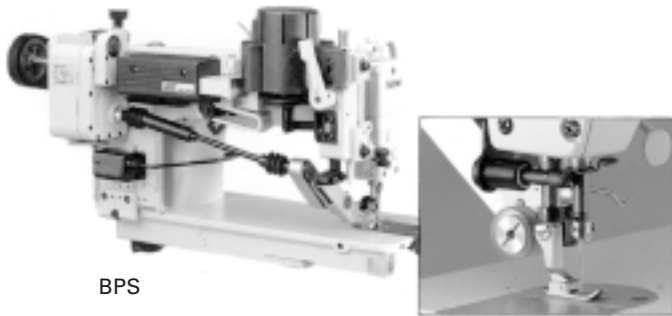

BPS

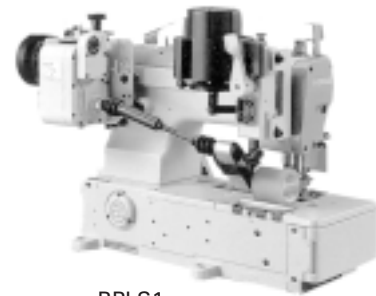

BPLS1

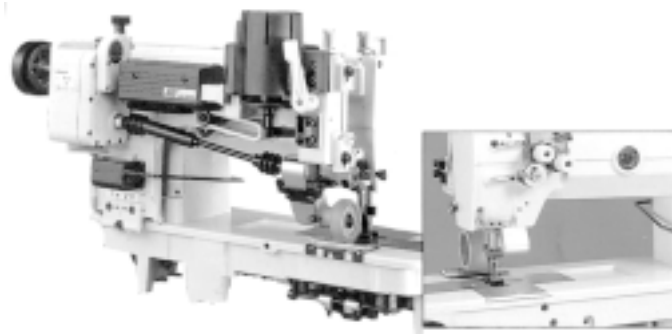

BPL

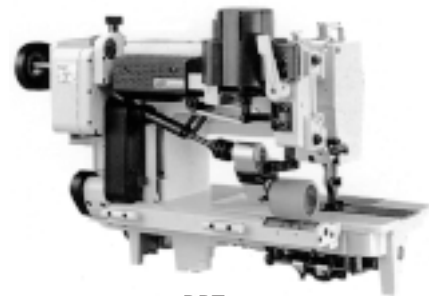

BPT

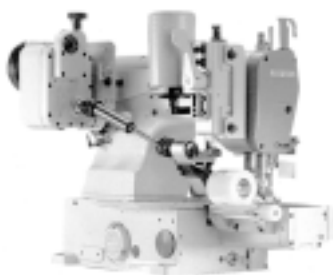

BPLS2



BPK

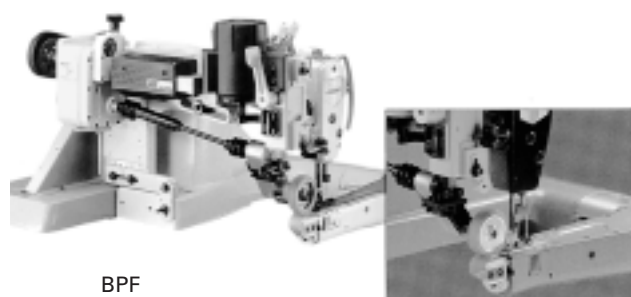

BPF

1: NÄHEN *SEWING*

1.12 LEUCHTEN UND ZUBEHÖR *SEWING LIGHTS AND ACCESSORIES*

Laser Laser

BL - Laser eignen sich für sämtliche Markierungsaufgaben im Bereich Zuschnitt, Stanzen, Nähen, Nieten, Sticken, Drucken und Bügeln. Der Einsatz von Markierungslasern empfiehlt sich besonders für Materialien, bei denen herkömmliche Markierungsmittel aufgrund der Materialeigenschaften nicht verwendet werden können (z.B. wegen schlechter Sichtbarkeit oder wegen Qualitätsverlust).
Sämtliche BL - Laser werden als betriebsbereites Set geliefert, daß außer dem Laser eine geeignete Halterung und das Netzgerät beinhaltet.

BL laser are suitable for all kind of markings required for cutting, punching, sewing, rivet, embroidery, printing and pressing operations. They are especially recommended for materials on which traditional ways of marking are not suitable (e.g. because of insufficient visibility or quality prejudice). All BL lasers are supplied as set ready for service, which includes a suitable bracket and the power supply unit in addition to the laser.

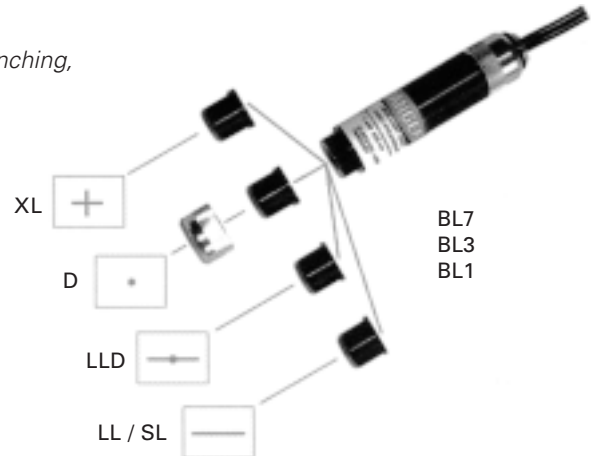

Laser 645 nm / 5 mW - geeignet für Fokussierabstand ca. 0,5 m <i>Laser 645 nm / 5 mW - suitable for approx. working distance 0,5 m</i>	
Artikelbezeichnung <i>Item description</i>	Artikelnummer <i>Item-no.</i>
für Punktmarkierung <i>for dot mark</i>	BL7D
für Linienmarkierung mit zusätzlichem Punkt <i>for line mark with additional dot mark</i>	BL7LLD
für Linienmarkierung <i>for line mark</i>	BL7LL
für Kreuzmarkierung <i>for cross mark</i>	BL7XL

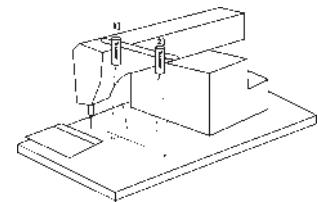

Nähmaschine
Sewing Machine

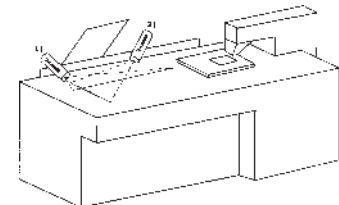

Nähautomat
Sewing Unit

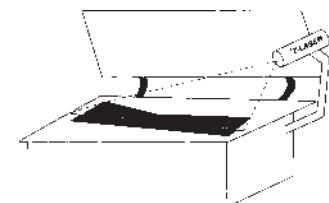

Bügelpresse (für Hosen)
Ironing Press (for trousers)

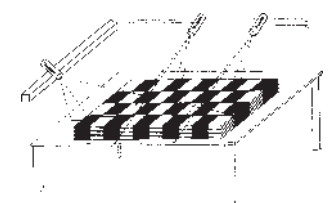

Textillegetisch
Spreading Table

Laser 635 nm / 3 mW - geeignet für Fokussierabstand ca. 1,0 m <i>Laser 635 nm / 3 mW - suitable for approx. working distance 1,0 m</i>	
für Linienmarkierung <i>for line mark</i>	BL3SL
für Kreuzmarkierung <i>for cross mark</i>	BL3XL

Laser 635 nm / 5 mW - geeignet für Fokussierabstand ca. 2 - 3 m <i>Laser 635 nm / 5 mW - suitable for approx. working distance 2 - 3 m</i>	
für Linienmarkierung mit zusätzlichem Punkt <i>for line mark with additional dot mark</i>	BL3LLD
für Linienmarkierung <i>for line mark</i>	BL3LL

Laser 635 nm / 10 mW - geeignet für Fokussierabstand ca. 3 - 5 m <i>Laser 635 nm / 10 mW - suitable for approx. working distance 3 - 5 m</i>	
für Linienmarkierung <i>for line mark</i>	BL1LL

Laser
Laser

Netzgeräte für BL - Laser <i>Power Supply Units for BL Laser</i>	
Artikelbezeichnung <i>Item description</i>	Artikelnummer <i>Item-no.</i>
geeignet für einen BL7 - Laser <i>suitable for one BL7 laser</i>	BPS-1
geeignet für ein bis vier BL7 - Laser <i>suitable for one up to four BL7 laser</i>	BPS-4
geeignet für einen BL3 oder BL1 - Laser <i>suitable for one BL3 or BL 1 laser</i>	BPW-1



BPS-1



BPS-4

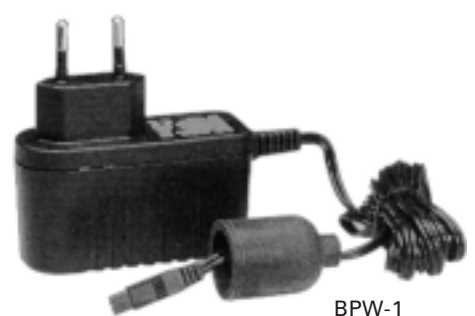

BPW-1

Halterungen für BL - Laser <i>Brackets for BL Laser</i>	
Artikelbezeichnung <i>Item description</i>	Artikelnummer <i>Item-no.</i>
mit Kugelgelenk, für Typ BL7 <i>with ball joint, for type BL7</i>	BH3T
mit Kippgelenk, für Typ BL3 / BL1 (außer BL3XL) <i>with joint, for type BL3 or BL 1 (except BL3XL)</i>	BH2D
mit Drehgelenk, für Typ BL3XL <i>with swivel joint, for type BL3XL</i>	BH1DX



BH3T



BH2D



BH1DX

Glasfaser-Nähleuchten *Glas Fibre Sewing Light*

Artikelbezeichnung <i>Item description</i>	Artikelnummer <i>Item-no.</i>
Glasfaserleuchte mit 880 mm Lichtleiter <i>Glas Fibre Sewing Light with 880mm light duct</i>	BD-4171
Glasfaserleuchte mit 1500 mm Lichtleiter <i>Glas Fibre Sewing Light with 1500mm light duct</i>	BD-4171A
Universal-Befestigung für Lichtleiter <i>Universal Fixation for Fibre Optic Light Duct</i>	*BC-2473A
Lichtmarkenprojektor für Kreuzmarkierung <i>Positioning Unit for Cross Mark</i>	*BC-2473B

*Nicht mehr lieferbar
*No longer available



BD-4171



BD-4171A

Halogenleuchte
Halogen Sewing Light

Artikelbezeichnung <i>Item description</i>	Artikelnummer <i>Item-no.</i> STANDARD	Artikelnummer <i>Item-no.</i> PREMIUM QUALITY
Halogenleuchte mit integriertem Trafo, mit Kugelgelenkstativ <i>Halogen Sewing Light with ball joint arm, with integrated transformer</i>		BC-2475
Halogenleuchte mit integriertem Trafo, mit Knickgelenkstativ <i>Halogen Sewing Light with rocker joint arm, with intergrated transformer</i>		BC-2475A
Halogenleuchte zur direkten Montage am Maschinenkopf, mit separatem Trafo <i>Head Mount Halogen Sewing Light, complete with separate transformer</i>		BC-2475B
Halogenleuchte mit integriertem Trafo, mit vollflexiblem Stativarm <i>Halogen Sewing Light with integrated transformer, with flexible stem</i>	BD-4130	
Halogenleuchte mit integriertem Trafo und Tischklemme, mit vollflexiblem Stativarm <i>Halogen Sewing Light with integrated transformer and table clamp, with flexible stem</i>	BD-4187	

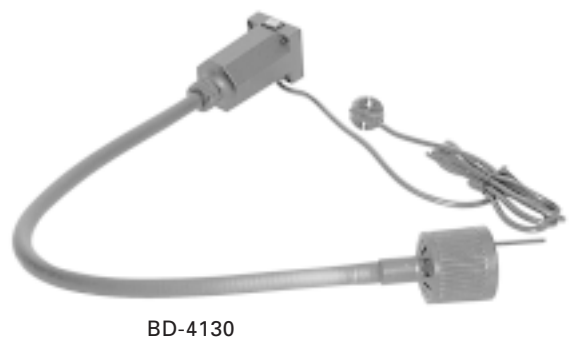

Halogenbirnen
Halogen Bulbs

Artikelbezeichnung <i>Item description</i>	Artikelnummer <i>Item-no.</i>
Halogenbirne mit Reflektor 12V/20W <i>Halogen Reflector Bulb 12V/20W</i> für/for BC-2475, BC-2475A, BC-2475B	BC-2477
Halogenbirne mit Reflektor und Abdeckglas, 12V/20W Strahlwinkel 32°, für EFKA-Leuchten <i>Halogen Dichroic Bulb 12V/20W</i> <i>32° beam, for EFKA lights</i>	BC-2477A
Halogenbirne mit Reflektor und Abdeckglas 12V/20W mit Strahlwinkel 18°, für EKFA-Leuchten <i>Halogen Dichroic Bulb 12V/20W</i> <i>18° beam, for EFKA lights</i>	BC-2477B
Halogenbirne mit Reflektor, 12V/20W <i>Halogen Reflector Bulb 12V/20W</i> für / for BD-4171, BD-4171A	BC-4182
Halogenbirne mit Reflektor, 14,5V/90W für Glasfaserleuchte mit Gebläse <i>Halogen Reflector Bulb 14,5V/90W</i> <i>for glas fibre halogen light with ventilation</i>	BC-4183
Halogenbirne ohne Reflektor 12V/20W, <i>Halogen Bulb 12V/20W</i> für / for BD-4130, BD-4187	BD-4133



BC-2477



BC-4182



BC-4183



BD-4133

Zubehör für Nähleuchten
Accessories for Sewing Lights

Artikelbezeichnung <i>Item description</i>	Artikelnummer <i>Item-no.</i>
Abdeckglas <i>Cover Glass</i> für/for BC-2475, BC-2475A, BC-2475B	B305204.10
Tischklemme für Nähleuchte <i>C-Clamp for Sewing Light</i> für/for BC-2472, BC-2475, BC-2475A	BC-2473
Tischklemme für Halogenleuchte <i>C-Clamp for Halogen Light</i> für/for BD-4130	BD-4131

**Kaltlichtleuchten**
Fluorescent Sewing Lights

Artikelbezeichnung <i>Item description</i>	Artikelnummer <i>Item-no.</i>
Kaltlichtleuchte mit Weisslichröhren 4W <i>Fluorescent Sewing Light with Tubes 4W</i>	BC-2472



Leuchtstoffröhren Fluorescent Tubes

Artikelbezeichnung <i>Item description</i>	Artikelnummer <i>Item-no.</i>
Leuchtstoffröhre 4W <i>Fluorescent Tube 4W</i> für / for BC-2472	BC-2476
UV-Leuchtstoffröhre 4W <i>UV - Fluorescent Tube 4W</i> für / for BC-2472	BC-2476A



BC-2476

Glühlampen mit Stecksockel B15d Bayonet Base Bulbs B15d

Artikelbezeichnung <i>Item description</i>	Artikelnummer <i>Item-no.</i>	
Glühbirne, klar, 12V <i>Bulb, clear, 12V</i>	TR 35 x 60, 15W	BC-2484
	TR 35 x 60, 25W	BC-2485
Glühbirne, matt, 12V <i>Bulb, frosted, 12V</i>	R 22 x 63, 15W	B27015
Glühbirne, klar, 235V <i>Bulb, clear, 235V</i>	B 26 x 57, 15W	B27029
	R 18 x 52, 15W	B27002
	R 20 x 65, 15W	B27025
	TR 35 x 60, 25W	BC-2483
Glühbirne, matt, 235V (import) <i>Bulb, frosted, 235V (import)</i>	R 18 x 52, 15W	B27000a
	R 22 x 57, 15W	*B27000
Glühbirne, matt, 235V <i>Bulb, frosted, 235V</i>	PL 22 x 48, 15W	B27013
	R 22 x 57, 15W	B27003
	R 22 x 57, 20W	B27004
	R 22 x 63, 15W	B27019
	R 22 x 63, 20W	B27028
	R 22 x 63, 25W	B27024



B27029

Form / Shape = B

Form / Shape = PL

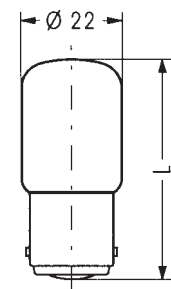
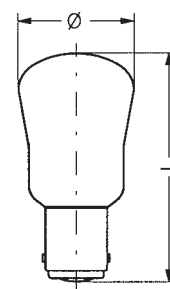

Form / Shape = R

Form / Shape = TR

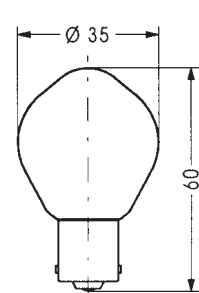
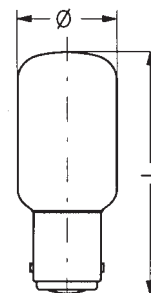

*Nicht mehr lieferbar
*No longer available

Glühlampen mit Schraubsockel E14
Screw Base Bulbs E14

Artikelbezeichnung <i>Item description</i>		Artikelnummer <i>Item-no.</i>
Glühbirne, klar, 12V <i>Bulb, clear, 12V</i>	TR 35 x 65, 15W	BC-2480
	TR 35 x 65, 25W	BC-2481
Glühbirne, matt, 12V <i>Bulb, frosted, 12V</i>	R 22 x 57, 15W	B27031
	R 22 x 63, 15W	B27022
Glühbirne, klar, 235V <i>Bulb, clear, 235V</i>	PL 22 x 48, 15W	B27014
	R 18 x 54, 15W	B27018
	TR 35 x 65, 25W	BC-2479
Glühbirne, matt, 235V (import) <i>Bulb, frosted, 235V (import)</i>	R 22 x 57, 15W	*B27001
Glühbirne, matt, 235V <i>Bulb, frosted, 235V</i>	R 22 x 57, 15W	B27005
	R 22 x 57, 20W	B27006
	R 22 x 63, 15W	B27026
	R 22 x 63, 20W	B27030
	R 22 x 63, 25W	B27007



BC-2479

*Nicht mehr lieferbar
*No longer available

Glühlampen mit Schraubsockel E12
Screw Base Bulbs E12

Artikelbezeichnung <i>Item description</i>		Artikelnummer <i>Item-no.</i>
Glühbirne, klar, 235V <i>Bulb, clear, 235V</i>	R 20 x 52, 15W	B27021

Form / Shape = B

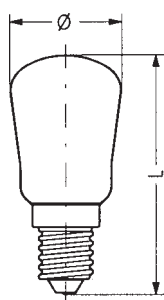

Form / Shape = PL

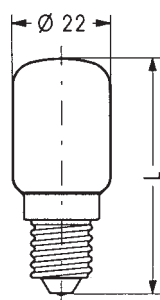

Form / Shape = R

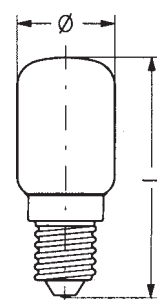

Form / Shape = TR

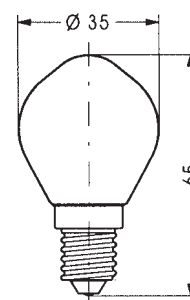

1: NÄHEN *SEWING*

1.13 MOTOREN UND ZUBEHÖR *MOTORS AND ACCESSORIES*

Kupplungsmotoren Clutch Motors

Artikelbezeichnung <i>Item description</i>		Artikelnummer <i>Item-no.</i>
Kupplungsmotor 1 Phase 230V <i>Clutch Motor 1 Phase 230V</i>	0,5 PS / 1400 U/Min <i>0,5 HP / 1400 UPM</i>	BC-2505
	0,5 PS / 2800 U/Min <i>0,5 HP / 2800 UPM</i>	BC-2505A
	0,75 PS / 1400 U/Min <i>0,75 HP / 1400 UPM</i>	BC-2505CA
	0,75 PS / 2800 U/Min <i>0,75 HP / 2800 UPM</i>	BC-2505B
Kupplungsmotor 3 Phasen 380V <i>Clutch Motor 3 Phase 380V</i>	0,5 PS / 1400 U/Min <i>0,5 HP / 1400 UPM</i>	BC-2506
	0,5 PS / 2800 U/Min <i>0,5 HP / 2800 UPM</i>	BC-2506A
	0,75 PS / 1400 U/Min <i>0,75 HP / 1400 UPM</i>	BC-2507
	0,75 PS / 2800 U/Min <i>0,75 HP / 2800 UPM</i>	BC-2507A



BC-2505 – BC-2507A

Ersatzteile für Kupplungsmotoren Spare Parts for Clutch Motors

Artikelbezeichnung <i>Item description</i>	Artikelnummer <i>Item-no.</i>
Riemenschutz <i>Belt guard</i>	B22/1-2
Kupplungsscheibe mit Welle <i>Friction Disk with Shaft</i>	B38/1E
Betätigungssperre <i>Operate Interlock</i>	BC-4510



B22/1-2

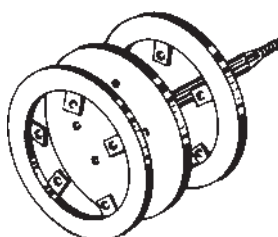

B38/1E



BC-4510

Anlassermotoren
Artisan Motors

Artikelbezeichnung <i>Item description</i>	Artikelnummer <i>Item-no.</i>
Anlassermotor 1/5 PS 4000 U/Min <i>Artisan Motor 1/5 HP 4000 UPM</i> 230V/150W	BC-2504AN
Anlassermotor 1/3 PS 6000 U/Min <i>Artisan Motor 1/3 HP 6000 UPM</i> 230V/250W	BC-2504AV



BC-2504AN – BC-2504AV

Ersatzteile für Anlassermotoren
Spare Parts for Artisan Motors

Artikelbezeichnung <i>Item description</i>	Artikelnummer <i>Item-no.</i>
Riemenschutz <i>Belt Guard</i>	B305
Schenkelfeder für Bremse <i>Brake Coil Spring</i>	B310
Zungenblock <i>Contact block</i>	B322
Kondensator <i>Condenser</i>	B325
Widerstand-Klemmfeder <i>Resistor Spring</i>	B343
Widerstand <i>Resistor</i>	B348
Rotor, Wellendurchmesser 10 mm <i>Rotor, shaft diameter 10 mm</i>	B415

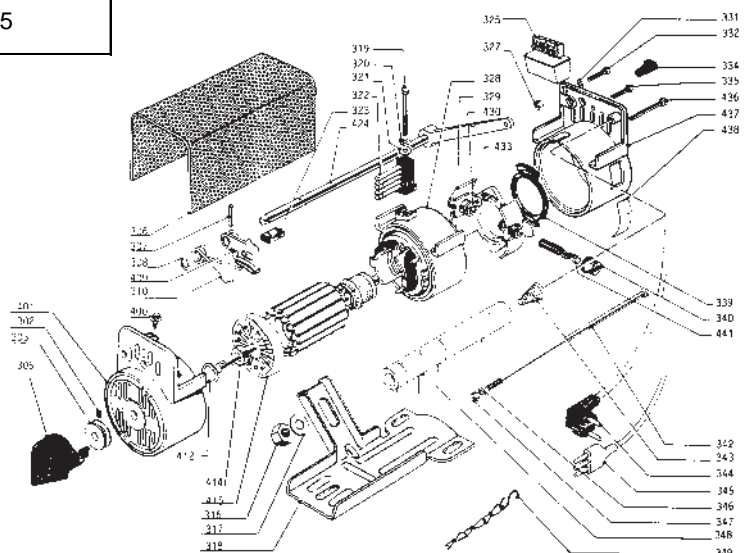

Anbaumotoren für Haushaltsmaschinen *Build-on Motors for Domestic Sewing Machines*

Artikelbezeichnung <i>Item description</i>	Artikelnummer <i>Item-no.</i>
YM261C-9, Eingang 90W - Ausgang 47W, mit Fußanlasser <i>YM261C-9, Input 90W / Output 47W, with foot control</i>	B74000
Eingang 120W - Ausgang 50W, mit Fußanlasser <i>Input 120W / Output 50W, with foot control</i>	BC-2500
Eingang 150W - Ausgang 60W, mit Fußanlasser <i>Input 150W / Output 60W, with foot control</i>	BC-2503
Eingang 180W - Ausgang 75W, mit Fußanlasser <i>Input 180W / Output 75W, with foot control</i>	BC-2500A
Eingang 150W - Ausgang 60W, mit Fußanlasser, rechtsdrehend <i>Input 150W / Output 60W, Clockwise Rotation</i>	BC-2500B



BC-2500 – BC-2503



B74000

Einbaumotoren für Haushaltsnäähmaschinen
Build-in Motors for Domestic Sewing Machines

Artikelbezeichnung <i>Item description</i>			Artikelnummer <i>Item-no.</i>
YM261-9, Eingang 90W - Ausgang 47W <i>YM261-9, Input 90 W / Output 47 W</i>	Schutzklasse <i>Safety Class</i>	II	B74006 Nicht mehr lieferbar <i>No longer available</i>
	Maße* in mm <i>Measures* in mm</i>	95x52x68	
	Abstand Bef. Schrauben <i>Distance Ret. Screws</i>	23mm	
Eingang 120W / Ausgang 50W <i>Input 120 W / Output 50 W</i>	Schutzklasse <i>Safety Class</i>	I	BC-2501D
	Maße* in mm <i>Measures* in mm</i>	102x54x73	
	Abstand Bef. Schrauben <i>Distance Ret. Screws</i>	59mm	
Eingang 120W / Ausgang 50W <i>Input 120 W / Output 50 W</i>	Schutzklasse <i>Safety Class</i>	II	BC-2501
	Maße* in mm <i>Measures* in mm</i>	105x57x76	
	Abstand Bef. Schrauben <i>Distance Ret. Screws</i>	35mm	
Eingang 120W - Ausgang 50W, rechtsdrehend <i>Input 120 W / Output 50 W,</i> Clockwise Rotation	Schutzklasse <i>Safety Class</i>	II	BC-2501E
	Maße* in mm <i>Measures* in mm</i>	105x57x76	
	Abstand Bef. Schrauben <i>Distance Ret. Screws</i>	35mm	

*Alle Maße sind Einbaumaße ohne Welle, Angabe in Länge x Breite x Höhe
*All measures are fitting measures without shaft, length x width x height



B74006

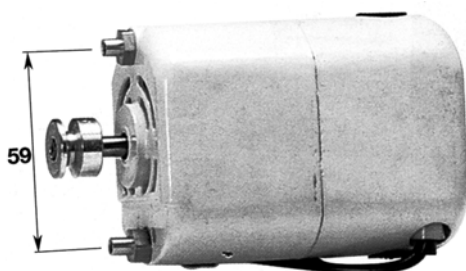

BC-2501D

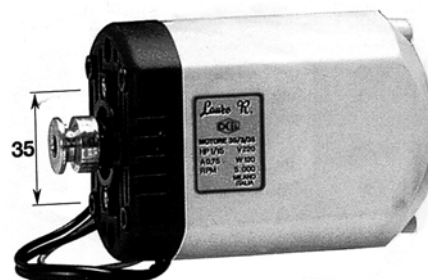

BC-2501 + BC2501E

Fußanlasser Motor Controller Pedal

Artikelbezeichnung <i>Item description</i>	Artikelnummer <i>Item-no.</i> STANDARD	Artikelnummer <i>Item-no.</i> PREMIUM QUALITY
Fußanlasser ohne Kabel <i>Motor Controller Pedal without cable</i>	*B72001	*B72001A
Fußanlasser ohne Kabel <i>Motor Controller Pedal without cable</i>		BC-2503D
Fußanlasser mit Kabel und Stecker für Motor B74000 <i>Foot Controller with cable and plug for Motor B74000</i>	B72009	
Fußanlasser mit Kabel und Stecker für Motor BC-2500/2503 <i>Motor Controller Pedal with</i>		BC-2503E
Fußanlasser für elektronischen Motor <i>Motor Controller Pedal for electronic domestic motor</i>		BC-2503F
Anschlußkabel für Motor B74000 <i>Cable for Motor B74000</i>	*B72005	
Anschlußkabel für Motor BC-2500/2503 <i>Cable for Motor BC-2500/2503</i>		BC-2503C

*Nicht mehr lieferbar
*No longer available

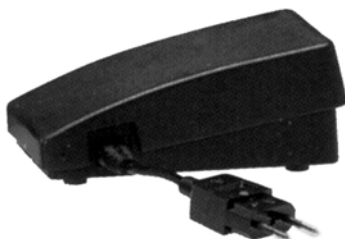

BC-2503F



BC-2503D



BC-2503E

Keilriemenscheiben
Motor Pulleys

Artikelbezeichnung <i>Item description</i>		Artikelnummer <i>Item-no.</i>
Für Anlassermotor, Bohrung 10 mm <i>For Artisan Motor, 10 mm Hole</i>		B12005
Für Anlassermotor AV-AN, Bohrung 12 mm <i>For Artisan Motor AV-AN, 12 mm Hole</i>		B303
Für Kupplungsmotor <i>For Clutch Motor</i>	50 mm	BC-2447Z
	63 mm	BC-2447
	67 mm	BC-2447A
	71 mm	BC-2447B
	75 mm	BC-2447C
	80 mm	BC-2447D
	85 mm	BC-2447E
	90 mm	BC-2447F
	95 mm	BC-2447G
	100 mm	BC-2447H
	106 mm	BC-2447I
	112 mm	BC-2447J
	118 mm	BC-2447K
	125 mm	BC-2447L
	132 mm	BC-2447N
	136 mm	BC-2447O
	140 mm	BC-2447M
	145 mm	BC-2447P
	150 mm	BC-2447Q
155 mm	BC-2447R	
160 mm	BC-2447S	



B12005 + B303



BC-2447 – BC-2447S

Keilriemen Profil 5mm
Endless V-Belt 5mm

Artikelbezeichnung <i>Item description</i>	Artikelnummer <i>Item-no.</i>	Artikelbezeichnung <i>Item description</i>	Artikelnummer <i>Item-no.</i>
5 x 160 mm	B11017	5 x 350 mm	B11034
5 x 185 mm	B11018	5 x 352 mm	B11035
5 x 190 mm	B11019	5 x 358 mm	B11036
5 x 229 mm	B11020	5 x 375 mm	B11037
5 x 236 mm	B11021	5 x 406 mm	B11038
5 x 260 mm	B11022	5 x 420 mm	B11039
5 x 265 mm	B11023	5 x 425 mm	B11040
5 x 270 mm	B11024	5 x 435 mm	B11041
5 x 280 mm	B11025	5 x 465 mm	B11042
5 x 287 mm	B11026	5 x 475 mm	B11043
5 x 300 mm	B11027	5 x 495 mm	B11044
5 x 315 mm	B11028	5 x 500 mm	B11045
5 x 322 mm	B11029	5 x 514 mm	B11046
5 x 330 mm	B11030	5 x 530 mm	B11047
5 x 335 mm	B11031	5 x 554 mm	B11048
5 x 340 mm	B11032	5 x 600 mm	B11049
5 x 345 mm	B11033		



Keilriemen Profil 8mm
Endless V-Belt 8mm

Artikelbezeichnung <i>Item description</i>	Artikelnummer <i>Item-no.</i>	Artikelbezeichnung <i>Item description</i>	Artikelnummer <i>Item-no.</i>
8 x 430 mm	BC-2431x430	8 x 825 mm	BC-2431x825
8 x 475 mm	BC-2431x475	8 x 830 mm	BC-2431x830
8 x 490 mm	BC-2431x490	8 x 850 mm	BC-2431x850
8 x 530 mm	BC-2431x530	8 x 875 mm	BC-2431x875
8 x 560 mm	BC-2431x560	8 x 900 mm	BC-2431x900
8 x 600 mm	BC-2431x600	8 x 950 mm	BC-2431x950
8 x 630 mm	BC-2431x630	8 x 1000 mm	BC-2431x1000
8 x 670 mm	BC-2431x670	8 x 1075 mm	BC-2431x1075
8 x 700 mm	BC-2431x700	8 x 1120 mm	BC-2431x1120
8 x 710 mm	BC-2431x710	8 x 1250 mm	BC-2431x1250
8 x 750 mm	BC-2431x750	8 x 1400 mm	BC-2431x1400
8 x 760 mm	BC-2431x760	8 x 1500 mm	BC-2431x1500
8 x 775 mm	BC-2431x775	8 x 1545 mm	BC-2431x1545
8 x 800 mm	BC-2431x800		



Keilriemen Profil 10mm
Endless V-Belt 10mm

Artikelbezeichnung <i>Item description</i>	Artikelnummer <i>Item-no.</i>	Artikelbezeichnung <i>Item description</i>	Artikelnummer <i>Item-no.</i>
10 x 350 mm	BC-2432x350	10 x 1000 mm	BC-2432x1000
10 x 530 mm	BC-2432x530	10 x 1016 mm	BC-2432x1016
10 x 540 mm	BC-2432x540	10 x 1030 mm	BC-2432x1030
10 x 560 mm	BC-2432x560	10 x 1041 mm	BC-2432x1041
10 x 575 mm	BC-2432x575	10 x 1050 mm	BC-2432x1050
10 x 600 mm	BC-2432x600	10 x 1060 mm	BC-2432x1060
10 x 630 mm	BC-2432x630	10 x 1080 mm	BC-2432x1080
10 x 700 mm	BC-2432x700	10 x 1100 mm	BC-2432x1100
10 x 710 mm	BC-2432x710	10 x 1120 mm	BC-2432x1120
10 x 725 mm	BC-2432x725	10 x 1150 mm	BC-2432x1150
10 x 750 mm	BC-2432x750	10 x 1165 mm	BC-2432x1165
10 x 775 mm	BC-2432x775	10 x 1180 mm	BC-2432x1180
10 x 800 mm	BC-2432x800	10 x 1225 mm	BC-2432x1225
10 x 825 mm	BC-2432x825	10 x 1250 mm	BC-2432x1250
10 x 850 mm	BC-2432x850	10 x 1270 mm	BC-2432x1270
10 x 875 mm	BC-2432x875	10 x 1320 mm	BC-2432x1295
10 x 900 mm	BC-2432x900	10 x 1400 mm	BC-2432x1400
10 x 950 mm	BC-2432x950		
10 x 975 mm	BC-2432x975		
10 x 980 mm	BC-2432x980		



Zahnkeilriemen
Toothed V-Belt

Artikelbezeichnung <i>Item description</i>	Artikelnummer <i>Item-no.</i>	Artikelbezeichnung <i>Item description</i>	Artikelnummer <i>Item-no.</i>
MB 235	BMB235	MB 360	BMB360
MB 250	BMB250	MB 365	BMB365
MB 260	BMB260	MB 370	BMB370
MB 270	BMB270	MB 380	BMB380
MB 280	BMB280	MB 385	BMB385
MB 290	BMB290	MB 395	BMB395
MB 300	BMB300	MB 430	BMB430
MB 310	BMB310	MB 440	BMB440
MB 320	BMB320	MB 470	BMB470
MB 330	BMB330	MB 510	BMB510
MB 340	BMB340	MB 530	BMB530
MB 345	BMB345	MB 540	BMB540
MB 350	BMB350		

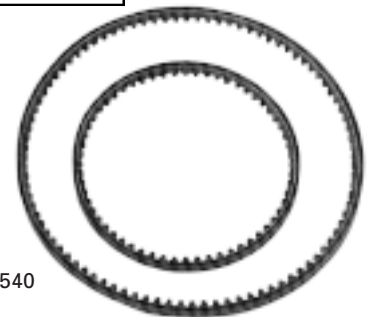

BMB235 – BMB540

Fatex-Riemen
Elastic Round Belts

Artikelbezeichnung <i>Item description</i>	Artikelnummer <i>Item-no.</i>
N-5861 für Quick-Motore 1400 U/Min <i>N-5861 for Quick-Motore 1400 UPM</i>	BC-2433A
N-5860 für Quick-Motore 2800 U/Min <i>N-5860 for Quick-Motore 2800 UPM</i>	BC-2433
N-5859 für Quick PFA 54 <i>N-5859 for Quick PFA 54</i>	BC-2433B



BC-2433 – BC2433B

Kernlederrundriemen Leather Round Belts

Artikelbezeichnung <i>Item description</i>	Artikelnummer <i>Item-no.</i>
Lederrundriemen 5,0 mm a 2 Meter, kompl. mit Riemenhaken <i>Round Leather Belt 5.0 mm, piece of 2 m, compl. with belt hooks</i>	B23001A
Lederrundriemen 5,5 mm a 2 Meter, kompl. mit Riemenhaken <i>Round Leather Belt 5.5 mm, piece of 2 m, compl. with belt hooks</i>	B23000A
Lederrundriemen 5,0 mm, Rolle a 30 m <i>Round Leather Belt 5.0 mm, roll of 30 m</i>	B23001
Lederrundriemen 5,5 mm, Rolle a 30 m <i>Round Leather Belt 5.5 mm, roll of 30 m</i>	B23000
Riemenhaken für 5,0 mm und 5,5 mm Riemen <i>Belt Hook for 5.0 mm und 5.5 mm belts</i>	B23005
Riemenlochzange <i>Belt Pliers</i>	BC-2445



B23000 – B23001A

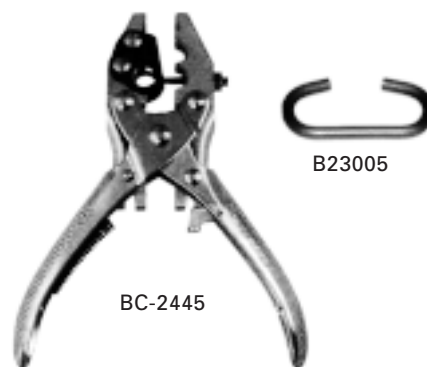

BC-2445

B23005

Kondensatoren Motor Capacitors

Artikelbezeichnung <i>Item description</i>	Artikelnummer <i>Item-no.</i>
8 μ F	BC-2489
16 μ F	BC-2490
25 μ F	BC-2491
30 μ F	BC-2492
35 μ F	BC-2492A



BC-2489 – BC-2492A

Motorkohle
Carbon Brush

Artikelbezeichnung <i>Item description</i>		Artikelnummer <i>Item-no.</i>
Motorkohle, mit Feder <i>Carbon Brush, with spring</i>	4 x 4 x 10	B15002
	4 x 4.4 x 10	B15003
	4 x 4.5 x 12.5	B15004
	4 x 5 x 13	B15007
	4 x 6 x 15	B15009
	4 x 8 x 25	B15013
	4.5 x 5.5 x 15	B15014
	5 x 4.5 x 16	B15016
	5 x 5 x 15	B15018
	5 x 5.5 x 12	B15019
	5 x 6 x 15	B15021
	5 x 8 x 25	B15024
	6 x 6 x 20	B15028
	6 x 8 x 25	B15032
Motorkohle, mit Teller, Kabel und Feder <i>Carbon Brush, with plate, wire and spring</i>	4 x 4 x 13	BC-2496
	4 x 5 x 15	B15006
	4 x 6 x 14	B15008
	4 x 8 x 19	B15012
	5 x 5 x 15	B15017
	5 x 6 x 12	B15020
	5 x 8 x 20	B15023
	6 x 6 x 20	BC-2495
	6 x 8 x 22	B15030



Motor Kohle
Carbon Brush

Artikelbezeichnung <i>Item description</i>	Artikelnummer <i>Item-no.</i>	
Motorkohle, mit Bügel, Kabel und Feder <i>Carbon Brush, with bow, wire and spring</i>	3 x 12,5 x 20	BC-2493
	3 x 4 x 15	BC-2497
	4 x 5 x 15	B15005
	4 x 6,4 x 13	B15010
	4 x 7 x 15	B15011
	5 x 10 x 25	B15015
	5 x 12,5 x 25	B15035
	5 x 5 x 18	BC-2498
	5 x 8 x 22	BC-2499
	5 x 9 x 20	B15025
	6 x 6 x 16	B15026
	6 x 8 x 23	BC-2494A
	6 x 9 x 22	BC-2494
	6,4 x 8 x 22	B15034



Schalter
Switches

Artikelbezeichnung <i>Item description</i>	Artikelnummer <i>Item-no.</i>
1-Phasen-Schaltegarbeit, mit Kabel und Schuko-Stecker <i>Single Phase Switch Box with Cable and Schuko-plug</i>	BC-4499A
3-Phasen-Schutzschalter IP54, kompl. mit Kabel und Montagewinkel, Sicherungsbereich 0,6-1,0 A <i>Three Phase Circuit Breaker Switch IP54 with Cable and Bracket, suitable for 0,6-1,0A</i>	BC-4502
3-Phasen-Schutzschalter IP54, kompl. mit Kabel und Montagewinkel, Sicherungsbereich 1,6-2,5 A <i>Three Phase Circuit Breaker Switch IP54 with Cable and Bracket, suitable for 1,6-2,5A</i>	BC-4500

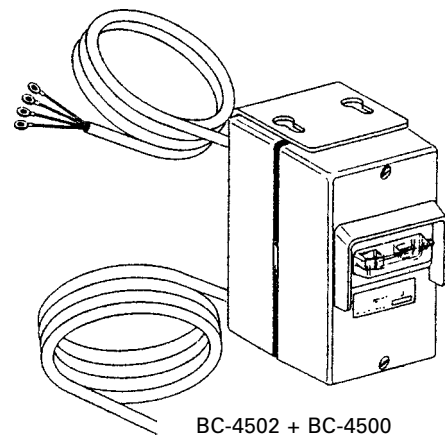
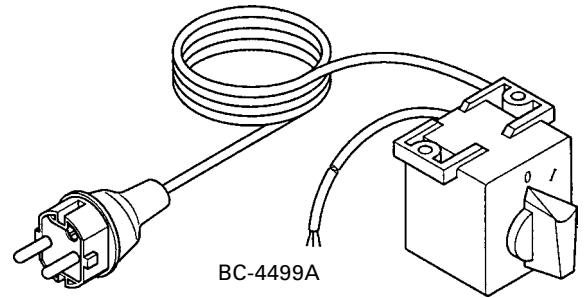

Stecker
Plugs

Artikelbezeichnung <i>Item description</i>	Artikelnummer <i>Item-no.</i>
Schuko-Stecker <i>Schuko Plug (2 Pins)</i>	BC-4498A
Perilex-Stecker (5-polig) <i>Perilex Plug (5 Pins)</i>	BC-4498B
Cekon-Stecker (5-polig) <i>Cekon Plug (5 pins)</i>	BC-4498D

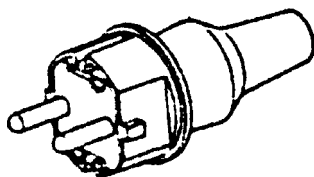

BC-4498A

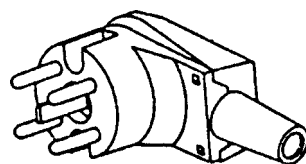

BC-4498B

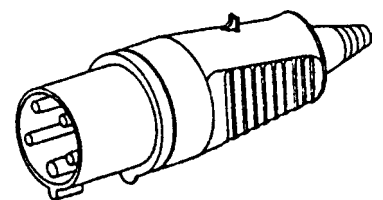

BC-4498D

1: NÄHEN *SEWING*

1.14 NÄHTISCHE UND ZUBEHÖR *TABLE TOPS AND ACCESSORIES*

Tischplatten Table Tops

Artikelbezeichnung <i>Item description</i>	Artikelnummer <i>Item-no.</i>	
Tischplatte, ohne Ausschnitt <i>Table Top, without cut</i>	106 x 50 x 4 cm	BC-4525/50OA
	106 x 55 x 4 cm	BC-4525/55OA
	106 x 60 x 4 cm	BC-4525/60OA
Tischplatte, mit Ausschnitt <i>Table Top, with cut</i>	106 x 50 x 4 cm	BC-4525/50
	106 x 55 x 4 cm	BC-4525/55
	106 x 60 x 4 cm	BC-4525/60

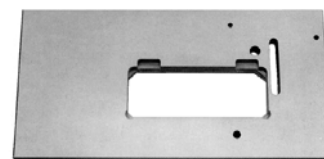

Bitte geben Sie bei der Bestellung von Tischplatten mit Ausschnitt die vollständige Maschinen-Klassenbezeichnung an. Sofern keine anders lautenden Bestellangaben gemacht werden, erfolgt die Lieferung mit weiß-grau meliertem Oberflächendekor. Auf Wunsch sind Tischplatten für Maschinen in teil- oder vollversenkter Einbauweise lieferbar.

Please always indicate the complete machine class if you order table tops. Delivery will be executed with white-grey mixed surface decor if not mentioned divergent. Table tops for semi- or fully submerged sewing machines are available on request.

Drehstühle Swivel Chairs

Artikelbezeichnung <i>Item description</i>	Artikelnummer <i>Item-no.</i> STANDARD	Artikelnummer <i>Item-no.</i> PREMIUM
Drehstuhl mit Holz Sitzfläche, stufenlose Sitzhöhenverstellung von 440 - 590 mm <i>Swivel Chair with wooden seat, stepless height adjustment from 440 - 590 mm</i>	BC-4520	BC-4530P
Drehstuhl mit Holz Sitzfläche wie BD-4520, aber mit Gasdruckfeder <i>Swivel Chair with wooden seat like BD-4520, but with pressure spring</i>	BC-4522	
Drehstuhl mit Polstersitzfläche, stufenlose Sitzhöhenverstellung von 450 - 630 mm <i>Swivel Chair with seat upholstery, stepless height adjustment from 450 - 630 mm</i>	BC-4521	
Drehstuhl BC-4521, mit Bandscheiben-Stoffpolstersitz <i>Swivel Chair BC-4521, but with ergonomic seat upholstery</i>	BC-4521A	
Drehstuhl mit Polstersitzfläche, stufenlose Sitzhöhenverstellung von 440 - 590 mm <i>Swivel Chair with seat upholstery, stepless height adjustment from 440 - 590 mm</i>		BC-4531P



BC-4530P



BC-4531P



BC-4520



BC-4522



BC-4521

Gestelle
Table Stands

Artikelbezeichnung <i>Item description</i>	Artikelnummer <i>Item-no.</i>
Gestell aus Formblech (L: 790 x B: 500 mm) höhenverstellbar von 725 - 815 mm, mit neigbarer Tischplattenauflage. Fußpedal bereits enthalten. <i>Table Stand of moulded sheet-iron</i> (L: 790 x W: 500 mm) hight adjustable 725 - 815 mm, with inclineable table top rest. Foot pedal already included.	BC-4515P
Gestell aus Profilstahlrohr (L: 760 x B: 475 mm) höhenverstellbar von 705 - 850 mm, mit zwei zusätzlichen Stützstreben und neigbarer Tischplattenauflage, sowie Bodenausgleichsfuß. Fußpedal bereits enthalten. <i>Table Stand of rectangular steel tubes</i> (L: 760 x W: 475 mm) hight adjustable 705 - 850 mm, with additional front support, inclineable table top rest and one floor-leveling foot. Foot pedal already included.	BC-4516BVT
Gestell aus Profilstahlrohr (L: 760 x B: 475 mm) höhenverstellbar von 705 - 850 mm, mit zwei zusätzlichen Stützstreben und neigbarer Tischplattenauflage, ausgestattet mit vier feststellbaren, fadengeschützten Radrollen. Fußpedal bereits enthalten. <i>Table Stand of rectangular steel tubes</i> (L: 760 x W: 475 mm) hight adjustable 705 - 850 mm, with additional front support, inclineable table top rest and four thread-guarded swivel casters with brake. Foot pedal already included.	BC-4516BVT/RO

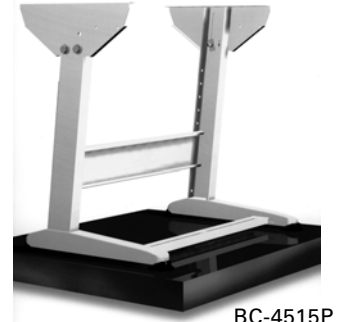

BC-4515P



BC-4516BVT

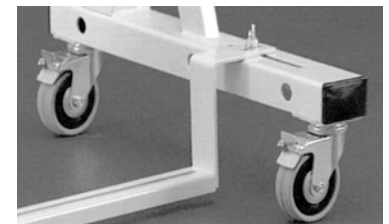

BC-4516BVT/RO

Die Lieferung der Gestelle erfolgt mit weiß-grauer Lackierung,
zerlegt im Einzelkarton, komplett mit einem breiten Fußtritt.

*Table stands are supplied in white-grey colour,
dismantled in single cardbox, complete with wide foot pedal.*

für alle drei Gestelle
for all three stands

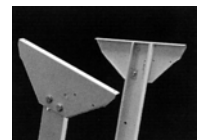

Kantengummis
Base Cushions

Artikelbezeichnung <i>Item description</i>	Artikelnummer <i>Item-no.</i>
Kantengummi Adler <i>Base Cushion Adler</i>	BD-4142
Kantengummi Dürkopp <i>Base Cushion Dürkopp</i>	BD-4137
Kantengummi ISO <i>Base Cushion ISO</i>	BD-4138
Kantengummi Pfaff <i>Base Cushion Pfaff</i>	BD-4141

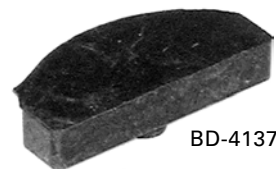

BD-4137

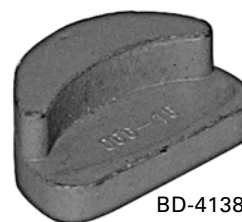

BD-4138

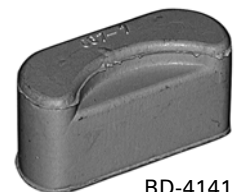

BD-4141

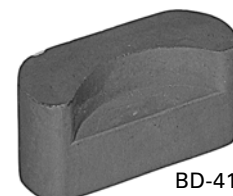

BD-4142

Scharniergummis Rubber Hinges

Artikelbezeichnung <i>Item description</i>	Artikelnummer <i>Item-no.</i>
Scharniergummi Dürkopp <i>Rubber Hinge Dürkopp</i>	BD-4136
Scharniergummi ISO <i>Rubber Hinge ISO</i>	BD-4058
Scharniergummi Pfaff <i>Rubber Hinge Pfaff</i>	BD-4140

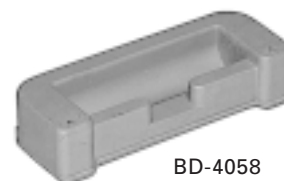
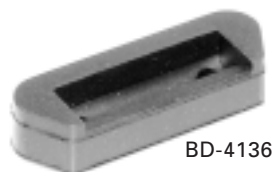

Scharnierhaken Metal Hinges

Artikelbezeichnung <i>Item description</i>	Artikelnummer <i>Item-no.</i>
Scharnierhaken ISO <i>Metal Hinge ISO</i>	BD-4059
Scharnierhaken Pfaff <i>Metal Hinge Pfaff</i>	BD-4139A

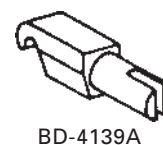

Schubladen Drawers

Artikelbezeichnung <i>Item description</i>	Artikelnummer <i>Item-no.</i>
Kunststoff-Schublade 330 x 150 x 80 mm mit Metalleisten <i>Plastic Drawer 330 x 150 x 80 mm with metall slides</i>	BD-4146
Kunststoff-Schublade 385 x 170 x 100 mm mit Kunststoffleisten <i>Plastic Drawer 385 x 170 x 100 mm with plastic slides</i>	BD-4147



Fußpedale
Foot Pedals

Artikelbezeichnung <i>Item description</i>	Artikelnummer <i>Item-no.</i>
Fußpedal 240 x 265 mm <i>Foot Pedal 240 mm x 265 mm</i>	BC-2451
Fußpedal L: 240 x B: 135 mm <i>Foot Pedal 240 mm x 135 mm</i>	BC-2452



BC-2451



BC-2452

Motorzugstange
Treadle Rod

Artikelbezeichnung <i>Item description</i>	Artikelnummer <i>Item-no.</i>
Motorzugstange <i>Treadle Rod, Complete</i>	BC-2453
Knotenkette 100cm, komplett mit 2 S-Haken <i>Handle Chain 100cm, complete with 2 S-hooks</i>	BC-2526



BC-2453

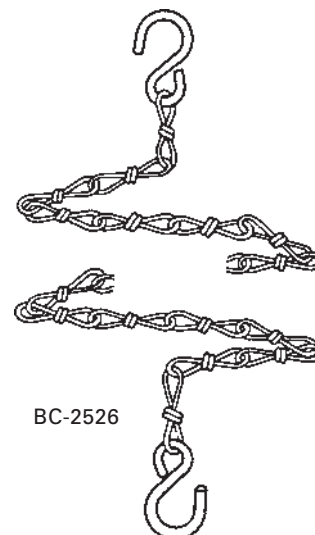

BC-2526

Zubehör Accessories

Artikelbezeichnung <i>Item description</i>	Artikelnummer <i>Item-no.</i>
Kniehebelpolster <i>Rubber Knee Lifter Pad</i>	BC-2524
Gummiteller, vibrations- und geräuschkäufend, geeignet für Reece-Nähtischgestelle <i>Rubber Leg Cushion, noise and vibration absorbing, suitable for Reece table stands</i>	BC-2525
Tischmagnet <i>Hold Magnet</i>	BC-2528
Oberteilstütze 100 mm lang, mit 14 mm Zapfendurchmesser <i>Table Pin 100 mm length, 14 mm diametre</i>	BD-4145



BC-2524



BC-2528



BD-4145

Wartungseinheit Filter Regulator Gauge Set

Artikelbezeichnung <i>Item description</i>	Artikelnummer <i>Item-no.</i>
Wartungseinheit <i>Filter Regulator Gauge Set</i>	BC-4470
Schraube für Wartungseinheit <i>Screw for filter regulator gauge set</i>	BC-4471
Scheibe für Wartungseinheit <i>Washer for filter regulator gauge set</i>	BC-4472
Schnellverschraubung für Wartungseinheit <i>Fast Mounting Screw Ring for filter regulator gauge set</i>	BC-4473
Winkel für Wartungseinheit <i>Mounting Bracket for filter regulator gauge set</i>	BC-4474



BC-4470



BC-4471



BC-4472



BC-4473

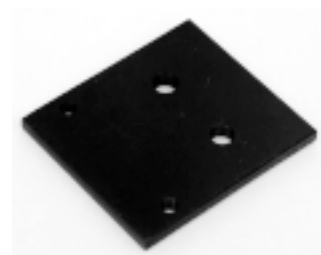

BC-4474

Montageteile
Assembly Parts

Artikelbezeichnung <i>Item description</i>	Artikelnummer <i>Item-no.</i>
Schutzschalter-Montagewinkel <i>Circuit Breaker Switch Bracket</i>	BC-4509
Schraube M8 zur Motorbefestigung <i>Screw M8 for motor fixation</i>	BC-4450
Unterlagscheibe zur Motorbefestigung <i>Washer for motor fixation</i>	BC-4451
Sicherungsscheibe zur Motorbefestigung <i>Security Washer for motor fixation</i>	BC-4452
Schraube zur Schubladenbefestigung <i>Screw for drawer fixation</i>	BC-4453
Schraube zur Schutzschalterbefestigung <i>Screw for switch circuit breaker fixation</i>	BC-4454
Nagelschelle, einfach, 7 - 11 mm <i>Cable Clamp, single, 7 - 11 mm</i>	BC-4456
Nagelschelle, zweifach, 7 - 11 mm <i>Cable Clamp, double, 7 - 11 mm</i>	BC-4455
Nagelclip (klein) <i>Cable Clamp (small)</i>	BC-4457
Zugentlastung <i>Cable Pull-out Protection</i>	BC-4458
Schraube für Zugentlastung <i>Screw for cable pull-out protection</i>	BC-4459
Erdungskabel 500 mm <i>Grounding Cable 500 mm</i>	BC-4460
Erdungskabel 650 mm <i>Grounding Cable 650 mm</i>	BC-4461
Schraube für Erdungskabel <i>Screw for grounding cable</i>	BC-4462
Zahnscheibe für Erdungskabel <i>Toothed Washer for grounding cable</i>	BC-4463
Unterlagscheibe für Erdungskabel <i>Washer for grounding cable</i>	BC-4464
Kabelbinder, kurz <i>Cable Tie, short</i>	BC-4465
Kabelbinder, mittel <i>Cable Tie, medium</i>	BC-4466
Kabelbinder, lang <i>Cable Tie, long</i>	BC-4467



Garnrollenmagazin
Thread Storage Rack

Artikelbezeichnung <i>Item description</i>	Artikelnummer <i>Item-no.</i>
Garnrollenmagazin mit Tischklemme, geeignet zur Aufnahme von 15 Garnrollen a 5000 m oder 10000m, mit einzelner Fadenführung/Fadenklemme je Faden <i>Thread Storage Rack with table clamp, suitable for 15 thread cones of 5000 m or 10000 m, complete with individual thread guide/clamp for each thread</i>	*BC-2517A
Garnrollenmagazin mit Tischklemme, geeignet zur Aufnahme von 25 Garnrollen a 1000 m <i>Thread Storage Rack with table clamp, suitable for 25 thread cones of 1000 m</i>	BC-2517
Garnrollenmagazin mit Tischklemme, geeignet zur Aufnahme von 50 Garnrollen a 1000m, mit einzelner Fadenführung/Fadenklemme je Faden und zusätzlicher Fadenabzugsstange <i>Thread Storage Rack with table clamp, suitable for 50 thread cones of 1000 m, complete with individual thread guide/clamp for each thread and additional upper thread guide stand</i>	*BC-2517B
Spulenbox für 24 Unterfadenspulen, geeignet zur Untertischmontage <i>Bobin Box for 24 sewing machine bobbins, suitable for fixation under the table top</i>	BC-2574

*Nicht mehr lieferbar
*No longer available

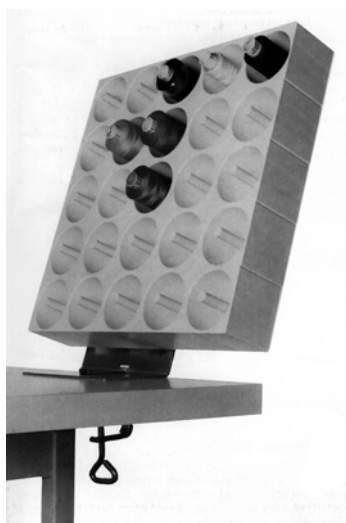

BC-2517



BC-2574

Garnständer
Thread Stand

Artikelbezeichnung <i>Item description</i>	Artikelnummer <i>Item-no.</i>
Garnständer, 1-fädig, für Blindstich- und Pelznähmaschinen <i>Thread Stand 1-thread, for blindstitch and fur sewing machines</i>	BC-2518
Garnständer, 1-fädig, mit Plastikteller <i>Thread Stand 1-thread with plastic platform</i>	BC-2518A
Garnständer, 2-fädig, mit Plastikteller <i>Thread Stand 2-thread with plastic platform</i>	BC-2519
Garnständer, 2-fädig, mit Kabeldurchführung, ganzmetall <i>Thread Stand 2-thread with power feed pipe, all metal</i>	BC-2520
Garnständer, 3-fädig, mit Kabeldurchführung, ganzmetall <i>Thread Stand 3-thread with power feed pipe, all metal</i>	BC-2521
Garnständer, 4-fädig, mit Kabeldurchführung, ganzmetall <i>Thread Stand 4-thread with power feed pipe, all metal</i>	BC-2522



Bandabwickelständer
Tape Rack

Artikelbezeichnung <i>Item description</i>	Artikelnummer <i>Item-no.</i>
Bandabwickelständer mit Tischklemme, ganzmetall <i>Tape Rack with Table Clamp, all metal</i>	BA-1540
Bandabwickelständer mit Tischklemme, schwere Ausführung, ganzmetall <i>Tape Rack with Table Clamp, heavy duty, all metal</i>	BA-1540A
Bandabwickelständer mit Befestigungsplatte, zur Befestigung mit Holzschrauben, ganzmetall <i>Tape Rack with Table Base Plate, to be fixed by screws, all metal</i>	BA-1541
Bandabwickelständer mit Tischklemme, mit Kunststoffteller <i>Tape Rack with Table Clamp, with plastic plates</i>	BTR390

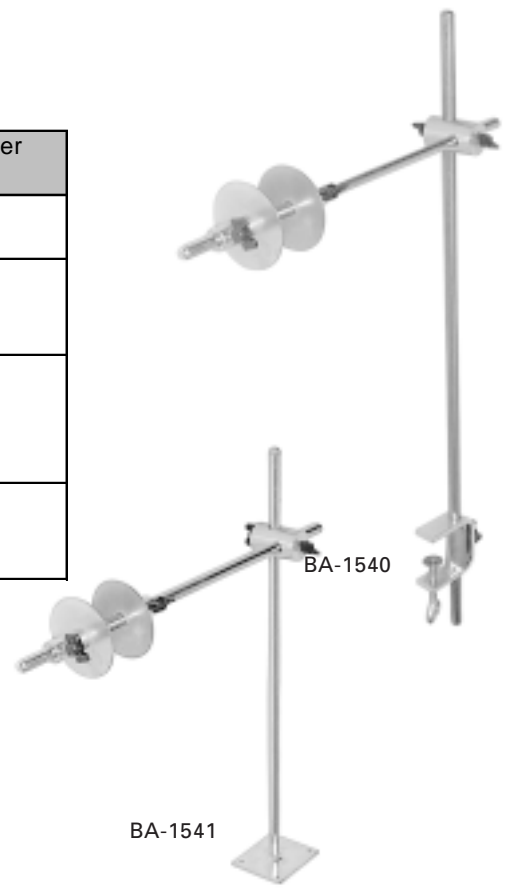
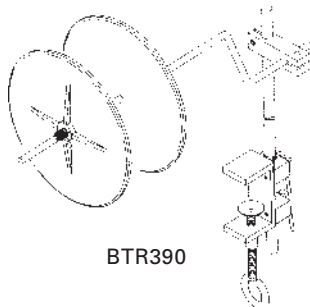

Bandabroller *Binding and Tape Reel*

Artikelbezeichnung <i>Item description</i>	Artikelnummer <i>Item-no.</i>
Bandabroller zur Befestigung auf dem Maschinenoberteil, komplett mit regulierbarer Bandbremse, geeignet für Consew, Seiko, Singer, etc. <i>Binding & Tape Reel Stand with adjustable tape tension, to be fixed at machine head, suitable for Consew, Seiko, Singer, etc.</i>	BA-1545A
Bandabroller zur Befestigung unter der Tischplatte, für vertikalen Bandabzug <i>Tape Rack to be fixed under the table top, for vertical tape feed</i>	BA-1543
Bandabroller zur Befestigung mit Tischklemme, für horizontalen oder vertikalen Bandabzug, mit kugelgelagerten Bandrollentellern <i>Binding & Tape Reel Stand to be fixed with table clamp, for horizontal or vertical tape feed, with ball bearing tape roll plates</i>	BA-1546s
Doppel-Bandabroller zur Befestigung mit Tischklemme, für horizontalen oder vertikalen Bandabzug, mit kugelgelagerten Bandrollentellern <i>Double Binding & Tape Reel Stand to be fixed with table clamp, for horizontal or vertical tape feed, with ball bearing tape roll plates</i>	BA-1548s
Bandabroller-Erweiterungs-Set, geeignet als Ergänzung zu BA-1546s/Ba-1548s <i>Binding & Tape Reel Stand Extension Set, to be used with BA-1546s/BA-1548s</i>	BA-1548As
Bandabroller zur Befestigung mit Tischklemme, für horizontalen Bandabzug von Strickbändern, mit kugelgelagertem Bandrollenteller <i>Binding & Tape Reel Stand to be fixed with table clamp, for horizontal knit tape feed, with ball bearing tape roll plate</i>	BA-1547s
Bandabroller zur Befestigung mit Tischklemme, für horizontalen Bandabzug, mit Nachlaufbremse <i>Binding & Tape Reel Stand to be fixed with table clamp, for horizontal tape feed, with NBL-brake spring</i>	BTR300
Bandabroller zur Befestigung mit Tischklemme, für horizontalen Bandabzug <i>Binding & Tape Reel Stand to be fixed with table clamp, for horizontal tape feed</i>	BA-1545
Bandabroller zur Befestigung auf der Tischplatte, für horizontalen Bandabzug <i>Binding & Tape Reel Stand to be fixed at the table top, for horizontal tape feed</i>	BA-1542

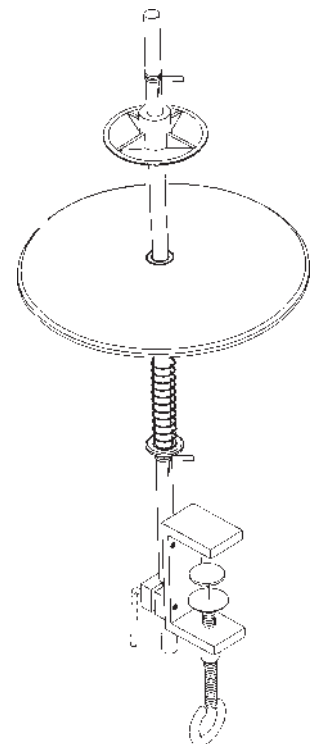

BTR300

Bandabroller
Binding and Tape Reel

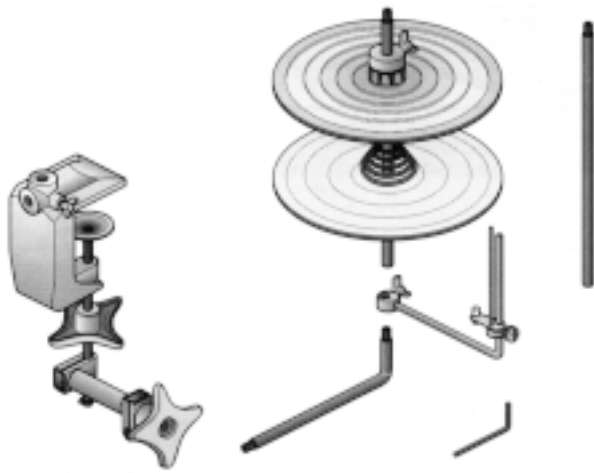

BA-1546s

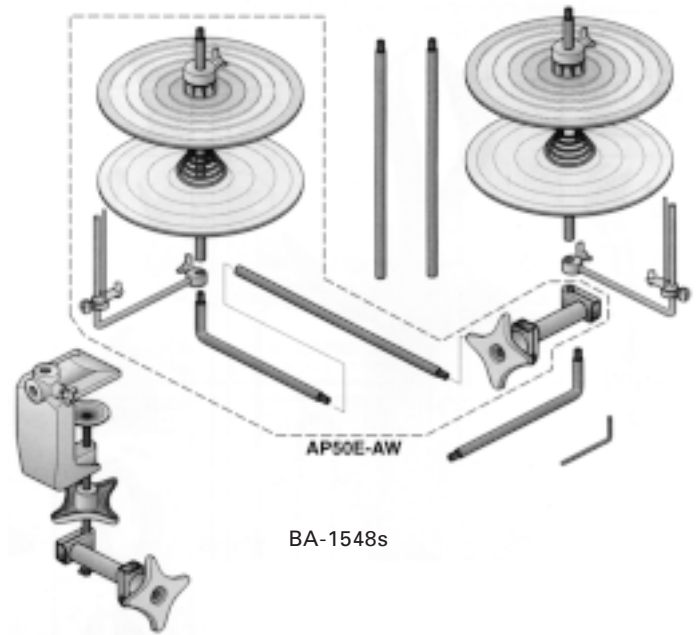

BA-1548s



BA-1548As

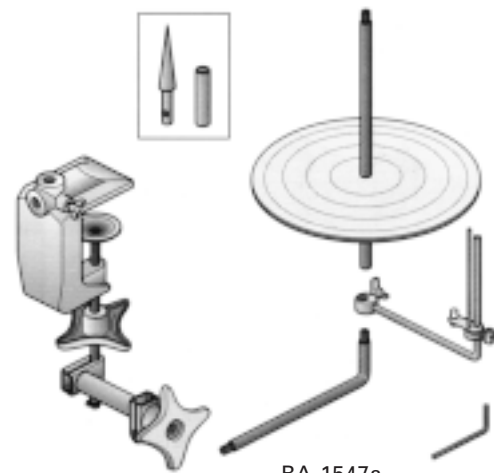

BA-1547s



BA-1545

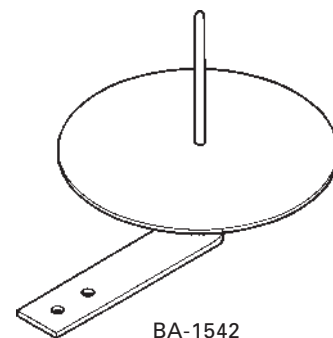

BA-1542

Tischspuler
Bobbin Winder

Artikelbezeichnung <i>Item description</i>	Artikelnummer <i>Item-no.</i>
Tischspuler <i>Bobbin Winder</i>	BC-2523



BC-2523

Maschinenabdeckhauben
Sewing Machine Covers

Artikelbezeichnung <i>Item description</i>	Artikelnummer <i>Item-no.</i>
Schmale Ausführung <i>Small version</i> 290 x 160 x 180 mm	BC-2540
Mittlere Ausführung <i>Medium version</i> 460 x 215 x 290 mm	BC-2541
Große Ausführung <i>Large version</i> 540 x 370 x 500 mm	BC-2542

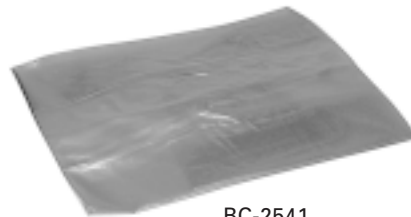

BC-2541

1: NÄHEN *SEWING*

1.15 HAUSHALTSNÄHMASCHINENBEDARF *DOMESTIC SEWING MACHINE EQUIPMENT*

Nähfüße Sewing Feet

Artikelbezeichnung <i>Item Description</i>		Artikelnummer <i>Item-number</i>
Geradstichfuß <i>Straight Stitch Foot</i>	mit niedrigem Schaft <i>with low shank</i>	B39006
	mit hohem Schaft <i>with high shank</i>	B39042
ZZ-Fuß <i>ZZ-foot</i>	mit niedrigem Schaft <i>with low shank</i>	B39007
	mit hohem Schaft <i>with high shank</i>	B39008
Säumerfuß <i>Hemmer Foot</i>	mit niedrigem Schaft <i>with low shank</i>	B39037
	mit hohem Schaft <i>with high shank</i>	B39038
Knopflochfuß <i>Buttonhole Foot</i>	mit niedrigem Schaft <i>with low shank</i>	B39048
	mit hohem Schaft <i>with high shank</i>	B39011
Rollfuß <i>Roller Foot</i>	mit niedrigem Schaft <i>with low shank</i>	B39060
	mit hohem Schaft <i>with high shank</i>	B39047
Knopfannähfuß <i>Button Sewing-on Foot</i>	mit niedrigem Schaft <i>with low shank</i>	B39070
	mit hohem Schaft <i>with high shank</i>	B39035
Reißverschlussfuß <i>Zipper Foot</i>	mit niedrigem Schaft <i>with low shank</i>	B39071
	mit hohem Schaft <i>with high shank</i>	B39049
Stickfuß <i>Satin Stitch Foot</i>	mit niedrigem Schaft <i>with low shank</i>	B39051
	mit hohem Schaft <i>with high shank</i>	B39046

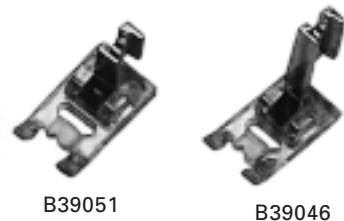
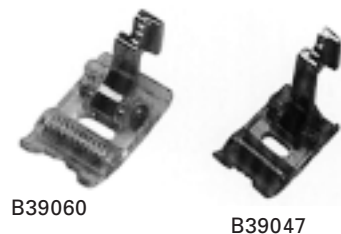
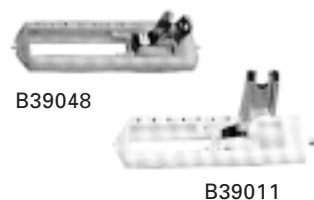
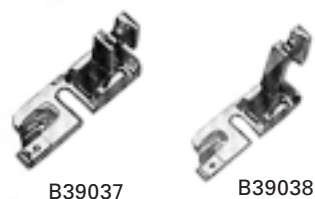
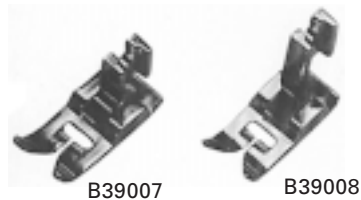

Nähfüße, Snap-on
Sewing Feet, Snap-on

Artikelbezeichnung <i>Item Description</i>	Artikelnummer <i>Item Number</i>
Kantenfußsohle <i>Cording Foot Sole</i>	B39000
Blindstichfußsohle <i>Blind Stitch Foot Sole</i>	B39001
Rollfußsohle <i>Roller Foot Sole</i>	B39002
Stickfußsohle <i>Satin Stitch Foot Sole</i>	B39003
ZZ-Fußsohle <i>ZZ-Foot Sole</i>	B39005
Knopflochfußsohle <i>Buttonhole Foot Sole</i>	B39015
Nähfußhalter, hoch <i>Shank Bracket, high</i>	B39022
Nähfußhalter, niedrig <i>Shank Bracket, low</i>	B39024
Reißverschlussfußsohle <i>Zipper Foot Sole</i>	B39025
Overlock-Fußsohle <i>Overlock Foot Sole</i>	B39026
Wattierlineal <i>Quilter Guide</i>	B39027
Knopfannähfußsohle <i>Button Sewing-on Foot Sole</i>	B39052
Säumerfußsohle <i>Hemmer Foot Sole</i>	B39065



B39000



B39001



B39002



B39003



B39005



B39015



B39022 + B39024



B39025



B39026



B39027



B39052



B39065

Messer
Knives

Artikelbezeichnung <i>Item Description</i>		Artikelnummer <i>Item-number</i> STANDARD	Artikelnummer <i>Item-number</i> PREMIUM
Bernina Bernette	Obermesser <i>Upper Knife</i>		BA4142-335- OOOCTm
	Untermesser <i>Lower Knife</i>		BA4145-335-OOOm
Brother B524, 525, 526	Obermesser <i>Upper Knife</i>	B127734-001	
	Untermesser <i>Lower Knife</i>	B127134-001	
Juki / BabyLock BL3-318, 408, 416, 418, 426 BL4-428, 436, 714, 738	Obermesser <i>Upper Knife</i>	B408-9101-01B	
	Untermesser <i>Lower Knife</i>		B408-9102-01Am
Juki / BabyLock BL3-406, 407 EF-405	Obermesser <i>Upper Knife</i>	B405-9101-01A	
	Untermesser <i>Lower Knife</i>		B405-9102-01Am
Juki / BabyLock BL4-436D	Obermesser <i>Upper Knife</i>		BPL-Q11-01Am
	Untermesser <i>Lower Knife</i>		BPL-R11-01Am
Juki / BabyLock BL4-605 EA-605 SL-500	Obermesser <i>Upper Knife</i>		BD-2760m
	Untermesser <i>Lower Knife</i>		BD-2759m BD-2759CTm
Juki / BabyLock BL4-738D, 5280ED	Obermesser <i>Upper Knife</i>		BPL-Q11-01Cm
	Untermesser <i>Lower Knife</i>		BSE-R11-01Am
Juki / BabyLock SL-803, 804	Obermesser <i>Upper Knife</i>		B60507m
	Untermesser <i>Lower Knife</i>		B60544m
New Home 603, 604	Obermesser <i>Upper Knife</i>	B77020	
	Untermesser <i>Lower Knife</i>	B77021	
Pfaff 794, 795, 796 HL-603, 604	Obermesser <i>Upper Knife</i>	B77020	
	Untermesser <i>Lower Knife</i>	B77021	
Ricar Lock RL-330, 333, 340, 343	Obermesser <i>Upper Knife</i>		B60507m
	Untermesser <i>Lower Knife</i>		B60544m
Viking M530	Obermesser <i>Upper Knife</i>	B127734-001	
	Untermesser <i>Lower Knife</i>	B127134-001	

Messer
Knives

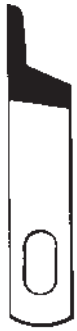

BA4142-335-OOOCTm



BA4145-335-OOOm



B127734-001



B127134-001



B408-9101-01B



B408-9102-01Am



B405-9101-01A



B405-9102-01A



BPL-Q11-01Am



BPL-R11-01Am



BD-2760m



BD-2759m
BD-2759CTm



BPL-Q11-01Cm



BSE-R11-01Am



B60507m



B60544m



B77020



B77021

Kettenstichgreifer
Looper

Artikelbezeichnung <i>Item Description</i>		Artikelnummer <i>Item-number</i> STANDARD	Artikelnummer <i>Item-number</i> PREMIUM
Bernina Bernette	Obergreifer <i>Upper Hook</i>	BD-2748	
	Untergreifer <i>Lower Hook</i>	BD-2749	
Brother B524, 525, 526	Obergreifer <i>Upper Hook</i>		B127814-001m
	Untergreifer <i>Lower Hook</i>		B127815-001m
	Spreizer <i>Spreader</i>		B127260-001m
Juki / BabyLock BL-300	Obergreifer <i>Upper Hook</i>	B60768	
	Untergreifer <i>Lower Hook</i>	B60335	
Juki / BabyLock BL3-200, 418	Obergreifer <i>Upper Hook</i>	B407-6101-01A	
	Untergreifer <i>Lower Hook</i>		B418-6101-02Am
Juki / BabyLock BL3-406	Obergreifer <i>Upper Hook</i>	B407-6101-01A	
	Untergreifer <i>Lower Hook</i>	B77018	
Juki / BabyLock BL4-605 EA-605	Obergreifer <i>Upper Hook</i>	B205-6101-01C	
	Untergreifer <i>Lower Hook</i>	BD-2761	
Juki / BabyLock BL4-738D, 5280ED	Obergreifer <i>Upper Hook</i>		B714-6101-01Am
	Untergreifer <i>Lower Hook</i>		B418-6101-02Am
Juki / BabyLock EF-405	Obergreifer <i>Upper Hook</i>	B405-6101-01C	
	Untergreifer <i>Lower Hook</i>	B77018	
Mammy Lock NL3, NL3-R	Obergreifer <i>Upper Hook</i>	B310629	
	Untergreifer <i>Lower Hook</i>	B310619	
New Home 603, 604	Obergreifer <i>Upper Hook</i>	B310629	
	Untergreifer <i>Lower Hook</i>	B310619	
Pfaff 794, 795, 796 HL-603	Obergreifer <i>Upper Hook</i>	B310629	
	Untergreifer <i>Lower Hook</i>	B310619	
Riccar Lock RL-330, 333, 340, 343	Obergreifer <i>Upper Hook</i>	B310629	
	Untergreifer <i>Lower Hook</i>	B310619	

Kettenstichgreifer
Looper



BD-2748



BD-2749

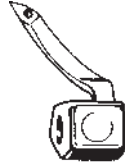

B127814-001m

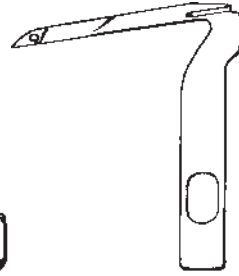

B127815-001m

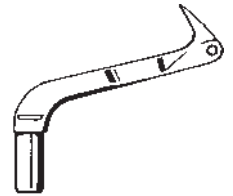

B127260-001m



B60768



B60335



B407-6101-01A

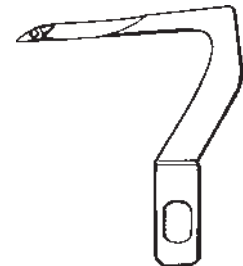

B418-6101-02Am



B205-6101-01C



BD-2761



B714-6101-01A



B405-6101-01C



B77018



B310629



B310619

CB-Greifer für ZZ-Nähmaschinen *Shuttle Hook for ZZ-Sewing Machines*

Artikelbezeichnung <i>Item Description</i>	Artikelnummer <i>Item Number</i>
CB-Greifer für ZZ-Haushaltsnähmaschinen <i>Shuttle Hook, standard for household zig-zag sewing machines</i>	B38035



B38035

ZZ-Spulen kapseln für Umlaufgreifer *ZZ-Bobbin Cases for Rotating Hooks*

Artikelbezeichnung <i>Item Description</i>	Originalnummer <i>Genuine Number</i>	Artikelnummer <i>Item Number</i>
Geschlossen für Singer 306, 319 <i>Closed for Singer 306, 319</i>	173058	BD-3368
Ausschnitt 12 mm für Brother, Riccar, etc. <i>Opening 12 mm for Brother, Riccar, etc.</i>		B38001
Ausschnitt 14 mm für Pfaff <i>Opening 14 mm for Pfaff</i>	9076ZZ	B38030
Mit Fadenführung für Adler, Meister, Phoenix <i>With thread guide for Adler, Meister, Phoenix</i>		BD-3342B
Schwarzer Kunststoff für Singer Apollo, etc. <i>Black plastic for Singer Apollo, etc.</i>	421325	B36011



BD-3368

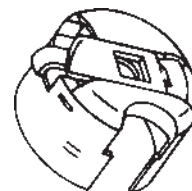

B38001



B38030



B36011

Geradstich-Spulen kapseln für CB-Greifer
Straight Stitch Bobbin Cases for Shuttle Hooks

Artikelbezeichnung <i>Item Description</i>	Originalnummer <i>Genuine Number</i>	Artikelnummer <i>Item Number</i>
Finger rechts <i>Finger right</i>	15277	B38003
Finger links (Kl. 15K88) <i>Finger left (Cl. 15K88)</i>	125291	BD-3329

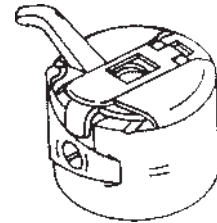

B38003

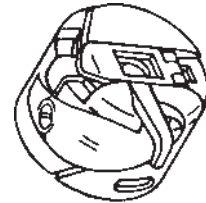

BD-3329

ZZ-Spulen kapseln für CB-Greifer
ZZ-Bobbin Cases for Shuttle Hooks

Artikelbezeichnung <i>Item Description</i>	Artikelnummer <i>Item Number</i>
Finger mit Bohrung <i>With Thread Guide Hole</i>	B38003A
Finger mit Bohrung (neue Version) <i>With Thread Guide Hole (new version)</i>	B38003B
Finger ohne Bohrung <i>Without Thread Guide Hole</i>	BD-3326



B38003A



B38003B



BD-3326

Spulen für Umlaufgreifer Bobbins for Rotating Hooks

Maschinenklasse Machine Class	Originalnummer Genuine number	Metallausführung Metal Version	Plastikausführung Plastic Version
für / for Adler, Meister, Naumann, Riccar, etc.	50623	BD-3385	B38027
für / for Bernina Kl. 116, 117, 217, etc.	330.026.03	B38041	
für Pfaff Kl. 130, 260, 3-teilig for Pfaff Cl. 130, 260, brim version	9033ZZ	B38012	
für Pfaff Kl. 130, 260, 1-teilig for Pfaff Cl. 130, 260, slim version	9033ZZ	B38023	B38011
für / for Singer Apollo, Capri, Samba, Kl. 66, etc.	172222 (32522)	B38024	B38008
für / for Singer Kl. 600, 700, 1000, etc.	163131		B38009
für / for Singer Kl. 700, 740, 760, etc.	506417		B38009A
für / for Singer Kl. 900, 1201, Futura, etc.	181551		B38025
für / for Singer Kl. 2010, Symphonie, etc.	312956		B38048

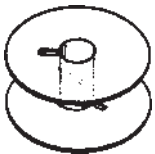

BD-3385
B38027
B38041

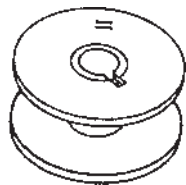

B38012

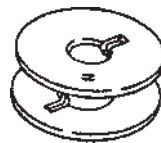

B38023
B38011

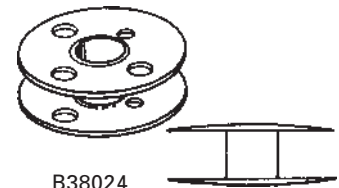

B38024
B38008

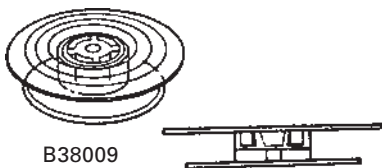

B38009
B38009A

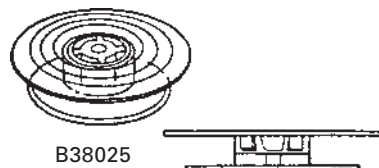

B38025

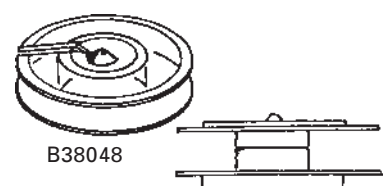

B38048

Spulen für CB-Greifer
Bobbins for Shuttle Hooks

Maschinenklasse <i>Machine Class</i>	Originalnummer <i>Genuine number</i>	Metallausführung <i>Metal Version</i>	Plastikausführung <i>Plastic Version</i>
für / for <i>Bernina Kl. 114, 530, 710, etc.</i>		B38016	
Lochspule, für die meisten jap./taiwan. CB-Maschinen <i>Bobbin with holes, for most jap./taiwan. SH-machines</i>	2518	B38020	
Geschlossene Spule, für die meisten jap./taiwan. Maschinen <i>Bobbin without holes, for most jap./taiwan. Machines</i>	2518C / 2518P	B38018	B38017



B38020

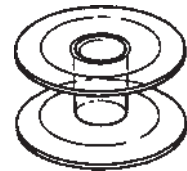

B38018
B38017

Weitere Ersatzteile
Further Spare Parts

Artikelbezeichnung <i>Item Description</i>	Artikelnummer <i>Item Number</i>
Lineal <i>Quilter</i>	B39044
Fadenspannung für ZZ- Haushaltsnähmaschinen (Taiwan) <i>Thread Tension for Household ZZ Sewing Machines (Taiwan)</i>	B71010



B39044



B71010

1: NÄHEN *SEWING*

1.16 NÄHZUBEHÖR *SEWING EQUIPMENT*

Einfädler
Threading Wires

Artikelbezeichnung <i>Item Description</i>	Artikelnummer <i>Item Number</i>
Einfädler für Steppstich- und Haushaltsmaschinen, 100 Stück pro Box <i>Threading Wire for lockstitch and household sewing machines, 100 pieces / box</i>	BB-2417
Einfädler für Overlockmaschinen, Länge ca. 140 mm <i>Threading Wire for overlock machines, length approx. 140 mm</i>	BC-2460
Einfädler für Schuhmachermaschinen (zum Einstoßen), Länge ca. 285 mm <i>Threading Wire for shoemaker machine (push type), length approx. 285 mm</i>	BC-2461A
Fadenholer, Länge ca. 300 mm <i>Threading Wire (pull type), Length approx. 300 mm</i>	BC-2461B



BB-2417

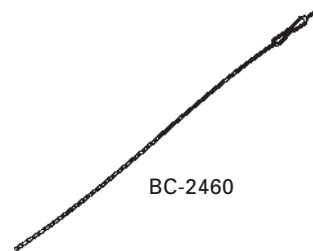

BC-2460

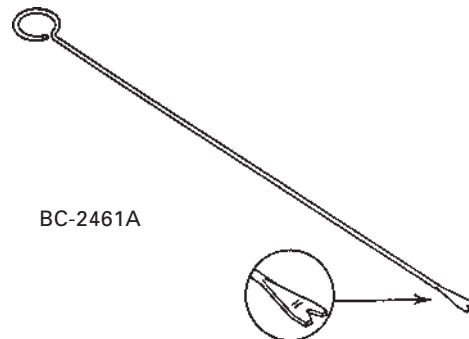

BC-2461A

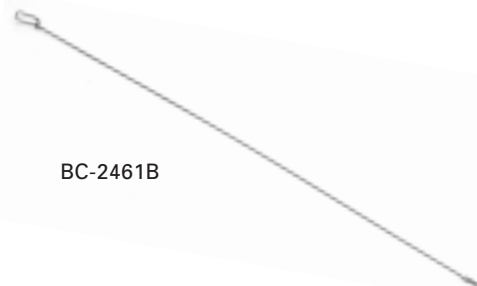

BC-2461B

Fingerschutze
Finger Guards

Artikelbezeichnung <i>Item Description</i>	Artikelnummer <i>Item Number</i>
Fingerschutz für Handwerker- und Haushaltsmaschinen (mit hohem Schaft) <i>Finger Guard for artisan and domestic sewing machines (high shank)</i>	B39061
Fingerschutz für Handwerker- und Haushaltsmaschinen (mit niedrigem Schaft) <i>Finger Guard for artisan and domestic sewing machines (low shank)</i>	B39062
Fingerschutz für Einnadel-Dreifachtransportmaschinen (Außenfuß mit flachem Schaft) <i>Finger Guard for single needle unison feed machines (outside foot with flat shank)</i>	*BB1471562000
Fingerschutz für Einnadel-Steppstichmaschinen <i>Finger Guard for single needle lockstitch machines</i>	BC-2449
Fingerschutz für Zweinadel-Nadeltransportmaschinen (mit flachem Schaft) <i>Finger Guard for double needle machines with needle feed (flat shank)</i>	BC-2449A



BC-2449



BC-2449A

*Nicht mehr lieferbar
*No longer available

2: ZUSCHNEIDEN *CUTTING*

2.0 SYMBOLERLÄUTERUNGEN *SYMBOL DESCRIPTIONS*

Symbolerklärungen
Symbol Descriptions

Clarificación des symboles
Explicación de los signos

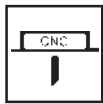

Cutter-Messer
Cutter Knives
Couteaux pour coupeuse
Cuchilla para „Cutter“

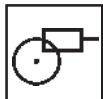

Kreismesser
Circular Knives
Lame rotative
Cuchilla circular



Stoßmesser
Straight Knives
Lame verticale
Cuchilla de impacto



Bandmesser
Band Knives
Lame pour scie à ruban
Cuchilla de cinta



Schleifstein
Sharpening Stone
Pierre d'affûtage
Piedra de afilar

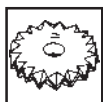

Auszackmaschinenzubehör
Pinking Equipment
Accessoires par machine à cranter
Accesorios para máquinas de reortar en forma dentada



Stoffklammern
Cloth clamps
Pince tissu
Pinzas sujetatelas



Handarbeitsscheren
Dressmaker Scissors
Ciseau
Tijeras para trabajo manual



Stickscheren
Embroidery Scissors
Ciseau de broderie
Tijeras de bordar



Schneiderscheren
Dressmaker Shears
Ciseau tailleur
Tijeras de sastrre



Zackenscheren
Pinking Shears
Ciseau à cranter
Tijeras dentada



Spezialscheren
Special Scissors
Ciseau special
Tijeras especial



Rollschneider
Roller Cutter
Cutter à roulette
Cortador de rueda

2: ZUSCHNEIDEN *CUTTING*

2.1 MESSER UND SCHLEIFSTEINE FÜR CUTTER *KNIVES AND SHARPENING STONES FOR CUTTER*

2.1

Cutter-Messer Cutter Knives

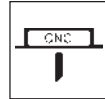

für / for BULLMER - Cutter					
Bemerkungen Remarks	Referenz Reference	Länge in mm Length in mm	Breite in mm Width in mm	Stärke in mm Thickness in mm	Artikelnummer Part No.
ohne Hohlschliff <i>without hollow ground</i>	51953	165	8,00	2,50	BB-2034
ohne Hohlschliff <i>without hollow ground</i>	50343	165	10,00	3,10	B50343
ohne Hohlschliff <i>without hollow ground</i>	104264	201	8,00	2,50	BB-1900
mit Hohlschliff <i>with hollow ground</i>	100124	201	8,00	2,50	BB-1901
mit Hohlschliff <i>with hollow ground</i>	102642	223	8,00	2,50	BB-2034B

für / for GERBER - Cutter					
Bemerkungen Remarks	Referenz Reference	Länge in mm Length in mm	Breite in mm Width in mm	Stärke in mm Thickness in mm	Artikelnummer Part No.
	G93 HPC S 5200	195	6,35	2,00	BB-1920
	G93 HPC S 5200	195	7,90	2,00	BB-1919
mit Schlitz <i>with slot</i>	G91, G93/7 S 7200	254	8,00	2,35	BB-1921
mit Loch <i>with hole</i>	G91, G93/7 S 7200	254	8,00	2,35	BB-1922



BB-1902



BB-1903



BB-1907



BB-1910



BB-1912



BB-1919



BB-1921

Cutter-Messer
Cutter Knives

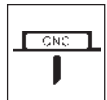

für / for INVESTRONICA - Cutter					
Bemerkungen Remarks	Referenz Reference	Länge in mm Length in mm	Breite in mm Width in mm	Stärke in mm Thickness in mm	Artikelnummer Part No.
	SC 4	187	8,00	1,95	BB-1904
	S 70	245	8,30	3,00	BB-1934
	SC 3	296	7,80	2,52	BB-1906
	SC 3	296	8,00	2,52	BB-1905

für / for KURIS ZAT - Cutter					
Bemerkungen Remarks	Referenz Reference	Länge in mm Length in mm	Breite in mm Width in mm	Stärke in mm Thickness in mm	Artikelnummer Part No.
	24306	178	10,00	2,50	BB-1902

für / for LECTRA - Cutter					
Bemerkungen Remarks	Referenz Reference	Länge in mm Length in mm	Breite in mm Width in mm	Stärke in mm Thickness in mm	Artikelnummer Part No.
	S 97	85	4,00	0,80	BB-1908
	Vector 2500	89	5,50	1,50	BB-1907
mit Hohlschliff <i>with hollow ground</i>	S 95	113	6,00	2,00	BB-1910
Hohlschliff mit schlanker Spitze <i>hollow ground with narrow tip</i>	S 95	113	6,00	2,00	BB-1912
mit gerader Spitze <i>with straight tip</i>	S 95	113	6,00	2,00	BB-1914
mit Hohlschliff <i>with hollow ground</i>	S 95	113	7,50	2,00	BB-1909
Hohlschliff mit schlanker Spitze <i>hollow ground and narrow tip</i>	S 95	113	7,50	2,00	BB-1911
mit gerader Spitze <i>with straight tip</i>	S 95	113	7,50	2,00	BB-1913
im Rücken geschliffen <i>grinded in the back</i>	S 95	296	6,50	2,00	BB-1918
	S 95 Vector 5000	296	7,00	2,00	BB-1916
	S 95	296	7,00	3,00	BB-1915
im Rücken geschliffen <i>grinded in the back</i>	S 95	296	8,50	3,00	BB-1917

für / for WASTEMA - Cutter					
Bemerkungen Remarks	Referenz Reference	Länge in mm Length in mm	Breite in mm Width in mm	Stärke in mm Thickness in mm	Artikelnummer Part No.
		256	8,00	2,00	BB-1903

BB-1915

BB-1922

BB-1934

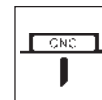
Schleifbänder für Cutter
Abrasive Bands for Cutter

Bemerkungen Remarks	Umfang x Breite in mm Circuit x width in mm	Körnung Grit	Artikelnummer / Part No.		
			Standard	SPIRA-Qualität	
Eastman, KM (> 6"), Kuris Lectra 95, Suprena, Wolf	schwarz / black	220 x 6,0	60	BB-2202	
Eastman, KM (> 6"), Kuris Lectra 95, Suprena, Wolf	rot / red	220 x 6,0	80	BB-2193	BB-2204A
Eastman, KM (> 6"), Kuris Lectra 95, Suprena, Wolf	grün / green	220 x 6,0	100	BB-2203	BB-2205
Eastman, KM (> 6"), Kuris Lectra 95, Suprena, Wolf	blau / blue	220 x 6,0	120	BB-2194	BB-2206
Eastman, KM (> 6"), Kuris Lectra 95, Suprena, Wolf	weiss / white	220 x 6,0	150	BB-2195	
Bullmer Cutter	schwarz / black	220 x 8,0	60	BB-1923	BB-2208A
Bullmer Cutter	rot / red	220 x 8,0	80		BB-2207
Bullmer Cutter	grün / green	220 x 8,0	100	BB-1924	BB-2208
Bullmer Cutter	blau / blue	220 x 8,0	120	BB-1925	
Lectra Vector 2500	grün / green	226 x 12,0	100	BB-1926	
Lectra Vector 2500	blau / blue	226 x 12,0	120	BB-1927	
Lectra Vector 2500	weiss / white	226 x 12,0	150	BB-1928	

lieferbar in zwei Qualitätsstufen:

- Standard für normale bis starke Beanspruchung
- SPIRA-Qualität für starke bis sehr starke Beanspruchung

available in two quality grades:

- standard quality for regular up to heavy duty purpose
- special SPIRA quality for heavy up to very heavy duty purpose

Anwendungsempfehlungen für Schleifbandkörnungen:

Application recommendations for abrasive band grits:

Korn / Grit 60:

schwere Jeansstoffe, Leder, Segeltuch
canvas, heavy denim, leather

Korn / Grit 80:

leichte Jeansstoffe, dicht gewebte Materialien
light denim, tightly woven materials

Korn / Grit 100 - 120:

Baumwollstoffe, leichte Wollstoffe
cottons, light woolens

Korn / Grit 120 - 150:

locker gewebte Materialien, Strickwaren, synthetische Materialien
knits, loosely woven materials, synthetics



BB-2194

Schleifsteine für Cutter
Sharpening Stones for Cutter



Bemerkungen <i>Remarks</i>	Referenz <i>Reference</i>	Durchmesser in mm <i>Diametre in mm</i>	Artikelnummer <i>Part No.</i>
	Gerber G 91	35	BB-1929
	Gerber G 93	25	BB-1930
	Investronica	45	BB-1931
mit Kerbe <i>with notch</i>	Lectra	35	BB-1932



BB-1929



BB-1930

2: ZUSCHNEIDEN *CUTTING*

2.2 MESSER UND SCHLEIFSTEINE FÜR KREISMESSERMASCHINEN *KNIVES AND SHARPENING STONES FOR CIRCULAR KNIFE CUTTING MACHINES*

2.2

Kreismesser für ALLSTAR Circular Knives for ALLSTAR

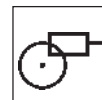

für / for ALLSTAR					
Bemerkungen Remarks	Referenz Reference	Außen-Ø Outer Dia. in mm	Aufnahme-Ø Hole Dia. in mm	Messerstärke Knife Thickness in mm	Artikelnummer Part No.
6-Bogen / 6 curves rund / round	Allstar 100	50,0	12,7	1,0	BB-2136B
	Allstar 100	50,0	12,7	1,0	BB-2136A



BB-2136B

Kreismesser für BULLMER Circular Knives for BULLMER

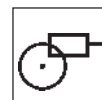

für / for BULLMER					
Bemerkungen Remarks	Referenz Reference	Außen-Ø Outer Dia. in mm	Aufnahme-Ø Hole Dia. in mm	Messerstärke Knife Thickness in mm	Artikelnummer Part No.
10-Bogen / 10 curves	Typ 602	50,0	14,0	1,0	BB-2100
10-Bogen / 10 curves	Typ 604, 801	59,0	10,0	1,0	BB-2101
10-Bogen / 10 curves	Typ 601, 605	79,0	10,0	2,0	BB-2102
10-Bogen / 10 curves	Typ 607	100,0	10,0	2,0	BB-2104
4-Bogen / 4 curves	Typ 607	100,0	10,0	2,0	BB-2105
rund / round	Typ 607	100,0	10,0	1,5	BB-2103
4-Bogen / 4 curves	Typ 970	110,0	10,0	2,0	BB-2106
10-Bogen / 10 curves	Typ 840	126,0	45,0	1,0	BB-2108
rund / round	Typ 840	126,0	45,0	1,0	BB-2109



BB-2102



BB-2108

Kreismesser für CONSEW
Circular Knives for CONSEW

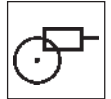

für / for CONSEW					
Bemerkungen Remarks	Referenz Reference	Außen-Ø Outer Dia. in mm	Aufnahme-Ø Hole Dia. in mm	Messerstärke Knife Thickness in mm	Artikelnummer Part No.
4-Bogen / 4 curves	Typ 508	65	25	1,2	BB-2174
rund / round	Typ 505	65	25	1,2	BB-2173



BB-2174

Kreismesser für EASTMAN
Circular Knives for EASTMAN

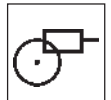

für / for EASTMAN					
Bemerkungen Remarks	Referenz Reference	Außen-Ø Outer Dia. in mm / Inch	Aufnahme-Ø Hole Dia. in mm	Messerstärke Knife Thickness in mm	Artikelnummer Part No.
4-Bogen / 4 curves	Buzzaird (123)	51,6 / 2-1/32	16,0	1,2	BB-2110
6-Bogen / 6 curves	Chickadee (149)	57,1 / 2-1/4	27,0	1,0	BB-2110B
rund / round	Chickadee (147)	57,1 / 2-1/4	27,0	1,0	BB-2110A
rund / round	BBR25, BBB25 (114)	63,5 / 2-1/2	22,2	1,0	BB-2120
rund / round	BBB32, Falcon (84)	82,5 / 3-1/4	39,7	1,0	BB-2111
rund / round	134 (26)	88,9 / 3-1/2		1,0	BB-2112
rund / round	Robin	101,6 / 4	22,2	1,0	BB-2110D
rund / round	534, 548, Falcon (59)	101,6 / 4	39,7	1,0	BB-2113
rund / round	134, 534, 548 (35)	127,0 / 5	50,8	1,0	BB-2114
rund / round	334, 354, 548 (61)	133,4 / 5-1/4	50,8	1,0	BB-2115
rund / round		139,7 / 5-1/2	50,8	1,4	BB-2116
rund / round	Rag Cutter WE6 (39)	152,4 / 6	50,8	1,5	BB-2117
rund / round	355 (75)	177,8 / 7	50,8	1,5	BB-2118
rund / round	562, 567, N-155 (77)	190,5 / 7-1/2	50,8	1,5	BB-2119



BB-2110B

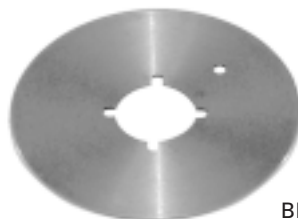

BB-2111



BB-2114

2.2

Kreismesser für HOOGS Circular Knives for HOOGS

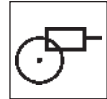

für / for HOOGS					
Bemerkungen Remarks	Referenz Reference	Außen-Ø Outer Dia. in mm	Aufnahme-Ø Hole Dia. in mm	Messerstärke Knife Thickness in mm	Artikelnummer Part No.
10-Bogen / 10 curves	Favorit, Liliput	50,0	25,0	1,2	BB-2124
7-Bogen / 7 curves	Favorit, Liliput	50,0	25,0	1,2	BB-2123
4-Bogen / 4 curves	Favorit, Liliput	50,0	25,0	1,2	BB-2122
rund / round	Favorit, Liliput	50,0	25,0	1,2	BB-2121
10-Bogen / 10 curves	Goliath, IAG, IAK	60,0	25,0	1,2	BB-2127
4-Bogen / 4 curves	Goliath, IAG, IAK	60,0	25,0	1,2	BB-2126
rund / round	Goliath, IAG, IAK	60,0	25,0	1,2	BB-2125
10-Bogen / 10 curves	ST, Z	110,0	25,0	1,2	BB-2130
4-Bogen / 4 curves	ST, Z	110,0	25,0	1,2	BB-2129
rund / round	ST, Z	110,0	25,0	1,2	BB-2128
10-Bogen / 10 curves	X-130, X-130N	130,0	25,0	1,5	BB-2133
4-Bogen / 4 curves	X-130, X-130N	130,0	25,0	1,5	BB-2132
rund / round	X-130, X-130N	130,0	25,0	1,5	BB-2131



BB-2123



BB-2129



BB-2124

Kreismesser für KM RS Circular Knives for KM RS

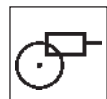

für / for KM					
Bemerkungen Remarks	Referenz Reference	Außen-Ø Outer Dia. in mm	Aufnahme-Ø Hole Dia. in mm	Messerstärke Knife Thickness in mm	Artikelnummer Part No.
7-Bogen / 7 curves	Birdie	50,0	25,0	1,2	BB-2178
8-Bogen / 8 curves	RS 100 - OCTA	100,00	21,0	1,0	BB-2178B
rund / round	RS 100	100,00	21,0	1,0	BB-2178A
rund / round	KRA-5	127,00	43,5	1,2	BB-2178C



BB-2178B

Kreismesser für KURIS
Circular Knives for KURIS

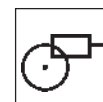

für / for KURIS					
Bemerkungen Remarks	Referenz Reference	Außen-Ø Outer Dia. in mm	Aufnahme-Ø Hole Dia. in mm	Messerstärke Knife Thickness in mm	Artikelnummer Part No.
8-Bogen / 8 curves	Novita	50,0	16,0	1,0	BB-2136
6-Bogen / 6 curves	Novita	50,0	16,0	1,0	BB-2135
rund / round	Novita	50,0	16,0	1,0	BB-2134
6-Bogen / 6 curves	Novita Plus	50,0	12,7	1,0	BB-2136B
rund / round	Novita Plus	50,0	12,7	1,0	BB-2136A
6-Bogen / 6 curves	Super Novita	57,1	27,0	1,0	BB-2136D
rund / round	Super Novita	57,1	27,0	1,0	BB-2136C
6-Bogen / 6 curves	Novita Spezial	60,0	16,0	1,0	BB-2136E
4-Bogen / 4 curves	BOM 60	60,0	22,0	1,0	BB-2139
rund / round	BOM 60	60,0	22,0	1,0	BB-2138
8-Bogen / 8 curves	BOM 30, 80	80,0	22,0	1,0	BB-2142B
6-Bogen / 6 curves	BOM 30, 80	80,0	22,0	1,0	BB-2142
4-Bogen / 4 curves	BOM 30, 80	80,0	22,0	1,0	BB-2141
rund / round	BOM 30, 80	80,0	22,0	1,0	BB-2140
rund / round	CRA	100,0	8,0	1,3	BB-2153
6-Bogen / 6 curves	BOM 100	100,0	22,0	1,0	BB-2142A
4-Bogen / 4 curves	BOM 100	100,0	22,0	1,0	BB-2141A
rund / round	BOM 100	100,0	22,0	1,0	BB-2140A
4-Bogen / 4 curves	KRH10	100,0	35,0	1,2	BB-2146
rund / round	KRH10	100,0	35,0	1,2	BB-2145
rund / round	KRH10-Pioneer (HSS)	100,0	35,0	1,2	BB-1933
4-Bogen / 4 curves	KRH12, KRT120	120,0	35,0	1,2	BB-2148
rund / round	KRH12, KRT120	120,0	35,0	1,2	BB-2147
4-Bogen / 4 curves	KRH15	150,0	35,0	1,5	BB-2150
rund / round	KRH15	150,0	35,0	1,5	BB-2149
4-Bogen / 4 curves	KRH20	200,0	40,0	2,2	BB-2152
rund / round	KRH20	200,0	40,0	2,2	BB-2151



BB-2136B

2.2

Kreismesser für MAIMIN Circular Knives for MAIMIN

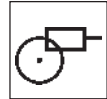

für / for MAIMIN					
Bemerkungen Remarks	Referenz Reference	Außen-Ø Outer Dia. in mm / Inch	Aufnahme-Ø Hole Dia. in mm	Messerstärke Knife Thickness in mm	Artikelnummer Part No.
8-Bogen / 8 curves	Mini Shear	50,0 / 2	16,0	1,0	BB-2160A
6-Bogen / 6 curves	Mini Shear	50,0 / 2	16,0	1,0	BB-2160
rund / round	Mini Shear	50,0 / 2	16,0	1,0	BB-2160B
rund / round	Roto Shear	63,5 / 2-1/2	21,6	1,0	BB-2154
rund / round	ACDC 4	101,6 / 4	40,0	1,0	BB-2155
rund / round	ACDC 5	127,0 / 5	40,0	1,2	BB-2156
rund / round	ACDC 5-1/4	133,4 / 5-1/4	51,8	1,3	BB-2157
rund / round	ACDC 6	152,4 / 6	58,2	1,4	BB-2158
rund / round	ACDC 7	177,8 / 7	58,2	1,4	BB-2159



BB-2158



BB-2160

Kreismesser für RASOR Circular Knives for RASOR

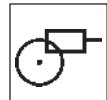

für / for RASOR					
Bemerkungen Remarks	Referenz Reference	Außen-Ø Outer Dia. in mm	Aufnahme-Ø Hole Dia. in mm	Messerstärke Knife Thickness in mm	Artikelnummer Part No.
rund / round	D.86	86,0	22,5	1,0	BRASOR 86



BRASOR 86

Kreismesser für SUPRENA
Circular Knives for SUPRENA

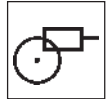

für / for SUPRENA					
Bemerkungen Remarks	Referenz Reference	Außen-Ø Outer Dia. in mm	Aufnahme-Ø Hole Dia. in mm	Messerstärke Knife Thickness in mm	Artikelnummer Part No.
8-Bogen / 8 curves	HC-1005, 1007	50,0	16,0	1,0	BB-2136
6-Bogen / 6 curves	HC-1005, 1007	50,0	16,0	1,0	BB-2135
rund / round	HC-1005, 1007	50,0	16,0	1,0	BB-2134
8-Bogen / 8 curves	CR-1021, 1026	80,0	22,0	1,0	BB-2142B
6-Bogen / 6 curves	CR-1021, 1026	80,0	22,0	1,0	BB-2142
4-Bogen / 4 curves	CR-1021, 1026	80,0	22,0	1,0	BB-2141
rund / round	CR-1021, 1026	80,0	22,0	1,0	BB-2140
6-Bogen / 6 curves	CR-100, 1031, 1032	100,0	22,0	1,0	BB-2142A
4-Bogen / 4 curves	CR-100, 1031, 1032	100,0	22,0	1,0	BB-2141A
rund / round	CR-100, 1031, 1032	100,0	22,0	1,0	BB-2140A

Kreismesser für WOLF
Circular Knives for WOLF

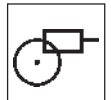

für / for WOLF					
Bemerkungen Remarks	Referenz Reference	Außen-Ø Outer Dia. in mm / in Inch	Aufnahme-Ø Hole Dia. in mm	Messerstärke Knife Thickness in mm	Artikelnummer Part No.
4-Bogen / 4 curves	Pup (R1426371)	52,5 / 2-1/16	17,5	1,0	BB-2171
rund / round	Clipper (23)	101,6 / 4	31,7	1,0	BB-2162
rund / round	Clipper (22)	120,7 / 4-3/4	42,6	1,0	BB-2163
rund / round	Blazer (21)	133,4 / 5-1/4	42,6	1,0	BB-2164
rund / round	Slim Jim (24)	133,4 / 5-1/4	50,8	1,0	BB-2165
rund / round	Blazer, ZA6 (16)	152,4 / 6	40,0	1,0	BB-2166
rund / round	Blazer-O (18)	152,4 / 6	50,8	1,2	BB-2167
rund / round	Blazer (19)	177,8 / 7	50,8	1,5	BB-2168
rund / round	Blazer-O	203,0 / 8	50,8	1,4	BB-2169
rund / round	Big-O	254,0 / 10	50,8	1,7	BB-2170

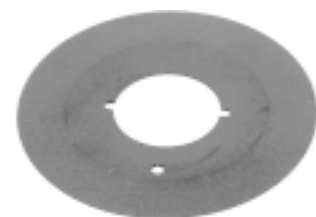

BB-2163

2.2

Gegenmesser für Kreismessermaschinen Counter Blade for Circular Knife Cutting Machines

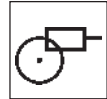

Maschinentyp Machine Class	Referenz Reference	Ausführung Execution	Artikelnummer Part No.
Kuris BOM 101	22219	HM/ CT	B22219
Kuris Novita, Suprena HC-1005, HC-1007	25208	HM/ CT	B25208
Kuris Novita, Suprena HC-1005, HC-1007	30785	HM/ CT	B30785
Kuris BOM 30, 60, 80, 100, KRH 10, KRS 550, KSM 200	31391	HM/ CT	B31391
Kuris BOM 30, 60, 80, 100, KRH 10, KRS 550, KSM 200	02257	HSS	BB-2175/5
Hoogs ST, Z, X-130	UM-5	HM/ CT	BB-2177/5



BB-2177/5



B25208



B30785



BB-2175/5



B31391

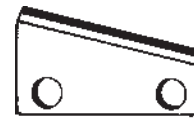

B22219

Schleifsteine für Kreismessermaschinen Sharpening Stone for Circular Knife Cutting Machines



Bemerkungen Remarks	Referenz Reference	Artikelnummer Part No.
für / for EASTMAN		
Typ 344, 354, 355, 356, 548 (5-1/4"), WE6 (Rag Cutter)	133C1-12	BB-2210
WE6 (Rag Cutter), kompl. mit Welle / compl. with spindle (shaft)	541C1-9	BB-2210A
Typ 323, 534, 548 (4"), Falcon IV, Robin-Track	541C1-10	B541C1-10
Typ Chickadee	541C1-22	B541C1-22
für / for KURIS		
Typ BOM 101	24062	BB-2221A
Typ BOM 30, 80, 100	32041	BB-2221
Typ KRH, KRS, KSM	32051	BB-2222
Typ Novita	32070	BB-2223
Typ Champion (CRA)	90159	BB-2224
für / for SUPRENA		
Typ HC-1005, HC-1007	M688	BM688Z
für / for WOLF		
Typ ZA6 (Rag Cutter)	45483	BB-2211

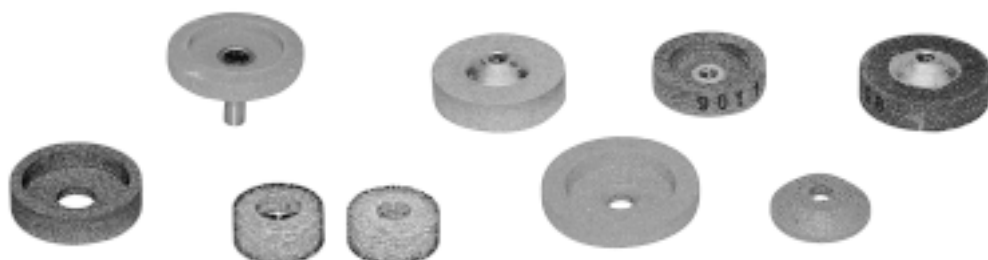

2: ZUSCHNEIDEN *CUTTING*

2.3 MESSER UND SCHLEIFMITTEL FÜR STOSSMESSERMASCHINEN *KNIVES AND SHARPENING STONES FOR STRAIGHT KNIFE CUTTING MACHINES*

2.3

Hergestellt in HSS-Qualität aus erstklassigem Schwedenstahl. Verschiedene Typen sind außerdem aus amerikanischer Produktion lieferbar. Der amerikanische Stahl hat eine noch höhere Standzeit und eignet sich für den Zuschnitt besonders harter Materialien.

Manufactured of first-class Swedish steel in HSS quality. Several types are also available from US production. American steel offers an even higher durability and is recommended for cutting of especially hard materials.

Die Lieferung der Messer erfolgt mit glatter Schneide, die sich für den Zuschnitt der meisten Materialien eignet. Bei Bedarf sind, gegen Aufpreis, auch folgende Ausführungen lieferbar:

- a) mit gewellter Schneide für den Zuschnitt weicher Kunst- und Schaumstoffe
- b) mit PTFE-Beschichtung für den Zuschnitt von hitzeempfindlichen Synthetikmaterialien

Straight knives are supplied with smooth edge which is suitable for almost any kind of material.

The following versions are also available on request:

- a) with waved cutting edge for soft synthetic and rubber foam materials*
- b) with PTFE-coating for heat-sensitive synthetic materials*

Stoßmesser für COMET *Straight Knives for COMET*

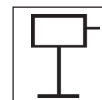

Länge in Zoll <i>Length in Inch</i>	Artikelnummer / <i>Part No.</i>	
	Standard	USA
5	BB-2035	
6	BB-2036	BB-2036o
7	BB-2037	
8	BB-2038	
9	BB-2039	
10	BB-2040	BB-2040o



Stoßmesser für EASTMAN, HITAKA, KM (>6"), LIGHTNING, SUPRENA *Straight Knives for EASTMAN, HITAKA, KM (>6"), LIGHTNING, SUPRENA*

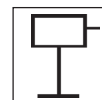

Länge in Zoll <i>Length in Inch</i>	Artikelnummer / <i>Part No.</i>		
	Standard	USA	Welle / <i>wave</i>
5	BB-2041	BB-2041o	BB-2041W
6	BB-2042	BB-2042o	BB-2042W
7	BB-2043	BB-2043o	BB-2043W
8	BB-2044	BB-2044o	BB-2044W
9	BB-2045		
10	BB-2046	BB-2046o	BB-2046W
11-1/2	BB-2047	BB-2047o	BB-2047W
13	BB-2048		



Stoßmesser für EASTMAN Servo-Cutter
Straight Knives for EASTMAN Servo Cutter



Länge in Zoll <i>Length in Inch</i>	Artikelnummer / Part No.	
	Breite / Width 18,0 mm	Breite / Width 14,5 mm
6	BB-2049A	
7	BB-2049	
8	BB-2049B	BB-2049E
9	BB-2049C	
10	BB-2049D	BB-2049F
11-1/2		BB-2049G

Stoßmesser für KM
Straight Knives for KM



Länge in Zoll <i>Length in Inch</i>	Artikelnummer / Part No.	
	Standard	USA
4	BB-2054	
5	BB-2055	BB-2055o
6	BB-2056	
7	BB-2057	
8	BB-2058	
10	BB-2059	



Stoßmesser für KURIS
Straight Knives for KURIS

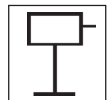

Maschinentyp <i>Machine Model</i>	Artikelnummer <i>Part No.</i>
Kuris KV 70	BB-2060
Kuris KV 90	BB-2061
Kuris KV 115	BB-2062
Kuris KV 140	BB-2063
Kuris KV 20	BB-2064
Kuris KV 200	BB-2065
Kuris KVS 70	BB-2067
Kuris KVS 900	BB-2068
Kuris KV 4 - 1100	BB-2069
Kuris KV 4 - 1350	BB-2070
Kuris KV 4 - 1600	BB-2071
Kuris KV 4 - 2000	BB-2072
Kuris KV 1605 E	BB-2071A
Kuris KV 2005 E	BB-2071B



2.3

Stoßmesser für KURIS Servo-Cutter *Straight Knives for KURIS Servo Cutter*

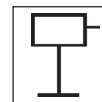

Maschinentyp <i>Machine Model</i>	Artikelnummer <i>Part No.</i>
Kuris SC 700	BB-2073
Kuris SC 900	BB-2074
Kuris SC 1350	BB-2076
Kuris SC 1600	BB-2077
Kuris SC 2000	BB-2078
Kuris SC 1350 J2	BB-2079
Kuris SC 1600 J2	BB-2079A



Stoßmesser für MAIMIN *Straight Knives for MAIMIN*

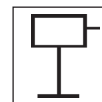

Länge in Zoll <i>Length in Inch</i>	Artikelnummer <i>Part No.</i>
4	BB-2083
5	BB-2084
6	BB-2085
7	BB-2086
8	BB-2087
9	BB-2088
10	BB-2088A
11-1/2	BB-2089



Stoßmesser für WOLF *Straight Knives for WOLF*

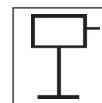

Länge in Zoll <i>Length in Inch</i>	Artikelnummer / <i>Part No.</i>	
	Standard	USA
5	BB-2091	BB-2091o
6	BB-2092	BB-2092o
7	BB-2093	BB-2093o
8	BB-2094	BB-2094o
10	BB-2095	BB-2095o
14	BB-2096	



Schleifbänder für Stoßmessermaschinen
Abrasive Bands for Straight Knife Cutting Machines

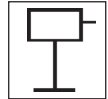

Bemerkungen <i>Remarks</i>	Umfang x Breite in mm <i>Circuit x width in mm</i>	Körnung <i>Grit</i>	Artikelnummer / <i>Part No.</i>		
			Standard	SPIRA-Qualität	
KM 4" + 5"	rot / <i>red</i>	175 x 5,5	80	BB-2196	
KM 4" + 5"	grün / <i>green</i>	175 x 5,5	100	BB-2197	BB-2209
KM 4" + 5"	blau / <i>blue</i>	175 x 5,5	120	BB-2198	
Maimin	rot / <i>red</i>	175 x 7,5	80	BB-2199	
Maimin	grün / <i>green</i>	175 x 7,5	120	BB-2200	
Maimin	blau / <i>blue</i>	175 x 7,5	150	BB-2201	
Eastman, KM (> 6"), Kuris Lectra 95, Suprena, Wolf	schwarz / <i>black</i>	220 x 6,0	60	BB-2202	
Eastman, KM (> 6"), Kuris Lectra 95, Suprena, Wolf	rot / <i>red</i>	220 x 6,0	80	BB-2193	BB-2204A
Eastman, KM (> 6"), Kuris Lectra 95, Suprena, Wolf	grün / <i>green</i>	220 x 6,0	100	BB-2203	BB-2205
Eastman, KM (> 6"), Kuris Lectra 95, Suprena, Wolf	blau / <i>blue</i>	220 x 6,0	120	BB-2194	BB-2206
Eastman, KM (> 6"), Kuris Lectra 95, Suprena, Wolf	weiss / <i>white</i>	220 x 6,0	150	BB-2195	
Comet	rot / <i>red</i>	225 x 8,0	80	BB-2190	
Comet	grün / <i>green</i>	225 x 8,0	100	BB-2191	
Comet	blau / <i>blue</i>	225 x 8,0	120	BB-2192	

lieferbar in zwei Qualitätsstufen:

- Standard für normale bis starke Beanspruchung
 - SPIRA-Qualität für starke bis sehr starke Beanspruchung
- available in two quality grades:*
- *standard quality for regular up to heavy duty purpose*
 - *special SPIRA quality for heavy up to very heavy duty purpose*

Anwendungsempfehlungen für Schleifbandkörnungen:
Application recommendations for abrasive band grits:

Korn / *Grit* 60:

schwere Jeansstoffe, Leder, Segeltuch
canvas, heavy denim, leather

Korn / *Grit* 80:

leichte Jeansstoffe, dicht gewebte Materialien
light denim, tightly woven materials

Korn / *Grit* 100 - 120:

Baumwollstoffe, leichte Wollstoffe
cottons, light woolens

Korn / *Grit* 120 - 150:

locker gewebte Materialien, Strickwaren, synthetische Materialien
knits, loosely woven materials, synthetics



BB-2194

2.3

MESSER UND SCHLEIFMITTEL FÜR STOSSMESSERMASCHINEN KNIVES AND SHARPENING STONES FOR STRAIGHT KNIFE CUTTING MACHINES

Schleifsteine für Stoßmessermaschinen Sharpening Stones for Straight Knife Cutting Machines

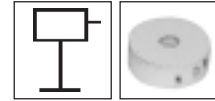

Ausführung Version	Referenz Reference	Artikelnummer Part No.
für / for KURIS		
KV (groß / large)	14806	BB-2225
KV (klein / small)	24190	BB-2219
KVS 700	24200	BB-2220
KVS 900	24248	BB-2225A
KVS 90	24716	BB-2225B
für / for WOLF Pacer		
Korn / Grit 80	12800	BB-2212
Korn / Grit 120	12801	BB-2213



2: ZUSCHNEIDEN *CUTTING*

2.4 MESSER UND SCHLEIFSTEINE FÜR BANDMESSERMASCHINEN *KNIVES AND SHARPENING STONES FOR BAND KNIFE CUTTING MACHINES*

Bandmesser mit doppelter Wate Band Knives with double bevel



Länge in mm Length in mm	glatt smooth	gewellt convex	gezahnt concave
2830	BB-1570	BB-1570W	BB-1570K
2840	BB-1570A	BB-1570AW	BB-1570AK
2850	BB-2000	BB-2000W	BB-2000K
2870	BB-1589	BB-1589W	BB-1589K
2880	BB-2001	BB-2001W	BB-2001K
2910	BB-1587	BB-1587W	BB-1587K
3100	BB-1571	BB-1571W	BB-1571K
3120	BB-1572	BB-1572W	BB-1572K
3150	BB-2014	BB-2014W	BB-2014K
3200	BB-1573	BB-1573W	BB-1573K
3300	BB-2002	BB-2002W	BB-2002K
3370	BB-2002B	BB-2002BW	BB-2002BK
3460	BB-1574	BB-1574W	BB-1574K
3480	BB-2003	BB-2003W	BB-2003K
3550	BB-2015	BB-2015W	BB-2015K
3600	BB-1575	BB-1575W	BB-1575K
3670	BB-2010	BB-2010W	BB-2010K
3675	BB-1576	BB-1576W	BB-1576K
3760	BB-1577	BB-1577W	BB-1577K
3970	BB-1578	BB-1578W	BB-1578K
4000	BB-1579	BB-1579W	BB-1579K
4050	BB-2004	BB-2004W	BB-2004K
4090	BB-1579B	BB-1579BW	BB-1579BK
4100	BB-1590	BB-1590W	BB-1590K
4120	BB-2021	BB-2021W	BB-2021K
4200	BB-1580	BB-1580W	BB-1580K
4225	BB-1591	BB-1591W	BB-1591K
4250	BB-1593	BB-1593W	BB-1593K
4255	BB-2005	BB-2005W	BB-2005K
4500	BB-1581	BB-1581W	BB-1581K
4550	BB-2022	BB-2022W	BB-2022K
4560	BB-2023	BB-2023W	BB-2023K
4600	BB-2011	BB-2011W	BB-2011K
4620	BB-2028	BB-2028W	BB-2028K
4650	BB-1582	BB-1582W	BB-1582K
4700	BB-1583	BB-1583W	BB-1583K
4720	BB-2012	BB-2012W	BB-2012K
4800	BB-1584	BB-1584W	BB-1584K
4920	BB-2024	BB-2024W	BB-2024K
5000	BB-2025	BB-2025W	BB-2025K
5200	BB-1585	BB-1585W	BB-1585K
5225	BB-1586	BB-1586W	BB-1586K
5270	BB-2027	BB-2027W	BB-2027K
5280	BB-2006	BB-2006W	BB-2006K
5300	BB-2026	BB-2026W	BB-2026K
5310	BB-1588	BB-1588W	BB-1588K
5500	BB-2013	BB-2013W	BB-2013K

Hergestellt aus erstklassiger Stahlqualität, lieferbar in sämtlichen gewünschten Längen und für alle Bandmesser-Zuschneidemaschinen, wie z. B. Bullmer, CKS, FK, Hitaka, Hoogs, Kuris, NCA, Takaoka, Wastema, etc.

Als Standardausführung werden die Bandmesser in der Breite 10 mm und der Stärke 0,45 mm mit doppelt angeschliffener Wate geliefert (andere Breiten und Schliffarten auf Anfrage möglich).

Manufactured of first-class steel material, available in all required lengths and for all band knife cutting machines like Bullmer, CKS, FK, Hitaka, Hoogs, Kuris, NCA, Takaoka, Wastema, etc.

The band knives are supplied in 10 mm width and 0,45 mm thickness with double bevel cutting edge as standard version (other sizes and grinding versions available on request).

Anwendungsempfehlungen für Schneidenformen:
Application recommendations for cutting edge forms:

glatt / smooth
für die meisten Textilien geeignet
suitable for most textiles

gewellt / convex
zum Schneiden weicher Kunst- und Schaumstoffe, Wellpappe und Toilettenpapier
for cutting of soft plastic and rubber foam, corrugated paper and toilet paper

gezahnt / concave
geeignet für harte Textilien auf synthetischer Basis
suitable for synthetics-based harder textiles

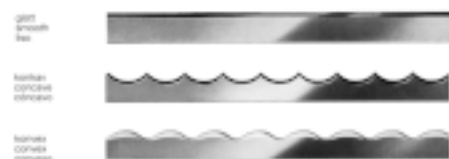

Schleifsteine 65 x 12 mm für Bandmesser-Zuschneidemaschinen
Sharpening Stones 65 x 12 mm for Band Knife Cutting Machines



für / for Kuris, Wastema, etc.		
Körnung Grit	Referenz Reference	Artikelnummer Part No.
80	24132	BB-2218
100	24133	BB-2218A
150	24134	BB-2218B

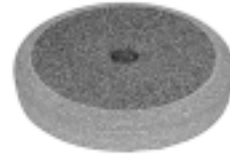

2: ZUSCHNEIDEN *CUTTING*

2.5 ERSATZTEILE FÜR ZUSCHNEIDEMASCHINEN *SPARE PARTS FOR CUTTING MACHINES*

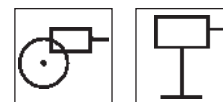
Zuschneidemaschinen-Ersatzteile
Cutting Machine Spare Parts

Bemerkungen Remarks	Artikelnummer Part No.
für Kreismessermaschinen / for Circular Cutting Machines	
Messerschlüssel, verstellbar, für Eastman, KM, Kuris, Wolf, etc. <i>Wrench, adjustable, for Eastman, KM, Kuris, Suprena, Wolf, etc.</i>	BAWS
Welle für Schleifapparat zur Eastman WE6 (Rag Cutter) <i>Sharpener Shaft for Eastman WE6 (Rag Cutter)</i>	B11C10-10
Unterlegscheibe für Schleifstein zur Eastman WE6 (Rag Cutter) <i>Washer for sharpening stone for Eastman WE6 (Rag Cutter)</i>	B12C1-28
Keilriemen für Eastman WE6 (Rag Cutter) <i>Endless V-Belt for Eastman WE6 (Rag Cutter)</i>	B181C1
Schraube für Schleifapparatfeder Eastman WE6 (Rag Cutter) <i>Screw for sharpener spring Eastman WE6 (Rag Cutter)</i>	B20C12-13
Schleifstein-Befestigungsschraube Eastman WE6 (Rag Cutter) <i>Screw for sharpening stone Eastman WE6 (Rag Cutter)</i>	B20C13-20
Schleifsteinwellenbuchse Eastman WE6 (Rag Cutter) <i>Grinder bushing (journal) Eastman WE6 (Rag Cutter)</i>	B20C6-11
Schraube für Schleifsteinwelle Eastman WE6 (Rag Cutter) <i>Screw for sharpening stone shaft Eastman WE6 (Rag Cutter)</i>	B304C10-3
Schraube für Schleifapparatwelle Eastman WE6 (Rag Cutter) <i>Screw for sharpener assy. Shaft Eastman WE6 (Rag Cutter)</i>	B309C12-1
Feder für Schleifapparat (alte Version) Eastman WE6 (Rag Cut.) <i>Sharpener Spring (old version) Eastman WE6 (Rag Cutter)</i>	B34C1-20
Feder für Schleifapparat (neue Version) Eastman WE6 <i>Sharpener Spring (new version) Eastman WE6 (Rag Cutter)</i>	B34C1-60
Schleifsteinwelle Eastman WE6 (Rag Cutter) <i>Sharpening Stone Spindle Shaft Eastman WE6 (Rag Cutter)</i>	B541C1-9A
für Stoßmessermaschinen / for Straight Knife Cutting Machines	
Messerschlüssel Eastman, KM, Lightning, Suprena, etc. <i>Knife Wrench for Eastman, KM, Lightning, Suprena, etc.</i>	B529C1-8
Friktionsring für Schleifbänder Eastman, KM, Lightning, Wolf, etc. <i>Neoprene Ring for abrasive belts Eastman, Lightning, Wolf, etc.</i>	BD-4071

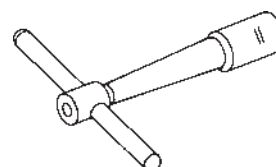

Auszackmaschinenzubehör
Pinking equipment

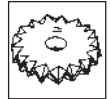

Auszackmesser
Pinking Knives

Referenz <i>Reference</i>	Zacken pro Zoll <i>Pinks per Inch</i>	Artikelnummer <i>Part No.</i>
für / for CHANDLER		
No. 7	4	BB-2400A
No. 7A	5	BB-2400
für / for KURIS ZMA 34		
02054	3	BZMA-15
02056	4	BZMA-18
für / for MAN SEW		
515	5	BD-4060

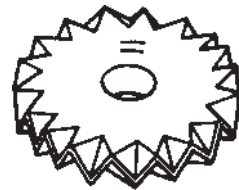

BB-2400



BD-4060

Ersatzteile für Auszackmaschinen
Spare Parts for Pinking Machines

Bemerkungen <i>Remarks</i>	Referenz <i>Reference</i>	Artikelnummer <i>Part No.</i>
für / for CHANDLER		
Gegendruckrolle, komplett <i>Anvil with pin and bearings</i>	DLP9C	BB-2401
für / for MAN SEW		
Druckfeder <i>Puller Spring</i>	526	BD-4060A

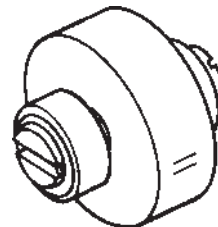

BB-2401



BD-4060A

2: ZUSCHNEIDEN *CUTTING*

2.6 STOFFKLAMMERN UND SONSTIGE HILFSMITTEL *CLOTH CLAMPS AND OTHER AIDS*

Stoffklammer
Cloth clamp

Bemerkungen <i>Remarks</i>	Spannweite in mm <i>Span in mm</i>	Breite in mm <i>Width in mm</i>	Artikelnummer <i>Part No.</i>
Standmodelle / Table standing models			
mit Wippe, besonders für empfindliche Stoffe <i>with hinged jaw, especially for delicate fabric</i>	120	60	BB-2227s
mit Wippe, besonders für empfindliche Stoffe <i>with hinged jaw, especially for delicate fabric</i>	240	120	BB-2234
Modelle zur Tischmontage / Table mounted models			
Montageklammer, vernickelt <i>Table mounting clamp, nickel plated</i>	30	120	BB-2234B
Schmetterlingsklammer <i>Sample cloth clamp</i>	60	100	BB-2229
Schmetterlingsklammer <i>Sample cloth clamp</i>	100	100	BB-2230
Handmodelle / Hand-held models			
mit Schenkelfeder, schwarz lackiert <i>with coil spring, black varnished</i>	30	120	BB-2234A
mit Schenkelfeder, schwarz lackiert <i>with coil spring, black varnished</i>	35	25	BB-2226A
mit Spiraldruckfeder, unlackiert <i>with helical spring, non-varnished</i>	60	50	BB-2231
mit Schenkelfeder, unlackiert <i>with coil spring, non-varnished</i>	60	50	BB-2232
mit Schenkelfeder, schwarz lackiert <i>with coil spring, black varnished</i>	60	50	BB-2232C
mit Schenkelfeder, schwarz lackiert <i>with coil spring, black varnished</i>	90	60	BB-2232B
mit Schenkelfeder, schwarz lackiert <i>with coil spring, black varnished</i>	120	65	BB-2232A
mit Wippe, besonders für empfindliche Stoffe <i>with hinged jaw, especially for delicate fabric</i>	75	120	BB-2233

Stoffklammer
Cloth clamp



BB-2227s



BB-2226A



BB-2234A



BB-2232B



BB-2231



BB-2233



BB-2232A

Zuschnitthilfsmittel Cutting Aids

Schablonenbeschwerer
Cloth Weight

Gewicht in kg Weight in kg	Artikelnummer Part No.
1,2	BB-2320



Schablonenhaken
Pattern Hanger Cords

Kordellänge in mm Cord length in mm	Artikelnummer Part No.
200	BB-2321

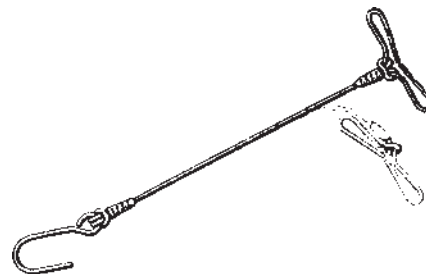

Metallmaschenhandschuh, 5 Finger Metal Safety Gloves, 5 Finger

Kennfarbe Colour mark	Größe Size	Artikelnummer Part No.
grün / green	0 = ca. 6 - 7	BB-2391
weiss / white	1 = ca. 7 - 8	BB-2393
rot / red	2 = ca. 8 - 9	BB-2394
blau / blue	3 = ca. 9 -10	BB-2395
orange / orange	4 = ca. 10 - 11	BB-2396



BB-2391

Gegen Schnittverletzungen beim Arbeiten mit Band- und Stoßmessermaschinen, wendbar für linke und rechte Hand.

To prevent injuries while working with band or straight knife cutting machines, reversible for left and right hand.

2: ZUSCHNEIDEN *CUTTING*

2.7 SCHEREN UND TRENNMESSER *SCISSORS, SHEARS AND KNIVES*

2.7

SCHEREN UND TRENNMESSER SCISSORS, SHEARS AND KNIVES

Handarbeitsscheren Dressmaker Scissors



Ganzmetall-Handarbeitsscheren, vernickelt
Full-metal dressmaker scissors, nickel plated

Länge in " Length in "	Länge in mm Length in mm	Artikel Nr. Part No.
KRETZER Spirale		
6.1/2	165	B12517
7	180	B12518
8	200	B12520
5	130	B12713
6	150	B12715
7	180	B12718
5	130	B13013
6	150	B13015
7	180	B13318



B12517 - B12520



B12713 - B12718



B13318



B13013 + B13015

Länge in " Length in "	Länge in mm Length in mm	Artikel Nr. Part No.
MUNDIAL		
5	130	B437-5
6	150	B437-6
7	180	B437-7
8	200	B437-8
6	150	B445-6
7	180	B445-7
8	200	B445-8



B437-5 - B437-8



B445-6 - B445-8

Handarbeitsscheren
Dressmaker Scissors



Handarbeitsscheren mit Kunststoffgriff
Dressmaker scissors, nickel plated

Länge in " Length in "	Länge in mm Length in mm	Artikel Nr. Part No.
KRETZER Finny		
5	130	B72013
6	150	B72015
8	200	B72020
10	250	B72025



B72013



B72015



B72025



B72020

Länge in " Length in "	Länge in mm Length in mm	Artikel Nr. Part No.
MUNDIAL Typ 600		
5.1/2	140	B664-5.1/2
7.1/2	190	B662-7.1/2
8.1/2	216	B660-8.1/2



B664-5.1/2



B662-7.1/2



B660-8.1/2

Handarbeitsscheren
Dressmaker Scissors



Handarbeitsscheren mit Kunststoffgriff
Dressmaker scissors, with plastic handle

Länge in " Length in "	Länge in mm Length in mm	Artikel Nr. Part No.
MUNDIAL Typ 600 SR		
7.1/2	190	B662SR-7.1/2
8.1/2	216	B660SR-8.1/2

eine Schneide mit Feinzahnung
one blade serrated



B662SR-7.1/2



B660SR-8.1/2

Länge in " Length in "	Länge in mm Length in mm	Artikel Nr. Part No.
MUNDIAL Softy Cut		
8.1/2	216	B1860-8.1/2
5.1/2	140	B1864-5.1/2
7	178	B1863-7

eine Schneide mit Feinzahnung
one blade serrated



B1860-8.1/2



B1864-5.1/2



B1863-7

Länge in " Length in "	Länge in mm Length in mm	Artikel Nr. Part No.
PRYM KaiCut		
5	135	B611510
6.1/2	165	B611511



B611510



B611511

Stickscheren
Embroidery Scissors



Ganzmetall-Stickscheren
Full-metal embroidery scissors

Länge in " Length in "	Länge in mm Length in mm	Artikel Nr. Part No.
KRETZER Spirale		
3.1/2	90	B15409
4	100	B18410



B15409



B18410

Länge in " Length in "	Länge in mm Length in mm	Artikel Nr. Part No.
MUNDIAL		
3.1/2	90	B426-3.1/2
4	100	B426-4
4	100	B427-4*
3.1/2	90	B702-3.1/2

*gebogene Blätter
curved blades



B426-3.1/2
B426-4
B427-4
B702-3.1/2

Stickscheren mit Kunststoffgriff
Embroidery scissors with plastic handle

Länge in " Length in "	Länge in mm Length in mm	Artikel Nr. Part No.
KRETZER Finny		
3.1/2	90	B70709
5	130	B70213



B70709



B70213

Länge in " Length in "	Länge in mm Length in mm	Artikel Nr. Part No.
Mundial Typ 600		
4.1/2	108	B668-4.1/4



B668-4.1/4

2.7

SCHEREN UND TRENNMESSER SCISSORS, SHEARS AND KNIVES

Stickscheren *Embroidery Scissors*



Stickscheren mit Kunststoffgriff
Embroidery scissors with plastic handle

Länge in " Length in "	Länge in mm Length in mm	Artikel Nr. Part No.
PRYM KaiCut		
4	100	B611514
4	100	B611516



B611514



B611516

Taschenscheren *Pocket scissors*

Länge in " Length in "	Länge in mm Length in mm	Artikel Nr. Part No.
Mundial		
4.1/8	105	B430-4-1/8
4.5/8	115	B430-4-5/8



B430-4-1/8
B430-4-5/8

KRETZER Finny		
5	130	B72413



B72413

Einringscheren *Thread Nippers*

Ganzmetall-Einringscheren *Full-metal thread nippers*

Länge in " Length in "	Länge in mm Length in mm	Artikel Nr. Part No.
KRETZER Spirale		
4.1/2	115	B33611
4.1/2	115	B33711*

* gebogene Blätter
* curved blades



B33611
B33711

Einringscheren
Thread Nippers

Ganzmetall-Einringscheren
Full-metal thread nippers

Länge in " Length in "	Länge in mm Length in mm	Artikel Nr. Part No.
MUNDIAL		
4.1/2	115	B801-4.1/2
4.1/2	115	B811-4.1/2*

* gebogene Blätter
* curved blades



B801-4.1/2



B811-4.1/2

Einringscheren mit Kunststoffgriff
Thread nippers with plastic handle

Länge in " Length in "	Länge in mm Length in mm	Artikel Nr. Part No.
KRETZER Finny		
4.1/2	115	B34711
4.1/2	115	B34811*

* gebogene Blätter
* curved blades



B34711
B34811



B601-4.5/8

MUNDIAL Typ 600		
4.5/8	115	B601-4.5/8
Ersatzklingen zu B601-4.5/8 Spareblades for B601-4.5/8		BB-2271b

Schneiderscheren
Dressmaker Shears

Schneiderscheren, vernickelt
Dressmaker shears, nickel plated

Länge in " Length in "	Länge in mm Length in mm	Artikel Nr. Part No.
KRETZER Spirale		
7	180	B43918
8	203	B43920



B43918 + B43920

MUNDIAL		
7	180	B460-7
8	203	B460-8
9	229	B460-9



B460-7 - B460-9



Schneiderscheren
Dressmaker Shears



Schneiderscheren mit unvernickelten Blättern und lackiertem Griff
Dressmaker shears with blue polished blades and varnished handle

Länge in " Length in "	Länge in mm Length in mm	Artikel Nr. Part No.
KRETZER Spirale		
7	180	B44518
8	203	B44520
9	229	B44523
10	254	B44525
11	280	B44528
12	305	B44530



B44518 – B44530

MUNDIAL		
8	203	B490-8
9	229	B490-9
10	254	B490-10
12	305	B490-12



B490-8 – B490-12

Schneiderscheren mit vernickelten Blättern und lackiertem Griff
Dressmaker shears with nickled blades and varnished handle

Länge in " Length in "	Länge in mm Length in mm	Artikel Nr. Part No.
KRETZER Spirale		
7	180	B44618
8	203	B44620
9	229	B44623
10	254	B44625
11	280	B44628
12	305	B44630



B44618 – B44630

MUNDIAL		
8	203	B314NP-8N
8	203	B490-8NP
9	229	B490-9NP
10	254	B490-10NP
12	305	B490-12NP



B314NP-8N



B490-8NP – B490-12NP

Schneiderscheren
Dressmaker Shears



Schneiderscheren mit vernickelten Blättern und lackiertem Griff (eine Schneide feinverzahnt)
Dressmaker shears with nickled blades and varnished handle (one blade serrated)

Länge in " Length in "	Länge in mm Length in mm	Artikel Nr. Part No.
MUNDIAL		
7	178	B270SR-7
8	203	B270SR-8
8	203	B490-8NP/NS
9	229	B490-9NP/NS
10	254	B490-10NP/NS
12	305	B490-12NP/NS



B270SR-7 + B270SR-8



B490-8NP/NS
B490-9NP/NS
B490-10NP/NS
B490-12NP/NS

Schneiderscheren mit Kunststoffgriff
Dressmaker shears with plastic handle

Länge in " Length in "	Länge in mm Length in mm	Artikel Nr. Part No.
KRETZER Finny		
9.1/2	240	B73224
10	254	B73225



B73225



B73224

Länge in " Length in "	Länge in mm Length in mm	Artikel Nr. Part No.
MUNDIAL Typ 600		
9.1/2	240	B690-9.1/2



B690-9.1/2

Schneiderscheren
Dressmaker Shears

Schneiderscheren mit Kunststoffgriff
Dressmaker shears with plastic handle

Länge in " <i>Length in "</i>	Länge in mm <i>Length in mm</i>	Artikel Nr. <i>Part No.</i>
PRYM KaiCut		
8	210	B611512
9	230	B611517



B611512



B611517

Länge in " <i>Length in "</i>	Länge in mm <i>Length in mm</i>	Artikel Nr. <i>Part No.</i>
MUNDIAL Typ 600 SR		
9.1/2	240	B690SR-9.1/2

feinverzahnt
serrated



B690SR-9.1/2

Länge in " <i>Length in "</i>	Länge in mm <i>Length in mm</i>	Artikel Nr. <i>Part No.</i>
MUNDIAL SoftyCut		
9.1/2	240	B1890-9.1/2

feinverzahnt
serrated



B1890-9.1/2

Linkshänderscheren
Lefthand Scissors

Ganzmetall-Linkshänderscheren
Full-metal lefthand scissors

Länge in " <i>Length in "</i>	Länge in mm <i>Length in mm</i>	Artikel Nr. <i>Part No.</i>
KRETZER Spirale		
7	180	B12618
8	200	B44920
10	250	B44925



B12618



B44920 + B44925

Länge in " <i>Length in "</i>	Länge in mm <i>Length in mm</i>	Artikel Nr. <i>Part No.</i>
MUNDIAL		
8	200	B271SR-8
10	254	B493NP-10NL



B271SR-8



B493NP-10NL

Linkshänderscheren mit Kunststoffgriff
Lefthand scissors with plastic handle

Länge in " <i>Length in "</i>	Länge in mm <i>Length in mm</i>	Artikel Nr. <i>Part No.</i>
MUNDIAL Typ 600		
8.1/2	216	B661-8.1/2



B661-8.1/2

Länge in " <i>Length in "</i>	Länge in mm <i>Length in mm</i>	Artikel Nr. <i>Part No.</i>
PRYM KaiCut		
8	210	B611513



B611513

2.7

SCHEREN UND TRENNMESSER SCISSORS, SHEARS AND KNIVES

Zackenscheren Pinking Shears



Ganzmetall-Zackenscheren mit lackiertem Griff
Full-metal pinking shears with varnished handle

Länge in " Length in "	Länge in mm Length in mm	Artikel Nr. Part No.
KRETZER Kreso		
7.1/2	190	B94719



B94719

Länge in " Length in "	Länge in mm Length in mm	Artikel Nr. Part No.
MUNDIAL		
7.1/2	190	B262-7.1/2
9	229	B262-9
10.1/2	270	B262-10.1/2
7.1/2	190	B562-7.1/2



B262-7.1/2 – B262-10.1/2



B562-7.1/2
brünierte Blätter / burnished blades

Zackenscheren mit Kunststoffgriff
Pinking shears with plastic handle

Länge in " Length in "	Länge in mm Length in mm	Artikel Nr. Part No.
KRETZER Finny		
8	200	B97620



B97620

Länge in " Length in "	Länge in mm Length in mm	Artikel Nr. Part No.
MUNDIAL Typ 600		
8.1/2	216	B665-8.1/2



B665-8.1/2

Zackenscheren
Pinking Shears



Zackenscheren mit Kunststoffgriff
Pinking shears with plastic handle

Länge in " <i>Length in "</i>	Länge in mm <i>Length in mm</i>	Artikel Nr. <i>Part No.</i>
MUNDIAL SoftyCut		
8.1/2	216	B1865-8.1/2



B1865-8.1/2

Länge in " <i>Length in "</i>	Länge in mm <i>Length in mm</i>	Artikel Nr. <i>Part No.</i>
PRYM KaiCut		
8	210	B611515



B611515

Spezialscheren
Special Scissors



Knopflochscheren, vernickelt
Buttonhole scissors, nickel plated

Länge in " <i>Length in "</i>	Länge in mm <i>Length in mm</i>	Artikel Nr. <i>Part No.</i>
KRETZER Spirale		
4.1/2	115	B34011



B34011

Länge in " <i>Length in "</i>	Länge in mm <i>Length in mm</i>	Artikel Nr. <i>Part No.</i>
IKOS		
4.1/2	115	BB-2311b
4.1/2	115	BB-2311c



BB-2311b



BB-2311c

2.7

Spezialscheren
Special Scissors



Manufakturscheren
Professional scissors

Länge in " Length in "	Länge in mm Length in mm	Artikel Nr. Part No.
KRETZER Spirale		
5	130	B30913
6	150	B30915



B30913



B30915

Länge in " Length in "	Länge in mm Length in mm	Artikel Nr. Part No.
KRETZER Finny		
5	130	B71113



B71113

Ganzmetall-Weberscheren, vernickelt
Full-metal weaver's scissors, nickel plated

Länge in " Length in "	Länge in mm Length in mm	Artikel Nr. Part No.
KRETZER Spirale		
4	100	B35410
5	130	B35413
4	100	B35510*
5	130	B35513*



B35410 – B35513

gebogen / *curved*

Spezialscheren
Special Scissors



Länge in " <i>Length in "</i>	Länge in mm <i>Length in mm</i>	Artikel Nr. <i>Part No.</i>
KRETZER Spirale		
5	130	B32913
5	130	B33013
5	130	B33113
10	250	B45125
9,5	240	B45524
8,5	210	B46122

Berufsscheren, unvernickelt
Industry scissors, blue polished

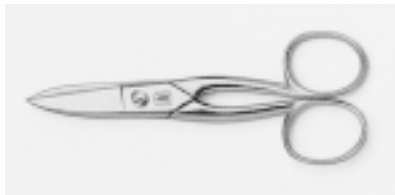

B32913



B33013



B33113



B45125
Kevlar-Schere / *Kevlar Shears*



B45524
Hutmacherschere / *Hatmakers Shears*



B46122
Lederschere / *Leather Shears*

Rollschneider
Roller Cutter



Bemerkungen <i>Remarks</i>	Durchmesser in mm <i>Diameter in mm</i>	Artikel Nr. <i>Part No.</i>
PRYM		
Rollschneider Mini <i>roller cutter Mini</i>	28	B611371
Rollschneider Maxi <i>roller cutter Maxi</i>	45	B611370
Rollschneider Jumbo <i>roller cutter Jumbo</i>	60	B611387



B611370



B611371



B611387

Zubehör für Rollschneider
Accessories for roller cutter

Ersatzklingen für Rollschneider
Spareblades for roller cutter

Bemerkungen <i>Remarks</i>	Durchmesser in mm <i>Diameter in mm</i>	Artikel Nr. <i>Part No.</i>
PRYM		
für Rollschneider Maxi <i>for roller cutter Maxi</i>	45	B611372
für Rollschneider Mini <i>for roller cutter Mini</i>	28	B611373
für Rollschneider Jumbo <i>for roller cutter Jumbo</i>	60	B611388

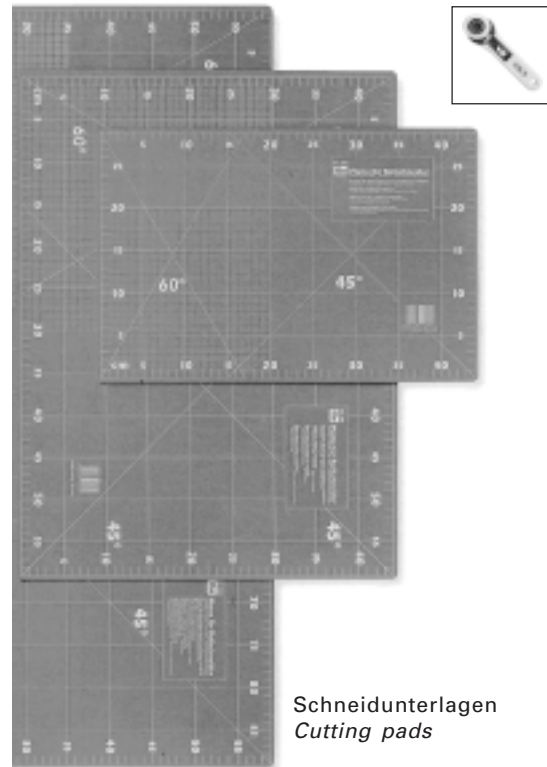

Schneidunterlagen
Cutting pads

Schneidunterlagen für Rollschneider
Cutting pads for roller cutter

Maße in cm <i>Size in cm</i>	Artikel Nr. <i>Part No.</i>
60 x 45	B611374
60 x 90	B611382

B611364

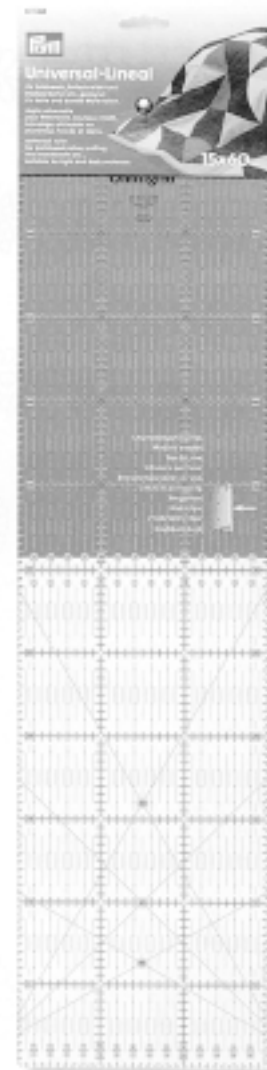

Kunststoff-Lineale für Rollschneider
Plastic-Guides for roller cutter

Maße in cm <i>Size in cm</i>	Artikel Nr. <i>Part No.</i>
24 x 17	B611357
15 x 30	B611363
15 x 60	B611364

B611363

B611357



Trennmesser
Cutting Knives

Bemerkungen <i>Remarks</i>	Artikel Nr. <i>Part No.</i>
Ziehmesser für Leder- und Kartonzuschnitt <i>knives for leather and carton pre-cut parts</i>	B611395
Standardklinge für Ziehmesser <i>standard blade</i>	B611396
Präzisionsklinge für Ziehmesser <i>precision blade</i>	B611399

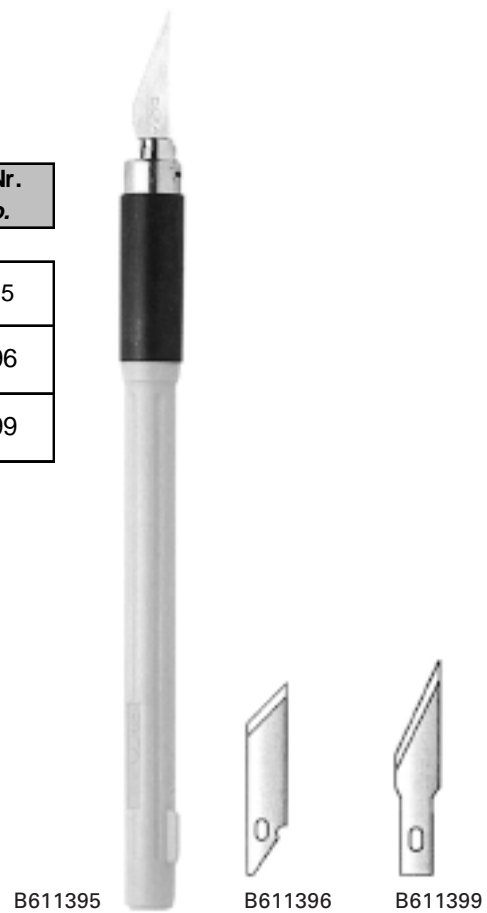

Nahttrenner mit Kugel
Seam Rippers with ball

Bemerkungen <i>Remarks</i>	Artikel Nr. <i>Part No.</i>
Nahttrenner groß <i>seam ripper big version</i>	BB-2410
Nahttrenner klein <i>seam ripper small version</i>	B54004



3. MESSEN UND MARKIEREN *MEASURING AND MARKING*

3.0 SYMBOLERLÄUTERUNGEN *SYMBOL DESCRIPTIONS*

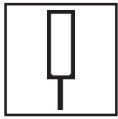
Symbolerklärungen
Symbol DescriptionsClarification des symboles
Explicación de los signos

Bohrnadel, kalt
Drill Needle, cold
Aiguille pour perceuse, froid
Aguja por perforación, frío



Bohrnadel, heiß
Drill Needle, hot
Aiguille pour perceuse, chaud
Aguja por perforación, caliente



Kerbschnittzange
Pattern Notcher Plier
Pince à cranter
Alicata para cortar muescas

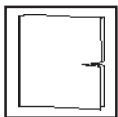

Einkerbgerät
Cloth Notcher
Appareil de crantage
Dispositivo para muescas

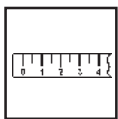

Maßband
Measure Tape
Mesure
Cinta metrica



Zählwerk
Counter
Compteur
Mecanismo contador

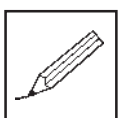

Markierung auftragen, manuell
Apply marking manually
Marquage manuel
Aplicar marcas en forma manual



UV-Markiermittel
UV-Marking items
Marquage UV
Material de marcar UV



Heißsiegelbügeleisen
Heatseal Iron
Fer pour impression à chaud
Plancha de sellar a calor



Schneiderbüste
Dummy
Mannequin
Maniquí de sastre

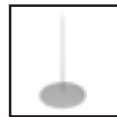

Markiernadel
Marking Pins
Aiguille à marquer
Aguja de marcar



Stecknadel
Pin
Epingles à nourrice
Alfileres

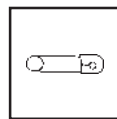

Sicherheitsnadel
Safety Pin
Aiguille de sécurité
Aguja de seguridad

3: MESSEN UND MARKIEREN *MEASURING AND MARKING*

3.1 BOHRMARKIERNADELN, KERBSCHNITT- UND LOCHZANGEN *DRILL NEEDLES AND PUNCH PLIERS*

3.1

Bohrnadeln für Bohrmarkiergeräte Drill Needles for cloth drill machines

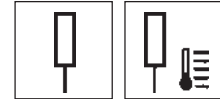

Nadelstärke in mm Needle Size in mm	für Eastman, Wolf, Kuris (Spannfutter) for Eastman, Wolf, Kuris (drill chuck)	für Bullmer 335 VS for Bullmer 335 VS	für Bullmer 336 VS for Bullmer 336 VS	für Bullmer 337 VS for Bullmer 337 VS
1,00	B12532	BB-2247	BB-2248	BB-2249
1,25	B12532A	BB-2247A	BB-2248A	BB-2249A
1,50	B12532B	BB-2247B	BB-2248B	BB-2249B
1,75	B12532C	BB-2247C	BB-2248C	BB-2249C
2,00	B12532D	BB-2247D	BB-2248D	BB-2249D
2,50	B12532E	BB-2247E	BB-2248E	BB-2249E
3,00	B12532F	BB-2247F	BB-2248F	BB-2249F
4,00	B12532G			

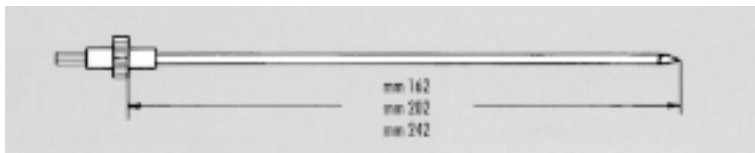

B12532

BB-2247 - BB-2249

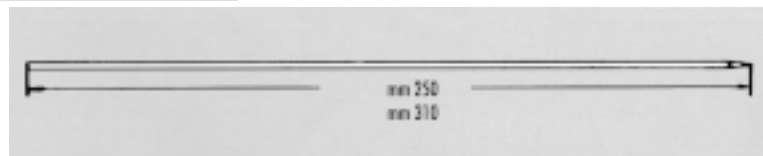

Kerbschnittzangen Pattern Notcher Plier



Kerblänge in mm length of notch in mm	Kerbreite in mm width of notch in mm	Artikelnummer Part No.
6,4	1,6	BB-2235
6,4	3,2	BB-2236
8,0	1,6	BB-2237
8,0	3,2	BB-2238

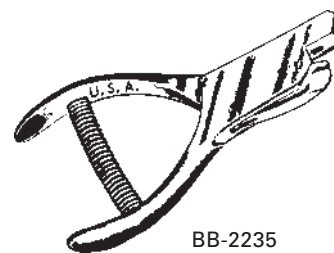

BB-2235

Einkerbgerät Cloth Notcher

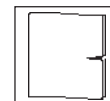

BB-2238A

Einkerbgerät zum Anbringen von Schnittmarkierungen an den Außenkanten von Stofflagenpaketen.

Cloth notcher for cut marks at the side of cloth lays.



BB-2238A

Lochwerkzeuge
Punching Tools

Henkellocheisen
Punch Tool

Durchmesser in mm <i>Diameter in mm</i>	Artikelnummer <i>Part No.</i>
2	BB-2356
3	BB-2356A
4	BB-2356B
5	BB-2356C
6	BB-2356D
7	BB-2356E
8	BB-2356F
9	BB-2356G
10	BB-2356H
12	BB-2356K



BB-2356D

BB-2357

Revolverlochzange mit sechs verschiedenen Lochpfeifen 2 - 5 mm
Revolving punch plier with six different punch tools 2 - 5 mm

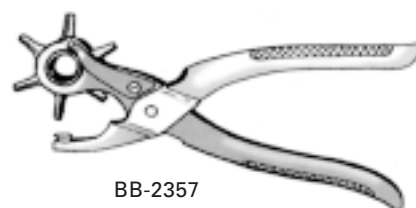

BB-2357

BB-2390

Schablonenlocher, Lochdurchmesser 19 mm
Pattern Punch, hole diameter 19 mm

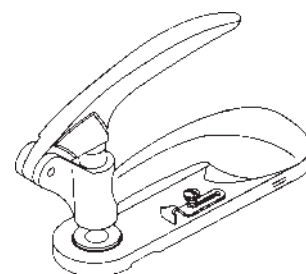

BB-2390

3: MESSEN UND MARKIEREN *MEASURING AND MARKING*

3.2 LUPEN, STÜCKZÄHLER, MASSBÄNDER UND LINEALE *MAGNIFIER, COUNTER, MEASURING TAPES AND RULERS*

Schneidermaßbänder Tailor's Measure Tapes

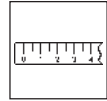

Bemerkungen <i>Remarks</i>	Maße in cm <i>Size in cm</i>	lose im Karton <i>bulk packed</i>	auf SB - Karte <i>on self-service card</i>
Standardqualität, cm/cm-Einteilung <i>standard quality, metric/metric scale</i>	150 x 1,9	B28000	B28001
Standardqualität, cm/inch-Einteilung <i>standard quality, metric/inch scale</i>	150 x 1,9	B28000A	
Standardqualität, verstärkt <i>strong quality</i>	150 x 1,9	B28002	B28003
Profiqualität <i>extra strong quality</i>	150 x 1,9		B28004
Profiqualität <i>extra strong quality</i>	200 x 1,9	BB-2363B	
Spezialqualität, beste Maßstabilität durch Glasfaserverstärkung <i>special strong quality, reinforced with glas fibre</i>	150 x 1,9	B28006	BB-2363
Rollmaßband <i>self-uncurling measure tape</i>	150 x 1,0		BB-2364
Rollmaßband <i>self-uncurling measure tape</i>	150 x 1,5		B28010
Tailienmaßband mit Metallhaken in Profiqualität <i>Waist measure tape with metal hooks, extra strong quality</i>	150 x 1,9	BB-2363A	



B28000



BB-2363B

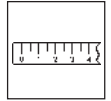

BB-2364

Selbstklebende Maßbänder
Self-adhesive Measure Tapes

Bemerkungen <i>Remarks</i>	Länge in cm <i>Length in cm</i>	Artikelnummer <i>Part No.</i>
cm-Teilung von links nach rechts laufend, besonders für Nähtische geeignet <i>with metric scale, running left to right, especially suitable for table tops</i>	150	B282690
cm-Teilung von links nach rechts laufend, besonders für Lege- und Zuschneidetische geeignet <i>with metric scale running left to right, especially suitable for laying and cutting tables</i>	2000	BB-2366A
cm-Teilung von rechts nach links laufend, besonders für Lege- und Zuschneidetische geeignet <i>with metric scale running right to left, especially suitable for laying and cutting tables</i>	2000	BB-2366B

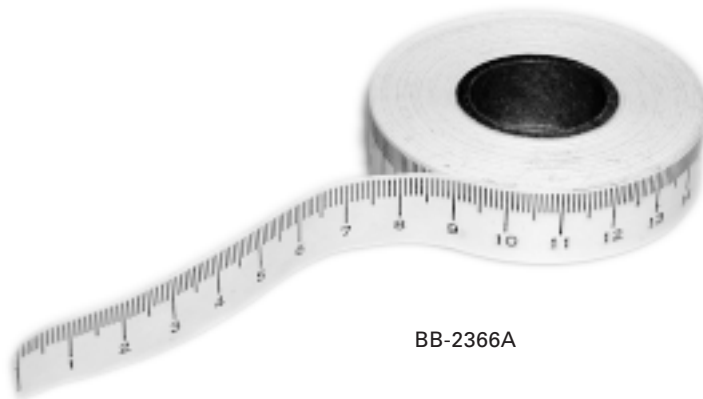

BB-2366A

Lineale und Maßstäbe Rulers and Measuring Tapes

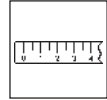

Stahlmaßstab, biegsam, mit Millimeter-Teilung
Spring Steel Ruler with metric scale

Länge in cm <i>Length in cm</i>	Artikelnummer <i>Part No.</i>
10	BB-2362
15	BB-2362A
20	BB-2362B
25	BB-2362C
30	BB-2362D
50	BB-2362E
100	BB-2362F
150	BB-2362G
200	BB-2362H



BB-2362A

B29022

Lineal aus Aluminium, Länge 100 cm, mit Millimeter-Teilung
Aluminium ruler, length 100 cm, with metric scale.



B29022

BB-2358

Kurvenlineal, flexible, mit Tuschkante, Länge 50 cm.
Curve ruler, flexible, with line drawing edge, length 50 cm.



BB-2358

Lineale und Maßstäbe
Rulers and Measuring Tapes

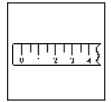

Tuchelle mit Griff, Hartholz, mit cm-Teilung von rechts nach links laufend
Hardwood Tailor's Ruler, with metric scale from right to left

Maße in mm Size in mm	Artikelnummer Part No.
500 x 18 x 13	BB-2360
1000 x 18 x 13	BB-2360A



BB-2360A

Reverswinkel mit Maßeinteilung
Tailor's Angle with scale

Maße in mm Size in mm	Bemerkungen Remarks	Artikelnummer Part No.
60 x 24	aus Kunststoff <i>plastic</i>	BB-2359
60 x 24	aus Leichtmetall <i>aluminium</i>	BB-2359A



BB-2359

B29003

Dreieckswinkel aus Leichtmetall 29,5 x 15 x 33 cm.
Triangle bracket, aluminium 29.5 x 15 x 33 cm.

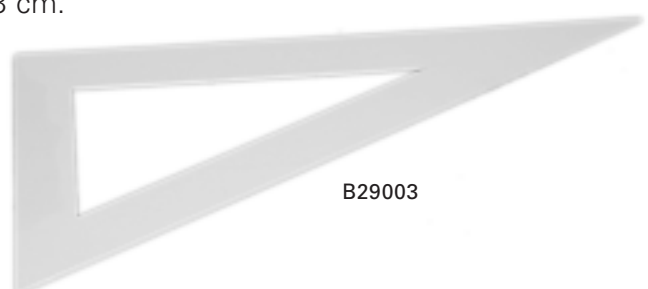

B29003

Stückzähler und Fadenzähler
Counter and Thread Counter



BB-2389

Handstückzähler, vierstellig, geeignet zur Tischmontage.
Tally counter with four digits, suitable for table mounting.

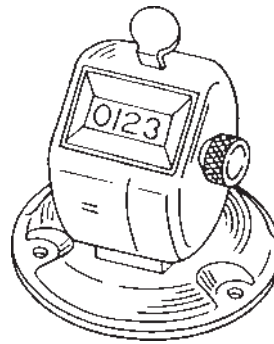

BB-2365

Fadenzähl Lupe, 10 x 10 mm.
Thread counter, 10 x 10 mm.



3: MESSEN UND MARKIEREN *MEASURING AND MARKING*

3.3 KREIDE UND MARKIERSTIFTE *CHALK AND MARKING PINS*

Schneiderkreide Tailor's Chalk



Farbe colour	25 Stück/Karton 25 pieces per box	100 Stück/Karton 100 pieces per box
weiß white	B34008-20	BB-2370
rot red	B34009-21	BB-2371
blau blue	B34009-22	BB-2373
gelb yellow	B34009-23	BB-2372

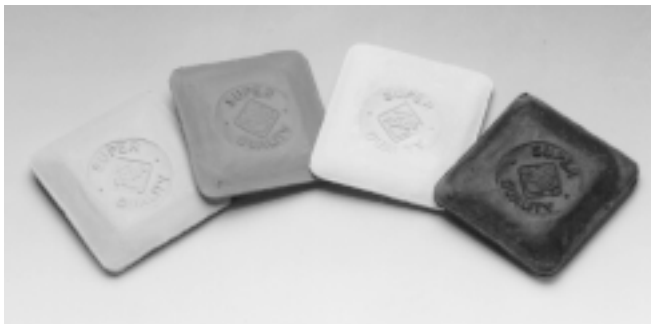

Wachskreide, 50 Stück/Karton Wax Chalk, 50 pieces per box



Bemerkungen Remarks	Artikelnummer Part No.
weiß white	BB-2378
extra-weiß extra white	BB-2378A
rot red	BB-2378B
gelb yellow	BB-2378C
blau blue	BB-2378D

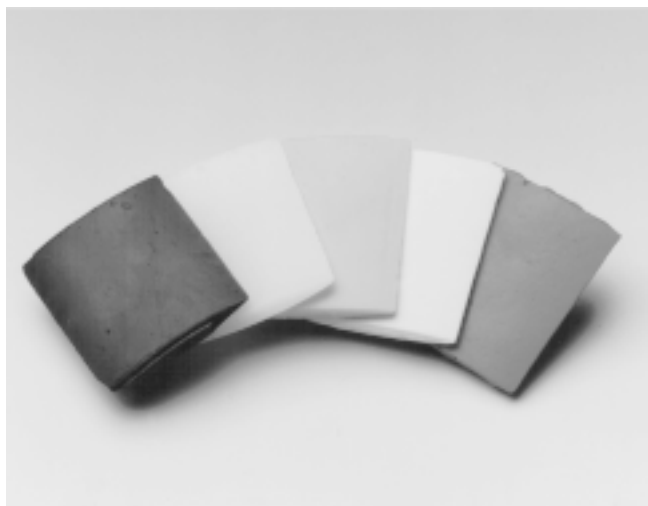

Sublimatkreide, weiß, 50 Stück/Karton
Sublimating Chalk, white, 50 pieces per box

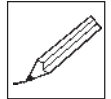

Bemerkungen <i>Remarks</i>	Artikelnummer <i>Part No.</i>
selbstlöschend nach 3 - 5 Tagen <i>visible for 3 - 5 days</i>	BB-2379
selbstlöschend nach 1 - 2 Tagen <i>visible for 1 - 2 days</i>	BB-2380



Kreidestifte mit Löschbürste
Tailor's Chalk Pencil with brush

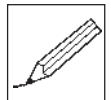

Bemerkungen <i>Remarks</i>	Artikelnummer <i>Part No.</i>
weiß <i>white</i>	BB-2382
rosa <i>pink</i>	BB-2382A
blau <i>blue</i>	BB-2382B



Sublimatstifte Sublimating Pencils

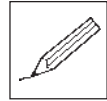

Bemerkungen <i>Remarks</i>	Artikelnummer <i>Part No.</i>
rosa, selbstlöschend nach 10 - 20 Stunden <i>pink, visible for 10 - 20 hours</i>	BB-2381A
violett, selbstlöschend nach 2 - 14 Tagen <i>purple, visible for 2 - 14 days</i>	BB-2381B
blau, mit Wasser löschar <i>blue, erasable with water</i>	BB-2381C
weiß, selbstlöschend nach 2 - 4 Tagen <i>white, visible for 2 - 4 days</i>	BB-2381D



BB-2381C



BB-2381D

BB-2381e

Löschstift für Sublimatstifte
Eraser for sublimating pencils



Zeichenstifte mit Wechselmine Pencils with exchangeable lead

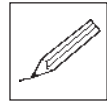

Druckhalter für Kreideminen 100 x 3,2 mm
Pen Holder for Chalk Leads 100 x 3,2 mm

Bemerkungen <i>Remarks</i>	Artikelnummer <i>Part No.</i>
Druckhalter für Kreideminen <i>Pen holder for chalk leads</i>	B34013
Schneiderkreidemine, 12 Stück / Dose <i>Tailor's chalk lead, box of 12 pices</i>	B34014



Zeichenstifte mit Wechselmine
Pencils with exchangeable lead

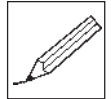

Druckstift für Fettminen 100 x 3 mm
Pen Holder for Grease Leads, 100 x 3 mm

Bemerkungen <i>Remarks</i>	Artikelnummer <i>Part No.</i>
Drehstift für Fettminen <i>Pen holder for grease leads</i>	BB-2386
Fettmine, weiß, 12 Stück / Dose <i>Grease lead, white, 12 pc. / box</i>	BB-2387
Fettmine, rot, 12 Stück / Dose <i>Grease lead, red, 12 pc. / box</i>	BB-2387A
Fettmine, gelb, 12 Stück / Dose <i>Grease lead, yellow, 12 pc. / box</i>	BB-2387B
Fettmine, blau, 12 Stück / Dose <i>Grease lead, blue, 12 pc. / box</i>	BB-2387C



BB-2386

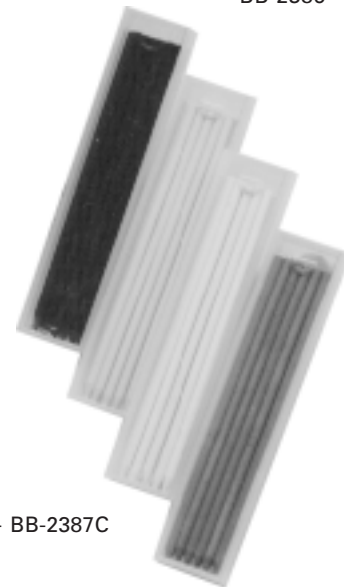

BB-2387 - BB-2387C

Drehstift für Silberminen
Ball Pen Holder for Silver Cartridge

Bemerkungen <i>Remarks</i>	Artikelnummer <i>Part No.</i>
Drehstift für Silberminen <i>Ball pen holder for silver cartridge</i>	BK-700EH
Silbermine, 10 Stück / Dose <i>Ball pen silver cartridge, 10 pieces / box</i>	BK-700

Kopierrädchen Tracing Wheel

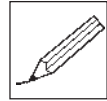

BB-2339

Kopierrädchen mit Kunststoffgriff, 22 Stahlnadeln
Tracing wheel with plastic handle and 22 steel needles



Kreideschärfer Chalk Sharpener

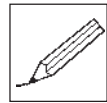

Bemerkungen <i>Remarks</i>	Artikelnummer <i>Part No.</i>
komplett aus Kunststoff <i>all plastic</i>	BB-2367
aus Kunststoff mit Metallklingen <i>plastic with embedded metal blades</i>	BB-2367A
Modell Spitzfix, mit Auffangbehälter <i>Model Spitzfix, with waste compartement</i>	BB-2368



BB-2367

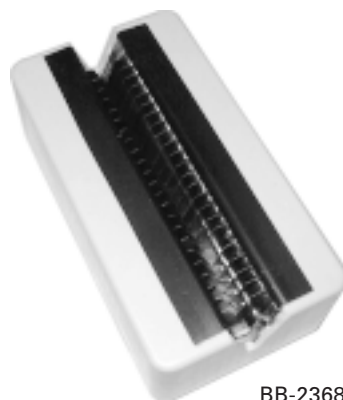

BB-2368

Kreidemarkiergeräte
Chalk Marking Devices

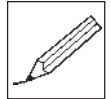

BB-2369

Kreidezeichner Imperator
Chalk marker Imperator



BB-2384

Pauspuderverteiler
Chalk powder applicator



Kreidepulver mit besonders guter Haftung
Chalk Powder, very well adhesive

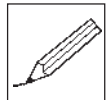

Farbe Colour	1000 ccm / Dose 1000 ccm / can	100 ccm / Beutel 100 ccm / bag
weiß white	B34004	BB-2374A
röt red	B34005A	BB-2374B
gelb yellow		BB-2374C
blau blue		BB-2374D



Spezial-Kreidepulver, weiß
Special Chalk Powder, white

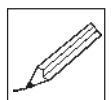

Bemerkungen Remarks	Menge Quantity	Artikelnummer Part No.
Pauspuder PS-Special <i>Pattern powder</i>	1000 ccm	BB-2385
Sublimatpulver, 1 - 2 Tage sichtbar <i>Sublimating chalk powder, visible for 1 - 2 days</i>	500 ccm	B34006

UV - Markiermittel UV - Marking Items



Tankstifte für UV-Tinktur
Refillable Pen for UV-liquid

Bemerkungen Remarks	Artikelnummer Part No.
UV-Filzschreiber, gefüllt, grün leuchtend, nachfüllbar <i>UV-pen, filled with green UV-liquid, refillable</i>	B99420-01
UV-Tankstift mit 1-2 mm Spitze, ungefüllt <i>UV-pen, with 1-2 mm tip diameter, unfilled</i>	B94400-012
UV-Tinktur für glatte Oberflächen, grün leuchtend, 250 ml <i>UV-liquid for leather/plastic, green, 250 ml</i>	B452-2
UV-Tinktur für textile Oberflächen, grün leuchtend, 250 ml <i>UV-liquid for textile materials, green, 250 ml</i>	B453-2



B99420-01



B452-2

UV-Stifte und Kreide
UV-Pencils and Chalk

Bemerkungen Remarks	Artikelnummer Part No.
UV-Bleistift, grün leuchtend <i>UV-pencil, green</i>	B99117-1
UV-Minen 100 x 3 mm, grün leuchtend, 12 Stück / Dose, geeignet für Drehstift Artikelnummer BB-2386 <i>UV - leads 100 x 3 mm, green, box of 12 pieces, suitable for revolving pen holder part no. BB-2386</i>	BB-2387d
UV-Puder, grün leuchtend, Dose a 500 g <i>UV-powder, green, can of 500 g</i>	B99117-10
UV-Wachskreide, grün leuchtend, 48 Stück / Karton <i>UV-wax chalk, green, box of 48 pieces</i>	B99117-2



B99117-1



BB-2387d



B99117-2

3: MESSEN UND MARKIEREN *MEASURING AND MARKING*

3.4 HEISSSIEGELBÜGELEISEN, ROCK- ABRUNDER UND SCHNEIDERBÜSTEN *HEAT SEAL IRONS, SKIRT MARKERS AND DUMMIES*

3.4 HEISSIEGELBÜGELEISEN, ROCKABRUNDER UND SCHNEIDERBÜSTEN HEAT SEAL IRONS, SKIRT MARKERS AND DUMMIES

Heißsiegelbügeleisen Heatseal Iron



Bemerkungen <i>Remarks</i>	Heizleistung <i>Capacity</i>	Länge in mm <i>Length in mm</i>	Breite in mm <i>Width in mm</i>	Artikelnummer <i>Part No.</i>
kleine Ausführung <i>small version</i>	1000W / 230V	250	130	BD-4134
mit Abstellergriff <i>with iron-rest handle</i>	2000W / 230V	750	150	BD-4135
mit Abstellergriff <i>with iron-rest handle</i>	3000W / 230V	750	150	BD-4135A

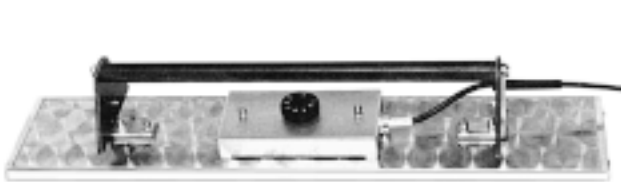

BD-4135



BD-4134

Rockabründer Skirt Marker

Bemerkungen <i>Remarks</i>	Höhe in mm <i>Height in cm</i>	Fabrikat <i>Brand</i>	Artikelnummer <i>Part No.</i>
Standmodell für Kreidemarkierungen <i>Standind version for chalk markings</i>	80	PRYM	B611767
Standmodell für Kreidemarkierungen <i>Standing version for chalk markings</i>	90	IKOS	BC-2544
Profiausführung, fahrbar, für Kreidemarkierungen <i>Professional version, mobile, for chalk markings</i>	80	IKOS	BC-2545
Spezialausführung für Fadenmarkierungen <i>Special version for thread marking</i>	80	FADOMAT	BC-2547m



B611767



BC-2544



BC-2545

BC-2547m



Zubehör
Accessories

Verschleißteile für Rockabrunder
Wear and Tear Parts for Skirt Marker

Bemerkungen Remarks	Artikelnummer Part No.
Zerstäuber für fahrbaren Rockabrunder BC-2545 <i>Atomizer for mobile skirt marker BC-2545</i>	B11133
Ball für fahrbaren Rockabrunder BC-2545 <i>Ball for mobile skirt marker BC-2545</i>	B11135
Schlauch für fahrbaren Rockabrunder BC-2545 <i>Hose coupling for mobile skirt marker BC-2545</i>	B11137
Verschuß für fahrbaren Rockabrunder BC-2545 <i>Coupling for mobile skirt marker BC-2545</i>	B11138
Ballgarnitur für Rockabrunder BC-2544 <i>Ball and hose coupling for skirt marker BC-2544</i>	B11154

Schneiderbüsten Dummies



Schneiderbüsten, starr Dummies, fixed			
Größe Size	Herren- und Knabenbüsten Male Dummies	Damen- und Mädchenbüsten Female dummies	Mantel- und Rockbüste Coat and long skirt dummies
36		BB-196136	
37		BB-196137	
38		BB-196138	
39		BB-196139	
40	BB-195140	BB-196040	BB-196540
41	BB-195141		
42	BB-195142	BB-196042	BB-196542
44	BB-195044	BB-196044	BB-196544
45	BB-195345		
46	BB-195046	BB-196046	BB-196546
47	BB-195347		
48	BB-195048	BB-196048	BB-196548
49	BB-195349		
50	BB-195050		
51	BB-195351		
52	BB-195052		
53	BB-195353		
54	BB-195054		
55	BB-195355		
56	BB-195056		
57	BB-195357		
59	BB-195359		
61	BB-195361		



BB-195140



BB-196138



BB-196542

Schneiderbüsten
Dummies



Schneiderbüsten, verstellbar Dummies, adjustable		
Größe Size	Herren- und Knabenbüsten Male Dummies	Damen- und Mädchenbüsten Female dummies
38-42		BB-198B38
40-44		BB-198B40
42-46		BB-198B42
44-48		BB-198B44
46-50	BB-198A46	BB-198B46
48-52	BB-198A48	
50-54	BB-198A50	
52-56	BB-198A52	



BB-198B44

Büstenständer
Dummy Rack

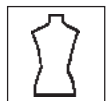

Bemerkungen Remarks	Artikelnummer Part No.
aus lackiertem Metallrohr varnished metal	BB-19104A
aus verchromtem Metallrohr chrome plated metal	BB-19104B



BB-19104B

3: MESSEN UND MARKIEREN *MEASURING AND MARKING*

3.5 MARKIER-, SICHERHEITS- UND STECKNADELN *MARKING AND FIXING PINS*

3.5

Zuschnittmarkiernadeln Marking Pins

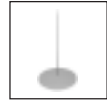

Bemerkungen <i>Remarks</i>	Nadellänge in mm <i>Needle Length in mm</i>	Nadelstärke in mm <i>Needle Size in mm</i>	Artikelnummer <i>Part No.</i>
blau <i>blue</i>	30	0,65	BB-2340
weiß <i>white</i>	40	0,90	BB-2341
schwarz <i>black</i>	55	0,90	BB-2341A
rot <i>red</i>	65	1,00	BB-2342
grau <i>grey</i>	75	1,00	BB-2342A



Zuschnittbefestigungsnadeln Pattern Stick Pins

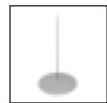

Länge in mm <i>Length in mm</i>	Artikelnummer <i>Part No.</i>
25	BB-2418
40	BB-2419
60	BB-2420
75	BB-2421

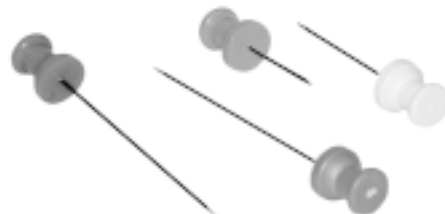

Nadelleiste
Needle Bar

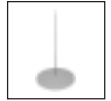

Länge in mm <i>Length in mm</i>	Artikelnummer <i>Part No.</i>
15	BB-2347A
20	BB-2347
30	BB-2348
40	BB-2349
50	BB-2350
60	BB-2350A



Nadeldreieck
Needle Triangle

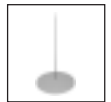

Länge in mm <i>Length in mm</i>	Artikelnummer <i>Part No.</i>
20	BB-2351
40	BB-2353

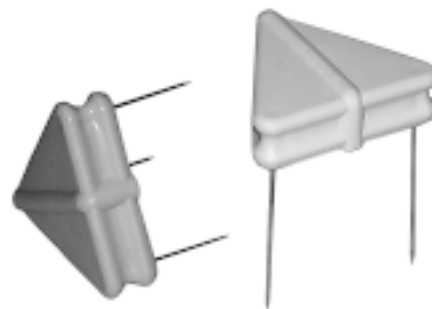

BB-2353

3.5

Stecknadeln, Stahl, 500 g/Karton
Pins, Steel, 500 g / box



Bemerkung <i>Remarks</i>	Nadellänge in mm <i>Needle length</i> in mm	Nadelstärke in mm <i>Needle Size</i> in mm	Fabrikat / Brand AMAZONAS <i>Artikelnummer / Part No.</i>	Fabrikat / Brand PRYM <i>Artikelnummer / Part No.</i>
Superfein, silberfarbig <i>Super fine, silver</i>	30	0,5		B024122
Extrafein, silberfarbig <i>Extra fine, silver</i>	30	0,6	BB-2325A	B024158
Fein, silberfarbig <i>Fine, silver</i>	30	0,7	BB-2325	B024263
Extrafein, silberfarbig <i>Extra fine, silver</i>	34	0,6	BB-2326A	B024164
Fein, silberfarbig <i>Fine, silver</i>	34	0,7	BB-2326	B024264



Stecknadeln, Messing, silberfarbig, 500 g/Karton
Pins, brass, silver, 500 g/box



Nadellänge in mm <i>Needle Length in mm</i>	Nadelstärke in mm <i>Needle Size in mm</i>	Artikelnummer <i>Part No.</i>
26	0,6	B011209
30	0,8	B011205

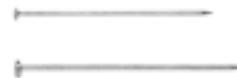

Glaskopf-Stecknadeln, Stahl, 1000 Stück/Karton
Pins, Steel, 1000 pieces/box



Bemerkungen <i>Remarks</i>	Nadellänge in mm <i>Needle Length in mm</i>	Nadelstärke in mm <i>Needle Size in mm</i>	Fabrikat / Brand AMAZONAS Artikelnummer / Part No.	Fabrikat / Brand PRYM Artikelnummer / Part No.
Nr. 9, mit bunten Köpfen <i>No. 9, assorted colors</i>	30	0,6	BB-1935	B029157
Nr. 2/0, mit bunten Köpfen <i>No. 2/0, assorted colors</i>	48	0,8		B029116
Nr. 2/0, mit weißen Köpfen <i>No. 2/0, white only</i>	48	0,8		B029209



Plastikkopf-Stecknadeln, mit bunten Köpfen, 1000 Stück/Karton
Pins, steel with plastic heads, assorted colours, 1000 pieces/box



Nadellänge in mm <i>Needle Length in mm</i>	Artikelnummer <i>Part No.</i>
30	BB-2327
50	BB-2327A



Nadelkissen Pin Cushion

Bemerkungen <i>Remarks</i>	Artikelnummer <i>Part No.</i>
mit glatten Boden <i>with slick bottom</i>	B29009
mit Stecknadeldose <i>with pintin</i>	B29011
mit Klemme <i>with clamp</i>	BB-2322
mit Sauger <i>with suction cup</i>	BB-2323
mit Armspange <i>with bracelet</i>	BB-2324
für Rockabründer <i>for skirt marker</i>	BC-2546

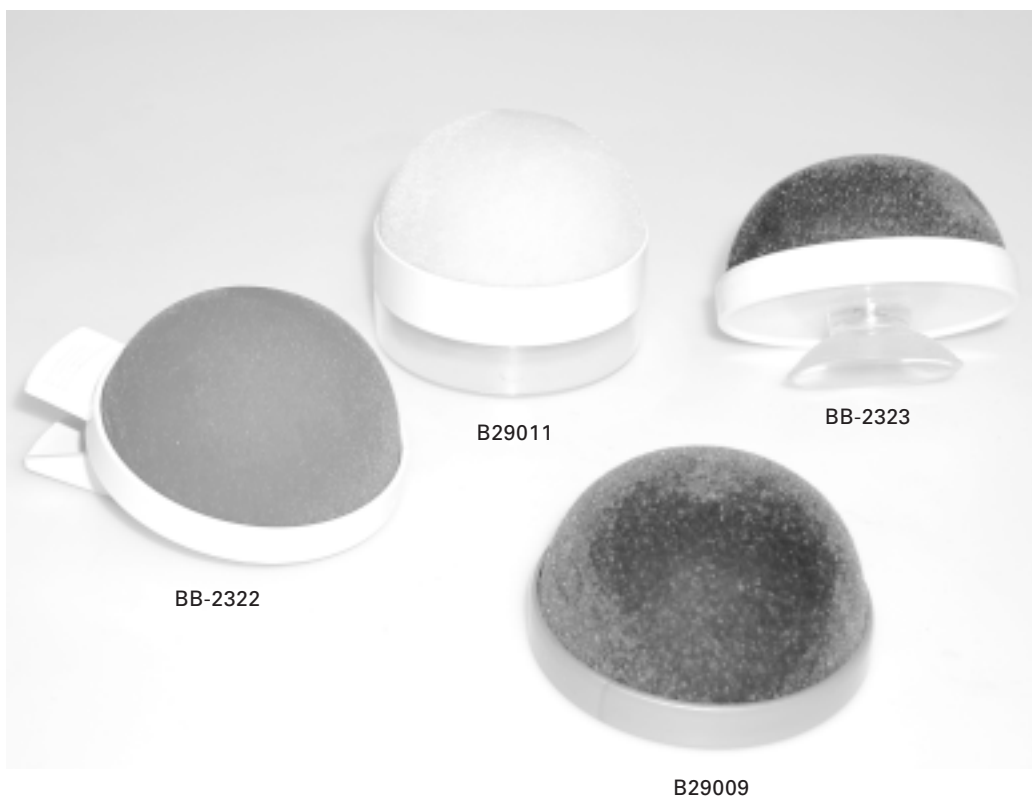

Sicherheitsnadeln, 1000 Stück/Packung
Safety Pins, 1000 pieces/box

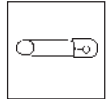

Fabrikat PRYM				
Größe Size	Länge in mm Length in mm	Messing Brass	Stahl Steel	Edelstahl Stainless Steel
Nr. 3/0 No. 3/0	19	B071136	B085270	
Nr. 2/0 No. 2/0	23	B071137	B085271	
Nr. 0 No. 0	27	B071139	B085272	B085362
Nr. 1 No. 1	34		B085273	
Nr. 2 No. 2	38		B085274	
Nr. 3 No. 3	50		B085275	
Nr. 4 No. 4	57		B085277	



3

Sicherheitsnadeln, 1000 Stück/Packung
Safety Pins, 1000 pieces/box

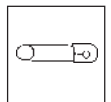

Fabrikat AMAZONAS			
Größe Size	Länge in mm Length in mm	Messing Brass	Stahl Steel
Nr. 1 No. 1	28	BB-1939	
Nr. 1 No. 1	30		BB-1936
Nr. 2 No. 2	38	BB-1940	
Nr. 2 No. 2	40		BB-1937
Nr. 3 No. 3	50	BB-1941	BB-1938
Nr. 4 No. 4	58	BB-1942	



3.5 MARKIER-, SICHERHEITS- UND STECKNADELN MARKING AND FIXING PINS

Sicherheitsnadeln, Eisen, vernickelt, 1000 Stück/Karton
Safety Pins, iron, nickel plated, 1000 pieces/box

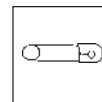

Größe Size	Länge in mm Length in mm	Artikelnummer Part No.
Nr. 0 No. 0	28	BB-2328
Nr. 1 No. 1	33	BB-2328A
Nr. 2 No. 2	40	BB-2328B
Nr. 3 No. 3	45	BB-2328C
Nr. 4 No. 4	50	BB-2328D



4: NACHBEARBEITUNG *POSTPROCESSING*

4.0 SYMBOLERLÄUTERUNGEN *SYMBOL DESCRIPTIONS*

Symbolerklärungen
Symbol Descriptions

Clarificación des symboles
Explicación de los signos



Bügelbedarf
Ironing equipment
Accessoires de repassage
Auxiliares de planchado

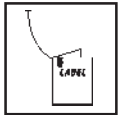

Etikettieren
Labeling
Etiquetage
Etiquetado

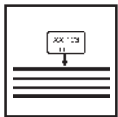

Auszeichnungsgeräte
Labeling Devices
Appareil d'étiquetage
Aparato de etiquetado

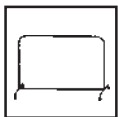

Atelierausstattung
Studio Equipment
Fournitures d'atelier
Equipo de sala de costura

4: NACHBEARBEITEN *POSTPROCESSING*

4.1 WENDEGERÄTE *TURNING DEVICES*

Kragenwender Collar Turner

Bemerkungen Remarks	Artikelnummer Part No.
Typ A, für spitze Kragenecken "A" Type, for tapered collar edges	BA-1550s
Typ B, für abgerundete Kragenecken "B" Type, for rounded collar edges	BA-1551s



BA-1550s

BA-1551s



Gürtel- und Krawattenwender Belt & Tie Turner



BA-1552

Schlaufen- und Kragenwender
Loop and collar turner



BA-1553

4: NACHBEARBEITEN *POSTPROCESSING*

4.2 FADENSCHERGERÄTE UND ZUBEHÖR *TRIMMING MACHINES AND ACCESSORIES*

Fadenschergerät *Trimming Machine*

BTM-170

Fadenschergerät mit 2 Scherköpfen, fahrbar, mit integrierter Absaugung und Auffangbehälter. Gewährleistet ein effektives und schonendes Entfernen von heraushängenden Fäden und Fadenketten an fertigen Kleidungsstücken.

Trimming machine with two trimmer heads, mobile, with built-in suction and waste compartment. Guarantees an effective and careful removal of loose thread ends from the ready-made garment.



Scherblätter *Thread Trimming Blades*

Bemerkungen <i>Remarks</i>	Fabrikat / Brand TRIM-MASTER	Fabrikat / Brand CRA
für feine bis mittlere Fäden <i>for fine up to medium thread</i>	BC-2562 (TX3)	BC-2565 (T7)
für mittlere bis grobe Fäden <i>for medium up to coarse thread</i>	BC-2563 (TX6)	BC-2566 (T8)

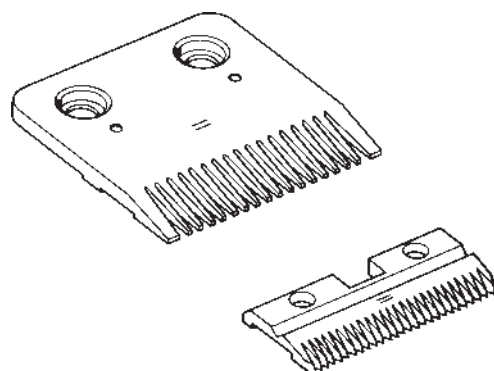

4: NACHBEARBEITEN *POSTPROCESSING*

4.3 BÜGELBEDARF *IRONING EQUIPMENT*

Bügelkissen ohne Ständer *Ironing Cushions without Stand*



Bemerkungen <i>Remarks</i>	Maße in cm <i>Size in cm</i>	Artikelnummer <i>Part No.</i>
Handkissen mit Gurt <i>Ironing hand cushion with strap</i>	11 x 22	BB-19709
Bügelkissen in Bohnenform <i>Ironing cushion, bean-shaped</i>	32 x 62	BB-19786B/2
Bügelkissen in Eiform <i>Ironing cushion, egg-shaped</i>	35 x 60	BB-19787B/1



BB-19786B/2



BB-19787B/1



BB-19709

Bügelkissen auf Holzbock
Ironing Cushion with wooden Stand



Bemerkungen <i>Remarks</i>	Maße in cm <i>Size in cm</i>	Artikelnummer <i>Part No.</i>
Berliner Bock <i>Ironing cushion 'Berlin design' with wooden stand</i>	15 x 30	BB-19714A
Ärmelbock <i>Arm ironing cushion with wooden stand</i>	10 x 68	BB-19720
Bügelbock in Bohnenform <i>Ironing cushion, bean-shaped, with wooden stand</i>	30 x 60	BB-19786
Bügelbock in Eiform <i>Ironing cushion, egg-shaped, with wooden stand</i>	30 x 60	BB-19787
Bügelbock <i>Ironing cushion with wooden stand</i>	19 - 26 x 75	BB-19787C
Achselbock <i>Shoulder ironing cushion with wooden stand</i>	11 x 25	BB-19788



BB-19714A



BB-19720

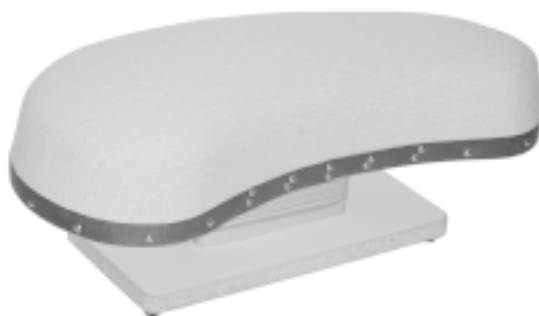

BB-19786



BB-19787



BB-19787C



BB-19788

Samtbügelunterlagen *Velvet Ironing Pads*



BB-19799

Bügelblatt mit Nadelborsten, 20 x 60 cm
Needle point ironing pad, 20 x 60 cm

BB-19799A

Borstengewebe aus Kunststoff auf hitzebeständigem
Nomex-Filz, 150 cm breit, Verkauf per Meter.
*Bristle ironing cover with heatresistant Nomex felt,
width 150 cm, sold per metre.*



4: NACHBEARBEITEN *POSTPROCESSING*

4.4 ETIKETTIEREN *LABELING*

Etikettenheftzangen Tagging Guns

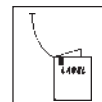

Ausführung Version	Fabrikat / Brand ALLSTAR	Fabrikat / Brand BANOK	Fabrikat / Brand DENNISON	Fabrikat / Brand N-S/F
für Standardnadel <i>for standard needle</i>	BD-3516B	BD-3516	BD-3516A	BD-3520A
für feine Nadel <i>for fine needle</i>	BD-3517A	BD-3517		BD-3521A
für lange Nadel <i>for long needle</i>	BD-3518A	BD-3518		



BD-3516B



BD-3516



BD-3516A

Ersatznadeln für Etiketten-Heftzangen Tagging Needles

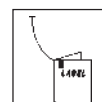

Bemerkungen <i>Remarks</i>	Artikelnummer <i>Part No.</i>
Standardnadel für Allstar, Banok, NS = Typ S <i>Standard needle for Allstar, Banok, NS = Type S</i>	BD-3512
Standardnadel für Dennison Mark 1 = Typ S <i>Standard needle for Dennison Mark 1 = Type S</i>	BD-3512A
feine Nadel für Allstar, Banok, NF = Typ X <i>fine needle for Allstar, Banok, NF = Type X</i>	BD-3513
lange Nadel für Allstar, Banok = Typ L <i>long needle for Allstar, Banok = Type L</i>	BD-3519



BD-3512



BD-3513



BD-3519

Etiketten-Heftfäden
Tagging Threads

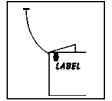

Länge in mm <i>Length in mm</i>	Verkaufseinheit <i>Sales Unit</i>	Standardfäden <i>Standard thread</i>	feine Fäden <i>Fine thread</i>
7	10.000		BD-3515D
15	5.000	BD-3514	BD-3515
25	5.000	BD-3514A	BD-3515A
40	5.000	BD-3514B	
50	5.000	BD-3514D	BD-3515B
65	5.000	BD-3514C	BD-3515C



Etiketten
Labels

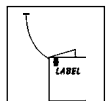

Hängeetiketten, Rolle à 1000 Stück
Hanging Labels, 1000 Pieces / Roll

Bemerkungen <i>Remarks</i>	Artikelnummer <i>Part No.</i>
ohne Aufdruck <i>without print</i>	BE30x58RS
mit Aufdruck <i>with print</i>	BE30x58T

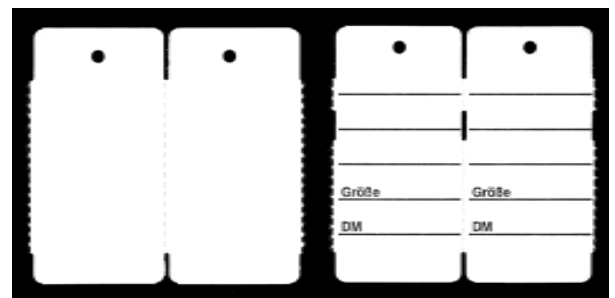

BE30x58RS

BE30x58T

Warenanhänger mit Plastiköse, 1000 Stück / Karton
Hanging Labels with Plastic Eye, 1000 Pieces / box

Maße in mm <i>Size in mm</i>	Artikelnummer <i>Part No.</i>
40 x 50	BS40
48 x 65	BS48

Nicht mehr lieferbar
No longer available

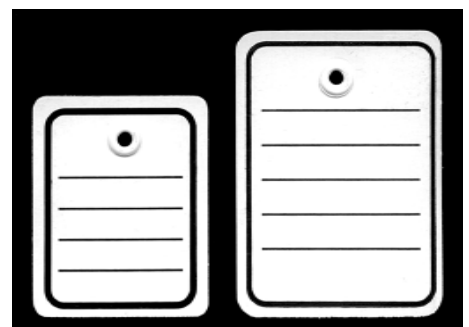

Auszeichnungsgeräte TOVEL für Selbstklebeetiketten Labeling Devices TOVEL for self-adhesive Labels

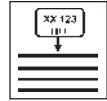

Anzahl der Druckwerkziffern Number of printing digits		Etikettengröße in mm Label size in mm	Bezeichnung Type	Artikelnummer Part No.
feststehend fixed	fortlaufend consecutive			
3	3	22 x 12	TL3P	BD-3525
3	4	22 x 12	TL4P/1	BD-3525A
6		22 x 12	TL6	BD-3527A
7		22 x 12	TL7	BD-3527
5	3	26 x 12	TK3P	BD-3526
8		26 x 12	TK8	BD-3528

Diese Geräte bieten vielseitige Einsatzmöglichkeiten im Bereich Zuschnitt, Warenkontrolle und Preisauszeichnung. Bei Druckwerken mit fortlaufenden Ziffern bestehen drei Einstellmöglichkeiten:

1. Gleichbleibende Stempelung von allen Druckwerkstellen
2. automatisches Weiterzählen der fortlaufenden Ziffern nach jedem Druck
3. automatisches Weiterzählen der fortlaufenden Ziffern nach jedem 2. Druck

These devices are used for various applications in the cutting room, fabric control or price labeling. Versions with consecutive printing digits offer three different print settings:

1. constant print of all numbers set in the print mechanism
2. automatic change of the consecutive digits after each print
3. automatic change of the consecutive digits after every second print

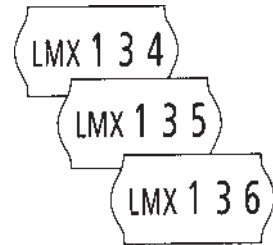
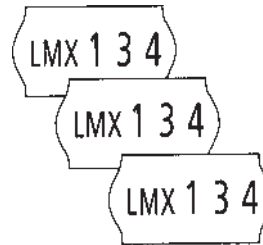

Farbrollen, schwarz
Replacement Ink Rolls, black

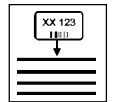

Bemerkungen <i>Remarks</i>	Länge in mm <i>Length in mm</i>	Artikelnummer <i>Part No.</i>
für Auszeichnungsgerät Blitz, etc. <i>for labeller Blitz, etc.</i>	29	BD-3525C
für Auszeichnungsgerät Tovel, etc. <i>for labeller Tovel, etc.</i>	30	BD-3525B

Selbstklebeetiketten
Self-adhesive Labels

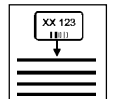

Maße in mm <i>Size in mm</i>	Verkaufseinheit <i>Sales unit</i>	Artikelnummer <i>Part No.</i>
22 x 12	67.500	BD-3529
26 x 12	54.000	BD-3530

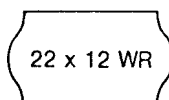

BD-3529

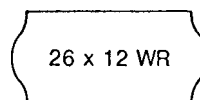

BD-3530

4: NACHBEARBEITEN *POSTPROCESSING*

4.5 ATELIERAUSSTATTUNG *STUDIO EQUIPMENT*

Rollständer auf kugelgelagerten Gummirollen Garment Racks on ball bearing rubber wheels

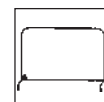

Bemerkungen <i>Remarks</i>	Maße in cm <i>Size in cm</i>	verchromt <i>chrome-plated</i>	braun lackiert <i>brown varnished</i>
Doppelrollständer <i>Double Garment Rack</i>	200 x 180	BB-19514AC	BB-19514AL
Rollständer mit Auszieharm <i>Garment Rack with pull-out bar</i>	180 x 180	BB-19514C	BB-19514L

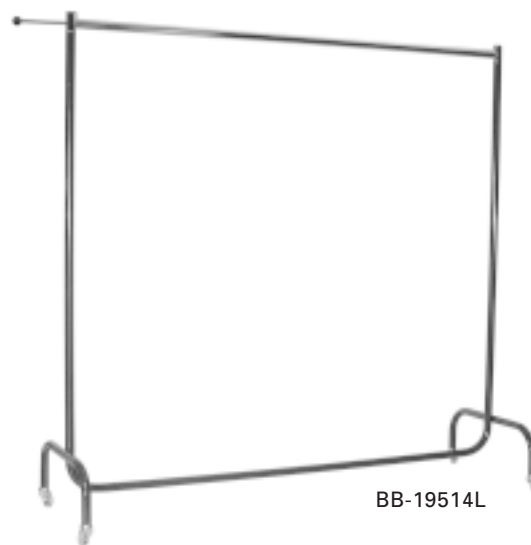
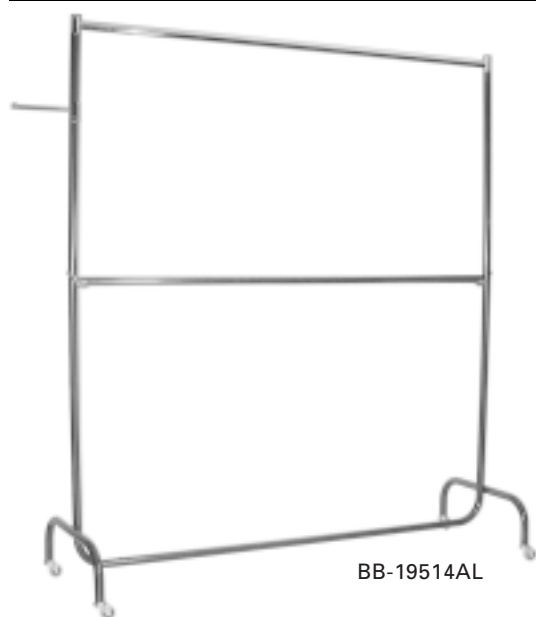

Spiegel, dreiteilig Mirrors, three pieces

Bemerkungen <i>Remarks</i>	Maße / sizes in cm		Artikelnummer <i>Part No.</i>
	Mittelteil / <i>Centre part</i>	Seitenteile / <i>side parts</i>	
zur Wandmontage <i>wall-mounted version</i>	57 x 144	28 x 144	BB-19532
auf verchromtem Rollständer <i>on chrome-plated wheel rack</i>	57 x 144	28 x 144	BB-19545



5: ZUSCHNEIDEN *CUTTING*

5.0 SYMBOLERLÄUTERUNGEN *SYMBOL DESCRIPTIONS*

Symbolerklärungen
Symbol Descriptions

Clarification des symboles
Explicación de los signos



Öl
Oil
Huile
Aceite



Spray
Spray
Spray
Spray



Folie
Foil
Folie
Folio



Werkzeuge
Tools
Outils
Herramientos

5: VERBRAUCHSMATERIALIEN UND WERKZEUGE *CONSUMPTION ITEMS AND TOOLS*

5.1 ÖLE UND SPRAYS *OILS AND SPRAYS*

Nähmaschinenöle und Schmierfett Sewing Machine Oil and Axle-grease



Viskosität Viscosity	Farbe Colour	Füllmenge in Liter / Content in litre			
		0,1	1,0	5,0	10,0
10	klar/clear		BC-2533	BC-2533A	BC-2533B
16	klar/clear	BC-2532D*	BC-2532	BC-2532A	BC-2532B
22	gelb/yellow		BC-2549	BC-2549A	BC-2549B
32	rot/red		BC-2535	BC-2535A	BC-2535B
46	braun/brown		BC-2534	BC-2534A	BC-2534B

Nicht mehr lieferbar
No longer available



BC-2532D

* Mindestbestellmenge für 100 ml Ölflaschen mit neutralem Etikett = 50 St.,
für Ölflaschen mit vierzeiligem Werbedruck = 200 St. je Auftrag.

* Minimum order quantity for 100 ml oil bottles with standard label = 50 pcs.,
for bottles with four individual printed advertising lines on label = 200 pcs.

BC-2532

Dünnflüssiges Öl, gleichermaßen für Handwerkermaschinen und für Haushaltsnähmaschinen geeignet.

Thin oil, suitable for modern high speed lockstitch machines as well as for domestic sewing machines.

BC-2533

Besonders dünnflüssiges Öl, geeignet zur Dochtschmierung von Greifern und Maschinenkopfteile.

Especially thin oil for wick lubrication of hooks and machine head parts.

BC-2535

Dickflüssiges Öl für Ölbadmaschinen älterer Bauart.

Thick oil for elderly sewing machines with oil tub lubrication.

BC-2549

Mittleres Öl, geeignet zur Getriebebeschmierung der meisten modernen Industrienähmaschinen.

Medium oil, suitable for gear lubrication of most modern industrial sewing machines.

28-011202-43

Schmierfett RETINAX, Tube à 500 g
Axle-grease RETINAX, tube of 500 g



Wichtig!

Bitte beachten Sie bei der Auswahl von Ölen unbedingt die Spezifikationen in den Bedienungsanleitungen des jeweiligen Nähmaschinenherstellers.

Important!

Please always refer to the service manual of the sewing machine manufacturer to choose the suitable oil for your machine.

Ölbehälter aus Kunststoff, ungefüllt
Plastic Oil Bottles, empty



Bemerkung <i>Remark</i>	Inhalt in Liter <i>Contents in litre</i>	Artikelnummer <i>Part No.</i>
Industrieöler, konische Form, mit Spritztülle <i>Industrial oiler, cone shape, with spout</i>	0,25	BC-2531
Ölflasche mit Schraubverschluß und Spritztülle <i>Plastic oil bottle with screw lid and spout</i>	1,00	BC-2531E

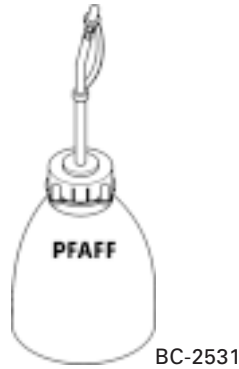

BC-2531



BC-2531E

Silikonöl für Fadenschmierung
Silicon Oil for thread lubrication



Inhalt in Liter <i>Contents in litre</i>	Artikelnummer <i>Part No.</i>
1,00	BC-2512
5,00	BC-2512A
10,00	BC-2512B
0,05	BC-2512D*

*Mindestbestellmenge = 25 Stück

*Minimum order quantity = 25 pc.



BC-2512



BC-2512D

Fadenöler
Thread Lubricating Box

BC-2513

Silikon-Fadenöler mit drei unterschiedlichen Befestigungsmöglichkeiten.

Thread lubrication box for silicone oil, with three different installation possibilities.

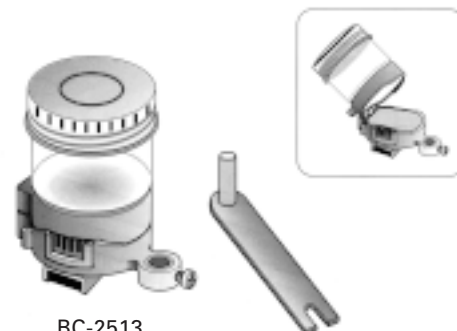

BC-2513

Sprays für Mechaniker *Sprays for mechanics*



Bemerkung <i>Remark</i>	Inhalt in ml <i>Contents in ml</i>	Artikelnummer <i>Part No.</i>
Harzlösespray <i>Gummed grease cleaner spray</i>	200	B41008
Rostlösespray <i>Rust cleaner spray</i>	150	B41009
Ölspray <i>Oil spray</i>	150	B41012
Schleifstein-Reinigungsspray <i>Sharpening stone cleaner spray</i>	400	BB-2216



B41008



BB-2216

Sprays für die Textilverarbeitung *Sprays for the sewing industry*



Bemerkung <i>Remark</i>	Inhalt in ml <i>Contents in ml</i>	Artikelnummer <i>Part No.</i>
Antistatik-Spray <i>Anti-static spray</i>	400	BB-2397
Silikon-Gleitspray <i>Silicone slide spray</i>	400	BB-2398
Kantenfestigerspray <i>Fabric edge sealer spray</i>	400	BB-2399
Teflon-Spray <i>Teflon spray</i>	400	BD-3482



BB-2397



BB-2398



BB-2399



BD-3482

5: VERBRAUCHSMATERIALIEN UND WERKZEUGE *CONSUMPTION ITEMS AND TOOLS*

5.2 TEFLONPRODUKTE *TEFLON PRODUCTS*

PTFE-Folie
PTFE Foil

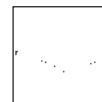

Bemerkung <i>Remark</i>	Länge x Breite x Stärke in mm <i>Length x Width x Thickness in mm</i>	Artikelnummer <i>Part No.</i>
einseitig geätzt, geeignet zur Verarbeitung mit Spezialkleber BD-4149 <i>one side cauterized, to be used with special glue BD-4149</i>		
zur Beschichtung flacher Teile, z.B. Stichplatten <i>for coating of flat parts like needle plates</i>	300 x 250 x 1,0	BD-4148
zur Beschichtung gebogener Teile, z.B. Nähfußsohlen <i>for coating of curved parts like presser foot soles</i>	300 x 250 x 0,5	BD-4148A
einseitig selbstklebend, zur direkten Verarbeitung ohne Spezialkleber <i>one side self-adhesive, to be used without special glue</i>		
zur Beschichtung gebogener Teile, z.B. Nähfußsohlen <i>for coating of curved parts like presser foot soles</i>	1000 x 50 x 0,5	BD-4148C

BD-4149

Spezialkleber für einseitig geätzte PTFE-Platten, Tube à 3 g
Special glue for PTFE plates with cauterized surface, tube à 3 g

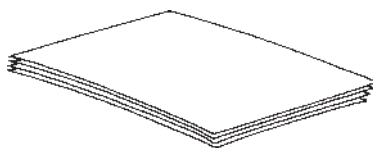

BD-4148
BD-4148A

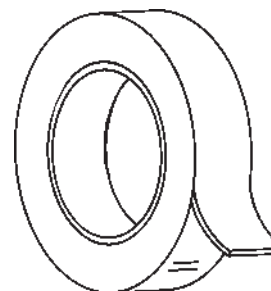

BD-4148C

PTFE-beschichtete Glasfaserfolie, selbstklebend
PTFE-coated Glas Fibre Foil, self-adhesive

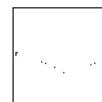

Bemerkung <i>Remark</i>	Länge x Breite x Stärke in mm <i>Length x Width x Thickness in mm</i>	Artikelnummer <i>Part No.</i>
großflächige Beschichtungen, z.B. von Nähtischplatten <i>for coating of large surfaces like sewing table tops</i>	1000 x 1000 x 0,15	BD-4148B

5: VERBRAUCHSMATERIALIEN UND WERKZEUGE *CONSUMPTION ITEMS AND TOOLS*

5.3 SCHLEIFMITTEL UND WERKZEUGE *GRINDING MATERIAL AND TOOLS*

Blasebalg *Bellow*



Bemerkung <i>Remark</i>	Artikelnummer <i>Part No.</i>
Größe 1 <i>Size 1</i>	BC-2454
Größe 2 <i>Size 2</i>	BC-2455
Größe 3 <i>Size 3</i>	BC-2456



BC-2455

Reinigungspinsel *Cleaning Brush*



Bemerkung <i>Remark</i>	Artikelnummer <i>Part No.</i>
mit Holzgriff <i>with wooden handle</i>	BC-2457



BC-2457

Pinzetten
Tweezer



Bemerkung Remark	Länge in mm Length in mm	Artikelnummer Part No.
gerade, glatte Flächen, selbstklemmend <i>straight, smooth surface, self grip version</i>	120	B32010
gerade, glatte Flächen <i>straight, smooth surface</i>	150	BB-2312
gebogene Spitze, Griffbereich und Spitze gerieft, mit Führungsstift <i>curved tip, grip section and tip serrated, with guide pin</i>	150	BB-2313
gerade, Griffbereich und Spitze gerieft, mit Einstreichdorn <i>straight, grip section and tip serrated, with pin end</i>	160	BB-2314
gerade, Griffbereich und Spitze gerieft, mit Hakenende <i>straight, grip section and tip serrated, with hook end</i>	130	BB-2314A
gebogene, breite Spitze, Griffbereich und Spitze gerieft <i>curved, broad tip, grip section and tip serrated</i>	150	BB-2315
gebogene Spitze, glatte Flächen <i>curved tip, smooth surface</i>	150	BB-2315A
stark gebogen, Griffbereich und Spitze gerieft <i>strongly curved, grip section and tip serrated</i>	130	BB-2316

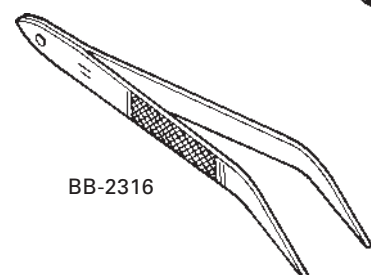
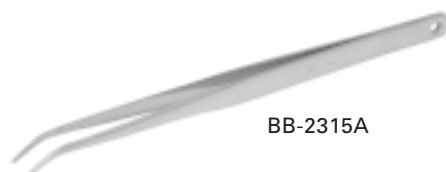
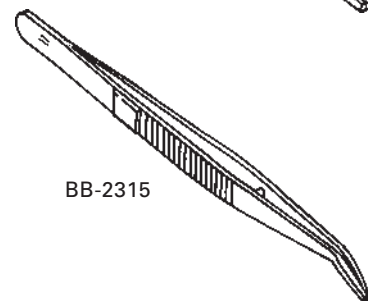
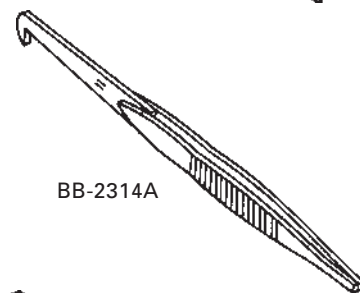
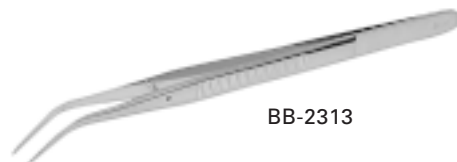
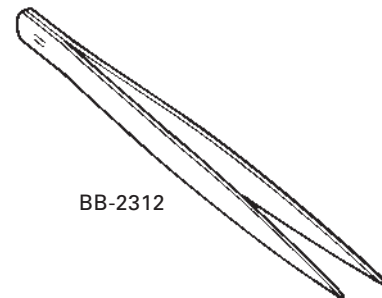

Maschinenzubehör-Schraubendreher Machine Accessory Screwdriver



Bemerkung Remark	Klingenlänge in mm Tip Length in mm	Klingenbreite in mm Blade Width in mm	Artikelnummer Part No.
Schraubendreher 250 mm, für Stichplattenschrauben Screwdriver 250 mm, for needle plate screws	150	5	BC-2458
Schraubendreher 100 mm für Nadelbefestigungsschrauben Screwdriver 100 mm for needle set screw	40	3	BC-2459
Schraubendreher 85 mm für Spulenkapfelschrauben Screwdriver 85 mm for bobbin case screws	40	2	BC-2459A



BC-2458



BC-2459



BC-2459A

Mechaniker-Schraubendreher mit langer Klinge Mechanic Screwdriver with long tip



Klingenlänge in mm Tip Length in mm	Klingenbreite in mm Blade Width in mm	Artikelnummer Part No.
100	3	BC-2581
200	3	BC-2582
300	3	BC-2583
300	4	BC-2584
300	5	BC-2585
300	6	BC-2586
300	8	BC-2587



BC-2581



BC-2582

Spezial-Schraubendreher
Special Screwdriver



Bemerkung Remark	Klingenlänge in mm Tip Length in mm	Klingenbreite in mm Blade Width in mm	Artikelnummer Part No.
Kurzschraubendreher 75 mm Screwdriver, short, 75 mm	25	6,5	BC-2596
Festhalte-Schraubendreher 320 mm Retain screwdriver 320 mm	225	5,5	BC-2597
Winkelschraubendreher Größe 5 90° shaped screwdriver size 5	125	5,5	BC-2615
Winkelschraubendreher Größe 8 90° shaped screwdriver size 8	40	8	BC-2616



BC-2597



BC-2596



BC-2616

Sechskant-Stiftschlüssel
Hexagonal Allen Keys



Bemerkung Remark	Klingenlänge in mm Tip Length in mm	Größe Size	Artikelnummer Part No.
Sechskant-Schraubendreher mit Griff, metrisch Hexagonal screwdriver with handle, metrical	50	1,5 mm	BC-2459B
Sechskant-Schraubendreher mit Griff, Zollmaß Hexagonal screwdriver with handle, inch	50	1/16"	BC-2459C
Sechskant-Stiftschlüsselsatz, metrisch, achteilig Hexagonal allen key set, metrical, eight pieces		2,0 - 10,0 mm	BC-2592
Sechskant-Stiftschlüsselsatz, Zollmaß, achteilig Hexagonal allen key set, inch, eight pieces		1/16" - 1/4"	BC-2593



BC-2459B



BC-2593

Sechskant-Steckschlüssel Hexagonal Wrenches



Bemerkung Remark	Länge in mm Length in mm	Größe Size	Artikelnummer Part No.
Sechskant-Steckschlüssel mit Griff, metrisches Maß <i>Hexagonal wrench with handle, metric size</i>	230	7 mm	BC-2588
Sechskant-Steckschlüssel mit Griff, metrisches Maß <i>Hexagonal wrench with handle, metric size</i>	230	8 mm	BC-2589
Sechskant-Steckschlüssel mit Griff, metrisches Maß <i>Hexagonal wrench with handle, metric size</i>	230	9 mm	BC-2589A
Sechskant-Steckschlüssel mit Griff, Zollmaß <i>Hexagonal wrench with handle, inch size</i>	210	3/8"	BC-2590
Sechskant-Steckschlüssel mit Griff, Zollmaß <i>Hexagonal wrench with handle, inch size</i>	210	1/4"	BC-2591
Nadelmutter Schlüssel für MERROW, RIMOLDI, SINGER <i>Needle nut wrench for MERROW, RIMOLDI, SINGER</i>	160	3/16"	B44-2

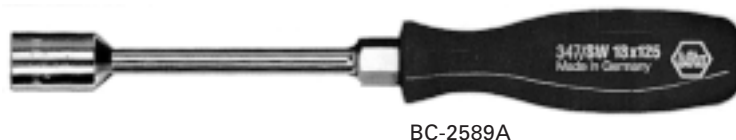
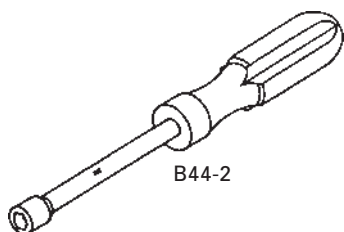

Diamant - Nadelfeilen Diamond Files



Bemerkung Remark	Artikelnummer Part No.
flachstumpf <i>flat hand</i>	BC-2602
flachspitz <i>flat pointed</i>	BC-2603
dreikant <i>three-edged</i>	BC-2604
vierkant <i>square</i>	BC-2605
halbrund <i>half-round</i>	BC-2606
rund <i>round</i>	BC-2607
Messerform <i>knife shaped</i>	BC-2607A
Vogelzungenform <i>lenticular cross section</i>	BC-2607B
Schwertform <i>feather-edge</i>	BC-2607C
Barettform <i>barette shape</i>	BC-2607D



Schleif- und Polierrundschnüre
Emery and Crocus Round Cords



Rolle à ca. 23 Meter <i>Roll of approx. 23 metre</i>		Schmirgelrundschnur <i>Round Emery Cord</i>		Polierrundschnur <i>Round Crocus Cords</i>	
Durchmesser in mm <i>Diameter in mm</i>	Körnung <i>Grit</i>	Referenz <i>Reference</i>	Artikelnummer <i>Part No.</i>	Referenz <i>Reference</i>	Artikelnummer <i>Part No.</i>
2,0	120	49	BC-2550		
1,8	180	50	BC-2551	50 C	BC-2557
1,4	120	51	BC-2552		
1,4	150	52	BC-2553	52 C	BC-2558
1,0	180	53	BC-2554	53 C	BC-2559
0,8	200	54	BC-2555	54 C	BC-2560
0,5	200	55	BC-2556	55 C	BC-2551
0,4	200	60	BC-2556E		
0,3	200	66	BC-2556F		



BC-2553

Schmirgel- und Polierband
Emery and Crocus Flat Tape



Rolle à ca. 23 Meter <i>Roll of approx. 23 metre</i>		Schmirgelband <i>Flat Emery Tape</i>		Polierband <i>Flat Crocus Tape</i>	
Breite in mm <i>Width in mm</i>	Körnung <i>Grit</i>	Referenz <i>Reference</i>	Artikelnummer <i>Part No.</i>	Referenz <i>Reference</i>	Artikelnummer <i>Part No.</i>
2,4	180	56	BC-2556A	56 C	BC-2561A
3,2	180	57	BC-2556B		
4,8	150	58	BC-2556C		
6,4	150	59	BC-2556D		

Schmirgel- und Polierleinen 220 x 280 mm Emery and Polishing Cloth 220 x 280 mm



Schmirgelleinen / Emery Cloth	
Korn Grit	Artikelnummer Part No.
50	BC-2548J
80	BC-2548
100	BC-2548A
120	BC-2548B
150	BC-2548C
180	BC-2548D
220	BC-2548E
240	BC-2548I
280	BC-2548F
320	BC-2548G
400	BC-2548H
Polierleinen / Polishing Cloth	
999+	BC-2548K

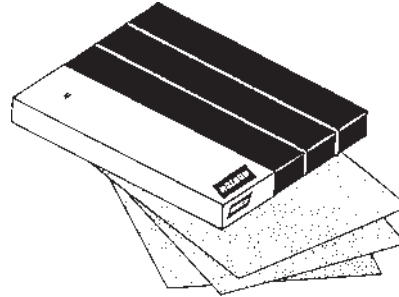

Scheren- und Messerschleifmaschinen Scissors and Knife Grinding Machines



Bemerkung Remark	Artikelnummer Part No.
Scherenschleifmaschine Modell 111 <i>Scissors Grinding Machine Type 111</i>	BC-2619m
Messerschleifmaschine Modell 90 <i>Knife Grinding Machine Type 90</i>	BD-2619Am



BC-2619m

BD-2619Am



Schleifmaschinenzubehör
Grinding Machine Accessories



Bemerkung <i>Remark</i>	Durchmesser in mm <i>Diametre in mm</i>	Artikelnummer <i>Part No.</i>
für Messerschleifmaschine Modell 90 for Knife Grinding Machine Type 90		
Topfschleifstein für universelle Schleifarbeiten <i>Cup grinding wheel for universal grinding application</i>	100	B51/2m
Topfschleifstein zum Vorschleifen von Hartmetall <i>Cup grinding wheel for pre-grinding of carbide metal</i>	100	B51/4m
für Scherenschleifmaschine Modell 111 for Scissors Grinding Machine Type 111		
Schleifstein zum Scherenschleifen <i>Flat grinding wheel for scissors grinding</i>	125	B52/11m
Abziehscheibe <i>Dressing wheel</i>	125	B69/3m

Einstellehren
Adjusting Gauges



Artikelbezeichnung <i>Item description</i>	Artikelnummer <i>Item-no.</i>
Schlingenhub-Fächerlehre mit Messblattstärke 1,6 / 1,8 / 2,0 / 2,2 / 2,4 mm <i>Adjusting Gauge for needle rise, gauge blade thickness 1,6 / 1,8 / 2,0 / 2,2 / 2,4 mm</i>	B600
Befestigungszwinge für Schlingenhublehre <i>Clamp for needle rise adjusting gauge</i>	B600-35
Transporteureinstellung-Fächerlehre mit Messblattstärke 0,6 / 1,0 / 1,3 / 1,8 mm <i>Adjusting Gauge for feed dogs, gauge blade thickness 0,6 / 1,0 / 1,3 / 1,8 mm</i>	B639
Transporteureinstellung-Fächerlehre mit Messblattstärke 1,3 / 2,0 mm <i>Adjusting Gauge for feed dogs, gauge blade thickness 1,3 / 2,0 mm</i>	B642
Kettenstichgreifereinstellung-Fächerlehre mit Messblattstärke 2,0 / 2,5 / 3,2 / 3,6 / 4,2 / 4,6 / 5,0 mm <i>Adjusting Gauge for loopers, gauge blade thickness 2,0 / 2,5 / 3,2 / 3,6 / 4,2 / 4,6 / 5,0 mm</i>	B643



B600



B600-35



B639



B642



B643

6: NADELN *NEEDLES*

6.0 NADELN ZUR LEDERVERARBEITUNG *NEEDLES FOR STITCHING LEATHER*

Schneidspitzen *Cutting points*



Sie können jetzt auf drei weitere Dateien zugreifen und nach dem passenden Nadelsystem für Ihre Nähmaschine suchen.

Klicken Sie einfach auf die zutreffende Suchmöglichkeit.

1. Suche über die Nähmaschinenklasse
2. Suche über das Nadelsystem
3. Suche nach der PFAFF-Bestellnummer

Schneidspitzen Cutting points

Auswahl der Nadeldicke

Die Stepptechnik und die Wahl des Garns bestimmen die Nadeldicke. Zwei wesentliche Kriterien sind zu beachten:

- 1. Nähfaden/Nahtbild**
Nähfadenstärke und gewünschtes Nahtbild bestimmen die Nadeldicke.
- 2. Material und Materialbeschaffenheit**
Je dicker und härter das Material ist, desto dicker muß auch die Nadel sein.

Schmetz Hinweis:

Die Tabellen beinhalten nur die gängigsten Nähfäden. Baumwollnähfäden, Nähseide und Stickgarne bleiben aufgrund der Übersicht in dieser Tabelle unberücksichtigt.

Wenn Sie spezielle Fragen zu diesen Nähfäden haben, wenden Sie sich bitte an Ihren Garnhersteller.

* No = Etikettennummer
tex = Feinheitsbezeichnung
1 g/1000 m (z.B. 75 tex = 1000 m Garn wiegen 75 g)

Stepptechnik	Endlosfilament							
	Polyamid 6.6 (Nylon)				Polyester			
	Garnfeinheit No*	tex*	Nadeldicke NM	SIZE	Garnfeinheit No*	tex*	Nadeldicke NM	SIZE
Grobe Ziernähte	4	750	280/330	28-30	4	750	250-300	27-29
	5	600	250-300	27-29	5	600	250-280	27-28
	6	500	230-250	26-27	6	500	230-250	26-27
	7	429	230-250	26-27	7	429	200-230	25-26
	8/9	375/333	200-250	25-27	8/9	375/333	180-200	24-25
Steppnähte Grob	10/11	300/273	160-230	23-26	10/11	300/273	140-180	22-24
	12	250	160-230	23-26	12	250	140-180	22-24
	13	231	160-200	23-25	13/14	231/214	130-160	21-23
	15	200	160-180	23-24	15	200	125-140	20-22
	18	167	120-130	19-21	20	150	110-130	18-21
Mittel	20	150	120-160	19-23	24/25	125/120	100-110	16-18
	24/25	125/120	100-110	16-18	30	100	100-110	16-18
	30	100	100-140	16-22	35/36	86/83	110-120	18-19
	40	75	100-120	16-19	40	75	100-110	16-18
	50	60	90-100	14-16	60	50	80-90	12-14
Spann-/ Bestech- nähte	60	50	80-100	12-16	70	43	75-80	11-12
	80/90	38/33	70-90	10-14	80/90	38/33	70-80	10-12
	40	75	100-120	16-19	40	75	100-110	16-18
	60	50	80-100	12-16	60	50	80-90	12-14
	80/90	38/33	70-90	10-14	80/90	38/33	70-80	10-12
				100	30	65-70	9-10	

Stepptechnik	core-spun							
	Polyester/Baumwolle				Polyester/Polyester			
	Garnfeinheit No*	tex*	Nadeldicke NM	SIZE	Garnfeinheit No*	tex*	Nadeldicke NM	SIZE
Grobe Ziernähte	4	750	230-280	26-28				
	5	600	180-250	24-27				
	6	500	180-200	24-25				
	8	375	180-200	24-25	8	375	160-200	23-25
	12	250	160-180	23-24	12	250	140-180	22-24
Steppnähte Grob	15	200	140-160	22-23				
	20	150	140-160	22-23	20	150	120-160	19-23
	24	125	130-160	21-23				
	25	120	120-140	19-22	25	120	110-140	18-22
	28	107	120-140	19-22				
Mittel	30	100	120-140	19-22	30	100	110-130	18-21
	35/36	86/83	110-130	18-21	35/36	86/83	100-120	16-19
	40	75	100-120	16-19	40	75	100-110	16-18
	50	60	100-110	16-18	50	60	90-100	14-16
	60/75	50/40	90-100	14-16	60/75	50/40	90-100	14-16
Spann-/ Bestech- nähte	80	38	90-100	14-16	80	38	80-90	12-14
	90	33	80-90	12-14				
	100	30	80-90	12-14	100	30	70-90	10-14
	40	75	100-120	16-19	40	75	100-110	16-18
	60/75	50/40	90-100	14-16	60/75	50/40	90-100	14-16
				80	38	80-90	12-14	

Schneidspitzen Cutting points

Auswahl der Spitzenform

Die Verarbeitungstechnik bzw. das gewünschte Nahtbild bestimmen die Spitzenform.

Einfädeldrichtung:
von links nach rechts

Verarbeitungstechnik	Nahtbild	Spitzenform
Nähte mit hoher Festigkeit Feine Ziernähte		P Perlspitze PCL Perlspitze links-cordiert PCR Perlspitze rechts-cordiert
Normale Steppnähte Grobziernähte Sehr gerade Nähte		S Spatenspitze DI Diamantspitze
Dekorationsnähte (Zier-/Absteppnähte)		LR Lederrechtsspitze VR Vierschlifffspitze – rechts schneidend LBR Sehr breite Lederrechtsspitze
Sehr gerade Nähte		LL Lederlinksspitze
Grob-/Steppnähte Quernähte		D Dreikantspitze DH Halbe Dreikantspitze
Stickereien Besonderheiten, z.B. Applikationen		SUK Mittlere Kugelspitze R Normale Rundspitze SD1 Rundspitze mit kleiner Dreikantschneide
Multidirektionale Nähte		SD1 Rundspitze mit kleiner Dreikantschneide
Materialkombinationen, Verbundstoffe – Bekleidung		R Normale Rundspitze SD1 Rundspitze mit kleiner Dreikantschneide
– Technischer Bereich		D Dreikantspitze DH Halbe Dreikantspitze

Schneidspitzen
Cutting points

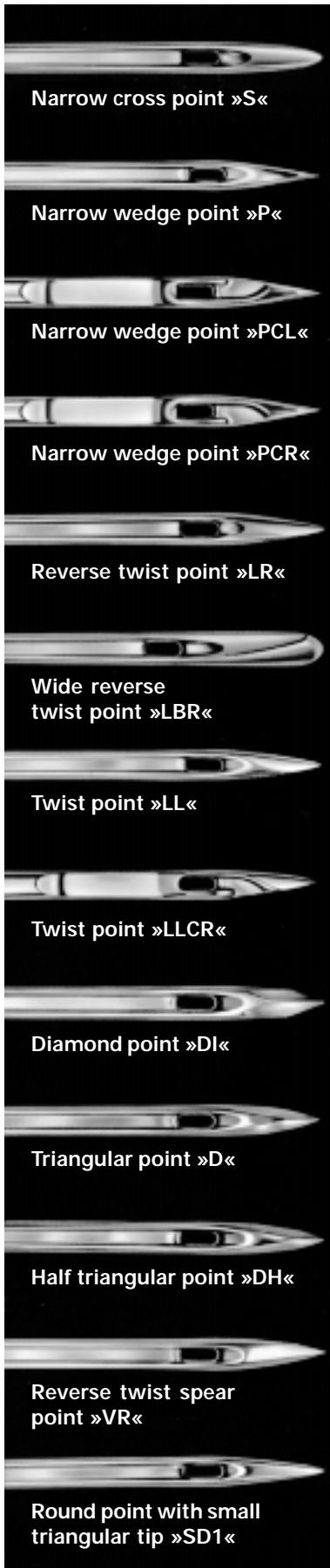

Now you can access three further files to search the suitable needle system for your sewing machine.

Just click one of the possibilities mentioned below.

1. *Search by sewing machine class*
2. *Search by needle system*
3. *Search the PFAFF order number*

Schneidspitzen Cutting points

The right needle size

The stitching technique and the choice of thread determine the needle size.

Two essential criteria must be taken into account:

1. Thread/ seam appearance

The needle size is determined by the thickness of the thread and the desired seam appearance.

2. Material and material properties

The harder and thicker the material, the thicker the needle must be.

Schmetz tip:

These tables only include the most common threads. Cotton threads, sewing silk and embroidery yarn have been omitted for the sake of clarity.

If you have specific questions concerning these threads, please ask your thread manufacturer.

* No = Label number
tex = Unit of size 1 g/1000 m
(e.g. 75 tex = 1000 m yarn weigh 75 g)









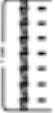
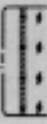
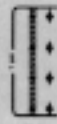

Continuous filament								
Stitching technique	Polyamide 6.6 (Nylon)				Polyester			
	Yarn size		Needle size		Yarn size		Needle size	
	No*	tex*	NM	SIZE	No*	tex*	NM	SIZE
Coarse decorative seams	4	750	280/330	28-30	4	750	250-300	27-29
	5	600	250-300	27-29	5	600	250-280	27-28
	6	500	230-250	26-27	6	500	230-250	26-27
	7	429	230-250	26-27	7	429	200-230	25-26
	8/9	375/333	200-250	25-27	8/9	375/333	180-200	24-25
	10/11	300/273	160-230	23-26	10/11	300/273	140-180	22-24
Coarse seams	12	250	160-230	23-26	12	250	140-180	22-24
	13	231	160-200	23-25	13/14	231/214	130-160	21-23
	15	200	160-180	23-24	15	200	125-140	20-22
	18	167	120-160	19-23	18	167	120-130	19-21
	20	150	120-160	19-23	20	150	110-130	18-21
	24/25	125/120	100-140	16-22	24/25	125/120	100-110	16-18
Medium seams	30	100	100-140	16-22	30	100	100-110	16-18
	35/36	86/83	100-120	16-19	35/36	86/83	110-120	18-19
	40	75	100-120	16-19	40	75	100-110	16-18
	50	60	80-100	12-16	50	60	90-100	14-16
	60	50	80-100	12-16	60	50	80-90	12-14
	70	43	70-90	10-14	70	43	75-80	11-12
Stay seams (heel seams)	80/90	38/33	70-90	10-14	80/90	38/33	70-80	10-12
	40	75	100-120	16-19	40	75	100-110	16-18
	60	50	80-100	12-16	60	50	80-90	12-14
	80/90	38/33	70-90	10-14	80/90	38/33	70-80	10-12
	100	30	65-70	9-10				

core-spun								
Stitching technique	Polyester/Cotton				Polyester/Polyester			
	Yarn size		Needle size		Yarn size		Needle size	
	No*	tex*	NM	SIZE	No*	tex*	NM	SIZE
Coarse decorative seams	4	750	230-280	26-28				
	5	600	180-250	24-27				
	6	500	180-200	24-25				
	8	375	180-200	24-25	8	375	160-200	23-25
	12	250	160-180	23-24	12	250	140-180	22-24
Coarse seams	15	200	140-160	22-23				
	20	150	140-160	22-23	20	150	120-160	19-23
	24	125	130-160	21-23				
	25	120	120-140	19-22	25	120	110-140	18-22
	28	107	120-140	19-22				
	30	100	120-140	19-22	30	100	110-130	18-21
	35/36	86/83	110-130	18-21	35/36	86/83	100-120	16-19
Medium seams	40	75	100-120	16-19	40	75	100-110	16-18
	50	60	100-110	16-18	50	60	90-100	14-16
	60/75	50/40	90-100	14-16	60/75	50/40	90-100	14-16
	80	38	90-100	14-16	80	38	80-90	12-14
	90	33	80-90	12-14				
	100	30	80-90	12-14	100	30	70-90	10-14
Stay seams (heel seams)	40	75	100-120	16-19	40	75	100-110	16-18
	60/75	50/40	90-100	14-16	60/75	50/40	90-100	14-16
	80	38	90-100	14-16	80	38	80-90	12-14

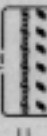
Schneidspitzen
Cutting points

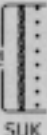
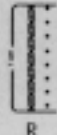
Choosing the point form

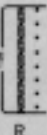
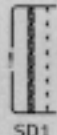
The point form is determined by the stitching technique and the desired seam appearance. Needle threading from left to right.

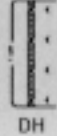
Stitching technique	Seam appearance	Point form
Very strong seams Fine ornamental seams		P Narrow wedge point PCL Narrow wedge point with left twist groove below eye PCR Narrow wedge point with right twist groove below eye
Normal seams Coarse ornamental seams Very straight seams	 	S Narrow cross point DI Diamond point
Decorative seams (ornamental seams/normal seams)	  	LR Reverse twist point VR Reverse twist spear point LBR Wide reverse twist point
Very straight seams		LL Twist point
Coarse/normal seams Cross seams	 	D Triangular point DH Half triangular point
Embroidery Special features, e.g. ornamentations	  	SUK Medium ball point R Normal round point SD1 Round point with small triangular tip
Multidirectional sewing		SD1 Round point with small triangular tip
Material combinations, composites: - Garments - Industrial sector	   	R Normal round point SD1 Round point with small triangular tip D Triangular point DH Half triangular point

6: NADELN *NEEDLES*

6.1 NADELN ZUR TEXTILVERARBEITUNG *NEEDLES FOR STITCHING TEXTILES*

Rundspitzen
Round points

Sie können jetzt auf drei weitere Dateien zugreifen und nach dem passenden Nadelsystem für Ihre Nähmaschine suchen.

Klicken Sie einfach auf die zutreffende Suchmöglichkeit.

1. Suche über die Nähmaschinenklasse
2. Suche über das Nadelsystem
3. Suche nach der PFAFF-Bestellnummer

Rundspitzen
Round points

Material		Nadeldicke NM	SIZE	Spitzenform		
Gewebe	Leicht (Hemden-/Blusenstoff)	65-75	9-11	R		
	Mittel (Kostüm-/Anzugstoff)	80-90	12-14	SES		
	Schwer (Mantelstoff, Bezugsstoffe)	100-110	16-18	SES		
	Jeans	Leicht	70-90	10-14	SES	
		Mittel	100-110	16-18	SUK	
		Schwer	110-140	18-22	SES	
	Dicht gewebte Materialien	Leicht (z.B. Microfaser, Seide, Kunstseide)	65-70	9-10	SES	Minimierung der Materialbeschädigung
			65-70	9-10	SPI	Minimierung des Nahtkräuselns
		Mittel (z.B. Zeltplanen, Planen)	100-180	16-24	SPI	
		Schwer	200-330	25-30	SPI	
Maschenware	Fein	60	8	SUK		
	Mittel	65-75	9-11	SES		
	Grob	75-90	11-14	SUK		
	Sehr grob	75-90	11-14	SKF		
Elastische Materialien						
z.B. hochelastische Gewirke bzw. Gewirke mit umspinnenen Elastomerefäden (Elastan, Lyrca etc.)						
	Fein	65-70	9-10	SKF		
	Mittel (insbesondere Bandagen)	80-90	12-14	SKL		
	Grob	80-90	12-14	SKL		
	Nicht umspinnene Elastomerefäden (z.B. Hosenbundgummi)	65-90	9-14	SPI	Minimierung des Herausbrückens der Elastomerefäden	
Verbundmaterialien						
Gewebe/Maschenware im Verbund mit Einlage (z.B. Oberhemdenfertigung [Manschetten-, Kragensteppnähte])						
		65-80	9-12	SPI		
Beschichtete Materialien als Verbundmaterial mit Gewebe/Maschenware (z.B. Goretex, Sympatex, Helsapor)						
	Fein	65-70	9-10	SPI		
	Mittel	80-90	12-14	SPI		
	Grob	80-90	12-14	SPI		
Kaschierte Materialien						
Textil/Textil (z.B. Autositzbezüge, Surf- und Tauchanzüge)						
		80-110	12-18	SES		
Textil/Pappe, Textil/Kunststoff, Sehr feste Pappe/Kunststoff (z.B. Befestigungsschienen Autositz)						
		100-140	16-22	R		
		100-140	16-22	SD1	Für Sicherheit und sicheres Verriegeln	
		80-130	12-21	DH	Für eine schöne Naht	
Beschichtete Materialien (z.B. Planen)						
	Mittel	100-180	16-24	SPI		
	Schwer	200-330	25-30	SPI		
		200-330	25-30	SD1		
Folien		65-90	9-14	R		
Materialkombinationen						
	Leder mit Textil	80-100	12-16	R		
Konfektionieren von Pelzen und Fellen		80-100	12-16	R		

Rundspitzen
Round points**Auswahl der Nadeldicke:**

Neben Material und Materialbeschaffenheit ist auch die Wahl des Garns bestimmend für die Nadeldicke:

Endlosfilament								
Garntyp	Polyamid 6.6 (Nylon)				Polyester			
	Garnfeinheit		Nadeldicke		Garnfeinheit		Nadeldicke	
	No*	tex*	NM	SIZE	No*	tex*	NM	SIZE
Grob	13	231	160-200	23-25	13	231	130-160	21-23
					14	214	130-140	21-22
	15	200	160-180	23-24	15	200	120-140	19-22
					18	167	120-130	19-21
	20	150	120-160	19-23	20	150	110-130	18-21
				24/25	125/120	110-130	18-21	
	30	100	100-140	16-22	30	100	110-120	18-19
					35/36	86/83	100-110	16-18
Mittel	40	75	90-120	14-19	40	75	90-100	14-16
					50	60	80-90	12-14
	60/70	50/43	80-100	12-16	60/70	50/43	70-80	10-12
	80	38	70-90	10-14	80	38	65-80	9-12
	90	33	65-90	9-14	90	33	60-80	8-12
Fein					100	30		
	120	25	70-80	10-12	120	25	60-80	8-12
	180	17	70-80	10-12	180	17	65-70	9-10
					200	15	60-65	8-9
					250	12	55-60	6-9
				360	8	50-55	5-6	

SCHMETZ Hinweis:

Die Tabellen beinhalten nur die gängigsten Nähfäden und Baumwollnähfäden.

Nähseide und Stickgarne bleiben aufgrund der Übersichtlichkeit in dieser Tabelle unberücksichtigt.

Wenn Sie spezielle Fragen zu diesen Garnen/Nähfäden haben, wenden Sie sich bitte an Ihren Garnhersteller.

Core Spun								
Garntyp	Polyester/Baumwolle				Polyester/Polyester			
	Garnfeinheit		Nadeldicke		Garnfeinheit		Nadeldicke	
	No*	tex*	NM	SIZE	No*	tex*	NM	SIZE
Grob	15	200	140-160	22-23				
	20	150	130-160	21-23	20	150	120-140	19-22
	24	125	130-160	21-23	25	120	110-130	18-21
	25	120	130-160	21-23				
	28	107	130-160	21-23				
	30	100	120-140	19-22	30	100	110-130	18-21
	35/36	86/83	110-130	18-21	35/36	86/83	110-120	18-19
Mittel	40	75	100-120	16-19	40	75	90-110	14-18
	50	60	100-120	16-19	50	60	90-100	14-16
	60	50	100-110	16-18	60/70	50	90-100	14-16
	75	40	90-100	14-16	80	40	70-90	10-14
	80/90	38/33	80-90	12-14	90	38/33	65-80	9-12
Fein	100	30	70-90	10-14	100	30	70-80	10-12
	120	25	70-80	10-12	120	25	70-80	10-12
					140	21	60-70	8-10
	150/160	20/19	65-70	9-10	150/160	20/19	50-60	5-8
	180	17	50-65	5-9	180	17	50-60	5-8

* No = Etikettennummer

tex = Feinheitsbezeichnung
1 g/1000 m (z.B. 17 tex =
1000 m Garn wiegen 17 g)

Rundspitzen
Round points

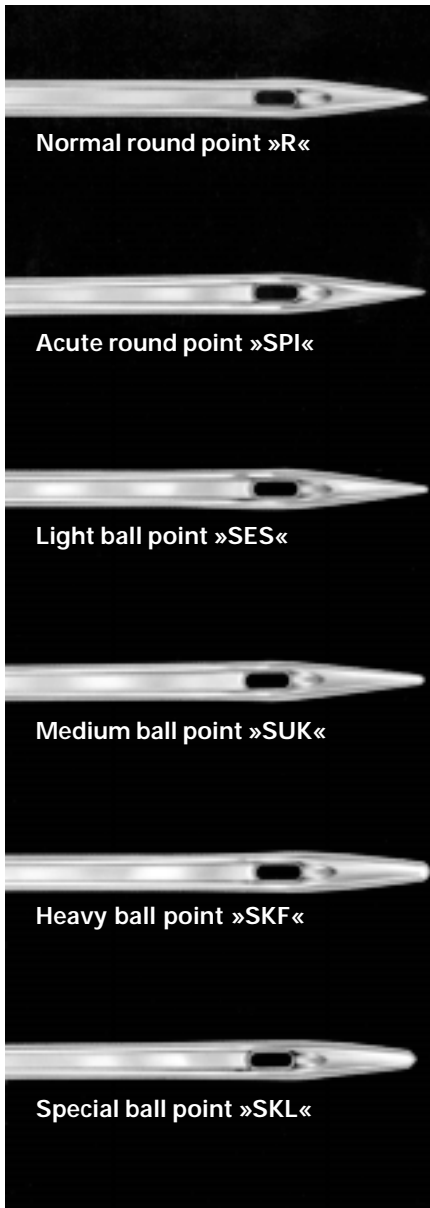

Now you can access three further files to search the suitable needle system for your sewing machine.

Just click one of the possibilities mentioned below.

- 1. Search by sewing machine class*
- 2. Search by needle system*
- 3. Search the PFAFF order number*

6.1

Rundspitzen Round points

Material		Needle Size		Point form		
		NM	SIZE			
Woven fabric	Light (Shirt/blouse material)	65-75	9-11	R		
	Medium (Suit material)	80-90	12-14	SES		
	Heavy (Coat material, covering material)	100-110	16-18	SES		
	Denim	Light	70-90	10-14	SES	
		Medium	100-110	16-18	SUK	
		Heavy	110-140	18-22	SES	
	Very densely woven materials	Light (e.g. microfibres, silk, artificial silk)	65-70	9-10	SES	to prevent material damage
			65-70	9-10	SPI	to prevent seam puckering
		Medium (e.g. tarpaulins)	100-180	16-24	SPI	
		Heavy	200-330	25-30	SPI	
Knitwear	Fine	60	8	SUK		
	Medium	65-75	9-11	SES		
	Coarse	75-90	11-14	SUK		
	Very coarse	75-90	11-14	SKF		
Elastic materials						
E.g. highly elastic knitted fabrics and knitted fabrics with covered elastomeric threads (Elastan, Lycra etc.)						
	Fine	65-70	9-10	SKF		
	Medium (particularly bandages)	80-90	12-14	SKL		
	Coarse	80-90	12-14	SKL		
	Non-covered elastomeric threads (e.g. elastic for waistbands)	65-90	9-14	SPI	to prevent the elastomeric threads being pushed out	
Composite materials						
	Woven fabrics/knitwear combined with an inlay (e.g. shirt manufacture [seams for cuffs, collars])	65-80	9-12	SPI		
	Coated materials combined with woven fabrics/knitwear (e.g. Goretex, Sympatex, Helsapor)					
	Fine	65-70	9-10	SPI		
	Medium	80-90	12-14	SPI		
	Coarse	80-90	12-14	SPI		
Laminated materials						
	Textile/textile (e.g. car seat covers, wetsuits and diving suits)	80-110	12-18	SES		
	Textile/cardboard, textile/plastic, very rigid cardboard/plastic (e.g. car seat tracks)	100-140	16-22	R		
		100-140	16-22	SD1	for safety and reliable locking	
		80-130	12-21	DH	for an attractive seam	
	Coated materials (e.g. tarpaulins)	100-180	16-24	SPI		
	Medium	200-330	25-30	SPI		
	Heavy	200-330	25-30	SD1		
Films		65-90	9-14	R		
Material combinations						
	Leather with textile	80-100	12-16	R		
Manufacture of furs and skins		80-100	12-16	R		

Rundspitzen
Round points

The right needle size

In addition to material and material properties, the choice of thread also determines the right needle size:

Schmetz Tip:

These tables only include the most common threads. Cotton threads, sewing silk and embroidery yarn have been omitted for the sake of clarity. If you have specific questions concerning these threads, please ask your thread manufacturer.

Continuous filament

Thread type	Polyamide 6.6 (Nylon)				Polyester			
	Yarn size		Needle size		Yarn size		Needle size	
	No*	tex*	NM	SIZE	No*	tex*	NM	SIZE
Coarse	13	231	160-200	23-25	13	231	130-160	21-23
					14	214	130-140	21-22
	15	200	160-180	23-24	15	200	120-140	19-22
					18	167	120-130	19-21
	20	150	120-160	19-23	20	150	110-130	18-21
				24/25	125/120	110-130	18-21	
	30	100	100-140	16-22	30	100	110-120	18-19
					35/36	86/83	100-110	16-18
Medium	40	75	90-120	14-19	40	75	90-100	14-16
					50	60	80-90	12-14
	60/70	50/43	80-100	12-16	60/70	50/43	70-80	10-12
	80	38	70-90	10-14	80	38	60-80	10-12
	90	33	65-90	9-14	90	33	60-80	8-12
Fine					100	30		
	120	25	70-80	10-12	120	25	60-80	8-12
	180	17	70-80	10-12	180	17	65-70	9-10
					200	15	60-65	8-9
					250	12	55-60	6-9
					360	8	50-55	5-6

core-spun

Thread type	Polyester/Cotton				Polyester/Polyester			
	Yarn size		Needle size		Yarn size		Needle size	
	No*	tex*	NM	SIZE	No*	tex*	NM	SIZE
Coarse	15	200	140-160	22-23				
	20	150	130-160	21-23	20	150	120-140	19-22
	24	125	130-160	21-23	25	120	110-130	18-21
	25	120	130-160	21-23				
	28	107	130-160	21-23				
	30	100	120-140	19-22	30	100	110-130	18-21
	35/36	86/83	110-130	18-21	35/36	86/83	110-120	18-19
Medium	40	75	100-120	16-19	40	75	90-110	14-18
	50	60	100-120	16-19	50	60	90-100	14-16
	60	50	100-110	16-18	60/70	50	90-100	14-16
	75	40	90-100	14-16	80	40	70-90	10-14
	80/90	38/33	80-90	12-14	90	38/33	65-80	9-12
Fine	100	30	70-90	10-14	100	30	70-80	10-12
	120	25	70-80	10-12	120	25	70-80	10-12
					140	21	60-70	8-10
	150/160	20/19	65-70	9-10	150/160	20/19	50-60	5-8
	180	17	50-65	5-9	180	17	50-60	5-8

* No = Label number
tex = Unit of size 1 g/1000 m
(e.g. 17 tex = 1000 m yarn weigh 17 g)

7: VERSCHLEISSTEILE *HIGH MORTALITY PARTS*

7.0 PFAFF STEPPSTICHMASCHINEN *PFAFF LOCKSTITCH MACHINES*

335 G-17/01-650/03 BLN (ohne Einfasser / *without binder*)

 <p>Stoffschiebefuß <i>Vibrating presser foot</i> 91-040 629-93/006</p>	 <p>Stoffdrückerfuß <i>Presser foot</i> 91-040 432-04/005</p>	 <p>Stoffschieber <i>Feed dog</i> 91-046 497-04/002</p>	 <p>Nadelstange <i>Needle bar</i> 91-710 650-92</p>
 <p>Stichplatte <i>Needle plate</i> 91-046 498-04/002</p>	 <p>Greifer <i>Hook</i> 91-060 581-91</p>	 <p>Spulenkapsel <i>Bobbin case</i> 91-174 955-91</p>	 <p>Spule <i>Bobbin</i> 91-174 480-05</p>
 <p>Bremsfeder <i>Break spring</i> 91-175 690-05</p>	 <p>Fadenanzugsfeder <i>Thread check spring</i> 91-010 023-05</p>	 <p>Reibring <i>Friction Ring</i> 99-137 151-45</p>	 <p>Biegefeder z. Spuler <i>Spring for bobbin winder</i> 91-171 049-05</p>
<p>Passende Bändeinfasser zu dieser Maschine sind unter der Nr. 91-040452-23/...erhältlich (Bitte benötigte Abmessungen angeben)</p> <p><i>Suitable tape binders for this machine are available under n° 91-040452-23/... (Please mention required measures)</i></p>			

Befestigungsschrauben für:
Retaining screws for:

Stoffschiebefuß <i>Vibrating presser foot</i> 91-000 085-15	Stoffschieber <i>Feed dog</i> 91-000 338-15	Nadel <i>Needle</i> 91-173 664-15	Stichplatte <i>Needle plate</i> 91-000 277-25
Stoffdrückerfuß <i>Presser foot</i> 91-100 366-15			

422

-6/01-650/01 AS x3,2-12,0

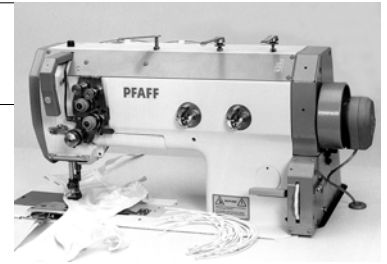

Nähwerkzeuge auf Anfrage
(abhängig vom Nadelabstand)

*Gauge sets on request
(depends on the needle gauge)*



Rohr zur Nadelstange
Needle bar tube
91-177 357-45



Klemmring
Clamp collar
91-118 196-12



Greifer
Hook
91-166 733-91



Spulenkapsel
Bobbin case
91-162 632-91

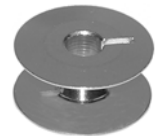

Spule
Bobbin
91-118 308-05



Bremsfeder
Break spring
91-175 690-05
91-176 321-05



Fadenanzugsfeder
Thread check spring
91-176 329-05



Reibring
Friction Ring
99-137 151-45



Biegefeder z. Spuler
Spring for bobbin winder
91-171 049-05

Befestigungsschrauben für:
Retaining screws for:

Nähfuß Sewing foot 11-108 174-15	Stoffschieber Feed dog 11-108 174-15	Nadel Needle 11-330 082-15 11-330 085-15	Stichplatte Needle plate 91-700 173-15

441

-900/61 BLN 2,5

441

-900/61-910/15 BLN 2,5

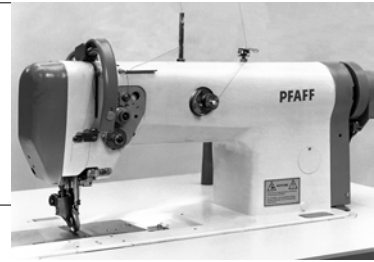

 <p>Rollfuß <i>Roller presser</i> 91-119 787-93/001</p>	 <p>Schiebrad <i>Feed wheel</i> 91-119 546-05</p>	 <p>Stichplatte <i>Needle plate</i> 91-158 808-04/003</p>	 <p>Nadelstange <i>Needle bar</i> 91-175 110-91</p>
 <p>Greifer <i>Hook</i> 91-173 240-91</p>	 <p>Spulenkapsel <i>Bobbin case</i> 91-113 192-91</p>	 <p>Spule <i>Bobbin</i> 91-118 308-05</p>	 <p>Bremsfeder <i>Break spring</i> 91-019 891-05</p>
 <p>Fadenanzugsfeder <i>Thread check spring</i> 91-010 023-05</p>	 <p>Fänger <i>Thread catcher</i> 91-176 093-05</p>	 <p>Messer <i>Knife</i> 91-186 659-05</p>	 <p>Reibring <i>Friction Ring</i> 99-137 151-45</p>
 <p>Biegefeder z. Spuler <i>Spring for bobbin winder</i> 91-171 049-05</p>			

Befestigungsschrauben für:
Retaining screws for:

<p>Fänger <i>Thread catcher</i> 11-132 172-15</p>	<p>Messer <i>Knife</i> 11-130 092-15</p>	<p>Nadel <i>Needle</i> 11-173 664-15</p>	<p>Stichplatte <i>Needle plate</i> 91-100 296-25</p>
<p>Rollfuß <i>Roller presser</i> 11-178 172-15</p>			

471

-725/04 BL x 1,2 ohne / without Mini-Stop



 <p>Rollfuß (Standard) Roller presser (standard) 91-119 787-93/001</p>	 <p>Schiebrad Feed wheel 91-119 136-05</p>	 <p>Stichplatte Needle plate 91-150 337-93/001</p>	 <p>Nadelstange Needle bar 91-175 095-91</p>
 <p>Greifer Hook 91-119 386-91</p>	 <p>Spulenkapsel Bobbin case 91-010 159-91</p>	 <p>Spule Bobbin 91-118 308-05</p>	 <p>Fadenanzugsfeder Thread check spring 91-010 023-05</p>
 <p>Reibring Friction Ring 99-137 151-45</p>	 <p>Biegefeder z. Spuler Spring for bobbin winder 91-171 049-05</p>		

Befestigungsschrauben für:
Retaining screws for:

<p>Rollfuß Roller presser 11-178 172-15</p>	<p>Nadel Needle 91-173 664-15</p>	<p>Stichplatte Needle plate 91-100 296-25</p>	

471

-725/04-900/53 BL x 1,2 mit / with Mini-Stop



 <p>Rollfuß (Standard) Roller presser 91-119 787-93/001</p>	 <p>Schieberad Feed wheel 91-119 136-05</p>	 <p>Stichplatte Needle plate 91-150 606-93/001</p>	 <p>Nadelstange Needle bar 91-175 095-91</p>
 <p>Greifer Hook 91-119 385-91</p>	 <p>Spulenkapsel Bobbin case 91-119 459-91</p>	 <p>Spule Bobbin 91-118 308-05</p>	 <p>Fadenanzugsfeder Thread check spring 91-010 023-05</p>
 <p>Schere Trimmer 91-164 672-91</p>	 <p>Reibring Friction Ring 99-137 151-45</p>	 <p>Biegefeder z. Spuler Spring for bobbin winder 91-171 049-05</p>	

Befestigungsschrauben für: Retaining screws for:

<p>Rollfuß Roller presser 11-178 172-15</p>	<p>Nadel Needle 91-173 664-15</p>	<p>Stichplatte Needle plate 91-100 296-25</p>	

481-G

-8/01-900/51 BS
-8/01-900/51-911/97 BS
-8/01-900/51 BS
-8/01-900/99 BS

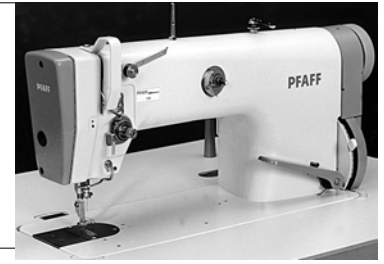

 Nähfuß Sewing foot 483-G-8/01 91-155 599-21	 Stoffschieber Feed dog 483-G-8/01 91-059 392-05	 Stichplatte Needle plate 483-G-8/01 91-158 960-25	 Nadelstange Needle bar 91-171 018-91
 Nähfuß Sewing foot 481-G-8/01 91-154 172-21	 Stoffschieber Feed dog 481-G-8/01 91-059 816-05	 Stichplatte Needle plate 481-G-8/01 91-150 315-25	
 Greifer Hook 91-174 475-96	 Spulenkapsel Bobbin case 91-174 955-91	 Spule Bobbin 91-174 480-05	 Bremsfeder Break spring 91-175 690-05
 Fadenanzugsfeder Thread check spring 91-006 814-05	 Fänger Thread catcher 91-165 505-05	 Messer Knife 91-171 853-15	 Reibring Friction Ring 99-137 151-45
 Biegefeder z. Spuler Spring for bobbin winder 91-171 049-05			

Befestigungsschrauben für: Retaining screws for:

Fänger Thread catcher 11-108 084-15	Messer Knife 11-108 087-15	Nadel Needle 91-701 179-15	Stichplatte Needle plate 91-100 296-25
Stoffschieber Feed dog 91-000 407-15	Nähfuß Sewing foot 11-108 174-15		

487

-G-6/61 BS 487-G-6/61-900/51 BS

-G-6/41 BS 487-G-6/41-900/51 BS



 <p>Nähfuß Sewing foot 91-055 618-03/001 (zur Unterklasse -6/41) (for subclass -6/41)</p>	 <p>Nähfuß Sewing foot 91-055 680-93/002 (zur Unterklasse -6/61) (for subclass -6/61)</p>	 <p>Stoffschiebefuß Vibrating presser foot 91-049 154-45 (zur Unterklasse -6/41) (for subclass -6/41) 91-049 155-45 (zur Unterklasse -6/61) (for subclass -6/61)</p>	 <p>Nadelstange Needle bar 91-175 543-92</p>
 <p>Stoffschieber Feed dog 91-047 553-04/004</p>	 <p>Stichplatte Needle plate 91-058 132-24/002</p>	 <p>Greifer Hook 91-174 475-96</p>	 <p>Spulenkapsel Bobbin case 91-174 955-91</p>
 <p>Spule Bobbin 91-174 480-05</p>	 <p>Fadenanzugsfeder Thread check spring 91-006 814-05</p>	 <p>Bremsfeder Break spring 91-175 690-05</p>	 <p>Fänger Thread catcher 91-165 505-05 *</p>
 <p>Messer Knife 91-171 853-15 *</p>	 <p>Reibring Friction Ring 99-137 151-45</p>	 <p>Biegefeder z. Spuler Spring for bobbin winder 91-171 049-05</p>	

* = nur bei Maschinen mit Fadenabschneider -900/.. /machines with thread trimmer -900/.. only

Befestigungsschrauben für: Retaining screws for:

<p>Fänger Thread catcher 11-108 084-15 *</p>	<p>Messer Knife 11-108 087-15 *</p>	<p>Nadel Needle 11-330 085-15</p>	<p>Stichplatte Needle plate 91-100 296-25</p>
<p>Stoffschieber Feed dog 91-000 407-15</p>	<p>Nähfuß Sewing foot 11-108 174-15</p>		

491

-BL
-B/CLMN7
-725/04-B/CL x1,5 MN7 ohne / *without* Mini-Stop



<p>Rollfuß (Standard) <i>Roller presser (standard)</i> 91-119 787-93/001</p>	<p>Schiebrad <i>Feed wheel</i> 91-119 546-05</p>	<p>Stichplatte <i>Needle plate</i> 491-B/L: 91-150 549-93/001 491-B/CLMN7: 91-150 552-93/001 491-725/04-B/CL...: 91-058 584-93/001</p>	<p>Nadelstange <i>Needle bar</i> 91-175 110-91</p>
<p>Greifer <i>Hook</i> 91-119 386-91</p>	<p>Spulenkapself <i>Bobbin case</i> 91-010 159-91</p>	<p>Spule <i>Bobbin</i> 91-118 308-05</p>	<p>Fadenanzugsfeder <i>Thread check spring</i> 91-010 023-05</p>
<p>Reibring <i>Friction Ring</i> 99-137 151-45</p>	<p>Biegefeder z. Spuler <i>Spring for bobbin winder</i> 91-171 049-05</p>		

Befestigungsschrauben für: *Retaining screws for:*

<p>Rollfuß <i>Roller presser</i> 11-178 172-15</p>	<p>Nadel <i>Needle</i> 91-173 664-15</p>	<p>Stichplatte <i>Needle plate</i> 11-210 168-25</p>	

491

-900/53 BL mit / with Mini-Stop
-900/53-910/15-911/35 BL mit / with Mini-Stop
-725-04-900/53-910/15-911/35 A (1,0)L
x 0,8 mit / with Ministop



 <p>Rollfuß (Standard) Roller presser (standard) 91-119 787-93/001</p>	 <p>Schiebrad Feed dog 91-119 544-05 (A-Version) 91-119 546-05 (B-Version)</p>	 <p>Stichplatte Needle plate 91-150 249-93/002 491-725/04-900/53...</p> <p>Stichplatte Needle plate 91-150 524-93/001 491-900/53 (mit / ohne 910/.. -911/..) (with / without -910/.. -911/..)</p>	 <p>Nadelstange Needle bar 91-175 110-91</p>
 <p>Greifer Hook 91-119 385-91</p>	 <p>Spulenkapsel Bobbin case 91-119 458-91</p>	 <p>Spule Bobbin 91-118 308-05</p>	 <p>Fadenanzugsfeder Thread check spring 91-010 023-05</p>
 <p>Messer Knife 91-164 672-91</p>	 <p>Reibring Friction Ring 99-137 151-45</p>	 <p>Biegefeder z. Spuler Spring for bobbin winder 91-171 049-05</p>	
<p>Einsatz zur Stichplatte 91-150 524-93/001: 91-150 526-04/001 Insert for Needle Plate 91-150 524-93/001: 91-150 526-04/001</p>		<p>Einsatz zur Stichplatte 91-150 249-93/002: 91-150 251-04/004 Insert for Needle Plate 91-150 249-93/002: 91-150 251-04/004</p>	

Befestigungsschrauben für: Retaining screws for:

<p>Rollfuß Roller presser 11-178 172-15</p>	<p>Nadel Needle 91-173 664-15</p>	<p>Stichplatte Needle plate 11-210 168-15</p>	

918

- 6/01BS x 10,0
- 6/01-900/51 BS x 10,0
- 716/06-6/01 BS x 10,0
- 716/06-6/01-900/51 BS x10,0
- 6/01 BS x 6,0
- 6/01-900/51 BS x 6,0
- 716/06-6/01 BS x 7,0

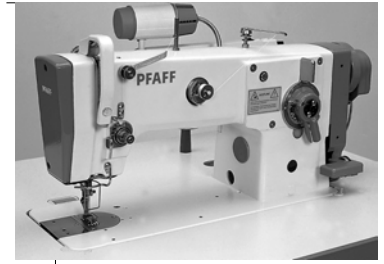

 <p>Nadelstange Needle bar 91-168 019-91</p>	 <p>Greifer Hook 91-168 888-91</p>	 <p>Spulenkapsel Bobbin case 91-168 628-91</p>	 <p>Spule Bobbin 91-168 178-05</p>
 <p>Bremsfeder Break spring 91-168 468-05</p>	 <p>Fadenanzugsfeder Thread check spring 91-006 814-05</p>	 <p>Fänger Thread catcher 91-168 499-05 *</p>	 <p>Messer Knife 91-168 498-15 *</p>
 <p>Reibring Friction Ring 99-137 151-45</p>	 <p>Biegefeder z. Spuler Spring for bobbin winder 91-171 049-05</p>		

* = nur bei Maschinen mit Fadenabschneider -900/51 / machines with thread trimmer -900/51 only

Befestigungsschrauben für: Retaining screws for:

<p>Nähfuß Sewing foot 11-108 174-15</p>	<p>Stoffschieber Feed dog 11-108 171-15</p>	<p>Nadel Needle 91-701 179-15</p>	<p>Stichplatte Needle plate 91-100 296-25</p>
<p>Messer Knife 91-700 249-15</p>			

918

-6/01BS x 10,0
 -6/01-900/51 BS x 10,0
 -716/06-6/01 BS x 10,0
 -716/06-6/01-900/51 BS x10,0
 -6/01 BS x 6,0
 -6/01-900/51 BS x 6,0
 -716/06-6/01 BS x 7,0

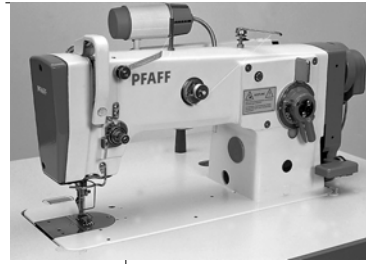

Nähwerkzeuge / Gauge parts

918-6/01 BS x10,0

938-6/01 BS x 6,0

918-716-6/01 BS x 10,0

938-716-6/01 BS x 7,0



Stoffschieber
Feed dog
91-047 559-04/003



Stoffschieber
Feed dog
91-047 575-04/003



Stoffschieber
Feed dog
91-047 645-04/004

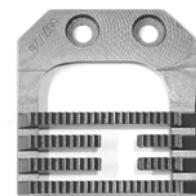

Stoffschieber
Feed dog
91-059 777-04/002



Nähfuß
Sewing foot
91-055 106-23/006



Nähfuß
Sewing foot
91-054 501-23/001



Nähfuß
Sewing foot
91-055 106-23/002



Nähfuß
Sewing foot
91-055 106-23/004



Stichplatte
Needle plate
91-058 089-24/003

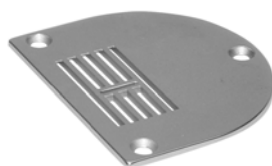

Stichplatte
Needle plate
91-058 113-24/003

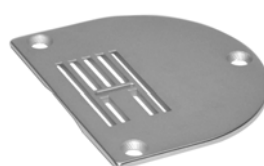

Stichplatte
Needle plate
91-058 208-24/002



Stichplatte
Needle plate
91-150 028-04/002

1051

-8/11-900/24 BS

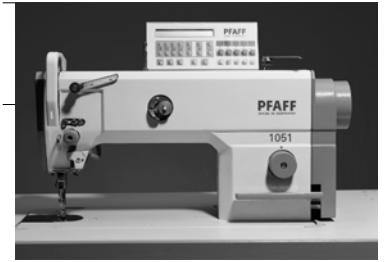

 <p>Nähfuß Sewing foot 91-154 172-21</p>	 <p>Stoffschieber Feed dog 91-059 816-05</p>	 <p>Stichplatte Needle plate 91-150 671-25</p>	 <p>Nadelstange Needle bar 91-262 368-91</p>
 <p>Greifer Hook 91-262 417-91</p>	 <p>Spulenkapsel Bobbin case 91-262 377-91</p>	 <p>Spulenkapselträger Bobbin Case Base 91-262 438-01</p>	 <p>Spule Bobbin 91-262 437-05</p>
 <p>Bremsfeder Break spring 99-137 191-05</p>	 <p>Fadenanzugsfeder Thread check spring 91-006 814-05</p>	 <p>Fänger Thread catcher 91-262 184-05</p>	 <p>Messer Knife 91-171 853-15</p>
 <p>Reibring Friction Ring 99-137 151-45</p>	 <p>Biegefeder z. Spuler Spring for bobbin winder 91-171 049-05</p>		

Befestigungsschrauben für: Retaining screws for:

<p>Fänger Thread catcher 11-108 084-15</p>	<p>Messer Knife 11-108 087-15</p>	<p>Nadel Needle 11-330 085-15 91-701 179-25</p>	<p>Stichplatte Needle plate 91-100 422-25 91-100 296-15</p>
<p>Stoffschieber Feed dog 91-000 407-15</p>	<p>Nähfuß Sewing foot 11-108 174-15</p>		

1053

-8/31-900/24 BS

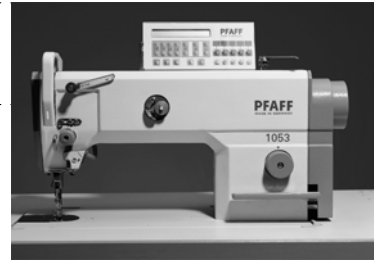

 <p>Nähfuß Sewing foot 91-154 753-21</p>	 <p>Stoffschieber Feed dog 91-059 968-05</p>	 <p>Stichplatte Needle plate 91-150 694-24/001</p>	 <p>Nadelstange Needle bar 91-262 368-91</p>
 <p>Greifer Hook 91-262 417-91</p>	 <p>Spulenkapsel Bobbin case 91-262 377-91</p>	 <p>Spulenkapselträger Bobbin Case Base 91-262 438-01</p>	 <p>Spule Bobbin 91-262 437-05</p>
 <p>Bremsfeder Break spring 99-137 191-05</p>	 <p>Fadenanzugsfeder Thread check spring 91-006 814-05</p>	 <p>Fänger Thread catcher 91-262 184-05</p>	 <p>Messer Knife 91-171 853-15</p>
 <p>Reibring Friction Ring 99-137 151-45</p>	 <p>Biegefeder z. Spuler Spring for bobbin winder 91-171 049-05</p>		

Befestigungsschrauben für: Retaining screws for:

<p>Fänger Thread catcher 11-108 084-15</p>	<p>Messer Knife 11-108 087-15</p>	<p>Nadel Needle 11-330 085-15 91-701 179-25</p>	<p>Stichplatte Needle plate 91-100 422-25 91-100 296-15</p>
<p>Stoffschieber Feed dog 91-000 407-15</p>	<p>Nähfuß Sewing foot 11-108 174-15</p>		

1181
-8/11-900/24

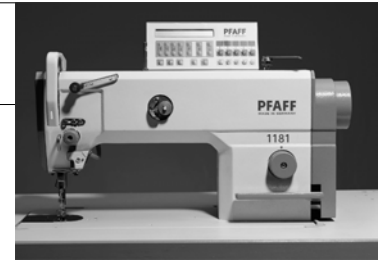

 <p>Nähfuß <i>Sewing foot</i> 91-154 172-21</p>	 <p>Stoffschieber <i>Feed dog</i> 91-059 816-05</p>	 <p>Stichplatte <i>Needle plate</i> 91-150 671-25</p>	 <p>Nadelstange <i>Needle bar</i> 91-262 368-91</p>
 <p>Greifer <i>Hook</i> 91-262 250-91</p>	 <p>Spulenkapsel <i>Bobbin case</i> 91-262 377-91</p>	 <p>Spule <i>Bobbin</i> 91-262 437-05</p>	 <p>Bremsfeder <i>Break spring</i> 99-137 191-05</p>
 <p>Fadenanzugsfeder <i>Thread check spring</i> 91-006 814-05</p>	 <p>Fänger <i>Thread catcher</i> 91-262 184-05</p>	 <p>Messer <i>Knife</i> 91-171 853-15</p>	 <p>Reibring <i>Friction Ring</i> 99-137 151-45</p>
 <p>Biegefeder z. Spuler <i>Spring for bobbin winder</i> 91-171 049-05</p>			

Befestigungsschrauben für:
Retaining screws for:

<p>Fänger <i>Thread catcher</i> 11-108 084-15</p>	<p>Messer <i>Knife</i> 11-108 087-15</p>	<p>Nadel <i>Needle</i> 11-330 085-15 91-701 179-25</p>	<p>Stichplatte <i>Needle plate</i> 91-000 422-25 91-100 296-15</p>
<p>Stoffschieber <i>Feed dog</i> 91-000 407-15</p>	<p>Nähfuß <i>Sewing foot</i> 11-108 174-15</p>		

1183

-8/31-900/24 BS

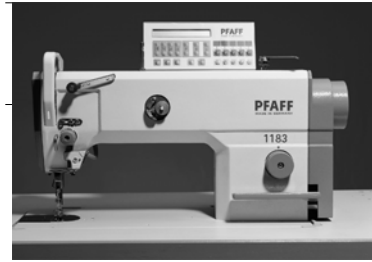

 <p>Nähfuß Sewing foot 91-154 753-21</p>	 <p>Stoffschieber Feed dog 91-059 968-05</p>	 <p>Stichplatte Needle plate 91-150 694-24/001</p>	 <p>Nadelstange Needle bar 91-262 368-91</p>
 <p>Greifer Hook 91-262 250-91</p>	 <p>Spulenkapsel Bobbin case 91-262 377-91</p>	 <p>Spule Bobbin 91-262 437-05</p>	 <p>Bremsfeder Break spring 99-137 191-05</p>
 <p>Fadenanzugsfeder Thread check spring 91-006 814-05</p>	 <p>Fänger Thread catcher 91-262 184-05</p>	 <p>Messer Knife 91-171 853-15</p>	 <p>Reibring Friction Ring 99-137 151-45</p>
 <p>Biegefeder z. Spuler Spring for bobbin winder 91-171 049-05</p>			

Befestigungsschrauben für: Retaining screws for:

<p>Fänger Thread catcher 11-108 084-15</p>	<p>Messer Knife 11-108 087-15</p>	<p>Nadel Needle 11-330 085-15 91-701 179-25</p>	<p>Stichplatte Needle plate 91-000 422-25 91-100 296-15</p>
<p>Stoffschieber Feed dog 91-000 407-15</p>	<p>Nähfuß Sewing foot 11-108 174-15</p>		

1243

-712/02-6/01-900/56 BS



 <p>Nähfuß Sewing foot 91-057 182-05</p>	 <p>Stichplatte Needle plate 91-158 662-91</p>	 <p>Nadelstange Needle bar 91-141 609-91</p>	
 <p>Greifer Hook 91-140 451-91</p>	 <p>Spulenkapsel Bobbin case 91-140 287-91</p>	 <p>Spule Bobbin 91-018 480-05</p>	 <p>Bremsfeder Break spring 91-019 891-05</p>
 <p>Fadenanzugsfeder Thread check spring 91-010 023-05</p>	 <p>Fänger Thread catcher 91-140 731-90</p>	 <p>Messer Knife 91-018 147-05</p>	 <p>Reibring Friction Ring 99-137 151-45</p>
 <p>Biegefeder z. Spuler Spring for bobbin winder 91-171 049-05</p>			

Befestigungsschrauben für: Retaining screws for:

<p>Fänger Thread catcher 11-341 169-15</p>	<p>Messer Knife 11-130 089-15</p>	<p>Nadel Needle 11-174 089-15</p>	<p>Stichplatte Needle plate 91-000 422-25</p>
<p>Stoffschieber Feed dog 91-000 407-15</p>	<p>Nähfuß Sewing foot 11-173 174-25</p>		

1245 -6/01 CLMN8

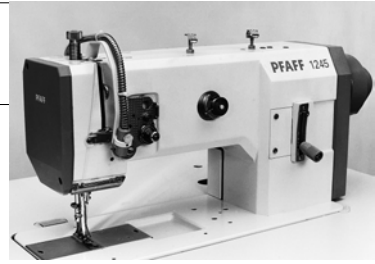

 Stoffschiefefuß <i>Vibrating presser foot</i> 91-049 269-93/006	 Stoffdrückerfuß <i>Presser foot</i> 91-049 585-04/004	 Stoffschieber <i>Feed dog</i> 91-026 745-04/003	 Nadelstange <i>Needle bar</i> 91-141 609-91
 Stichplatte <i>Needle plate</i> 91-048 922-04/002	 Greifer <i>Hook</i> 91-140 539-91	 Spulenkapsel <i>Bobbin case</i> 91-018 348-91	 Spule <i>Bobbin</i> 91-018 339-05
 Bremsfeder <i>Break spring</i> 91-019 891-05	 Fadenanzugsfeder <i>Thread check spring</i> 91-010 937-05	 Reibring <i>Friction Ring</i> 99-137 151-45	 Biegefeder z. Spuler <i>Spring for bobbin winder</i> 91-171 049-05

Befestigungsschrauben für: Retaining screws for:

Stoffschiefefuß <i>Vibrating presser foot</i> 91-000 085-15	Stoffschieber <i>Feed dog</i> 91-000 407-15	Nadel <i>Needle</i> 11-174 089-15	Stichplatte <i>Needle plate</i> 91-000 422-25
Stoffdrückerfuß <i>Presser foot</i> 91-100 366-15			

1293

-4/01-900/56-911/97 CLMN



 <p>Rollfuß (Standard) Roller presser (standard) 91-141 772-93/001</p>	 <p>Stoffschieber Feed dog 91-059 186-04/001</p>	 <p>Stichplatte Needle plate 91-158 087-04/001</p>	 <p>Nadelstange Needle bar 91-009 678-91</p>
 <p>Greifer Hook 91-018 285-91</p>	 <p>Spulenkapsel Bobbin case 91-018 676-91</p>	 <p>Spule Bobbin 91-018 480-05</p>	 <p>Bremsfeder Break spring 91-019 891-05</p>
 <p>Fadenanzugsfeder Thread check spring 91-010 937-05</p>	 <p>Fänger Thread catcher 91-018 257-05</p>	 <p>Messer Knife 91-011 957-15</p>	 <p>Reibring Friction Ring 99-137 151-45</p>
 <p>Biegefeder z. Spuler Spring for bobbin winder 91-171 049-05</p>			

Befestigungsschrauben für: Retaining screws for:

<p>Fänger Thread catcher 11-039 171-45</p>	<p>Messer Knife 91-701 344-15</p>	<p>Nadel Needle 91-700 336-15</p>	<p>Stichplatte Needle plate 91-000 277-25</p>
<p>Stoffschieber Feed dog 91-000 781-25</p>	<p>Nähfuß Sewing foot 11-178 172-15</p>		

1425

-6/01-900/81-910/04-911/35
-918/29 CLMN8

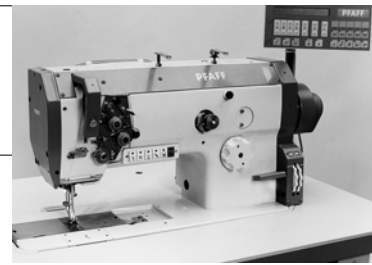

 <p>Stoffschiebefuß <i>Vibrating presser foot</i> 91-049 394-93/003</p>	 <p>Stoffdrückerfuß <i>Presser foot</i> 91-149 162-93/001</p>	 <p>Stoffschieber <i>Feed dog</i> 91-059 933-04/001</p>	 <p>Nadelstange <i>Needle bar</i> 91-266 541-91</p>
 <p>Stichplatte <i>Needle plate</i> 91-150 600-04/001</p>	 <p>Greifer <i>Hook</i> 91-266 504-91</p>	 <p>Spulenkapsel <i>Bobbin case</i> 91-266 505-91</p>	 <p>Spule <i>Bobbin</i> 91-018 480-05</p>
 <p>Bremsfeder <i>Break spring</i> 91-176 438-05</p>	 <p>Fadenanzugsfeder <i>Thread check spring</i> 91-176 329-05</p>	 <p>Fadenklemme <i>Thread clamp</i> 91-266 299-01</p>	 <p>Fänger <i>Thread catcher</i> 91-176 094-05</p>
 <p>Messer <i>Knife</i> 91-186 659-05</p>	 <p>Reibring <i>Friction Ring</i> 99-137 151-45</p>	 <p>Biegefeder z. Spuler <i>Spring for bobbin winder</i> 91-171 049-05</p>	

Befestigungsschrauben für: *Retaining screws for:*

<p>Fänger <i>Thread catcher</i> 11-132 172-15</p>	<p>Messer <i>Knife</i> 11-130 092-15</p>	<p>Nadel <i>Needle</i> 11-174 086-15</p>	<p>Stichplatte <i>Needle plate</i> 91-700 173-15</p>
<p>Stoffschieber <i>Feed dog</i> 11-108 174-15</p>	<p>Nähfuß <i>Sewing foot</i> 11-132 217-15/ 11-130 173-15</p>		

7: VERSCHLEISSTEILE *HIGH MORTALITY PARTS*

7.1 PFAFF SCHWEISSMASCHINEN *PFAFF WELDING MACHINES*

8302



 <p>Heizpatrone <i>Heating Element</i> 71-810 001-21</p>	 <p>Temperaturfühler <i>Thermo Couple</i> 71-710 000-81</p>	 <p>Transportrolle, 25 mm, Silikon <i>Feed Roller, 25 mm, silicone</i> 95-208 496-91</p>
 <p>Kettenspanner, obere Säule <i>Chain Tensioner (Slide), upper post</i> 95-253 539-05</p>	 <p>Kettenspanner, untere Säule <i>Chain Tensioner (Slide), lower post</i> 95-253 153-05</p>	 <p>Kettenspanner, untere Säule <i>Chain Tensioner (Slide), lower post</i> 95-253 960-05 (Ukl. / Sub-CI. -042)</p>
 <p>Messer, oben (Bandabschneider) <i>Upper knife (tape cutter)</i> 99-137 221-91</p>	 <p>Messer, unten (Bandabschneider) <i>Lower knife (tape cutter)</i> 99-137 222-91</p>	 <p>Silikonrolle (Bandabschneider) <i>Silicone feed roller (tape cutter)</i> 99-137 243-91</p>

8304

Heißluft / Hot Air

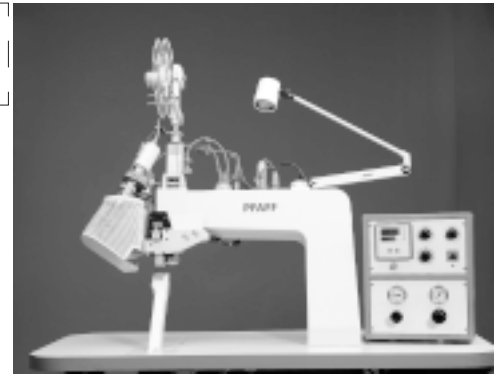

 <p>Heizpatrone Heating Element 71-810 000-91</p>	 <p>Temperaturfühler Thermo Couple 95-210 723-91</p>	 <p>Temperaturregler Temperature Controller 71-750 002-43</p>
 <p>Relais für Heizstrom Heating Relais 71-190 002-52</p>	 <p>Transportrolle, 25 mm, Silikon Feed Roller, 25 mm, silicone 95-208 496-91</p>	 <p>Kettenspanner (obere Säule) Chain Tensioner (Slide), upper post 95-253 539-05</p>
 <p>Kettenspanner (untere Säule) Chain Tensioner (Slide), lower post 95-253 153-05</p>	 <p>Kettenspanner (untere Säule, Schuhversion) Chain Tensioner (Slide), lower post, shoe version 95-253 960-05</p>	 <p>Obermesser (Bandabschneider) Upper knife 95-253 848-05</p>
 <p>Untermesser (Bandabschneider) Lower knife (tape cutter) 95-253 847-05</p>		

8304

Heizkeil / Hot Wedge

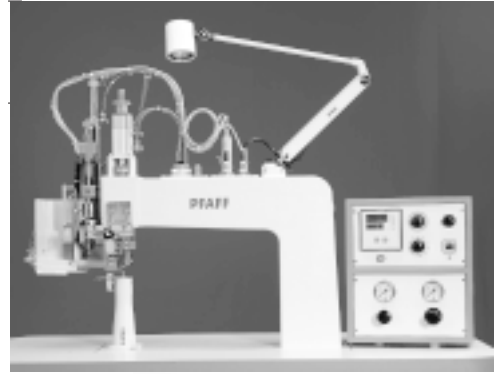

Heizkeil 20 mm
Sealing Wedge 20 mm
95-253 343-91



Heizpatrone
Heating Element
95-211 633-91



Temperaturfühler
Thermo Couple
95-210 728-91



Temperaturregler
Temperature Controller
71-750 002-43



Relais für Heizstrom
Heating Relais
71-190 002-52



Kettenspanner (obere Säule)
Chain Tensioner (Slide), upper post
95-253 539-05



Kettenspanner, (untere Säule)
Chain Tensioner (Slide), lower post
95-253 508-05



Transportrolle, 25 mm, Silikon
Feed Roller, 25 mm, silicone
95-208 496-91

Allgemeines Zubehör *General Accessories*



Nahtprüfgerät
Seam Tester
95-203 099-71/895



Nahtprüfstation (Bekleidung)
Seam Testing Station (Garment)
99-514 162-91



Nahtprüfstation (Schuhe)
Seam Testing Station (Shoes)
99-514 163-91

95-203 099-71/895

Dichtigkeitsprüfung an mit Band abgedeckten Nähten.
Manuelle Version, mit Handpumpe
Control of the permeability of sealed seams.
Testing pressure is produced manually.

99-514 162-91

Nahtprüfstation für Bekleidung.
Funktionsweise wie oben, jedoch für externe Druckluftversorgung
Seam testing Station for garments.
Functionality as described under 95-203 099-71/895, but for external compressed air supply.

99-514 163-91

Nahtprüfstation für Schuhe.
Ausstattung wie bei 99-514 162-91 beschrieben
Seam testing station for shoes.
Equipment as described under 99-514 162-91.

8.

GREIFER, SPULENKAPSELN UND SPULEN *HOOKS, LOOPERS, BOBBIN CASES AND BOBBINS*

8.0

GREIFER, SPULENKAPSELN UND SPULEN GEORDNET NACH PFAFF-MASCHINENKLASSEN *HOOKS, LOOPERS, BOBBIN CASES AND BOBBINS SORTED BY PFAFF MACHINE CLASSES*

8.0

GREIFER, SPULENKAPSELN UND SPULEN GEORDNET NACH PFAFF-MASCHINENKLASSEN HOOKS, LOOPERS, BOBBIN CASES AND BOBBINS SORTED BY PFAFF MACHINE CLASSES

Maschinenklasse →
Greifer →
Greifertyp →
Spulenkapsel →
Spule (A = Alu) →



28
91-004 317-91
R
91-002 314-05



141 A;B;SmG
91-010 165-91
V
91-010 159-91
91-010 079-05

Machine class →
Hooks →
type of hook →
Bobbin case →
Bobbin (A = Alu) →



28-10
91-004 403-91
R
91-002 030-05



141 A;B;LmG
91-010 896-91
V
91-010 159-91
91-010 079-05



34 A;B
91-006 560-05/001
CB
91-006 843-91
91-002 030-05



141-900/06 S m G
91-113 414-91
V
91-140 650-91
91-118 308-05 A



34 C
91-006 694-05
CB
91-006 843-91
91-002 030-05



141-900/06 L m G
91-113 190-91
V
91-113 192-91
91-118 308-05 A



38
91-005 870-91
R *
91-002 030-05



141-900/.. m G
91-113 414-91
V
91-140 650-91
91-118 308-05 A



38-900/75
91-005 870-91
R *
91-002 030-05



142 A;B; S m G
91-010 165-91
V
91-010 159-91
91-010 079-05



118 (-900/..)x10,0
91-163 260-91
H
91-163 263-91
91-168 144-05 A



142 A;B; L m G
91-010 896-91
V
91-010 159-91
91-010 079-05



134-0-K-6; 134-0-31
91-009 264-91
H
91-106 528-91
91-009 033-05



142 C; S m G
91-010 896-91
V
91-010 159-91
91-010 079-05



134
91-105 490-91
H
91-106 528-91
91-009 033-05























142 C; L m G
91-010 850-91
V
91-011 498-91
91-010 079-05



138
91-105 490-91
H
91-009 076-61
91-009 033-05



142 D m G
91-010 850-91
V
91-011 498-91
91-010 079-05

	<p>142-721/01 bis 8,0 m G 91-010 165-91 V 91-010 159-91 91-010 079-05</p>		<p>144-944/01 A;B m G 91-010 896-91 V 91-010 159-91 91-010 079-05</p>
	<p>142-721/01 ab 8,0 m G 91-019 922-91 V 91-019 923-91 91-010 079-05</p>		<p>145-H3 B; S m G 91-010 165-91 V 91-010 159-91 91-010 079-05</p>
	<p>142-900/.. S m G 91-113 414-91 V 91-140 650-91 91-118 308-05 A</p>		<p>145-H3 B; L m G 91-010 896-91 V 91-010 159-91 91-010 079-05</p>
	<p>142-900/.. L m G 91-113 190-91 V 91-113 192-91 91-118 308-05 A</p>		<p>145-900/06 S m G 91-113 414-91 V 91-140 650-91 91-118 308-05 A</p>
	<p>143-705/03 C m G 91-010 850-91 V 91-011 498-91 91-010 079-05</p>		<p>145-900/06 L m G 91-113 190-91 V 91-113 192-91 91-118 308-05 A</p>
	<p>143-944/01 m G 91-010 896-91 V 91-010 159-91 91-010 079-05</p>		<p>145-900/.. B m G 91-113 414-91 V 91-140 650-91 91-118 308-05 A</p>
	<p>144-720/02 m G 91-010 896-91 V 91-010 159-91 91-010 079-05</p>		<p>146-H3 S m G 91-010 165-91 V 91-010 159-91 91-010 079-05</p>
	<p>144-900/06 S m G 91-113 414-91 V 91-140 650-91 91-118 308-05 A</p>		<p>146-H3 L m G 91-010 896-91 V 91-010 159-91 91-010 079-05</p>
	<p>144-900/06 L m G 91-113 190-91 V 91-113 192-91 91-118 308-05 A</p>		<p>146-900/06 S m G 91-113 414-91 V 91-140 650-91 91-118 308-05 A</p>
	<p>144-900/.. m G 91-113 414-91 V 91-140 650-91 91-118 308-05 A</p>		<p>146-900/06 L m G 91-113 190-91 V 91-113 192-91 91-118 308-05 A</p>

8.0

GREIFER, SPULENKAPSELN UND SPULEN GEORDNET NACH PFAFF-MASCHINENKLASSEN HOOKS, LOOPERS, BOBBIN CASES AND BOBBINS SORTED BY PFAFF MACHINE CLASSES

Maschinenklasse →
Greifer →
Greifertyp →
Spulenkapsel →
Spule (A = Alu) →



146-900/.. B m G
91-113 414-91
V
91-140 650-91
91-118 308-05 A



193 A;B; L m G
91-010 896-91
V
91-010 159-91
91-010 079-05

Machine class →
Hooks →
type of hook →
Bobbin case →
Bobbin (A = Alu) →



191 S m G
91-010 165-91
V
91-010 159-91
91-010 079-05



193 C m G
91-010 850-91
V
91-011 498-91
91-010 079-05



191 L m G
91-010 896-91
V
91-010 159-91
91-010 079-05



194 B; S m G
91-010 165-91
V
91-010 159-91
91-010 079-05



192 A;B; S m G
91-010 165-91
V
91-010 159-91
91-010 079-05



194 BC; S m G
91-010 896-91
V
91-010 159-91
91-010 079-05



192 A;B; L m G
91-010 896-91
V
91-010 159-91
91-010 079-05



194 C; L m G
91-010 850-91
V
91-011 498-91
91-010 079-05



192 C; S m G
91-010 896-91
V
91-010 159-91
91-010 079-05



**194-720/02
-944/01 m G**
91-010 896-91
V
91-010 159-91
91-010 079-05



192 C; L m G
91-010 850-91
V
91-011 498-91
91-010 079-05



194-900/56 A;B m G
91-012 781-91
V
91-113 192-91
91-118 308-05 A



**192-721/01
bis 8,0 m G**
91-010 165-91
V
91-010 159-91
91-010 079-05



194-900/56 C o G
91-012 782-91
V
91-113 192-91
91-118 308-05 A



**192-721/01
ab 8,0 m G**
91-019 922-91
V
91-019 923-91
91-010 079-05



194-944/01 A;B m G
91-010 896-91
V
91-010 159-91
91-010 079-05



193 A;B; S m G
91-010 165-91
V
91-010 159-91
91-010 079-05



194-944/01 C m G
91-010 850-91
V
91-011 498-91
91-010 079-05

	<p>195-H3 B; S m G 91-010 165-91 V 91-010 159-91 91-010 079-05</p>		<p>238 mit Auswuchtring with balancing ring 91-064 661-91 H 91-106 528-91 91-009 033-05</p>
	<p>195-H3 B; L m G 91-010 896-91 V 91-010 159-91 91-010 079-05</p>		<p>238 ohne Auswuchtring without balancing ring 91-064 662-91 H 91-106 528-91 91-009 033-05</p>
	<p>195-H3 C;D; S m G 91-010 896-91 V 91-010 159-91 91-010 079-05</p>		<p>241 m G 91-140 454-91 V 91-010 159-91 91-010 079-05</p>
	<p>195-H3 C;D; L m G 91-010 850-91 V 91-011 498-91 91-010 079-05</p>		<p>241-900/.. m G 91-140 544-91 V 91-140 650-91 91-118 308-05 A</p>
	<p>196-H3 B; S m G 91-010 165-91 V 91-010 159-91 91-010 079-05</p>		<p>242 m G 91-140 454-91 V 91-010 159-91 91-010 079-05</p>
	<p>196-H3 B; L m G 91-010 896-91 V 91-010 159-91 91-010 079-05</p>		<p>242-720/02 1,6-7,6 m G 91-010 165-91 V 91-010 159-91 91-010 079-05</p>
	<p>196-H3 C; S m G 91-010 896-91 V 91-010 159-91 91-010 079-05</p>		<p>242-720/02 8,0-30,0 m G 91-019 922-91 V 91-019 923-91 91-010 079-05</p>
	<p>196-H3 C; L o G 91-010 850-91 V 91-011 498-91 91-010 079-05</p>		
	<p>196-H3 D o G 91-010 850-91 V 91-011 498-91 91-010 079-05</p>		
	<p>230 91-105 490-91 H 91-009 076-61 93-009 033-21</p>		

8.0

GREIFER, SPULENKAPSELN UND SPULEN GEORDNET NACH PFAFF-MASCHINENKLASSEN HOOKS, LOOPERS, BOBBIN CASES AND BOBBINS SORTED BY PFAFF MACHINE CLASSES

Maschinenklasse →
Greifer →
Greifertyp →
Spulenkapsel →
Spule (A = Alu) →



242-720/02-900/.. m G
91-113 414-91
V
91-140 650-91
91-118 308-05 A



292 B; BN; S m G
91-010 165-91
V
91-010 159-91
91-010 079-05

Machine class →
Hooks →
type of hook →
Bobbin case →
Bobbin (A = Alu) →



242-900/.. m G
91-140 544-91
V
91-140 650-91
91-118 308-05 A



292 B; BN; L m G
91-010 896-91
V
91-010 159-91
91-010 079-05



244 (-720/02) m G
91-140 454-91
V
91-010 159-91
91-010 079-05



292 C; S m G
91-010 850-91
V
91-011 498-91
91-010 079-05



244 (-720/02)-900/.. m G
91-140 544-91
V
91-140 650-91
91-118 308-05 A



292 C; L m G
91-010 896-91
V
91-010 159-91
91-010 079-05



244-900/.. o G
91-140 545-91
V
91-140 650-91
91-118 308-05 A



292-900/56 B m G
91-012 781-91
V
91-113 192-91
91-118 308-05 A



245 m G
91-140 454-91
V
91-010 159-91
91-010 079-05



292-900/56 C o G
91-012 782-91
V
91-113 192-91
91-118 308-05 A



245-900/.. m G
91-140 544-91
V
91-140 650-91
91-118 308-05 A



293 m G
91-010 896-91
V
91-010 159-91
91-010 079-05



246 m G
91-140 454-91
V
91-010 159-91
91-010 079-05



293-900/.. m G
91-012 781-91
V
91-113 192-91
91-118 308-05 A



246-900/.. m G
91-140 544-91
V
91-140 650-91
91-118 308-05 A



294 m G
91-010 896-91
V
91-010 159-91
91-010 079-05



260
91-105 490-91
H
91-009 076-61
93-009 033-21



294-900/.. A;B;B/C m G
91-012 781-91
V
91-113 192-91
91-118 308-05 A

	<p>294-900/.. C o G 91-012 782-91 V 91-113 192-91 91-118 308-05 A</p>		<p>337-900/51 91-060 461-91 H 91-009 076-61 91-168 144-05</p>
	<p>331 91-105 490-91 H 91-106 528-91 91-009 033-05</p>		<p>341-4 m G 91-013 778-91 V 91-010 159-91 91-010 079-05</p>
	<p>333-G (-900/..) 91-060 581-91 H 91-174 955-91 91-174 480-05 A</p>		<p>341-6 A;B; S m G 91-014 192-91 V 91-010 159-91 91-010 079-05</p>
	<p>333-712/02 (-900/..) 91-060 461-91 H 91-009 076-61 91-168 144-05 A</p>		<p>341-6 A;B; L m G 91-013 778-91 V 91-010 159-91 91-010 079-05</p>
	<p>333-712/03 91-060 461-91 H 91-009 076-61 91-009 033-05</p>		<p>341-6 C; S m G 91-013 778-91 V 91-010 159-91 91-010 079-05</p>
	<p>335-G (-900/..) 91-060 581-91 H 91-174 955-91 91-174 480-05 A</p>		<p>343-712/.. o G 91-014 415-91 V 91-010 159-91 91-010 079-05</p>
	<p>335-H3 91-060 461-91 H 91-009 076-61 91-009 033-05</p>		<p>345-H3 m G 91-014 192-91 V 91-010 159-91 91-010 079-05</p>
	<p>335-H3-900/52 91-060 461-91 H 91-009 076-61 91-168 144-05 A</p>		<p>345-6 S m G 91-014 192-91 V 91-010 159-91 91-010 079-95</p>
	<p>337-G (-900/..) 91-060 581-91 H 91-174 955-91 91-174 480-05 A</p>		<p>345-6 L m G 91-013 778-91 V 91-010 159-91 91-010 079-05</p>
	<p>337 91-060 461-91 H 91-009 076-61 91-009 033-05</p>		<p>346 B m G 91-140 942-91 V 91-010 159-91 91-010 079-05</p>

8.0

GREIFER, SPULENKAPSELN UND SPULEN GEORDNET NACH PFAFF-MASCHINENKLASSEN HOOKS, LOOPERS, BOBBIN CASES AND BOBBINS SORTED BY PFAFF MACHINE CLASSES

Maschinenklasse →
Greifer →
Greifertyp →
Spulenkapsel →
Spule (A = Alu) →



346 C o G
91-140 887-91
V
91-010 159-91
91-010 079-05



421-900/61 B/C o G
91-164 498-91
V
91-162 632-91
91-118 308-05 A

Machine class →
Hooks →
type of hook →
Bobbin case →
Bobbin (A = Alu) →

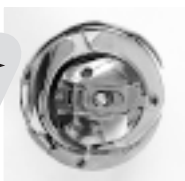

417 (-900/..) A; B
91-168 888-91
H
91-168 628-91
91-168 178-05 A



422 (-720/..);(-900/..)
91-166 733-91
V
91-162 632-91
91-118 308-05 A



417(-900/..) C
91-167 980-91
H
95 629 679-91
91-168 178-05 A



437
91-265 225-91
H
91-167 597-91
91-168 144-05 A



417/419 (-900/..)
91-168 888-91
H
91-168 628-91
91-168 178-05 A

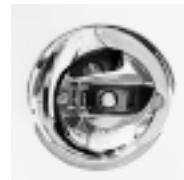

437-900/..
91-265 225-91
H
91-167 597-91
91-168 144-05 A



418 A; B
91-168 888-91
H
91-168 628-91
91-168 634-05

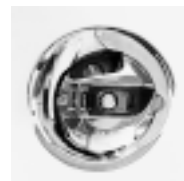

438
91-265 225-91
H
91-167 597-91
91-168 144-05 A



418 (-900/..) C
91-167 980-91
H
95-629 679-91
91-168 178-05 A

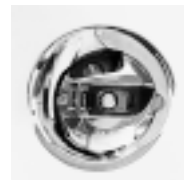

438-716/.. (-900/..)
91-265 225-91
H
91-167 597-91
91-168 144-05 A



**418-712/05-900/..
Schlitz**
95-629 677-91
H
95-629 679-91
91-168 178-05 A

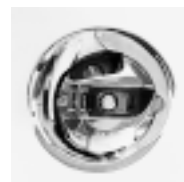

438-900/..
91-265 225-91
H
91-167 597-91
91-168 144-05 A



418-900/.. A;B
91-168 888-91
H
91-168 628-91
91-168 178-05 A

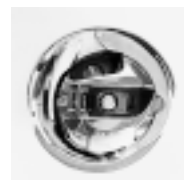

439
91-265 225-91
H
91-167 597-91
91-168 144-05 A



419
91-168 888-91
H
91-168 628-91
91-168 634-05

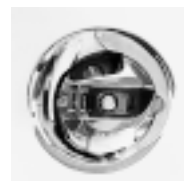





















439-900/..
91-265 225-91
H
91-167 597-91
91-168 144-05 A



421-900/61 A;B m G
91-162 655-91
V
91-162 632-91
91-118 308-05 A



441-O N7 o G
91-173 147-91
V
91-010 159-91
91-010 079-05

	<p>441-O S m G 91-118 876-91 V 91-010 159-91 91-010 079-05</p>		<p>442-0 S m G 91-118 876-91 V 91-010 159-91 91-010 079-05</p>
	<p>441-O L m G 91-118 875-91 V 91-010 159-91 91-010 079-05</p>		<p>442-0 L m G 91-118 875-91 V 91-010 159-91 91-010 079-05</p>
	<p>441-0-900/.. S m G 91-118 318-91 V 91-118 414-91 91-118 308-05 A</p>		<p>442-0-900/.. S m G 91-118 318-91 V 91-118 414-91 91-118 308-05 A</p>
	<p>441-0-900/.. L m G 91-118 419-91 V 91-118 414-91 91-118 308-05 A</p>		<p>442-0-900/.. L m G 91-118 419-91 V 91-118 414-91 91-118 308-05 A</p>
	<p>441-R m G 91-118 875-91 V 91-010 159-91 91-010 079-05</p>		<p>442-R S m G 91-118 876-91 V 91-010 159-91 91-010 079-05</p>
	<p>441-R-900/.. m G 91-173 240-91 V 91-113 192-91 91-118 308-05 A</p>		<p>442-R L m G 91-118 875-91 V 91-010 159-91 91-010 079-05</p>
	<p>442 m G 91-118 876-91 V 91-010 159-91 91-010 079-05</p>		<p>442-R-900/11;/51 S m G 91-118 318-91 V 91-118 414-91 91-118 308-05 A</p>
	<p>442-720/04 m G 91-118 876-91 V 91-010 159-91 91-010 079-05</p>		<p>442-R-900/11;/51 L m G 91-118 419-91 V 91-118 414-91 91-118 308-05 A</p>
	<p>442-720/04-900/... m G 91-173 240-91 V 91-113 192-91 91-118 308-05 A</p>		<p>442-R-900/56;/61 m G 91-173 240-91 V 91-113 192-91 91-118 308-05 A</p>
	<p>442-900/11 m G 91-118 318-91 V 91-118 414-91 91-118 308-05 A</p>		<p>442-R-900/71 m G 91-118 318-91 V 91-118 414-91 91-118 308-05 A</p>





















8.0

GREIFER, SPULENKAPSELN UND SPULEN GEORDNET NACH PFAFF-MASCHINENKLASSEN HOOKS, LOOPERS, BOBBIN CASES AND BOBBINS SORTED BY PFAFF MACHINE CLASSES

Maschinenklasse →
 Greifer →
 Greifertyp →
 Spulenkapsel →
 Spule (A = Alu) →

Machine class →
 Hooks →
 type of hook →
 Bobbin case →
 Bobbin (A = Alu) →

	444 A;B; S m G 91-118 876-91 V 91-010 159-91 91-010 079-05		444-R-900/.. S m G 91-118 318-91 V 91-118 414-91 91-118 308-05 A
	444 A;B; L m G 91-118 875-91 V 91-010 159-91 91-010 079-05		444-R-900/.. L m G 91-118 419-91 V 91-118 414-91 91-118 308-05 A
	444-900/.. A;B; S m G 91-118 318-91 V 91-118 414-91 91-118 308-05 A		448-0 S m G 91-118 876-91 V 91-010 159-91 91-010 079-05
	444-900/.. A;B; L m G 91-118 419-91 V 91-118 414-91 91-118 308-05 A		448-0 L m G 91-118 875-91 V 91-010 159-91 91-010 079-05
	444-0 S m G 91-118 876-91 V 91-010 159-91 91-010 079-05		448-0-900/.. S m G 91-118 318-91 V 91-118 414-91 91-118 308-05 A
	444-0 L m G 91-118 875-91 V 91-010 159-91 91-010 079-05		448-0-900/.. L m G 91-118 419-91 V 91-118 414-91 91-118 308-05 A
	444-0 -900/.. S m G 91-118 318-91 V 91-118 414-91 91-118 308-05 A		457-0 S m G 91-118 876-91 V 91-010 159-91 91-010 079-05
	444-0-900/.. L m G 91-118 419-91 V 91-118 414-91 91-118 308-05 A		457-0 L m G 91-118 875-91 V 91-010 159-91 91-010 079-05
	444-R S m G 91-118 876-91 V 91-010 159-91 91-010 079-05		457-0-900/.. S m G 91-118 318-91 V 91-118 414-91 91-118 308-05 A
	444-R L m G 91-118 875-91 V 91-010 159-91 91-010 079-05		457-0-900/.. L m G 91-118 419-91 V 91-118 414-91 91-118 308-05 A

	<p>461 (-900/..) 91-165 800-91 H 91-009 076-61 91-168 144-05 A</p>		<p>472 m G 91-119 386-91 V 91-010 159-91 91-010 079-05</p>
	<p>463 (-900/..) 91-165 800-91 H 91-009 076-61 91-168 144-05 A</p>		<p>472-900/.. m G 91-119 385-91 V 91-119 458-91 91-118 308-05 A</p>
	<p>463-H (-900/..) 91-171 912-91 H 91-009 076-61 91-168 144-05 A</p>		<p>474 A;B m G 91-119 386-91 V 91-010 159-91 91-010 079-05</p>
	<p>467 (-900/..) 91-165 800-91 H 91-009 076-61 91-168 144-05 A</p>		<p>474 B/C o G 91-119 767-91 V 91-010 159-91 91-010 079-05</p>
	<p>467/469 91-165 800-91 H 91-009 076-61 91-009 033-05</p>		<p>474-900/.. A;B m G 91-119 385-91 V 91-119 458-91 91-118 308-05 A</p>
	<p>469 91-165 800-91 H 91-009 076-61 91-009 033-05</p>		<p>474-900/.. B/C o G 91-119 899-91 V 91-119 458-91 91-118 308-05 A</p>
	<p>471 A; B m G 91-119 386-91 V 91-010 159-91 91-010 079-05</p>		<p>481-G (-900/..) 91-174-475-96 H 91-174 955-91 91-174 480-05 A</p>
	<p>471 B/C o G 91-119 767-91 V 91-010 159-91 91-010 079-05</p>		<p>481-G-900/..-926/01 91-174 475-96 H 91-174 955-91 91-186 492-05 A</p>
	<p>471-900/.. A;B m G 91-119 385-91 V 91-119 458-91 91-118 308-05 A</p>		<p>481 (-900/..) 91-165 800-91 H 91-009 076-61 91-168 144-05 A</p>
	<p>471-900/.. B/C o G 91-119 899-91 V 91-119 458-91 91-118 308-05 A</p>		<p>481-900/..-926/01 91-165 800-91 H 91-009 076-61 91-186 493-05 A</p>

8.0

GREIFER, SPULENKAPSELN UND SPULEN GEORDNET NACH PFAFF-MASCHINENKLASSEN HOOKS, LOOPERS, BOBBIN CASES AND BOBBINS SORTED BY PFAFF MACHINE CLASSES

Maschinenklasse →
Greifer →
Greifertyp →
Spulenkapsel →
Spule (A = Alu) →



483-G (-900/..)
91-174 475-96
H
91-174 955-91
91-174 480-05 A



489-G (-900/..)
91-174 475-96
H
91-174 955-91
91-174 480-05 A

Machine class →
Hooks →
type of hook →
Bobbin case →
Bobbin (A = Alu) →



483-G-900/..-926/01
91-174 475-96
H
91-174 955-91
91-186 492-05 A



489-G-900/..-926/01
91-174 475-96
H
91-174 955-91
91-186 492-05 A



483 (-900/..)
91-165 800-91
H
91-009 076-61
91-168 144-05 A



489 (-900/..)
91-165 800-91
H
91-009 076-61
91-168 144-05 A



483-900/..-926/01
91-165 800-91
H
91-009 076-61
91-186 493-05 A



491 A;B m G
91-119 386-91
V
91-010 159-91
91-010 079-05



485 (-900/..)
91-165 800-91
H
91-009 076-61
91-168 144-05 A



491 B/C o G
91-119 767-91
V
91-010 159-91
91-010 079-05



487-G (-900/..)
91-174 475-96
H
91-174 955-91
91-174 480-05 A



491-900/.. A;B m G
91-119 385-91
V
91-119 458-91
91-118 308-05 A



487-G-900/..-926/01
91-174 475-96
H
91-174 955-91
91-186 492-05 A



491-900/.. B/C o G
91-119 899-91
V
91-119 458-91
91-118 308-05 A



487 (-900/..)
91-165 800-91
H
91-009 076-61
91-168 144-05 A



493 A;B m G
91-119 386-91
V
91-010 159-91
91-010 079-05



487-900/..-926/01
91-165 800-91
H
91-009 076-61
91-186 493-05 A



493 B/C o G
91-119 767-91
V
91-010 159-91
91-010 079-05



487/489
91-165 800-91
H
91-009 076-61
91-168 144-05 A



493-900/.. A;B m G
91-119 385-91
V
91-119 458-91
91-118 308-05 A



493-900/.. B/C o G
 91-119 899-91
 V
 91-119 458-91
 91-118 308-05 A



542-900/.. C o G
 91-018 680-91
 V
 91-140 287-91
 91-018 480-05 A



541 B m G
 91-018 482-91
 V
 91-018 348-91
 91-018 339-05



543 C o G
 91-018 340-91
 V
 91-018 348-91
 91-018 339-05



541 C;D o G
 91-018 340-91
 V
 91-018 348-91
 91-018 339-05



543-712/.. o G
 91-014 418-91
 V
 91-018 348-91
 91-018 480-05



541-900/11 B m G
 91-018 106-91
 V
 91-140 287-91
 91-018 480-05 A



543-900/.. o G
 91-018 680-91
 V
 91-140 287-91
 91-018 480-05 A



**541-900/11;/16
 B/C m G**
 91-018 113-91
 V
 91-140 287-91
 91-018 480-05 A



544-162/01 B m G
 91-018 482-91
 V
 91-018 348-91
 91-018 339-05



541-900/11;/16 C o G
 91-018 680-91
 V
 91-140 287-91
 91-018 480-05 A



**544-720/02
 2,4-7,2 o G**
 91-018 340-91
 V
 91-018 348-91
 91-018 339-05



542 B m G
 91-018 482-91
 V
 91-018 348-91
 91-018 339-05



**544-720/02
 8,0-15,2 o G**
 91-018 876-91
 V
 91-018 959-91
 91-018 339-05



542 C o G
 91-018 340-91
 V
 91-018 348-91
 91-018 339-05



**544-720/-900/
 B/C m G**
 91-018 113-91
 V
 91-140 287-91
 91-018 480-05 A



**542-720/-900/..
 B/C m G**
 91-018 113-91
 V
 91-140 287-91
 91-018 480-05 A



544-900/.. B m G
 91-018 106-91
 V
 91-140 287-91
 91-018 480-05 A



542-900/.. B m G
 91-018 106-91
 V
 91-140 287-91
 91-018 480-05 A



**544-900/16;/56
 B/C m G**
 91-018 113-91
 V
 91-140 287-91
 91-018 480-05 A

8.0

GREIFER, SPULENKAPSELN UND SPULEN GEORDNET NACH PFAFF-MASCHINENKLASSEN HOOKS, LOOPERS, BOBBIN CASES AND BOBBINS SORTED BY PFAFF MACHINE CLASSES

Maschinenklasse →
Greifer →
Greifertyp →
Spulenkapsel →
Spule (A = Alu) →



**544-900/..
C;C/D o G**
91-018 680-91
V
91-140 287-91
91-018 480-05 A



561 (-900/..)
91-165 800-91
H
91-009 076-61
91-168 144-05 A

Machine class →
Hooks →
type of hook →
Bobbin case →
Bobbin (A = Alu) →



**544-944/01
C;C/D o G**
91-018 340-91
V
91-018 348-91
91-018 339-05



563-G (-900/..)
91-174 475-96
H
91-174 955-91
91-174 480-05 A



545-H3 C;D; o G
91-018 340-91
V
91-018 348-91
91-018 339-05



563-G-900/..-926/01
91-174 475-96
H
91-174 955-91
91-186 492-05 A



**545-H3-735/01
B m G**
91-018 482-91
V
91-018 348-91
91-018 339-05



563 (-900/..)
91-165 800-91
H
91-009 076-61
91-168 144-05 A



545-900/.. C o G
91-018 680-91
V
91-140 287-91
91-018 480-05 A



591 C;D o G
91-018 340-91
V
91-018 348-91
91-018 339-05



**546-H2-748/01
B m G**
91-018 482-91
V
91-018 348-91
91-018 339-05



593-712/.. o G
91-014 418-91
V
91-018 348-91
91-018 480-05 A



546-H3 C;D o G
91-018 340-91
V
91-018 348-91
91-018 339-05



593-944/01 C o G
91-018 340-91
V
91-018 348-91
91-018 339-05



546-900/.. C o G
91-018 680-91
V
91-140 287-91
91-018 480-05 A



594-720/02-944/01 o G
91-018 340-91
V
91-018 348-91
91-018 339-05



561-G (-900/..)
91-174 475-96
H
91-174 955-91
91-174 480-05























594-900/56-900/01 o G
91-018 285-91
V
91-018 676-91
91-018 480-05 A



561-G-900/..-926/01
91-174 475-96
H
91-174 955-91
91-186 492-05 A



594-944/01 o G
91-018 340-91
V
91-018 348-91
91-018 339-05

	<p>595-H3 S o G 91-018 340-91 V 91-018 348-91 91-018 339-05</p>		<p>918 (-900/..) C 91-167 980-91 H 95-629 679-91 91-168 178-05 A</p>
	<p>596-H3 o G 91-018 340-91 V 91-018 348-91 91-018 339-05</p>		<p>918 Homemaker Ver. 91-268 093-91 H 91-167 084-91 91-167 088-05</p>
	<p>646 B m G 91-140 942-91 V 91-010 159-91 91-010 079-05</p>		<p>937 91-265 225-91 H 91-167 597-91 91-168 144-05 A</p>
	<p>646 C o G 91-140 887-91 V 91-010 159-91 91-010 079-05</p>		<p>937-900/.. 91-265 225-91 H 91-167 597-91 91-168 144-05 A</p>
	<p>838 91-265 225-91 H 91-167 597-91 91-168 144-05 A</p>		<p>938 91-265 225-91 H 91-167 597-91 91-168 144-05 A</p>
	<p>838-900/.. 91-265 225-91 H 91-167 597-91 91-168 144-05</p>		<p>938-716/.. (-900/..) 91-265 225-91 H 91-167 597-91 91-168 144-05 A</p>
	<p>892 A;B;L m G 91-010 896-91 V 91-010 159-91 91-010 079-05</p>		<p>938-900/.. 91-265 225-91 H 91-167 597-91 91-168 144-05 A</p>
	<p>893 A;B;L m G 91-010 896-91 V 91-010 159-91 91-010 079-05</p>		<p>939 91-265 225-91 H 91-167 597-91 91-168 144-05 A</p>
	<p>917 (-900/..) A;B 91-168 888-91 H 91-168 628-91 91-168 178-05 A</p>		<p>939-900/.. 91-265 225-91 H 91-167 597-91 91-168 144-05 A</p>
	<p>918 (-900/..) A;B 91-168 888-91 H 91-168 628-91 91-168 178-05 A</p>		<p>951 (-900/..) 91-165 800-91 H 91-009 076-61 91-168 144-05 A</p>

8.0

GREIFER, SPULENKAPSELN UND SPULEN GEORDNET NACH PFAFF-MASCHINENKLASSEN HOOKS, LOOPERS, BOBBIN CASES AND BOBBINS SORTED BY PFAFF MACHINE CLASSES

Maschinenklasse →
Greifer →
Greifertyp →
Spulenkapsel →
Spule (A = Alu) →



951-900/..-926/01
91-165 800-91
H
91-009 076-61
91-186 493-05 A



1241-900/.. C o G
91-140 541-91
V
91-140 287-91
91-018 480-05 A

Machine class →
Hooks →
type of hook →
Bobbin case →
Bobbin (A = Alu) →



953 (-900/..)
91-165 800-91
H
91-009 076-61
91-168 144-05 A



1242 o G
91-140 539-91
V
91-018 348-91
91-018 339-05



953-900/..-926/01
91-165 800-91
H
91-009 076-61
91-186 493-05 A



**1242-720/
B 3,2-7,6 m G**
91-018 482-91
V
91-018 348-91
91-018 339-05



1051
91-262 417-91
H
91-262 377-91
91-262 437-05 A



**1242-720/
B 8-30,0 m G**
91-018 116-91
V
91-018 959-91
91-018 339-05



1053
91-262 417-91
H
91-262 377-91
91-262 437-05 A



**1242-720
B/C 3,2-7,6 m G**
91-018 112-91
V
91-018 348-91
91-018 339-05



1181
91-262 250-91
H
91-262 377-91
91-262 437-05 A



**1242-720
B/C 8-30,0 m G**
91-018 117-91
V
91-018 959-91
91-018 339-05



1183
91-262 250-91
H
91-262 377-91
91-262 437-05 A



**1242-720/02-900/..
m G**
91-018 113-91
V
91-140 287-91
91-018 480-05 A



1241 B;B/C m G
91-140 538-91
V
91-018 348-91
91-018 339-05



1242-732/09 B m G
91-140 538-91
V
91-018 348-91
91-018 339-05



1241 C;D o G
91-140 539-91
V
91-018 348-91
91-018 339-05





















**1242-732/09-900/
B m G**
91-140 540-91
V
91-140 287-91
91-018 480-05 A



**1241-900/..
B;B/C m G**
91-140 540-91
V
91-140 287-91
91-018 480-05 A



1242-748/01 B m G
91-140 538-91
V
91-018 348-91
91-018 339-05

	<p>1242-748/01 B;C o G 91-140 539-91 V 91-018 348-91 91-018 339-05</p>		<p>1245 B m G 91-140 538-91 V 91-018 348-91 91-018 339-05</p>
	<p>1242-900/.. o G 91-140 451-91 V 91-140 287-91 91-018 480-05 A</p>		<p>1245 C o G 91-140 539-91 V 91-018 348-91 91-018 339-05</p>
	<p>1243 o G 91-140 539-91 V 91-018 348-91 91-018 339-05</p>		<p>1245-706/47 o G 91-018 340-91 V 91-018 348-91 91-018 339-05</p>
	<p>1243-900/.. o G 91-140 451-91 V 91-140 287-91 91-018 480-05 A</p>		<p>1245-900/.. B m G 91-140 540-91 V 91-140 287-91 91-018 480-05 A</p>
	<p>1244 C o G 91-140 539-91 V 91-018 348-91 91-018 339-05</p>		<p>1245-900/.. C o G 91-140 451-91 V 91-140 287-91 91-018 480-05 A</p>
	<p>1244 D o G 91-018 340-91 V 91-018 348-91 91-018 339-05</p>		<p>1245-900/.. m G Dropin 91-140 738-91 V 91-140 992-91 91-018 480-05 A</p>
	<p>1244-720/02 m G 91-018 112-91 V 91-018 348-91 91-018 339-05</p>		<p>1246 B; m G 91-140 538-91 V 91-018 348-91 91-018 339-05</p>
	<p>1244-900(720/) B/C m G 91-018 113-91 V 91-140 287-91 91-018 480-05 A</p>		<p>1246 C;D o G 91-140 539-91 V 91-018 348-91 91-018 339-05</p>
	<p>1244-900/.. C o G 91-140 451-91 V 91-140 287-91 91-018 480-05 A</p>		
	<p>1244-900/.. C/D o G 91-018 680-91 V 91-140 287-91 91-018 480-05 A</p>		

8.0

GREIFER, SPULENKAPSELN UND SPULEN GEORDNET NACH PFAFF-MASCHINENKLASSEN HOOKS, LOOPERS, BOBBIN CASES AND BOBBINS SORTED BY PFAFF MACHINE CLASSES

Maschinenklasse →
Greifer →
Greifertyp →
Spulenkapsel →
Spule (A = Alu) →



1246-720/..
3,2-7,6 m G
91-140 538-91
V
91-018 348-91
91-018 339-05



1293-900/.. C o G
91-018 285-91
V
91-018 676-91
91-018 480-05 A

Machine class →
Hooks →
type of hook →
Bobbin case →
Bobbin (A = Alu) →



1246-720/.. 8-30,0 m G
91-140 541-91
V
91-018 959-91
91-018 339-05



1294 o G
91-018 340-91
V
91-018 348-91
91-018 339-05



1246-900/.. B;B/C m G
91-140 540-91
V
91-140 287-91
91-018 480-05 A



1294-900/.. o G
91-018 285-91
V
91-018 676-91
91-018 480-05 A



1246-900/.. C o G
91-140 451-91
V
91-140 287-91
91-018 480-05 A



1295 B m G
91-018 482-91
V
91-018 348-91
91-018 339-05



1246-900/ B;B/C m G
Drop-in
91-140 738-91
V
91-140 992-91
91-018 480-05 A



1295 C;D o G
91-018 340-91
V
91-018 348-91
91-018 339-05



1291 B m G
91-018 482-91
V
91-018 348-91
91-018 339-05



1295-900/.. B m G
91-018 284-91
V
91-018 676-91
91-018 480-05 A



1291 C o G
91-018 340-91
V
91-018 348-91
91-018 339-05



1295-900/.. C o G
91-018 285-91
V
91-018 676-91
91-018 480-05 A



1291-900/.. B m G
91-018 284-91
V
91-018 676-91
91-018 480-05 A



1295-900/.. Drop-in
91-141 833-91
V
91-176 443-91
91-018 480-05 A



1291-900/... C o G
91-018 285-91
V
91-018 676-91
91-018 480-05 A



1296 B m G
91-018 482-91
V
91-018 348-91
91-018 339-05



1293 o G
91-018 340-91
V
91-018 348-91
91-018 339-05



1296 C;D o G
91-018 340-91
V
91-018 348-91
91-018 339-05



1296-237/06 m G
 91-018 482-91
 V
 91-018 348-91
 91-018 339-05



**1422-720/.. -926/06
 b 8**
 91-266 685-91
 V
 91-266 683-91
 91-266 241-35 A



**1296-237/06-900/..
 m G**
 91-018 284-91
 V
 91-018 676-91
 91-018 480-05 A



**1422-720/.. -926/06
 a 8**
 91-266 055-91
 V
 91-266 056-91
 91-266 241-35 A



1296-900/.. B m G
 91-018 284-91
 V
 91-018 676-91
 91-018 480-05 A



**1422-900/..
 (-720/.. bis 8,0)**
 91-266 685-91
 V
 91-266 683-91
 91-018 480-05 A



1296-900/.. C o G
 91-018 285-91
 V
 91-018 676-91
 91-018 480-05 A



1422-900/.. -926/06
 91-266 685-91
 V
 91-266 683-91
 91-266 241-35 A



1297-900/.. B m G
 91-018 284-91
 V
 91-018 676-91
 91-018 480-05 A



**1425 (-900/..)
 Drop-in**
 91-266 504-91
 V
 91-266 505-91
 91-018 480-05 A



1422 (-720/.. bis 8,0)
 91-266 685-91
 V
 91-266 683-91
 91-018 480-05 A



**1425-900/.. -926/04
 Drop-in**
 91-266 504-91
 V
 91-266 505-91
 91-186 647-25 A



1422-720/.. ab 8,0
 91-266 055-91
 V
 91-266 056-91
 91-018 480-05 A



**1425-900/.. -926/06
 Drop-in**
 91-266 504-91
 V
 91-266 505-91
 91-266 241-35 A



**1422-720/..-900/..
 ab 8,0**
 91-266 055-91
 V
 91-266 056-91
 91-018 480-05 A



**1426 (-900/..)
 Drop-in**
 91-266 504-91
 V
 91-266 505-91
 91-018 480-05 A



**1422-720/.. -926/04
 b 8**
 91-266 685-91
 V
 91-266 683-91
 91-186 647-25 A



1426-720/04 (-900/..)
 91-266 685-91
 V
 91-266 683-91
 91-018 480-05 A



**1422-720/.. -926/04
 a 8**
 91-266 055-91
 V
 91-266 056-91
 91-186 647-25 A



**1426-720/..-900/..
 -926/04**
 91-266 685-91
 V
 91-266 683-91
 91-186 647-25 A

8.0

GREIFER, SPULENKAPSELN UND SPULEN GEORDNET NACH PFAFF-MASCHINENKLASSEN HOOKS, LOOPERS, BOBBIN CASES AND BOBBINS SORTED BY PFAFF MACHINE CLASSES

Maschinenklasse →
Greifer →
Greifertyp →
Spulenkapsel →
Spule (A = Alu) →



1426-900/..-926/06
Drop-in
91-266 504-91**
V
91-266 505-91
91-266 241-35 A



1442 B m G
91-140 538-91
V
91-018 348-91
91-018 339-05

Machine class →
Hooks →
type of hook →
Bobbin case →
Bobbin (A = Alu) →



1427 (-900/..)
Drop-in
91-266 504-91**
V
91-266 505-91
91-018 480-05 A



1442 C o G
91-140 539-91
V
91-018 348-91
91-018 339-05



1427-900/..-926/04
Drop-in
91-266 504-91**
V
91-266 505-91
91-186 647-25 A



1442-720/04 B m G
91-140 538-91
V
91-018 348-91
91-018 339-05



1427-900/..-926/06
Drop-in
91-266 504-91**
V
91-266 505-91
91-266 241-35 A



1442-720/04
B/C;C o G
91-140 539-91
V
91-018 348-91
91-018 339-05



1428 (-900/..)
Drop-in
91-266 504-91**
V
91-266 505-91
91-018 480-05 A



1442-720-900/
B/C;C o G
91-176 369-91
V
91-018 676-91
91-018 480-05 A



1428-900/..-926/04
Drop-in
91-266 504-91**
V
91-266 505-91
91-186 647-25 A



1442-900/.. B;C o G
91-176 369-91
V
91-018 676-91
91-018 480-05 A



1428-900/..-926/06
Drop-in
91-266 504-91**
V
91-266 505-91
91-266 241-35 A



1445 B m G
91-140 538-91
V
91-018 348-91
91-018 339-05



1441 B m G
91-140 538-91
V
91-018 348-91
91-018 339-05



1445 C o G
91-140 539-91
V
91-018 348-91
91-018 339-05



1441 C o G
91-140 539-91
V
91-018 348-91
91-018 339-05



1445-900/.. o G
Stand.
91-176 369-91
V
91-018 676-91
91-018 480-05 A



1441-900/.. B;C o G
91-176 369-91
V
91-018 676-91
91-018 480-05 A



1445-900/.. B m G
Drop-in
91-176 440-91
V
91-176 443-91
91-018 480-05 A



1445-900/.. C o G
Drop-in
 91-176 442-91
 V
 91-176 443-91
 91-018 480-05 A



3114
 91-008 250-99
 H
 91-008 243-99
 91-020 240-05



1446 B m G
 91-140 538-91
 V
 91-018 348-91
 91-018 339-05



3116
 mit Ölfangschale und elox. Spule
 with oil pan and anodised bobbin
 91-120 631-91
 H
 91-160 130-91
 91-138 550-05



1446 C o G
 91-140 539-91
 V
 91-018 348-91
 91-018 339-05



3116
 mit Ölfangschale
 with oil pan
 91-120 631-91
 H
 91-160 130-91
 91-120 054-05 A



1446-900/.. B;C o G
 91-176 369-91
 V
 91-018 676-91
 91-018 480-05 A



3116
 ohne Ölfangschale, mit elox. Spule
 without oil pan,
 with anodised bobbin
 91-120 710-91
 H
 91-160 130-91
 91-138 550-05



1471 (E)-900/.. m G
 91-119 385-91
 V
 91-119 458-91
 91-118 308-05 A



3116
 ohne Ölfangschale
 without oil pan
 91-120 710-91
 H
 91-160 130-91
 91-120 054-05 A



1474-900/.. m G
 91-119 385-91
 V
 91-119 458-91
 91-118 308-05 A



**1491 (E)-900/..
 A;B m G**
 91-119 385-91
 V
 91-119 458-91
 91-118 308-05 A



3117
 91-267 095-91
 H
 91-267 097-91
 91-138 550-05 A



**1491 (E)-900/..
 B/C o G**
 91-119 899-91
 V
 91-119 458-91
 91-118 308-05 A



3118
 91-138 500-91
 H
 91-138 531-91
 91-138 550-05



**1493 (E)-900/..
 A;B m G**
 91-119 385-91
 V
 91-119 458-91
 91-118 308-05 A



3125 A;B
 91-132 015-91
 CB
 91-130 590-91
 91-002 030-05



**1493 (E)-900/..
 B/C o G**
 91-119 899-91
 V
 91-119 458-91
 91-118 308-05 A



3125 C
 91-132 016-91
 CB
 91-024 423-91
 91-002 030-05

8.0

GREIFER, SPULENKAPSELN UND SPULEN GEORDNET NACH PFAFF-MASCHINENKLASSEN HOOKS, LOOPERS, BOBBIN CASES AND BOBBINS SORTED BY PFAFF MACHINE CLASSES

Maschinenklasse →
Greifer →
Greifertyp →
Spulenkapsel →
Spule (A = Alu) →



3135 A;B
91-132 015-91
CB
91-130 590-91
91-002 030-05



3339 A;B
91-230 413-91
CB
91-130 590-91
91-139 489-05

Machine class →
Hooks →
type of hook →
Bobbin case →
Bobbin (A = Alu) →



3135 C
91-132 016-91
CB
91-024 423-91
91-002 030-05



3339 C
91-230 422-91
CB
91-024 423-91
91-139 489-05



3334
91-132 015-91
CB
91-130 590-91
91-002 030-05



3370 A;B
91-130 117-91
CB
91-130 590-91
91-139 489-05



3335
91-132 015-91
CB
91-130 590-91
91-002 030-05



3370 C
91-110 177-91
H
91-024 423-91
91-139 489-05



3336 A;B
91-130 117-91
CB
91-130 590-91
91-139 489-05



3516-2/45
95-622 902-91
H
91-167 597-91
91-168 144-05 A



3336 C
91-110 177-91
H
91-024 423-91
91-139 489-05



3518-928/62
91-165 800-91
H
91-009 076-61
91-168 144-05 A



3337 A;B
91-130 117-91
H
91-130 590-91
91-139 489-05



3518-929/40;46;/47
95-629 677-91
H
95-629 679-91
91-168 178-05 A



3337 C
91-110 177-91
H
91-024 423-91
91-139 489-05



3518-929/70;/76;/77
95-629 677-91
H
95-629 679-91
91-168 178-05 A



3338 A;B
91-182 703-91
CB
91-182 558-91
91-168 144-05 A























3518-948/82;/92
95-622 902-91
H
91-167 597-91
91-168 144-05 A



3338 C
91-182 655-91
CB
91-182 558-91
91-168 144-05 A



3519-3/12
91-174 475-96
H
91-174 955-91
91-186 492-05 A

	<p>3557 91-174 475-96 H 91-174 955-91 91-186 492-05 A</p>		<p>3574-6/01 91-060 461-91 H 91-009 076-61 91-168 144-05 A</p>
	<p>3566-G-2/01 91-174 475-96 H 91-174 955-91 91-174 480-05 A</p>		<p>3588-02 95-776 515-91 H 91-009 076-61 91-168 144-05 A</p>
	<p>3566-2/01 91-165 800-91 H 91-009 076-61 91-168 144-05 A</p>		<p>3588-04 91-266 504-91 V 91-266 505-91 91-018 480-05 A</p>
	<p>3568-G-1/12 91-174 475-96 H 91-174 955-91 91-186 492-05 A</p>		<p>3701-G-1/01 91-174 475-96 H 91-174 955-91 91-174 480-05 A</p>
	<p>3568-1/12 95-622 902-91 H 91-167 597-91 91-168 144-05 A</p>		<p>3802 m G 91-140 540-91 V 91-140 287-91 91-018 480-05 A</p>
	<p>3568-2/01 91-167 082-91 H 91-167 084-91 91-167 088-05 A</p>		<p>3819-2/01 91-266 685-91 V 91-266 683-91 91-266 241-35 A</p>
	<p>3568-2/11 91-167 082-91 H 91-167 084-91 91-167 088-05 A</p>		<p>3819-2/03 91-266 685-91 V 91-266 683-91 91-266 241-35 A</p>
	<p>3568-12/21 91-167 082-91 H 91-167 084-91 91-167 088-05 A</p>		<p>3822-1/01 91-165 800-91 H 91-009 076-61 91-168 144-05 A</p>
	<p>3574-G-2/01 91-174 475-96 H 91-174 955-91 91-186 492-05 A</p>		<p>3822-1/02 (G) 91-174 475-96 H 91-174 955-91 91-174 480-05 A</p>
	<p>3574-G-2/02 91-174 475-96 H 91-174 955-91 91-174 480-05 A</p>		<p>3822-1/04 91-165 800-91 H 91-009 076-61 91-168 144-05 A</p>

8.0

GREIFER, SPULENKAPSELN UND SPULEN GEORDNET NACH PFAFF-MASCHINENKLASSEN HOOKS, LOOPERS, BOBBIN CASES AND BOBBINS SORTED BY PFAFF MACHINE CLASSES

Maschinenklasse →
Greifer →
Greifertyp →
Spulenkapsel →
Spule (A = Alu) →

3822-1/22 (G)
91-174 475-96
H
91-174 955-91
91-174 480-05 A

9491 L m G
91-010 896-91
V
91-010 159-91
91-010 079-05

Machine class →
Hooks →
type of hook →
Bobbin case →
Bobbin (A = Alu) →

3822-1/24
91-165 800-91
H
91-009 076-61
91-168 144-05 A

9493 S m G
91-010 165-91
V
91-010 159-91
91-010 079-05

3823-1/01
91-165 800-91
H
91-009 076-61
91-168 144-05 A

9493 L m G
91-010 896-91
V
91-010 159-91
91-010 079-05

3826-2/01 m G
91-140 540-91
V
91-140 287-91
91-018 480-05 A

3828-1/01
91-165 800-91
H
91-009 076-61
91-168 144-05 A

3828-1/02
91-165 800-91
H
91-009 076-61
91-168 144-05 A

3834-4/11 m G
91-119 385-91
V
91-119 458-91
91-118 308-05 A

3834-3/11 m G
91-119 385-91
V
91-119 458-91
91-118 308-05 A

3844-1/01
91-265 225-91
H
91-167 597-91
91-168 144-05 A

9491 S m G
91-010 165-91
V
91-010 159-91
91-010 079-05

Greifer-Typen

R = Ringschiffchen
CB = CB-Greifer
H = Umlaufgreifer horizontal
V = Umlaufgreifer vertikal
L = Leder
S = Stoff
m G = mit Gegenspitze
o G = ohne Gegenspitze
* = Greifer kpl.

Hook types

R = beak shuttle
CB = CB-hook
H = horizontal rotary hook
V = vertical rotary hook
L = leather
S = fabric
m G = with heel
o G = without heel
* = complete hook

Maschinenklasse	Kettenstich- greiferpaar	Kettenstich- greifer, vorn	Kettenstich Hilfsgreifer *	Kettenstich- greifer, hinten
Machine class	Chainstitch- looper pair	Chainstitch- looper, front	Chainstitch- looper spreader*	Chainstitch- looper, rear
3300		91-023 345-05	91-023 346-92*	
3300-759		91-023 345-05	91-023 727-92*	
3302		91-023 345-05	91-023 346-92*	
3304		91-023 345-05	91-023 346-92*	
3306		91-066 932-91	91-132 577-92	
3306-7/20		91-180 614-05	91-132 684-92	
3306-9/03		91-110 518-91	91-132 684-92	
3306-9/04		91-110 518-91	91-132 684-92	
3306-17/01		91-180 614-05	91-132 684-92	
3306-17/20		91-180 614-05	91-132 684-92	
3306-32/07		91-110 518-91	91-132 577-92	
3306-39/02		91-180 614-05	91-132 684-92	
3306-39/04		91-180 614-05	91-132 684-92	
3801-1/..		91-170 966-05		
3806-2/..		91-172 376-05		
3811-1/04		91-169 990-05		
3811-2/45		91-169 990-05		
3811-2/55		91-169 990-05		
3811-11/.. Stoff/Fabric		91-170 966-05		
3811-11/.. Leder/Leather		91-169 990-05		
3813		91-170 966-05		
3816-1/..		91-176 055-91		
3819-1/05		91-176 055-91		
3821-1/..		91-170 966-05		
3827-1/03		91-170 966-05		
5463-801-4		91-170 966-05		
5463-801-6		91-170 966-05		
5463-801/13-6		91-170 966-05		
5463-801/13-6-911	91-170 367-00	91-170 368-05		91-169 872-05
5463-H-802-6/01	91-169 883-00	91-169 863-05		91-169 873-05
5463-802-6x1,6	91-169 884-00	91-169 864-05		91-169 874-05
5463-802-6x2,4	91-169 885-00	91-169 865-05		91-169 875-05
5463-802-6x3,2	91-169 886-00	91-169 866-05		91-169 876-05
5463-802-6x4,8	91-169 887-00	91-169 867-05		91-169 877-05
5463-802-6x6,4	91-169 888-00	91-169 868-05		91-169 878-05
5463-802-6x7,2	91-169 889-00	91-169 869-05		91-169 879-05
5463-802-6x10,0	91-169 890-00	91-169 870-05		91-169 880-05
5463-802-6x12,8	91-169 883-00	91-169 863-05		91-169 873-05
5463-802/13-6x1,6	91-169 884-00	91-169 864-05		91-169 874-05
5463-802/13-6x2,4	91-169 885-00	91-169 865-05		91-169 875-05

8.0

GREIFER, SPULENKAPSELN UND SPULEN GEORDNET NACH PFAFF-MASCHINENKLASSEN
HOOKS, LOOPERS, BOBBIN CASES AND BOBBINS SORTED BY PFAFF MACHINE CLASSES

Maschinenklasse	Kettenstich- greiferpaar	Kettenstich- greifer, vorn	Kettenstich Hilfsgreifer *	Kettenstich- greifer, hinten
Machine class	Chainstitch- looper pair	Chainstitch- looper, front	Chainstitch- looper spreader*	Chainstitch- looper, rear
5463-802/13-6x3,2	91-169 886-00	91-169 866-05		91-169 876-05
5463-802/13-6x4,8	91-169 887-00	91-169 867-05		91-169 877-05
5463-802/13-6x6,4	91-169 888-00	91-169 868-05		91-169 878-05
5463-802/13-6x7,2	91-169 889-00	91-169 869-05		91-169 879-05
5463-802/13-6x10,0	91-169 890-00	91-169 870-05		91-169 880-05
5463-802/13-6x12,8		91-169 870-05		91-169 880-05
5463-811/02-94		91-169 711-05		
5463-813/02-45/01		91-170 378-05		
5463-813/02-45/02		91-170 378-05		
5463-821/02-95		91-169 711-05		
5483-H-814/01 1-N		91-169 711-05		
5483-H-814/01 2-Nx6,4		91-169 867-05		91-169 877-05
5483-H-814/01 2-Nx7,2		91-169 868-05		91-169 878-05
5483-H-814/01 3-N		91-176 980-05	91-176 981-05	91-176 982-05
5483-H0-814/01-749/01 1-N		91-172 221-01		
5483-H0-814/02 2-N		91-170 378-05		
5483-R-814/01 1-N		91-170 966-05		
5483-811/01		91-172 554-05		
5483-814/01 1-N		91-170 966-05		
5483-814/01-703/01-733/11;/12 1-N		91-170 966-05		
5483-814/01-731/11;/12 1-N		91-170 966-05		
5483-814/01-748/56 1-N		91-170 966-05		
5483-814/01-944/01 L 1-N		91-169 990-05		
5483-814/01 2-Nx1,6		91-169 863-05		91-169 873-05
5483-814/01 2-Nx2,4		91-169 864-05		91-169 874-05
5483-814/01 2-Nx3,2		91-169 865-05		91-169 875-05
5483-814/01 2-Nx4,8		91-169 866-05		91-169 876-05
5483-814/01 2-Nx6,4		91-169 867-05		91-169 877-05
5483-814/01 2-Nx7,2		91-169 868-05		91-169 878-05
5483-814/01 2-Nx10,0		91-169 869-05		91-169 879-05
5483-814/01 2-Nx11,2		91-169 491-05		91-169 492-05
5483-814/01 2-Nx12,8		91-169 870-05		91-169 880-05
5483-814/01-6/10 2-Nx0,4		91-172 573-05		91-169 872-05
5483-814/01-6/10 2-Nx0,8		91-170 368-05		91-169 872-05
5483-814/01-733/11;/12 2-N		91-169 865-05		91-169 876-05
5483-814/06 2-N		91-169 711-05		
5483-818/55 2-Nx4,8		91-169 866-05		91-169 876-05
5483-818/55 2-Nx6,4		91-169 867-05		91-169 877-05
5483-818/55 2-Nx7,2		91-169 868-05		91-169 878-05
5483-818/56 3-N		91-176 980-05	91-176 981-05	91-176 982-05

Maschinenklasse Machine class	Kettenstich- greiferpaar Chainstitch- looper pair	Kettenstich- greifer, vorn Chainstitch- looper, front	Kettenstich Hilfsgreifer * Chainstitch- looper spreader*	Kettenstich- greifer, hinten Chainstitch- looper, rear
5487-H.706/..-6/41-900/..-911/.. 1-N		91-169 711-05		
5487-H-706/..-6/72-900/..-911/.. 1-N		91-169 711-05		
5487-H-706/..-6/81 (-900/71) 1-N		91-170 966-05		
5487-H-706/..-6/81-900/71-971/23 1-N		91-170 966-05		
5487-H-706/..-6/87-900/..-911/.. 1-N		91-169 711-05		
5487-706/.. 1-N		91-170 966-05		
5487-811/01-900/75		91-172 554-05		
5487-814/01 2-Nx0,8		91-169 862-05		91-169 872-05
5487-814/01 2-Nx1,6		91-169 863-05		91-169 873-05
5487-814/01 2-Nx2,4		91-169 864-05		91-169 874-05
5487-814/01 2-Nx3,2		91-169 865-05		91-169 875-05
5487-814/01 2-Nx4,8		91-169 866-05		91-169 876-05
5487-814/01 2-Nx6,4		91-169 867-05		91-169 877-05
5487-814/01 2-Nx7,2		91-169 868-05		91-169 878-05
5487-814/01 2-Nx10,0		91-169 869-05		91-169 879-05
5487-814/01 2-Nx12,8		91-169 870-05		91-169 880-05
5487-814/06-706/83 2-N		91-169 711-05		
5487/5489		91-170 966-05		
5489-H 2-Nx6,4		91-169 867-05		91-169 877-05
5489-H 2-Nx7,2		91-169 868-05		91-169 878-05
5489-H 3-N		91-176 980-05	91-176 981-05	91-176 982-05
5489		91-170 966-05		
5642		91-176 055-91		
5642-61/21		91-178 624-91		
5642-61/31		91-178 624-91		
5642-748/58-900/..		91-177 657-91		
5645		91-177 868-91		
5646		91-177 868-91		
5695		91-177 868-91		
5696		91-177 868-91		
Greifer-Typen R = Ringschiffchen CB = CB-Greifer H = Umlaufgreifer horizontal V = Umlaufgreifer vertikal L = Leder S = Stoff m G = mit Gegenspitze o G = ohne Gegenspitze * = Greifer kpl.		Hook types R = beak shuttle CB = CB-hook H = horizontal rotary hook V = vertical rotary hook L = leather S = fabric m G = with heel o G = without heel * = complete hook		

8. GREIFER, SPULENKAPSELN UND SPULEN *HOOKS, LOOPERS, BOBBIN CASES AND BOBBINS*

8.1 SCHIFFCHEN UND GREIFERARTEN *SHUTTLES AND HOOK TYPES*

8.1

Schiffchen und Greiferarten bei Doppelsteppstich-Nähmaschinen Shuttles and Hooks Incorporated in Lockstitch Sewing Machines

Oszillierendes Zentralspulenschiffchen und Ringschiffchen Oscillating Central Bobbin Shuttle and Beak Shuttle



CB-Schiffchen
vollständig
CB shuttle,
complete



Schiffchenkörper
Shuttle body



Spulenkapsel
Bobbin case



Spule
Bobbin



Ringschiffchen
vollständig
Beak shuttle,
complete



Spule
Bobbin

Umlaufender Horizontalgreifer Horizontal Rotary Hook



Greifer
vollständig
Hook,
complete



Greiferkörper
Hook body



Greiferbügel
Hook gib



Spulenkapsel-
Unterteil
Hook
base



Spulenkapsel-
Oberteil
Bobbin
case



Spule
Bobbin

Großer umlaufender Horizontalgreifer Extra-large Horizontal Rotary Hook



Greifer
vollständig
Hook,
complete



Greiferkörper
Hook body



Greiferbügel und
Nadelschutz
Hook gib and
needle guard



Spulenkapsel-
Unterteil
Hook
base



Spulenkapsel-
Oberteil
Bobbin
case



Spule
Bobbin

Umlaufender Vertikalgreifer Vertical Rotary Hook



Greifer
vollständig
Hook,
complete



Greiferkörper
Hook body



Greiferbügel und
Nadelschutz
Hook gib and
needle guard



Spulenkapsel-
Unterteil
Hook
base



Spulenkapsel-
Oberteil
Bobbin
case



Spule
Bobbin

9: FORMULARE *FORMS*

9.0 BESTELLFORMULAR *ORDER FORM*

9: FORMULARE *FORMS*

9.1 IHRE ANREGUNGEN *YOUR SUGGESTIONS*

--	--	--	--	--	--	--	--

Kundennummer (falls bekannt)

Firma / Name

Straße

Postleitzahl

Ort

Telefon

Telefax

Land

Durch das Ausfüllen dieses Formulars helfen Sie uns Ihnen den bestmöglichen Service zu bieten und unseren Katalog nach Ihren Bedürfnissen zu überarbeiten.

Für Ihre Unterstützung bedanken wir uns bereits im Voraus

Name Ihres betreuenden Händlers

- 1:
- Der Katalog ist übersichtlich
 - Der Katalog ist unübersichtlich, weil ...

- 2:
- Das Katalogangebot deckt den größten Teil des Zubehörbedarfs ab
 - Das Katalogangebot deckt lediglich einen geringen Teil des Zubehörbedarfs ab
 - Es sollten noch folgende Bereiche aufgenommen werden:

- 3:
- Die Betreuung durch meinen Händler ist gut
 - Die Betreuung durch meinen Händler könnte besser sein, da

- 4:
- Die Qualität der gelieferten Teile hat meine Erwartungen übertroffen
 - Die Qualität der gelieferten Teile hat meinen Erwartungen entsprochen
 - Die Qualität der gelieferten Teile hat meine Erwartungen nicht erfüllt

- Die Liefergeschwindigkeit ist zufriedenstellend
- Die Liefergeschwindigkeit ist nicht zufriedenstellend
- Die Liefergenauigkeit ist zufriedenstellend
- Die Liefergenauigkeit ist nicht zufriedenstellend

- 5:
- Der Katalog beinhaltet ein marktgerechtes Angebot
 - Ich werde den Katalog auch künftig verwenden
 - Ich werde den Katalog künftig nur dann verwenden, wenn

Bitte senden Sie dieses Formular an unsere Faxnummer +49 (0)631 - 200 1386

PFAFF-INDUSTRIAL@ddition

YOUR SUGGESTIONS

--	--	--	--	--	--	--	--

Customer number(if available)

Company / Name

Street

Postal Code

Town

Phone

Fax

Country

By filling out this form, you are helping us to provide the best possible service and to revise our catalogue to meet your requirements.

Thank you in advance for your support.

Name of your dealer

- 1:
- The catalogue is easy to use
 - The catalogue is not easy to use because...

- 2:
- The catalogue covers the major part of our requirements for accessories
 - The catalogue only covers a small part of our requirements for accessories
 - Following sectors should be included:

- 3:
- My dealer treats me very well
 - There is room for improvement in the way my dealer treats me ...

- The delivery time is satisfactory
- The delivery time is unsatisfactory
- The accuracy of the delivery is satisfactory
- The accuracy of the delivery is unsatisfactory

- 4:
- The quality of the parts delivered exceeded my expectations
 - The quality of the parts delivered met up to my expectations
 - The quality of the parts delivered did not fulfil my expectations

- 5:
- The catalogue offers market coverage
 - I shall be using the catalogue in future
 - In future, I shall only use the catalogue, when...

Please send this form to our Fax-no. +49 (0)631 - 200 1386

PFAFF-INDUSTRIAL@ddition

VOS ATTENTES

--	--	--	--	--	--	--	--

Numéro de client (si connu)

Société/ Nom

Rue

Code postal

Ville

Téléphone

Télécopie

Pays

En remplissant ce formulaire, vous nous permettrez de vous proposer nos meilleur services, et d'améliorer notre catalogue selon vos attentes.

Merci beaucoup.

Nom de votre fournisseur régulier

- 1: Le catalogue est clair
 Le catalogue n'est pas clair, parce que ...

- 2: Le catalogue couvre la plus grande partie des besoins d'accessoires
 Le catalogue couvre l'essentiel des besoins d'accessoires
 Il faudrait en plus que les pointes suivants apparaissent:

- 3: L'assistance de mon fournisseur est bonne
 L'assistance de mon fournisseur pourrait être mieux, étant donné que ...

- Le délai de livraison est satisfaisant
 Le délai de livraison n'est pas satisfaisant
 Les nouveautés de livraison sont satisfaisantes
 Les nouveautés de livraison ne sont pas satisfaisantes

- 4: La qualité de livraison des pièces a été au delà mes attentes
 La qualité de livraisons des pièces a été à la hauteur de mes attentes
 La qualité de livraison des pièces n'a pas honoré mes attentes

- 5: Le catalogue contient une offre conforme aux conditions du marché
 A l'avenir, j'utiliserai ce catalogue plus souvent
 J'utiliserai ce catalogue plus souvent, uniquement si ...

S'il vous plaît envoyez ce formulaire à notre FAX +49 (0)631 - 200 1386

PFAFF-INDUSTRIAL@ddition

SUS SUGERENCIAS

--	--	--	--	--	--	--	--

Numero del cliente (si es conocido)

Razón social / Nombre

Calle

Código postal

Lugar

Teléfono

Telefax

País

Rellenando este formulario, ustedes nos ayuden de presentarles el mejor servicio posible y de revisar nuestro catálogo según vuestras demandas.

De antemano les agradecemos por su apoyo.

Nombre de su representante responsable

- 1:
- El catálogo es claramente dispuesto
 - El catálogo no es claramente dispuesto, porque ...

- 2:
- El catálogo cubre la mayor parte de la demanda de accesorios
 - El catálogo cubre solamente una pequeña parte de la demanda de accesorios
 - Los siguientes ramos debían ser agregados:

- 3:
- El asesoramiento por mi representante es bueno
 - El asesoramiento por mi representante podía ser mejor, porque ...

- El tiempo de entrega es satisfactorio
- El tiempo de entrega no es satisfactorio
- La exactitud de la entrega es satisfactorio
- La exactitud de la entrega no es satisfactorio

- 4:
- La calidad de las piezas suministradas ha superado lo esperado
 - La calidad de las piezas suministradas está conforme con lo esperado
 - La calidad de las piezas suministradas no ha cumplido lo esperado

- 5:
- El catálogo contiene un ofrecimiento adecuado al mercado
 - Utilizaré el catálogo también en el futuro
 - Utilizaré el catálogo en el futuro solamente si ...

Favor mandar este formulario a nuestra FAX +49 (0)631 - 200 1386

10: INDEX *INDEX*

Abreißmesser für MAUSER-SPEZIAL	1.7 - 2 1.7 - 3 1.7 - 4 1.7 - 5	Ausgleichsgelenkfuß, linksfedernd, für Nadeltransport	1.2 - 5
Abreißmesser für PEGASUS	1.6	Ausgleichsgelenkfuß, rechtsfedernd	1.1 - 5 1.1 - 7 1.1 - 8
Absaugvorrichtung	1.9 - 4	Ausgleichsgelenkfuß, rechtsfedernd, für Nadeltransport	1.2 - 4
Anlassermotor	1.13 - 3	Ausgleichsgelenkfuß, rechtsfedernd, für zwei Nahtbreiten	1.1 - 9
Anlassermotor (Ersatzteile)	1.13 - 3	Auszackmaschinenzubehör	2.5 - 3
Anprobierverspiegel	4.5 - 2		
Antriebsgurte SINGER	1.5 - 157		
Antriebsriemen REECE	1.5 - 134	Bandabschneider für PFAFF	7.1 - 2 7.1 - 3
Apparat zum Fertigen elastischer Träger	1.8 - 76	Bandabwickelständer	1.14 - 9
Apparatefuß, starr	1.1 - 24	Bandabzugsgerät	1.11 - 2
Apparatefüße DUERKOPP - ADLER	1.5 - 21 1.5 - 23 1.5 - 27	Bandbremse	1.8 - 81
Apparatefüße PFAFF	1.5 - 112 1.5 - 114 1.5 - 121	Bandeinfasser mit doppeltem Umbug	1.8 - 14 bis 1.8 - 18
Apparatehalterung	1.8 - 82 1.8 - 83	Bandeinfasser mit Umbug oben	1.8 - 21 bis 1.8 - 25
Apparatestichplatte für Säumer und Einfasser	1.1 - 40	Bandeinfasser ohne Umbug	1.8 - 26 bis 1.8 - 36
Apparatestichplatte mit Ausschnitt für Schrägbandeinfasser	1.1 - 41	Bandführung mit Flachbettbefestigung	1.8 - 78
Ausgleichsfuß DUERKOPP - ADLER	1.5 - 33	Bandführungsfuß mit Bandbremse	1.1 - 21
Ausgleichsfuß PFAFF	1.5 - 105	Bandführungsfuß, links	1.1 - 21
Ausgleichsfuß SINGER	1.5 - 168	Bandführungsfuß, mittig	1.1 - 20
Ausgleichsgelenkfuß	1.1 - 23	Bandführungsfuß, rechts	1.1 - 20
Ausgleichsgelenkfuß links, schmal, für Normaltransport, metrisch	1.1 - 6 1.1 - 8	Bandführungsfuß, verstellbar	1.1 - 19
Ausgleichsgelenkfuß rechts, mit niedrigem Schaft	1.1 - 9	Bandmesser mit doppelter Wate	2.4 - 2
Ausgleichsgelenkfuß rechts, schmal, für Normaltransport, metrisch	1.1 - 6 1.1 - 8	Bandrollenhalter	1.14 - 10 1.14 - 11
Ausgleichsgelenkfuß, doppelfedernd	1.1 - 6 1.1 - 9	Bandtrenner	1.9 - 3
Ausgleichsgelenkfuß, doppelfedernd, für Nadeltransport	1.2 - 5	Befestigungsschrauben für Kantenführungen und Apparate	1.10 - 5
Ausgleichsgelenkfuß, linksfedernd	1.1 - 5 1.1 - 7	Befestigungsschrauben für MAUSER-SPEZIAL	1.7
		Befestigungsschrauben für PEGASUS	1.6
		Befestigungsschrauben für PFAFF	7.0
		Berufsschere	2.7 - 15
		Bestellformular	9.0
		Biegefeder für PFAFF	7.0

Blasebalg	5.3 - 2	CB-Greifer für SINGER	1.4 - 22 1.4 - 24 1.4 - 28 1.4 - 29
Blindstichgreifer BROTHER	1.5 - 6	Cutter-Messer	2.1 - 2 2.1 - 3
Blindstichgreifer LEWIS	1.5 - 73	Diamant - Nadelfeilen	5.3 - 6
Blindstichgreifer MAUSER-SPEZIAL	1.5 - 82	Doppelkapper für Arm-Abwärtsmaschinen	1.8 - 49
Blindstichgreifer STROBEL	1.5 - 175	Doppelkapper für Flachbettmaschinen	1.8 - 50
Blindstichgreifer TREASURE	1.5 - 176	Einfädler	1.16 - 2
Blindstichgreifer UNION-SPECIAL	1.5 - 176	Einringschere	2.7 - 6 2.7 - 7
Block DUERKOPP - ADLER	1.5 - 42 1.5 - 44	Einsatz PFAFF	1.5 - 125
Block REECE	1.5 - 130 1.5 - 132	Einstelllehren	5.3 - 9
Bohrnadel	3.1 - 2	Etiketten - Auszeichnungsgерäte für selbstklebende Etiketten	4.4 - 4
Börtchenapparat mit doppeltem Umbug	1.8 - 37	Etikettenheftzange	4.4 - 2
Börtchenapparat mit Gummibandzuführung	1.8 - 47 1.8 - 48	Etikettenheftzange (Ersatznadeln)	4.4 - 2
Börtchenapparat mit Umbug oben	1.8 - 42	Fadenanzugsfeder DUERKOPP - ADLER	1.5 - 31 1.5 - 36
Börtchenapparat mit versetztem Umbug oben	1.8 - 39 1.8 - 41	Fadenanzugsfeder JUKI	1.5 - 49 1.5 - 54 1.5 - 55 1.5 - 57 1.5 - 58
Börtchenapparat ohne Umbug	1.8 - 44 1.8 - 46	Fadenanzugsfeder PFAFF	1.5 - 106 1.5 - 117 7.0
Bremsfeder für PFAFF	7.0	Fadenanzugsfeder REECE	1.5 - 131 1.5 - 132
Buchse RIMOLDI-NECCI	1.5 - 143	Fadenanzugsfeder SINGER	1.5 - 150 1.5 - 163 1.5 - 164 1.5 - 170
Bügelböcke	4.3 - 3	Fadenführung DUERKOPP - ADLER	1.5 - 36
Bügelkissen	4.3 - 2	Fadenführung für MAUSER-SPEZIAL	1.7 - 6 1.7 - 7
Bundapparat mit doppeltem Umbug	1.8 - 19	Fadenführung JUKI	1.5 - 49 1.5 - 54
Bundapparat mit doppeltem Umbug für Elastikbund	1.8 - 20	Fadenführung SINGER	1.5 - 158 1.5 - 168
Bundapparat mit Umbug oben für Elastikbund	1.8 - 20	Fadenschere JUKI	1.5 - 54
Bundapparat, zweiteilig	1.8 - 20		
CB-Greifer für BROTHER	1.4 - 5 1.4 - 6		
CB-Greifer für DUERKOPP - ADLER	1.4 - 9 1.4 - 13		
CB-Greifer für JUKI	1.4 - 13 1.4 - 17		
CB-Greifer für MITSUBISHI	1.4 - 21		

Fadenschere PFAFF	1.5 - 108 1.5 - 111	Gelenkkederfuß, Kordel rechts	1.1 - 15
Fadenschere REECE	1.5 - 131	Gelenkpresserfuß	1.1 - 22
Fadenschere RIMOLDI-NECCI	1.5 - 141	Gelenkpresserfuß für Standard-Nadeltransport- maschinen	1.2 - 3
Fadenschergerät	4.2 - 2	Gelenkpresserfuß mit gleichlangen Zehen	1.1 - 4
Fadenschergerät (Zubehör)	4.2 - 2	Gelenkpresserfuß mit Teflonsohle	1.1 - 30
Fadenzieher UNION SPECIAL	1.5 - 177 1.5 - 194	Gelenkpresserfuß, rechte Zehe verkürzt	1.1 - 3
Fänger BROTHER	1.5 - 17	Glasfaser-Nähleuchten	1.12 - 4
Fänger JUKI	1.5 - 58	Glasfaser-Nähleuchten (Zubehör)	1.12 - 4
Fänger PFAFF	7.0	Glühlampe mit Schraubsockel	1.12 - 9
Fänger REECE	1.5 - 134	Glühlampe mit Stecksockel	1.12 - 8
Farbrollen für Etikettierer	4.4 - 5	Greifer (ohne Spulenkapsel) für ALTIN (Textima)	1.4 - 3
Fatex-Riemen	1.13 - 11	Greifer (ohne Spulenkapsel) für BROTHER	1.4 - 3 bis 1.4 - 7
Feder DUERKOPP-ADLER	1.5 - 31	Greifer (ohne Spulenkapsel) für CONSEW	1.4 - 7 bis 1.4 - 9
Feder JUKI	1.5 - 57	Greifer (ohne Spulenkapsel) für DUERKOPP - ADLER	1.4 - 9 bis 1.4 - 13
Feder PFAFF	1.5 - 125	Greifer (ohne Spulenkapsel) für JUKI	1.4 - 13 bis 1.4 - 18
Feder REECE	1.5 - 131	Greifer (ohne Spulenkapsel) für MITSUBISHI	1.4 - 19 bis 1.4 - 21
Feder SINGER	1.5 - 163 1.5 - 165	Greifer (ohne Spulenkapsel) für SINGER	1.4 - 22 bis 1.4 - 32
Filter für MAUSER-SPEZIAL	1.7	Greiferhalter SINGER	1.5 - 168
Filter für PEGASUS	1.6	Greiferschiffchen für CONSEW	1.4 - 9
Fingerschutz	1.16 - 3	Greiferschiffchen für DUERKOPP - ADLER	1.4 - 9
Flip - up - Nadelhalter	1.3 - 4	Greiferschiffchen für SINGER	1.4 - 22 1.4 - 24
Fuß mit Lineal	1.1 - 11	Gummibandeinfasser ohne Umbug	1.8 - 47
Fuß mit Lineal für MAUSER-SPEZIAL	1.7 - 2	Gummibandführung	1.8 - 79
Fußanlasser	1.13 - 6	Gürtelapparat	1.8 - 21
Fußtritt	1.14 - 5	Gürtelwender	4.1 - 2
Garnrollenmagazin	1.14 - 8		
Garnständer	1.14 - 9		
Gegenschneidklinge für Kreismessermaschine	2.2 - 8		
Gelenkfuß mit Kantenanschlag, links	1.1 - 10		
Gelenkfuß mit Kantenanschlag, rechts	1.1 - 10		
Gelenkkederfuß, Kordel links	1.1 - 15		

Haftetiketten	4.4 - 5	Kantengelenkfuß, links	1.1 - 12
Halogenbirne	1.12 - 6	Kantengelenkfuß, rechts	1.1 - 12
Halogenleuchte	1.12 - 5	Kantengummi	1.14 - 3
Handarbeitsschere	2.7 - 2 bis 2.7 - 4	Kantenlineal	1.10 - 4
Handstückzähler	3.2 - 6	Kapper mit Gummibandzuführung	1.8 - 66 1.8 - 67
Haushaltsnähmaschinenbedarf	1.15 - 2 1.15 - 3 1.15 - 8 1.15 - 9 1.15 - 10 1.15 - 11	Kapper mit Kordelzuführung	1.8 - 64
Haushaltsnähmaschinenmotor (Anbau)	1.13 - 4	Kapper mit Umbug oben	1.8 - 54
Haushaltsnähmaschinenmotor (Einbau)	1.13 - 5	Kapper mit Umbug unten	1.8 - 55 1.8 - 56
Heftfäden	4.4 - 3	Kappfuß mit Umbug oben	1.1 - 27
Heißsiegelbügelleisen	3.4 - 2	Kappfuß mit Umbug unten	1.1 - 28
Heizkeil für PFAFF	7.1 - 5	Kederfuß	1.1 - 18
Heizpatrone für PFAFF	7.1	Kederfuß, doppelte Rille	1.1 - 18
Hochklappbares Lineal	1.10 - 2 1.10 - 3	Kederfuß DUERKOPP-ADLER	1.5 - 21 1.5 - 27 1.5 - 36 1.5 - 37
Kaltlicht-Leuchte	1.12 - 7	Kederfuß starr, Kordel links	1.1 - 17
Kanten- und Reißverschlußfuß mit Teflon-Sohle	1.1 - 31	Kederfuß starr, Kordel rechts	1.1 - 16
Kantenfuß BROTHER	1.5 - 14 1.5 - 16 1.5 - 18	Kederfüße BROTHER	1.5 - 14 1.5 - 16 1.5 - 18
Kantenfuß CONSEW	1.5 - 18	Kederfüße CONSEW	1.5 - 18
Kantenfuß DUERKOPP-ADLER	1.5 - 21 1.5 - 27 1.5 - 33 1.5 - 36 1.5 - 37	Kederfüße PFAFF	1.5 - 110
Kantenfuß mit Anschlagfeder, rechts	1.1 - 11	Kederfüße SEIKO	1.5 - 149
Kantenfuß PFAFF	1.5 - 105 1.5 - 110	Kederfüße SINGER	1.5 - 158
Kantenfuß SEIKO	1.5 - 149	Keilriemen	1.13 - 8 1.13 - 9 1.13 - 10
Kantenfuß SINGER	1.5 - 158	Keilriemenscheibe	1.13 - 7
Kantenfuß, starr, links	1.1 - 13	Keramikmesser BROTHER	1.5 - 9
Kantenfuß, starr, rechts	1.1 - 13	Keramikmesser EAGLE	1.5 - 47
Kantengelenkfuß, für Nadeltransport	1.2 - 6	Keramikmesser JUKI	1.5 - 66
		Keramikmesser MAUSER-SPEZIAL	1.5 - 79
		Keramikmesser PEGASUS	1.5 - 92
		Keramikmesser PFAFF	1.5 - 128
		Keramikmesser REECE	1.5 - 128
		Keramikmesser SINGER	1.5 - 173

Keramikmesser SIRUBA	1.5 - 173	Kettenstichgreifer REECE	1.5 - 128 1.5 - 131
Keramikmesser UNION SPECIAL	1.5 - 176 1.5 - 186	Kettenstichgreifer RIMOLDI-NECCI	1.5 - 134 1.5 - 135
Keramikmesser WILLCOX & GIBBS	1.5 - 198	Kettenstichgreifer SINGER	1.5 - 141 1.5 - 143 1.5 - 145 1.5 - 148
Keramikmesser YAMATO	1.5 - 204 1.5 - 212	Kettenstichgreifer SINGER	1.5 - 150 1.5 - 156 1.5 - 160 1.5 - 163 1.5 - 164 1.5 - 166 1.5 - 167 1.5 - 169 1.5 - 171
Kerbschnittzange	3.1 - 2	Kettenstichgreifer SIRUBA	1.5 - 173
Kernlederrundriemen	1.13 - 12	Kettenstichgreifer STROBEL	1.5 - 175
Kettenspanner für PFAFF	7.1	Kettenstichgreifer UNION SPECIAL	1.5 - 177 bis 1.5 - 181 1.5 - 186 bis 1.5 - 196
Kettenstichgreifer JUKI	1.5 - 52 1.5 - 59 1.5 - 60 1.5 - 61 1.5 - 62 1.5 - 63 1.5 - 66	Kettenstichgreifer WILLCOX & GIBBS	1.5 - 198 1.5 - 202
Kettenstichgreifer (Haushaltsnähmaschinen)	1.15 - 6	Kettenstichgreifer YAMATO	1.5 - 204 1.5 - 205 1.5 - 207 1.5 - 209 1.5 - 210 1.5 - 212 1.5 - 214
Kettenstichgreifer ALTIN (Textima)	1.5 - 2	Kettentrenner mit Absaugung hinter der Nadel	1.9 - 2
Kettenstichgreifer BROTHER	1.5 - 5 1.5 - 7 bis 1.5 - 13 1.5 - 17	Kettentrenner mit Absaugung seitlich hinter dem Presserfuß	1.9 - 2
Kettenstichgreifer CONSEW	1.5 - 20	Klemme PFAFF	1.5 - 111
Kettenstichgreifer DUERKOPP-ADLER	1.5 - 26 1.5 - 44 1.5 - 45	Knopfklammer BROTHER	1.5 - 5
Kettenstichgreifer KANSAI	1.5 - 69 1.5 - 70 1.5 - 71 1.5 - 72	Knopfklammer CONSEW	1.5 - 19
Kettenstichgreifer LEWIS	1.5 - 73 1.5 - 74	Knopfklammer JUKI	1.5 - 59
Kettenstichgreifer MAUSER-SPEZIAL	1.5 - 76 1.5 - 79 1.5 - 83 1.5 - 84 1.7	Knopfklammer LEWIS	1.5 - 74
Kettenstichgreifer MERROW	1.5 - 85	Knopfklammer MAUSER-SPEZIAL	1.5 - 77
Kettenstichgreifer PEGASUS	1.5 - 92 1.5 - 94 1.5 - 96 1.5 - 100 1.5 - 101 1.5 - 102 1.5 - 103 1.6	Knopfklammer SINGER	1.5 - 160
Kettenstichgreifer PFAFF	1.5 - 124 1.5 - 126 1.5 - 127	Knopfklammerersatzteile CONSEW	1.5 - 19
		Knopfklammerersatzteile LEWIS	1.5 - 74
		Knopfklammerersatzteile MAUSER-SPEZIAL	1.5 - 77
		Knopfklammerersatzteile SINGER	1.5 - 160

Knopfleistenapparat	1.8 - 79	Lineal	3.2 - 4
Knopflochmesser 90° BROTHER	1.5 - 14	Linkshänderschere	2.7 - 11
Knopflochmesser 90° DUERKOPP-ADLER	1.5 - 40	Locheisen	3.1 - 3
Knopflochmesser 90° JUKI	1.5 - 53 1.5 - 54	Lochzange	3.1 - 3
Knopflochmesser 90° PFAFF	1.5 - 123	Lupen	3.2 - 6
Knopflochmesser 90° RIMOLDI-NECCI	1.5 - 136 1.5 - 137	Magnetlineal	1.10 - 4
Knopflochmesser 90° SINGER	1.5 - 154	Manufakturschere	2.7 - 14
Knopflochmesser BROTHER	1.5 - 14	Markierstift mit Wechselmine	3.3 - 4
Knopflochmesser DUERKOPP-ADLER	1.5 - 39 1.5 - 40	Maschinenabdeckhaube	1.14 - 12
Knopflochmesser JUKI	1.5 - 53 1.5 - 60	Maßband	3.2 - 2 3.2 - 3
Knopflochmesser PFAFF	1.5 - 123	Messer (Haushaltsnämaschinen)	1.15 - 4
Knopflochmesser REECE	1.5 - 133	Messer ALTIN (Textima)	1.5 - 2
Knopflochmesser RIMOLDI-NECCI	1.5 - 136	Messer BERNINA	1.5 - 4
Knopflochmesser SINGER	1.5 - 153	Messer BROTHER	1.5 - 5 bis 1.5 - 17
Knopflochschere	2.7 - 13	Messer CLINTON	1.5 - 18
Kondensator	1.13 - 12	Messer DUERKOPP-ADLER	1.5 - 23 bis 1.5 - 46
Kopierrädchen	3.3 - 6	Messer EAGLE	1.5 - 47
Kragenbandapparat für Polo-Shirts	1.8 - 76	Messer JUKI	1.5 - 48 bis 1.5 - 68
Kragenwender	4.1 - 2	Messer KANSAI	1.5 - 70 1.5 - 71 1.5 - 72
Kräuselfuß	1.1 - 28	Messer MAUSER-SPEZIAL	1.5 - 76 1.5 - 78 1.5 - 79 1.5 - 83 1.5 - 84 1.7 - 2 1.7 - 3 1.7 - 4 1.7 - 5
Kreidepulver	3.3 - 7	Messer MERROW	1.5 - 85
Kreideschärfer	3.3 - 6	Messer MITSUBISHI	1.5 - 86 1.5 - 87 1.5 - 88 1.5 - 89
Kreidestift	3.3 - 3		
Kreidezeichner	3.3 - 7		
Kreismesser	2.2 - 2 bis 2.2 - 7		
Kupplungsmotor	1.13 - 2		
Kupplungsmotor (Ersatzteile)	1.13 - 2		
Lasert	1.12 - 2 1.12 - 3		
Leuchtstoffröhren, weiss	1.12 - 8		

Messer PEGASUS	1.5 - 90 1.5 - 92 1.5 - 100 1.5 - 101 1.5 - 102 1.5 - 103 1.6	Motorkohle	1.13 - 13 1.13 - 14
Messer PFAFF	1.5 - 104 1.5 - 107 1.5 - 108 1.5 - 113 bis 1.5 - 127 7.0	Nadeldreieck	3.5 - 3
Messer REECE	1.5 - 128 1.5 - 129 1.5 - 130 1.5 - 134 1.5 - 135	Nadelführung für MAUSER-SPEZIAL	1.7 - 7
Messer RIMOLDI-NECCI	1.5 - 137 1.5 - 138 1.5 - 139 1.5 - 141 1.5 - 145 1.5 - 147 1.5 - 148	Nadelhalter BROTHER	1.5 - 8
Messer SINGER	1.5 - 150 1.5 - 151 1.5 - 152 1.5 - 155 1.5 - 156 1.5 - 164 1.5 - 166 1.5 - 169 1.5 - 170 1.5 - 171	Nadelhalter für Standard-Zweinadel- Maschinen	1.3 - 3 1.3 - 4
Messer SIRUBA	1.5 - 173	Nadelhalter JUKI	1.5 - 55 1.5 - 56 1.5 - 68
Messer UNION SPECIAL	1.5 - 176 bis 1.5 - 196	Nadelhalter SINGER	1.5 - 162 1.5 - 168
Messer WILLCOX & GIBBS	1.5 - 197 1.5 - 198 1.5 - 202 1.5 - 203	Nadelkissen	3.5 - 6
Messer YAMATO	1.5 - 205 1.5 - 207 1.5 - 208 1.5 - 209 1.5 - 210 1.5 - 212	Nadelleiste	3.5 - 3
Messerhalter ALTIN (Textima)	1.5 - 2	Nadelschutz für PEGASUS	1.6
Messerschleifmaschine	5.3 - 8	Nadelstange für Standard-Zweinadel- Maschinen	1.3 - 5
Metallmaschenschutzhandschuh	2.6 - 4	Nadelstange PFAFF	1.5 - 110 1.5 - 111 7.0
Montageteile	1.14 - 7	Nähereistuhl	1.14 - 2
Montagewinkel	1.14 - 7	Nähleuchten-Zubehör	1.12 - 7
		Nähmaschinen - Untergestelle	1.14 - 3
		Nähmaschinennadeln	6.0 6.1
		Nahtprüfgerät	7.1 - 5
		Nahtprüfstation	7.1 - 5
		Nahttrenner	2.7 - 17
		Öl für Nähmaschinen	5.1 - 2
		Ölbehälter	5.1 - 3
		Paspelapparat	1.8 - 68 bis 1.8 - 71
		Paspelführung	1.8 - 72
		Pinsel	5.3 - 2
		Pinzette	5.3 - 3
		Polierleinen	5.3 - 8

Polierschnur	5.3 - 7	Säumer mit Umbug unten	1.8 - 63 1.8 - 64
Positionsfinger JUKI	1.5 - 59	Säumerfuß für Zick-Zack-Maschinen	1.1 - 26
Presserfuß für MAUSER-SPEZIAL	1.7	Säumerfuß, gefedert	1.1 - 25
Presserfuß für PEGASUS	1.6	Säumerfuß, starr	1.1 - 26
Presserfuß für PFAFF	7.0	Schalter	1.13 - 15
Presserfuß für verdeckten Reißverschluss	1.1 - 14	Scharnierhaken	1.14 - 4
Presserstange PFAFF	1.5 - 110	Scharnierlager	1.14 - 4
PTFE-Folie, weiß	5.2 - 2	Scheren	2.7
PTFE-Glasgewebefolie	5.2 - 2	Scherenschleifmaschine	5.3 - 8
Puller	1.11 - 3 1.11 - 4	Schieberplatte für Standard-Zweinadel-Maschinen	1.3 - 8
Reibring für PFAFF	7.0	Schlaufenapparat	1.8 - 74 1.8 - 76 1.8 - 77
Reißverschußfuß	1.1 - 14	Schlaufenfaltefuß für Standard-Zweinadel-Maschinen	1.3 - 7
Reißverschußfuß DUERKOPP-ADLER	1.5 - 33	Schlaufenfaltefuß für Untertransport	1.1 - 19
Reißverschußfuß für Nadeltransport	1.2 - 7	Schlaufenwender	4.1 - 3
Relais für PFAFF	7.1 - 3 7.1 - 4	Schleifbändchen für Cutter	2.1 - 4
Reverswinkel	3.2 - 5	Schleifbändchen für Stoßmessermaschinen	2.3 - 5
Revolverkopf-Nähfußhalter	1.2 - 3	Schleifmaschine (Zubehör)	5.3 - 9
Riemenhaken	1.13 - 12	Schleifstein für Bandmessermaschinen	2.4 - 3
Rockabrunder	3.4 - 2 3.4 - 3	Schleifstein für Kreismessermaschinen	2.2 - 8
Rollbandfuß	1.1 - 29	Schleifstein für Stoßmessermaschinen	2.3 - 6
Rollfuß	1.1 - 29	Schleifsteine für Cutter	2.1 - 5
Rollfuß PFAFF	1.5 - 106	Schmirgelband	5.3 - 7
Rollsaumfuß	1.1 - 25	Schmirgelleinen	5.3 - 8
Rollschneider	2.7 - 15	Schmirgelschnur	5.3 - 7
Rollschneider (Zubehör)	2.7 - 16	Schneidbrücke SINGER	1.5 - 155
Rollständer	4.5 - 2	Schneiderbüste	3.4 - 4 3.4 - 5
Samtbügelunterlagen	4.3 - 4	Schneiderkreide	3.3 - 2
Säumer mit Gummibandzuführung	1.8 - 65 1.8 - 67	Schneiderschere	2.7 - 7 bis 2.7 - 10
Säumer mit Kordelzuführung	1.8 - 65	Schnittbefestigungsnadeln	3.5 - 2
Säumer mit Umbug oben	1.8 - 57 bis 1.8 - 62		

Schrägbandeinfasser mit doppeltem Umbug	1.8 - 5 bis 1.8 - 12	Spreizer REECE	1.5 - 131
Schrägbandeinfasser mit Gummibandzuführung	1.8 - 13	Spreizer SINGER	1.5 - 168
Schraube BROTHER	1.5 - 9 1.5 - 11	Spreizer UNION SPECIAL	1.5 - 180 1.5 - 194
Schraube MAUSER-SPEZIAL	1.5 - 81	Spreizer YAMATO	1.5 - 209
Schraube PEGASUS	1.5 - 96	Spreizerplatte DUERKOPP-ADLER	1.5 - 44
Schraube RIMOLDI-NECCI	1.5 - 143	Spule (Alu) für BROTHER	1.4 - 3 bis 1.4 - 7
Schraube WILLCOX & GIBBS	1.5 - 201	Spule (Alu) für CONSEW	1.4 - 8
Schraube YAMATO	1.5 - 207	Spule (Alu) für DUERKOPP - ADLER	1.4 - 9 bis 1.4 - 13
Schraubendreher	5.3 - 4	Spule (Alu) für JUKI	1.4 - 13 bis 1.4 - 18
Schublade	1.14 - 4	Spule (Alu) für MITSUBISHI	1.4 - 19 bis 1.4 - 21
Schulternahtapparat, linkskappend	1.8 - 52	Spule (Alu) für SINGER	1.4 - 13
Schulternahtapparat, rechtskappend	1.8 - 52	Spule (Haushaltsnähmaschinen, Stahl)	1.15 - 10
Sechskant-Steckschlüssel	5.3 - 6	Spule (Stahl) für BROTHER	1.4 - 3 1.4 - 6 1.4 - 7
Sechskant-Stiftschlüssel	5.3 - 5	Spule (Stahl) für CONSEW	1.4 - 7 bis 1.4 - 9
Sicherheitsnadel, Eisen	3.5 - 8	Spule (Stahl) für DUERKOPP - ADLER	1.4 - 9 bis 1.4 - 13
Sicherheitsnadel, Messing	3.5 - 7	Spule (Stahl) für JUKI	1.4 - 13 1.4 - 17 1.4 - 18
Sicherheitsnadel, Stahl	3.5 - 7	Spule (Stahl) für MITSUBISHI	1.4 - 19 1.4 - 20 1.4 - 21
Silikonöl	5.1 - 3	Spule (Stahl) für SINGER	1.4 - 22 bis 1.4 - 32
Spaghettiapparat	1.8 - 73	Spule für PFAFF	7.0 8.0
Spezialapparate	1.8 - 80 1.8 - 81	Spulenkapsel für PFAFF	7.0 8.0
Spezialkapper	1.8 - 52 1.8 - 53	Spulenkapsel mit Bremsfeder für BROTHER	1.4 - 3 bis 1.4 - 7
Spezialkapper für Hemden	1.8 - 51 1.8 - 53	Spulenkapsel mit Bremsfeder für CONSEW	1.4 - 8
Spezial-Schraubendreher	5.3 - 5	Spulenkapsel mit Bremsfeder für DUERKOPP - ADLER	1.4 - 10 1.4 - 11 1.4 - 12 1.4 - 13
Spray	5.1 - 4		
Spreizer (Haushaltsnähmaschinen)	1.15 - 6		
Spreizer BROTHER	1.5 - 17		
Spreizer DUERKOPP-ADLER	1.5 - 44		
Spreizer JUKI	1.5 - 66		
Spreizer MAUSER-SPEZIAL	1.7 - 6 1.7 - 7		
Spreizer PEGASUS	1.5 - 100		

Spulenkapsel mit Bremsfeder für JUKI	1.4 - 13 bis 1.4 - 18	Standardfuß JUKI	1.5 - 55 1.5 - 56 1.5 - 57 1.5 - 68
Spulenkapsel mit Bremsfeder für MITSUBISHI	1.4 - 19 1.4 - 20	Standardfuß PFAFF	1.5 - 105 1.5 - 106 1.5 - 110 1.5 - 112
Spulenkapsel mit Bremsfeder für SINGER	1.4 - 24 1.4 - 25 bis 1.4 - 32	Standardfuß SINGER	1.5 - 157 1.5 - 158 1.5 - 162 1.5 - 164 1.5 - 166
Spulenkapsel ohne Bremsfeder für ALTIN (Textima)	1.4 - 3	Stecker	1.13 - 15
Spulenkapsel ohne Bremsfeder für BROTHER	1.4 - 3 bis 1.4 - 7	Stecknadel mit Glaskopf	3.5 - 5
Spulenkapsel ohne Bremsfeder für CONSEW	1.4 - 7 1.4 - 8 1.4 - 9	Stecknadel mit Kunststoffkopf	3.5 - 5
Spulenkapsel ohne Bremsfeder für DUERKOPP - ADLER	1.4 - 9 bis 1.4 - 13	Stecknadel, Messing	3.5 - 4
Spulenkapsel ohne Bremsfeder für JUKI	1.4 - 13 bis 1.4 - 18	Stecknadel, Stahl	3.5 - 4
Spulenkapsel ohne Bremsfeder für MITSUBISHI	1.4 - 19 1.4 - 20 1.4 - 21	Stichplatte ALTIN (Textima)	1.5 - 2
Spulenkapsel ohne Bremsfeder für SINGER	1.4 - 22 bis 1.4 - 32	Stichplatte BROTHER	1.5 - 8
Spulenkapsel-Ersatzteile	1.4 - 32	Stichplatte CONSEW	1.5 - 18
Spulenkapsellüfter PFAFF	1.5 - 115 1.5 - 118	Stichplatte DUERKOPP-ADLER	1.5 - 21 1.5 - 23 1.5 - 27 1.5 - 30 1.5 - 35 1.5 - 38
Spuler	1.14 - 12	Stichplatte für Nadeltransport	1.2 - 10
Stahlmaßstab	3.2 - 4	Stichplatte für spezielle Nähzwecke	1.1 - 39
Standardfuß BROTHER	1.5 - 8 1.5 - 16 1.5 - 18	Stichplatte für Standard-Zweinadel-Maschinen ohne Fadenabschneider	1.3 - 3
Standardfuß CONSEW	1.5 - 18	Stichplatte JUKI	1.5 - 55 1.5 - 56 1.5 - 60 1.5 - 68
Standardfuß DUERKOPP-ADLER	1.5 - 21 1.5 - 23 1.5 - 27 1.5 - 33 1.5 - 36 1.5 - 37 1.5 - 38	Stichplatte MAUSER-SPEZIAL	1.5 - 81 1.5 - 82 1.7
		Stichplatte PEGASUS	1.5 - 96 1.5 - 98 1.6

Stichplatte PFAFF	1.5 - 106	TEFLEE-Gelenkpresserfuß	
	1.5 - 107	für Nadeltransport	1.2 - 8
	1.5 - 108	Teflon-Ausgleichsgelenkfuß	1.1 - 32
	1.5 - 110	Teflonfuß DUERKOPP-ADLER	1.5 - 33
	1.5 - 112		1.5 - 37
	1.5 - 114		1.5 - 38
	1.5 - 117	Teflonfuß für Nadeltransport	1.2 - 7
	1.5 - 120	Teflonfuß PFAFF	1.5 - 105
	1.5 - 121	Teflonfuß SINGER	1.5 - 157
	1.5 - 122		1.5 - 158
	7.0	Teflonsohle DUERKOPP-ADLER	1.5 - 33
Stichplatte REECE	1.5 - 128	Teflonsohle für Nadeltransport	1.2 - 7
	1.5 - 130	Teflonsohle für Untertransport	1.1 - 33
	1.5 - 133	Teflonsohle PFAFF	1.5 - 105
Stichplatte RIMOLDI-NECCI	1.5 - 139	Temperaturfühler für PFAFF	7.1
Stichplatte SEIKO	1.5 - 149	Temperaturregler für PFAFF	7.1 - 3
Stichplatte SINGER	1.5 - 150		7.1 - 4
	1.5 - 155	Tischplatte	1.14 - 2
	1.5 - 157	Transporteur ALTIN (Textima)	1.5 - 2
	1.5 - 158	Transporteur BROTHER	1.5 - 8
	1.5 - 162	Transporteur CONSEW	1.5 - 18
	1.5 - 164	Transporteur DUERKOPP-ADLER	1.5 - 21
	1.5 - 166		1.5 - 23
	1.5 - 168		1.5 - 27
	1.5 - 170		1.5 - 30
Stichplatte UNION SPECIAL	1.5 - 181		1.5 - 35
	1.5 - 182	Transporteur für Nadeltransport	1.2 - 10
	1.5 - 190	Transporteur für spezielle Nähzwecke	1.1 - 39
	1.5 - 194		1.1 - 40
Stichplatte WILLCOX & GIBBS	1.5 - 202	Transporteur für Standard-Zweinadel-	
Stichplatte, 3-reihig	1.1 - 37	Maschinen ohne Fadenabschneider	1.3 - 3
	1.1 - 38	Transporteur JUKI	1.5 - 55
Stichplatteneinsatz JUKI	1.5 - 57		1.5 - 56
Stickschere	2.7 - 5		1.5 - 68
	2.7 - 6	Transporteur MAUSER-SPEZIAL	1.5 - 81
Stoffklammer	2.6 - 2		1.5 - 82
	2.6 - 3		1.7
Stoßmesser	2.3 - 2	Transporteur PEGASUS	1.5 - 96
	bis 2.3 - 4		1.5 - 98
Sublimatkreide	3.3 - 3		1.6
Sublimatstift	3.3 - 4		
Taschenschere	2.7 - 6		
TEFLEE-Ausgleichsgelenkfuß	1.1 - 35		
TEFLEE-Ausgleichsgelenkfuß			
für Nadeltransport	1.2 - 9		
TEFLEE-Gelenkpresserfuß	1.1 - 34		

Transporteur PFAFF	1.5 - 106 1.5 - 110 1.5 - 112 1.5 - 114 1.5 - 117 1.5 - 120 1.5 - 121 1.5 - 122 7.0	Ziehmesser	2.7 - 17
Transporteur SINGER	1.5 - 150 1.5 - 157 1.5 - 158 1.5 - 162 1.5 - 164 1.5 - 166 1.5 - 168 1.5 - 170	Zubehör (für Nähtische)	1.14 - 6
Transporteur UNION SPECIAL	1.5 - 177 1.5 - 184	Zugstange	1.14 - 5
Transporteur WILLCOX & GIBBS	1.5 - 200 1.5 - 201	Zunge MAUSER-SPEZIAL	1.5 - 76
Transporteur, 3-reihig	1.1 - 37 1.1 - 38	Zunge PEGASUS	1.5 - 100
Transportrolle für PFAFF	7.1	Zunge UNION SPECIAL	1.5 - 180
Tuchelle	3.2 - 5	Zunge WILLCOX & GIBBS	1.5 - 203
Umlaufgreifer für PFAFF	7.0 8.0	Zunge YAMATO	1.5 - 209
UV-Licht-Leuchtstoffröhren, schwarz	1.12 - 8	Zuschneidemaschinenersatzteile	2.5 - 2
UV-Markiermittel	3.3 - 8	Zuschnitthilfsmittel	2.6 - 4
Verschleißteile für Nähfüße	1.1 - 36 1.1 - 39	Zuschnittmarkiernadeln	3.5 - 2
Wachskreide	3.3 - 2	Zweifachsäumer mit Umbug oben	1.8 - 58
Warenanhänger	4.4 - 3	Zweinadel-Ausgleichsfuß	1.3 - 8
Weberschere	2.7 - 14	Zweinadelfuß mit Kantenanschlag, für feine Materialien	1.3 - 5 1.3 - 6
Winkel	3.2 - 5	Zweinadelfuß mit Kantenanschlag, für Jeansstoffe	1.3 - 6
Zackenschere	2.7 - 12 2.7 - 13	Zweinadel-Gelenkpresserfuß	1.3 - 3
Zahnkeilriemen	1.13 - 11	Zweinadel-Gelenkpresserfuß mit Teflonsohle	1.3 - 7
Zick-Zack-Ausgleichsgelenkfuß	1.1 - 7		
Zick-Zack-Fuß	1.1 - 4		

- Abrasive Bands for Cutter* 2.1 - 4
- Abrasive Bands for Straight Knife Cutting Machines* 2.3 - 5
- Accessories for Sewing Lights* 1.12 - 7
- Accessories for Table Tops* 1.14 - 6
- Adjusting Gauges* 5.3 - 9
- Angle* 3.2 - 5
- Artisan Motor* 1.13 - 3
- Artisan Motor Spare Parts* 1.13 - 3
- Assembly Parts* 1.14 - 7
- Attachment bracket* 1.8 - 82
1.8 - 83
- Attachment Feet DUERKOPP - ADLER* 1.5 - 21
1.5 - 23
1.5 - 27
- Attachment Feet PFAFF* 1.5 - 112
1.5 - 114
1.5 - 121
- Attachment foot, solid* 1.1 - 24
- Ball Hemmer Foot* 1.1 - 25
- Band Knives with double bevel* 2.4 - 2
- Base Cushion* 1.14 - 3
- Bayonet Base Bulbs, 12 V* 1.12 - 8
- Bellow* 5.3 - 2
- Belt Folder* 1.8 - 21
- Belt Hook* 1.13 - 12
- Belt Loop Attachment* 1.8 - 74
1.8 - 76
1.8 - 77
- Belt Turner* 4.1 - 2
- Bias Loop Piping Foot* 1.1 - 19
- Bias Tape Binder with double fold* 1.8 - 5
up to 1.8 - 12
- Bias Tape Binder with elastic tape insertion* 1.8 - 13
- Binder with double fold* 1.8 - 14
up to 1.8 - 18
- Binder with upper fold* 1.8 - 21
up to 1.8 - 25
- Binder without fold* 1.8 - 26
up to 1.8 - 36
- Blindstitch Looper BROTHER* 1.5 - 6
- Blindstitch Looper LEWIS* 1.5 - 73
- Blindstitch Looper MAUSER-SPEZIAL* 1.5 - 82
- Blindstitch Looper STROBEL* 1.5 - 175
- Blindstitch Looper TREASURE* 1.5 - 176
- Blindstitch Looper UNION-SPECIAL* 1.5 - 176
- Bobbin (Alu) for BROTHER* 1.4 - 3
up to 1.4 - 7
- Bobbin (Alu) for CONSEW* 1.4 - 8
- Bobbin (Alu) for DUERKOPP - ADLER* 1.4 - 9
up to 1.4 - 13
- Bobbin (Alu) for JUKI* 1.4 - 13
up to 1.4 - 18
- Bobbin (Alu) for MITSUBISHI* 1.4 - 19
up to 1.4 - 21
- Bobbin (Alu) for SINGER* 1.4 - 13
- Bobbin (steel, for domestic sewing machines)* 1.15 - 10
- Bobbin (steel) for BROTHER* 1.4 - 3
1.4 - 6
1.4 - 7
- Bobbin (steel) for CONSEW* 1.4 - 7
up to 1.4 - 9
- Bobbin (steel) for DUERKOPP - ADLER* 1.4 - 9
up to 1.4 - 13
- Bobbin (steel) for JUKI* 1.4 - 13
1.4 - 17
1.4 - 18
- Bobbin (steel) for MITSUBISHI* 1.4 - 19
1.4 - 20
1.4 - 21
- Bobbin (steel) for SINGER* 1.4 - 22
up to 1.4 - 32
- Bobbin Case for PFAFF* 7.0
8.0
- Bobbin Case Opener PFAFF* 1.5 - 115
1.5 - 118
- Bobbin Case Replacement Parts* 1.4 - 32
- Bobbin Case w/out NBL-Spring for ALTIN (Textima)* 1.4 - 3

<i>Bobbin Case w/out NBL-Spring for BROTHER</i>	1.4 - 3 up to 1.4 - 7	<i>Button Clamp JUKI</i>	1.5 - 59
<i>Bobbin Case w/out NBL-Spring for CONSEW</i>	1.4 - 7 1.4 - 8 1.4 - 9	<i>Button Clamp LEWIS</i>	1.5 - 74
<i>Bobbin Case w/out NBL-Spring for DUERKOPP - ADLER</i>	1.4 - 9 up to 1.4 - 13	<i>Button Clamp MAUSER-SPEZIAL</i>	1.5 - 77
<i>Bobbin Case w/out NBL-Spring for JUKI</i>	1.4 - 13 up to 1.4 - 18	<i>Button Clamp SINGER</i>	1.5 - 160
<i>Bobbin Case w/out NBL-Spring for MITSUBISHI</i>	1.4 - 19 1.4 - 20 1.4 - 21	<i>Button Clamp Spare Parts CONSEW</i>	1.5 - 19
<i>Bobbin Case w/out NBL-Spring for SINGER</i>	1.4 - 22 up to 1.4 - 32	<i>Button Clamp Spare Parts LEWIS</i>	1.5 - 74
<i>Bobbin Case with NBL-Spring for BROTHER</i>	1.4 - 3 up to 1.4 - 7	<i>Button Clamp Spare Parts MAUSER-SPEZIAL</i>	1.5 - 77
<i>Bobbin Case with NBL-Spring for CONSEW</i>	1.4 - 8	<i>Button Clamp Spare Parts SINGER</i>	1.5 - 160
<i>Bobbin Case with NBL-Spring for DUERKOPP - ADLER</i>	1.4 - 10 1.4 - 11 1.4 - 12 1.4 - 13	<i>Button Stay Folder</i>	1.8 - 79
<i>Bobbin Case with NBL-Spring for JUKI</i>	1.4 - 13 up to 1.4 - 18	<i>Buttonhole Knife BROTHER</i>	1.5 - 14
<i>Bobbin Case with NBL-Spring for MITSUBISHI</i>	1.4 - 19 1.4 - 20	<i>Buttonhole Knife DUERKOPP-ADLER</i>	1.5 - 39 1.5 - 40
<i>Bobbin Case with NBL-Spring for SINGER</i>	1.4 - 24 1.4 - 25 up to 1.4 - 32	<i>Buttonhole Knife JUKI</i>	1.5 - 53 1.5 - 60
<i>Bobbin for PFAFF</i>	7.0 8.0	<i>Buttonhole Knife PFAFF</i>	1.5 - 123
<i>Bobbin Winder</i>	1.14 - 12	<i>Buttonhole Knife REECE</i>	1.5 - 133
<i>Bracket</i>	1.14 - 7	<i>Buttonhole Knife RIMOLDI-NECCI</i>	1.5 - 136
<i>Break Spring for PFAFF</i>	7.0	<i>Buttonhole Knife SINGER</i>	1.5 - 153
<i>Brush</i>	5.3 - 2	<i>Buttonhole Knife 90° BROTHER</i>	1.5 - 14
<i>Bushing RIMOLDI-NECCI</i>	1.5 - 143	<i>Buttonhole Knife 90° DUERKOPP-ADLER</i>	1.5 - 40
<i>Button Clamp BROTHER</i>	1.5 - 5	<i>Buttonhole Knife 90° JUKI</i>	1.5 - 53 1.5 - 54
<i>Button Clamp CONSEW</i>	1.5 - 19	<i>Buttonhole Knife 90° PFAFF</i>	1.5 - 123
		<i>Buttonhole Knife 90° RIMOLDI-NECCI</i>	1.5 - 136 1.5 - 137
		<i>Buttonhole Knife 90° SINGER</i>	1.5 - 154
		<i>Buttonhole Scissors</i>	2.7 - 13
		<i>Catcher BROTHER</i>	1.5 - 17
		<i>Catcher JUKI</i>	1.5 - 58
		<i>Catcher PFAFF</i>	7.0
		<i>Catcher REECE</i>	1.5 - 134
		<i>Ceramic Knife BROTHER</i>	1.5 - 9
		<i>Ceramic Knife EAGLE</i>	1.5 - 47
		<i>Ceramic Knife JUKI</i>	1.5 - 66
		<i>Ceramic Knife MAUSER-SPEZIAL</i>	1.5 - 79

- Ceramic Knife PEGASUS* 1.5 - 92
- Ceramic Knife PFAFF* 1.5 - 128
- Ceramic Knife REECE* 1.5 - 128
- Ceramic Knife SINGER* 1.5 - 173
- Ceramic Knife SIRUBA* 1.5 - 173
- Ceramic Knife UNION SPECIAL* 1.5 - 176
1.5 - 186
- Ceramic Knife WILLCOX & GIBBS* 1.5 - 198
- Ceramic Knife YAMATO* 1.5 - 204
1.5 - 212
- Chain Cutter with sideward suction
behind the presser foot* 1.9 - 2
- Chain Cutter with suction behind the needle* 1.9 - 2
- Chain Tensioner for PFAFF* 7.1
- Chalk Marker* 3.3 - 7
- Chalk Powder* 3.3 - 7
- Chalk Sharpener* 3.3 - 6
- Circular Knives* 2.2 - 2
up to 2.2 - 7
- Clamp PFAFF* 1.5 - 111
- Cloth Clamp* 2.6 - 2
2.6 - 3
- Clutch Motor* 1.13 - 2
- Clutch Motor Spare Parts* 1.13 - 2
- Collar Turner* 4.1 - 2
- Compensating Foot* 1.1 - 23
- Compensating Foot DUERKOPP - ADLER* 1.5 - 33
- Compensating Foot PFAFF* 1.5 - 105
- Compensating Foot SINGER* 1.5 - 168
- Compensating Foot, right, low shaft* 1.1 - 9
- Compensating Foot, with teflon sole* 1.1 - 32
- Compensating presser foot* 1.1 - 6
1.1 - 9
- Compensating presser foot for needle feed* 1.2 - 5
- Condenser* 1.13 - 12
- Cording Foot, solid, left* 1.1 - 13
- Cording Foot, solid, right* 1.1 - 13
- Cording Foot BROTHER* 1.5 - 14
1.5 - 16
1.5 - 18
- Cording Foot CONSEW* 1.5 - 18
- Cording Foot DUERKOPP-ADLER* 1.5 - 21
1.5 - 27
1.5 - 33
1.5 - 36
1.5 - 37
- Cording Foot PFAFF* 1.5 - 105
1.5 - 110
- Cording Foot SEIKO* 1.5 - 149
- Cording Foot SINGER* 1.5 - 158
- Counter Blade for Circular Knife
Cutting Machines* 2.2 - 8
- Crocus Round Cloth* 5.3 - 8
- Crocus Round Cords* 5.3 - 7
- Cutter Knives* 2.7 - 17
- Cutter Knives* 2.1 - 2
2.1 - 3
- Cutting Aids* 2.6 - 4
- Cutting Block DUERKOPP - ADLER* 1.5 - 42
1.5 - 44
- Cutting Block REECE* 1.5 - 130
1.5 - 132
- Cutting Machine Spare Parts* 2.5 - 2
- Diamond Files* 5.3 - 6
- Domestic Sewing Machine Equipment* 1.15 - 2
1.15 - 3
1.15 - 8
1.15 - 9
1.15 - 10
1.15 - 11
- Domestic Sewing Machine Motors (Built-in)* 1.13 - 5
- Domestic Sewing Machine Motors (Built-on)* 1.13 - 4
- Double Needle Compensating Foot* 1.3 - 8
- Double Needle Foot with guide,
for fine materials* 1.3 - 5
1.3 - 6
- Double Needle Foot with guide,
for jeans materials* 1.3 - 6
- Double Needle Hinged Presser Foot* 1.3 - 3
- Double Needle Presser Foot with Teflon Sole* 1.3 - 7

<i>Downturn Feller Foot</i>	1.1 - 28	<i>Feed Dog JUKI</i>	1.5 - 55 1.5 - 56 1.5 - 68
<i>Drawer</i>	1.14 - 4	<i>Feed Dog MAUSER-SPEZIAL</i>	1.5 - 81 1.5 - 82 1.7
<i>Dressmaker Scissors</i>	2.7 - 2 up to 2.7 - 4	<i>Feed Dog PEGASUS</i>	1.5 - 96 1.5 - 98 1.6
<i>Dressmaker Scissors</i>	2.7 - 7 up to 2.7 - 10	<i>Feed Dog PFAFF</i>	1.5 - 106 1.5 - 110 1.5 - 112 1.5 - 114 1.5 - 117 1.5 - 120 1.5 - 121 1.5 - 122 7.0
<i>Drill Needle</i>	3.1 - 2	<i>Feed Dog SINGER</i>	1.5 - 150 1.5 - 157 1.5 - 158 1.5 - 162 1.5 - 164 1.5 - 166 1.5 - 168 1.5 - 170
<i>Driving belt REECE</i>	1.5 - 134	<i>Feed Dog UNION SPECIAL</i>	1.5 - 177 1.5 - 184
<i>Driving belt SINGER</i>	1.5 - 157	<i>Feed Dog WILLCOX & GIBBS</i>	1.5 - 200 1.5 - 201
<i>Dummies</i>	3.4 - 4 3.4 - 5	<i>Feed Dog with 3 rows</i>	1.1 - 37 1.1 - 38
<i>Edge Guides</i>	1.10 - 4	<i>Feed Roller for PFAFF</i>	7.1
<i>Elastic Round Belts</i>	1.13 - 11	<i>Feet with concealed Zipper</i>	1.1 - 14
<i>Elastic Shirring Foot with adjustable tension</i>	1.1 - 19	<i>Feller with Cord Guide</i>	1.8 - 64
<i>Elastic Shoulder Straps Folder</i>	1.8 - 76	<i>Feller With Elastic Tape Guide</i>	1.8 - 66 1.8 - 67
<i>Elastic Tape Binder</i>	1.8 - 47	<i>Feller with lower fold</i>	1.8 - 55 1.8 - 56
<i>Elastic Tape Guide</i>	1.8 - 79	<i>Feller with upper fold</i>	1.8 - 54
<i>Embroidery Scissors</i>	2.7 - 5 2.7 - 6	<i>Fibre Optic Sewing Lights</i>	1.12 - 4
<i>Emery Flat Tape</i>	5.3 - 7	<i>Fibre Optic Sewing Lights (Accessories)</i>	1.12 - 4
<i>Emery Round Cloth</i>	5.3 - 8	<i>Filter for MAUSER-SPEZIAL</i>	1.7
<i>Emery Round Cords</i>	5.3 - 7	<i>Filter for PEGASUS</i>	1.6
<i>Endless V-Belts</i>	1.13 - 8 1.13 - 9 1.13 - 10	<i>Finger Guard</i>	1.16 - 3
<i>Feed Dog ALTIN (Textima)</i>	1.5 - 2	<i>Flip - up Needle Clamp</i>	1.3 - 4
<i>Feed Dog BROTHER</i>	1.5 - 8	<i>Flourescent Tubes, white</i>	1.12 - 8
<i>Feed Dog CONSEW</i>	1.5 - 18		
<i>Feed Dog DUERKOPP-ADLER</i>	1.5 - 21 1.5 - 23 1.5 - 27 1.5 - 30 1.5 - 35 1.5 - 38		
<i>Feed Dog for Needle Feed</i>	1.2 - 10		
<i>Feed Dog for special purpose</i>	1.1 - 39 1.1 - 40		
<i>Feed Dog for Standard Double Needle Machines without thread cutter</i>	1.3 - 3		

Fluorescent Lights	1.12 - 7	Hinged Raising Foot, right	1.1 - 10
Folder For Waistband Works with two continuous tapes	1.8 - 20	Hinged Tube Foot	1.1 - 21
Foot Controller	1.13 - 6	Hook Knife for MAUSER-SPEZIAL	1.7 - 2 1.7 - 3 1.7 - 4 1.7 - 5
Foot Pedal	1.14 - 5	Hook Knife for PEGASUS	1.6
Friction Ring for PFAFF	7.0	Hook Shuttle for CONSEW	1.4 - 9
Garment Racks	4.5 - 2	Hook Shuttle for DUERKOPP - ADLER	1.4 - 9
Grinding Machine (Accessories)	5.3 - 9	Hook Shuttle for SINGER	1.4 - 22 1.4 - 24
Halogen Bulb	1.12 - 6	Industry scissors	2.7 - 15
Halogen Sewing Lights	1.12 - 5	Ink Rolls for Labeling Device	4.4 - 5
Heating Element for PFAFF	7.1	Insert PFAFF	1.5 - 125
Heatseal Iron	3.4 - 2	Insert SINGER	1.5 - 155
Hemmer Foot, solid	1.1 - 26	Iron Cushions	4.3 - 2
Hemmer with Cord Guide	1.8 - 65	Knife	1.15 - 4
Hemmer with Elastic Tape Guide	1.8 - 65 1.8 - 67	Knife ALTIN (Textima)	1.5 - 2
Hemmer with lower fold	1.8 - 63 1.8 - 64	Knife BERNINA	1.5 - 4
Hemmer with two hem sizes, upper fold	1.8 - 58	Knife BROTHER	1.5 - 5 up to 1.5 - 17
Hemmer with upper fold	1.8 - 57 up to 1.8 - 62	Knife CLINTON	1.5 - 18
Hexagonal Allen Keys	5.3 - 5	Knife DUERKOPP-ADLER	1.5 - 23 up to 1.5 - 46
Hexagonal Wrenches	5.3 - 6	Knife EAGLE	1.5 - 47
High mortality parts for sewing feet	1.1 - 36 1.1 - 39	Knife Grinding Machines	5.3 - 8
Hinged Cording Foot for needle feed	1.2 - 6	Knife Holder ALTIN (Textima)	1.5 - 2
Hinged Cording Foot, left	1.1 - 12	Knife JUKI	1.5 - 48 up to 1.5 - 68
Hinged Cording Foot, right	1.1 - 12	Knife KANSAI	1.5 - 70 1.5 - 71 1.5 - 72
Hinged Piping Foot, left	1.1 - 15	Knife MAUSER-SPEZIAL	1.5 - 76 1.5 - 78 1.5 - 79 1.5 - 83 1.5 - 84 1.7 - 2 1.7 - 3 1.7 - 4 1.7 - 5
Hinged Piping Foot, right	1.1 - 15		
Hinged Presser Foot	1.1 - 22		
Hinged Presser Foot for standard needle feed machines	1.2 - 3		
Hinged Presser Foot, even toes	1.1 - 4		
Hinged PresserFoot, right toe shorter	1.1 - 3		
Hinged Raising Foot, left	1.1 - 10		

<i>Knife MERROW</i>	1.5 - 85	<i>Labeling Device for self-adhesive Labels</i>	4.4 - 4
<i>Knife MITSUBISHI</i>	1.5 - 86	<i>Labels, Hanging</i>	4.4 - 3
	1.5 - 87	<i>Lap-Seam Feller</i>	
	1.5 - 88	<i>for feed-off the arm machines</i>	1.8 - 49
	1.5 - 89	<i>Lap-Seam Feller</i>	
<i>Knife PEGASUS</i>	1.5 - 90	<i>for flatbed machines</i>	1.8 - 50
	1.5 - 92	<i>Laser</i>	1.12 - 2
	1.5 - 100		1.12 - 3
	1.5 - 101	<i>Leather Round Belt</i>	1.13 - 12
	1.5 - 102	<i>Left side compensating foot</i>	1.1 - 5
	1.5 - 103		1.1 - 7
	1.6	<i>Left side compensating foot for needle feed</i>	1.2 - 5
<i>Knife PFAFF</i>	1.5 - 104	<i>Left side compensating foot, narrow,</i>	
	1.5 - 107	<i>for bottom feed, metrical</i>	1.1 - 6
	1.5 - 108		1.1 - 8
	1.5 - 113	<i>Lefthand Scissors</i>	2.7 - 11
	up to 1.5 - 127	<i>Loop Folding Foot</i>	1.3 - 7
	7.0	<i>Loop Retainer UNION SPECIAL</i>	1.5 - 177
<i>Knife REECE</i>	1.5 - 128	<i>Loop Retainer UNION SPECIAL</i>	1.5 - 194
	1.5 - 129	<i>Loop Turner</i>	4.1 - 3
	1.5 - 130	<i>Looper</i>	1.15 - 6
	1.5 - 134	<i>Looper ALTIN (Textima)</i>	1.5 - 2
	1.5 - 135	<i>Looper BROTHER</i>	1.5 - 5
<i>Knife RIMOLDI-NECCI</i>	1.5 - 137		1.5 - 7
	1.5 - 138		up to 1.5 - 13
	1.5 - 139		1.5 - 17
	1.5 - 141	<i>Looper CONSEW</i>	1.5 - 20
	1.5 - 145	<i>Looper DUERKOPP-ADLER</i>	1.5 - 26
	1.5 - 147		1.5 - 44
	1.5 - 148		1.5 - 45
<i>Knife SINGER</i>	1.5 - 150	<i>Looper for MAUSER-SPEZIAL</i>	1.7
	1.5 - 151	<i>Looper for Pegasus</i>	1.6
	1.5 - 152	<i>Looper Holder SINGER</i>	1.5 - 168
	1.5 - 155	<i>Looper JUKI</i>	1.5 - 52
	1.5 - 156		1.5 - 59
	1.5 - 164		1.5 - 60
	1.5 - 166		1.5 - 61
	1.5 - 169		1.5 - 62
	1.5 - 170		1.5 - 63
	1.5 - 171		1.5 - 66
<i>Knife SIRUBA</i>	1.5 - 173	<i>Looper KANSAI</i>	1.5 - 69
<i>Knife UNION SPECIAL</i>	1.5 - 176		1.5 - 70
	up to 1.5 - 196		1.5 - 71
<i>Knife WILLCOX & GIBBS</i>	1.5 - 197		1.5 - 72
	1.5 - 198		
	1.5 - 202		
	1.5 - 203		
<i>Knife YAMATO</i>	1.5 - 205		
	1.5 - 207		
	1.5 - 208		
	1.5 - 209		
	1.5 - 210		
	1.5 - 212		

Looper LEWIS	1.5 - 73 1.5 - 74	Magnetic Guides	1.10 - 4
Looper MAUSER-SPEZIAL	1.5 - 76 1.5 - 79 1.5 - 83 1.5 - 84	Marking Pencil with exchangeable lead	3.3 - 4 3.3 - 5
Looper MERROW	1.5 - 85	Marking Pins	3.5 - 2
Looper PEGASUS	1.5 - 92 1.5 - 94 1.5 - 96 1.5 - 100 1.5 - 101 1.5 - 102 1.5 - 103	Measure Tapes	3.2 - 2 3.2 - 3
Looper PFAFF	1.5 - 124 1.5 - 126 1.5 - 127	Measure Tapes, Steel	3.2 - 4
Looper REECE	1.5 - 128 1.5 - 131 1.5 - 134 1.5 - 135	Metal Hinge	1.14 - 4
Looper RIMOLDI-NECCI	1.5 - 141 1.5 - 143 1.5 - 145 1.5 - 148	Metal Safety Gloves	2.6 - 4
Looper SINGER	1.5 - 150 1.5 - 156 1.5 - 160 1.5 - 163 1.5 - 164 1.5 - 166 1.5 - 167 1.5 - 169 1.5 - 171	Metering Device	1.11 - 2
Looper SIRUBA	1.5 - 173	Mirror for try on	4.5 - 2
Looper STROBEL	1.5 - 175	Motor Brush	1.13 - 13 1.13 - 14
Looper UNION SPECIAL	1.5 - 177 up to 1.5 - 181 1.5 - 186 up to 1.5 - 196	Neckline Attachment for Polo Shirts	1.8 - 76
Looper WILLCOX & GIBBS	1.5 - 198 1.5 - 202	Needle bar	3.5 - 3
Looper YAMATO	1.5 - 204 1.5 - 205 1.5 - 207 1.5 - 209 1.5 - 210 1.5 - 212 1.5 - 214	Needle Bar for PFAFF	7.0
Loupe	3.2 - 6	Needle Bar for Standard Double Needle Machines	1.3 - 5
		Needle Bar PFAFF	1.5 - 110 1.5 - 111
		Needle Clamp BROTHER	1.5 - 8
		Needle Clamp for Standard Double Needle Machines	1.3 - 3 1.3 - 4
		Needle Clamp JUKI	1.5 - 55 1.5 - 56 1.5 - 68
		Needle Clamp SINGER	1.5 - 162 1.5 - 168
		Needle Guard for PEGASUS	1.6
		Needle Guide for MAUSER-SPEZIAL	1.7 - 7
		Needle Plate ALTIN (Textima)	1.5 - 2
		Needle Plate BROTHER	1.5 - 8
		Needle Plate CONSEW	1.5 - 18
		Needle Plate DUERKOPP-ADLER	1.5 - 21 1.5 - 23 1.5 - 27 1.5 - 30 1.5 - 35 1.5 - 38

<i>Needle Plate for hemmer and binder attachments</i>	1.1 - 40	<i>Oil bottles</i>	5.1 - 3
<i>Needle Plate for special purpose</i>	1.1 - 39	<i>Oil for sewing machines</i>	5.1 - 2
<i>Needle Plate Insert JUKI</i>	1.5 - 57	<i>Order Form</i>	9.0
<i>Needle Plate JUKI</i>	1.5 - 55	<i>Pattern Notcher Plier</i>	3.1 - 2
	1.5 - 56	<i>Pattern Stick Pins</i>	3.5 - 2
	1.5 - 60	<i>Pin Cushion</i>	3.5 - 6
	1.5 - 68	<i>Pinking equipment</i>	2.5 - 3
<i>Needle Plate MAUSER-SPEZIAL</i>	1.5 - 81	<i>Pinking Shears</i>	2.7 - 12
	1.5 - 82		2.7 - 13
	1.7	<i>Pins, brass</i>	3.5 - 4
<i>Needle Plate PEGASUS</i>	1.5 - 96	<i>Pins, steel</i>	3.5 - 4
	1.5 - 98	<i>Pins, steel, glass head</i>	3.5 - 5
	1.6	<i>Pins, steel, plastic head</i>	3.5 - 5
<i>Needle Plate PFAFF</i>	1.5 - 106	<i>Piping Attachment</i>	1.8 - 68
	1.5 - 107		up to 1.8 - 71
	1.5 - 108	<i>Piping Feet BROTHER</i>	1.5 - 14
	1.5 - 110		1.5 - 16
	1.5 - 112		1.5 - 18
	1.5 - 114	<i>Piping Feet CONSEW</i>	1.5 - 18
	1.5 - 117	<i>Piping Feet DUERKOPP-ADLER</i>	1.5 - 21
	1.5 - 120		1.5 - 27
	1.5 - 121		1.5 - 36
	1.5 - 122		1.5 - 37
	7.0	<i>Piping Feet PFAFF</i>	1.5 - 110
<i>Needle Plate REECE</i>	1.5 - 128	<i>Piping Feet SEIKO</i>	1.5 - 149
	1.5 - 130	<i>Piping Feet SINGER</i>	1.5 - 158
	1.5 - 133	<i>Piping Foot</i>	1.1 - 18
<i>Needle Plate RIMOLDI-NECCI</i>	1.5 - 139	<i>Piping Foot with double groove</i>	1.1 - 18
<i>Needle Plate SEIKO</i>	1.5 - 149	<i>Piping Guide</i>	1.8 - 72
<i>Needle Plate SINGER</i>	1.5 - 150	<i>Plug</i>	1.13 - 15
	1.5 - 155	<i>Pocket Scissors</i>	2.7 - 6
	1.5 - 157	<i>Positioning Finger JUKI</i>	1.5 - 59
	1.5 - 158	<i>Presser Bar PFAFF</i>	1.5 - 110
	1.5 - 162	<i>Presser Feet with Guide</i>	1.1 - 11
	1.5 - 164	<i>Presser Feet with Guide for MAUSER-SPEZIAL</i> ..	1.7 - 2
	1.5 - 166	<i>Presser Foot for MAUSER-SPEZIAL</i>	1.7
	1.5 - 168	<i>Presser Foot for PEGASUS</i>	1.6
	1.5 - 170		
<i>Needle Plate UNION SPECIAL</i>	1.5 - 181		
	1.5 - 182		
	1.5 - 190		
	1.5 - 194		
<i>Needle Plate WILLCOX & GIBBS</i>	1.5 - 202		
<i>Needle Plate with cut for right angle bias binder</i>	1.1 - 41		
<i>Needle Plate, 3 rows</i>	1.1 - 37		
	1.1 - 38		
<i>Needle Triangle</i>	3.5 - 3		

<i>Presser Foot for PFAFF</i>	7.0	<i>Safety Pins, brass</i>	3.5 - 7
<i>Professional Scissors</i>	2.7 - 14	<i>Safety Pins, iron</i>	3.5 - 8
<i>PTFE-coated Foil, white</i>	5.2 - 2	<i>Safety Pins, steel</i>	3.5 - 7
<i>PTFE-coated Glass Fibre Foil</i>	5.2 - 2	<i>Scissors</i>	2.7
<i>Puller</i>	1.11 - 3 1.11 - 4	<i>Scissors Grinding Machines</i>	5.3 - 8
<i>Pulleys</i>	1.13 - 7	<i>Screw Base Bulbs</i>	1.12 - 9
<i>Punch Tool</i>	3.1 - 3	<i>Screw BROTHER</i>	1.5 - 9 1.5 - 11
 		<i>Screw MAUSER-SPEZIAL</i>	1.5 - 81
<i>Quilter Guides</i>	1.10 - 2 1.10 - 3	<i>Screw PEGASUS</i>	1.5 - 96
 		<i>Screw RIMOLDI-NECCI</i>	1.5 - 143
<i>Relais for PFAFF</i>	7.1 - 3 7.1 - 4	<i>Screw WILLCOX & GIBBS</i>	1.5 - 201
 		<i>Screw YAMATO</i>	1.5 - 207
<i>Replacement sole for teflon feet</i>	1.1 - 33	<i>Screwdriver</i>	5.3 - 4
<i>Retaining Screws for MAUSER-SPEZIAL</i>	1.7	<i>Screws for Guides and Attachments</i>	1.10 - 5
<i>Retaining Screws for PEGASUS</i>	1.6	<i>Sealing Wedge for PFAFF</i>	7.1 - 5
<i>Retaining Screws for PFAFF</i>	7.0	<i>Seam Rippers with Ball</i>	2.7 - 17
<i>Revolving Punch Plier</i>	3.1 - 3	<i>Seam Tester</i>	7.1 - 5
<i>Right side compensating foot</i>	1.1 - 5 1.1 - 7 1.1 - 8	<i>Seam Testing Station</i>	7.1 - 5
 		<i>Seld-adhesive Labels</i>	4.4 - 5
<i>Right side compensating foot for needle feed</i>	1.2 - 4	<i>Sewing Chair</i>	1.14 - 2
 		<i>Sewing Machine Covers</i>	1.14 - 12
<i>Right side compensating foot for needle feed for two seam-widths</i>	1.1 - 9	<i>Sewing Machine Needles</i>	6.0 6.1
 		<i>Sharpening Stone for Circular Knife Cutting Machines</i>	2.2 - 8
<i>Right side compensating foot, narrow, for bottom feed, metrical</i>	1.1 - 6 1.1 - 8	<i>Sharpening Stone for Cutter</i>	2.1 - 5
 		<i>Sharpening Stones for Band Knife Cutting Machines</i>	2.4 - 3
<i>Roller Cutter</i>	2.7 - 15	<i>Sharpening Stones for Straight Knife Cutting Machines</i>	2.3 - 6
<i>Roller Cutter (Accessories)</i>	2.7 - 16	<i>Shirring Foot</i>	1.1 - 28
<i>Roller Foot</i>	1.1 - 29	<i>Shoulder Joint Folder, left</i>	1.8 - 52
<i>Roller Foot PFAFF</i>	1.5 - 106	<i>Shoulder Joint Folder, right</i>	1.8 - 52
 		<i>Shuttle Hook for BROTHER</i>	1.4 - 5 1.4 - 6
<i>Rotating Hook for PFAFF</i>	7.0 8.0	 	
 		<i>Shuttle Hook for DUERKOPP - ADLER</i>	1.4 - 9 1.4 - 13
<i>Rubber Hinge</i>	1.14 - 4		
<i>Ruler</i>	3.2 - 4 3.2 - 5		

Shuttle Hook for JUKI	1.4 - 13 1.4 - 17	Split-Tube Folder With Offset Upper Fold	1.8 - 39 1.8 - 41
Shuttle Hook for MITSUBISHI	1.4 - 21	Split-Tube Folder With Upper Fold	1.8 - 42
Shuttle Hook for SINGER	1.4 - 22 1.4 - 24 1.4 - 28 1.4 - 29	Split-Tube Folder Without Fold	1.8 - 44 1.8 - 46
Shuttles and Rotating Hooks (without bobbin case) for ALTIN (Textima)	1.4 - 3	Spray	5.1 - 4
Shuttles and Rotating Hooks (without bobbin case) for BROTHER	1.4 - 3 up to 1.4 - 7	Spreader (for domestic sewing machines)	1.15 - 6
Shuttles and Rotating Hooks (without bobbin case) for CONSEW	1.4 - 7 up to 1.4 - 9	Spreader BROTHER	1.5 - 17
Shuttles and Rotating Hooks (without bobbin case) for DUERKOPP - ADLER ...	1.4 - 9 up to 1.4 - 13	Spreader DUERKOPP-ADLER	1.5 - 44
Shuttles and Rotating Hooks (without bobbin case) for JUKI	1.4 - 13 up to 1.4 - 18	Spreader MAUSER-SPEZIAL	1.7 - 6 1.7 - 7
Shuttles and Rotating Hooks (without bobbin case) for MITSUBISHI	1.4 - 19 up to 1.4 - 21	Spreader JUKI	1.5 - 66
Shuttles and Rotating Hooks (without bobbin case) for SINGER	1.4 - 22 up to 1.4 - 32	Spreader PEGASUS	1.5 - 100
Silicon Oil	5.1 - 3	Spreader REECE	1.5 - 131
Skirt Marker	3.4 - 2 3.4 - 3	Spreader SINGER	1.5 - 168
Slide Plate for Standard Double Needle Machines	1.3 - 8	Spreader UNION SPECIAL	1.5 - 180 1.5 - 194
Slide Ring Foot	1.1 - 29	Spreader YAMATO	1.5 - 209
Solid Piping Foot, left	1.1 - 17	Spring DUERKOPP-ADLER	1.5 - 31
Solid Piping Foot, right	1.1 - 16	Spreader Plate DUERKOPP-ADLER	1.5 - 44
Spaghetti Attachment	1.8 - 73	Spring JUKI	1.5 - 57
Special Attachments	1.8 - 80 1.8 - 81	Spring PFAFF	1.5 - 125 7.0
Special Feller	1.8 - 52 1.8 - 53	Spring REECE	1.5 - 131
Special Feller for shirt production	1.8 - 51 1.8 - 53	Spring SINGER	1.5 - 163 1.5 - 165
Special Srewdriver	5.3 - 5	Spring Wire Hemmer Foot	1.1 - 25
Split-Tube Folder With Double Fold	1.8 - 37	Standard Foot BROTHER	1.5 - 8 1.5 - 16 1.5 - 18
Split-Tube Folder With Elastic Tape Insertion	1.8 - 47 1.8 - 48	Standard Foot CONSEW	1.5 - 18
		Standard Foot DUERKOPP-ADLER	1.5 - 21 1.5 - 23 1.5 - 27 1.5 - 33 1.5 - 36 1.5 - 37 1.5 - 38
		Standard Foot JUKI	1.5 - 55 1.5 - 56 1.5 - 57 1.5 - 68

- Standard Foot PFAFF* 1.5 - 105
1.5 - 106
1.5 - 110
1.5 - 112
- Standard Foot SINGER* 1.5 - 157
1.5 - 158
1.5 - 162
1.5 - 164
1.5 - 166
- Straight Knife* 2.3 - 2
up to 2.3 - 4
- Sublimating Chalk* 3.3 - 3
- Sublimating Pencil* 3.3 - 4
- Supervisor foot, centered* 1.1 - 20
- Supervisor foot, left* 1.1 - 21
- Supervisor foot, right* 1.1 - 20
- Switch* 1.13 - 15
- Table Stand* 1.14 - 3
- Table Tops* 1.14 - 2
- Tagging Guns* 4.4 - 2
- Tagging Needles* 4.4 - 2
- Tagging Threads* 4.4 - 3
- Tailor's Angle* 3.2 - 5
- Tailor's Chalk* 3.3 - 2
- Tailor's Chalk Pencil* 3.3 - 3
- Take-up Spring DUERKOPP - ADLER* 1.5 - 31
1.5 - 36
- Take-up Spring JUKI* 1.5 - 49
1.5 - 54
1.5 - 55
1.5 - 57
1.5 - 58
- Take-up Spring PFAFF* 1.5 - 106
1.5 - 117
- Take-up Spring REECE* 1.5 - 131
1.5 - 132
- Take-up Spring SINGER* 1.5 - 150
1.5 - 163
1.5 - 164
1.5 - 170
- Tally Counter* 3.2 - 6
- Tape Cutter* 1.9 - 3
- Tape Cutter for PFAFF* 7.1 - 2
7.1 - 3
- Tape guide with flatbed fixation* 1.8 - 78
- Tape reel stand* 1.14 - 9
- Tape retainer* 1.8 - 81
- Tape roll holder* 1.14 - 10
1.14 - 11
- TEFLEE Compensating Foot* 1.1 - 35
- TEFLEE Compensating Foot for needle feed* 1.2 - 9
- TEFLEE Hinged Presser Foot for needle feed* 1.2 - 8
- TEFLEE Presser Foot* 1.1 - 34
- Teflon Cording and Zipper Foot* 1.1 - 31
- Teflon Foot DUERKOPP-ADLER* 1.5 - 33
1.5 - 37
1.5 - 38
- Teflon Foot for needle feed* 1.2 - 7
- Teflon Foot PFAFF* 1.5 - 105
- Teflon Foot SINGER* 1.5 - 157
1.5 - 158
- Teflon Presser Foot* 1.1 - 30
- Teflon Sole DUERKOPP-ADLER* 1.5 - 33
- Teflon Sole PFAFF* 1.5 - 105
- Temperature Controller for PFAFF* 7.1 - 3
7.1 - 4
- Thermo Couple for PFAFF* 7.1
- Thread Check Spring for PFAFF* 7.0
- Thread Guide DUERKOPP - ADLER* 1.5 - 36
- Thread Guide JUKI* 1.5 - 49
1.5 - 54
- Thread Guide MAUSER-SPEZIAL* 1.7 - 6
1.7 - 7
- Thread Guide SINGER* 1.5 - 158
1.5 - 168
- Thread Nippers* 2.7 - 6
2.7 - 7
- Thread Scissor JUKI* 1.5 - 54
- Thread Scissor PFAFF* 1.5 - 108
1.5 - 111
- Thread Scissor REECE* 1.5 - 131
- Thread Scissor RIMOLDI-NECCI* 1.5 - 14

<i>Thread Stand</i>	1.14 - 9	<i>Wodden Stand</i>	4.3 - 3
<i>Thread Storage Rack</i>	1.14 - 8	<i>Zig-zag Compensating Foot</i>	1.1 - 7
<i>Threading Wires</i>	1.16 - 2	<i>Zig-zag Foot</i>	1.1 - 4
<i>Throat Plate for needle feed</i>	1.2 - 10	<i>Zig-zag Hemmer Foot</i>	1.1 - 26
<i>Throat Plate for Standard Double Needle Machines without thread cutter</i>	1.3 - 3	<i>Zipper Foot</i>	1.1 - 14
<i>Tongue MAUSER-SPEZIAL</i>	1.5 - 76	<i>Zipper Foot DUERKOPP-ADLER</i>	1.5 - 33
<i>Tongue PEGASUS</i>	1.5 - 100	<i>Zipper Foot for needle feed</i>	1.2 - 7
<i>Tongue UNION SPECIAL</i>	1.5 - 180		
<i>Tongue WILLCOX & GIBBS</i>	1.5 - 203		
<i>Tongue YAMATO</i>	1.5 - 209		
<i>Toothed Endless V-Belts</i>	1.13 - 11		
<i>Top Stich Guide Foot with Spring, right</i>	1.1 - 11		
<i>Tracing Wheel</i>	3.3 - 6		
<i>Treadle Rod</i>	1.14 - 5		
<i>Trimming Machine</i>	4.2 - 2		
<i>Trimming Machine (Accessories)</i>	4.2 - 2		
<i>Turret Presser Foot Holder</i>	1.2 - 3		
<i>Tweezer</i>	5.3 - 3		
<i>Upturn Feller Foot</i>	1.1 - 27		
<i>UV - Flourescent Tubes, black</i>	1.12 - 8		
<i>UV-Marking Items</i>	3.3 - 8		
<i>Vacuum Devices</i>	1.9 - 4		
<i>Velvet Iron Pads</i>	4.3 - 4		
<i>Waistband Attachment With Double Fold</i>	1.8 - 19		
<i>Waistband Attachment With Double Fold For Elastic Waist Band</i>	1.8 - 20		
<i>Waistband Attachment With Upper Fold For Elastic Waist Band</i>	1.8 - 20		
<i>Wax Chalk</i>	3.3 - 2		
<i>Weaver's Scissors</i>	2.7 - 14		