

Sailboat

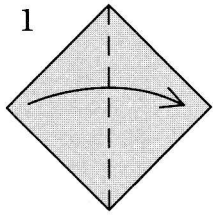

1
Fold in half.

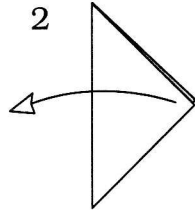

2
Unfold.

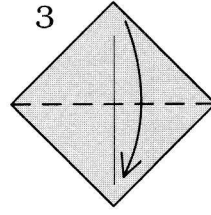

3
Fold in half.

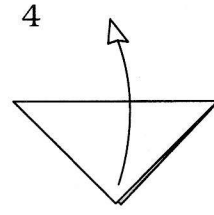

4
Unfold.

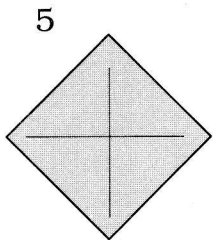

5

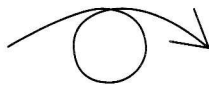

Turn over.

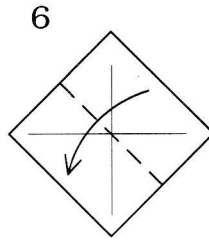

6

Book-fold.

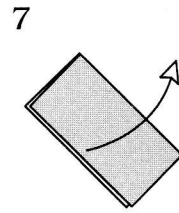

7

Unfold.

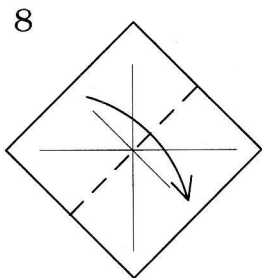

8

Book-fold.

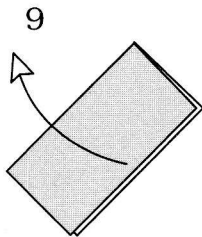

9

Unfold.

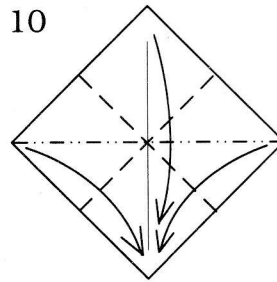

10

Collapse along the creases so that all the corners meet.

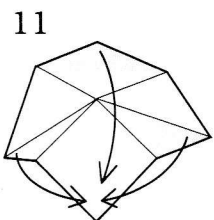

11

This is a three-dimensional intermediate step.

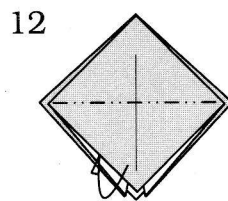

12

Fold inside.

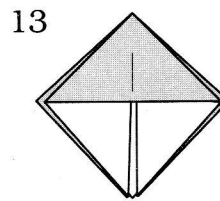

13

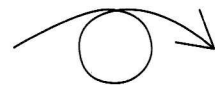

Turn over.

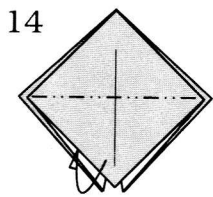

Fold inside.

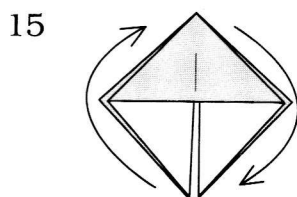

Rotate.

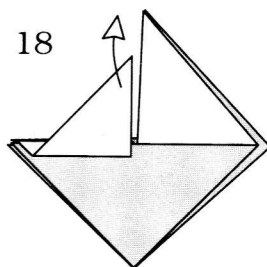
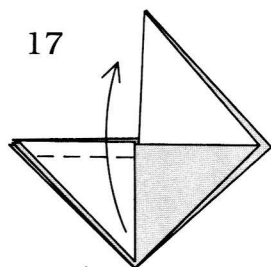
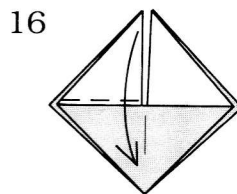

Unfold.

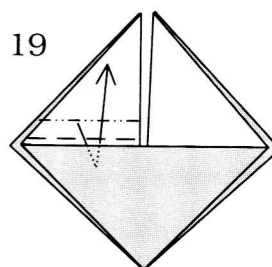

Refold while tucking inside.

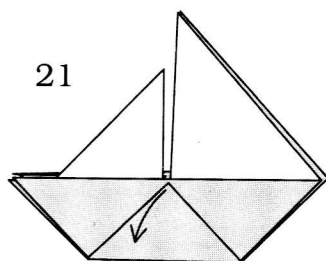
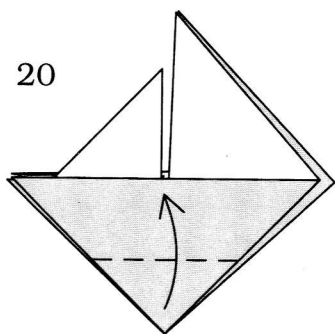

Fold the triangle
down a little so the
sailboat can stand.

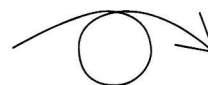

Turn over.

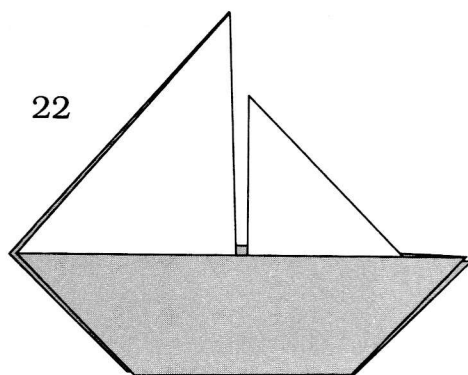

Sailboat

This sailboat is the logo for
*The Friends of The Origami
Center of America.*