

Moldings/Baseboards | Wall Panels | Coffered Ceilings | Medallions/Domes
Brackets/Corbels | Rosettes/Onlays | Sconces/Shelves

ARCHITECTURAL



ARCHITECTURAL

Bling

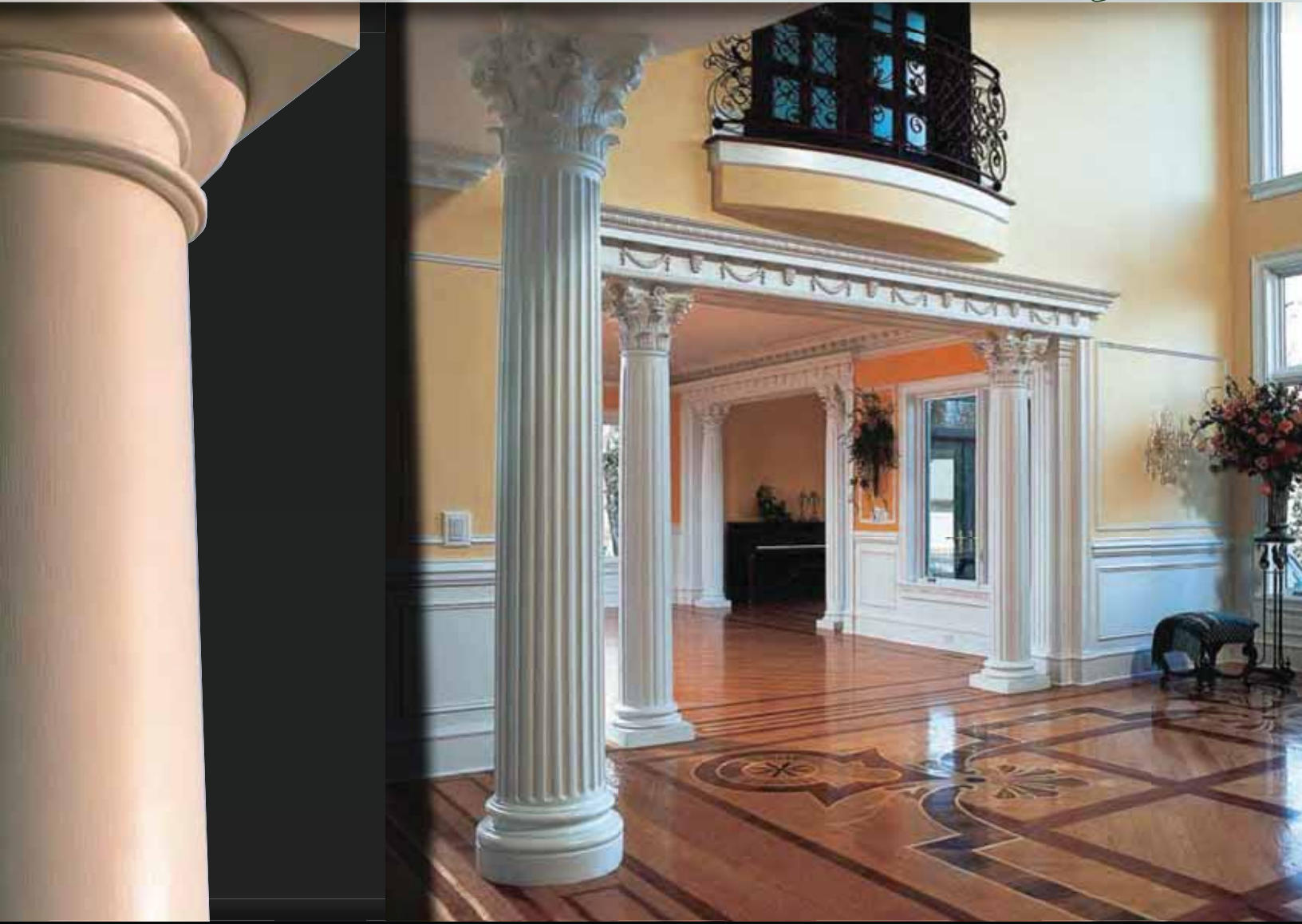

Dallas Design Community

4020 N MacArthur Blvd

122-270

Irving, TX 75038-6419

(214) 613-2285

QUICKSHIP NATIONWIDE

Standard stocked items ship
within **24-72 hours**

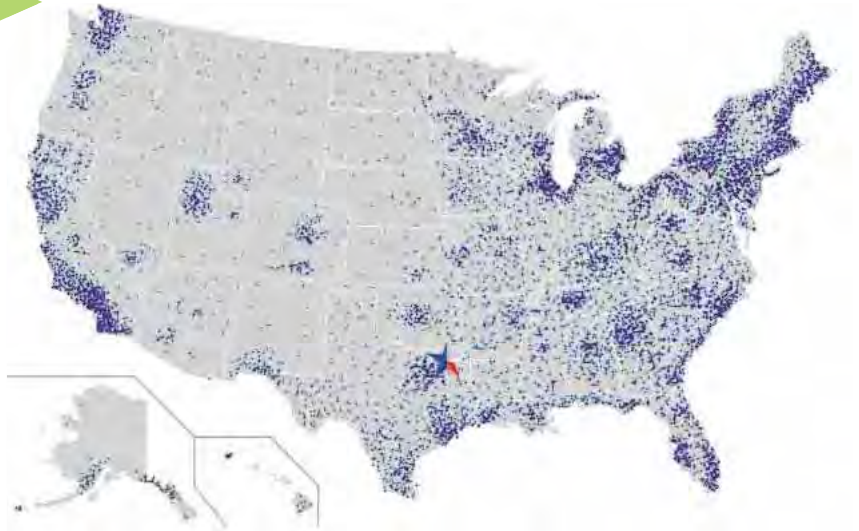

RAVE REVIEWS

"What a great company to deal with. The items are well made, well packaged, and shipped quickly. The company is a breeze to work with."

Michael S.
Huntsville, AR

"Architectural Bling's delivery is 'amazon-quick' and priced reasonably. The product quality is excellent and the service is really extraordinary. I wish I was always so lucky on "out of amazon" experiences."

James H.
Boston, MA

"To meet the custom and specific needs of commercial properties in a timely and professional manner is something that is priceless in our line of work. Architectural Bling not only met our demands but exceeded them, and most importantly delivered in perfect time to install and meet our customer's demands. We are completely satisfied and our customers are completely satisfied. You cannot beat that combination of satisfaction!"

Alejandro S.
Houston, TX

"Architectural Bling provided an easy solution for a \$3.5 million construction project where the architect didn't know what to use. This was easy and efficient and reasonably priced."

-Frederick R.
Baltimore, MD

NOTEWORTHY PROJECTS

ADOLPHUS HOTEL DALLAS
BELLAGIO CASINO LAS VEGAS
CALIFORNIA ADVENTURE
CAESAR'S PALACE LAS VEGAS
CVN 77 GEORGE H. W. BUSH
DISNEYLAND
FORT KNOX
FORT LEWIS
HARVARD LAW LIBRARY

HILTON HOTELS
UNIVERSITY OF KENTUCKY
KROGER'S GROCERY STORES
MARRIOTT RESORTS MARSHALL'S
MARRIOTT BONVOY ODESSA
CLOTHING NATIONAL GALLERY
OF ART NORDSTROM
PRESTIGE OCEANFRONT RESORT
RICHARD NIXON LIBRARY

RONALD REAGAN LIBRARY
SMITHSONIAN INSTITUTION
TARGET
TAJ MAHAL CASINO
US ARMY CORE OF ENGINEERS
VALLEY RANCH ISLAMIC CENTER
WARNER BROTHERS STUDIOS
WHITLEY COUNTY COURTHOUSE
YELLOWSTONE NATIONAL PARK

ICON KEY





-  DESIGNATES PRODUCT IS MADE TO ORDER
-  DESIGNATES PRODUCT IS SHIPPED COMMON CARRIER
-  DESIGNATES NEW PRODUCT
-  PRODUCT LEADER = BEST SELLING

TABLE OF CONTENTS

HIGH DENSITY POLYURETHANE

Crown Moulding	4
Crown Moulding Systems	31
Panel Moulding.	37
Panel Moulding Systems	61
Baseboard	69
Wall Panels	73
Coffered Ceilings	85
Ceiling Accents	97
Ceiling Medallions	98
Ceiling Rings	112
Ceiling Domes & Tiles	120
Brackets & Corbels	123
Rosettes	139
Onlays	142
Drops & Swags.	160
Left & Right Onlays	164
Stair Brackets	172
Sconces & Shelves	174



URETHANE CROWN MOULDING

Crown moulding is one of the fastest and easiest ways to add value to any interior project. Most commonly used to highlight the transition of wall to ceiling, crown is also used to cap off pilasters, accent cabinets or even build fireplace mantels. If needing large, decorative, or light-weight crown moulding, polyurethane is the perfect option for you.

Our line of polyurethane crown gives the crisp, clean details of hand-carved wood moulding, but at a fraction of the cost and half the installation time. With over 400 profiles to choose from, we are sure to have the perfect crown for your project.

BRIGHTTON: MLD18X16X24BR



F H P L \$
23 7/8" 18 1/4" 16 3/8" 82" \$235.07

NORWICH: MLD17X16X23NO



F H P L \$
23 7/8" 17 3/4" 16 1/8" 94 1/2" \$249.31

MARCELLA: MLD16X16X23MA



F H P L \$
23 3/8" 16 3/8" 16 1/2" 82" \$235.07

HARVEST: MLD16X14X21HA



F H P L \$
21 5/8" 16 3/8" 14 1/8" 94 1/2" \$211.32

MELBOURNE: MLD15X13X20MB



F H P L \$
20 5/8" 15 1/2" 13 3/8" 94 1/2" \$281.37

TRADITIONAL: MLD19X08X20TR



F H P L \$
20 1/2" 19" 8 3/8" 94 1/2" \$465.34

SYDNEY: MLD11X16X19SY



F H P L \$
19 5/8" 11 3/8" 16" 94 1/2" \$199.45

PRESTON: MLD12X15X19PR



F H P L \$
19 1/2" 12" 15 3/8" 94 1/2" \$236.25

RILEY: MLD12X15X19RL



F H P L \$
19 1/2" 12" 15 3/8" 94 1/2" \$204.20

BRIGHTTON: MLD12X15X19BR



F H P L \$
19 1/4" 12" 15 3/8" 94 1/2" \$236.25

COOGAN: MLD11X15X18CG



F H P L \$
18 3/4" 11 5/8" 15 3/8" 94 1/2" \$218.44

EMERY: MLD12X12X17EM



F H P L \$
17 1/2" 12" 12 5/8" 94 1/2" \$180.45

MARSEILLE: MLD10X14X17MA

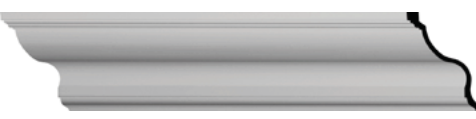

F H P L \$
17" 9 7/8" 13 3/4" 94 1/2" \$213.70

EGG & DART ACANTHUS: MLD13X10X16EG



F H P L \$
16 5/8" 13" 10 1/2" 94 1/2" \$156.71

CLAREMONT: MLD12X12X17CL



F H P L \$
16 5/8" 11 7/8" 11 7/8" 94 1/2" \$189.95

MILTON: MLD10X12X16MI



F H P L \$
16 1/8" 10 5/8" 12 5/8" 94 1/2" \$177.19

MELBOURNE: MLD11X10X15MB



F H P L \$
15 7/8" 11 3/8" 10 7/8" 94 1/2" \$193.51

KINSLEY: MLD11X11X15KN



F H P L \$
15 3/4" 11 1/8" 11 1/8" 94 1/2" \$165.02

CLASSIC: MLD12X10X15CL



F H P L \$
15 1/4" 11 7/8" 9 1/2" 94 1/2" \$195.89

ERIS: MLD13X07X12ER



F H P L \$
14 5/8" 13" 6 7/8" 94 1/2" \$189.95

★ **HILLSBOROUGH:** MLD09X10X14HI



F H P L \$
14 1/2" 9 7/8" 10 5/8" 94 1/2" \$136.53



FASCIA: MLD13X06X12FA



F	H	P	L	\$
14 1/4"	12 3/4"	6 1/4"	78 3/4"	\$136.53

MILTON: MLD09X12X14CL



F	H	P	L	\$
14 1/4"	9"	11 3/4"	94 1/2"	\$149.42

CLAREMONT: MLD10X10X14CL



F	H	P	L	\$
14"	9 7/8"	9 7/8"	94 1/2"	\$172.14

GRANADA: MLD09X09X14GR



F	H	P	L	\$
14"	9 7/8"	9 3/4"	94 1/2"	\$184.02

SYDNEY: MLD09X10X13SY



F	H	P	L	\$
13 3/4"	9 1/2"	10"	94 1/2"	\$111.60

ROSETTA: MLD08X09X12RO



F	H	P	L	\$
12 1/2"	9"	9"	94 1/2"	\$135.34

BRIGHTON: MLD07X09X11BR



F	H	P	L	\$
11 7/8"	7 3/4"	9"	94 1/2"	\$104.47

FASCIA: MLD12X07X14FA



F	H	P	L	\$
14"	12 1/8"	7 1/8"	94 1/2"	\$154.34

CHESTERFIELD: MLD11X04X12CH



F	H	P	L	\$
12 5/8"	11 7/8"	4"	94 1/2"	\$136.53

DUBLIN: MLD09X09X12DU



F	H	P	L	\$
12 3/8"	8 3/4"	8 3/4"	94 1/2"	\$132.97

TITUS: MLD09X07X11TT



F	H	P	L	\$
11 7/8"	9 1/4"	7 1/2"	94 1/2"	\$113.97

SPRINGTIME: MLD11X08X13SP



F	H	P	L	\$
13 7/8"	11 3/8"	8 1/8"	94 1/2"	\$231.50

FOSTER COVE: MLD09X09X13FO



F	H	P	L	\$
12 1/2"	8 1/2"	9 1/4"	94 1/2"	\$113.97

MEDWAY: MLD08X08X12ME

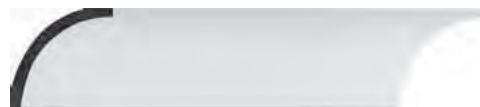

F	H	P	L	\$
12"	8 1/2"	8 1/2"	94 1/2"	\$91.41

DENTIL: MLD06X09X11DE



F	H	P	L	\$
11 3/4"	6 3/4"	9 7/8"	94 1/2"	\$102.10



NEUVEAU: MLD07X09X11NA



F	H	P	L	\$
11 3/4"	7 3/4"	9"	94 1/2"	\$100.91

RAYMOND: MLD07X09X11RA



F	H	P	L	\$
11 3/4"	7 3/8"	9 1/8"	94 1/2"	\$106.85

HARVEST: MLD08X08X11HA



F	H	P	L	\$
11 3/4"	8 5/8"	8 1/8"	94 1/2"	\$105.66

DENTIL: MLD07X08X11DE



F	H	P	L	\$
11 3/4"	7 3/4"	8 3/4"	94 1/2"	\$149.59

FOSTER COVE: MLD08X08X12FO



F	H	P	L	\$
11 1/2"	7 7/8"	7 7/8"	94 1/2"	\$111.60

★ **ACANTHUS: MLD08X08X11AC**



F	H	P	L	\$
11 1/2"	8 1/4"	8"	94 1/2"	\$113.97

ALEXANDRIA: MLD09X07X11AL



F	H	P	L	\$
11 1/4"	8 3/4"	7"	94 1/2"	\$155.44

ODESSA: MLD07X09X11OD



F	H	P	L	\$
11 1/4"	6 5/8"	9"	94 1/2"	\$125.50

MEDEA: MLD08X07X11MD



F	H	P	L	\$
11 1/4"	8 3/4"	7"	94 1/2"	\$78.36

ERIS: MLD08X08X11ER



F	H	P	L	\$
11 1/8"	7 7/8"	8"	94 1/2"	\$90.23

ERIS: MLD07X08X11ER

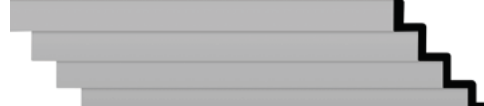

F	H	P	L	\$
11"	7 5/8"	8 1/8"	94 1/2"	\$106.85

TRADITIONAL: MLD08X08X11TR



F	H	P	L	\$
11"	7 3/4"	7 3/4"	94 1/2"	\$99.72

ROBIN: MLD09X06X11RO



F	H	P	L	\$
10 3/4"	9 1/8"	5 7/8"	94 1/2"	\$87.85

FOSTER: MLD08X06X10FO



F	H	P	L	\$
10 5/8"	8 1/4"	6 5/8"	94 1/2"	\$107.91

AMELIA: MLD08X06X10AM



F	H	P	L	\$
10 3/8"	8 1/4"	6 1/4"	94 1/2"	\$102.10

FLORAL SWAG: MLD06X08X10FL



F	H	P	L	\$
10 3/8"	6 3/8"	8"	94 1/2"	\$106.25

JONEE: MLD08X07X10JO



F	H	P	L	\$
10 1/4"	7 7/8"	6 5/8"	94 1/2"	\$170.87

EGG AND DART: MLD06X07X10EG



F	H	P	L	\$
10 1/4"	6 3/4"	7 3/4"	94 1/2"	\$99.72

1 FOOT SAMPLES AVAILABLE

FACE
HEIGHT
PROJECTION



CROWNMOULDING

BEDFORD: MLD07X07X10BE



F	H	P	L	\$
10 1/4"	7 3/8"	7 1/4"	94 1/2"	\$94.98

ANTONIO: MLD04X09X10AN



F	H	P	L	\$
10 1/4"	4"	9"	94 1/2"	\$66.48

DENTIL: MLD08X04X10DE



F	H	P	L	\$
10 1/8"	8 7/8"	4 7/8"	94 1/2"	\$85.48

DENTIL: MLD08X06X10DE



F	H	P	L	\$
10 1/8"	7 7/8"	6 3/8"	94 1/2"	\$94.98

DEVON: MLD07X07X09DE



F	H	P	L	\$
9 7/8"	7 1/4"	7 1/8"	94 1/2"	\$96.16

NOUVEAU: MLD08X05X09NO



F	H	P	L	\$
9 7/8"	8 1/2"	5"	94 1/2"	\$102.10

KINSLEY: MLD07X07X09KI



F	H	P	L	\$
9 7/8"	7"	7"	94 1/2"	\$77.17

DENTIL: MLD06X08X10DE



F	H	P	L	\$
9 7/8"	6 3/8"	7 3/4"	94 1/2"	\$77.17

SOUTHAMPTON: MLD09X03X09SO



F	H	P	L	\$
9 7/8"	9 1/8"	3 7/8"	94 1/2"	\$83.10

WOODRUFF: MLD09X03X09WF



F	H	P	L	\$
9 7/8"	9 1/8"	3 3/4"	94 1/4"	\$83.10

ALEXANDRIA: MLD09X03X10AL



F	H	P	L	\$
9 7/8"	9 1/4"	3 3/4"	94 1/2"	\$68.86

FOSTER: MLD06X07X09FO



F	H	P	L	\$
9 3/4"	6 3/4"	7"	94 1/2"	\$68.86

JACKSON: MLD05X08X10JA



F	H	P	L	\$
9 5/8"	5 1/4"	7 7/8"	94 1/2"	\$70.04

FLORAL SWAG: MLD06X06X09FL



F	H	P	L	\$
9 5/8"	6 3/4"	6 7/8"	94 1/2"	\$74.79

ARTIS: MLD07X06X09AR



F	H	P	L	\$
9 5/8"	7 3/8"	6 1/8"	94 1/2"	\$89.72

CLASSIC: MLD07X05X09CL



F	H	P	L	\$
9 1/2"	7 3/4"	5 1/4"	94 1/2"	\$93.79

ATHENA: MLD07X06X09AT



F	H	P	L	\$
9 1/2"	7 1/8"	6 1/4"	94 1/2"	\$61.73

ODESSA: MLD07X05X09OD



F	H	P	L	\$
9 1/2"	7 3/4"	5 1/2"	94 1/2"	\$64.11

EGG AND DART: MLD06X07X09EG



F	H	P	L	\$
9 3/8"	6 1/4"	7"	94 1/2"	\$73.61

NIOBE: MLD05X07X09NI



F	H	P	L	\$
9 3/8"	5"	7 1/2"	94 1/2"	\$47.49

JACKSON: MLD07X06X09JA



F	H	P	L	\$
9 1/4"	7 3/8"	5 3/4"	94 1/2"	\$73.61

STOCKPORT: MLD06X06X09ST



F H P L \$
9 1/4" 6 1/2" 6 1/2" 94 1/2" \$113.97

AVERY: MLD00X08X12AV



F H P L \$
9" 7" 8 7/8" 94 1/2" \$65.30

CLAREMONT: MLD06X06X09CL



F H P L \$
9" 6 3/8" 6 3/8" 94 1/2" \$76.57

FOSTER COVE: MLD06X06X09FO



F H P L \$
9" 6 1/4" 6 1/2" 94 1/2" \$58.17

BEDFORD: MLD08X03X09BE



F H P L \$
9" 8 3/8" 3 3/4" 94 1/2" \$66.48

LINUS: MLD06X06X08LI



F H P L \$
8 7/8" 6 1/4" 6 1/8" 94 1/2" \$53.42

CLASSIC: MLD06X06X08CL



F H P L \$
8 7/8" 6 1/4" 6 1/4" 94 1/2" \$66.48

HOLMDEL: MLD07X06X09HO



F H P L \$
8 7/8" 6 1/2" 6 3/8" 94 1/2" \$66.48

HARVEST: MLD06X05X08HA



F H P L \$
8 7/8" 6 3/4" 5 7/8" 94 1/2" \$64.11

BRIGHTTON: MLD06X06X09BR



F H P L \$
8 7/8" 6" 6 3/8" 94 1/2" \$68.86

SOUTHAMPTON: MLD06X06X09HM



F H P L \$
8 7/8" 6 1/4" 6 1/4" 94 1/2" \$81.92

SYDNEY: MLD06X06X08SY



F H P L \$
8 7/8" 6 1/4" 6 1/4" 94 1/2" \$73.61

SHELL: MLD07X06X09SH



F H P L \$
8 3/4" 6 3/4" 5 1/2" 94 1/2" \$71.23

EGG AND DART: MLD07X05X08EG



F H P L \$
8 3/4" 7 1/4" 5" 94 1/2" \$74.79

NOUVEAU: MLD07X05X08NO



F H P L \$
8 5/8" 7 1/4" 5" 94 1/2" \$55.80

NEVIO: MLD06X05X08NE



F H P L \$
8 5/8" 6 3/4" 5 1/2" 94 1/2" \$61.73

CORNELIA: MLD06X06X08CN



F H P L \$
8 5/8" 6 3/8" 6 1/4" 94 1/2" \$61.73

DUBLIN: MLD07X05X08DU



F H P L \$
8 5/8" 7 1/4" 5 3/8" 94 1/2" \$71.23

CARRILLO: MLD06X06X09CI



F H P L \$
8 5/8" 6 1/2" 6" 94 1/2" \$48.68

JONEE: MLD07X06X09JO



F H P L \$
8 5/8" 6 5/8" 5 1/2" 94 1/2" \$83.10

ZEPHYR: MLD07X05X08ZE



F H P L \$
8 5/8" 7" 5" 94 1/2" \$75.98

FACE
HEIGHT
PROJECTION



CROWNMOULDING

CLAREMONT: MLD06X05X08CL

F	H	P	L	\$
8 5/8"	6 1/2"	5 3/4"	94 1/2"	\$47.49

TIRANA: MLD06X05X08TI

CORNERS
Page 42

F	H	P	L	\$
8 5/8"	6 7/8"	5 1/8"	94 1/2"	\$45.11

PALMETTO: MLD06X05X08PM

F	H	P	L	\$
8 1/2"	6 5/8"	5 1/8"	94 1/2"	\$48.68

VERSAILLES: MLD05X06X08VE

CORNERS
Page 42

F	H	P	L	\$
8 1/2"	5 5/8"	6 3/8"	94 1/2"	\$45.11

DENTIL: MLD06X04X08DE

F	H	P	L	\$
8 3/8"	6 3/4"	4 3/4"	94 1/2"	\$46.00

EDWARDS: MLD06X06X08ED

F	H	P	L	\$
8 3/8"	5 7/8"	5 7/8"	94 1/2"	\$64.11



KENT: MLD06X06X08KE

F	H	P	L	\$
8 3/8"	5 7/8"	5 7/8"	94 1/2"	\$61.73

BRIGHTTON: MLD06X06X08BR

F	H	P	L	\$
8 3/8"	6"	6"	94 1/2"	\$73.61

BERKSHIRE: MLD06X05X08BE

F	H	P	L	\$
8 1/4"	6 1/2"	5"	94 1/2"	\$59.36

MONIQUE: MLD05X06X08MO

CORNERS
Page 42

F	H	P	L	\$
8 1/4"	5 1/4"	6 1/4"	94 1/2"	\$53.42

CRENDON: MLD06X05X08CR

F	H	P	L	\$
8 1/8"	6 1/8"	5 3/8"	94 1/2"	\$58.17

FLOWER: MLD07X03X08FL

F	H	P	L	\$
8 1/8"	7 1/2"	3 1/8"	94 1/2"	\$54.61

MARSEILLE: MLD06X05X08MA

F	H	P	L	\$
8"	5 5/8"	4 5/8"	94 1/2"	\$52.24

EGG AND DART: MLD05X06X07EG

F	H	P	L	\$
7 7/8"	5 1/8"	6"	94 1/2"	\$68.86

ALEXA: MLD06X04X07AX

F	H	P	L	\$
7 7/8"	6 1/4"	4 3/4"	94 1/2"	\$55.80

FLOWER: MLD05X05X07FL

F	H	P	L	\$
7 7/8"	5 3/4"	5 7/8"	94 1/2"	\$43.93

MILTON: MLD07X03X08MI

F	H	P	L	\$
7 3/4"	7 1/8"	3 1/4"	94 1/2"	\$55.80

MARIA: MLD03X04X05TR



CORNERS
Page 42

F	H	P	L	\$
7 3/4"	6"	4 1/2"	94 1/2"	\$44.99

FASCIA: MLD06X05X08FA



F	H	P	L	\$
7 3/4"	6 7/8"	5 1/2"	94 1/2"	\$85.86

ARTIS: MLD05X05X07AR



F	H	P	L	\$
7 5/8"	5 5/8"	5 1/4"	94 1/2"	\$53.42

DIANE: MLD05X05X08DI



CORNERS
PAGE 46

F	H	P	L	\$
7 1/2"	5 3/8"	5 1/4"	94 1/2"	\$65.30

DYLAN: MLD06X05X08DY

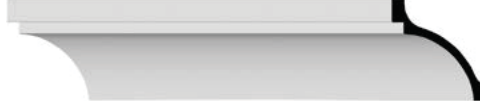

F	H	P	L	\$
7 1/2"	5 1/2"	5 1/8"	94 1/2"	\$54.61

FOSTER COVE: MLD05X05X07FO

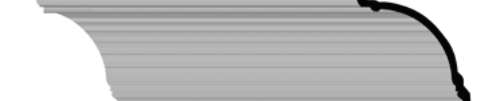

F	H	P	L	\$
7 1/2"	5 3/8"	5 3/8"	94 1/2"	\$49.86

NESTOR: MLD05X04X07NS



F	H	P	L	\$
7 1/2"	5 7/8"	4 3/4"	94 1/2"	\$45.11

FEDERAL: MLD05X04X07FE



F	H	P	L	\$
7 1/2"	5 3/4"	4 3/4"	94 1/2"	\$43.93



ATTICA: MLD05X05X07AT



CORNERS
Page 42

F	H	P	L	\$
7 1/2"	5 1/4"	5 1/4"	94 1/2"	\$47.49

MITER-FREE CROWN MOULDING ON Page 31

TERRONES: MLD05X05X07TS



F	H	P	L	\$
7 3/8"	5"	5 3/8"	94 1/2"	\$54.61

HAMPSHIRE: MLD06X04X07HA



F	H	P	L	\$
7 1/4"	6"	4 1/8"	94 1/2"	\$51.05

DIANE: MLD06X04X07DI



CORNERS
Page 42

F	H	P	L	\$
7 1/4"	4 1/8"	6 1/8"	94 1/2"	\$37.99

GENEVIEVE: MLD06X02X07GE



F	H	P	L	\$
7 1/4"	7"	3"	94 1/2"	\$45.11

VALLETTA: MLD07X02X07VL



F	H	P	L	\$
7 1/4"	7"	2 1/4"	94 1/2"	\$45.11

DENTIL: MLD05X05X07DE



F	H	P	L	\$
7 1/8"	5"	5"	94 1/2"	\$48.68

WAKEFIELD: MLD05X05X07WA



F	H	P	L	\$
7 1/8"	5"	5"	94 1/2"	\$48.68

SHELL: MLD06X03X07SH



F	H	P	L	\$
7"	6 1/4"	3 3/8"	94 1/2"	\$53.42

HEATON: MLD05X05X07HE



F	H	P	L	\$
7"	5 1/8"	4 3/4"	94 1/2"	\$47.49

FACE
HEIGHT
PROJECTION



CROWNMOULDING

FLORAL: MLD06X02X07FL



F	H	P	L	\$
7"	6 1/4"	2 3/4"	94 1/2"	\$53.42

FELIX: MLD05X05X07FE



F	H	P	L	\$
7"	5"	5"	94 1/2"	\$42.74

KIRKE: MLD06X02X07KI



F	H	P	L	\$
7"	6 3/8"	2 1/2"	94 1/2"	\$42.74

NADIA: MLD04X05X07NA



F	H	P	L	\$
7"	4 3/4"	5 1/8"	94 1/2"	\$42.74

CARRILLO: MLD04X05X07CI



F	H	P	L	\$
6 7/8"	4 5/8"	5 3/8"	94 1/2"	\$45.11

WAKEFIELD: MLD04X04X06WA



F	H	P	L	\$
6 3/4"	4 3/4"	4 3/4"	94 1/2"	\$50.67

LINUS: MLD05X05X07LI



F	H	P	L	\$
6 3/4"	4 3/4"	4 3/4"	94 1/2"	\$46.30

JACKSON: MLD04X04X06JA



F	H	P	L	\$
6 3/4"	4 3/4"	4 3/4"	94 3/8"	\$48.68

DENTIL AND BEAD: MLD06X03X06DE



F	H	P	L	\$
6 3/4"	5 3/4"	3 7/8"	94 1/2"	\$61.73

KINSLEY: MLD04X04X06KI



F	H	P	L	\$
6 3/4"	4 3/4"	4 3/4"	94 1/2"	\$49.86

BLACKTHORN: MLD05X04X07BL



F	H	P	L	\$
6 3/4"	5 3/8"	4"	94 1/2"	\$42.74

TRADITIONAL: MLD05X03X06TR



F	H	P	L	\$
6 3/4"	5 1/2"	3 7/8"	94 1/2"	\$37.99

TRISTAN: MLD04X04X06TN



F	H	P	L	\$
6 3/4"	4 3/4"	4 3/4"	94 1/2"	\$40.36

ARTIS EGG AND DART: MLD04X05X06AR



F	H	P	L	\$
6 3/4"	4 1/4"	5 1/4"	94 1/2"	\$37.99

ROSE: MLD05X02X06RO



F	H	P	L	\$
6 3/4"	5 1/2"	3 3/4"	94 1/2"	\$36.80

FEDERAL: MLD05X04X06SA



F	H	P	L	\$
6 3/4"	5 1/8"	4 1/4"	94 1/2"	\$37.99

FRANCIS: MLD05X05X07FR



F	H	P	L	\$
6 5/8"	4 1/2"	4 3/4"	94 1/2"	\$44.99

WINSTON: MLD05X04X07WN



F	H	P	L	\$
6 5/8"	4 7/8"	4 1/2"	94 1/2"	\$48.68

FLORAL: MLD04X04X06FL



F	H	P	L	\$
6 5/8"	4 3/4"	4 1/2"	94 1/2"	\$47.49

HARVEST: MLD04X04X06HA



F	H	P	L	\$
6 5/8"	4 5/8"	4 3/4"	94 1/2"	\$45.11

EGG AND DART: MLD06X03X07EG



F	H	P	L	\$
6 5/8"	6"	3 1/8"	94 1/2"	\$45.11

FEDERAL: MLD05X06X06FE



F	H	P	L	\$
6 5/8"	5 1/4"	4"	94 1/2"	\$37.99

TOMANGO: MLD05X02X06TO



F	H	P	L	\$
6 1/2"	5 3/4"	2 7/8"	94 1/2"	\$45.11

MARCUS: MLD04X04X06MC



F	H	P	L	\$
6 1/2"	4 7/8"	4 1/4"	94 1/2"	\$64.11

WASHINGTON: MLD05X03X06WA



F	H	P	L	\$
6 1/2"	5 3/4"	3 1/8"	94 1/2"	\$43.93

RICHMOND: MLD06X02X06RI



F	H	P	L	\$
6 1/2"	6"	2 7/8"	94 1/2"	\$47.49

COLE: MLD04X05X07CO



F	H	P	L	\$
6 1/2"	4 1/8"	5"	94 1/2"	\$51.05

BRIGHTTON: MLD05X05X06BR



F	H	P	L	\$
6 1/2"	4 5/8"	4 5/8"	94 1/2"	\$49.86

SCOTT: MLD05X03X06SC



F	H	P	L	\$
6 1/2"	5"	3 7/8"	94 3/8"	\$47.49

JONEE: MLD04X04X06JO



F	H	P	L	\$
6 1/2"	4 7/8"	4 1/4"	94 1/2"	\$52.11

STRASBOURG: MLD04X04X06SG



CORNERS
PAGE 43

F	H	P	L	\$
6 1/2"	4 7/8"	4 3/8"	94 1/2"	\$35.62

DENTIL: MLD05X03X06DE



F	H	P	L	\$
6 3/8"	5"	3 7/8"	94 1/2"	\$54.61

NEVIO: MLD04X04X06NE



F	H	P	L	\$
6 3/8"	4 5/8"	4 3/8"	94 1/2"	\$42.74

DENTIL: MLD05X04X06DE



F	H	P	L	\$
6 3/8"	4 3/4"	4 1/8"	94 1/2"	\$49.86

EDWARDS: MLD04X05X06ED



CORNERS
PAGE 43

F	H	P	L	\$
6 3/8"	4"	5"	94 1/2"	\$36.80

BRADFORD: MLD04X04X06BR



CORNERS
PAGE 43

F	H	P	L	\$
6 3/8"	4 1/4"	4 3/4"	94 1/2"	\$42.74

DENTIL: MLD04X04X06DE



CORNERS
PAGE 43

F	H	P	L	\$
6 3/8"	4 1/2"	4 1/2"	94 1/2"	\$40.36

EMERY: MLD04X04X06EM



F	H	P	L	\$
6 3/8"	4 1/2"	4 5/8"	94 1/2"	\$40.36

KENT: MLD05X02X06KE



F	H	P	L	\$
6 3/8"	5 7/8"	2 1/2"	94 1/2"	\$43.93

NAOMI: MLD06X03X06NA



F	H	P	L	\$
6 1/4"	5 5/8"	3"	94 1/2"	\$47.49

FLOWING WIND: MLD05X03X06FD



F	H	P	L	\$
6 1/4"	5 1/8"	3 3/8"	94 1/2"	\$39.18

HELENE: MLD04X04X06HE



F	H	P	L	\$
6 1/4"	4 5/8"	4 1/8"	94 1/2"	\$42.74



WE DO FLEX MOULDING



LOERA: MLD04X04X06LO



F	H	P	L	\$
6 1/8"	4 3/8"	4 3/8"	94 1/2"	\$45.11

SEQUENTIAL: MLD05X04X06SE



F	H	P	L	\$
6 1/8"	4 3/4"	4"	94 1/2"	\$46.30

IRIS: MLD05X03X06IS



F	H	P	L	\$
6 1/8"	5 1/8"	3 1/2"	94 1/2"	\$40.36

COVE DENTIL: MLD05X05X06DE



F	H	P	L	\$
6 1/8"	4 3/4"	4 1/4"	94 1/2"	\$47.49

CHARLOTTE: MLD04X04X06CT



F	H	P	L	\$
6 1/8"	4 1/4"	4 1/4"	94 1/2"	\$40.36

CLASSIC: MLD04X04X06CL



F	H	P	L	\$
6 1/8"	4"	4 5/8"	94 1/2"	\$43.93

WINSTON: MLD04X04X06WN



F	H	P	L	\$
6"	4 1/4"	4 1/4"	94 1/2"	\$43.93

BEDFORD: MLD05X02X06BE



F	H	P	L	\$
6"	5 5/8"	2 1/4"	94 1/2"	\$45.11

ERIS: MLD04X04X06ER



F	H	P	L	\$
6"	4 1/4"	4 1/4"	94 1/2"	\$43.93

CORNERS
PAGE 43

★ **NIOBE:** MLD05X03X06NI



F	H	P	L	\$
6"	5 1/8"	3 1/8"	94 1/2"	\$36.80

WAKEFIELD: MLD04X05X06WA



F	H	P	L	\$
6"	4 3/4"	5 1/8"	94 1/2"	\$40.36

CORNERS
PAGE 43

BEDFORD: MLD04X03X06BE



F	H	P	L	\$
6"	4 7/8"	3 1/2"	94 1/2"	\$40.36

COLTON: MLD04X03X06CO



F	H	P	L	\$
6"	4 1/2"	3 7/8"	94 1/2"	\$41.55

DUBLIN: MLD04X03X06DU



F	H	P	L	\$
6"	4 1/2"	3 3/4"	94 1/2"	\$40.36

FLORAL: MLD05X02X06FL



F	H	P	L	\$
6"	5 5/8"	2 1/4"	94 1/2"	\$33.24

CORNERS
PAGE 43

RICHMOND: MLD05X02X06RI



CORNERS
PAGE 43

F	H	P	L	\$
6"	5 1/2"	2 1/4"	94 1/2"	\$37.99

SPRINGTIME: MLD05X02X06SP



F	H	P	L	\$
6"	5 1/8"	2 7/8"	94 1/2"	\$40.36

PALMETTO: MLD03X04X06PA



F	H	P	L	\$
6"	3 3/4"	4 5/8"	94 1/2"	\$41.55

DUBLIN: MLD04X03X05DU



F	H	P	L	\$
5 7/8"	4 3/8"	3 3/4"	94 1/2"	\$33.24

ZADLO: MLD04X04X06ZA



F	H	P	L	\$
5 7/8"	4 1/8"	4 1/8"	94 1/2"	\$40.36

EGG AND DART: MLD05X03X06EG



F	H	P	L	\$
5 7/8"	5 1/8"	3"	94 1/2"	\$36.80

NESTOR: MLD05X03X06NS



F	H	P	L	\$
5 7/8"	4 3/4"	3 3/8"	94 1/2"	\$41.55

ADONIS: MLD04X03X04AD

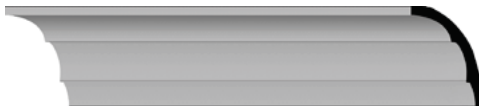

F	H	P	L	\$
5 7/8"	4 3/4"	3 1/2"	94 1/2"	\$41.55

SYDNEY: MLD04X04X05SY



F	H	P	L	\$
5 7/8"	4 1/4"	4 1/8"	94 1/2"	\$41.55

VERSAILLES: MLD04X04X06VE



F	H	P	L	\$
5 7/8"	4 3/8"	4"	94 1/2"	\$33.24

LOGAN: MLD05X03X05LO



F	H	P	L	\$
5 7/8"	5"	3 1/4"	94 1/2"	\$37.99

VICTORIAN: MLD05X03X05VI



F	H	P	L	\$
5 7/8"	5 1/8"	3 1/8"	94 1/2"	\$43.93

DENTIL: MLD03X04X06DE



F	H	P	L	\$
5 7/8"	3 3/4"	4 1/2"	94 1/2"	\$53.42

DENTIL: MLD04X03X06NO



F	H	P	L	\$
5 7/8"	4 1/2"	3 3/4"	94 1/2"	\$53.42

DUBLIN: MLD04X04X04DU



F	H	P	L	\$
5 7/8"	4 1/8"	4 1/4"	94 1/2"	\$40.36

BULWARK: MLD03X04X05BU



CORNERS
PAGE 43

F	H	P	L	\$
5 7/8"	3 7/8"	4 1/2"	94 1/2"	\$37.99

DEVON: MLD03X04X05DE



F	H	P	L	\$
5 7/8"	3 3/8"	4 3/4"	94 1/2"	\$36.80

BATEMAN: MLD04X04X05BA



F	H	P	L	\$
5 7/8"	4 1/8"	4 1/4"	94 1/2"	\$36.80

HAMPSHIRE: MLD05X03X05HA



F	H	P	L	\$
5 7/8"	5"	3"	94 1/2"	\$36.80

**SHIPS OUT IN
24-72 HOURS**

FACE
HEIGHT
PROJECTION



CROWNMOULDING

SHELL: MLD04X04X06SH



F	H	P	L	\$
5 3/4"	4 1/8"	4 1/8"	94 1/2"	\$47.49

CHESTERFIELD: MLD03X04X05CH



F	H	P	L	\$
5 3/4"	3 7/8"	4 1/8"	94 1/2"	\$34.43

EGG AND DART: MLD03X03X05EG



F	H	P	L	\$
5 3/4"	4"	4"	94 1/2"	\$41.55

LOERA: MLD04X04X05LO



F	H	P	L	\$
5 3/4"	4 1/4"	4"	94 1/2"	\$39.18

BULWARK: MLD04X04X06BU



F	H	P	L	\$
5 3/4"	4 1/4"	3 7/8"	94 1/2"	\$52.24

ARTIS: MLD05X03X06AR



F	H	P	L	\$
5 3/4"	2 3/4"	5 1/8"	94 1/2"	\$46.30

HAMPSHIRE: MLD05X04X06HA



F	H	P	L	\$
5 3/4"	4 1/2"	3 1/2"	94 1/2"	\$41.55

ELSINORE: MLD04X03X05EL



F	H	P	L	\$
5 3/4"	4 5/8"	3 1/2"	94 1/2"	\$35.62

ASA: MLD09X07X10AS



F	H	P	L	\$
5 5/8"	3 1/4"	4 7/8"	91 1/2"	\$83.10

LEAF: MLD04X04X05LT



F	H	P	L	\$
5 5/8"	4"	4"	94 1/2"	\$34.43

ROSE: MLD03X04X05RO

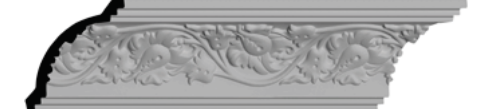

F	H	P	L	\$
5 5/8"	3 7/8"	4"	94 1/2"	\$37.99

HEATON: MLD03X04X06HE



F	H	P	L	\$
5 5/8"	3 7/8"	4"	94 1/2"	\$49.86

DENTIL: MLD04X03X06DE



F	H	P	L	\$
5 5/8"	4 3/8"	3 1/2"	94 1/2"	\$41.55

LINUS: MLD04X04X06LI



F	H	P	L	\$
5 5/8"	4"	4"	94 1/2"	\$39.18

FOSTER: MLD02X05X05FO



F	H	P	L	\$
5 5/8"	2 1/8"	5 3/8"	94 1/2"	\$32.05

DYLAN: MLD03X04X05DY



F	H	P	L	\$
5 5/8"	3 3/4"	4 1/8"	94 1/2"	\$32.05

CORNERS
PAGE 43

LYON: MLD05X03X06LY



F	H	P	L	\$
5 1/2"	4 3/4"	2 3/4"	94 1/2"	\$41.55

DIJON: MLD04X04X05DI



F	H	P	L	\$
5 1/2"	4 1/8"	4"	94 1/2"	\$37.99

COVE: MLD04X04X05CO



F	H	P	L	\$
5 1/2"	3 7/8"	3 7/8"	94 1/2"	\$42.74

EMERY: MLD04X04X05EM



F	H	P	L	\$
5 1/2"	3 7/8"	3 7/8"	94 1/2"	\$36.80

CARRILLO: MLD04X04X05CI



F	H	P	L	\$
5 1/2"	3 7/8"	3 7/8"	94 1/2"	\$32.05

KEPLER: MLD04X04X05KP



F	H	P	L	\$
5 1/2"	4"	3 7/8"	94 1/2"	\$35.62

GRAPE: MLD04X04X05GR



F	H	P	L	\$
5 1/2"	3 7/8"	3 7/8"	94 1/2"	\$40.36

ROSE: MLD04X04X05RO



F	H	P	L	\$
5 1/2"	3 7/8"	3 7/8"	94 1/2"	\$38.58

VERSAILLES: MLD05X02X05VE



F	H	P	L	\$
5 1/2"	4 7/8"	2 1/2"	94 1/2"	\$42.74

DENTIL: MLD05X03X05DE



F	H	P	L	\$
5 1/2"	4 5/8"	2 7/8"	94 1/2"	\$35.62

KENDALL: MLD04X04X06KD



F	H	P	L	\$
5 1/2"	4 1/8"	3 5/8"	94 1/2"	\$41.55

DUBLIN: MLD03X03X05DU



F	H	P	L	\$
5 1/2"	3 7/8"	3 7/8"	94 1/2"	\$29.68

FOSTER: MLD03X03X05FO



F	H	P	L	\$
5 1/2"	3 7/8"	3 7/8"	94 1/2"	\$29.68

GORLEEN: MLD03X03X05GO



F	H	P	L	\$
5 1/2"	3 7/8"	3 7/8"	94 1/2"	\$33.24

MARCELLA: MLD03X04X05MA



F	H	P	L	\$
5 1/2"	3 3/4"	4 1/8"	94 1/2"	\$33.24

ASA: MLD04X02X05AS



F	H	P	L	\$
5 1/2"	5"	2 1/2"	94 1/2"	\$33.24

DEVON: MLD04X03X05DE



F	H	P	L	\$
5 1/2"	4 1/2"	3 1/4"	94 1/2"	\$33.24

WINDSOR: MLD03X04X05WI



F	H	P	L	\$
5 1/2"	3 3/4"	3 7/8"	94 1/2"	\$34.43

JACKSON: MLD03X03X05JA



F	H	P	L	\$
5 3/8"	3 3/4"	3 7/8"	94 1/4"	\$36.80

VERSAILLES: MLD04X04X05VE



F	H	P	L	\$
5 3/8"	4 3/8"	3 1/4"	94 1/2"	\$36.80

LOGAN: MLD03X03X05LO



F	H	P	L	\$
5 3/8"	3 7/8"	3 3/4"	94 1/2"	\$34.43

RICHMOND: MLD04X03X05RI



F	H	P	L	\$
5 3/8"	4 1/8"	3 3/4"	94 1/2"	\$36.80

VALERIANO: MLD04X03X05VA



F	H	P	L	\$
5 3/8"	4"	3 3/4"	94 1/2"	\$41.55

WINSTON: MLD04X03X05WN



F	H	P	L	\$
5 3/8"	4"	3 5/8"	94 1/2"	\$36.80

MEDWAY: MLD04X04X05ME



F	H	P	L	\$
5 3/8"	3 7/8"	3 3/4"	94 1/2"	\$33.24

STRASBOURG: MLD04X04X05SG



F	H	P	L	\$
5 3/8"	3 3/4"	3 7/8"	94 1/2"	\$39.18

FACE
HEIGHT
PROJECTION



CROWNMOULDING

EDWARDS: MLD05X03X05ED



F	H	P	L	\$
5 3/8"	4 3/4"	3 1/8"	94 1/2"	\$37.99

EGG AND DART: MLD04X04X05EG



F	H	P	L	\$
5 3/8"	3 3/4"	4"	94 1/2"	\$40.36

NADIA: MLD05X03X05NA



F	H	P	L	\$
5 3/8"	4 3/4"	2 3/4"	94 1/2"	\$39.18

KENT: MLD04X04X05KE



F	H	P	L	\$
5 3/8"	4"	3 1/2"	94 1/2"	\$33.24

VICEROY: MLD04X03X05VI



F	H	P	L	\$
5 3/8"	4 1/2"	3"	94 1/2"	\$35.62

ATTICA: MLD03X03X05AT



F	H	P	L	\$
5 3/8"	3 7/8"	3 5/8"	94 1/2"	\$34.43

CORNERS
PAGE 44

SEQUENTIAL: MLD04X04X05SE



F	H	P	L	\$
5 1/4"	3 7/8"	3 1/2"	94 1/2"	\$41.55

DENTIL: MLD05X04X05DE



F	H	P	L	\$
5 1/4"	4 3/8"	3 1/8"	94 1/2"	\$36.80

HEATON: MLD04X03X05HE



F	H	P	L	\$
5 1/4"	4 3/8"	2 7/8"	94 1/2"	\$43.93

BAROQUE: MLD04X04X05BQ



F	H	P	L	\$
5 1/4"	3 3/4"	3 3/4"	94 1/2"	\$40.36

**PAIR
CROWN MOULDING
WITH MATCHING
PANEL MOULDING
TO ADD
GREAT VALUE**

PRO
TIP

ANISE: MLD05X02X05AN



F	H	P	L	\$
5 1/4"	4 3/4"	2 3/8"	94 1/2"	\$36.80

DECO: MLD05X02X05DC



F	H	P	L	\$
5 1/4"	4 3/4"	2 3/8"	94 1/2"	\$35.62

EGG AND DART: MLD04X02X05EG



F	H	P	L	\$
5 1/4"	4 3/4"	2 3/8"	94 1/2"	\$39.18

ERIS: MLD04X04X05ER



F	H	P	L	\$
5 1/4"	4 1/4"	4 1/8"	94 1/2"	\$32.05

LISBON: MLD03X03X05LI



F	H	P	L	\$
5 1/4"	3 1/2"	3 7/8"	94 1/2"	\$30.87

STRASBOURG: MLD03X03X05SG



F	H	P	L	\$
5 1/4"	3 5/8"	3 5/8"	94 1/2"	\$30.87

LONDON: MLD03X03X05LD



F	H	P	L	\$
5 1/8"	3 1/2"	3 5/8"	94 1/2"	\$33.24



CLEMENTINE: MLD04X03X05CM



F	H	P	L	\$
5 1/8"	4 1/8"	3 3/4"	94 1/2"	\$36.80

LESLIE: MLD04X03X05LS



F	H	P	L	\$
5 1/8"	4"	3 1/4"	94 1/2"	\$34.43

SWINDON: MLD04X03X05SW



F	H	P	L	\$
5 1/8"	4 3/8"	3"	94 1/2"	\$32.05

HURLEY: MLD03X03X05HU



F	H	P	L	\$
5 1/8"	3 3/4"	3 1/4"	94 1/2"	\$33.24

WASHINGTON: MLD03X03X05WA



F	H	P	L	\$
5 1/8"	3 5/8"	3 5/8"	94 1/2"	\$29.68

NADIA: MLD03X04X05NA



F	H	P	L	\$
5 1/8"	3"	4"	94 1/2"	\$36.80

EMERY: MLD04X03X05EM



F	H	P	L	\$
5 1/8"	4 1/2"	2 5/8"	94 1/2"	\$39.05

BULWARK: MLD04X04X05BU



F	H	P	L	\$
5 1/8"	3 1/2"	3 7/8"	94 1/2"	\$37.99

VERSAILLES: MLD04X02X05VE



F	H	P	L	\$
5 1/8"	4 1/2"	2 3/8"	94 1/2"	\$30.87

CRISP DETAIL



GRANADA: MLD04X03X05GR



F	H	P	L	\$
5 1/8"	3 3/4"	3 1/2"	94 1/2"	\$32.05

DELFINA: MLD05X03X05DL



F	H	P	L	\$
5"	5"	3"	94 1/2"	\$37.99

LEGACY: MLD03X04X05LE



F	H	P	L	\$
5"	3 1/8"	3 5/8"	94 1/2"	\$29.68

SCOTT: MLD04X03X05SC



F	H	P	L	\$
5"	4 1/4"	2 3/4"	94 1/2"	\$37.99

LINUS: MLD04X04X05LI



F	H	P	L	\$
5"	3 3/8"	3 3/8"	94 1/2"	\$30.87

BRIGHTTON: MLD03X03X05BR



F	H	P	L	\$
5"	3 1/2"	3 1/2"	94 1/2"	\$37.99

ROSE: MLD03X03X05RO



F	H	P	L	\$
5"	3 1/2"	3 1/2"	94 1/2"	\$33.24

NOUVEAU: MLD03X03X05NO



F	H	P	L	\$
5"	3 1/2"	3 1/2"	94 1/2"	\$34.43

EDWARDS: MLD04X02X05ED



F	H	P	L	\$
5"	4"	2 7/8"	94 1/2"	\$33.24

FACE
HEIGHT
PROJECTION



CROWNMOULDING

JACKSON: MLD04X03X05JA



F	H	P	L	\$
5"	3 5/8"	3 1/4"	94 1/2"	\$30.87

ASHFORD: MLD03X03X06AS



F	H	P	L	\$
5"	3 1/8"	3 1/8"	94 1/2"	\$35.62

SUSSEX: MLD03X03X05SU



F	H	P	L	\$
5"	3 1/2"	3 1/2"	94 1/2"	\$33.24

★ **TRADITIONAL:** MLD04X03X05TR



F	H	P	L	\$
5"	4"	3"	94 1/2"	\$28.49

NEXUS: MLD04X03X05NE



F	H	P	L	\$
5"	4"	3"	94 1/2"	\$29.68

MELCHOR: MLD04X02X05ML



F	H	P	L	\$
5"	4 3/8"	2 3/8"	94 1/2"	\$29.68

TELMA: MLD04X02X05TE



F	H	P	L	\$
5"	4 1/2"	2"	94 1/2"	\$33.24

BULWARK: MLD03X03X05BU



F	H	P	L	\$
5"	3 1/4"	3 3/4"	94 1/2"	\$29.68

STOCKPORT: MLD03X03X05ST



F	H	P	L	\$
5"	3 5/8"	3 3/8"	94 1/2"	\$29.68

THEIA: MLD03X03X05TH



F	H	P	L	\$
5"	3 3/4"	3 3/8"	94 1/2"	\$30.87

CLEMENTINE: MLD03X03X04CM



F	H	P	L	\$
4 7/8"	3 7/8"	3 3/8"	94 1/2"	\$34.43

COLTON: MLD03X04X04CO



F	H	P	L	\$
4 7/8"	3 1/4"	3 1/2"	94 1/2"	\$32.05

ASHFORD: MLD03X03X04AS



F	H	P	L	\$
4 7/8"	3 5/8"	3 1/8"	94 1/2"	\$34.43

DAUPHINE: MLD03X03X04DH



F	H	P	L	\$
4 7/8"	3 1/2"	3 3/8"	94 1/2"	\$32.05

LUNEL: MLD03X03X04LU



F	H	P	L	\$
4 7/8"	3 1/2"	3 3/8"	94 1/2"	\$33.24

VERSAILLES: MLD03X03X04VE



F	H	P	L	\$
4 7/8"	3 3/8"	3 1/2"	94 1/2"	\$33.24

VERSAILLES: MLD04X03X05VE



F	H	P	L	\$
4 7/8"	4 1/4"	2 1/2"	94 1/2"	\$39.18

LISBON: MLD03X04X05LI



F	H	P	L	\$
4 7/8"	3 3/8"	3 1/2"	94 1/2"	\$34.43

ROBIN: MLD04X02X04RB



F	H	P	L	\$
4 7/8"	4 1/8"	2 3/8"	94 1/2"	\$39.18

HOLMDEL: MLD03X03X04HO



F	H	P	L	\$
4 7/8"	3 1/2"	3 3/8"	94 1/2"	\$28.49

NEVIO: MLD04X02X04NE



F	H	P	L	\$
4 3/4"	4"	2 1/4"	94 1/2"	\$27.31

VERSAILLES: MLD03X03X05VE



F	H	P	L	\$
4 3/4"	3 3/8"	3 3/8"	94 1/2"	\$34.43

AUGUSTA: MLD03X02X04AG



F	H	P	L	\$
4 3/4"	3 7/8"	2 3/4"	94 1/2"	\$37.99

COVE DENTIL: MLD04X04X04DE



F	H	P	L	\$
4 3/4"	3 1/2"	3 1/2"	94 1/2"	\$39.18

EGG AND DART: MLD03X03X04EG



F	H	P	L	\$
4 3/4"	3 1/2"	3 1/4"	94 1/2"	\$28.49

FLEUR-DE-LIS: MLD03X03X05FL



F	H	P	L	\$
4 3/4"	3 1/4"	3 1/4"	94 1/2"	\$32.05

CORNELIA: MLD03X03X04CN



F	H	P	L	\$
4 3/4"	3 1/2"	3 3/8"	94 1/2"	\$30.87

TRADITIONAL: MLD03X03X04TR



F	H	P	L	\$
4 3/4"	3 3/8"	3 1/2"	94 1/2"	\$27.31

QUEENSTOWN: MLD03X03X04QU



CORNERS
PAGE 44

F	H	P	L	\$
4 3/4"	3 1/2"	3 1/8"	94 1/2"	\$26.12

DEVON: MLD03X03X04DE



CORNERS
PAGE 44

F	H	P	L	\$
4 3/4"	3 3/8"	3 3/8"	94 1/2"	\$27.31

LEGACY: MLD03X03X04LE



CORNERS
PAGE 44

F	H	P	L	\$
4 3/4"	3 1/8"	3 1/2"	94 1/2"	\$28.49

FOSTER: MLD04X04X05FO



F	H	P	L	\$
4 5/8"	3 3/8"	3 3/8"	94 1/2"	\$32.05

EGG AND DART: MLD03X04X05EG



F	H	P	L	\$
4 5/8"	3 1/4"	3 1/4"	94 1/2"	\$30.87

CAPUTO: MLD03X02X04CA



F	H	P	L	\$
4 5/8"	3 7/8"	2 3/8"	94 1/2"	\$34.43

CLASSIC: MLD04X02X05CL

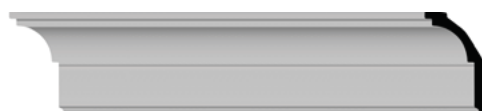

F	H	P	L	\$
4 5/8"	3 5/8"	2 1/2"	94 1/2"	\$36.80

JACKSON: MLD04X02X05JA



F	H	P	L	\$
4 5/8"	4 1/8"	2 1/4"	94 1/2"	\$32.05

FLEUR-DE-LIS: MLD03X03X04FL



F	H	P	L	\$
4 5/8"	3 1/4"	3 1/2"	94 1/2"	\$30.87

PEARL: MLD03X03X05PE



F	H	P	L	\$
4 5/8"	3 1/4"	3 1/8"	94 1/2"	\$32.05

BEADED ROPE: MLD03X03X04BD



F	H	P	L	\$
4 5/8"	3 1/4"	3 3/8"	94 1/2"	\$36.68

CHAMBERLAIN: MLD03X03X04CE



F	H	P	L	\$
4 5/8"	3 1/4"	3 3/8"	94 3/8"	\$29.68

FEDERAL: MLD03X03X04FE



F	H	P	L	\$
4 5/8"	3"	3 5/8"	94 1/2"	\$33.11

VICEROY: MLD04X02X05VI



F	H	P	L	\$
4 5/8"	4"	2 1/2"	94 1/2"	\$32.05

FACE
HEIGHT
PROJECTION



CROWNMOULDING

VICEROY: MLD03X03X04VI



F	H	P	L	\$
4 5/8"	3 1/2"	3 1/8"	94 1/2"	\$26.12



EDINBURGH: MLD04X03X05ED



F	H	P	L	\$
4 5/8"	4"	2 3/8"	94 1/2"	\$27.31

WAKEFIELD: MLD03X03X04WA



F	H	P	L	\$
4 1/2"	3 1/2"	2 3/4"	94 1/2"	\$32.05

BUTTERFLY: MLD03X03X05BT



F	H	P	L	\$
4 1/2"	3 1/8"	3 1/8"	94 1/2"	\$30.87

VICEROY: MLD04X02X04VI



F	H	P	L	\$
4 1/2"	4"	2 1/4"	94 1/2"	\$32.05

HARVEST: MLD03X03X04HA



F	H	P	L	\$
4 1/2"	3 1/4"	3 1/4"	94 1/2"	\$30.87

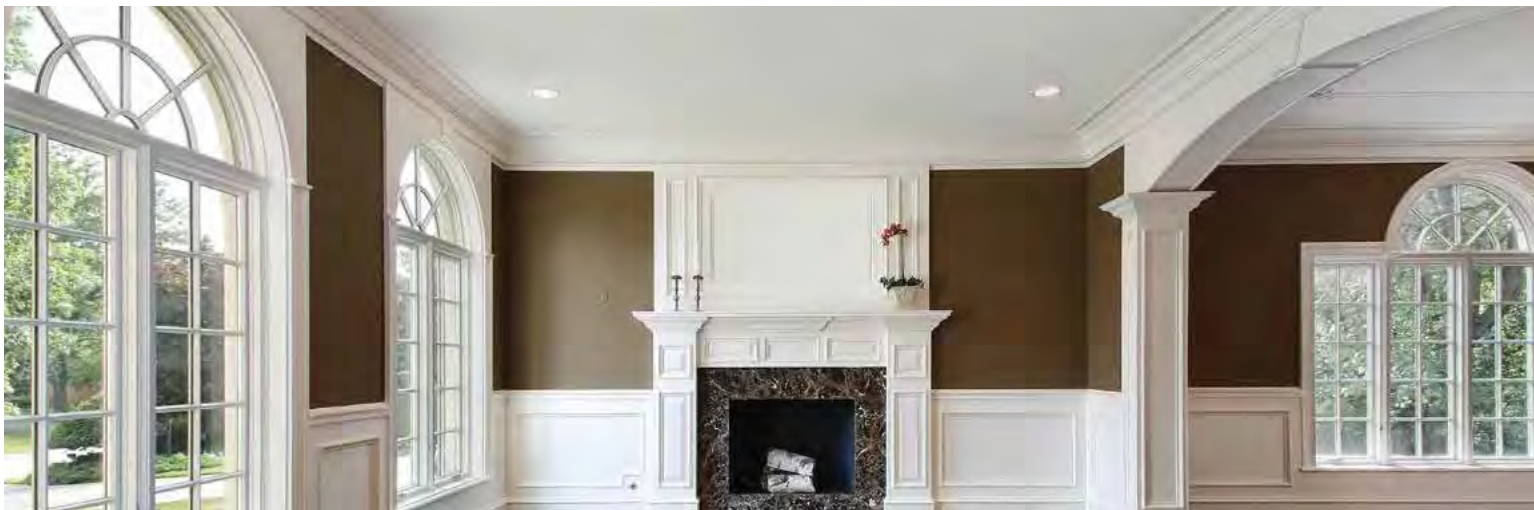

AMELIA: MLD04X02X04AM



F	H	P	L	\$
4 1/2"	3 7/8"	2 1/8"	94 1/2"	\$35.62

VALERIANO: MLD02X03X04VA



F	H	P	L	\$
4 1/2"	2 3/4"	3"	94 1/2"	\$29.68

MEDWAY: MLD03X03X04ME



F	H	P	L	\$
4 1/2"	3"	3 3/8"	94 1/2"	\$29.68

SOUTHAMPTON: MLD03X03X04SO



F	H	P	L	\$
4 1/2"	3 1/8"	3 1/8"	94 1/2"	\$33.24

SEQUENTIAL: MLD04X02X04SQ



F	H	P	L	\$
4 1/2"	2 1/8"	4"	94 1/2"	\$36.42

ADONIS: MLD01X04X04AD



F	H	P	L	\$
4 1/2"	1 3/4"	4"	94 1/2"	\$26.12

SALEM: MLD03X03X04SA



F	H	P	L	\$
4 1/2"	3 1/4"	3 1/4"	94 1/2"	\$24.93

HOLMDEL: MLD04X02X04HO



F	H	P	L	\$
4 1/2"	4"	2 1/4"	94 1/2"	\$26.12

HAMPSHIRE: MLD03X02X04HA



F	H	P	L	\$
4 1/2"	3 7/8"	2 1/8"	94 1/2"	\$29.68

BOTH INTERIOR & EXTERIOR GRADE

READ: MLD03X03X04RE



F	H	P	L	\$
4 1/2"	3 1/8"	3 1/8"	94 1/2"	\$28.49

LEAF: MLD03X02X04LT



F	H	P	L	\$
4 3/8"	3 1/4"	2 7/8"	94 1/2"	\$29.68

GRAPE: MLD03X03X04GR



F	H	P	L	\$
4 3/8"	3 1/8"	3 1/8"	94 1/2"	\$32.05

DENTIL: MLD03X03X05DE



F	H	P	L	\$
4 3/8"	3 1/4"	3 1/4"	94 1/2"	\$32.05

EGG AND DART: MLD03X02X04TR



F	H	P	L	\$
4 3/8"	3 1/4"	2 3/4"	94 1/2"	\$30.87

COLTON: MLD03X03X04CO



F	H	P	L	\$
4 3/8"	3 1/4"	3 1/8"	94 1/2"	\$32.05

BEDFORD: MLD03X03X04BE



F	H	P	L	\$
4 3/8"	3"	3 1/2"	94 1/2"	\$24.93

ALEXANDRIA: MLD03X02X04AL



F	H	P	L	\$
4 3/8"	3 7/8"	2 1/8"	94 1/2"	\$27.31

ROSE: MLD03X03X04RO



F	H	P	L	\$
4 3/8"	3 1/8"	3 1/8"	94 1/2"	\$27.31

FLORAL: MLD02X03X04FL



F	H	P	L	\$
4 1/4"	2 3/4"	3 1/4"	94 1/2"	\$30.87

CARRILLO: MLD03X03X04CI



F	H	P	L	\$
4 1/4"	3"	3"	94 1/2"	\$29.68

RACHELLE: MLD03X03X04RH



F	H	P	L	\$
4 1/4"	3"	3"	94 1/2"	\$23.74

BEADED: MLD03X03X04FO



F	H	P	L	\$
4 1/4"	3 1/8"	3 1/8"	94 1/2"	\$41.04

JACKSON: MLD03X03X04JA



F	H	P	L	\$
4 1/4"	3"	3"	94 1/2"	\$30.87

HEATON: MLD04X02X04HE



F	H	P	L	\$
4 1/4"	3 5/8"	2 1/4"	94 1/2"	\$32.05

ROBERTS: MLD03X02X04RO



F	H	P	L	\$
4 1/4"	3 1/4"	2 7/8"	94 1/2"	\$27.31

KENDALL: MLD03X03X04KD



F	H	P	L	\$
4 1/4"	3 1/8"	2 7/8"	94 1/2"	\$27.31

DENTIL: MLD03X03X04DT



F	H	P	L	\$
4 1/4"	3"	3"	94 1/2"	\$34.43

PALMETTO: MLD03X03X04PA



F	H	P	L	\$
4 1/4"	3"	3"	94 1/2"	\$23.15

CORNERS
PAGE 45



ERIS: MLD03X02X04ER



F	H	P	L	\$
4 1/4"	3 1/2"	2 1/4"	94 1/2"	\$23.74

★ **CRENDON:** MLD02X02X04CR



CORNERS
PAGE 45

F	H	P	L	\$
4 1/4"	3"	3"	94 1/2"	\$22.56

EGG AND DART: MLD02X03X04EG



CORNERS
PAGE 45

F	H	P	L	\$
4 1/4"	2 3/4"	3 1/8"	94 1/2"	\$26.12

NEXUS: MLD02X03X04NE



F	H	P	L	\$
4 1/4"	2 3/4"	3 1/8"	94 1/2"	\$24.93

PALMETTO: MLD02X02X04PM



F	H	P	L	\$
4 1/8"	2 7/8"	2 7/8"	94 1/2"	\$27.31

SOFIA: MLD03X02X04SO



F	H	P	L	\$
4 1/8"	3 1/8"	2 3/4"	94 1/2"	\$30.87

BRADLEY: MLD03X03X04BY



F	H	P	L	\$
4 1/8"	3"	3"	94 1/2"	\$27.31

EGG AND DART: MLD03X02X04EG



F	H	P	L	\$
4 1/8"	3"	2 3/4"	94 1/2"	\$28.49

DAUPHINE: MLD03X02X04DA



F	H	P	L	\$
4 1/8"	3 1/4"	2 1/2"	94 1/2"	\$24.93

GORLEEN: MLD03X02X04GO



CORNERS
PAGE 45

F	H	P	L	\$
4 1/8"	3 1/8"	2 3/4"	94 1/2"	\$21.37

LANARKSHIRE: MLD03X02X04LA



F	H	P	L	\$
4 1/8"	3"	2 7/8"	94 1/2"	\$22.56

FLORAL: MLD04X02X04FL



F	H	P	L	\$
4 1/8"	3"	2 3/4"	94 1/2"	\$22.56

CAPUTO: MLD03X03X04CA



F	H	P	L	\$
4"	2 7/8"	2 3/4"	94 1/2"	\$30.87

DENTIL: MLD02X02X04DE



F	H	P	L	\$
4"	3"	2 3/4"	94 1/2"	\$28.49

MELONIE: MLD02X02X04ML



F	H	P	L	\$
4"	2 3/4"	2 3/4"	94 1/2"	\$24.93

VALERIANO: MLD03X03X04VA



F	H	P	L	\$
4"	2 3/4"	2 3/4"	94 1/2"	\$23.74

BULWARK: MLD03X02X04BU



F	H	P	L	\$
4"	3 1/4"	2 3/8"	94 1/2"	\$26.12

VALERIANO: MLD03X02X04VA



F	H	P	L	\$
4"	3"	2 1/2"	94 1/2"	\$23.74

SEQUENTIAL: MLD03X01X04SQ



F	H	P	L	\$
4"	3 1/2"	1 7/8"	94 1/2"	\$22.56

★ **MEDWAY:** MLD03X02X04ME



F	H	P	L	\$
4"	3 3/8"	2 1/8"	94 1/2"	\$40.36

SHELL: MLD02X02X02SH



CORNERS
PAGE 45

F	H	P	L	\$
4"	2 7/8"	2 3/4"	94 1/2"	\$21.37

EGG AND DART: MLD02X02X04EG



F	H	P	L	\$
4"	2 1/4"	2 1/2"	94 1/2"	\$27.31

QUENTIN: MLD02X02X04QU



F	H	P	L	\$
4"	3"	3"	94 1/2"	\$24.93

TRISTAN: MLD02X02X04TN



CORNERS
PAGE 45

F	H	P	L	\$
4"	2 3/4"	2 3/4"	94 1/2"	\$24.93

ASHUR: MLD02X02X03AS



F	H	P	L	\$
3 7/8"	2 3/4"	2 5/8"	94 1/2"	\$26.12

CAPUTO: MLD02X02X03CA



F	H	P	L	\$
3 7/8"	2 3/4"	2 5/8"	94 1/2"	\$26.12

DYLAN: MLD02X03X03DY



F	H	P	L	\$
3 7/8"	2 5/8"	3 1/8"	94 1/2"	\$26.12

CHAFFIN: MLD03X01X03CF



F	H	P	L	\$
3 7/8"	3 5/8"	1 5/8"	94 1/2"	\$26.12

IRWIN: MLD03X02X03IR



F	H	P	L	\$
3 7/8"	3 1/8"	2 3/8"	94 1/2"	\$26.12

ALEXANDRIA: MLD03X01X03AL



F	H	P	L	\$
3 7/8"	3 3/4"	1 7/8"	94 1/2"	\$23.74

TELMA: MLD03X02X04TE



F	H	P	L	\$
3 7/8"	2 7/8"	2 1/2"	94 1/2"	\$28.49

CLASSIC: MLD03X03X04CL



F	H	P	L	\$
3 7/8"	2 7/8"	2 3/4"	94 1/2"	\$29.68

QUENTIN: MLD02X02X03QU



F	H	P	L	\$
3 7/8"	2 1/2"	2 7/8"	94 1/2"	\$24.93

GRAPE: MLD03X03X04GV



F	H	P	L	\$
3 7/8"	2 3/4"	2 3/4"	94 1/2"	\$27.31

LOERA: MLD03X03X04LO



F	H	P	L	\$
3 7/8"	2 7/8"	2 7/8"	94 1/2"	\$29.68

ORION: MLD02X02X03OR



F	H	P	L	\$
3 7/8"	2 3/4"	2 3/4"	94 1/2"	\$22.56

DUBLIN: MLD02X02X03DU



CORNERS
PAGE 45

F	H	P	L	\$
3 7/8"	2 3/4"	2 3/4"	94 1/2"	\$22.56

HEATON: MLD03X02X03HE



F	H	P	L	\$
3 7/8"	3 1/8"	2 3/4"	94 1/2"	\$22.56

DENTIL: MLD02X02X03DE



CORNERS
PAGE 45

F	H	P	L	\$
3 7/8"	2 3/4"	2 3/4"	94 1/2"	\$20.18

DENTIL: MLD03X02X04DE



F	H	P	L	\$
3 3/4"	2 7/8"	2 5/8"	94 1/2"	\$28.49

MILLER: MLD02X02X03MI



F	H	P	L	\$
3 3/4"	2 1/2"	2 7/8"	94 1/2"	\$23.74

EMPIRE: MLD02X03X04EM



F	H	P	L	\$
3 3/4"	2 3/8"	3 1/8"	94 1/2"	\$28.49

FACE
HEIGHT
PROJECTION



CROWNMOULDING

ARTIS: MLD02X02X01AR



F	H	P	L	\$
3 3/4"	2 3/4"	2 1/2"	94 1/2"	\$21.37

SMOOTH: MLD02X02X03AT



F	H	P	L	\$
3 3/4"	2 1/2"	2 1/8"	94 1/2"	\$21.37

FLORAL: MLD03X02X03FL



F	H	P	L	\$
3 3/4"	3 1/8"	2 1/8"	94 1/2"	\$22.56

BARCELONA: MLD02X02X03BA



F	H	P	L	\$
3 3/4"	2 3/4"	2 1/2"	94 1/2"	\$26.12

SEQUENTIAL: MLD02X02X03SQ



F	H	P	L	\$
3 3/4"	2 5/8"	2 3/4"	94 1/2"	\$22.56

CORNERS
PAGE 45

SEQUENTIAL: MLD03X02X04SE



F	H	P	L	\$
3 5/8"	2 3/4"	2 3/8"	94 1/2"	\$27.31

TIRANA: MLD03X03X04TI



F	H	P	L	\$
3 5/8"	2 5/8"	2 5/8"	94 1/2"	\$26.12

BUTTERFLY: MLD02X02X03BT



F	H	P	L	\$
3 5/8"	2 1/2"	2 1/2"	94 1/2"	\$26.12

FRANKLIN: MLD03X01X03FN



F	H	P	L	\$
3 5/8"	3 1/2"	1 1/8"	94 1/2"	\$27.31

**ADD VALUE
BY BUILDING
COFFERED CEILINGS
USING OUR
CROWN MOULDING**



BONETTI: MLD02X02X03BO



F	H	P	L	\$
3 5/8"	2 1/2"	2 1/2"	94 1/2"	\$27.31

TRISTAN: MLD02X02X03TN



F	H	P	L	\$
3 5/8"	2 3/4"	2 1/2"	94 1/2"	\$24.80

WHITMAN: MLD02X02X04WH



F	H	P	L	\$
3 5/8"	2 1/2"	2 1/2"	94 1/2"	\$29.68

FOSTER: MLD03X02X04FO



F	H	P	L	\$
3 5/8"	2 7/8"	2 1/4"	94 1/2"	\$24.93

MARSEILLE: MLD03X02X04MA



F	H	P	L	\$
3 5/8"	2 5/8"	2 3/8"	94 1/2"	\$26.12

DENTIL: MLD03X02X03DE



F	H	P	L	\$
3 5/8"	3"	2"	94 1/2"	\$21.37

FEDERAL: MLD02X02X03FE



F	H	P	L	\$
3 5/8"	2 3/8"	2 7/8"	94 1/2"	\$27.18

TRADITIONAL: MLD02X02X03TR



F	H	P	L	\$
3 5/8"	2 3/8"	2 5/8"	94 1/2"	\$21.37

CORNERS
PAGE 46



TRADITIONAL: MLD03X02X03TR



F	H	P	L	\$
3 5/8"	3"	2"	94 1/2"	\$21.37

LISBON: MLD03X02X03LI



F	H	P	L	\$
3 5/8"	3"	2"	94 1/2"	\$21.37

BRIGHTTON: MLD03X01X03BR



F	H	P	L	\$
3 5/8"	3 1/8"	1 7/8"	94 1/2"	\$23.74

LOERA: MLD03X02X04LO



F	H	P	L	\$
3 1/2"	3 1/8"	1 5/8"	94 1/2"	\$23.74

SUSSEX: MLD03X01X05SU



F	H	P	L	\$
3 1/2"	3 1/4"	1 3/8"	94 1/2"	\$23.74

ASA: MLD02X01X03AS



F	H	P	L	\$
3 1/2"	2 7/8"	1 7/8"	94 1/2"	\$23.74

RAYNOR: MLD03X01X03BE



F	H	P	L	\$
3 1/2"	3 1/8"	1 1/2"	94 1/2"	\$21.37

ORION: MLD03X03X03OR



F	H	P	L	\$
3 1/2"	2 1/2"	2 1/2"	94 1/2"	\$21.37

HELENE: MLD02X02X04HE

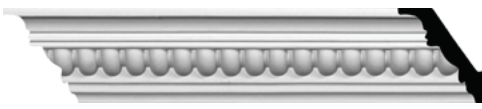

F	H	P	L	\$
3 3/8"	2 3/8"	2 3/8"	94 1/2"	\$21.96

LOERA: MLD02X02X03LO



F	H	P	L	\$
3 3/8"	2 1/2"	2 3/8"	94 3/8"	\$23.74

CLASSIC: MLD02X02X04CL



F	H	P	L	\$
3 3/8"	2 3/8"	2 3/8"	94 1/2"	\$20.18

EGG AND DART: MLD03X01X03EG



F	H	P	L	\$
3 3/8"	3"	1 1/2"	94 1/2"	\$21.37

VERSAILLES: MLD02X02X03VE



F	H	P	L	\$
3 3/8"	2 3/8"	2 3/8"	94 1/2"	\$23.74

TIRANA: MLD02X02X03TI



F	H	P	L	\$
3 1/4"	2 3/8"	2 3/8"	94 1/2"	\$22.56

EDINBURGH: MLD02X02X03ED



F	H	P	L	\$
3 1/4"	2 1/4"	2 3/8"	94 1/2"	\$22.56

NADIA: MLD02X02X03NA



F	H	P	L	\$
3 1/4"	2 3/8"	2 3/8"	94 1/2"	\$19.00

NEED A
DIFFERENT
MATERIAL?

WOOD CROWN
MOULDING
CALL FOR DETAILS

FACE
HEIGHT
PROJECTION



CROWNMOULDING

DENTIL: MLD03X01X03DE



F	H	P	L	\$
3 1/4"	2 3/4"	1 7/8"	94 1/2"	\$26.12

DAMON: MLD02X01X02DA



F	H	P	L	\$
2 7/8"	2 1/8"	1 7/8"	94 1/2"	\$19.00

ROBIN: MLD02X02X03RO



F	H	P	L	\$
2 7/8"	2 3/8"	1 5/8"	94 1/2"	\$20.78

★ **JEFFERSON:** MLD02X02X03JE



CORNERS
PAGE 46

F	H	P	L	\$
3 1/4"	2 1/4"	2 1/4"	94 1/2"	\$19.00

DENTIL: MLD02X01X03DE



F	H	P	L	\$
3 1/4"	2 7/8"	1 1/2"	94 1/2"	\$20.18

LOERA: MLD02X01X03LO



F	H	P	L	\$
3 1/8"	2 3/4"	1 5/8"	94 1/2"	\$20.18

MEDEA: MLD02X02X03MD



F	H	P	L	\$
3 1/8"	2 1/4"	2 1/4"	94 1/2"	\$19.00

★ **CLASSIC:** MLD02X01X03CL



F	H	P	L	\$
3 1/8"	2 1/4"	2 1/4"	94 1/2"	\$20.78

PIEDMONT: MLD02X01X03PI



F	H	P	L	\$
3 1/8"	2 3/4"	1 1/2"	94 1/2"	\$19.00

BLACKTHORNE: MLD02X02X03BL



F	H	P	L	\$
3 1/8"	2 1/4"	2"	94 1/2"	\$19.00

NEXUS: MLD02X02X03NE



F	H	P	L	\$
3 1/8"	2 3/4"	1 1/2"	94 1/2"	\$19.59

LEANDROS: MLD02X02X06LN



CORNERS
PAGE 46

F	H	P	L	\$
3 1/8"	2"	2 1/4"	94 1/2"	\$19.00

ERIS: MLD01X01X03ER



F	H	P	L	\$
3"	2 1/8"	2 1/8"	94 1/2"	\$21.37

LOERA: MLD03X02X03LO



F	H	P	L	\$
3"	2 1/2"	2 1/8"	94 1/2"	\$21.96

LYON: MLD02X02X03LY



CORNERS
PAGE 46

F	H	P	L	\$
3"	2"	2"	94 1/2"	\$17.81

EDWARDS: MLD03X02X03ED



F	H	P	L	\$
3"	2 5/8"	1 5/8"	94 1/2"	\$20.18

ERIS: MLD02X02X03ER



F	H	P	L	\$
3"	2 1/4"	2 1/4"	94 1/2"	\$17.81

HILLSBOROUGH: MLD02X02X02HI



F	H	P	L	\$
2 7/8"	2"	2"	94 1/2"	\$20.18

LEGACY: MLD02X01X03LE



F	H	P	L	\$
3"	2 1/2"	1 5/8"	94 1/2"	\$19.00

EGG AND DART: MLD02X02X03EG



CORNERS
PAGE 46

F	H	P	L	\$
3"	2 1/8"	2 1/8"	94 1/2"	\$19.00

DENTIL: MLD02X02X02DE



F	H	P	L	\$
2 7/8"	2"	2"	94 1/2"	\$21.37

HAMPSHIRE: MLD02X02X03HA



F	H	P	L	\$
2 7/8"	2"	2"	94 1/2"	\$22.56

LEAF: MLD02X01X02AS



F	H	P	L	\$
2 7/8"	2 5/8"	1 1/4"	94 1/2"	\$16.62

VALERIANO: MLD02X02X03VA



F	H	P	L	\$
2 3/4"	2"	2"	94 1/2"	\$19.00

WHITMAN: MLD02X02X03WH



F	H	P	L	\$
2 3/4"	2"	2"	94 1/2"	\$24.93

CLASSIC: MLD01X01X02CL



F	H	P	L	\$
2 3/4"	1 7/8"	1 7/8"	94 1/2"	\$23.15

REECE: MLD02X01X02RE



F	H	P	L	\$
2 3/4"	2"	1 7/8"	94 1/2"	\$17.81

GIANA: MLD02X02X02GI



F	H	P	L	\$
2 3/4"	2"	2"	94 1/2"	\$17.81

KENT: MLD02X02X02KE



F	H	P	L	\$
2 3/4"	2"	2"	94 1/2"	\$17.81



MARSEILLE: MLD02X02X02MA



F	H	P	L	\$
2 3/4"	2"	2"	94 1/2"	\$17.81

★ **MIDDLESBOROUGH:** MLD02X02X02MD



F	H	P	L	\$
2 3/4"	2"	2"	94 1/2"	\$17.81

EDINBURGH: MLD01X02X02ED



F	H	P	L	\$
2 3/4"	2"	2"	94 1/2"	\$17.81

TRADITIONAL: MLD01X01X02TR



F	H	P	L	\$
2 5/8"	1 3/4"	1 3/4"	94 1/2"	\$15.43

VALERIANO: MLD02X01X02VA



CORNERS
PAGE 46

F	H	P	L	\$
2 5/8"	2 1/8"	1 5/8"	94 1/2"	\$17.81

EDINBURGH: MLD01X01X02ED



F	H	P	L	\$
2 1/2"	1 3/4"	1 3/4"	94 1/2"	\$15.43

BEDFORD: MLD01X01X02BE



F	H	P	L	\$
2 1/4"	1 1/2"	1 1/2"	94 1/2"	\$14.84

TYRONE: MLD01X01X02TY



F	H	P	L	\$
2 1/4"	1 1/2"	1 1/2"	94 1/2"	\$14.25

ODESSA: MLD01X01X02OD



CORNERS
PAGE 46

F	H	P	L	\$
2 1/4"	1 5/8"	1 5/8"	94 1/2"	\$14.25

FACE
HEIGHT
PROJECTION



JACKSON: MLD01X01X02JA



F	H	P	L	\$
2 1/4"	1 5/8"	1 5/8"	94 1/2"	\$15.43

EDINBURGH: MLD02X02X02ED

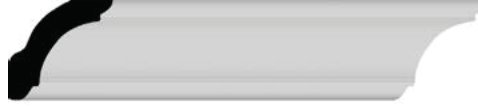

F	H	P	L	\$
2 1/8"	1 1/2"	1 1/2"	94 1/2"	\$13.06

ASHFORD: MLD01X01X02AS



F	H	P	L	\$
2 1/8"	1 1/2"	1 1/2"	94 1/2"	\$14.25

CAPUTO: MLD01X01X02CA



F	H	P	L	\$
2"	1 3/8"	1 3/8"	94 1/2"	\$15.43

EMERY: MLD02X01X02EM



F	H	P	L	\$
2"	1 1/2"	1 3/8"	94 1/2"	\$17.81

ARTIS: MLD01X01X02AR



F	H	P	L	\$
1 7/8"	1 3/8"	1 3/8"	94 1/2"	\$13.06

FACTORY PRIMED

LEANDROS: MLD02X02X02LE



F	H	P	L	\$
1 7/8"	2"	2"	94 1/2"	\$16.62

★ **HILLSBOROUGH:** MLD01X01X01HI



F	H	P	L	\$
1 3/4"	1 1/4"	1 1/4"	94 1/2"	\$12.47

SALEM: MLD01X01X02SA



F	H	P	L	\$
1 5/8"	1 1/4"	1 1/4"	94 1/2"	\$11.87

EDINBURGH: MLD00X01X01ED



F	H	P	L	\$
1 1/2"	3/4"	1"	94 1/2"	\$11.87

TRADITIONAL: MLD01X01X01TR



F	H	P	L	\$
1 1/2"	1 1/8"	1 1/8"	94 1/2"	\$13.06

EDINBURGH: MLD00X00X01ED



F	H	P	L	\$
1 1/4"	3/4"	7/8"	94 1/2"	\$9.50

EDINBURGH: MLD02X02X01ED



F	H	P	L	\$
1 1/8"	1"	1 1/8"	94 1/2"	\$10.68

HILLSBOROUGH: MLD02X01X01HI



F	H	P	L	\$
1"	3/4"	3/4"	94 1/2"	\$11.87

TRADITIONAL: MLD00X00X01TR



F	H	P	L	\$
7/8"	3/4"	3/4"	94 1/2"	\$9.50

EDINBURGH: MLD01X01X01ED



F	H	P	L	\$
7/8"	7/8"	5/8"	94 1/2"	\$11.87

SMOOTH: MLD01X01X01CL



F	H	P	L	\$
3/4"	5/8"	1/2"	94 1/2"	\$11.87



URETHANE CROWN MOULDING SYSTEMS

Perfect for projects that require a large or decorative crown that is difficult to miter, our extensive line of pre-mitered, P molded corners make installation a breeze. With the corner block pattern and profile matching the corresponding crown moulding perfectly, these systems provide an expert-level finished installation look that is sure to impress.

Complete projects in hours instead of days, with seamless hassle-free installation. Your new look is sure to evoke envy and inspire everyone to follow suit.



ANTONIO: MLD04X09X10AN

F **H** **P** **L** **\$**

10 1/4" 4" 9" 94 1/2" \$66.48

MIC04X09AN
Inside Corner
\$ \$21.37

MOC04X09AN
Outside Corner
\$ \$21.37

FOSTER: MLD06X07X09FO

F **H** **P** **L** **\$**

9 3/4" 6 3/4" 7" 94 1/2" \$68.86

MIC07X06FO
Inside Corner
\$ \$19.00

MOC07X06FO
Outside Corner
\$ \$19.00

NIobe: MLD05X07X09NI

F **H** **P** **L** **\$**

9 3/8" 5" 7 1/2" 94 1/2" \$47.49

MIC07X05NI
Inside Corner
\$ \$19.00

MOC07X05NI
Outside Corner
\$ \$19.00

TIRANA: MLD06X05X08TI

F **H** **P** **L** **\$**

8 5/8" 6 7/8" 5 1/8" 94 1/2" \$45.11

MIC05X06TI
Inside Corner
\$ \$21.96

MOC05X06TI
Outside Corner
\$ \$21.96

VERSAILLES: MLD05X06X08VE

F **H** **P** **L** **\$**

8 1/2" 5 5/8" 6 3/8" 94 1/2" \$45.11

MIC05X06VE
Inside Corner
\$ \$15.43

MOC05X06VE
Outside Corner
\$ \$14.25

MONIQUE: MLD05X06X08MO

F **H** **P** **L** **\$**

8 1/4" 5 1/4" 6 1/4" 94 1/2" \$53.42

MIC05X06MO
Inside Corner
\$ \$19.00

MOC05X06MO
Outside Corner
\$ \$17.81

MARIA: MLD03X04X05TR

F **H** **P** **L** **\$**

7 3/4" 6" 4 1/2" 94 1/2" \$44.99

MIC04X03TR
Inside Corner
\$ \$14.84

MOC04X03TR
Outside Corner
\$ \$14.84

★ **ATTICA: MLD05X05X07AT**

F **H** **P** **L** **\$**

7 1/2" 5 1/4" 5 1/4" 94 1/2" \$47.49

MIC05X05AT
Inside Corner
\$ \$14.25

MOC05X05AT
Outside Corner
\$ \$14.25

DIANE: MLD06X04X07DI

F **H** **P** **L** **\$**

7 1/4" 4 1/8" 6 1/8" 94 1/2" \$37.99

MIC06X04DI
Inside Corner
\$ \$13.06

MOC06X04DI
Outside Corner
\$ \$11.87

FELIX: MLD05X05X07FE

F **H** **P** **L** **\$**

7" 5" 5" 94 1/2" \$42.74

MIC05X05FE
Inside Corner
\$ \$11.87

MOC05X05FE
Outside Corner
\$ \$14.25

ROSE: MLD05X02X06RO

F **H** **P** **L** **\$**

6 3/4" 5 1/2" 3 3/4" 94 1/2" \$36.80

MIC02X05RO
Inside Corner
\$ \$16.03

MOC02X05RO
Outside Corner
\$ \$16.03



STRASBOURG: MLD04X04X06SG



F	H	P	L	\$
6 1/2"	4 7/8"	4 3/8"	94 1/2"	\$35.62

MIC04X04SG
Inside Corner
\$11.87

MOC04X04SG
Outside Corner
\$13.06

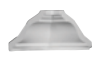

BRADFORD: MLD04X04X06BR



F	H	P	L	\$
6 3/8"	4 1/4"	4 3/4"	94 1/2"	\$42.74

MIC04X04BR
Inside Corner
\$8.31

MOC04X04BR
Outside Corner
\$8.31



EDWARDS: MLD04X05X06ED



F	H	P	L	\$
6 3/8"	4"	5"	94 1/2"	\$36.80

MIC05X04ED
Inside Corner
\$13.06

MOC04X04SG
Outside Corner
\$13.06



DENTIL: MLD04X04X06DE



F	H	P	L	\$
6 3/8"	4 1/2"	4 1/2"	94 1/2"	\$40.36

MIC04X04DE
Inside Corner
\$13.06

MOC04X04DE
Outside Corner
\$13.06



ERIS: MLD04X04X06ER



F	H	P	L	\$
6"	4 1/4"	4 1/4"	94 1/2"	\$43.93

MIC04X04ER
Inside Corner
\$8.90

MOC04X04ER
Outside Corner
\$8.31

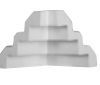

FLORAL: MLD05X02X06FL



F	H	P	L	\$
6"	5 5/8"	2 1/4"	94 1/2"	\$33.24

MIC05X02FL
Inside Corner
\$11.87

MOC05X02FL
Outside Corner
\$11.87



RICHMOND: MLD05X02X06RI



F	H	P	L	\$
6"	5 1/2"	2 1/4"	94 1/2"	\$37.99

MIC05X02RI
Inside Corner
\$11.87

MOC05X02RI
Outside Corner
\$11.87



WAKEFIELD: MLD04X05X06WA



F	H	P	L	\$
6"	4 3/4"	5 1/8"	94 1/2"	\$40.36

MIC04X05WA
Inside Corner
\$13.06

MOC04X05WA
Outside Corner
\$11.87



BULWARK: MLD03X04X05BU



F	H	P	L	\$
5 7/8"	3 7/8"	4 1/2"	94 1/2"	\$37.99

MIC04X03BU
Inside Corner
\$12.47

MOC04X03BU
Outside Corner
\$12.47



DYLAN: MLD03X04X05DY



F	H	P	L	\$
5 5/8"	3 3/4"	4 1/8"	94 1/2"	\$32.05

MIC04X03DY
Inside Corner
\$11.28

MOC04X03DY
Outside Corner
\$11.28



DUBLIN: MLD03X03X05DU



F	H	P	L	\$
5 1/2"	3 7/8"	3 7/8"	94 1/2"	\$29.68

MIC03X03DU
Inside Corner
\$10.09

MOC03X03DU
Outside Corner
\$10.09



FACE
HEIGHT
PROJECTION



CROWNMOULDINGSYSTEMS

DEVON: MLD04X03X05DE

F **H** **P** **L** **\$**

5 1/2" 4 1/2" 3 1/4" 94 1/2" \$33.24

MIC03X04DE
Inside Corner
\$ \$11.87

MOC03X04DE
Outside Corner
\$ \$11.87

ATTICA: MLD03X03X05AT

F **H** **P** **L** **\$**

5 3/8" 3 7/8" 3 5/8" 94 1/2" \$34.43

MIC03X03AT
Inside Corner
\$ \$11.87

MOC03X03AT
Outside Corner
\$ \$11.87

★ **TRADITIONAL: MLD04X03X05TR**

F **H** **P** **L** **\$**

5" 4" 3" 94 1/2" \$28.49

MIC03X04TR
Inside Corner
\$ \$13.06

MOC03X04TR
Outside Corner
\$ \$14.25

BULWARK: MLD03X03X05BU

F **H** **P** **L** **\$**

5" 3 1/4" 3 3/4" 94 1/2" \$29.68

MIC03X03BU
Inside Corner
\$ \$8.90

MOC03X03BU
Outside Corner
\$ \$8.90

MATCHING PATTERN AND PROFILE



STOCKPORT: MLD03X03X05ST

F **H** **P** **L** **\$**

5" 3 5/8" 3 3/8" 94 1/2" \$29.68

MIC03X03ST
Inside Corner
\$ \$10.68

MOC03X03ST
Outside Corner
\$ \$10.68

HOLMDEL: MLD03X03X04HO

F **H** **P** **L** **\$**

4 7/8" 3 1/2" 3 3/8" 94 1/2" \$28.49

MIC03X03HO
Inside Corner
\$ \$10.68

MOC03X03HO
Outside Corner
\$ \$10.68

QUEENSTOWN: MLD03X03X04QU

F **H** **P** **L** **\$**

4 3/4" 3 1/2" 3 1/8" 94 1/2" \$26.12

MIC03X03QU
Inside Corner
\$ \$7.72

MOC03X03QU
Outside Corner
\$ \$7.72

LEGACY: MLD03X03X04LE

F **H** **P** **L** **\$**

4 3/4" 3 1/8" 3 1/2" 94 1/2" \$28.49

MIC03X03LE
Inside Corner
\$ \$10.09

MOC03X03LE
Outside Corner
\$ \$10.09

DEVON: MLD03X03X04DE

F **H** **P** **L** **\$**

4 3/4" 3 3/8" 3 3/8" 94 1/2" \$27.31

MIC03X03DE
Inside Corner
\$ \$8.90

MOC03X03DE
Outside Corner
\$ \$8.90

★ **EDINBURGH: MLD04X03X05ED**

F **H** **P** **L** **\$**

4 5/8" 4" 2 3/8" 94 1/2" \$27.31

MIC03X04ED
Inside Corner
\$ \$8.90

MOC03X04ED
Outside Corner
\$ \$8.90

HOLMDEL: MLD04X02X04HO



MIC04X02HO
Inside Corner
\$8.31

MOC04X02HO
Outside Corner
\$7.72

F H P L \$
4 1/2" 4" 2 1/4" 94 1/2" \$26.12

SALEM: MLD03X03X04SA



MIC03X03SA
Inside Corner
\$8.90

MOC03X03SA
Outside Corner
\$8.90

F H P L \$
4 1/2" 3 1/4" 3 1/4" 94 1/2" \$24.93

★ CRENDON: MLD02X02X04CR



MIC02X02CR
Inside Corner
\$8.31

MOC02X02CR
Outside Corner
\$8.31

F H P L \$
4 1/4" 3" 3" 94 1/2" \$22.56

PALMETTO: MLD03X03X04PA



MIC03X03PA
Inside Corner
\$8.90

MOC03X03PA
Outside Corner
\$8.90

F H P L \$
4 1/4" 3" 3" 94 1/2" \$23.15

EGG AND DART: MLD02X03X04EG



MIC03X02EG
Inside Corner
\$10.39

MOC03X02EG
Outside Corner
\$10.39

F H P L \$
4 1/4" 2 3/4" 3 1/8" 94 1/2" \$26.12

GORLEEN: MLD03X02X04GO



MIC02X03GO
Inside Corner
\$8.31

MOC02X03GO
Outside Corner
\$8.31

F H P L \$
4 1/8" 3 1/8" 2 3/4" 94 1/2" \$21.37

TRISTAN: MLD02X02X04TN



MIC02X02TN
Inside Corner
\$7.72

MOC02X02TN
Outside Corner
\$7.72

F H P L \$
4" 2 3/4" 2 3/4" 94 1/2" \$24.93

SHELL: MLD02X02X02SH



MIC02X02SH
Inside Corner
\$8.90

MOC02X02SH
Outside Corner
\$8.90

F H P L \$
4" 2 7/8" 2 3/4" 94 1/2" \$21.37

DUBLIN: MLD02X02X03DU



MIC02X02DU
Inside Corner
\$7.72

MOC02X02DU
Outside Corner
\$7.72

F H P L \$
3 7/8" 2 3/4" 2 3/4" 94 1/2" \$22.56

DENTIL: MLD02X02X03DE



MIC02X02DE
Inside Corner
\$8.31

MOC02X02DE
Outside Corner
\$8.31

F H P L \$
3 7/8" 2 3/4" 2 3/4" 94 1/2" \$20.18

SEQUENTIAL: MLD02X02X03SQ



MIC02X02SQ
Inside Corner
\$8.31

MOC02X02SQ
Outside Corner
\$8.31

F H P L \$
3 3/4" 2 5/8" 2 3/4" 94 1/2" \$22.56

PERFECT INSTALLATION EVERY TIME



TRADITIONAL: MLD02X02X03TR

F H P L \$

3 5/8" 2 3/8" 2 5/8" 94 1/2" \$21.37

MIC02X02TR
Inside Corner
\$7.72

MOC02X02TR
Outside Corner
\$7.72

RAYNOR: MLD03X01X03BE

F H P L \$

3 1/2" 3 1/8" 1 1/2" 94 1/2" \$21.37

MIC01X03BE
Inside Corner
\$6.53

MOC01X03BE
Outside Corner
\$6.53

★ **JEFFERSON: MLD02X02X03JE**

F H P L \$

3 1/4" 2 1/4" 2 1/4" 94 1/2" \$19.00

MIC02X02JE
Inside Corner
\$7.72

MOC02X02JE
Outside Corner
\$7.72

LEANDROS: MLD02X02X06LN

F H P L \$

3 1/8" 2" 2 1/4" 94 1/2" \$19.00

MIC02X02LN
Inside Corner
\$7.72

MOC02X02LN
Outside Corner
\$7.72

LYON: MLD02X02X03LY

F H P L \$

3" 2" 2" 94 1/2" \$17.81

MIC02X02LY
Inside Corner
\$5.94

MOC02X02LY
Outside Corner
\$5.94

EGG AND DART: MLD02X02X03EG

F H P L \$

3" 2 1/8" 2 1/8" 94 1/2" \$19.00

MIC02X02EG
Inside Corner
\$5.34

MOC02X02EG
Outside Corner
\$5.34

VALERIANO: MLD02X01X02VA

F H P L \$

2 5/8" 2 1/8" 1 5/8" 94 1/2" \$17.81

MIC01X02VA
Inside Corner
\$5.34

MOC01X02VA
Outside Corner
\$5.34

ODESSA: MLD01X01X02OD

F H P L \$

2 1/4" 1 5/8" 1 5/8" 94 1/2" \$14.25

MIC01X01OD
Inside Corner
\$5.94

MOC01X01OD
Outside Corner
\$5.94

DIANE: MLD05X05X08DI

F H P L \$

7 1/2" 5 3/8" 5 1/4" 94 1/2" \$65.30



MIC28X05DI-1
Inside Corner
\$56.60

MIC28X05DI-2
Inside Corner
\$56.60





URETHANE PANEL MOULDING

Overhaul a room and solve boring wall problems, with beautiful panel moulding profiles. Make a big impact for less with high-density urethane that is water-proof, rot and termite resistant, making it extremely durable with minimal upkeep. Great for use over paneling edges or framing out recessed designs on the wall, because it cuts like real wood without splintering or cracking and it does not require any special tools. It's an easy way to add a decorative, historic feel to walls, ceilings, and furniture pieces. The clean, crisp details mimic that of traditional plaster and wood designs, adding charm and interest to any space.

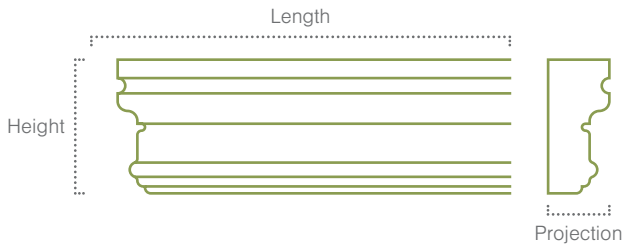

**COORDINATING PROFILES
& CORNERS AVAILABLE**

**PANEL MOULDING
SYSTEMS** PAGE 61

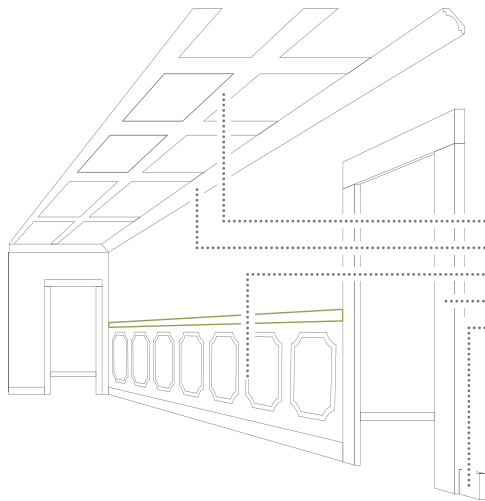

Panel Moulding compliments other features, such as crown moulding, baseboard, door & window trim, wainscot paneling and coffered ceilings!

- Coffered Ceilings
- Crown Moulding
- Wainscot Paneling
- Door & Window Trim
- Baseboard

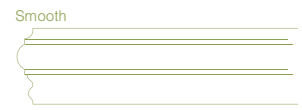

ROMERO: PML01X00RO



H	P	L	\$
1/2"	3/8"	94 1/2"	\$8.31



HOLMDEL: PML03X00HO



H	P	L	\$
1/2"	3/4"	94 1/2"	\$22.56

TRADITIONAL: PML00X00TR



H	P	L	\$
3/4"	3/8"	94"	\$9.50

EMERY: CHA01X00EM



H	P	L	\$
3/4"	3/8"	94 1/2"	\$12.47

STOCKPORT: CHA01X00ST



H	P	L	\$
3/4"	3/8"	94 1/2"	\$12.47

EGG AND DART: PML00X00EG



H	P	L	\$
7/8"	3/8"	94 1/2"	\$8.31

ALEXANDRIA: PML01X00AL



H	P	L	\$
7/8"	3/8"	94 1/2"	\$9.50



ODESSA: PML00X00OD



H	P	L	\$
7/8"	3/8"	94 1/2"	\$9.50



CLASSIC: PML00X00CL



H	P	L	\$
7/8"	1/2"	94 1/2"	\$9.50

BRADFORD: PML01X01BR



H	P	L	\$
7/8"	5/8"	94 1/2"	\$10.68

VALERIANO: MLD01X00VA



H	P	L	\$
1"	1/4"	94 1/2"	\$9.50

MEDWAY: PIR01X00ME



H	P	L	\$
1"	1/2"	94 1/2"	\$22.43

SYDNEY: PML01X01SY



H	P	L	\$
1"	1/2"	94 1/2"	\$8.31



BULWARK: MLD01X00BU



H	P	L	\$
1"	5/8"	94 1/2"	\$10.68

CRENDON: MLD01X00CR



H	P	L	\$
1"	5/8"	94 1/2"	\$9.50

ALEXANDRIA: MLD01X00AL



H	P	L	\$
1"	3/4"	94 1/2"	\$9.50

DENTIL: MLD00X00DE



H	P	L	\$
1"	5/16"	94 1/2"	\$9.50

SWINDON: CHA01X01SW



H	P	L	\$
1 1/8"	3/8"	94 1/2"	\$10.09

KEPLER: PML01X01KP



H	P	L	\$
1 1/8"	1/2"	94 1/2"	\$12.47

STANDARD: PML01X01ST



H	P	L	\$
1 1/8"	5/8"	94 1/2"	\$10.68

CRENDON: PML01X01CR



H	P	L	\$
1 1/8"	3/8"	94 1/2"	\$7.83



MORE THAN 300 PROFILES

RIBBON: PML01X01RI



H	P	L	\$
1 1/4"	5/8"	94 1/2"	\$10.68

NEXUS: PML01X00NE



H	P	L	\$
1 1/4"	1/2"	94 1/2"	\$10.68

MIDDLESBOROUGH: PML01X00MD



H	P	L	\$
1 1/4"	3/8"	94 1/2"	\$10.68

EGG AND DART: MLD01X01EG



H	P	L	\$
1 1/4"	5/8"	94 1/2"	\$13.65

STOCKPORT: PML01X00ST



H	P	L	\$
1 1/4"	5/8"	94 1/2"	\$10.68

EGG AND DART: PML01X01EG



H	P	L	\$
1 1/4"	7/8"	96"	\$7.12

DENTIL: MLD01X00DE



H	P	L	\$
1 1/4"	1/2"	94 1/2"	\$11.31

EDWARDS: PML01X10ED



H	P	L	\$
1 1/4"	3/4"	94 1/2"	\$10.68

SEQUENTIAL: MLD01X00SQ



H	P	L	\$
1 3/8"	3/8"	94 1/2"	\$15.43

LINUS: CHA01X01LI



H	P	L	\$
1 3/8"	1/2"	94 1/2"	\$13.06

DUBLIN: PML01X01DU



H	P	L	\$
1 3/8"	3/4"	94 1/2"	\$16.62

ALEXANDRIA: CHA01X01AL



H	P	L	\$
1 3/8"	7/8"	94 1/2"	\$15.43

SELLEK: CHA01X01SE



H	P	L	\$
1 3/8"	7/8"	94 1/2"	\$11.87

ACANTHUS: MLD01X00AC



H	P	L	\$
1 3/8"	7/8"	94 1/2"	\$11.87

VINCENT: MLD01X00VI



H	P	L	\$
1 1/2"	1/4"	94 1/2"	\$9.50

RIBBON: CHA01X01RB



H	P	L	\$
1 1/2"	3/8"	94 1/2"	\$11.87

★ **SWINDON: CHA01X00SW**



H	P	L	\$
1 1/2"	1/2"	94 1/2"	\$10.68

FEDERAL: CHA01X00FE



H	P	L	\$
1 1/2"	1/2"	94 1/2"	\$10.68

ABERDEEN: PML01X00AB



H	P	L	\$
1 1/2"	3/4"	94 1/4"	\$13.65

★ **SEVILLE: PML01X00SE**



H	P	L	\$
1 1/2"	3/4"	94 1/2"	\$11.87

★ **ROPE: CHA01X01RO**

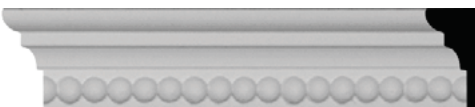

H	P	L	\$
1 1/2"	7/8"	94 1/2"	\$13.06

BRADFORD: MLD01X01X02BR



H	P	L	\$
1 1/2"	1 1/2"	94 1/2"	\$16.75

COLE: MLD01X01X02CO



H	P	L	\$
1 1/2"	1 1/2"	94 1/2"	\$16.15

DIAMOND: CHA02X01DI



H	P	L	\$
1 5/8"	1/2"	94 1/2"	\$11.87

MARCELLA: PML02X01MA



H	P	L	\$
1 5/8"	1/2"	94 1/2"	\$11.87

★ **ASHFORD: PML01X00AS**



H	P	L	\$
1 5/8"	1/2"	94 1/2"	\$11.87

★ **SWINDON: PML01X00SW**



H	P	L	\$
1 5/8"	1/2"	94 1/2"	\$11.87

KENDALL: PML01X00KD



H	P	L	\$
1 5/8"	3/4"	94 1/2"	\$11.87

ERIS: PML01X00ER



H	P	L	\$
1 5/8"	3/4"	94 1/2"	\$17.21

JACKSON: PML01X00JA



H	P	L	\$
1 5/8"	3/4"	94 1/2"	\$11.87

VALERIANO: PML02X01VA



H	P	L	\$
1 5/8"	1"	94 1/2"	\$12.11

LYON: PML02X00LY



H	P	L	\$
1 3/4"	3/8"	94 1/2"	\$11.87

SOFIA: CHA01X00SO



H	P	L	\$
1 3/4"	1/2"	94 1/2"	\$11.87

BACKPLATE: PIR01X00BP



H	P	L	\$
1 3/4"	1/2"	94 1/2"	\$27.05

MEDWAY: PIR02X00ME



H	P	L	\$
1 3/4"	1/2"	94 1/2"	\$49.35

**SHIPS OUT IN
24-72 HOURS**

HEIGHT
PROJECTION
LENGTH

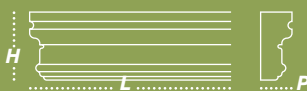

PANELMOULDING

CLAREMONT: PML01X00CL



H	P	L	\$
1 3/4"	1/2"	94 1/2"	\$11.87

FLOWER: CHA01X00FL



H	P	L	\$
1 3/4"	5/8"	94 1/2"	\$11.87

MIDDLESBOROUGH: PML02X01MD



H	P	L	\$
1 3/4"	5/8"	94 1/2"	\$11.87

HILLSBOROUGH: PML01X01HI



H	P	L	\$
1 3/4"	5/8"	94 1/2"	\$16.62

LANARKSHIRE: PML01X00LA



H	P	L	\$
1 3/4"	5/8"	94 1/2"	\$13.06

ASHFORD: CHA01X01AS



H	P	L	\$
1 3/4"	3/4"	94 1/2"	\$14.25

EGG AND DART: PML02X02EG



H	P	L	\$
1 3/4"	3/4"	94 1/2"	\$14.25

TIRANA: PML01X00TI



H	P	L	\$
1 3/4"	3/4"	94 1/2"	\$14.25

CLASSIC: PML02X01CL



H	P	L	\$
1 3/4"	7/8"	94 1/2"	\$11.87

SELLEK: PML01X01SK



H	P	L	\$
1 3/4"	1"	94 1/2"	\$14.71

ACANTHUS: PML01X01AC



H	P	L	\$
1 3/4"	1 1/8"	94 1/2"	\$14.25

QUEENSTOWN: CHA02X01QU



H	P	L	\$
1 3/4"	1 3/8"	94 1/2"	\$13.65

COLE: CHA01X01CO



H	P	L	\$
1 7/8"	1/2"	94 1/2"	\$14.25

COLE: CHA01X00CO

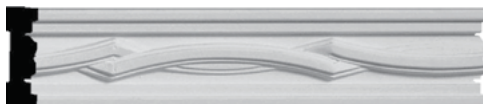

H	P	L	\$
1 7/8"	1/2"	94 1/2"	\$14.71

FLOWER: CHA01X01FL



H	P	L	\$
1 7/8"	5/8"	94 1/2"	\$14.84

EGG AND DART: PML02X01EG



H	P	L	\$
1 7/8"	5/8"	94 1/2"	\$16.03

REMINGTON: CHA01X00RE



H	P	L	\$
1 7/8"	3/4"	94 1/2"	\$14.25

BLACKTHORNE: MLD01X00BL



H	P	L	\$
1 7/8"	3/4"	94 1/2"	\$17.21

REEDED: PML01X01RE



H	P	L	\$
1 7/8"	3/4"	94 1/2"	\$15.43

ARTIS: PML01X00AR



H	P	L	\$
1 7/8"	3/4"	94 1/2"	\$14.71

CRENDON: PML01X00CR



H	P	L	\$
1 7/8"	7/8"	94 1/2"	\$15.43

VALERIANO: PML01X01VA

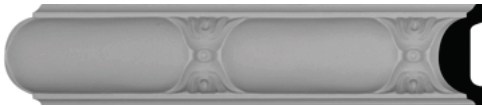

H	P	L	\$
1 7/8"	1"	94 1/2"	\$21.37

MONIQUE: PIR02X00MO



H	P	L	\$
2"	1/4"	94 1/2"	\$24.68

TRISTAN: CHA02X00TN



H	P	L	\$
2"	3/8"	94 1/2"	\$14.25

LISBON: CHA02X00LI



H	P	L	\$
2"	3/8"	94 1/2"	\$17.09

NEVIO: PML02X00NE



H	P	L	\$
2"	3/8"	94 1/2"	\$12.47



ALEXANDRIA: CAS02X00AL



H	P	L	\$
2"	1/2"	94 1/2"	\$11.87

VICTORIAN: CHA02X01VI



H	P	L	\$
2"	1/2"	94 1/2"	\$11.87

HURLEY: PML02X01HU



H	P	L	\$
2"	1/2"	94 1/2"	\$13.06

CLAREMONT: CHA02X01CL



H	P	L	\$
2"	5/8"	94 1/2"	\$13.06

HILLSBOROUGH: CHA02X01HI



H	P	L	\$
2"	5/8"	94 1/2"	\$13.06

RAYMOND: PML02X01RA



H	P	L	\$
2"	5/8"	94 1/2"	\$15.43

LEAF: MLD02X01LE



H	P	L	\$
2"	5/8"	94 1/2"	\$15.43

★ **OXFORD:** PML02X00OX



H	P	L	\$
2"	5/8"	94 1/2"	\$13.06



★ **RAYMOND:** PML02X00RA



H	P	L	\$
2"	5/8"	94 1/2"	\$13.65

FLORENCE: CHA02X01FL



H	P	L	\$
2"	3/4"	94 1/2"	\$16.62

BAROQUE: MLD02X01BQ



H	P	L	\$
2"	3/4"	94 1/2"	\$21.37

VALERIANO: PML02X00VA



H	P	L	\$
2"	3/4"	94 1/2"	\$14.25

MONIQUE: CHA02X01MO

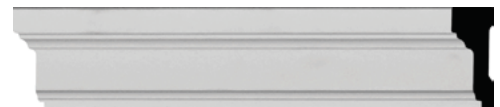

H	P	L	\$
2"	7/8"	94 1/2"	\$13.06

DEVON: PML02X00DE



H	P	L	\$
2"	7/8"	94 1/2"	\$15.43

FAIRFAX: PML02X01FA



H	P	L	\$
2"	1 1/8"	94 1/2"	\$17.81

REDEED: PML02X01RE



H	P	L	\$
2"	1 1/8"	94 1/2"	\$17.81

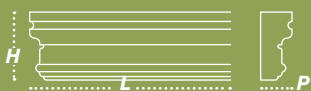

SUSSEX: PML02X00SU



H	P	L	\$
2"	1 7/8"	94 1/2"	\$14.25

RIBBON: PML02X01RI



H	P	L	\$
2 1/8"	1/4"	78 7/8"	\$14.01

DELFINA: PML02X01DL



H	P	L	\$
2 1/8"	3/8"	79"	\$14.96

MARSEILLE: MLD02X00MA



H	P	L	\$
2 1/8"	3/8"	94 1/2"	\$13.06

KENT: MLD02X00KE



H	P	L	\$
2 1/8"	5/8"	94 1/2"	\$14.25

REEDED: PML02X00RE

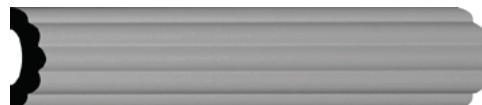

H	P	L	\$
2 1/8"	3/4"	94 1/2"	\$17.81



DUBLIN: PML02X01DU



H	P	L	\$
2 1/8"	7/8"	94 1/2"	\$17.81

EMERY: PML02X01EM



H	P	L	\$
2 1/8"	7/8"	94 1/2"	\$18.40

NADIA: PML02X01NA



H	P	L	\$
2 1/8"	1 1/8"	94 1/2"	\$24.57

SALEM: MLD02X00SA



H	P	L	\$
2 1/4"	1/4"	94 1/2"	\$14.84

DERRY: PIR02X00DE



H	P	L	\$
2 1/4"	3/8"	78"	\$32.05

PEARL: PIR02X00PE



H	P	L	\$
2 1/4"	3/8"	78"	\$32.39

FEDERAL: CHA02X00FE



H	P	L	\$
2 1/4"	1/2"	94 1/2"	\$16.62

HAYLYNN: CHA02X01HY



H	P	L	\$
2 1/4"	3/4"	94 1/2"	\$17.81

KINSLEY: CHA02X01KN



H	P	L	\$
2 1/4"	3/4"	94 1/2"	\$17.81

LOERA: PML02X00LO



H	P	L	\$
2 1/4"	3/4"	94 1/2"	\$15.31

MILTON: PML02X00MI



H	P	L	\$
2 1/4"	3/4"	94 1/2"	\$14.25

EMERY: CHA02X01EM



H	P	L	\$
2 1/4"	7/8"	94 1/2"	\$15.43

PEARL: PML02X00PE



H	P	L	\$
2 3/8"	3/8"	79 1/2"	\$18.04

ALEXANDRIA: MLD02X00AL



H	P	L	\$
2 3/8"	3/8"	94 1/2"	\$13.06

CARRILLO: CHA02X01CI



H	P	L	\$
2 3/8"	5/8"	94 1/2"	\$12.47

EDWARD: CHA02X00ED



H	P	L	\$
2 1/2"	1/2"	94 1/2"	\$15.31

FOSTER: PML02X00FO



H	P	L	\$
2 3/8"	3/4"	94 1/2"	\$14.25

CLASSIC: PML02X00CL



H	P	L	\$
2 3/8"	7/8"	94 1/2"	\$16.62

HAMILTON: PML02X01HA



H	P	L	\$
2 3/8"	1"	94 1/2"	\$16.62

SHELL: PML02X01SH



H	P	L	\$
2 3/8"	1 1/8"	94 1/2"	\$27.42

CAPISTRANO: PML02X01CP



H	P	L	\$
2 3/8"	1 1/4"	94 1/2"	\$20.18

WHITMAN: PML02X01WH



H	P	L	\$
2 3/8"	1 1/4"	94 1/2"	\$27.42

LYON: PML02X02LY



H	P	L	\$
2 3/8"	1 1/2"	94 1/2"	\$16.62

BULWARK: MLD02X00BU



H	P	L	\$
2 1/2"	3/8"	94 1/2"	\$13.06

BEDFORD: CAS02X00BE



H	P	L	\$
2 1/2"	1/2"	94 1/2"	\$15.90

ROSE: CHA02X01RO



H	P	L	\$
2 1/2"	1/2"	94 1/2"	\$19.00

FEDERAL: CHA02X01FE



H	P	L	\$
2 1/2"	1/2"	94 1/2"	\$14.25

FACTORY PRIMED

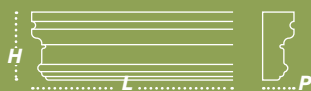

ACANTHUS: PML02X00AC



H	P	L	\$
2 1/2"	1/2"	94 1/2"	\$15.43

POMPEII: PML02X00PO



H	P	L	\$
2 1/2"	3/4"	94 1/2"	\$15.43

CLASSIC: PML03X01CL



H	P	L	\$
2 1/2"	7/8"	94 1/2"	\$28.49

BEADED: MLD02X01BE



H	P	L	\$
2 1/2"	1"	94 1/2"	\$21.96

SWINDON: MLD02X01SW



H	P	L	\$
2 1/2"	1 1/8"	94 1/2"	\$17.21

HILLSBOROUGH: CAS02X01HI



H	P	L	\$
2 5/8"	5/8"	94 1/2"	\$19.00

PIEDMONT: CHA03X01PE



H	P	L	\$
2 5/8"	3/4"	94 1/2"	\$26.12

NORWICH: MLD02X00NO



H	P	L	\$
2 5/8"	3/4"	94 1/2"	\$16.03

KENNETH: PML02X01KN



H	P	L	\$
2 5/8"	3/4"	94 1/2"	\$19.00

ALEXANDRIA: PML03X01AL



H	P	L	\$
2 5/8"	3/4"	94 1/2"	\$20.78

DOVER: CHA02X00DR



H	P	L	\$
2 5/8"	7/8"	94 1/2"	\$14.25

BEADED: MLD02X00BE



H	P	L	\$
2 5/8"	7/8"	94 1/2"	\$19.59

BEDFORD: PML02X01BE



H	P	L	\$
2 5/8"	1 1/8"	94"	\$18.40

HILLSBOROUGH: PIR02X00HI



H	P	L	\$
2 3/4"	3/8"	78"	\$38.80

JACKSON: PIR02X00JA



H	P	L	\$
2 3/4"	3/8"	78"	\$37.02

ERIS: MLD02X00ER



H	P	L	\$
2 3/4"	3/8"	94 1/2"	\$16.62

LISBON: CHA02X00TR



H	P	L	\$
2 3/4"	1/2"	94 1/2"	\$14.25

MEDWAY: CHA03X01ME



H	P	L	\$
2 3/4"	5/8"	94 1/2"	\$19.00

VICTORIAN: CHA03X01VI

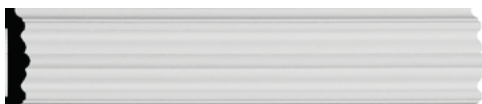

H	P	L	\$
2 3/4"	5/8"	94 1/2"	\$16.62

TIRANA: MLD02X00TI



H	P	L	\$
2 3/4"	5/8"	94 1/2"	\$16.62

CRENDON: CHA02X00CR



H	P	L	\$
2 3/4"	7/8"	94 1/2"	\$17.21

EDWARDS: MLD02X01ED



H	P	L	\$
2 3/4"	1"	94 1/2"	\$19.00

CLASSIC: PML03X02CL



H	P	L	\$
2 3/4"	1 3/8"	94 1/2"	\$24.93

KEPLER: CHA03X02KP



H	P	L	\$
2 3/4"	1 7/8"	94 1/2"	\$17.81

SMOOTH: PML03X01SM



H	P	L	\$
2 7/8"	5/8"	94 1/2"	\$21.37

MONIQUE: CAS02X00MO



H	P	L	\$
2 7/8"	3/4"	94 1/2"	\$18.87

NESTOR: PML03X01NE



H	P	L	\$
2 7/8"	7/8"	94 1/2"	\$27.42

HAMILTON: PIR03X00HA



H	P	L	\$
3"	3/8"	94 1/2"	\$49.35

HOLMDEL: PIR03X00HO



H	P	L	\$
3"	3/8"	94 1/2"	\$45.79

FLUTED: PML03X00FL



H	P	L	\$
3"	3/8"	94 1/2"	\$19.00

BEDFORD: CHA03X01BE

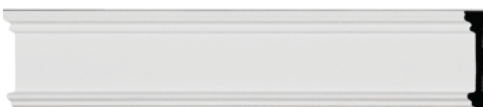

H	P	L	\$
3"	5/8"	94 1/2"	\$21.37

MILTON: CHA03X01MI

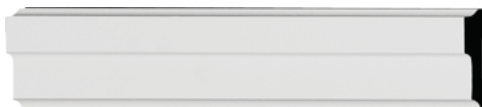

H	P	L	\$
3"	5/8"	94 1/2"	\$21.37

LYON: CHA03X01LY



H	P	L	\$
3"	5/8"	94 1/2"	\$33.11

NEVIO: CHA03X00NE



H	P	L	\$
3"	5/8"	94 1/2"	\$21.37

DIANA: MLD03X00DI



H	P	L	\$
3"	5/8"	94 1/2"	\$17.81

WOODRUFF: MLD03X01WF



H	P	L	\$
3"	5/8"	94 1/2"	\$24.93

CHARLESTON: CHA03X01CH



H	P	L	\$
3"	7/8"	94 1/2"	\$23.74

LEAF: CHA03X01LE



H	P	L	\$
3"	7/8"	94 1/2"	\$20.18

STANDARD: PML03X01ST



H	P	L	\$
3"	7/8"	94 1/2"	\$24.93

OSLO: PML03X01OS



H	P	L	\$
3"	1"	94 1/2"	\$23.74

HEATON: PML03X01HE



H	P	L	\$
3"	1"	94 1/2"	\$20.18

EDINBURGH: PML03X01ED



H	P	L	\$
3"	1 1/8"	94 1/4"	\$26.12

HEIGHT
PROJECTION
LENGTH



PANELMOULDING



WINDSOR: CHA03X01WI



H	P	L	\$
3"	1 1/8"	94 1/2"	\$27.31

DUBLIN: MLD03X01DU



H	P	L	\$
3"	1 1/8"	94 1/2"	\$21.96

REEDED: PML03X01RE



H	P	L	\$
3"	1 1/8"	94 1/2"	\$27.42



EMERY: MLD03X00EM



H	P	L	\$
3 1/8"	1/2"	94 1/2"	\$20.18

SWINDON: PML03X01SW



H	P	L	\$
3 1/8"	1/2"	94 1/2"	\$26.71

HILLSBOROUGH: CAS03X01HI



H	P	L	\$
3 1/8"	5/8"	94 1/2"	\$19.00

BACKPLATE: PIR03X00BP



H	P	L	\$
3 1/8"	5/8"	94 1/2"	\$44.60

MONIQUE: PIR03X00MO



H	P	L	\$
3 1/8"	5/8"	94 1/2"	\$69.28

FEDERAL: CHA03X00FE



H	P	L	\$
3 1/8"	3/4"	94 1/2"	\$24.93

MARIA: MLD03X00MA



H	P	L	\$
3 1/8"	3/4"	94 1/2"	\$23.74

EMERY: PML03X00EM



H	P	L	\$
3 1/8"	3/4"	94 1/2"	\$19.00

EMERY: PML03X00ER



H	P	L	\$
3 1/8"	3/4"	94 1/2"	\$18.40

CAPUTO: PML03X00CA



H	P	L	\$
3 1/8"	3/4"	94 1/2"	\$18.40

ERIS: CHA03X01ER



H	P	L	\$
3 1/8"	7/8"	94 1/2"	\$21.24

WINDSOR: CHA03X00WI



H	P	L	\$
3 1/8"	7/8"	94 1/2"	\$24.34

CAPUTO: CHA03X00CA



H	P	L	\$
3 1/8"	7/8"	94 1/2"	\$21.37

MARSEILLE: CHA03X01MA



H	P	L	\$
3 1/8"	1"	94 1/2"	\$27.31

KEPLER: CHA03X01KP

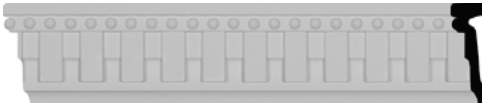

H	P	L	\$
3 1/8"	1"	94 1/2"	\$27.31

FEDERAL: CHA03X01FE



H	P	L	\$
3 1/8"	1"	94 1/2"	\$22.43

FEDERAL: CHA03X02FE



H	P	L	\$
3 1/8"	1"	94 1/2"	\$24.93

BEADED: PML03X02BE



H	P	L	\$
3 1/8"	1 1/4"	94 1/2"	\$28.02

VERSAILLES: CHA03X00VE



H	P	L	\$
3 1/8"	1 3/8"	94 1/2"	\$28.49

STANDARD: MLD03X02ST



H	P	L	\$
3 1/8"	2 3/8"	94 1/2"	\$51.05

KINSLEY: PML03X00KI



H	P	L	\$
3 1/4"	3/8"	94 1/2"	\$41.55

COLE: MLD03X00CO



H	P	L	\$
3 1/4"	5/8"	94 1/2"	\$19.00

EMERY: CHA03X01EM



H	P	L	\$
3 1/4"	3/4"	94 1/2"	\$19.00

EGG AND DART: CHA03X01EG



H	P	L	\$
3 1/4"	3/4"	94 1/2"	\$26.12

ROSE: CHA03X01RO



H	P	L	\$
3 1/4"	3/4"	94 1/2"	\$24.93

DELFINA: CHA03X00DL



H	P	L	\$
3 1/4"	3/4"	94 1/2"	\$30.74

ATHENS: CHA03X01AT



H	P	L	\$
3 1/4"	7/8"	94 1/2"	\$27.31

FOSTER: PML03X01FO



H	P	L	\$
3 1/4"	7/8"	94 1/2"	\$26.48

NEVIO: CHA04X01NE



H	P	L	\$
3 1/4"	1"	94 1/2"	\$24.93

PICK YOUR PERFECT PATTERN FOR A SIGNATURE STYLE

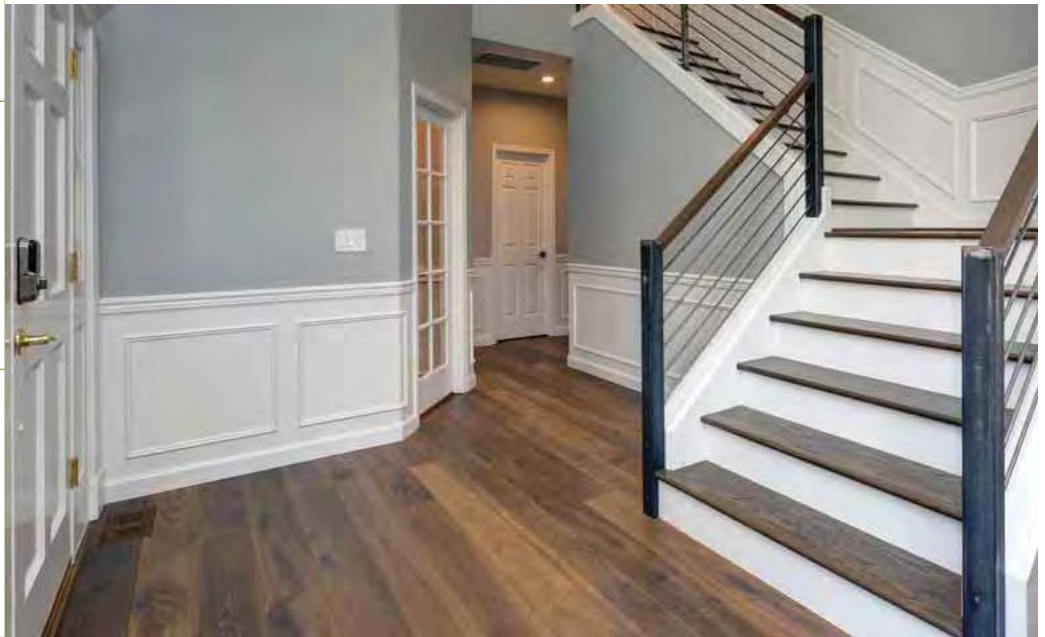

HEIGHT
PROJECTION
LENGTH



PANELMOULDING

FLAT: FLT03X01X96



H	P	L	\$
3 1/4"	1"	94 1/2"	\$39.77

EGG AND DART: PML03X01EG



H	P	L	\$
3 1/4"	1"	94 1/2"	\$33.01

VICEROY: PML03X01VI



H	P	L	\$
3 1/4"	1 1/8"	94 1/2"	\$28.02

WINSTON: CHA03X01WN



H	P	L	\$
3 3/8"	1/2"	94 1/2"	\$26.12

MEDWAY: CHA03X00ME



H	P	L	\$
3 3/8"	3/4"	94 1/2"	\$24.34

FINLEY: CHA03X01FI



H	P	L	\$
3 3/8"	1"	94 1/2"	\$26.12

NEVIO: CHA03X02NE



H	P	L	\$
3 3/8"	1"	94 1/2"	\$26.12

CHESTERFIELD: PML03X01CH



H	P	L	\$
3 3/8"	1"	94 1/2"	\$21.37

★ **BLACKTHORNE:** CHA03X01BL



H	P	L	\$
3 3/8"	1 1/8"	94 1/2"	\$24.93

TRADITIONAL: PML03X02TR



H	P	L	\$
3 3/8"	1 5/8"	94 1/2"	\$26.71

ERIS: MLD03X00ER



H	P	L	\$
3 1/2"	1/2"	94 1/2"	\$19.00

ATTICA: CHA03X00AT



H	P	L	\$
3 1/2"	3/4"	94 1/2"	\$23.74

DIANE: CHA03X00DI



H	P	L	\$
3 1/2"	3/4"	94 1/2"	\$33.24

BENSON: MLD03X01BE



H	P	L	\$
3 1/2"	3/4"	94 1/2"	\$21.96

DENTIL: MLD03X01MU



H	P	L	\$
3 1/2"	1"	94 1/2"	\$22.56

ODESSA: MLD03X01OD



H	P	L	\$
3 1/2"	1"	94 1/2"	\$23.74

BLACKTHORN: PML03X01BL



H	P	L	\$
3 1/2"	1"	94 1/2"	\$28.02

DEVON: CAS03X01DE



H	P	L	\$
3 1/2"	1 1/8"	94 1/2"	\$24.93

FAIRFAX: PML03X01FA



H	P	L	\$
3 1/2"	1 1/8"	94 1/2"	\$23.74

★ **BEDFORD:** PML03X01BE



H	P	L	\$
3 1/2"	1 1/8"	94 1/2"	\$22.56

DOVER: CAS03X01DR



H	P	L	\$
3 1/2"	1 3/8"	94 1/2"	\$35.62

BEDFORD: PML04X02BE



H	P	L	\$
3 1/2"	1 5/8"	94 1/2"	\$28.49

RIBBON: PML04X02RE



H	P	L	\$
3 1/2"	2 3/8"	94 1/2"	\$27.31

NEVIO: CHA03X01NE



H	P	L	\$
3 5/8"	1/2"	94 1/2"	\$35.62

ANTONIO: CHA03X01AN



H	P	L	\$
3 5/8"	3/4"	94 1/2"	\$28.49

ANTONIO: CHA04X01AN



H	P	L	\$
3 5/8"	3/4"	94 1/2"	\$29.68

CLASSIC: PML03X00CL



H	P	L	\$
3 5/8"	3/4"	94 1/2"	\$38.58

LINUS: CHA03X01LI



H	P	L	\$
3 5/8"	1"	94 1/2"	\$29.68



DUBLIN: CAS03X01DU



H	P	L	\$
3 5/8"	1 1/4"	94 1/2"	\$30.27

SIMON: CHA04X01SI



H	P	L	\$
3 5/8"	1 1/4"	94 1/2"	\$28.49

VERSAILLES: CHA03X01VE



H	P	L	\$
3 5/8"	1 1/4"	94 1/2"	\$30.87

BEDFORD: CHA04X01BE



H	P	L	\$
3 5/8"	1 1/4"	94 1/2"	\$27.31

HAMILTON: CHA03X01HA



H	P	L	\$
3 3/4"	5/8"	94 1/2"	\$24.93

WOVEN: CHA04X01WO



H	P	L	\$
3 3/4"	3/4"	94 1/2"	\$33.24

CLASSIC: CAS04X94X01



H	P	L	\$
3 3/4"	7/8"	94 1/2"	\$21.37

FAIRMONT: CHA04X01FA



H	P	L	\$
3 3/4"	1 1/8"	94 1/2"	\$33.24

EDWARDS: CAS04X01ED



H	P	L	\$
3 3/4"	1 1/4"	94 1/2"	\$31.23

TRADITIONAL: FLT03X00TR



H	P	L	\$
3 7/8"	3/8"	94"	\$21.37

FAIRFAX: PIR03X00FA



H	P	L	\$
3 7/8"	3/8"	94 1/2"	\$60.55

SWINDON: CHA03X01SW



H	P	L	\$
3 7/8"	1/2"	94 1/2"	\$28.49

LUNEL: PML03X00LU



H	P	L	\$
3 7/8"	1/2"	94 1/2"	\$40.36

MARCELLA: CHA03X00MA



H	P	L	\$
3 7/8"	3/4"	94 1/2"	\$22.56

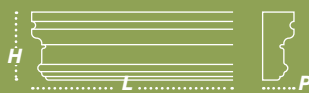

ROSE: CHA03X00RO



H	P	L	\$
3 7/8"	3/4"	94 1/2"	\$26.71

STANDARD: MLD04X02ST

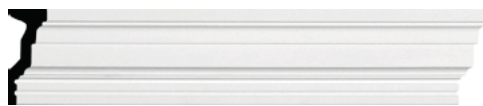

H	P	L	\$
3 7/8"	1 1/2"	94 1/2"	\$29.68

PALMETTO: PML04X02PA



H	P	L	\$
3 7/8"	2 3/8"	94 1/2"	\$34.07

SWINDON: PIR04X00SW



H	P	L	\$
4"	3/8"	94 1/2"	\$49.35

**PAIR
PANEL MOULDING
WITH MATCHING
CROWN MOULDING
TO ADD
GREAT VALUE**



TOMANGO: PIR04X00TO



H	P	L	\$
4"	3/8"	94 1/2"	\$49.35

FLUTED: CAS04X01FL



H	P	L	\$
4"	5/8"	94 1/2"	\$26.12

FLUTED: MLD04X00FT



H	P	L	\$
4"	3/8"	94 1/2"	\$22.56

SYDNEY: MLD04X01SY



H	P	L	\$
4"	5/8"	94 1/2"	\$30.87

NAOMI: PML04X01NA



H	P	L	\$
4"	5/8"	94 1/2"	\$26.12

GORLEEN: CHA04X01GO



H	P	L	\$
4"	3/4"	94 1/2"	\$28.49

FELIX: CAS04X00FE



H	P	L	\$
4"	3/4"	94 1/2"	\$24.93

GORLEEN: PML04X00GO



H	P	L	\$
4"	3/4"	94 1/2"	\$24.93

OSLO: MLD04X00OS



H	P	L	\$
4"	3/4"	94 1/2"	\$29.09

EDWARDS: PML04X00ED



H	P	L	\$
4"	7/8"	94 1/2"	\$24.93

BLACKTHORNE: CHA04X01BL

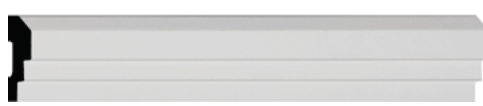

H	P	L	\$
4"	1"	94 1/2"	\$29.68

VERSAILLES: CHA04X01VE



H	P	L	\$
4"	1"	94 1/2"	\$28.83



HEATON: MLD04X01HE



H	P	L	\$
4"	1"	94 1/2"	\$39.18

DYLAN: CHA04X01DY



H	P	L	\$
4"	1 1/8"	94 1/2"	\$28.83

DUBLIN: MLD04X01DU



H	P	L	\$
4"	1 1/8"	94 1/2"	\$27.31

EGG AND DART: CHA04X01EG



H	P	L	\$
4"	1 1/4"	94 1/2"	\$33.24

DUBLIN: PML04X01DU



H	P	L	\$
4"	1 1/4"	94 1/2"	\$26.71

NADIA: CHA04X01NA



H	P	L	\$
4"	1 3/8"	94 1/2"	\$32.05

EMILY: CHA04X01EY



H	P	L	\$
4"	1 3/8"	94 1/2"	\$37.99



DYLAN: CAS04X01DY



H	P	L	\$
4"	1 1/2"	94 1/2"	\$39.18

STANDARD: MLD04X01ST



H	P	L	\$
4"	1 5/8"	94 1/2"	\$41.55



VICTORIAN: CHA04X03VI



H	P	L	\$
4"	2 7/8"	94 1/2"	\$27.31

AMBER: CHA04X00AE



H	P	L	\$
4 1/8"	5/8"	94 1/2"	\$29.68

SMOOTH: PML04X01CL



H	P	L	\$
4 1/8"	5/8"	94 1/2"	\$26.35

SEQUENTIAL: CHA04X01SQ



H	P	L	\$
4 1/8"	1 1/8"	94 1/2"	\$30.15

NESTOR: CHA04X00NS



H	P	L	\$
4 1/4"	5/8"	94 1/2"	\$38.88

EMERY: PML04X01EM



H	P	L	\$
4 1/4"	5/8"	94 1/2"	\$34.31

MEDWAY: CHA04X01ME



H	P	L	\$
4 1/4"	3/4"	94 1/2"	\$29.68

FLORAL: CHA04X00FL



H	P	L	\$
4 1/4"	3/4"	94 1/2"	\$25.52

EMERY: CHA04X01EM



H	P	L	\$
4 1/4"	1 1/4"	94 1/2"	\$33.24

HEIGHT
PROJECTION
LENGTH

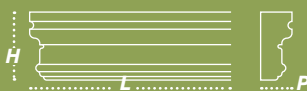

PANELMOULDING

SWAG: PML04X01SW



H	P	L	\$
4 1/4"	1 1/4"	94 1/2"	\$35.02

ROPE: CHA04X01RO



H	P	L	\$
4 1/4"	1 1/2"	94 1/8"	\$37.61

CLAREMONT: CHA04X01CL



H	P	L	\$
4 1/4"	1 5/8"	94 1/2"	\$35.62

ORLEANS: CHA04X01OL



H	P	L	\$
4 3/8"	5/8"	94 1/2"	\$29.68

VICTORIAN: CHA04X01VI



H	P	L	\$
4 3/8"	5/8"	94 1/2"	\$29.68

DELFINA: CHA04X00DL



H	P	L	\$
4 3/8"	3/4"	94 1/2"	\$32.05

VERSAILLES: CHA04X00VE



H	P	L	\$
4 3/8"	3/4"	94 1/2"	\$30.87

FEDERAL: CHA04X01FE



H	P	L	\$
4 3/8"	3/4"	94 1/2"	\$30.74

FEDERAL: PML04X01FE



H	P	L	\$
4 3/8"	7/8"	94 1/2"	\$34.31

ORNATE OR SMOOTH HISTORIC OR MODERN

SOUTHAMPTON: CHA04X01SO



H	P	L	\$
4 3/8"	1"	94 1/2"	\$27.90

DENTIL: MLD04X01DE



H	P	L	\$
4 3/8"	2 3/8"	94 1/2"	\$53.42

LEAF: CHA04X01LF



H	P	L	\$
4 1/2"	5/8"	94 1/2"	\$32.05

LISBON: PML04X00LI

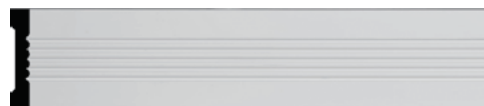

H	P	L	\$
4 1/2"	3/4"	94 1/2"	\$32.65

WOODRUFF: PML04X01WF



H	P	L	\$
4 1/2"	7/8"	94 1/2"	\$34.31

HERA: CHA04X01HE



H	P	L	\$
4 1/2"	1 1/8"	94 1/2"	\$33.24

TRISTAN: CHA04X01TN



H	P	L	\$
4 1/2"	1 1/2"	94 3/8"	\$35.96

FEDERAL: CHA05X02FE



H	P	L	\$
4 1/2"	1 3/4"	94 1/2"	\$40.36

STANDARD: MLD04X03ST



H	P	L	\$
4 1/2"	3 1/2"	94 1/2"	\$81.92

AMBER: CHA04X01AE



H	P	L	\$
4 5/8"	3/4"	94 1/2"	\$32.05

RALSTON: CHA04X01RA



H	P	L	\$
4 5/8"	1"	94 1/2"	\$34.43

STOCKPORT: CHA05X01ST



H	P	L	\$
4 3/4"	7/8"	94 1/2"	\$37.99

LISBON: CHA04X00LI



H	P	L	\$
4 3/4"	7/8"	94 1/2"	\$38.20

LYON: PML04X01LY



H	P	L	\$
4 3/4"	1"	94 1/2"	\$35.02

MARSEILLE: PML04X01MA



H	P	L	\$
4 3/4"	1"	94 1/2"	\$43.93

ABERDEEN: CHA04X01AB



H	P	L	\$
4 3/4"	1 1/8"	94 1/2"	\$42.74

DIANE: PML04X01DI



H	P	L	\$
4 3/4"	1 1/8"	94 1/2"	\$30.87

KEPLER: CHA05X01KP



H	P	L	\$
4 3/4"	1 1/4"	94 1/2"	\$40.36

SEVILLE: MLD04X01SE



H	P	L	\$
4 3/4"	1 3/8"	94 1/2"	\$30.87

HOLMDEL: CHA05X02HO



H	P	L	\$
4 3/4"	1 3/4"	94 1/2"	\$49.61

STANDARD: MLD04X04ST



H	P	L	\$
4 3/4"	3 7/8"	94 1/2"	\$40.36

SHEFFIELD: CHA04X00SH



H	P	L	\$
4 7/8"	7/8"	94 1/2"	\$41.76

BRADFORD: CAS04X01BR



H	P	L	\$
4 7/8"	1"	94 1/2"	\$49.86

ELSINORE: CAS04X00EL



H	P	L	\$
4 7/8"	1 5/8"	94 1/2"	\$42.48

MILLIN: CHA05X01MU



H	P	L	\$
5"	5/8"	94 1/2"	\$32.05

ANTONIO: CHA05X01AN



H	P	L	\$
5"	5/8"	94 1/2"	\$28.49

ABERDEEN: MLD05X00AB



H	P	L	\$
5"	5/8"	94 1/2"	\$28.49

WAKEFIELD: MLD05X00WA



H	P	L	\$
5"	5/8"	94 1/2"	\$28.49

ORLEANS: MLD05X00OL



H	P	L	\$
5"	7/8"	94 1/2"	\$34.43

WELLINGTON: CHA05X01WE



H	P	L	\$
5"	1"	94 1/2"	\$35.62

BRONTES: MLD05X01BO



H	P	L	\$
5"	1 3/8"	94 1/2"	\$30.87

HEIGHT
PROJECTION
LENGTH

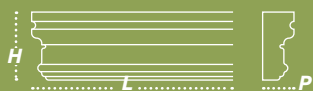

PANELMOULDING

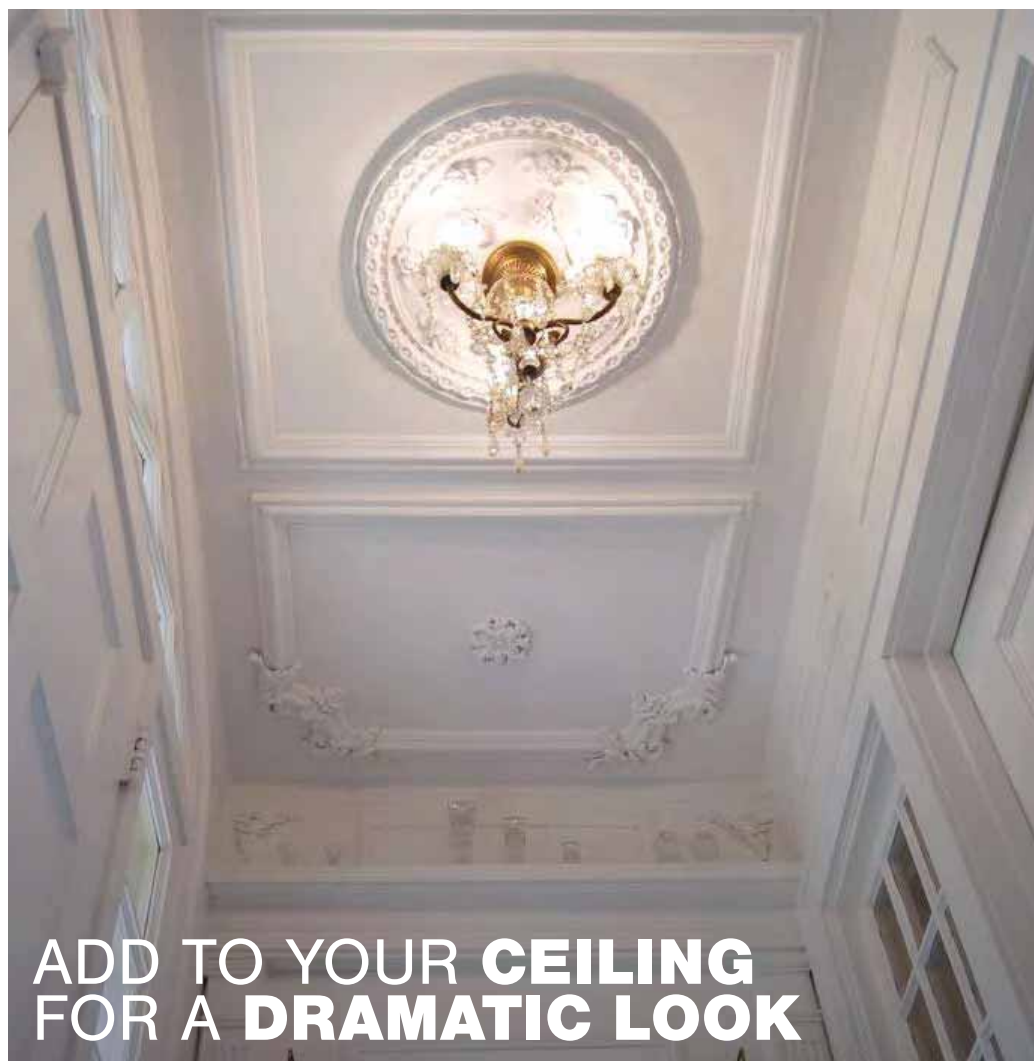

ADD TO YOUR CEILING
FOR A DRAMATIC LOOK

DUBLIN: MLD05X01DU



H	P	L	\$
5"	1 5/8"	94 1/2"	\$36.21

STANDARD: MLD05X04ST



H	P	L	\$
5"	4"	94 1/2"	\$72.59

FLUTED: CAS05X79X01



H	P	L	\$
5 1/8"	5/8"	78 3/4"	\$26.92

VERSAILLES: MLD05X00VE



H	P	L	\$
5 1/8"	7/8"	94 1/2"	\$28.49

BEDFORD: MLD05X01BE



H	P	L	\$
5 1/8"	1 1/8"	94 1/2"	\$32.05

EMERY: MLD05X01EM



H	P	L	\$
5 1/8"	1 1/8"	94 1/2"	\$39.18

MILTON: CAS05X01MI



H	P	L	\$
5 1/4"	1"	94 1/2"	\$37.27

DEVON: CHA05X01DE



H	P	L	\$
5 3/8"	1 3/8"	94 1/2"	\$41.55

LEGACY: PML04X00LE



H	P	L	\$
5 1/2"	3/4"	94 1/2"	\$36.80

★ **BLACKTHORNE:** PML05X01BL



H	P	L	\$
5 1/2"	1 1/4"	94 1/2"	\$34.43

FLORAL: MLD06X01FL



H	P	L	\$
5 1/2"	1 3/8"	94 1/2"	\$41.55

SEVILLE: MLD05X02X08SE



H	P	L	\$
5 1/2"	2"	94 1/2"	\$67.67

PANEL: PML06X02PN-3



H	P	L	\$
5 1/2"	2"	94 1/2"	\$45.11

STANDARD: MLD06X03ST



H	P	L	\$
5 1/2"	2 3/4"	94 1/2"	\$67.66

NICOLE: CHA05X03NI



H	P	L	\$
5 1/2"	3"	94 1/2"	\$71.23

STANDARD: MLD06X04ST-2



H	P	L	\$
5 1/2"	4"	94 1/2"	\$77.72

EGG AND DART: CHA05X01EG



H	P	L	\$
5 5/8"	1 1/8"	94 1/2"	\$46.30

CHESTERFIELD: CHA05X01CH



H	P	L	\$
5 5/8"	1 1/4"	94 1/2"	\$50.07

STANDARD: MLD06X05ST



H	P	L	\$
5 3/4"	4 3/4"	94 1/2"	\$105.53

SWINDON: PML06X01SW



H	P	L	\$
5 7/8"	7/8"	94 1/2"	\$36.80

HARVEST: CHA05X01HA



H	P	L	\$
5 7/8"	1 3/4"	94 1/2"	\$45.11

STANDARD: MLD05X02ST



H	P	L	\$
5 7/8"	2"	94 1/2"	\$40.36

LOERA: MLD06X03X06LO



H	P	L	\$
5 7/8"	2 5/8"	94 1/2"	\$60.55

FLAT: FLT06X01FL



H	P	L	\$
6"	5/8"	94 1/2"	\$42.74



FAST & EASY INSTALLATION

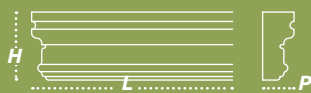

KINSLEY: PML06X01KI



H	P	L	\$
6"	1 1/8"	94 1/2"	\$48.68

ASHFORD: CAS06X01AS



H	P	L	\$
6"	1 3/8"	94 1/2"	\$58.29

ACANTHUS LEAF: CHA06X02AC



H	P	L	\$
6"	1 5/8"	94 1/2"	\$59.36

PANEL: PML06X02PN-2



H	P	L	\$
6"	1 5/8"	94 1/2"	\$42.15

PANEL: PML06X02PN-1



H	P	L	\$
6 1/8"	2"	94 1/2"	\$47.66

ODESSA: CHA06X01OD



H	P	L	\$
6 1/4"	1 1/2"	94 1/2"	\$49.27

FEDERAL: MLD06X02FE



H	P	L	\$
6 1/4"	2"	94 1/2"	\$45.71

STANDARD: MLD06X04ST-1



H	P	L	\$
6 1/4"	4"	94 1/2"	\$73.25

NAOMI: PML06X01NA



H	P	L	\$
6 3/8"	5/8"	94 1/2"	\$40.36

SPRINGTIME: CHA06X00SP



H	P	L	\$
6 3/4"	3/4"	94 1/2"	\$44.99

STOCKPORT: CHA07X01ST



H	P	L	\$
6 3/4"	1 1/4"	94 1/2"	\$56.99

FLAT: FLT07X01X0FL



H	P	L	\$
6 7/8"	1 3/8"	94 1/2"	\$58.17

HEATON: MLD07X02HE



H	P	L	\$
6 7/8"	2"	94 1/2"	\$99.72

GRAPE: PIR07X00GR



H	P	L	\$
7"	5/8"	94 1/4"	\$86.67

FLOWER: PML07X01FL



H	P	L	\$
7"	5/8"	94 1/2"	\$43.33

FLUTED: CAS07X79X01



H	P	L	\$
7"	1"	78 3/4"	\$43.54

ASHFORD: MLD07X01AS



H	P	L	\$
7"	1"	94 1/2"	\$52.83

MONIQUE: MLD07X01MO



H	P	L	\$
7"	1"	94 1/2"	\$53.42

WELLINGTON: MLD07X01WE



H	P	L	\$
7"	1"	94 1/2"	\$52.83

TYRONE: MLD07X01TY



H	P	L	\$
7"	1"	94 1/2"	\$49.27

DENTIL: PML07X02DE



H	P	L	\$
7"	1 5/8"	94 1/2"	\$118.13

DYLAN: PML07X01DY



H	P	L	\$
7"	1 3/4"	94 1/2"	\$62.47

FLORAL SWAG: CHA07X02FL



H	P	L	\$
7 1/8"	1 5/8"	94 1/2"	\$71.23

STANDARD: MLD03X07ST



H	P	L	\$
7 1/8"	2 1/2"	94 1/2"	\$81.92

TRADITIONAL: FLT07X00TR



H	P	L	\$
7 1/2"	3/4"	78 3/4"	\$42.15



EMERY: CHA07X01ER



H	P	L	\$
7 1/2"	1 3/4"	94 1/2"	\$85.48

URN: CHA07X01HA



H	P	L	\$
7 1/2"	1 3/4"	94 1/2"	\$85.48

FEDERAL: CHA07X01UR



H	P	L	\$
7 1/2"	1 3/4"	94 1/2"	\$85.48

ALEXA: PML07X02AX



H	P	L	\$
7 1/2"	1 3/4"	94 1/2"	\$71.12

ELSINORE: MLD07X01EL



H	P	L	\$
7 3/4"	1"	94 1/2"	\$49.27

ODESSA: PML07X01OD



H	P	L	\$
7 3/4"	1 1/8"	94 1/2"	\$49.86

EMERY: MLD07X01EM



H	P	L	\$
7 3/4"	1 3/8"	94 1/2"	\$68.86

ASPEN: MLD07X02AS



H	P	L	\$
7 3/4"	2 1/4"	94 1/2"	\$47.90

LISBON: CHA07X01LI



H	P	L	\$
7 7/8"	3/4"	94 1/2"	\$59.36

FLUTED: CAS08X94X01



H	P	L	\$
7 7/8"	1 1/8"	94 1/2"	\$49.35

ALEXA: MLD07X01AX



H	P	L	\$
7 7/8"	1 3/8"	94 1/2"	\$56.99

TEMPLE: MLD07X01TE



H	P	L	\$
7 7/8"	1 3/8"	94 1/2"	\$53.42

BRADFORD: MLD07X01BR



H	P	L	\$
7 7/8"	1 7/8"	94 1/2"	\$56.99

STANDARD: MLD08X05ST



H	P	L	\$
7 7/8"	5 1/8"	94 1/2"	\$148.40

DUBLIN: PML08X01DU



H	P	L	\$
8 1/4"	1 1/2"	94 1/2"	\$59.95

BEDFORD: PML08X02BE



H	P	L	\$
8 5/8"	2 1/2"	94 1/2"	\$78.78

WAKEFIELD: PML09X02WA



H	P	L	\$
9 3/8"	1 3/4"	94 1/2"	\$80.73

HEIGHT
PROJECTION
LENGTH

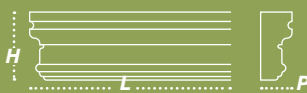

PANELMOULDING

DENTIL: PML09X03DE



H	P	L	\$
9 3/8"	3 1/8"	94 1/2"	\$174.52

REEDED: CAS10X79X01



H	P	L	\$
9 1/2"	1 3/8"	78 3/4"	\$73.69

STANDARD: MLD10X06ST



H	P	L	\$
9 5/8"	6 1/8"	94 1/2"	\$232.69

HAMILTON: PML10X02HM



H	P	L	\$
9 7/8"	1 5/8"	94 1/2"	\$68.86

BEDFORD: MLD11X02BE



H	P	L	\$
11 1/4"	1 7/8"	94 1/2"	\$172.14

STANDARD: MLD12X04ST

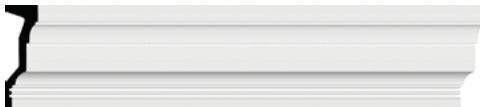

H	P	L	\$
11 7/8"	3 1/2"	94 1/2"	\$166.21

STANDARD: MLD14X04ST

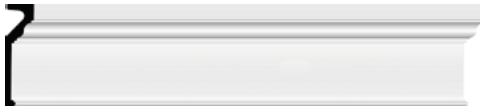

H	P	L	\$
13 3/4"	3 1/2"	94 1/2"	\$207.76

FLUTED: CAS13X79X01



H	P	L	\$
12 5/8"	1 1/8"	78 3/4"	\$86.07

STANDARD: PML13X04ST



H	P	L	\$
12 7/8"	3 5/8"	94 1/2"	\$185.80

VICTORIAN: CAS15X79X02



H	P	L	\$
15"	1 7/8"	78 3/4"	\$102.10

REEDED: CAS18X94X02



H	P	L	\$
17 3/4"	1 1/2"	94 1/2"	\$162.94





URETHANE PANEL MOULDING SYSTEMS

Our beautiful panel moulding and corners add a decorative, historic feel to walls, ceilings, and furniture pieces. Made from high-density urethane, each piece has crisp details that mimic traditional plaster and wood, providing a professional look at a fraction of the price. Completely transform a room in hours by using panel moulding systems to create an accent wall, add intricate wainscot paneling, or creating wall paneling that matches your crown and base moulding. Our moulding systems are a breeze to install and make you look like a pro.

HEIGHT
PROJECTION
LENGTH
WIDTH



PANEL MOULDING SYSTEMS

TRADITIONAL: PML00X00TR



H 3/4" **P** 3/8" **L** 94" **\$** \$9.50



PML03X03TR \$4.95 **PML04X04TR** \$6.65 **PML05X05TR** \$5.75



PML06X06TR \$7.50 **PML08X08TR** \$8.27 **PML10X10TR** \$9.78

H W H W H W
6" 6" 8" 8" 10" 10"

BRADFORD: PML01X01BR



H 7/8" **P** 5/8" **L** 94 1/2" **\$** \$10.69



PML04X04BR \$6.71 **PML04X05BR** \$6.71 **PML05X05BR** \$6.71



PML06X06BR \$6.71

H W H W H W
6 1/2" 6 1/2"

★ CLASSIC: PML00X00CL



H 7/8" **P** 1/2" **L** 94 1/2" **\$** \$9.50



PML03X03WA \$5.87 **PML05X05CL** \$7.01 **PML06X06CL** \$7.60



PML08X08CL-2 \$8.35 **PML10X10CL** \$9.97

H W H W H W
8" 8" 10" 10"

★ SEVILLE: PML01X00SE



H 1 1/2" **P** 3/4" **L** 94 1/2" **\$** \$11.87



PML04X04SE \$6.65 **PML08X08SE-2** \$8.54 **PML10X10SE-1** \$8.61



PML08X08SE \$6.79 **PML05X05SE** \$8.54 **PML06X06SE-2** \$7.60



PML10X10SE \$8.99 **PML12X12SE** \$12.35

H W H W H W
10 1/2" 10 1/2" 12" 12"

POMPEII: PML02X00PO



H 2 1/2" **P** 3/4" **L** 94 1/2" **\$** \$15.43



PML08X08PO \$10.45 **PML10X10PM-2** \$11.86 **PML12X12PO** \$13.20



PML10X10PM \$16.32 **PML11X11PM** \$13.22



PML13X10PM-L \$12.27 **PML13X10PM-R** \$12.27

H W H W H W
10 5/8" 10 5/8" 11 3/4" 11 3/4" 10 5/8" 13 1/4"

★ OXFORD: PML02X00OX



H 2" **P** 5/8" **L** 94 1/2" **\$** \$13.06



PML14X04OX \$14.84 **PML06X06OX** \$8.45 **PML08X08OX** \$8.47



PML10X10OX \$12.35 **PML10X10OX-2** \$11.40 **PML12X12OX-2** \$13.39



H W H W H W
10" 10" 10" 10" 12" 12"

BEDFORD: PML02X01BE



H	P	L	\$
2 5/8"	1 1/8"	94"	\$18.40



\$15.87	\$32.03	\$19.75
---------	---------	---------

H	W	H	W	H	W
15 1/8"	15 1/8"	16 1/2"	16 1/2"	17 3/4"	17 3/4"



\$38.02

PML19X19BE
H W
19 5/8" 19 5/8"

BULWARK: MLD01X00BU



H	P	L	\$
1"	5/8"	94 1/2"	\$10.69



\$7.71	\$7.60	\$8.54
--------	--------	--------

H	W	H	W	H	W
4"	4"	6"	6"	8"	8"



\$10.45

PML10X10BU
H W
10" 10"

NEXUS: PML01X00NE



H	P	L	\$
1 1/4"	1/2"	94 1/2"	\$10.69



\$7.80	\$7.79	\$22.07
--------	--------	---------

H	W	H	W	H	W
4"	4"	6"	6"	6 1/2"	6 1/2"



\$8.83	\$11.67	\$22.07
--------	---------	---------

H	W	H	W	H	W
8"	8"	8 1/2"	8 1/2"	11"	11"

DEVON: PML02X00DE



H	P	L	\$
2"	7/8"	94 1/2"	\$15.43



\$11.59	\$16.99	\$13.96
---------	---------	---------

H	W	H	W	H	W
8"	8"	9"	9"	10"	10"

HILLSBOROUGH: PML01X01HI



H	P	L	\$
1 3/4"	5/8"	94 1/2"	\$16.62



\$12.78	\$12.78	\$21.33
---------	---------	---------

H	W	H	W	H	W
11"	7"	11"	7"	15"	15"

LOERA: PML02X00LO



H	P	L	\$
2 1/4"	3/4"	94 1/2"	\$15.31



\$53.30

PML28X28LO
H W
28" 28"

ABERDEEN: PML01X00AB



H	P	L	\$
1 1/2"	3/4"	94 1/4"	\$13.65



\$15.87	\$15.87
---------	---------

H	W	H	W
8 1/4"	8 1/8"	11 1/4"	11 1/4"

ACANTHUS: PML02X00AC



H	P	L	\$
2 1/2"	1/2"	94 1/2"	\$15.43



\$14.87	\$11.19
---------	---------

H	W	H	W
9 3/8"	9 3/8"	10 7/8"	10 7/8"

FOSTER: PML02X00FO



H	P	L	\$
2 3/8"	3/4"	94 1/2"	\$14.25



\$14.78	\$10.49
---------	---------

H	W	H	W
10 1/4"	10 1/4"	10 1/4"	10 1/4"



STOCKPORT: PML01X00ST



H	P	L	\$
1 1/4"	5/8"	94 1/2"	\$10.69



H	W	H	W	H	W
4"	4"	6 5/8"	6 5/8"	8"	8"



H	W	H	W
10"	10"	12"	12"

★ SWINDON: PML01X00SW



H	P	L	\$
1 5/8"	1/2"	94 1/2"	\$11.87



H	W	H	W	H	W
6"	6"	7 3/4"	7 3/4"	10"	10"

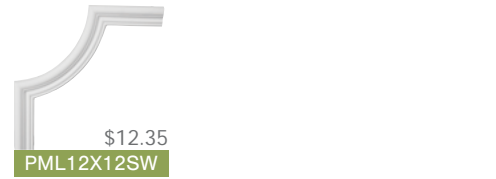

H	W
12"	12"

★ RAYMOND: PML02X00RA



H	P	L	\$
2"	5/8"	94 1/2"	\$13.65



H	W	H	W	H	W
8"	8"	10"	10"	10 1/4"	10 1/4"



H	W	H	W
12"	12"	12 7/8"	12 7/8"

ACANTHUS: PML01X01AC



H	P	L	\$
1 3/4"	1 1/8"	94 1/2"	\$14.25



H	W	H	W	H	W
6"	6"	8 7/8"	8 7/8"	12"	12"

CAPUTO: PML03X00CA



H	P	L	\$
3 1/8"	3/4"	94 1/2"	\$18.40



H	W	H	W	H	W
12"	12"	16 1/8"	16 1/8"	19 7/8"	19 7/8"

TIRANA: PML01X00TI



H	P	L	\$
1 3/4"	3/4"	94 1/2"	\$14.25



H	W	H	W	H	W
14 1/4"	14 1/4"	18 1/8"	16 1/2"	18 1/8"	16 1/2"

DUBLIN: PML01X01DU



H	P	L	\$
1 3/8"	3/4"	94 1/2"	\$16.62



H	W	H	W
7 7/8"	7 7/8"	9 1/2"	9 1/2"

CLAREMONT: PML01X00CL



H	P	L	\$
1 3/4"	1/2"	94 1/2"	\$11.87



H	W	H	W
8 3/4"	8 3/4"	12 1/2"	12 1/2"

EDINBURGH: PML03X01ED



H	P	L	\$
3"	1 1/8"	94 1/4"	\$26.12



H	W	H	W
14 3/8"	14 3/8"	16 1/4"	16 1/4"

JACKSON: PML01X00JA



H	P	L	\$
1 5/8"	3/4"	94 1/2"	\$11.87



H	W	H	W	H	W
6"	6"	9"	9"	10"	10"



H	W	H	W
11 3/4"	11 3/8"	12"	12"

KENDALL: PML01X00KD



H	P	L	\$
1 5/8"	3/4"	94 1/2"	\$11.87



H	W	H	W	H	W
4"	4"	9"	9"	9"	9"



H	W	H	W
13 1/2"	13 1/2"	13 1/2"	13 1/2"

SUSSEX: PML02X00SU



H	P	L	\$
2"	1 7/8"	94 1/2"	\$14.25



H	W	H	W	H	W
6"	6"	8"	8"	10"	10"



H	W
10 3/4"	10 3/4"

LANARKSHIRE: PML01X00LA



H	P	L	\$
1 3/4"	5/8"	94 1/2"	\$13.06



H	W
11 3/4"	11 3/4"

MIDDLESBOROUGH: PML01X00MD



H	P	L	\$
1 1/4"	3/8"	94 1/2"	\$10.69



H	W
8 3/8"	8 3/8"

EMERY: PML03X00EM



H	P	L	\$
3 1/8"	3/4"	94 1/2"	\$19.00



H	W
12"	12"

SELLEK: PML01X01SK



H	P	L	\$
1 3/4"	1"	94 1/2"	\$14.71



H	W
11 1/8"	11 1/8"

ARTIS: PML01X00AR



H	P	L	\$
1 7/8"	3/4"	94 1/2"	\$14.71



H	W
13"	13"

VALERIANO: PML02X00VA



H	P	L	\$
2"	3/4"	94 1/2"	\$14.25



H	W
9 3/8"	9 3/8"

HEIGHT
PROJECTION
LENGTH
WIDTH



PANEL MOULDING SYSTEMS

★ ASHFORD: PML01X00AS



H	P	L	\$
1 5/8"	1/2"	94 1/2"	\$11.87



H	W	H	W
4"	4"	4 1/4"	9 1/4"



H	W	H	W	H	W
6 1/8"	6 1/8"	7 7/8"	7 7/8"	8"	8"



H	W	H	W	H	W
8"	8"	8 1/4"	8 1/4"	9"	8 3/4"



H	W	H	W	H	W
9"	9"	10"	10"	12"	12"

MILTON: PML02X00MI



H	P	L	\$
2 1/4"	3/4"	94 1/2"	\$14.25



H	W	H	W	H	W
6"	6"	9 3/4"	9 3/4"	10"	10"



H	W	H	W
10"	10"	12 3/4"	12 3/4"

ERIS: PML01X00ER



H	P	L	\$
1 5/8"	3/4"	94 1/2"	\$17.21



H	W
3 3/8"	3 3/8"

EMERY: PML02X01EM



H	P	L	\$
2 1/8"	7/8"	94 1/2"	\$17.36



H	W	H	W
10 5/8"	10 5/8"	15 3/4"	15 3/4"

DUBLIN: MLD04X01DU



H	P	L	\$
4"	1 1/8"	94 1/2"	\$27.31



H	W
11 3/4"	11 3/4"

★ ODESSA: PML00X00OD



H	P	L	\$
7/8"	3/8"	94 1/2"	\$9.50



H	W
8 1/4"	8 1/4"

KEPLER: PML01X01KP



H	P	L	\$
1 1/8"	1/2"	94 1/2"	\$12.47



H	W
11"	11"



**MIX & MATCH
TO CREATE
UNIQUE WALLS**

BEDFORD FASCIA: CAS08X01CL



H	P	L	\$
7 3/4"	1 1/4"	49 7/8"	\$33.60

BEDFORD FASCIA: CAS11X02DN



H	P	L	\$
10 1/2"	2 3/8"	49 7/8"	\$56.00

BEDFORD FASCIA: CAS12X02LU



H	P	L	\$
11 3/4"	2 3/8"	49 7/8"	\$56.00

BEDFORD: CHA04X01BE



H	P	L	\$
3 5/8"	1 1/4"	94 1/2"	\$25.76



ASHFORD TRADITIONAL: CAS05X02AS



H	P	L	\$
5 7/8"	1 3/4"	96 5/8"	\$73.00

ASHFORD FLOWER: CAS07X02AS



H	P	L	\$
6"	2 1/2"	96 5/8"	\$81.80

ASHFORD SHELL: CAS06X02AS



H	P	L	\$
6"	2 1/2"	96 5/8"	\$81.80

ASHFORD: CAS06X01AS



H	P	L	\$
6"	1 3/8"	96 1/8"	\$54.99

HEIGHT
PROJECTION
LENGTH
WIDTH



PANEL MOULDING SYSTEMS

EDWARDS TRADITIONAL: CAS09X02ED



H	P	L	\$
9 1/8"	2 1/4"	97 1/4"	\$82.66

EDWARDS SHELL: CAS10X03ED



H	P	L	\$
9 5/8"	2 3/4"	96 1/2"	\$82.66

EDWARDS FLOWER: CAS11X02ED



H	P	L	\$
11 1/8"	2 1/4"	94 1/2"	\$80.30

EDWARDS: CAS04X01ED

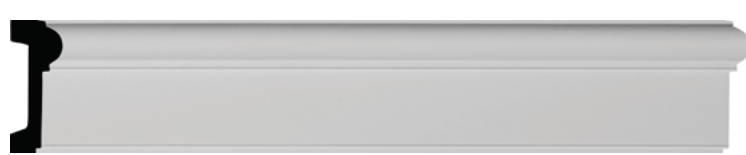

H	P	L	\$
3 3/4"	1 1/4"	96 1/4"	\$29.46



**SHIPS OUT IN
24-72 HOURS**

BRADFORD TRADITIONAL: CAS04X02BR



H	P	L	\$
5"	1 1/2"	96 5/8"	\$65.10

BRADFORD SHELL: CAS05X02BR



H	P	L	\$
4 7/8"	1 3/4"	96 5/8"	\$65.10

BRADFORD FLOWER: CAS05X01BR



H	P	L	\$
5 1/4"	1 3/8"	96 5/8"	\$63.00

BRADFORD: CAS04X01BR

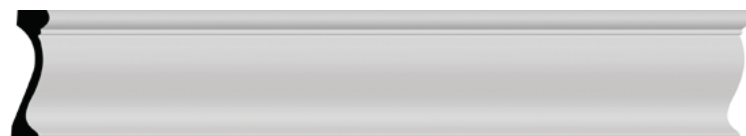

H	P	L	\$
4 7/8"	1"	96 1/8"	\$47.04



URETHANE BASEBOARD

Traditional detailing with baseboard provides a timeless and elegant look in any room. Baseboard moulding is a practical way to hide unsightly gaps between the floor and wall and adds a beautiful finishing touch. Available in classic and contemporary patterns in a wide range of pre-primed profiles.

Proving to be a durable alternative to traditional materials, urethane baseboards will not rot, warp or crack, and are impervious to insect infestations. Urethane baseboards are a worthwhile investment with minimal upkeep that complements other moulding types for a balanced look.

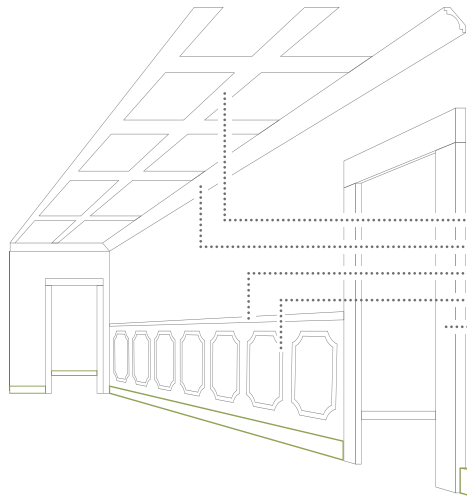

Baseboard compliments other features, such as crown moulding, door & window trim, wainscot paneling, chair rail and coffered ceilings.

- Coffered Ceilings
- Crown Moulding
- Chair Rail
- Wainscot Paneling
- Door & Window Trim

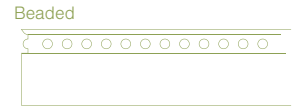
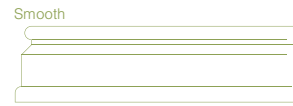
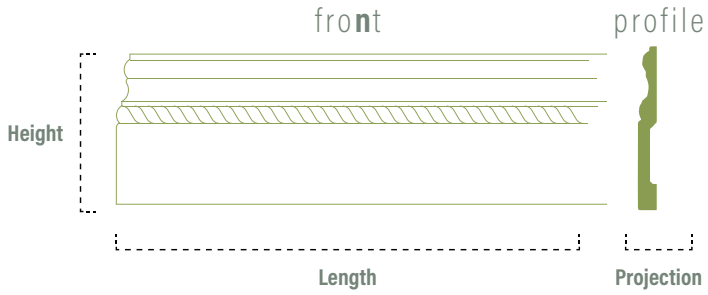

ABERDEEN: BBD03X00AB



H	P	L	\$
3 3/4"	1/2"	94 1/2"	\$27.77

ASHFORD: BBD03X00AS



H	P	L	\$
3 7/8"	1/2"	94 1/2"	\$28.37

BARCELONA: BBD03X00BA



H	P	L	\$
3 7/8"	1/2"	94 1/2"	\$23.74

HOLMDEL: BBD03X00HO



H	P	L	\$
3 7/8"	5/8"	94 1/2"	\$23.74

BARCELONA: BBD04X01BA



H	P	L	\$
4"	3/8"	94 1/2"	\$22.56

SUSSEX: BBD04X00SU

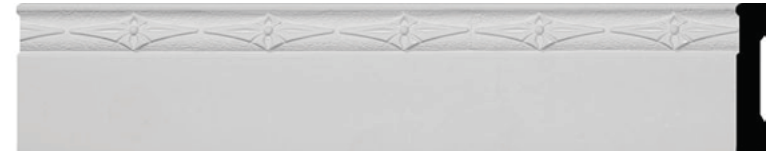

H	P	L	\$
4"	5/8"	94 1/2"	\$27.18

BARCELONA: BBD04X00BA



H	P	L	\$
4"	1/2"	94 1/2"	\$24.93

KEPLER: BBD05X03KP



H	P	L	\$
4 1/2"	1/2"	94 1/2"	\$29.68

OSLO: BBD04X01OS



H	P	L	\$
4 1/2"	5/8"	94 1/2"	\$30.74

BRADFORD: BBD04X00BR



H	P	L	\$
4 3/4"	1/2"	94 1/2"	\$32.52

HEIGHT
LENGTH
PROJECTION



BASEBOARD

OSLO: BBD04X00OS



H	P	L	\$
4 7/8"	5/8"	94 1/2"	\$26.12



CLASSIC: BBD05X01CL



H	P	L	\$
5"	3/4"	94 1/2"	\$45.11

ABERDEEN: BBD05X00AB



H	P	L	\$
5 1/2"	5/8"	94 1/2"	\$38.92

REMINGTON: BBD05X00RE

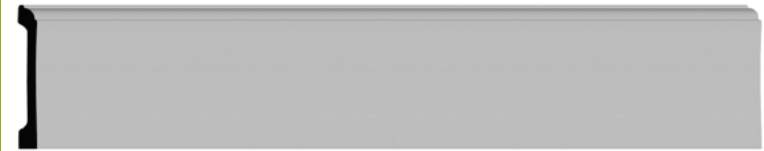

H	P	L	\$
5 7/8"	5/8"	94 1/2"	\$36.80

BRADFORD: BBD05X00BR



H	P	L	\$
5 7/8"	5/8"	94 1/2"	\$40.70

OSLO: BBD06X01OS



H	P	L	\$
6"	5/8"	94 1/2"	\$37.99

MITER-FREE BASEBOARD

FEDERAL: BBD06X01FE



H	P	L	\$
5 7/8"	3/4"	94 1/2"	\$45.11



HILLSBOROUGH: BBD07X01HI



H	P	L	\$
7 3/8"	1"	94 1/2"	\$72.42



BBD06X04FE
Inside Corner
\$7.12



BBD06X03FE
Outside Corner
\$9.50



BBD07X04HI
Inside Corner
\$14.25



BBD07X05HI
Outside Corner
\$16.62



URETHANE WAINSCOT PANELING

Save time and money with preassembled panels for a traditional wainscot look, without the hassle of measuring, cutting and assembling individual moulding pieces. Made of solid polyurethane for maximum durability and detail for a lasting upgrade to any home.

The panels are lightweight for quick and easy installation and factory primed ready for paint or faux finish. Easily attaches to furniture, doors and walls for an elegant finished look. Achieve an opulent custom space by pairing the panels with coordinating crown molding, baseboard, and door and window casing for a more balanced style.

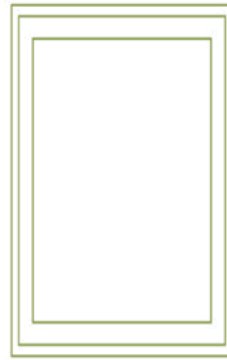

Designer Styles available in several classic designs and multiple sizes for convenient ordering, saving time and money.

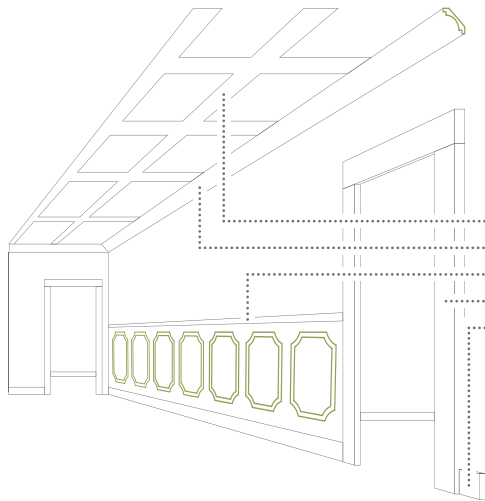





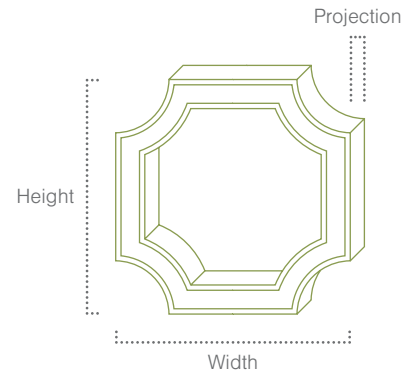























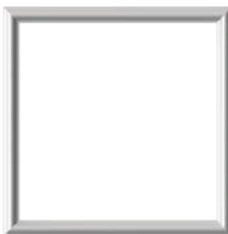

Wainscot Paneling is complimented by other features, such as crown moulding, baseboard, door & window trim, chair rail and coffered ceilings.

- Coffered Ceilings
- Crown Moulding
- Chair Rail
- Door & Window Trim
- Baseboard



ASHFORD TRADITIONAL PANEL FRAMES

	8"	12"	16"	20"	24"	28"			
8"	 PNL08X08AS-01 \$7.83	 PNL08X12AS-01 \$9.14	 PNL08X16AS-01 \$13.06	 PNL08X20AS-01 \$14.36	 PNL08X24AS-01 \$16.98	 PNL08X28AS-01 \$18.29			
12"	 PNL08X12AS-01 \$9.14	<p>SIZES TO MAKE ANY SPACE WORK</p>			 PNL12X20AS-01 \$15.67	 PNL12X24AS-01 \$18.29	 PNL12X28AS-01 \$19.59		
16"	 PNL08X16AS-01 \$13.06				 PNL16X20AS-01 \$17.63	 PNL16X24AS-01 \$19.59	 PNL16X28AS-01 \$20.89		
20"	 PNL08X20AS-01 \$14.36				 PNL12X20AS-01 \$15.67	 PNL16X20AS-02 \$18.93	 PNL20X20AS-01 \$19.59	 PNL20X24AS-01 \$20.89	 PNL20X28AS-01 \$23.51
24"	 PNL08X24AS-01 \$16.98				 PNL12X24AS-01 \$18.29	 PNL16X24AS-01 \$19.59	 PNL20X24AS-01 \$20.89	 PNL24X24AS-01 \$23.51	 PNL24X28AS-01 \$24.81
28"	 PNL08X28AS-01 \$18.29				 PNL12X28AS-01 \$19.59	 PNL16X28AS-01 \$20.89	 PNL20X28AS-01 \$23.51	 PNL24X28AS-01 \$24.81	

ASHFORD: PML01X00AS









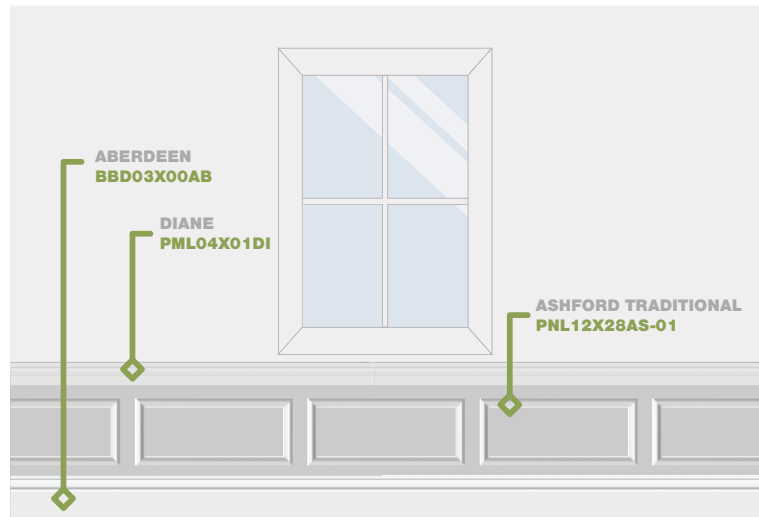
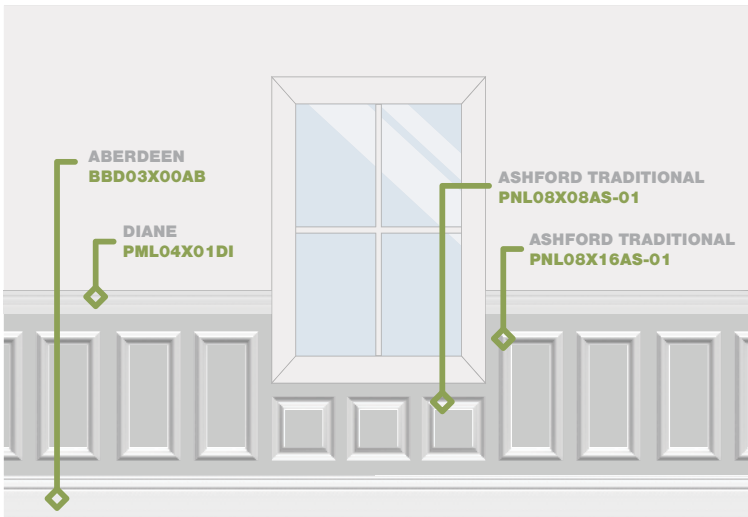
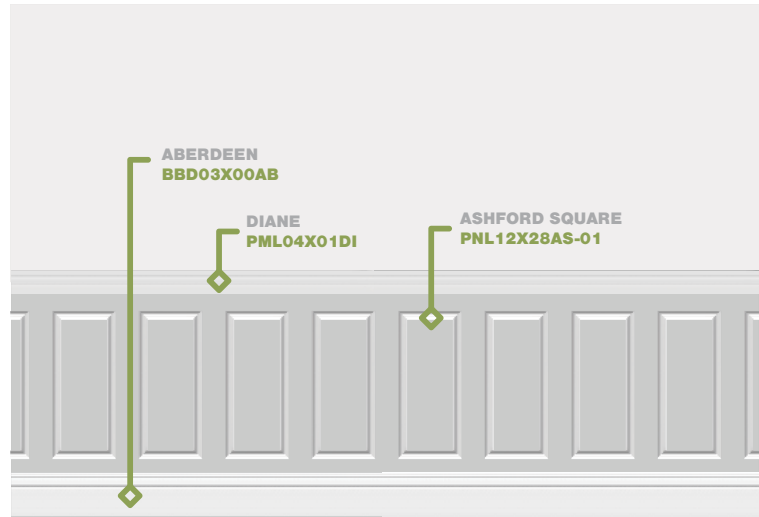
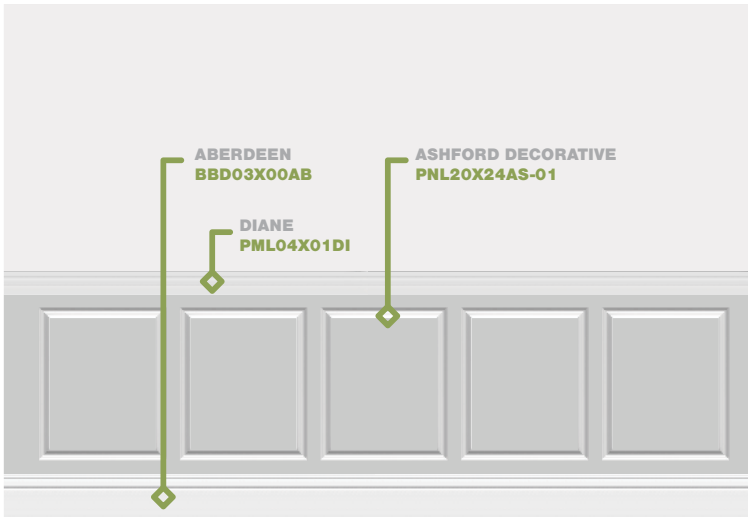























H P L S
1 5/8" 1/2" 94 1/2" \$11.87

A PERFECT MATCH

These square panels match the Ashford panel moulding, making it easy to match, and fabricate these panels to fit any project perfectly.



ASHFORD DECORATIVE PANEL FRAMES

	8"	12"	16"	20"	24"	28"		
8"	 PNL08X08AS-02 \$7.83	 PNL08X12AS-02 \$9.14	 PNL08X16AS-02 \$13.06	 PNL08X20AS-02 \$15.67	 PNL08X24AS-02 \$18.29	 PNL08X28AS-02 \$19.59		
12"	 PNL08X12AS-02 \$9.14	<p>SIZES TO MAKE ANY WALL WORK</p>		 PNL12X20AS-02 \$16.98	 PNL12X24AS-02 \$19.59	 PNL12X28AS-02 \$20.89		
16"	 PNL08X16AS-02 \$13.06			 PNL16X20AS-02 \$18.93	 PNL16X24AS-02 \$20.89	 PNL16X28AS-02 \$22.20		
20"	 PNL08X20AS-02 \$15.67			 PNL12X20AS-02 \$16.98	 PNL16X20AS-02 \$18.93	 PNL20X20AS-02 \$20.89	 PNL20X24AS-02 \$22.20	 PNL20X28AS-02 \$26.12
24"	 PNL08X24AS-02 \$18.29			 PNL12X24AS-02 \$19.59	 PNL16X24AS-02 \$20.89	 PNL20X24AS-02 \$22.20	 PNL24X24AS-02 \$24.81	 PNL24X28AS-02 \$26.12
28"	 PNL08X28AS-02 \$19.59			 PNL12X28AS-02 \$20.89	 PNL16X28AS-02 \$22.20	 PNL20X28AS-02 \$26.12	 PNL24X28AS-02 \$26.12	

ASHFORD: PML01X00AS



H P L S
 1 5/8" 1/2" 94 1/2" \$11.87

A PERFECT MATCH

These square panels match the Ashford panel moulding, making it easy to match, and fabricate these panels to fit any project perfectly.

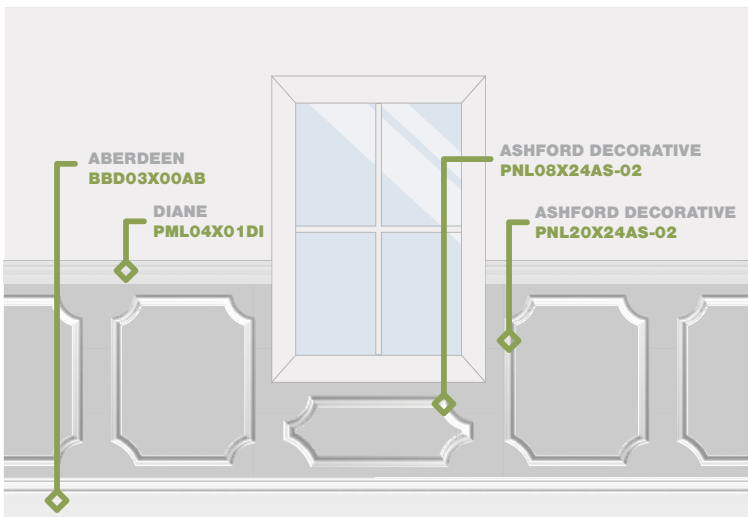
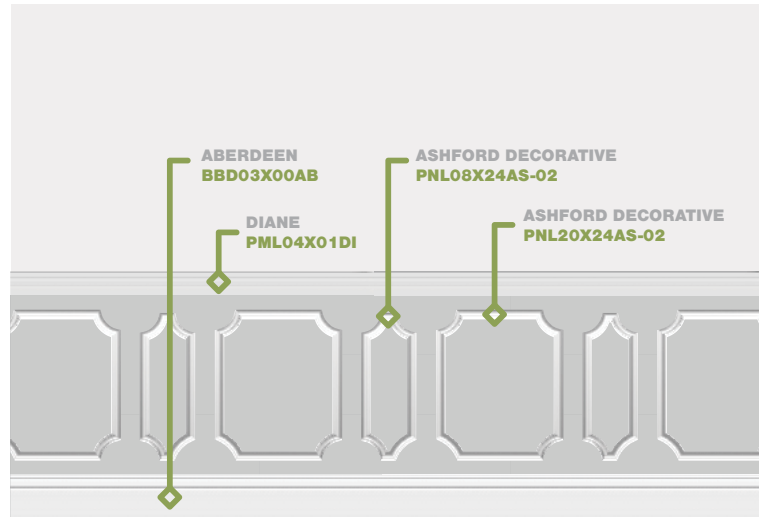
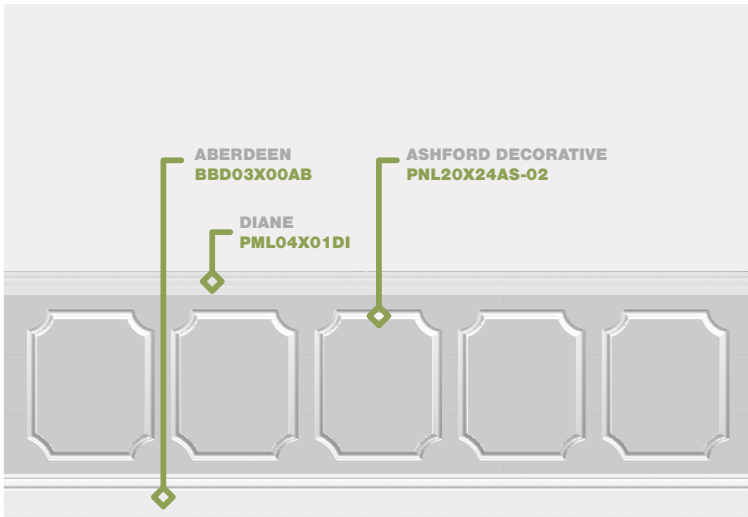

MONIQUE: PNL14X14MO

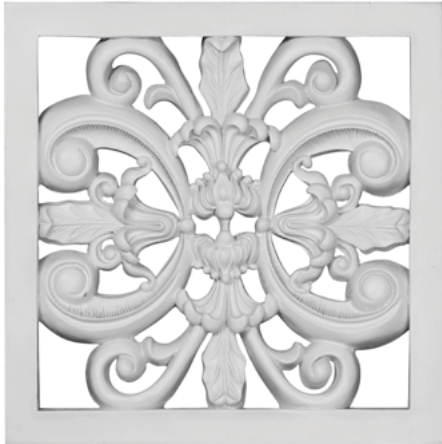

W	H	P	\$
14 1/8"	14 1/8"	1 1/8"	\$17.81

MODELED AFTER HISTORICAL PATTERNS

MODENA: PNL14X42MO



W	H	P	\$
14 1/8"	41 5/8"	1 1/8"	\$81.92

SOUTHAMPTON: PNL15X32SO



W	H	P	\$
15 1/8"	31 3/4"	1 1/4"	\$71.23

ROBIN: PNL28X77RB



W	H	P	\$
28 3/8"	77 1/8"	4 3/8"	\$682.64

SHIPS OUT IN 24-72 HOURS

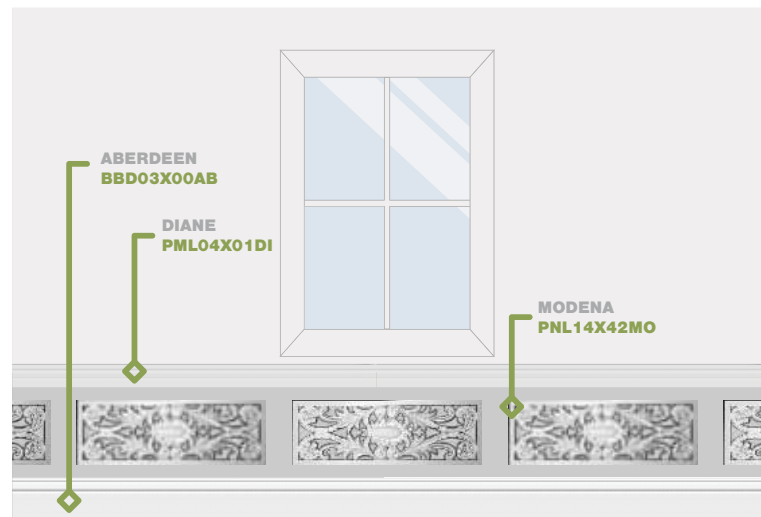
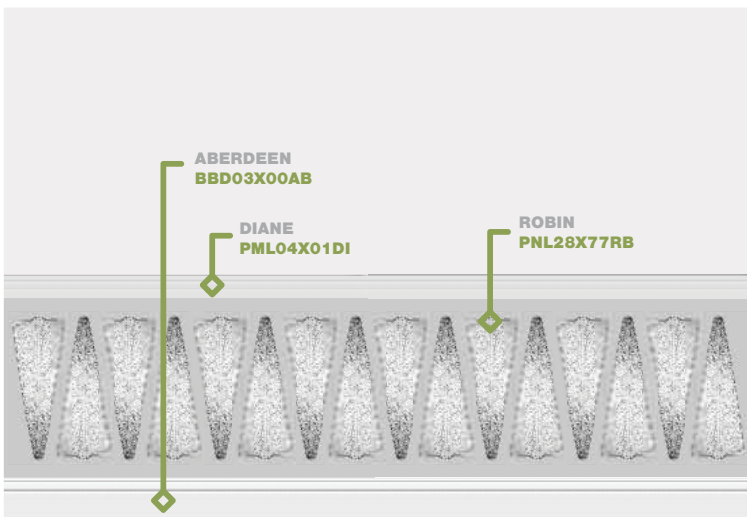
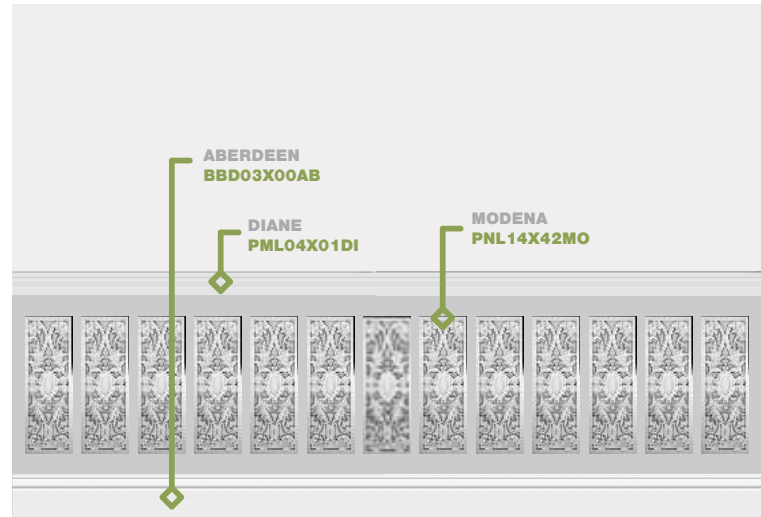
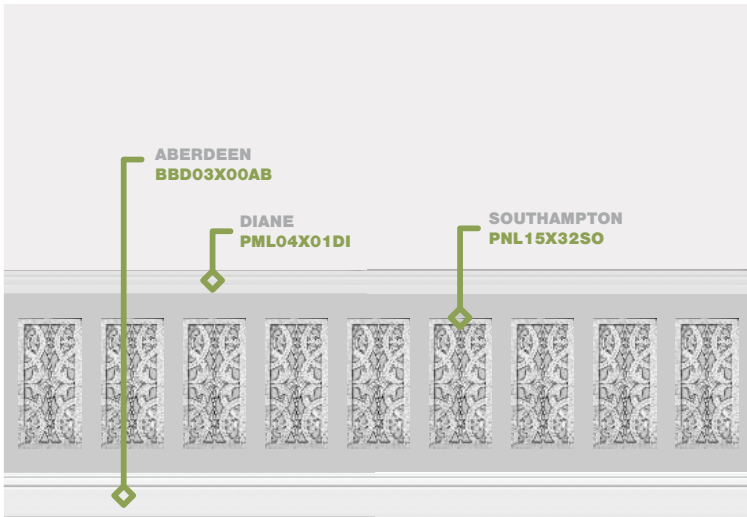

STOCKPORT PANEL FRAMES

STOCKPORT: PML05X26ST



W	H	P	\$
4 5/8"	26"	5/8"	\$21.37

STOCKPORT: PML05X34ST



W	H	P	\$
4 5/8"	34"	5/8"	\$28.49

STOCKPORT: PML07X26ST



W	H	P	\$
6 5/8"	26"	5/8"	\$23.15

STOCKPORT: PML07X34ST



W	H	P	\$
6 5/8"	34"	5/8"	\$30.27

STOCKPORT: PML09X26ST



W	H	P	\$
8 5/8"	26"	5/8"	\$24.93

STOCKPORT: PML09X34ST



W	H	P	\$
8 5/8"	34"	5/8"	\$32.05

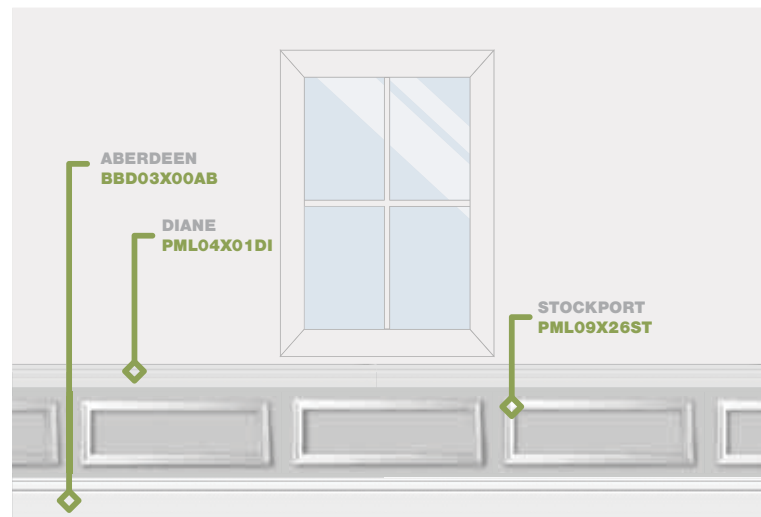
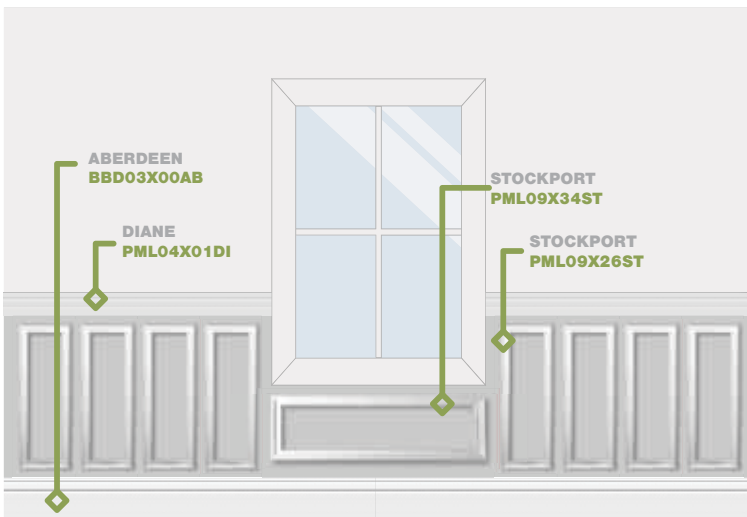
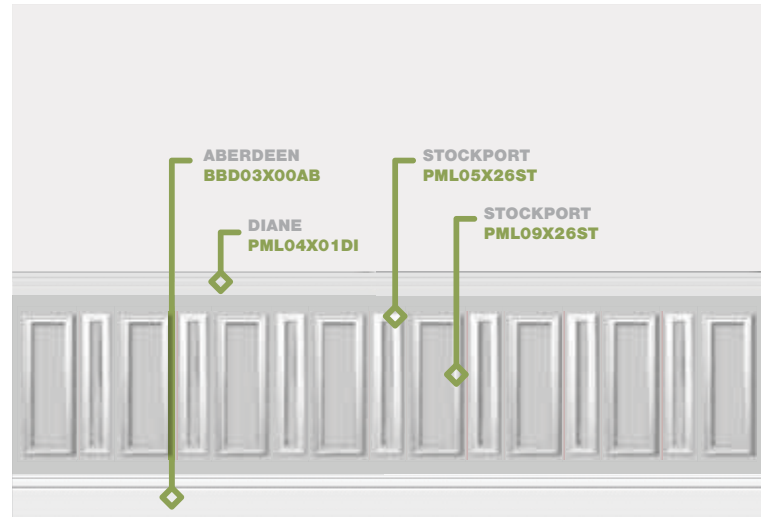
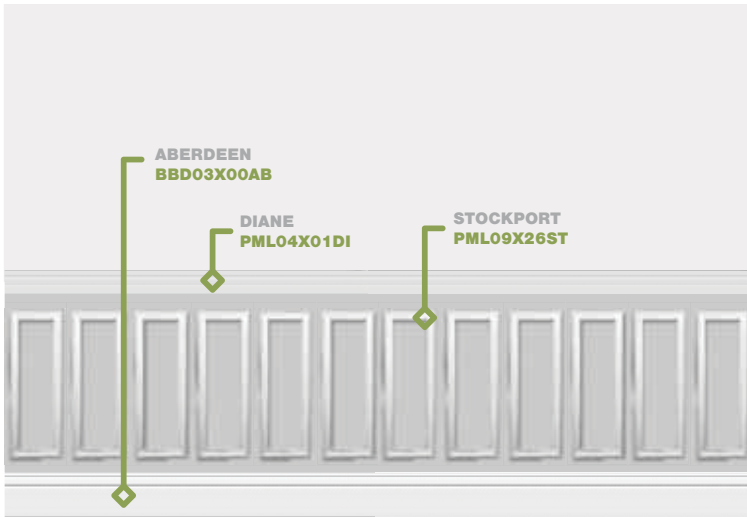

LEGACY SOLID PANELS

LEGACY: PNL22X05LE



W 4 3/4" **H** 22 5/8" **P** 5/8" **\$** \$21.49

LEGACY: PNL22X09LE



W 8 5/8" **H** 21 5/8" **P** 5/8" **\$** \$23.38

LEGACY: PNL22X22LE

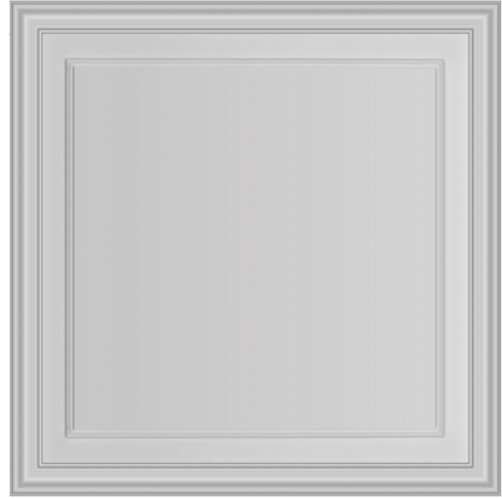

W 21 5/8" **H** 21 5/8" **P** 5/8" **\$** \$41.19

LEGACY: PNL22X30LE-1

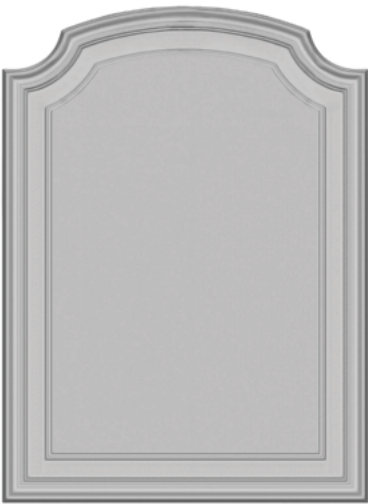

W 21 5/8" **H** 29 3/4" **P** 5/8" **\$** \$59.24

LEGACY: PNL22X36LE-1



W 21 5/8" **H** 35 5/8" **P** 5/8" **\$** \$62.92

LEGACY: PNL22X36LE-2

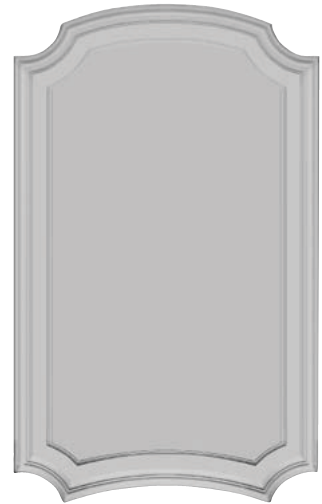

W 21 5/8" **H** 36 3/8" **P** 5/8" **\$** \$59.84

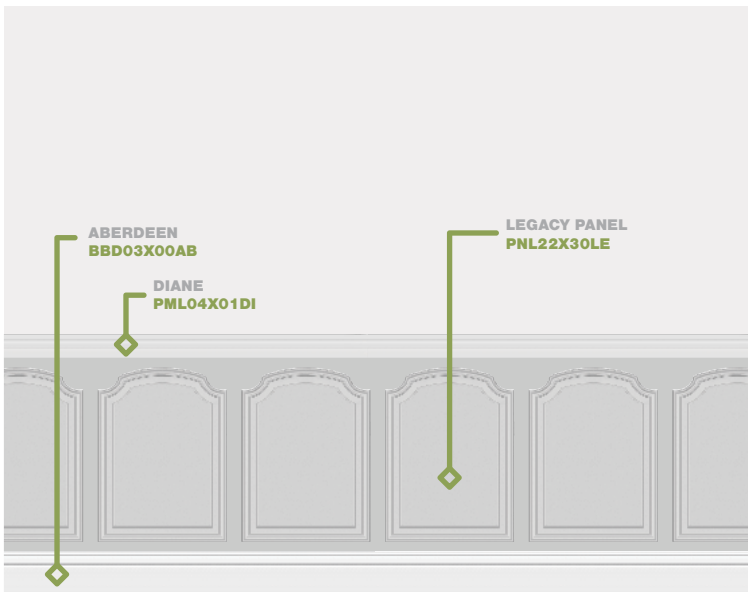
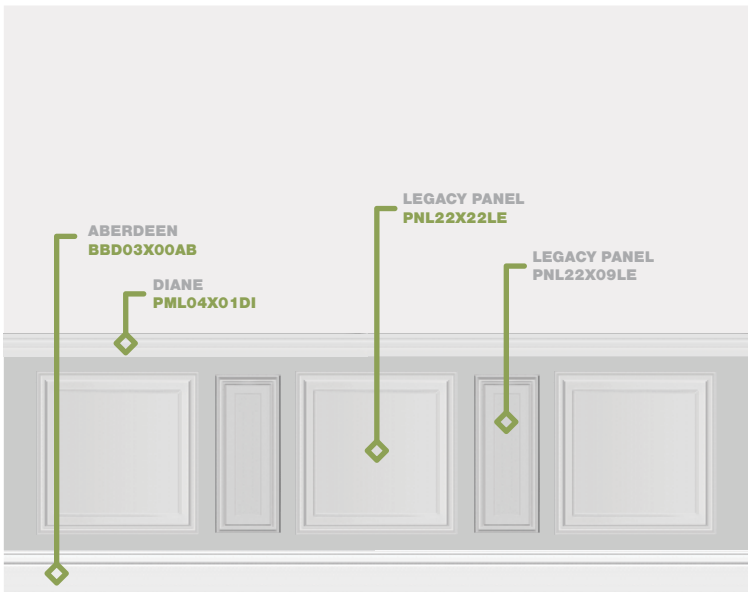
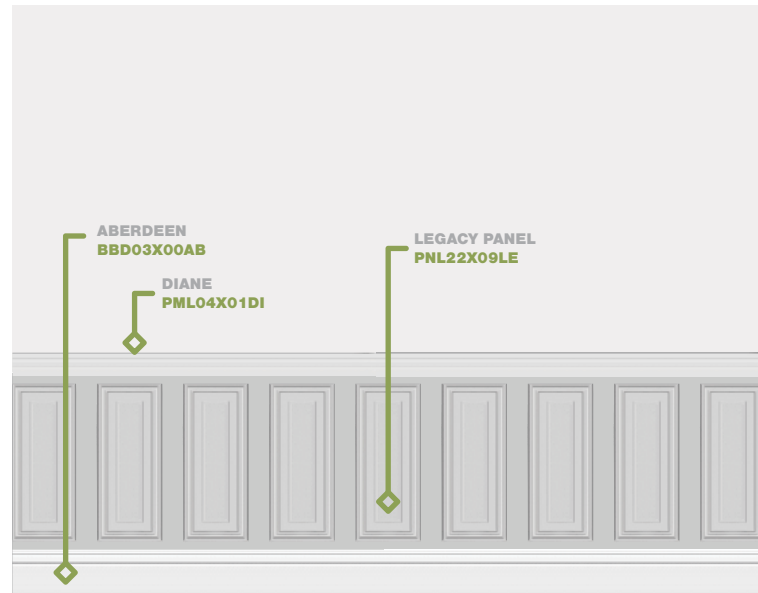
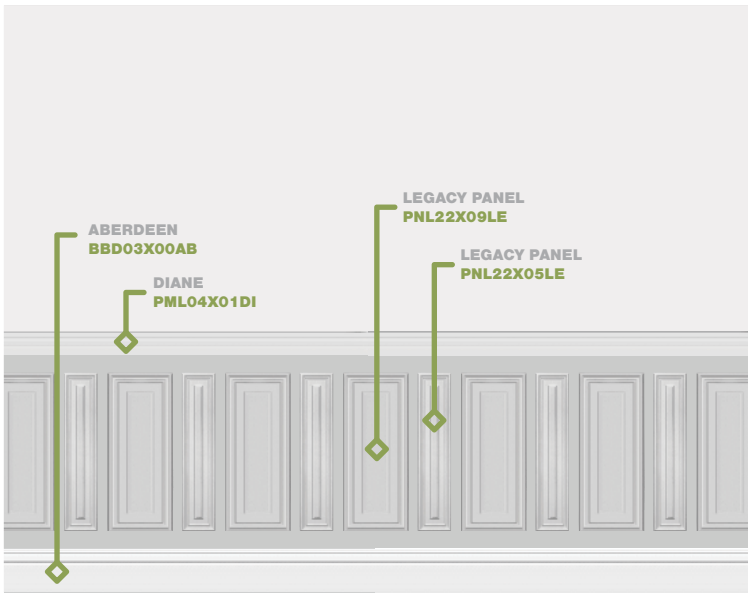



URETHANE COFFERED CEILING

Transform your ceiling into an elegant and timeless display that makes a bold statement while adding significant value to your living space. Coffered ceilings are a classic architectural design that brings out depth and dimension to an otherwise plain ceiling. Our urethane coffered ceilings are carefully modeled after original historical patterns and design, ensuring an authentic look. Compared to wood, they are much lighter weight, making for an easier install. What was once considered an expensive luxury, is now an affordable endeavor that exemplifies opulence.

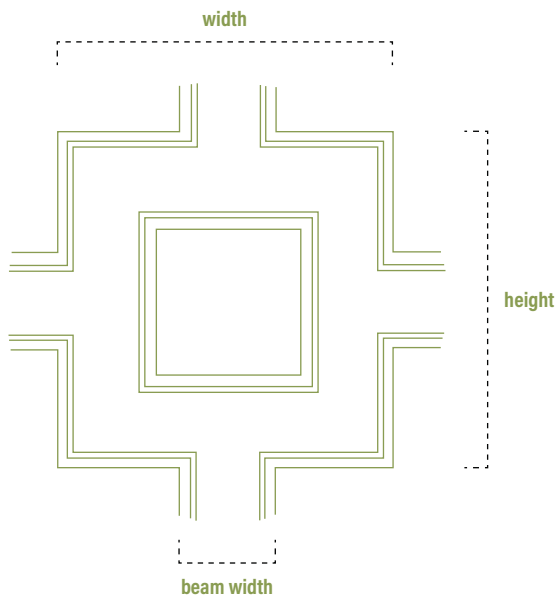

Cross

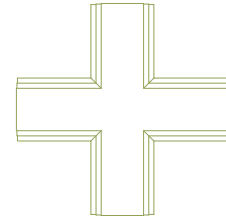

Square

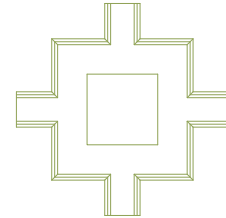

Circle

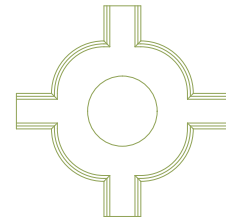

Diamond

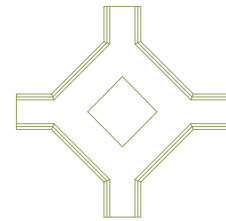

WHY CHOOSE ENDURATHANE COFFERED CEILING SYSTEM:

- Old-world custom ceiling design with the efficiency of modern material and fabrication.
- Install quicker, easier, and with greater precision.
- Do it yourself, no professional needed. Save time and money.
- Light-weight, perfect for any ceiling height.
- 8 different designs – intersections available in cross, circle, diamond and square.
- Low Maintenance. Impervious to moisture and insects.
- Available to ship within 72 hours. Need it faster? Tell us, and we will ship tomorrow!
- More cost-effective than traditional site-built wood systems.
- Architectural Bling Design Experts to assist in entire layout process.
- Simple to design. Easy to order.
- Lifetime warranty.

COFFERED CEILING SYSTEM BREAKDOWN

The Architectural Bling Coffered Ceiling System is made up of various parts. Below is a dissection of what our coffered ceiling system looks like broken down.

1. **Perimeter Corner** - Has flush back to butt up against the wall for a seamless joint.
2. **Perimeter Beam** - Has flush back & comes 96" long.
3. **Perimeter Tee** - Has flush back & extends away from the wall to connect with the inner beam or intersect pieces.
4. **Inner Beam** - Spans up to 96" & has trim detail on both sides.
5. **Intersect Piece** - Comes in four styles & eliminates the need to miter cut.
6. **Inner Tee** - Creates the opportunity to design inner patterns. Has trim details on the edges.
7. **Inner Corner** - Creates the opportunity to design inner patterns. Has trim details on the edges.

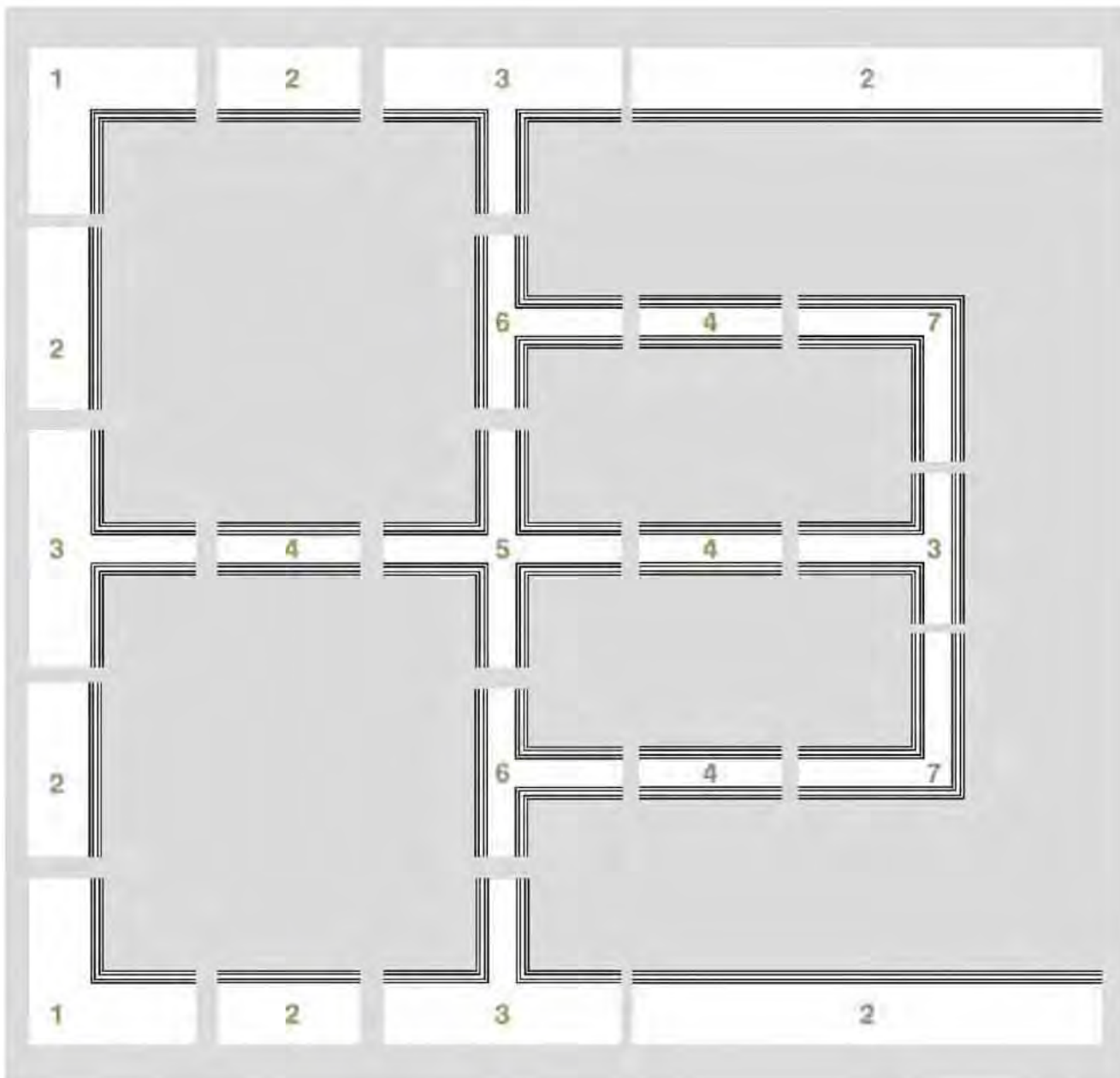

STEP BY STEP INSTRUCTIONS

When measuring your ceiling, ensure that you take into account the variations in your ceiling. We recommend measuring various points even if the measurement appears to be the same. Diagram 1 shows you dotted lines to give you a rough idea of what you should be measuring.

After measuring your ceiling, determine how many coffers you would like on your ceiling. Using that as your guide, it is recommended that you draft up a sketch like Diagram 2. Starting with your corner pieces and then working around the perimeter, determine how many tee pieces and intersects you will need. The result will be a parts list and how many pieces of inner and perimeter beams will be needed for your project.

COMPONENT LIST:

- A** 4 Corner Pieces - CC05PIC02X14X14TR
- B** 10 Perimeter Tees - CC05PTE02X14X20TR
- C** 6 Intersect Pieces - CC05ICI02X20X20TR
- D** 3 Perimeter Beams (96" Each) - CC05PBM02X06X96TR
- E** 3 Inner Beams (96" Each) - CC05IBM02X04X96TR

EXAMPLE MEASURING DIAGRAMS

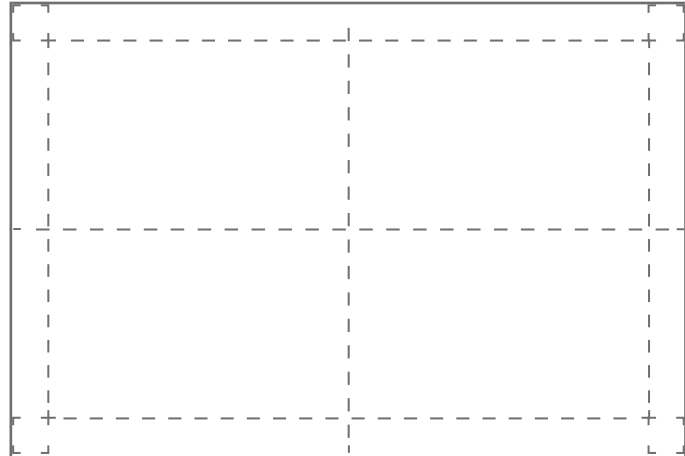

Diagram 1

TOTAL ROOM LENGTH 12'

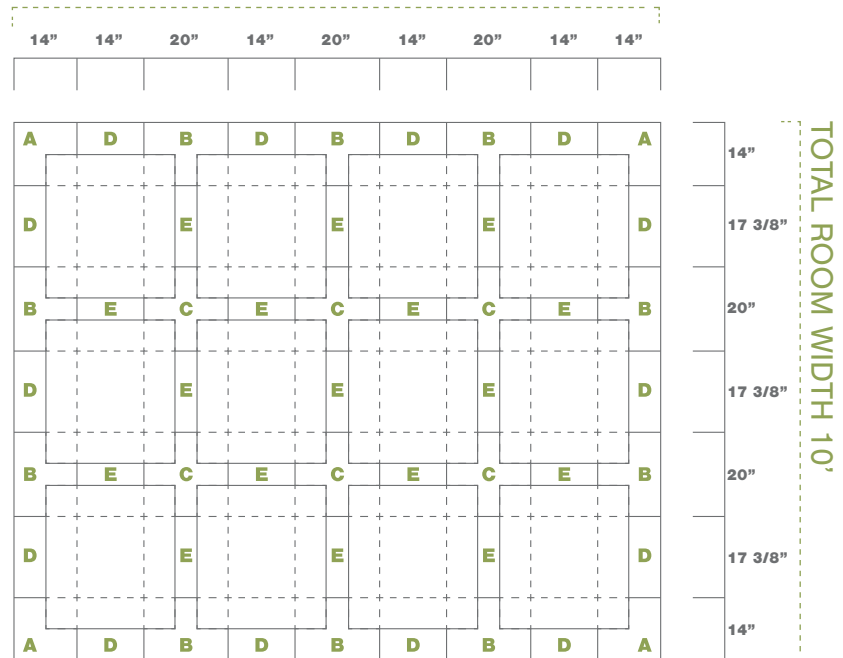

Diagram 2

SAVE TIME WITH **PERFECTLY**
EASY FIT COMPONENTS FOR A SEAMLESS INSTALL
 THAT GO TOGETHER EVERY TIME

8" DELUXE COFFERED CEILING SYSTEM

PART NO.	PIECE	W	P	L	\$
CC08IBM04X08X96DE	Inner Beam	8"	3 1/2"	96"	\$138.03
CC08ICI04X20X20DE	Inner Cross Intersection	20"	3 1/2"	20"	\$69.74
CC08ICI04X36X36DE	Inner Circle Intersection	36"	3 1/2"	36"	\$206.65
CC08ICN04X14X14DE	Inner Corner	14"	3 1/2"	14"	\$42.25
CC08IDI04X36X36DE	Inner Diamond Intersection	36"	3 1/2"	36"	\$168.25
CC08ISI04X36X36DE	Inner Square Intersection	36"	3 1/2"	36"	\$175.15
CC08ITE04X14X20DE	Inner Tee	14"	3 1/2"	20"	\$55.34
CC08PBM04X08X96DE	Perimeter Beam	8"	3 1/2"	96"	\$173.51
CC08PIC04X14X14DE	Perimeter Inside Corner	14"	3 1/2"	14"	\$56.28
CC08POC04X14X14DE	Perimeter Outside Corner	14"	3 1/2"	14"	\$51.22
CC08PTE04X14X20DE	Perimeter Tee	14"	3 1/2"	20"	\$64.89



INNER CROSS INTERSECTION



INNER SQUARE INTERSECTION



INNER DIAMOND INTERSECTION



INNER CIRCLE INTERSECTION

INNER PROFILE

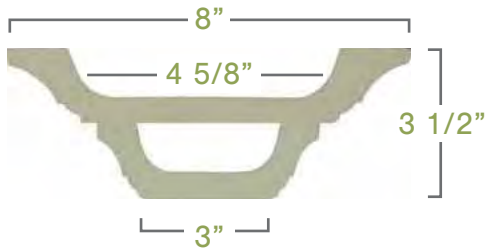

PERIMETER PROFILE

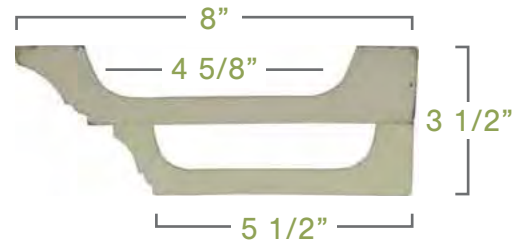

INNER BEAM



PERIMETER BEAM

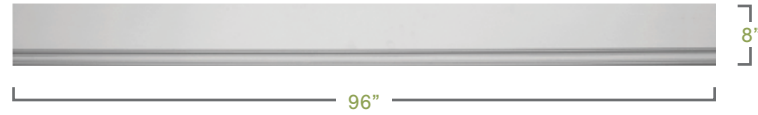

INNER CORNER



PERIMETER INSIDE CORNER

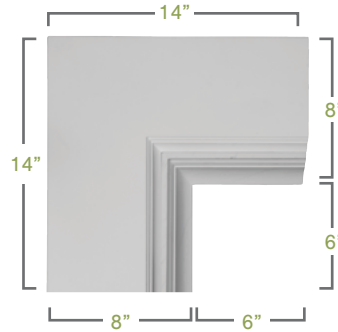

PERIMETER OUTSIDE CORNER

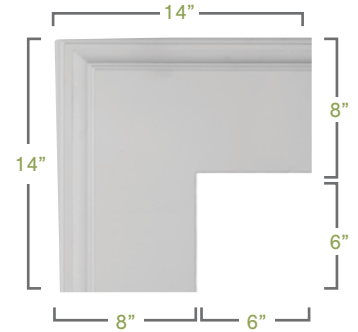

INNER TEE

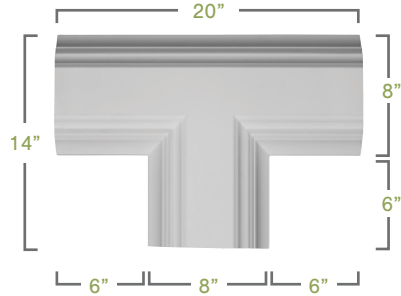

PERIMETER TEE

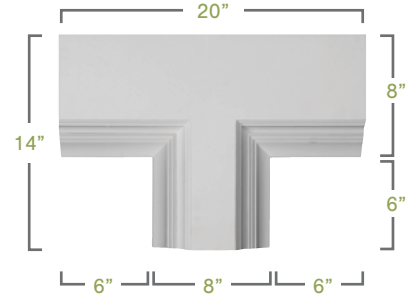

INNER CROSS INTERSECTION

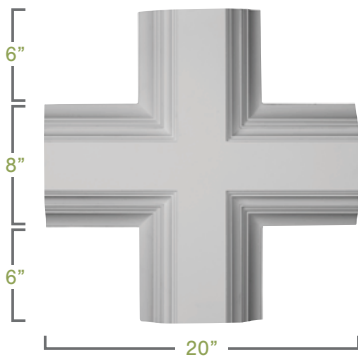

INNER CIRCLE INTERSECTION

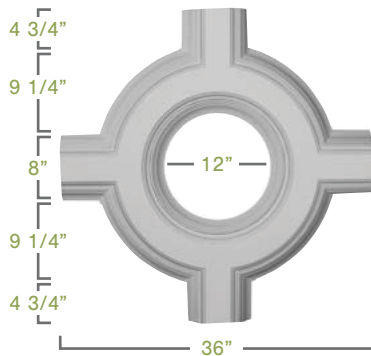

INNER DIAMOND INTERSECTION

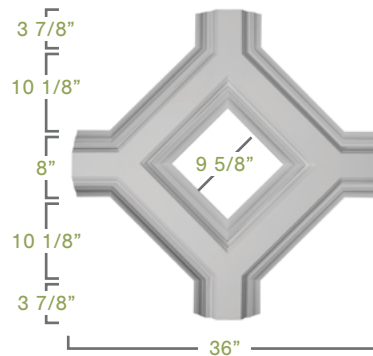

INNER SQUARE INTERSECTION

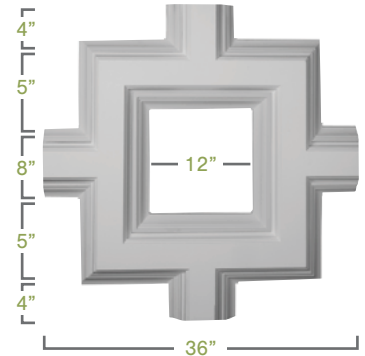

5" TRADITIONAL COFFERED CEILING SYSTEM

Part No.	Piece	W	P	L	\$
CC05IBM02X04X96TR	Inner Beam	4 1/2"	1 3/4"	96"	\$53.00
CC05ICI02X20X20TR	Inner Cross Intersection	20"	1 3/4"	20"	\$32.44
CC05ICI02X36X36TR	Inner Circle Intersection	36"	1 3/4"	36"	\$79.78
CC05ICN02X14X14TR	Inner Corner	14"	1 3/4"	14"	\$19.42
CC05IDI02X36X36TR	Inner Diamond Intersection	36"	1 3/4"	36"	\$70.02
CC05ISI02X36X36TR	Inner Square Intersection	36"	1 3/4"	36"	\$72.18
CC05ITE02X14X20TR	Inner Tee	14"	1 3/4"	20"	\$21.94
CC05PBM02X06X96TR	Perimeter Beam	6 1/4"	1 3/4"	96"	\$75.08
CC05PIC02X14X14TR	Perimeter Inside Corner	14"	1 3/4"	14"	\$25.93
CC05POC02X14X14TR	Perimeter Outside Corner	14"	1 3/4"	14"	\$24.05
CC05PTE02X14X20TR	Perimeter Tee	14"	1 3/4"	20"	\$27.00

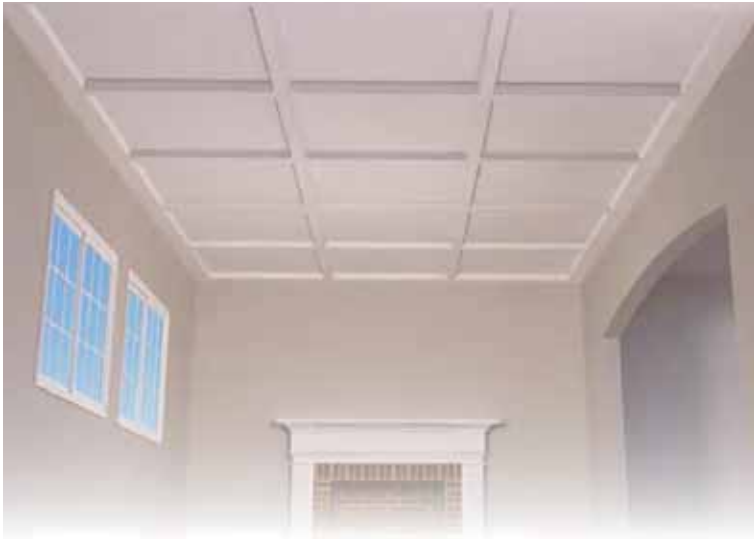

INNER CROSS INTERSECTION



INNER SQUARE INTERSECTION



INNER DIAMOND INTERSECTION



INNER CIRCLE INTERSECTION

INNER PROFILE



PERIMETER PROFILE

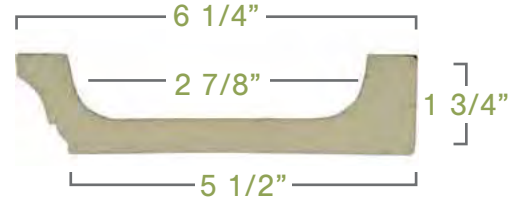

INNER BEAM

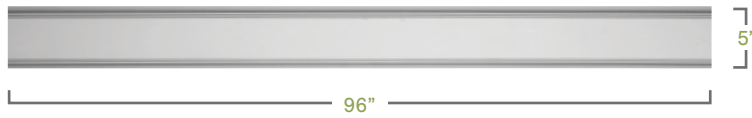

PERIMETER BEAM

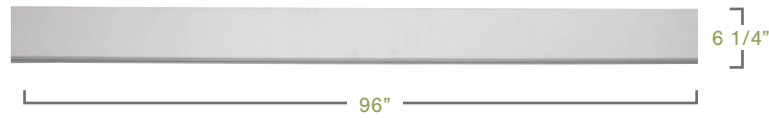

INNER CORNER

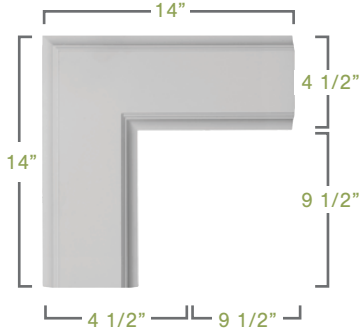

PERIMETER INSIDE CORNER

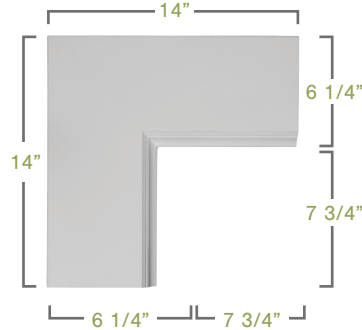

PERIMETER OUTSIDE CORNER

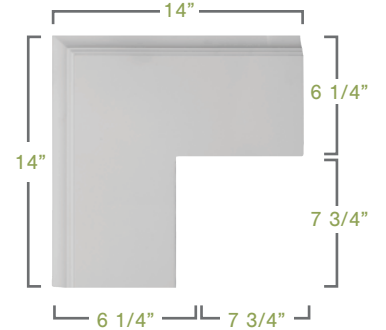

INNER TEE

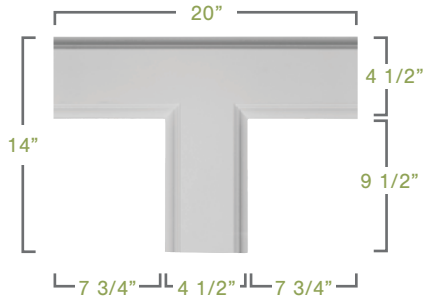

PERIMETER TEE

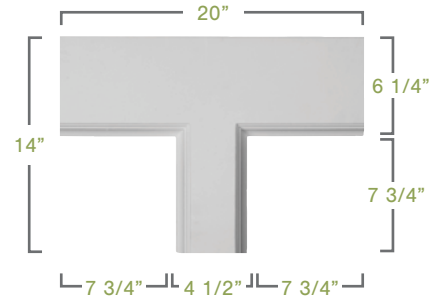

INNER CROSS INTERSECTION

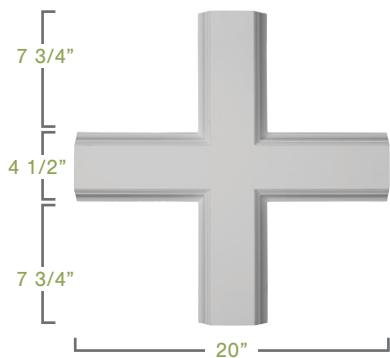

INNER CIRCLE INTERSECTION

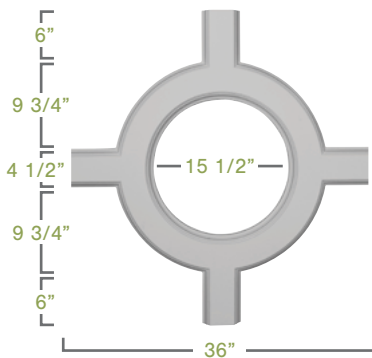

INNER DIAMOND INTERSECTION

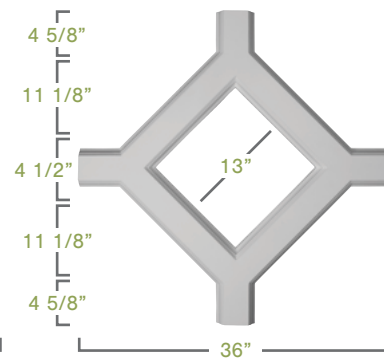

INNER SQUARE INTERSECTION

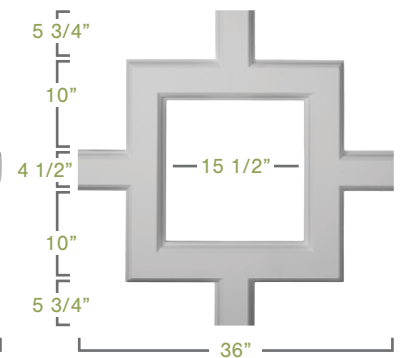

8" TRADITIONAL COFFERED CEILING SYSTEM

Part No.	Piece	W	P	L	\$
CC08IBM02X08X96TR	Inner Beam	8"	1 3/4"	96"	\$85.05
CC08ICI02X20X20TR	Inner Cross Intersection	20"	1 3/4"	20"	\$42.60
CC08ICI02X36X36TR	Inner Circle Intersection	36"	1 3/4"	36"	\$126.86
CC08ICN02X14X14TR	Inner Corner	14"	1 3/4"	14"	\$26.00
CC08IDI02X36X36TR	Inner Diamond Intersection	36"	1 3/4"	36"	\$98.23
CC08ISI02X36X36TR	Inner Square Intersection	36"	1 3/4"	36"	\$109.34
CC08ITE02X14X20TR	Inner Tee	14"	1 3/4"	20"	\$33.41
CC08PBM02X08X96TR	Perimeter Beam	8"	1 3/4"	96"	\$98.44
CC08PIC02X14X14TR	Perimeter Inside Corner	14"	1 3/4"	14"	\$30.35
CC08POC02X14X14TR	Perimeter Outside Corner	14"	1 3/4"	14"	\$30.35
CC08PTE02X14X20TR	Perimeter Tee	14"	1 3/4"	20"	\$37.90

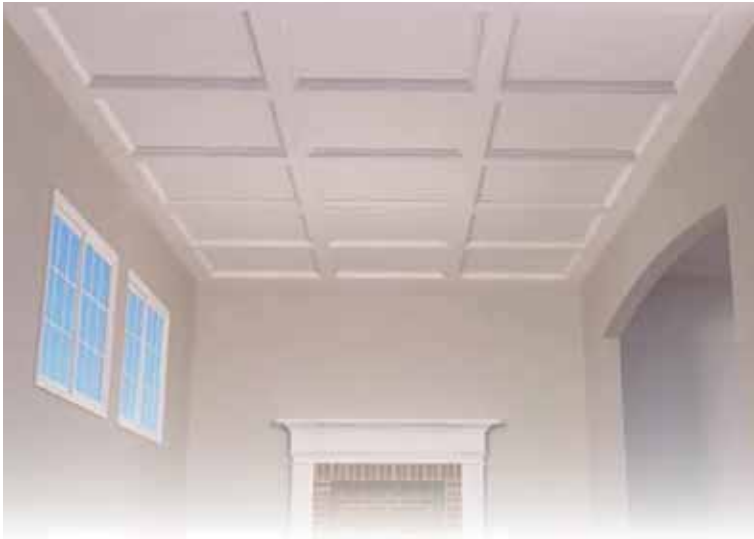

INNER CROSS INTERSECTION



INNER SQUARE INTERSECTION



INNER DIAMOND INTERSECTION



INNER CIRCLE INTERSECTION

INNER PROFILE

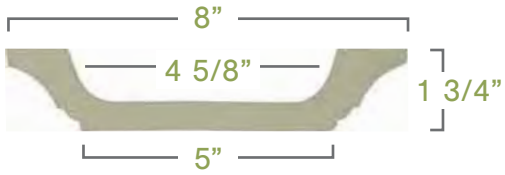

PERIMETER PROFILE

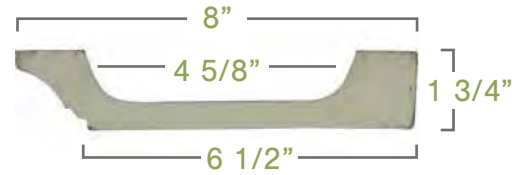

INNER BEAM



PERIMETER BEAM



INNER CORNER

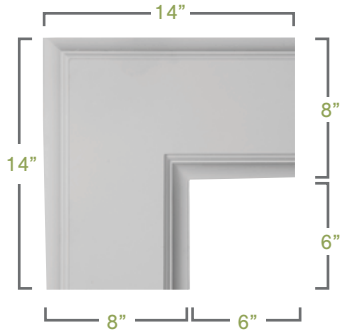

PERIMETER INSIDE CORNER

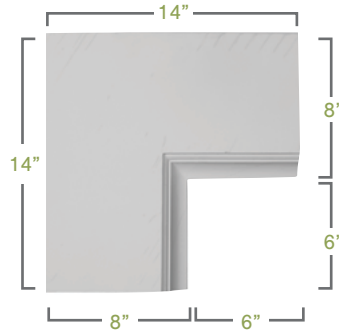

PERIMETER OUTSIDE CORNER

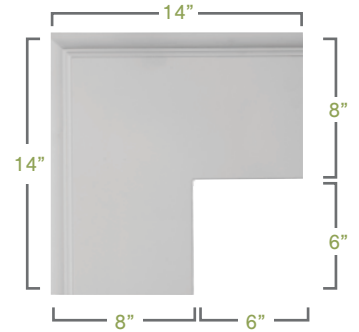

INNER TEE

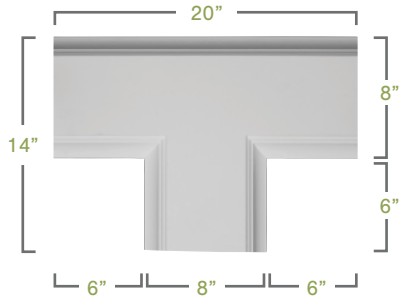

PERIMETER TEE

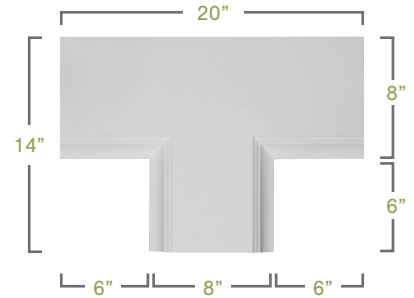

INNER CROSS INTERSECTION

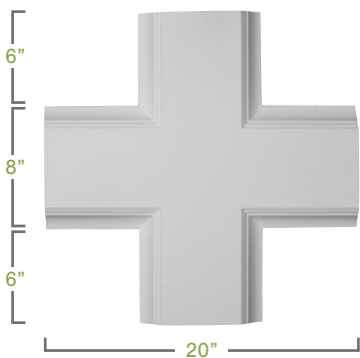

INNER CIRCLE INTERSECTION

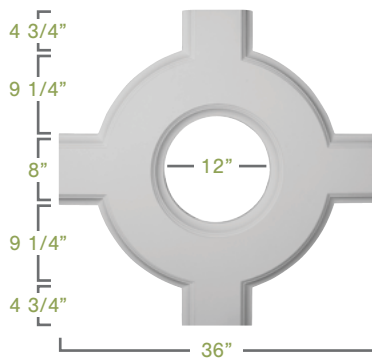

INNER DIAMOND INTERSECTION

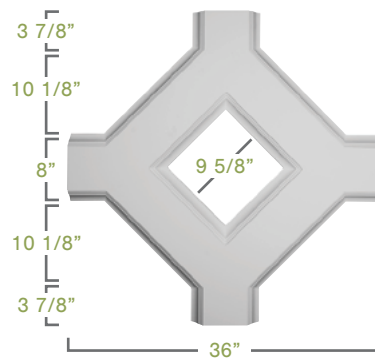

INNER SQUARE INTERSECTION

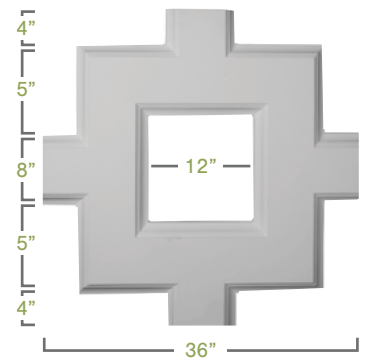

COFFERED CEILING INSTALLATION INSTRUCTIONS

TOOLS & MATERIALS

- Power Grab Adhesive
- Finishing Nails
- Utility Knife, Circular Saw, or Table Saw
- Paint Brush or Roller
- Measuring Tape
- Sand Paper

SPECIAL INSTRUCTIONS & NOTES

- Thoroughly read through the installation instructions to familiarize yourself before beginning.
- Acclimate the products for 24 hours to the room before installing.
- It is recommended that a complete layout be planned before cutting or installing.
- Take into consideration vents, fixtures, fire sprinklers, lighting, etc.
- Before installing ensure the product is free of any debris or dust.

STEP BY STEP INSTRUCTIONS

1. Prepare installation surface with sandpaper by removing excessive bumps or texture. Wipe clean & apply primer to ensure proper adhesion.
2. Mark center points on each side of the ceiling. (Fig. A)
3. Measure from the center to mark placement of the perimeter tee pieces. (Fig. B)
4. Connect each mark using a chalk line. (Fig. C)
5. Install corner pieces using adhesive & finishing nails. (Fig. D)

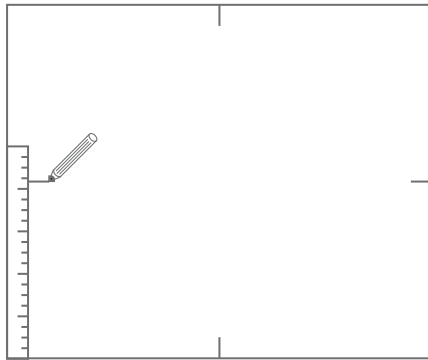

Fig. A

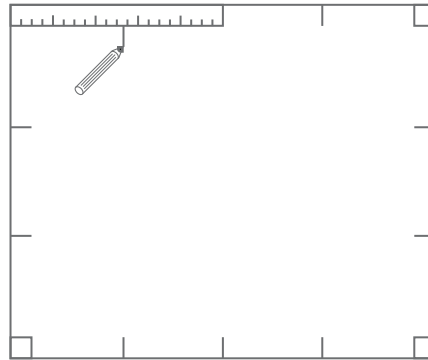

Fig. B

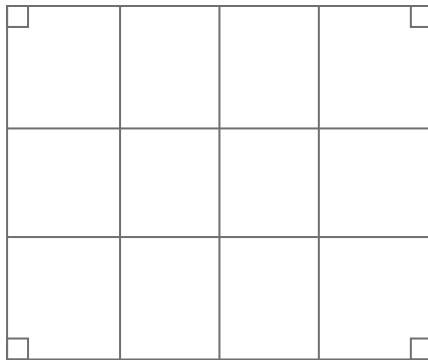

Fig. C

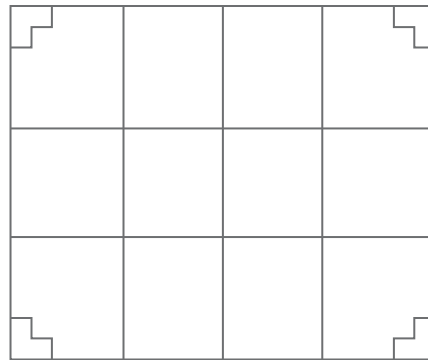

Fig. D

6. Install perimeter tees using adhesive & finishing nails, centering them on the chalk markings. (Fig. E)
7. Install intersection piece using adhesive & finishing nails, centering on the chalk markings. (Fig. F)
8. When installing perimeter beams, make sure to measure for each space & cut according to that space, then install using adhesive & finishing nails. Apply adhesive to the backs & ends of the perimeter beam pieces. (Fig. G)
9. When installing inner beams, make sure to measure for each space & cut according to that space, then install using adhesive & finishing nails. Apply adhesive to the backs & ends of the inner beam pieces. (Fig. H)
10. Once installed, paint your coffered ceiling as desired.

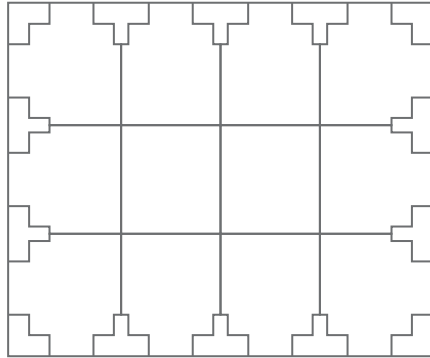

Fig. E

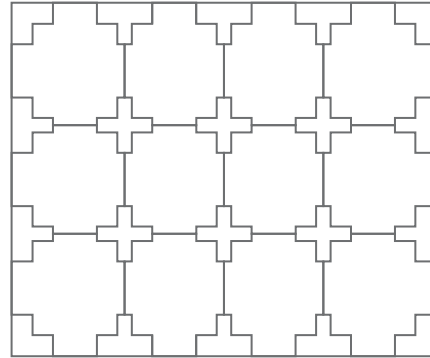

Fig. F

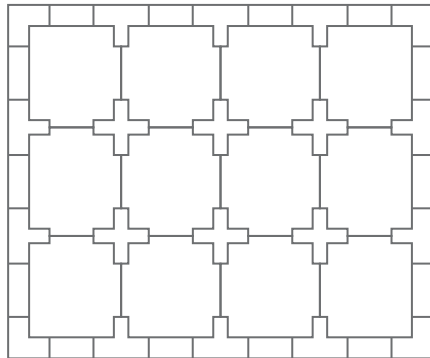

Fig. G

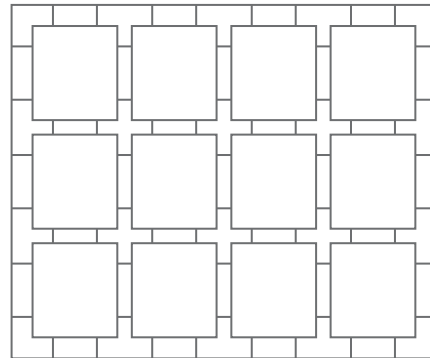
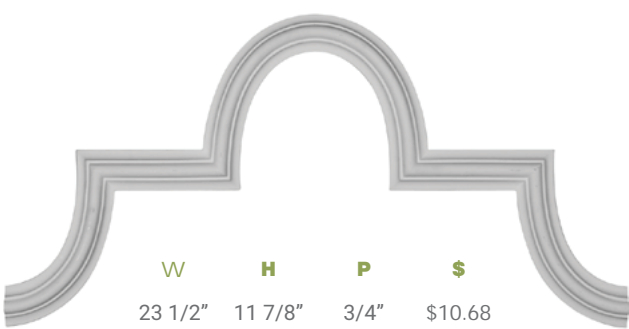

Fig. H



URETHANE CEILING ACCENTS

ADONIS PANEL MOULDING: PML12X00AD



ADONIS CENTER: PML04X01AD



ADONIS CENTER: PML05X02AD

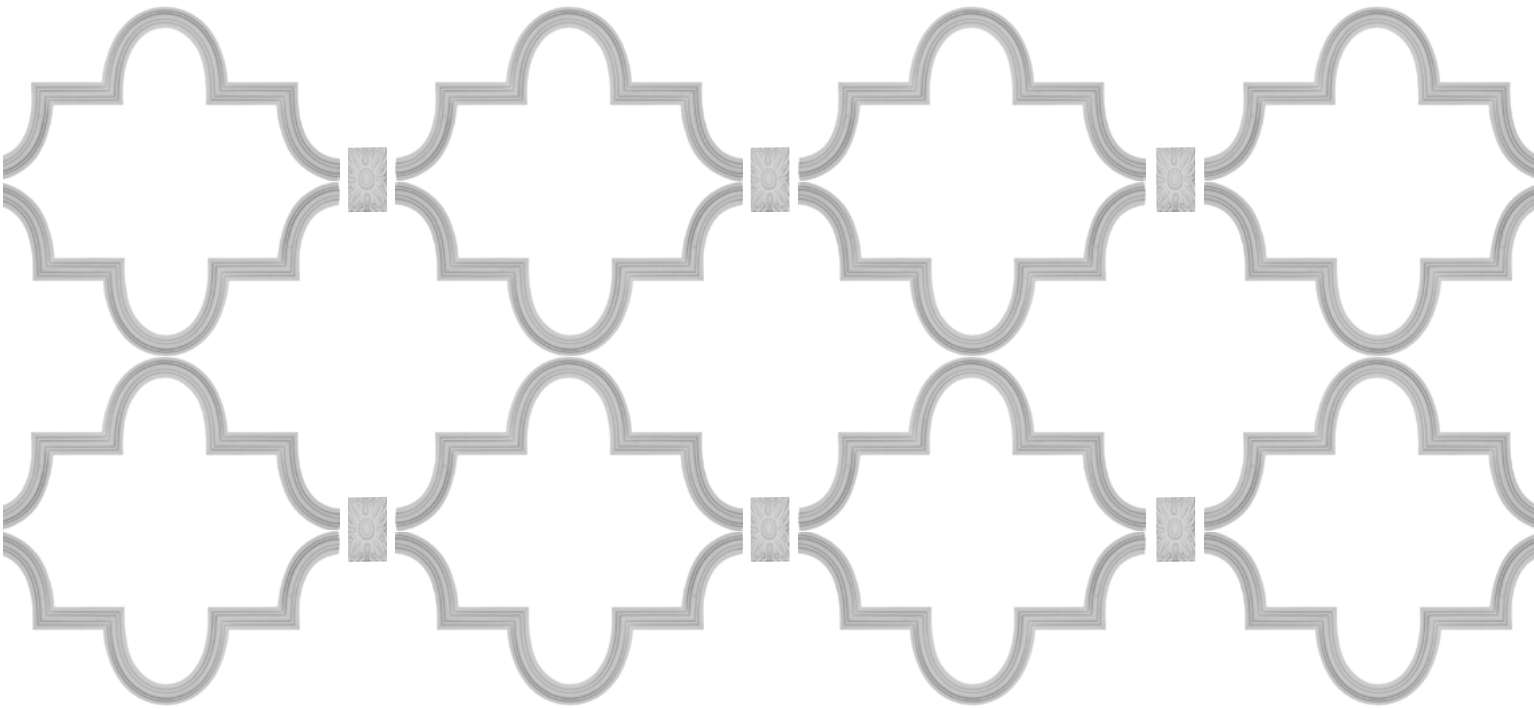



URETHANE CEILING MEDALLIONS

Increase the value of your project with a low-cost, easily installed medallion creating a timeless focal point. Medallions add dimension and texture, character, and vintage charm with over 400 designs to match every décor style. Urethane medallions are rigid, light-weight, and install quickly with construction adhesive or screws. All our urethane medallions are available with custom hole sizes, a two-piece option for reassembly around an existing fixture, and 52 unique, hand-painted finishes.

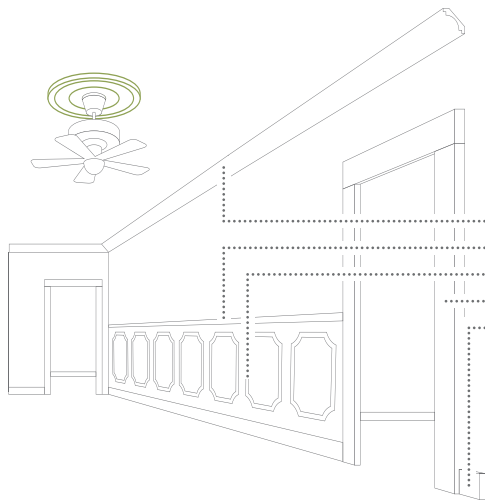
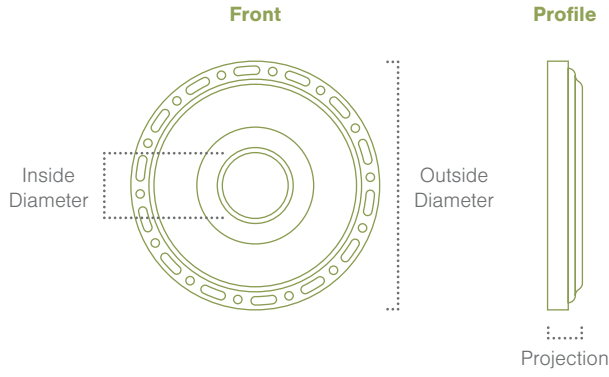

Ceiling Medallions are complimented by other features, such as crown moulding, baseboard, door & window trim, wainscot paneling, and chair rail.

Classic



Modern



Ornate



Square

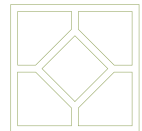



ODESSA
CM07OD \$10.68

OD	ID	P
7 1/2"	0"	1 1/8"



EMERY
CM07EM \$10.68

OD	ID	P
7 5/8"	0"	1"



MILLIN
CM08MU \$15.32

OD	ID	P
7 7/8"	0"	1/4"



OLIVIA
CM07OL \$16.03

OD	ID	P
7 7/8"	0"	1 1/8"



ALEXANDRIA
CM07AL \$10.68

OD	ID	P
7 7/8"	0"	3/4"



DANIELA
CM08DN \$10.09

OD	ID	P
8"	3 7/8"	1/2"



ANDREA
CM08AD \$11.15

OD	ID	P
8 1/8"	4 1/8"	1/2"



SHAKURAS
CM09SH \$18.76

OD	ID	P
9"	0"	1 3/8"



CLAREMONT
CM09CL \$12.93

OD	ID	P
9"	4 1/2"	1/2"



BENSON
CM09BN \$10.09

OD	ID	P
9"	4 1/8"	5/8"



MARIA
CM09MA \$13.06

OD	ID	P
9 5/8"	0"	1 1/8"



CLAREMONT
CM10CL \$16.49

OD	ID	P
10 5/8"	5 3/4"	1/2"



BENSON
CM11BN \$14.25

OD	ID	P
11 1/8"	6 1/8"	5/8"



LINUS
CM11LI \$19.00

OD	ID	P
11 1/4"	0"	1 1/8"



PALMETTO
CM11PM \$25.99

OD	ID	P
11 3/8"	3 5/8"	7/8"



LEAF
CM11LF \$24.80

OD	ID	P
11 3/8"	3 5/8"	1 1/8"



ACANTHUS
CM11AC \$22.56

OD	ID	P
11 3/8"	0"	2"



PALMETTO
CM11PA \$25.86

OD	ID	P
11 1/2"	0"	1"



BLACKTHORN
CM11BL \$24.80

OD	ID	P
11 3/4"	3 5/8"	1"



JEFFERSON
CM12JE \$25.89

OD	ID	P
11 3/4"	0"	3/8"



STOCKPORT
CM12ST \$24.93

OD	ID	P
11 3/4"	0"	3/8"



WAKEFIELD
CM11WA \$19.00

OD	ID	P
11 3/4"	0"	1 1/4"



HELENE
CM11HE \$22.43

OD	ID	P
11 7/8"	3 5/8"	7/8"



KEPLER
CM12KP \$13.06

OD	ID	P
11 7/8"	0"	1 1/4"



ANDREA
CM12AD \$16.62

OD	ID	P
12"	8"	1/2"



REECE
CM12RE \$21.37

OD	ID	P
12"	0"	1 3/4"



TRADITIONAL
CM12TR \$20.18

OD	ID	P
12"	0"	1"



PALMETTO
CM12PM \$24.80

OD	ID	P
12 1/8"	3 1/2"	1"



NADIA
CM12NA \$24.80

OD	ID	P
12 1/8"	3 5/8"	7/8"



VALERIANO
CM12VA \$23.62

OD	ID	P
12 1/8"	3 5/8"	3/4"



JACKSON
CM12JA \$19.95

OD	ID	P
12 1/4"	4"	1 1/8"



MEDWAY
CM12ME \$21.96

OD	ID	P
12 1/4"	7 1/2"	7/8"



RIBBON
CM12RI \$22.56

OD	ID	P
12 1/4"	7 1/2"	7/8"



FLOWER
CM12FL \$24.93

OD	ID	P
12 1/4"	0"	2 1/4"



CLASSIC
CM12CL \$19.95

OD	ID	P
12 3/8"	4"	1 1/8"

OUTSIDE DIAMETER
INSIDE DIAMETER
PROJECTION



WIDTH
HEIGHT

CEILING MEDALLIONS



BRADFORD

CM12BR \$21.37

OD	ID	P
12 1/2"	3 7/8"	3/4"



CARLSBAD

CM12CA \$21.37

OD	ID	P
12 1/2"	0"	1 1/2"



CARTON

CM13CA \$16.62

OD	ID	P
12 5/8"	0"	1"



FEDERAL

CM12FE \$24.93

OD	ID	P
12 5/8"	0"	1 1/8"



ATTICA

CM12AT \$25.23

OD	ID	P
12 3/4"	3 1/2"	1/2"



ACANTHUS

CM12LE \$19.00

OD	ID	P
12 3/4"	0"	7/8"



BRADFORD CLASSIC

CM13BR \$22.56

OD	ID	P
13"	7 1/2"	3/4"



WHITMAN

CM13WH \$21.37

OD	ID	P
13"	0"	1 3/8"



BENSON

CM13BN \$17.81

OD	ID	P
13 1/8"	8"	5/8"



ORRINGTON

CM13OR \$23.74

OD	ID	P
13 1/4"	6 5/8"	1 1/8"



SALEM

CM13SA \$19.00

OD	ID	P
13 1/4"	7 1/8"	7/8"



CLASSIC

CM13CL \$23.38

OD	ID	P
13 1/4"	0"	1/2"



BLACKTHORN

CM13BL \$22.56

OD	ID	P
13 3/8"	7 1/2"	3/4"



ASA

CM13AS \$23.74

OD	ID	P
13 3/4"	2 3/4"	3"



MONIQUE

CM13MO \$28.24

OD	ID	P
13 3/4"	0"	1"



TIRANA

CM13TI \$23.24

OD	ID	P
13 7/8"	3 3/4"	1 1/4"



KATHERYN

CM14KT \$28.37

OD	ID	P
14 1/2"	0"	2 3/4"



NEEDHAM

CM14NE \$49.78

OD	ID	P
14 5/8"	0"	2 1/4"



TRADITIONAL

CM14TR \$25.52

OD	ID	P
14 3/4"	0"	1 3/4"



ALEXA

CM14AX \$22.56

OD	ID	P
15"	0"	1 3/4"



DUBLIN

CM15DU \$28.24

OD	ID	P
15 3/8"	3 5/8"	1"



FEDERAL

CM15FE \$31.86

OD	ID	P
15 3/8"	3 5/8"	1"



BALTIMORE

CM15BA \$30.61

OD	ID	P
15 3/8"	4 1/4"	1 1/2"



LISBON

CM15LI \$21.37

OD	ID	P
15 3/8"	7"	1"



GALWAY

CM15GA \$26.12

OD	ID	P
15 3/4"	3 1/4"	1"



BERKSHIRE

CM15BE \$26.12

OD	ID	P
15 3/4"	3 7/8"	3/4"



AMELIA

CM16AM \$37.40

OD	ID	P
15 3/4"	0"	5/8"



GRANADA

CM16GA \$38.70

OD	ID	P
15 3/4"	0"	5/8"



KIRKE

CM16KI \$40.48

OD	ID	P
15 3/4"	0"	5/8"

PRO TIP **HOW TO MEASURE FOR CEILING MEDALLIONS**

Multiply the length & width of your room in feet then divide by 7 to determine a proportionate diameter size in inches.



LUTON		
CM16LU		\$35.85
OD	ID	P
15 3/4"	0"	5/8"



FOSTER		
CM15FO		\$27.31
OD	ID	P
15 3/4"	0"	2"



ARTIS		
CM15AR		\$33.24
OD	ID	P
15 3/4"	0"	1 3/8"



COLTON		
CM15CN		\$33.24
OD	ID	P
15 3/4"	0"	1 1/2"



DEVON		
CM15DE		\$32.39
OD	ID	P
15 3/4"	0"	1 1/2"



CHESTERFIELD		
CM15CH		\$28.49
OD	ID	P
15 3/4"	0"	1 7/8"



KEPLER		
CM16KP		\$26.12
OD	ID	P
15 7/8"	0"	1 1/2"



MELONIE		
CM16ML		\$27.31
OD	ID	P
16"	3 5/8"	3/4"



WIGAN		
CM16WG		\$51.13
OD	ID	P
16"	0"	2 1/4"



GENEVIEVE		
CM16GN		\$33.24
OD	ID	P
16 1/8"	3 1/2"	7/8"



ADONIS		
CM16AD		\$34.30
OD	ID	P
16 1/8"	3 5/8"	1"



MARSEILLE		
CM16MA		\$32.05
OD	ID	P
16 1/8"	0"	5/8"



TYRONE		
CM16TY		\$33.24
OD	ID	P
16 1/8"	0"	3/4"



WREATH		
CM16WR		\$34.30
OD	ID	P
16 1/4"	3 5/8"	1"



SOUTHAMPTON		
CM17SO		\$32.99
OD	ID	P
16 3/8"	0"	1 3/4"



APOLLO		
CM16AP		\$38.92
OD	ID	P
16 1/2"	3 5/8"	1 1/8"



MEDEA		
CM16ME		\$30.87
OD	ID	P
16 1/2"	3 7/8"	1 1/2"



SOUTHAMPTON		
CM16SO		\$27.31
OD	ID	P
16 1/2"	0"	2 3/8"



MEDEA		
CM16MD		\$30.87
OD	ID	P
16 1/2"	0"	1 1/2"



PLYMOUTH		
CM16PL		\$27.31
OD	ID	P
16 3/4"	0"	1 3/8"



VIENNA		
CM17VI		\$37.40
OD	ID	P
16 7/8"	0"	5/8"



EMERY		
CM16ER		\$34.90
OD	ID	P
16 7/8"	0"	5/8"



SWINDON		
CM16SW		\$28.37
OD	ID	P
16 7/8"	0"	1 1/2"



OXFORD		
CM16OX		\$19.00
W	H	P
16 7/8"	11 3/4"	1 1/2"



WASHINGTON		
CM17WA		\$29.55
OD	ID	P
17 1/8"	0"	1 1/2"



BREMEN		
CM17BR		\$26.12
OD	ID	P
17 3/8"	0"	1 3/4"



FEDERAL		
CM17FE		\$30.87
OD	ID	P
17 3/8"	0"	1 1/8"



HAMILTON		
CM17HA		\$36.42
OD	ID	P
17 3/8"	0"	1 3/4"



MUNICH		
CM17MU		\$32.05
OD	ID	P
17 1/2"	3 5/8"	1"



PRESTON		
CM17PR		\$34.43
OD	ID	P
17 1/2"	4"	1"



RAYMOND		
CM17RA2		\$34.30
OD	ID	P
17 5/8"	3 5/8"	7/8"



ORLEANS		
CM17OL		\$36.55
OD	ID	P
17 5/8"	3 5/8"	1 7/8"

OUTSIDE DIAMETER
INSIDE DIAMETER
PROJECTION



WIDTH
HEIGHT

CEILING MEDALLIONS



PERALTA
CM17PE \$39.05

OD	ID	P
17 3/4"	3 3/4"	1"



CARTON
CM18CA \$35.62

OD	ID	P
17 3/4"	0"	1 3/8"



EXETER
CM17EX \$41.55

OD	ID	P
17 3/4"	0"	1 1/8"



DUBLIN
CM17DU \$33.24

OD	ID	P
17 7/8"	3 5/8"	1 1/4"



TERRONES
CM17TS \$40.36

OD	ID	P
17 7/8"	3 7/8"	1"



CRAWLEY
CM18CR \$49.86

W	H	ID	P
18"	18"	3 1/4"	1 1/2"



OLDHAM
CM18OL1 \$42.74

OD	ID	P
18"	3 3/8"	7/8"



ROTHERHAM
CM17RO \$40.36

OD	ID	P
18"	3 1/2"	1 1/2"



GRANADA
CM18GA \$43.80

OD	ID	P
18"	3 1/2"	2 1/2"



KENT
CM18KE \$39.18

OD	ID	P
18"	3 1/2"	1 1/4"



NORWICH
CM18NO \$40.36

OD	ID	P
18"	3 1/2"	1 3/8"



NOTTINGHAM
CM18NT \$40.96

OD	ID	P
18"	3 1/2"	1 1/2"



RILEY
CM18RL \$30.87

OD	ID	P
18"	3 1/2"	1 1/2"



ROSE
CM18RO \$37.40

OD	ID	P
18"	3 1/2"	1 1/2"



ANTIOCH
CM18SE \$41.42

OD	ID	P
18"	3 1/2"	1 3/8"



VALLETTA
CM18VL \$37.99

OD	ID	P
18"	3 1/2"	1"



WARSAW
CM18WA \$48.42

OD	ID	P
18"	3 1/2"	1 3/8"



ERIS
CM18ER \$41.55

W	H	ID	P
18"	18"	3 1/2"	1 1/8"



DIANE
CM18DI \$28.49

OD	ID	P
18"	3 5/8"	1 1/8"



BAILEY
CM18BI \$34.30

OD	ID	P
18"	3 3/4"	1 1/2"



ATTICA
CM18AT \$35.62

OD	ID	P
18"	4"	5/8"



OLDHAM
CM18OL \$52.92

OD	ID	P
18"	0"	1 1/4"



RAYMOND
CM18RA2 \$36.42

OD	ID	P
18"	0"	1 1/4"



EDINBURGH
CM18ED \$37.40

OD	ID	P
18"	0"	1 3/4"



NIOBE
CM18NI \$29.68

OD	ID	P
18"	0"	1 1/2"



RICHMOND
CM18RI \$40.96

OD	ID	P
18"	0"	1 3/8"



EDINBURGH
CM18ED1 \$31.93

OD	ID	P
18 1/8"	3 1/2"	2 3/4"



RAYMOND
CM18RA \$28.49

OD	ID	P
18 1/8"	3 5/8"	1 1/8"



BRADFORD
CM18BR \$40.36

OD	ID	P
18 1/8"	3 3/4"	1 1/8"



HAMPSHIRE
CM18HA #N/A

OD	ID	P
18 1/8"	0"	1 1/2"



BAILEY
CM19BI \$40.48

OD	ID	P
18 1/8"	0"	3/4"



KATHERYN
CM18KA \$34.30

OD	ID	P
18 1/8"	0"	1 1/4"



SELLEK
CM18SK \$37.99

OD	ID	P
18 1/2"	7/8"	1 1/2"



FLOWER
CM18FW2 \$34.30

OD	ID	P
18 1/2"	3 5/8"	7/8"



KENDALL
CM18KD \$61.73

OD	ID	P
18 1/2"	3 7/8"	1"



SAVERNE
CM18SA \$27.31
W H P
18 1/2" 13 1/2" 1 7/8"



CLASSIC
CM19CL \$55.86
OD ID P
18 5/8" 4" 1 1/8"



POMPEII
CM18PO \$30.87
OD ID P
18 7/8" 0" 1 1/2"



GRANADA
CM19GA \$43.80
OD ID P
19" 0" 1 1/2"



TRIANGLE
CM19TG \$33.24
W H P
19" 19" 1 1/8"



FOSTER
CM19FO \$41.17
OD ID P
19 1/8" 0" 1"



CARLSBAD
CM19CA \$42.61
OD ID P
19 1/2" 0" 1 3/4"



ORRINGTON
CM19OR \$36.68
OD ID P
19 5/8" 4 3/4" 1 3/4"



AMELIA
CM20AM \$46.78
OD ID P
19 5/8" 0" 3/4"



ALEXANDRIA
CM18AL \$66.48
OD ID P
19 5/8" 0" 1 1/2"



KEPLER
CM20KP \$36.68
OD ID P
19 3/4" 0" 1 1/2"



ODESSA
CM20OD \$42.74
OD ID P
19 3/4" 0" 1 3/8"



SHAKURAS
CM20SH \$40.24
OD ID P
19 3/4" 0" 1 3/8"



SPRING LEAF
CM19SP \$40.11
OD ID P
19 7/8" 3 5/8" 1 1/4"



LEANDROS
CM22LN \$40.36
OD ID P
19 7/8" 0" 1 1/4"



VIENNA
CM20VI \$39.05
OD ID P
20" 3 1/2" 1 1/2"



JACKSON
CM20JA \$48.42
OD ID P
20" 3 5/8" 1"



BAILE
CM20BL \$40.36
OD ID P
20" 0" 1 5/8"



BONETTI
CM20BO \$40.36
OD ID P
20" 0" 1 3/4"



DAMON
CM20DA \$46.77
OD ID P
20" 0" 1 1/2"



RANEE
CM20HA \$40.36
OD ID P
20" 0" 1 3/8"



BERKSHIRE
CM20BE1 \$41.72
OD ID P
20 1/8" 3 7/8" 1 7/8"



DERIA
CM20DR \$43.54
OD ID P
20 1/4" 0" 1 1/2"



LUNEL
CM20LU \$44.86
OD ID P
20 1/4" 0" 1 1/2"



FOSTER
CM20FO \$40.36
OD ID P
20 1/2" 0" 1 1/2"



ALEXA
CM20AL \$36.68
OD ID P
20 1/2" 0" 1 7/8"



LAUREN
CM20LN \$45.11
OD ID P
20 5/8" 6 1/4" 1 3/8"



RAYNOR
CM20BE \$54.48
OD ID P
20 5/8" 0" 1 3/8"



PALMETTO
CM20PM \$37.99
OD ID P
20 7/8" 3 5/8" 1 5/8"



ANGEL
CM20AN \$65.17
OD ID P
20 7/8" 3 5/8" 1"



HOLMDEL
CM20HO \$30.87
OD ID P
20 7/8" 12 7/8" 1"



BIDDIX
CM20BX \$45.66
OD ID P
20 7/8" 0" 1 1/4"



LUTON
CM21LU \$46.17
OD ID P
21" 0" 2"



MARSEILLE
CM21MA \$44.52
OD ID P
21" 0" 2"



REECE
CM21RE \$42.15
OD ID P
21" 0" 1 1/4"

OUTSIDE DIAMETER
INSIDE DIAMETER
PROJECTION



WIDTH
HEIGHT

CEILING MEDALLIONS



WREATH
CM21WR \$44.86

OD	ID	P
21 1/8"	3 5/8"	7/8"



WALTZ
CM21WA \$30.87

W	H	P
21 1/4"	17 3/8"	1"



YORK
CM21YO \$81.66

OD	ID	P
21 5/8"	0"	2 1/2"



CLASSIC
CM22CL \$52.24

OD	ID	P
21 7/8"	0"	2 3/8"



ORRINGTON
CM22OR \$54.36

OD	ID	P
22"	6 1/4"	1 3/4"



TRINITY
CM22TN \$46.07

OD	ID	P
22"	0"	1 3/4"



HURLEY
CM26HU \$63.60

OD	ID	P
22 1/8"	7 1/4"	1 3/4"



ROBIN
CM22RB \$78.74

OD	ID	P
22 1/4"	4 3/4"	1 1/4"



HARVEST
CM22AT \$46.30

OD	ID	P
22 1/2"	0"	1 1/4"



CORNELIA
CM22CN \$74.03

OD	ID	P
22 1/2"	0"	1 1/2"



GRAPE
CM22GR \$53.98

OD	ID	P
22 5/8"	3 5/8"	5/8"



BORDEAUX
CM22BO \$42.74

OD	ID	P
22 5/8"	0"	1 3/4"



WOODRUFF
CM23WF \$41.79

OD	ID	P
23 1/4"	0"	7/8"



GRANADA
CM23GA \$55.67

OD	ID	P
23 3/8"	3 5/8"	2 1/2"



VADUZ
CM23VA \$62.92

OD	ID	P
23 1/2"	3 1/2"	2 1/8"



BRISTOL
CM23BI \$60.42

OD	ID	P
23 1/2"	3 7/8"	1"



FLORAL
CM23FL \$81.28

OD	ID	P
23 1/2"	0"	2 3/4"



LYON
CM23LY \$56.99

OD	ID	P
23 1/2"	0"	3 1/4"



MODENA
CM23MO \$74.67

OD	ID	P
23 1/2"	0"	3 1/2"



ROSE & RIBBON
CM23RO1 \$26.12

W	H	P
23 1/2"	12 1/4"	1 1/2"



GRANADA
CM24GA \$69.92

OD	ID	P
23 1/2"	0"	2 3/4"



BORDEAUX DELUXE
CM23BO \$83.32

OD	ID	P
23 5/8"	3"	2"



BELLONA
CM23BE \$54.61

OD	ID	P
23 5/8"	3 5/8"	1 1/8"



PALMETTO
CM23PM \$62.54

OD	ID	P
23 5/8"	3 5/8"	1 5/8"



JAMIE
CM23JA \$76.79

OD	ID	P
23 5/8"	3 7/8"	2 1/8"



ROSE & RIBBON
CM23RO \$76.79

OD	ID	P
23 5/8"	4"	1 1/2"



ACANTHUS
CM23AC \$84.97

OD	ID	P
23 5/8"	4 5/8"	1 7/8"



KEPLER
CM24KP \$59.91

OD	ID	P
23 5/8"	0"	1 3/4"



KAYA
CM23KA \$54.61

OD	ID	P
23 5/8"	0"	1 1/2"



LUTON
CM23LU \$69.66

OD	ID	P
23 3/4"	3 5/8"	1 7/8"



ASHLEY
CM23AS \$54.61

OD	ID	P
23 7/8"	4"	2 1/8"

INSPIRING IDEAS



Unique
CEILING MEDALLION CLOCKS!



DIANE
CM24DI \$57.79

OD	ID	P
24"	3 5/8"	1 1/4"



THEIA
CM24TH \$92.52

OD	ID	P
24"	3 5/8"	1 3/4"



SWINDON
CM24SW \$88.62

OD	ID	P
24"	4"	1 1/2"



SHAKURAS
CM24SH \$85.35

OD	ID	P
24"	0"	3"



TEMPLE
CM24TE \$61.73

OD	ID	P
24"	0"	1 5/8"



WALTZ
CM24WA \$51.05

W	H	P
24"	20 1/2"	1 1/8"



CRENDON
CM24CR \$52.24

OD	ID	P
24 1/8"	4 3/8"	2 1/4"



LOGAN
CM24LO1 \$66.36

OD	ID	P
24 1/4"	3 7/8"	2"



CAPUTO
CM24CA \$104.39

OD	ID	P
24 1/4"	0"	1 1/2"



NEUVEAU
CM24NA \$61.73

OD	ID	P
24 1/4"	0"	2"



VICTORIAN
CM24VI \$61.73

OD	ID	P
24 3/8"	0"	1"



REECE
CM24RE \$64.15

OD	ID	P
24 3/8"	0"	1 1/8"



TRADITIONAL
CM24TR \$51.05

OD	ID	P
24 3/8"	0"	1 1/2"



MILAN
CM24MI \$83.34

OD	ID	P
24 1/2"	3 1/2"	1"



SALFORD
CM24SA \$80.73

OD	ID	P
24 5/8"	3 3/4"	1 1/2"

LARIAH
CM24LA \$125.50

OD	ID	P
24 3/4"	1 3/8"	3 1/4"



ERYN
CM24EN \$85.48

OD	ID	P
24 3/4"	3 1/4"	1 7/8"



MADRID
CM24X12MA \$42.48

W	H	P
24 3/4"	12 1/2"	1 3/4"



SPIRAL
CM25SP \$74.41

OD	ID	P
25 1/4"	4"	2"



FELIX
CM25FE \$49.52

W	H	P
25 1/4"	17 1/4"	1 3/4"



COLE
CM25CO \$62.79

OD	ID	P
25 3/8"	3 3/8"	1 3/8"



BRONTES
CM25BR \$68.73

OD	ID	P
25 1/2"	0"	5 1/2"



ASHUR
CM25AS \$62.92

OD	ID	P
25 5/8"	0"	2 3/4"



SHELL
CM25SH \$74.20

OD	ID	P
25 5/8"	0"	1"



NESTOR
CM25NE \$100.83

OD	ID	P
25 7/8"	0"	2 1/4"



TRADITIONAL WITH ACANTHUS LEAF
CM26TA \$84.50

OD	ID	P
26"	3 1/8"	1 1/2"



ATTICA WITH ROSE
CM26AT \$84.50

OD	ID	P
26"	3 3/4"	1 1/2"



TRISTAN
CM26TN \$88.28

OD	ID	P
26"	0"	3"



VINCENT
CM26VI \$73.61

OD	ID	P
26"	0"	3"



PEARL
CM26PE \$113.38

OD	ID	P
26 1/4"	0"	1 1/2"



OUTSIDE DIAMETER
INSIDE DIAMETER
PROJECTION



CEILING MEDALLIONS



ATHENS
CM27AT \$99.89

OD	ID	P
26 1/4"	0"	3 1/4"



MARCELLA
CM26MR \$40.36

W	H	P
26 3/8"	17 1/4"	1 3/4"



JEFFERSON
CM26JE \$68.60

OD	ID	P
26 1/2"	3 5/8"	1 1/2"



LOERA
CM26LO \$66.48

OD	ID	P
26 5/8"	4 1/2"	1 3/8"



CHRISTOPHER
CM26CS \$67.03

OD	ID	P
26 5/8"	0"	2 1/4"



ELSINORE
CM26EL \$70.72

OD	ID	P
26 3/4"	3 5/8"	1 3/8"



LEAF
CM26LF \$67.54

OD	ID	P
26 3/4"	3 5/8"	1 1/8"



FLOWER
CM27FL \$88.56

OD	ID	P
27"	0"	1 1/8"



BRUNSWICK
CM27BR \$73.61

OD	ID	P
27"	0"	2 1/2"



ARTIS
CM27AR \$73.61

OD	ID	P
27 1/8"	0"	2 5/8"



HEATON
CM27HE \$68.86

OD	ID	P
27 1/2"	3 7/8"	2 1/4"



WINDSOR
CM27WI \$69.92

OD	ID	P
27 1/2"	4"	1 1/2"



SYDNEY
CM27SY \$127.50

OD	ID	P
27 3/4"	0"	2"



EGG AND DART
CM27TO \$78.36

OD	ID	P
27 7/8"	3 7/8"	2 1/2"



STOCKPORT
CM28ST \$136.19

OD	ID	P
28"	0"	2 3/4"



OSLO
CM28OS \$79.16

OD	ID	P
28 1/8"	0"	1 3/4"



CORNELIA
CM28CN \$113.97

OD	ID	P
28 1/4"	0"	1 1/2"



BENSON CLASSIC
CM28BE \$75.98

OD	ID	P
28 3/8"	3 3/4"	1 5/8"



FLOWER
CM29FW \$100.53

OD	ID	P
29"	3 5/8"	1 3/8"



HAYLYNN
CM29HY \$154.00

OD	ID	P
29 1/8"	1 1/4"	4"



SPRING OCTAGONAL
CM30SP \$100.40

OD	ID	P
29 1/8"	2 1/4"	1 1/8"



OAKLEAF
CM29OA \$71.23

OD	ID	P
29 1/8"	3 5/8"	1"



CARTON
CM29CA \$78.23

OD	ID	P
29 1/8"	0"	1 1/2"



DARNAY
CM29DA \$142.29

OD	ID	P
29 1/4"	0"	2"



ANTHONY
CM29AT \$99.00

OD	ID	P
29 3/8"	11 5/8"	1 1/8"



SPRINGTIME
CM29SP \$75.73

OD	ID	P
29 3/8"	0"	2 7/8"



SUNFLOWER
CM29SF \$99.09

OD	ID	P
29 1/2"	3 5/8"	1 5/8"



SHAKURAS
CM30SH \$106.85

OD	ID	P
29 1/2"	0"	2"



WIGAN
CM29WG \$81.28

OD	ID	P
29 3/4"	0"	1 1/2"



FAIRFAX
CM29FA \$88.91

OD	ID	P
29 7/8"	0"	1 3/8"



FLAGSTONE
CM30FL \$103.16

OD	ID	P
30"	3 7/8"	3 1/4"



NEXUS
CM30NE \$111.17

OD	ID	P
30"	0"	1 1/4"



DYLAN
CM30DY \$101.84

OD	ID	P
30"	0"	2 1/4"



ATTICA
CM30AT \$116.35

OD	ID	P
30 1/8"	0"	1 1/2"



KATHERYN
CM30KT \$90.23

W	H	P
30 3/8"	22 1/2"	1 1/2"



LINCOLN
CM30KI \$66.48
W H P
30 3/8" 20 3/4" 1"



STRASBOURG
CM30SG \$42.74
W H P
30 1/2" 20" 1 1/2"



TELLSON
CM30TE \$141.74
OD ID P
30 5/8" 0" 2 1/2"



ALEXA
CM21X30AL \$83.91
W H ID P
30 3/4" 21 1/4" 3 7/8" 1 5/8"



ROSE
CM30RO \$113.08
OD ID P
30 7/8" 3 5/8" 1 3/8"



DURHAM
CM31DU \$95.53
OD ID P
31" 0" 1 1/2"



CARLSBAD
CM31CA \$139.50
OD ID P
31 1/8" 0" 1 1/2"



BONETTI
CM34BO \$112.19
OD ID P
31 1/4" 0" 2"



BAILE
CM31BA \$102.57
OD ID P
31 1/4" 0" 2 1/4"



KIRKE
CM31KI \$134.07
OD ID P
31 1/2" 3 5/8" 1 1/2"



PALMETTO
CM31PM \$113.46
OD ID P
31 1/2" 3 5/8" 1 3/4"



TRADITIONAL
CM31TR \$109.22
OD ID P
31 1/2" 0" 2 1/2"

MORE THAN **400** MEDALLIONS



GORLEEN
CM31GO \$165.57
OD ID P
31 5/8" 3 5/8" 1 7/8"



ANGEL
CM32AN \$128.77
OD ID P
32 1/4" 3 5/8" 1 1/8"



TRISTAN
CM32TN \$122.45
OD ID P
32 3/8" 0" 3 1/2"



LESLIE
CM32LS \$100.91
OD ID P
32 5/8" 0" 1 1/8"



GIANA
CM32GI \$93.66
OD ID P
32 5/8" 0" 1 1/2"



BRADFORD
CM32BR \$101.84
OD ID P
32 5/8" 0" 2"



JACKSON
CM32JA \$218.28
OD ID P
32 3/4" 0" 2 1/2"



VERSAILLES
CM33VE \$106.85
OD ID P
33" 0" 1 3/4"



LEANDROS
CM33LE \$180.34
OD ID P
33 1/8" 3 1/2" 1 3/8"



SCROLL
CM33SC \$145.01
OD ID P
33 1/4" 3 5/8" 1"



MEDWAY
CM33ME \$103.29
OD ID P
33 7/8" 0" 4"



SHAKURAS
CM34SH \$116.35
OD ID P
33 7/8" 0" 2"



ROSE
CM33RO \$141.70
OD ID P
33 7/8" 0" 2 3/8"



DAUPHINE
CM33DA \$113.97
OD ID P
33 7/8" 0" 1 3/8"



VICEROI
CM35VI \$124.57
OD ID P
35 1/8" 4 7/8" 2 1/2"



FAIRFAX
CM35FA \$113.97
OD ID P
35 7/8" 0" 1 1/2"



ANTONIO
CM35X22AN \$124.57
W H P
35 7/8" 22 1/2" 4 3/8"



JUNIPER
CM36JU \$137.72
OD ID P
36" 0" 1 1/2"



PESARO
CM36X26PE \$79.54
W H P
36" 26" 1 1/2"



MELONIE
CM36ME \$187.87
OD ID P
36 1/4" 0" 1 7/8"



GALVESTON
CM36GL \$195.89
OD ID P
36 5/8" 3 5/8" 2 3/8"



PIEDMONT
CM37X26PE \$61.73
W H P
37" 26" 1 3/8"

OUTSIDE DIAMETER
INSIDE DIAMETER
PROJECTION



WIDTH
HEIGHT

CEILING MEDALLIONS

METZ
CM37ME \$189.95

OD	ID	P
37 3/8"	0"	1 1/8"



NAPLE
CM37NA \$141.28

OD	ID	P
37 1/2"	0"	3 3/8"



CATHEDRAL
CM29X38CA \$262.67

W	H	P
38 1/8"	29 1/8"	1 3/4"



ANTILLES
CM38AN \$163.01

OD	ID	P
38 1/4"	0"	1 1/2"



ORLEANS
CM38OL \$161.46

OD	ID	P
38 3/8"	6 5/8"	2 7/8"



OSLO
CM38OS \$144.84

OD	ID	P
38 3/8"	0"	2 7/8"



ATTICA
CM39AT \$201.10

OD	ID	P
39 1/2"	0"	2 1/2"



DELFINA
CM40DL \$163.83

OD	ID	P
40"	0"	1 7/8"



CLASSIC
CM40CL \$187.32

OD	ID	P
40 1/4"	0"	3 1/8"



MILTON
CM40MI \$190.50

OD	ID	P
40 5/8"	0"	1 3/4"



CAPUTO
CM41CA \$252.28

OD	ID	P
41"	4"	2 3/8"



EDINBURGH
CM41ED \$172.14

OD	ID	P
41"	0"	4 1/4"



NEXUS
CM41NE \$233.24

OD	ID	P
41"	0"	1 5/8"



CLASSIC
CM41CL \$230.79

OD	ID	P
41 1/8"	4"	2 1/8"



FLORAL
CM41FL \$207.93

OD	ID	P
41 1/8"	0"	2 1/2"



SELLEK
CM42SK \$254.27

OD	ID	P
42 1/8"	0"	1 7/8"



SPRINGTIME
CM42SP \$253.55

OD	ID	P
42 1/2"	0"	4 5/8"



ASHFORD
CM42X28AS \$151.71

W	H	P
42 3/4"	28 7/8"	1"



CLASSIC
CM44CL \$304.45

OD	ID	P
44 1/2"	4"	3"



SHAKURAS
CM48SH \$325.29

OD	ID	P
47 5/8"	0"	2"



MILAN
CM47MI \$397.46

OD	ID	P
47 5/8"	0"	2 3/4"



LORRY
CM50LO \$373.88

OD	ID	P
50 1/8"	3 5/8"	1 3/4"



GALVESTON
CM51GL \$373.88

OD	ID	P
51"	3 5/8"	3 3/8"



NEVIO
CM51NE \$378.63

OD	ID	P
51 1/8"	3 5/8"	1 1/2"



DECO
CM51DC \$261.78

OD	ID	P
51 1/8"	19 7/8"	2"



ATTICA
CM53AT \$409.58

OD	ID	P
53 1/2"	0"	3 1/2"



CLASSIC
CM54TCL \$420.18

OD	ID	P
54"	0"	4 7/8"



MILTON
CM54MI \$420.18

OD	ID	P
54 1/4"	0"	2 7/8"



SHAKURAS
CM64SH \$783.55

OD	ID	P
64 1/4"	0"	4"



PIEDMONT
CM67PE \$421.46

W	H	P
67 1/8"	48 5/8"	1 7/8"



MELCHOR
CM70X43ML \$405.68

W	H	ID	P
67 1/4"	43 3/8"	4"	2"

ORDER WITH A CENTER HOLE



ORDER ANY MEDALLION SPLIT



AVAILABLE CENTER HOLE SIZES

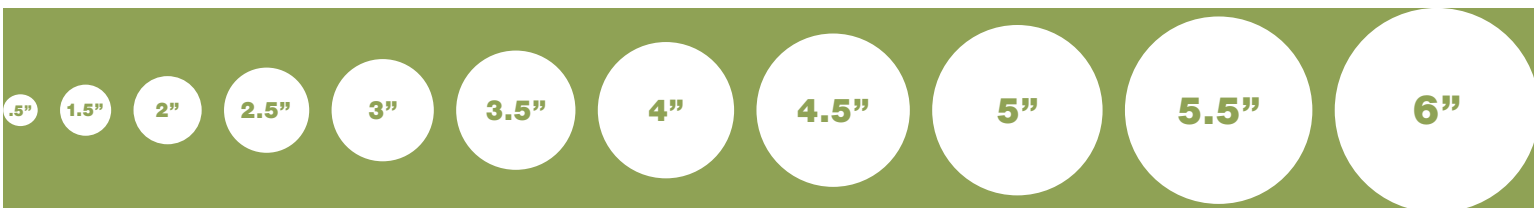

CUSTOM CENTER HOLE: **\$10**
SPLIT IN HALF: **\$10**



FLAT PAINT: **\$45**
SPECIALTY CRACKLE: **\$75**
METAL & WOOD FINISHES: **\$75**



OUTSIDE DIAMETER
INSIDE DIAMETER
PROJECTION



CEILING MEDALLIONS





URETHANE CEILING RINGS

Accents such as ceiling rings and medallions offer a great opportunity to upgrade a plain light fixture or ordinary ceiling space to an extraordinary focal point. These quick install and affordable additions come in durable, dense polyurethane and a vast range of sizes, shapes, and styles.

Ceiling rings and medallions are jewelry for the home, and when paired together, they compose a grand effect. Throw in a sparkling chandelier, modern pendant, or ceiling fan, and the combination creates the perfect signature style. Dream up and inspire an original piece of artwork with our rings by creating your own concept and makeover your ceiling space into something wonderful.



SWINDON: CR09SW
\$15.07

WHOLE

OD	ID	W	P
10"	6 5/8"	1 5/8"	1 1/4"

EGG AND DART: CR21EG
\$26.14

WHOLE

OD	ID	W	P
21 3/8"	16 7/8"	2 1/4"	1"

RAYMOND: CR22RA
\$37.69

WHOLE

OD	ID	W	P
22 1/4"	17 1/4"	2 1/2"	1 1/2"

MIDDLESBOROUGH: CR22MD
\$7.12

QUARTER

OD	ID	W	P
22 3/4"	20 1/4"	1 1/4"	1/2"

EGG AND DART: CR23EG
\$15.31

QUARTER

OD	ID	W	P
23 3/4"	19 3/4"	2"	3/4"

CLAREMONT: CR23CL
\$15.31

QUARTER

OD	ID	W	P
24"	20"	2"	7/8"

★ **SEVILLE: CR26SE**
\$9.50

QUARTER

OD	ID	W	P
26"	23 5/8"	1 1/4"	3/4"

MEDWAY: CR15ME
\$17.81

QUARTER

OD	ID	W	P
26 3/4"	23 1/2"	1 5/8"	3/4"

ORRINGTON: CR28OR
\$9.50

QUARTER

OD	ID	W	P
28 1/2"	25"	1 3/4"	3/4"

FLOWER: CR29FL
\$13.06

QUARTER

OD	ID	W	P
28 3/4"	23 5/8"	2 5/8"	7/8"

HILLSBOROUGH: CR29HI
\$10.68

QUARTER

OD	ID	W	P
28 3/4"	23 5/8"	2 5/8"	5/8"

KENT: CR13KE
\$19.00

QUARTER

OD	ID	W	P
28 3/4"	24 3/4"	2"	1"

MONIQUE: CR29MO
\$15.31

QUARTER

OD	ID	W	P
29 3/4"	23 3/4"	3"	3/8"

MIDDLESBOROUGH: CR34MD
\$9.50

QUARTER

OD	ID	W	P
33 1/2"	31"	1 1/4"	1/2"

HILLSBOROUGH: CR36HI
\$11.87

QUARTER

OD	ID	W	P
35 1/2"	29 1/2"	3"	1"

MEDWAY: CR36ME
\$10.68

QUARTER

OD	ID	W	P
35 1/2"	31 1/2"	2"	7/8"

WATFORD: CR35WA
\$16.62

QUARTER

OD	ID	W	P
36"	29 1/2"	3 1/4"	1"

PIERCED: CR35PI
\$16.62

QUARTER

OD	ID	W	P
36 1/2"	30 1/4"	3 1/8"	3/4"

OXFORD: CR38OX
\$16.62

QUARTER

OD	ID	W	P
38 1/2"	35 1/4"	1 5/8"	3/4"

SOFIA: CR39SI
\$16.62

QUARTER

OD	ID	W	P
39"	35 1/2"	1 3/4"	1/2"

MEDWAY: CR39ME
\$11.87

QUARTER

OD	ID	W	P
39 3/8"	35 1/2"	2"	7/8"

NEVIO: CR39NE
\$20.06

QUARTER

OD	ID	W	P
39 1/2"	33 1/4"	3 1/8"	5/8"

SUSSEX: CR39SU
\$16.62

QUARTER

OD	ID	W	P
40"	36"	2"	7/8"

HILLSBOROUGH: CR41HI
\$16.62

QUARTER

OD	ID	W	P
40 1/4"	34"	3 1/8"	3/4"

MEDEA: CR40MD
\$14.25

QUARTER

OD	ID	W	P
40 3/8"	35 1/2"	2 1/2"	3/4"

DEVON: CR39DE
\$17.68

QUARTER

OD	ID	W	P
40 1/2"	33 1/4"	3 5/8"	1 1/8"

SHELL: CR41SH
\$16.62

QUARTER

OD	ID	W	P
40 5/8"	35 1/2"	2 5/8"	7/8"

FLOWER: CR41FL
\$16.62

QUARTER

OD	ID	W	P
41"	34 1/4"	3 3/8"	3/4"

SEVILLE: CR42SE
\$13.06

QUARTER

OD	ID	W	P
41 3/4"	39 3/8"	1 1/4"	3/4"

TRADITIONAL: CR41TR
\$16.62

QUARTER

OD	ID	W	P
41 3/4"	35 1/4"	3 1/4"	3/4"

★ **ORRINGTON: CR42OR**
\$16.62

QUARTER

OD	ID	W	P
41 7/8"	38 3/8"	1 3/4"	5/8"

EGG AND DART: CR20EG
\$28.37

QUARTER

OD	ID	W	P
42"	36"	3"	3/4"



ROSE: CR41RO
\$28.37

QUARTER

OD	ID	W	P
42 1/2"	36"	3 1/4"	3/4"

ELSINORE: CR43EL
\$21.37

QUARTER

OD	ID	W	P
43 1/4"	36 3/4"	3 1/4"	1/4"

KENT: CR39KE
\$17.81

QUARTER

OD	ID	W	P
43 1/4"	35 1/2"	3 7/8"	1"

MILTON: CR44MI
\$13.06

QUARTER

OD	ID	W	P
43 5/8"	39 3/8"	2 1/8"	7/8"



WAKEFIELD: CR44WA
\$137.72

WHOLE

OD	ID	W	P
44"	30 1/4"	44"	2"

HILLSBOROUGH: CR45HI
\$17.81

QUARTER

OD	ID	W	P
44 1/2"	39 3/8"	2 5/8"	5/8"

BEDFORD: CR44BE
\$21.37

QUARTER

OD	ID	W	P
44 1/2"	39 1/4"	2 3/4"	5/8"

JAMIE: CR46JA
\$15.43

QUARTER

OD	ID	W	P
45 1/2"	39 3/8"	3 1/8"	1/2"

DENTIL AND BEAD: CR47DT
\$23.74

QUARTER

OD	ID	W	P
47"	40 1/2"	3 1/4"	1 1/8"

MONIQUE: CR47MO
\$23.74

QUARTER

OD	ID	W	P
47 1/2"	39 1/4"	4 1/8"	7/8"

TOMANGO: CR49TO
\$37.99

FITTED TOGETHER WITH **ONL04X06X010X**

QUARTER

OD	ID	W	P
49 1/4"	37 1/4"	6"	1 1/4"

SUSSEX: CR49SU
\$21.37

QUARTER

OD	ID	W	P
49 1/4"	45 1/4"	2"	7/8"

SHELL: CR50SH
\$37.99

OD ID W P
50" 43 3/8" 3 3/4" 1"

HILLSBOROUGH: CR50HI
\$21.37

OD ID W P
50" 43 3/8" 3 3/8" 1"

MEDWAY: CR25ME
\$24.93

OD ID W P
50" 47" 1 1/2" 3/4"

DUBLIN: CR50DU
\$26.12

OD ID W P
50" 44" 3" 1 1/4"

TRADITIONAL: CR50TR
\$11.87

OD ID W P
50 3/8" 47 1/4" 1 5/8" 3/4"

**RINGS SHOWN IN A 1/4 VIEW
ARE SOLD AS 1/4 PIECES**

MARCELLA: CR51MA
\$26.12

OD ID W P
51" 43" 4" 7/8"

FLORAL CLASSIC: CR25FL
\$31.93

OD ID W P
51 1/4" 43 1/4" 4" 7/8"

NEXUS: CR52NE
\$17.81

OD ID W P
52" 47 1/4" 2 3/8" 1 1/4"

KENT: CR25KE
\$28.49

OD ID W P
52" 48" 2" 1"

★ **OXFORD: CR52OX**
\$28.49

OD ID W P
52" 47" 2" 3/4"

MEDEA: CR52MD
\$15.43

OD ID W P
52 1/8" 47 1/4" 2 1/2" 3/4"

MILTON: CR55MI
\$21.37

OD ID W P
54 1/4" 50 1/4" 2" 3/4"

SEQUENTIAL: CR55SQ
\$27.18

OD ID W P
55" 46 3/4" 4 1/8" 1 1/8"

FELIX: CR55FX
\$23.74



QUARTER

OD	ID	W	P
55 3/8"	47 3/8"	4"	7/8"

FLOWER: CR59FL
\$23.74



QUARTER

OD	ID	W	P
55 3/4"	52 1/4"	3 1/4"	3/4"

SEVILLE: CR57SE
\$23.74



QUARTER

OD	ID	W	P
57 1/4"	53 3/4"	1 3/4"	1 1/4"

TIRANA: CR57TI
\$41.55
FITTED TOGETHER WITH **ONL02X03X00BL**



QUARTER

OD	ID	W	P
57 3/8"	46 1/8"	5 5/8"	1"

POMPEII: CR59PO
\$26.12



QUARTER

OD	ID	W	P
58 5/8"	53 5/8"	2 1/2"	7/8"

KENT: CR59KE
\$19.95



QUARTER

OD	ID	W	P
59"	52"	3 1/2"	3/4"

ARTIS EGG AND DART: CR59AR
\$37.99



QUARTER

OD	ID	W	P
59"	51 3/4"	3 5/8"	1"

HILLSBOROUGH: CR59HI
\$21.37



QUARTER

OD	ID	W	P
59 1/8"	53 1/8"	3"	1"

MILTON: CR59MI
\$19.00



QUARTER

OD	ID	W	P
59 3/8"	55 1/8"	2 1/8"	7/8"

DYLAN: CR59DY
\$26.12



QUARTER

OD	ID	W	P
59 1/2"	51 1/2"	4"	1 1/2"

TRALEE: CR59TE
\$26.12



QUARTER

OD	ID	W	P
59 1/2"	53"	2 3/4"	1/2"

FEDERAL: CR67FE
\$29.55



QUARTER

OD	ID	W	P
63"	54 1/4"	4 3/8"	3/4"

EDINBURGH: CR63ED
\$30.87



QUARTER

OD	ID	W	P
63 1/2"	53 3/8"	5"	3/4"

★ **HILLSBOROUGH: CR63HI**
\$28.49



QUARTER

OD	ID	W	P
63 1/2"	59"	2 1/4"	3/4"

CORNELIA: CR64CN
\$20.66



QUARTER

OD	ID	W	P
63 3/4"	55 7/8"	3 7/8"	3/4"

MEDEA: CR64MD
\$17.81



QUARTER

OD	ID	W	P
64"	59 1/8"	2 1/2"	3/4"

ROSE: CR32RO
\$35.62



QUARTER

OD	ID	W	P
64"	57 1/2"	3 1/4"	7/8"

TRADITIONAL: CR64TR
\$26.12



QUARTER

OD	ID	W	P
64 1/2"	58"	3 1/4"	1"

HILLSBOROUGH: CR65HI
\$26.12



QUARTER

OD	ID	W	P
64 1/2"	58"	3 1/4"	1"

CAPUTO: CR64CA
\$26.12



QUARTER

OD	ID	W	P
64 3/4"	58 1/4"	3 1/4"	3/4"

SHELL: CR66SH
\$47.49

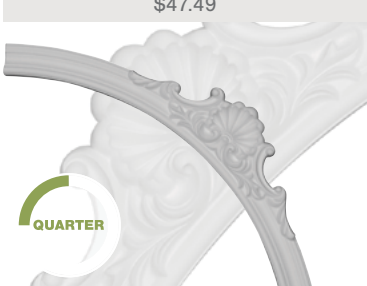

QUARTER

OD	ID	W	P
65 3/4"	59 1/8"	3 3/4"	1"

SOUTHAMPTON: CR67SO
\$34.30



QUARTER

OD	ID	W	P
66 3/4"	58"	4 3/8"	1"

TRISTAN: CR67TR
\$29.68



QUARTER

OD	ID	W	P
67 3/8"	58 5/8"	5"	7/8"

BRADFORD: CR67BR
\$43.54

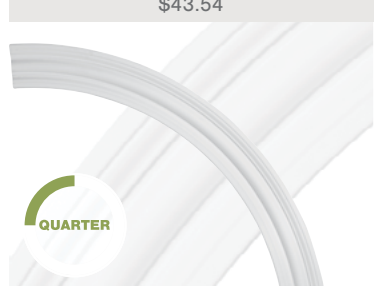

QUARTER

OD	ID	W	P
68"	58"	5"	1"

CHESTERFIELD: CR69CH
\$30.87



QUARTER

OD	ID	W	P
69"	62 3/4"	3 1/8"	1 1/4"

JAMIE: CR69JA
\$19.00



QUARTER

OD	ID	W	P
69 1/8"	63"	3 1/8"	1/2"

HILLSBOROUGH: CR70HI
\$23.74



QUARTER

OD	ID	W	P
69 3/4"	63"	3 3/8"	1"

★ **CAPUTO: CR70CA**
\$30.87



QUARTER

OD	ID	W	P
70"	63 1/2"	3 1/4"	5/8"

PALMETTO: CR70PM
\$35.36



QUARTER

OD	ID	W	P
71 1/4"	62 3/4"	4 1/4"	1 3/8"

BEDFORD: CR70BE
\$41.17



QUARTER

OD	ID	W	P
71 3/8"	61 3/8"	5"	1 5/8"

MEDWAY: CR73ME
\$30.87



QUARTER

OD	ID	W	P
74 3/4"	68 1/2"	3 1/8"	1/2"

NEXUS: CR76NE
\$23.74

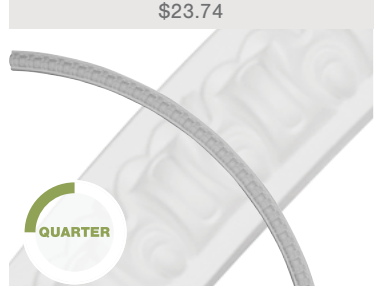

QUARTER

OD	ID	W	P
75 5/8"	70 7/8"	2 3/8"	1 1/4"

OUTSIDE DIAMETER
INSIDE DIAMETER



PROJECTION
WIDTH

CEILINGRINGS

FLORAL CLASSIC: CR37FL
\$40.36

QUARTER

OD	ID	W	P
76"	68"	4"	7/8"

DYLAN: CR77DY
\$23.74

QUARTER

OD	ID	W	P
77 1/4"	71 7/8"	3 1/8"	3/4"

SHELL: CR77SH
\$54.61

QUARTER

OD	ID	W	P
77 5/8"	70 7/8"	3 3/8"	1"

SHELL: CR78SH
\$59.23

QUARTER

OD	ID	W	P
78 1/8"	64 7/8"	6 5/8"	1"

SPIRAL: CR78SP
\$43.54

QUARTER

OD	ID	W	P
79 1/2"	70 1/4"	4 5/8"	1 1/8"

MILTON: CR78MI
\$40.92

QUARTER

OD	ID	W	P
84 3/4"	74 1/4"	5 1/4"	1"

MARCELLA: CR87MA
\$36.80

QUARTER

OD	ID	W	P
86 5/8"	78 3/4"	4"	7/8"

ABERDEEN: CR87AB
\$45.11

QUARTER

OD	ID	W	P
87 3/8"	78 3/4"	4 3/8"	3/4"



LEGACY: CR86LE
\$40.11

QUARTER

OD	ID	W	P
87 1/2"	79 1/4"	4 1/8"	1 1/2"

SHELL: CR93SH
\$60.55

QUARTER

OD	ID	W	P
93 3/8"	86 5/8"	3 3/8"	1"

TRADITIONAL: CR96TR
\$117.15

QUARTER

OD	ID	W	P
93 1/2"	77 3/4"	7 7/8"	2 3/4"

HILLSBOROUGH: CR95HI
\$40.36

QUARTER

OD	ID	W	P
94 1/2"	86 5/8"	4"	1 1/4"



URETHANE CEILING DOMES

Urethane ceiling domes enhance interiors with rich texture and traditional appeal. Many of our urethane ceiling domes include classic decorative details, ranging from floral motifs to crisp features. Whether you seek something subtle or ornate, there's a design for every style. Each ceiling dome is factory primed and ready for paint or faux finish. Each dome is manufactured out of a high-density urethane foam, which is great for durability, but is also lighter than other materials to make installation a snap. Enhance your space with a beautiful ceiling dome focal piece.

Our ceiling tile collections are modeled after original historical patterns and designs. Each piece is molded with rich texture and deep relief, sharp lines for a truly unique look. The dense urethane tiles are beautifully detailed and light weight, offering a new easy install alternative to other ceiling accents. Ceiling tiles are great for covering damaged or popcorn ceilings, allowing a new surface without losing ceiling height. Grid drop ceilings are easy to care for and are perfect for hiding duct work and wiring or allowing ready access to pipes. There is a ceiling tile style to meet every taste. Basic, modern, classic and elaborate styles offer a range of looks.

OUTSIDE DIAMETER
INSIDE DIAMETER
DEPTH



CEILING DOMES

DUBLIN: DOME26DU



OD	ID	D	\$
26 7/8"	25"	3 7/8"	\$109.60

TRADITIONAL: DOME28TR



OD	ID	D	\$
28"	22 1/2"	4 5/8"	\$227.94

MILTON: DOME31MI



OD	ID	D	\$
31 7/8"	25 1/8"	7 3/8"	\$230.32

NEXUS: DOME32NE

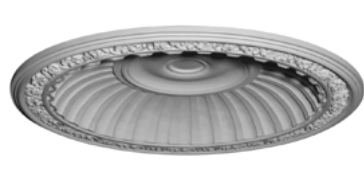

OD	ID	D	\$
32 1/2"	26"	4 1/8"	\$296.80

CHESTERFIELD: DOME35CH



OD	ID	D	\$
35"	27 7/8"	5 5/8"	\$232.69

★ **DEVON: DOME35DE**



OD	ID	D	\$
35 3/8"	27 1/2"	3 1/4"	\$166.21

TRADITIONAL: DOME32TR

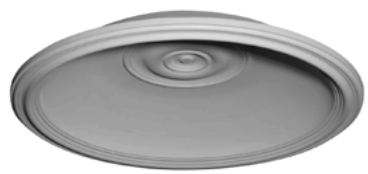

OD	ID	D	\$
36 5/8"	32 5/8"	6 1/2"	\$334.79

ODESSA: DOME38OD



OD	ID	D	\$
38 1/2"	30 3/4"	6 1/2"	\$287.30

ARTISAN: DOME38AR



OD	ID	D	\$
38 5/8"	35 7/8"	7"	\$379.90

MILTON: DOME39MI



OD	ID	D	\$
39 3/8"	31 1/8"	4 1/8"	\$232.69

HILLOCK: DOME39HI



OD	ID	D	\$
39 1/2"	32"	10 3/8"	\$287.30

HAMILTON: DOME42HA



OD	ID	D	\$
42 7/8"	35 3/8"	8 1/4"	\$351.41

SMOOTH: DOME44SM



OD	ID	D	\$
44 1/8"	39"	8 3/8"	\$453.26

EDWARDS: DOME44ED



OD	ID	D	\$
44 1/8"	37"	6 7/8"	\$468.86

DEVON: DOME44X35DE



OL	OW	IL	IW	D	\$
45"	35 1/2"	39"	31"	3 3/4"	\$472.51

BENSON: DOME46BE



OD	ID	D	\$
45 5/8"	39 3/8"	8"	\$488.41

MILTON: DOME47MI



OD	ID	D	\$
47"	38 3/8"	5 1/4"	\$403.65

SALEM: DOME47SA



OD	ID	D	\$
47 1/8"	39 1/4"	9 3/8"	\$1,215.35

STOCKPORT: DOME47ST



OD	ID	D	\$
47 1/4"	39 3/8"	6 3/8"	\$531.87

CLAREMONT: DOME47CL



OD	ID	D	\$
47 3/8"	38 3/8"	10 3/8"	\$403.65

DEVON: DOME47DE



OD	ID	D	\$
47 3/8"	38 3/8"	3 3/4"	\$353.79

ANDREA: DOME47AN



OD	ID	D	\$
47 1/2"	41 3/4"	8 5/8"	\$668.65

ARTISAN: DOME50AR



OD	ID	D	\$
50 3/8"	48"	8 7/8"	\$679.08

DUBLIN: DOME51DU



OD	ID	D	\$
50 7/8"	43 1/2"	6 3/8"	\$455.88

HILLSBOROUGH: DOME51HI



OD	ID	D	\$
51 1/8"	44 3/8"	11 1/2"	\$546.11

BEDFORD: DOME53BE



OD	ID	D	\$
53 7/8"	46"	8"	\$609.71

VADUZ: DOME57VA



OD	ID	D	\$
57 1/8"	49 5/8"	8 3/8"	\$886.58

FLORAL: DOME59FL



OD	ID	D	\$
59"	47"	11"	\$1,020.99

DUBLIN: DOME59DU



OD	ID	D	\$
59 1/4"	50 1/8"	8 3/8"	\$641.09

★ **CLAREMONT: DOME60CL**



OD	ID	D	\$
60 3/4"	50 1/8"	12 5/8"	\$759.81

ARTISAN: DOME62AR



OD	ID	D	\$
63 5/8"	59 1/2"	13 3/8"	\$1,028.08

MEDWAY: DOME58ME



OD	ID	D	\$
68"	60"	9 7/8"	\$860.72

ASHLEY: DOME63AS



OD	ID	D	\$
71"	52 1/2"	9 1/2"	\$979.44

ARTISAN: DOME74AR



OD	ID	D	\$
74"	71 5/8"	19 1/4"	\$1,246.56

HILLSBOROUGH: DOME79HI



OD	ID	D	\$
79 1/2"	70 1/2"	16 1/4"	\$1,448.38

ARTISAN: DOME87AR



OD	ID	D	\$
87"	84 1/4"	24"	\$1,593.16

SURFACE MOUNT

ASHFORD: DOME28AS



OD	ID	D	\$
28 7/8"	22"	2 1/4"	\$223.02

BEDFORD: DOME34BE



OD	ID	D	\$
34 1/2"	25"	3 1/2"	\$252.70

TRADITIONAL: DOME37TR



OD	ID	D	\$
37 3/8"	26 1/2"	4"	\$178.08





URETHANE BRACKETS & CORBELS

These brackets are truly unique in design and function. Primarily used in decorative applications, urethane brackets can make a dramatic difference in kitchens, bathrooms, entryways, fireplace surrounds, and more. A durable choice for shelves or under countertops and cabinets for a lasting transformation. Urethane brackets are smooth and easy to paint for a flawless finish. Perfect for exterior applications on porches, entryways or embellished trim, urethane brackets will not rot or crack and are impervious to insect infestations. The detailed craftsmanship is incomparable in beauty and quality. The most variety of patterns and sizes anywhere, there is one to match every decor style and project need.

214.613.2285 | Info@ArchitecturalBling.com | ArchitecturalBling.com

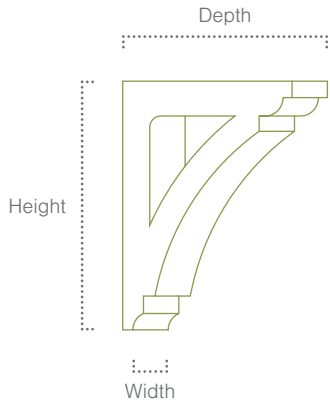



Brackets & Corbels are complimented by other features, such as rafter tails, gable brackets, gable vents, door & window trim, and columns.





ASHFORD BRACKET







3 Sizes

Part No.	W	D	H	\$
 BKT02X11X11AS	2"	11 7/8"	11 7/8"	\$30.55
 BKT02X13X13AS	2"	13 7/8"	13 7/8"	\$34.91
 BKT02X15X15AS	2"	15 7/8"	15 7/8"	\$47.49



DUBLIN BRACKET





7 Sizes

Part No.	W	D	H	\$
 BKT09X05X05DU	5 5/8"	9 3/8"	5 3/4"	\$20.42
 BKT06X07X05DU	6"	7 1/2"	5"	\$14.96
 BKT06X11X06DU	6"	11 1/2"	6"	\$31.79
 BKT13X06X05DU	6"	13"	5 7/8"	\$39.79
 BKT07X07X05DU	7"	7 1/2"	5"	\$18.08
 BKT07X09X05DU	7"	9 1/2"	5 1/2"	\$24.62
 BKT08X11X06DU	8"	11 1/2"	6"	\$34.29



DIANE BRACKET







4 Sizes

Part No.	W	D	H	\$
 BKT03X04X08DI	3 1/2"	4 1/4"	8"	\$19.32
 BKT05X10X03DI	4"	5 1/4"	10"	\$23.68
 BKT04X06X12DI	4 1/2"	6 1/2"	12"	\$28.06
 BKT05X07X14DI	5"	7"	14"	\$33.66



WIGAN BRACKET





6 Sizes

Part No.	W	D	H	\$
 BKT03X04X07WG	3 1/2"	4"	7"	\$21.69
 BKT05X06X04WG	4 1/2"	5 1/4"	6"	\$29.62
 BKT05X04X08WG	5 1/4"	4 1/2"	8"	\$26.99
 BKT05X04X10WG	5 1/4"	4 1/2"	10"	\$32.29
 BKT06X06X08WG	6"	6"	8"	\$33.04
 BKT06X06X12WG	6"	6"	12"	\$46.76



RICHMOND BRACKET





4 Sizes

★	Part No.	W	D	H	\$
	BKT04X12X12RI	4"	12"	12"	\$67.07
	BKT04X12X16RI	4"	12"	16"	\$74.54
	BKT04X15X16RI	4"	15"	16"	\$82.83
	BKT04X18X24RI	4"	18 5/8"	24"	\$110.49



EDINBURGH BRACKET



4 Sizes

Part No.	W	D	H	\$	
	BKT03X07X05ED	3 1/2"	5"	7"	\$20.88
	BKT03X09X07ED	3 1/2"	7"	9"	\$24.00
	BKT10X16X04ED	4 1/8"	10 3/8"	16 3/8"	\$48.02
	BKT04X10X10ED	4 1/8"	10 1/2"	10 1/2"	\$26.18



IMPERIAL BRACKET

2 Sizes

Part No.	W	D	H	\$	
	BKT16X16X04IM	4"	16"	16"	\$81.03
	BKT20X20X04IM	4"	20"	20"	\$99.72



TRADITIONAL BRACKET



7 Sizes

Part No.	W	D	H	\$	
	COR05X02X07TR	2 7/8"	5 7/8"	7 1/4"	\$27.52
	COR02X06X10TR	2 7/8"	5 7/8"	10"	\$21.19
	COR02X07X14TR	2 7/8"	7 1/2"	14"	\$34.29
	COR04X06X07TR	4 1/2"	5 7/8"	7 1/4"	\$22.44
	COR04X06X10TR	4 1/2"	5 7/8"	10"	\$29.91
	COR04X07X10TR	4 1/2"	7 1/2"	10"	\$33.04
	COR04X07X14TR	4 1/2"	7 1/2"	14"	\$38.65



TRADITIONAL BRACKET

2 Sizes

Part No.	W	D	H	\$	
	BKT03X15X19TR	2 5/8"	14 1/2"	14 3/8"	\$39.07
	BKT03X07X10TR	3"	7 5/8"	10 5/8"	\$32.11



LEGACY BRACKET

11 Sizes



LEGACY CLASSIC BRACKET

13 Sizes













★	Part No.	W	D	H	\$
	BKT10X10X03LE	3"	10"	10"	\$28.67
	BKT12X12X03LE	3"	12"	12"	\$43.86
	BKT14X14X03LE	3 1/2"	14"	14"	\$37.40
	BKT16X16X03LE	3 1/2"	16"	16"	\$28.49
	BKT18X18X03LE	3 1/2"	18"	18"	\$62.33
	BKT12X12X05LE	5 1/2"	12"	12"	\$37.40
	BKT14X14X05LE	5 1/2"	14"	14"	\$49.86
	BKT16X16X05LE	5 1/2"	16"	16"	\$30.87
	BKT18X18X05LE	5 1/2"	18"	18"	\$68.56
	BKT24X24X05LE	5 1/2"	24"	24"	\$81.03
	BKT08X30X30LE	8"	30"	30"	\$137.74

	Part No.	W	D	H	\$
	BKT06X06X02LE	2 7/8"	6"	6"	\$18.08
	BKT08X08X02LE	2 7/8"	8"	8"	\$20.38
	BKT04X06X06LE	4"	6"	6"	\$14.96
	BKT06X06X04LE	4 7/8"	6"	6"	\$19.32
	BKT08X08X04LE	4 7/8"	8"	8"	\$23.86
	BKT10X10X04LE	4 7/8"	10"	10"	\$23.68
	BKT06X06X06LE	6 7/8"	6"	6"	\$22.44
	BKT08X08X06LE	6 7/8"	8"	8"	\$24.32
	BKT10X10X06LE	6 7/8"	10"	10"	\$26.81
	BKT12X12X06LE	6 7/8"	12"	12"	\$33.09
	BKT08X08X08LE	8 7/8"	8"	8"	\$28.06
	BKT10X10X08LE	8 7/8"	10"	10"	\$31.16
	BKT12X12X08LE	8 7/8"	12"	12"	\$37.47



STOCKPORT BRACKET

12 Sizes

Part No.	W	D	H	\$
 BKT03X05X05ST	3"	5 1/2"	5 1/2"	\$15.40
 BKT03X05X07ST	3"	5 1/2"	7 1/4"	\$16.95
 BKT03X07X07ST	3"	7 1/4"	7 1/4"	\$18.20
 BKT03X07X09ST	3"	7 1/4"	9"	\$20.14
 BKT05X05X05ST	5"	5 1/2"	5 1/2"	\$21.57
 BKT05X05X07ST	5"	5 1/2"	7 1/4"	\$23.25
 BKT05X07X07ST	5"	7 1/4"	7 1/4"	\$24.74
 BKT05X07X09ST	5"	7 1/4"	9"	\$26.49
 BKT07X07X05ST	5 1/2"	7 1/4"	7 1/4"	\$30.90
 BKT07X05X05ST	7 1/4"	5 1/2"	5 1/2"	\$23.37
 BKT07X07X07ST	7 1/4"	7 1/4"	7 1/4"	\$26.92
 BKT07X07X09ST	7 1/4"	7 1/4"	9"	\$28.80

SOUTHAMPTON

BKT11X11X00SO

W 3/4"
D 11"
H 11"
\$ \$28.49



SWANSEA

BKT11X11X00SW

W 7/8"
D 11"
H 12"
\$ \$28.49



VERSAILLES

BKT01X11X12VE

W 1"
D 11 1/2"
H 12 1/4"
\$ \$21.37



WAKEFIELD

BKT12X12X01WA

W 1"
D 12"
H 12"
\$ \$26.12



CHESTERFIELD

BKT13X14X01CH

W 1"
D 13"
H 14 5/8"
\$ \$34.43



ASHFORD

BKT18X17X01AS

W 1 1/4"
D 17"
H 18"
\$ \$40.36



ABERDEEN

BKT02X09X16AB

W 2 3/4"
D 9 3/4"
H 16"
\$ \$56.99



TYRONE

BKT02X11X17TY

W 2 7/8"
D 11"
H 17"
\$ \$52.24



FEDERAL

BKT03X10X11FE

W 3"
D 10 1/2"
H 11 1/4"
\$ \$39.19



★ **TIRANA**

BKT03X05X05TI

W 3 1/2"
D 5 1/2"
H 5 1/2"
\$ \$29.69



EMERY

BKT03X28X30EM

W 3 1/2"
D 28"
H 30"
\$ \$119.97



WIRRAL

BKT14X15X04WI

W 4"
D 14"
H 15 3/4"
\$ \$71.30



CLAREMONT

BKT16X20X04CL

W 4"
D 16"
H 20"
\$ \$103.22



BEDFORD

BKT06X12X04BE

W 4 1/4"
D 6 1/2"
H 12"
\$ \$39.57



POLYURETHANE

CAN SUPPORT UP TO 20LBS WITH PROPER INSTALLATION
 MODELED AFTER ORIGINAL HISTORICAL PATTERNS AND DESIGNS
 FACTORY PRIMED AND READY FOR PAINT OR FAUX FINISH

LANARKSHIRE

BKT07X04X04LA

W 4 5/8"
D 7 1/2"
H 4"
\$ \$31.72



SUSSEX

BKT07X04X04SU

W 4 5/8"
D 7 1/2"
H 4"
\$ \$20.07



REECE

BKT05X14X12RE

W 5"
D 14 3/4"
H 12 1/2"
\$ \$54.30



DOVER

BKT07X11X05DR

W 5 1/2"
D 11 3/4"
H 7 1/4"
\$ \$39.18



EDWARDS

BKT06X10X02ED

W 6"
D 2"
H 10 3/8"
\$ \$18.04



WAKEFIELD

BKT06X05X04WA

W 6"
D 6 1/4"
H 4 5/8"
\$ \$22.07



COLE

BKT06X18X10CO

W 6"
D 10 1/8"
H 18"
\$ \$65.30



TEMPLE

BKT06X10X05TE

W 6"
D 10 3/4"
H 5 1/4"
\$ \$35.68

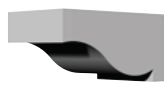

GIANA

BKT11X06X05GI

W 6 1/4"
D 11 3/4"
H 5 7/8"
\$ \$52.81



NIOBE

BKT10X12X07NI

W 7 1/4"
D 12"
H 10 1/8"
\$ \$71.63



NEXUS LEFT

BKT07X04X06NE-L

W 7 1/2"
D 6 1/4"
H 4"
\$ \$27.74



NEXUS RIGHT

BKT07X04X06NE-R

W 7 1/2"
D 6 1/4"
H 4"
\$ \$27.74



FEDERAL

BKT07X04X05FE

W 7 5/8"
D 5 1/4"
H 4"
\$ \$30.37



LUNEL

BKT07X03X05LU

W 7 3/4"
D 5 1/8"
H 3 1/2"
\$ \$31.05



TRADITIONAL STEP

BKT08X09X06TS 

W 8"
D 9 1/8"
H 6 7/8"
\$ \$47.17



GENEVIEVE

COR12X02X07GE

W 2 1/8"
D 7 7/8"
H 12 1/8"
\$ \$55.16



 **DEVON**

COR02X02X04DE

W 2 1/4"
D 2 1/4"
H 4 1/4"
\$ \$14.66



ALEXANDRIA

COR02X01X03AL

W 2 5/8"
D 1 3/8"
H 3 5/8"
\$ \$5.22



 **ODESSA**

COR02X01X03OD

W 2 5/8"
D 1 3/8"
H 3 5/8"
\$ \$5.23



GRANADA

COR02X01X05GR

W 2 3/4"
D 1 5/8"
H 5 1/2"
\$ \$26.24



HELENE

COR02X01X04HE

W 2 7/8"
D 1 1/2"
H 4 3/8"
\$ \$22.16



VALLETA

COR02X01X04VL

W 2 7/8"
D 1 5/8"
H 4 3/8"
\$ \$19.98



ORION

COR03X01X04OR

W 3"
D 1 1/2"
H 4 7/8"
\$ \$22.16



ALEXANDRIA

COR03X02X04AL

W 3"
D 1 5/8"
H 4 3/8"
\$ \$7.12



HAMPSHIRE

COR03X01X08HA

W 3"
D 1 7/8"
H 8 1/2"
\$ \$25.92



LEAF

COR03X01X05LE

W 3 1/8"
D 3/4"
H 5"
\$ \$17.45



OXFORD

COR03X05X01OX

W 3 1/8"
D 1 1/2"
H 5 1/8"
\$ \$15.64



COLE

COR03X03X06CO

W 3 1/8"
D 3"
H 5 1/4"
\$ \$12.84



WIDTH
DEPTH
HEIGHT



















BRACKETS & CORBELS



USE WITH A RANGE HOOD
FOR AN AFFORDABLE UPGRADE
THAT ADDS VALUE TO YOUR KITCHEN

PRO TIP

<p>GENEVIEVE</p> <p>COR18X03X12GE</p> <p>W 3 1/4"</p> <p>D 12 1/8"</p> <p>H 18 1/4"</p> <p>\$ \$94.89</p> 	<p>OXFORD</p> <p>COR03X02X07OX</p> <p>W 3 3/8"</p> <p>D 2 1/2"</p> <p>H 7 3/4"</p> <p>\$ \$25.90</p> 	<p>BALTIMORE</p> <p>COR03X01X04BA</p> <p>W 3 1/2"</p> <p>D 1 5/8"</p> <p>H 4 1/8"</p> <p>\$ \$23.57</p> 	<p>★ NORWICH</p> <p>COR03X02X06NO</p> <p>W 3 1/2"</p> <p>D 2 1/4"</p> <p>H 6 1/8"</p> <p>\$ \$12.42</p> 
<p>MARIA</p> <p>COR03X02X11MA</p> <p>W 3 1/2"</p> <p>D 2 1/2"</p> <p>H 11 5/8"</p> <p>\$ \$20.95</p> 	<p>APOLLO</p> <p>COR03X02X06AP</p> <p>W 3 1/2"</p> <p>D 2 3/4"</p> <p>H 6"</p> <p>\$ \$25.28</p> 	<p>LEAF</p> <p>COR04X02X07LE</p> <p>W 3 5/8"</p> <p>D 2 1/8"</p> <p>H 7"</p> <p>\$ \$21.49</p> 	<p>SCROLL</p> <p>COR03X02X06SC</p> <p>W 3 5/8"</p> <p>D 2 1/2"</p> <p>H 6 1/8"</p> <p>\$ \$11.31</p> 
<p>★ KENT</p> <p>COR17X03X08KE</p> <p>W 3 5/8"</p> <p>D 8 5/8"</p> <p>H 17 1/4"</p> <p>\$ \$88.17</p> 	<p>NORWICH</p> <p>COR03X01X07NO</p> <p>W 3 3/4"</p> <p>D 1 7/8"</p> <p>H 7 1/8"</p> <p>\$ \$13.90</p> 	<p>BRADLEY</p> <p>COR04X02X06BY</p> <p>W 3 3/4"</p> <p>D 2 1/4"</p> <p>H 5 3/4"</p> <p>\$ \$7.12</p> 	<p>MARCELLA</p> <p>COR03X09X14MA</p> <p>W 3 3/4"</p> <p>D 9 5/8"</p> <p>H 14 1/2"</p> <p>\$ \$62.86</p> 
<p>★ SCROLL LEAF</p> <p>COR03X01X05SC</p> <p>W 3 7/8"</p> <p>D 1 1/4"</p> <p>H 5 1/4"</p> <p>\$ \$9.43</p> 	<p>BALTIMORE</p> <p>COR03X02X05BA</p> <p>W 3 7/8"</p> <p>D 2 1/8"</p> <p>H 5 7/8"</p> <p>\$ \$25.76</p> 	<p>ROSE</p> <p>COR04X02X06RO</p> <p>W 3 7/8"</p> <p>D 2 1/4"</p> <p>H 5 3/4"</p> <p>\$ \$9.50</p> 	<p>LEGACY</p> <p>COR03X02X05LE</p> <p>W 3 7/8"</p> <p>D 2 3/4"</p> <p>H 5 7/8"</p> <p>\$ \$18.70</p> 

ODESSA
 COR03X05X27OD
W 3 7/8"
D 5 1/4"
H 27"
\$ \$53.48



HAMPSHIRE
 COR04X02X09HA
W 4"
D 2 1/8"
H 9 5/8"
\$ \$25.93



ASHTON
 COR04X02X06AS
W 4"
D 2 3/8"
H 6 1/8"
\$ \$7.12



BERKSHIRE
 COR04X03X07BE
W 4"
D 2 5/8"
H 6 5/8"
\$ \$11.87



DUBLIN
 COR04X03X05DU
W 4"
D 2 3/4"
H 5 5/8"
\$ \$23.57



LEAF
 COR04X03X07LE
W 4"
D 3 3/8"
H 7 1/8"
\$ \$17.81



★ **DEVON**
 COR04X04X07DE
W 4"
D 4"
H 7 1/2"
\$ \$22.56



LEANDROS
 COR04X05X03LE
W 4 1/8"
D 3"
H 5 3/4"
\$ \$24.87



COLE
 COR04X02X06CO
W 4 1/4"
D 2 3/8"
H 6 3/8"
\$ \$24.05



HAMPSHIRE
 COR04X02X11HA
W 4 1/4"
D 2 1/2"
H 10 7/8"
\$ \$25.95



BLACKTHORNE
 COR04X02X05BL
W 4 1/4"
D 2 5/8"
H 5 3/4"
\$ \$9.39



NEEDHAM
 COR04X04X12NE
W 4 1/4"
D 4 3/8"
H 12 3/4"
\$ \$57.66



PALMETTO
 COR04X02X05PA
W 4 3/8"
D 2 1/2"
H 5 5/8"
\$ \$24.72



REECE
 COR04X07X03RE
W 4 3/8"
D 3 1/8"
H 7 7/8"
\$ \$22.74



ASA
 COR04X01X10AS
W 4 1/2"
D 1 3/4"
H 10"
\$ \$21.98



JEFFERSON
 COR05X05X12JE 
W 4 1/2"
D 5"
H 11 7/8"
\$ \$22.56































ORNATE OR
SMOOTH
HISTORIC OR
MODERN

WIDTH
DEPTH
HEIGHT



BRACKETS & CORBELS

<p>GORLEEN</p> <p>COR04X02X09GO</p> <p>W 4 5/8"</p> <p>D 2 5/8"</p> <p>H 9 3/4"</p> <p>\$ \$35.62</p> 	<p>DUBLIN</p> <p>COR05X02X05DU</p> <p>W 4 5/8"</p> <p>D 2 3/4"</p> <p>H 5 1/2"</p> <p>\$ \$25.69</p> 	<p>LEGACY</p> <p>COR04X02X06LE</p> <p>W 4 5/8"</p> <p>D 2 3/4"</p> <p>H 6 3/4"</p> <p>\$ \$25.01</p> 	<p>TIRANA</p> <p>COR04X03X06TI</p> <p>W 4 5/8"</p> <p>D 3"</p> <p>H 6 3/8"</p> <p>\$ \$12.72</p> 
<p>COLE</p> <p>COR05X03X06CO</p> <p>W 4 5/8"</p> <p>D 3 1/8"</p> <p>H 6 1/4"</p> <p>\$ \$9.50</p> 	<p>SCROLL LEAF</p> <p>COR04X05X10SC</p> <p>W 4 5/8"</p> <p>D 5 1/4"</p> <p>H 10 3/4"</p> <p>\$ \$51.76</p> 	<p>CHERRY CLUSTER</p> <p>COR04X05X09CH</p> <p>W 4 5/8"</p> <p>D 5 1/2"</p> <p>H 9 3/8"</p> <p>\$ \$27.61</p> 	<p>ANGEL</p> <p>COR05X06X10AN</p> <p>W 4 5/8"</p> <p>D 5 3/4"</p> <p>H 9 5/8"</p> <p>\$ \$20.18</p> 
<p>LEGACY</p> <p>COR12X04X02LE</p> <p>W 4 3/4"</p> <p>D 2 3/4"</p> <p>H 12 1/4"</p> <p>\$ \$45.47</p> 	<p>ZEPHYR</p> <p>COR04X03X09ZE</p> <p>W 4 3/4"</p> <p>D 3"</p> <p>H 9 7/8"</p> <p>\$ \$16.91</p> 	<p>WALTZ</p> <p>COR04X06X03WA</p> <p>W 4 3/4"</p> <p>D 3 1/8"</p> <p>H 6 1/4"</p> <p>\$ \$22.74</p> 	<p>FORREST</p> <p>COR06X04X03FO</p> <p>W 4 3/4"</p> <p>D 3 1/8"</p> <p>H 6 3/4"</p> <p>\$ \$22.74</p> 
<p>SALO</p> <p>COR04X03X09SA</p> <p>W 4 3/4"</p> <p>D 3 1/8"</p> <p>H 9 3/4"</p> <p>\$ \$16.76</p> 	<p>TRADITIONAL</p> <p>COR04X06X03TR</p> <p>W 4 3/4"</p> <p>D 3 1/2"</p> <p>H 6 3/4"</p> <p>\$ \$22.74</p> 	<p>★ REECE</p> <p>COR04X07X14RE</p> <p>W 4 3/4"</p> <p>D 7 1/2"</p> <p>H 14"</p> <p>\$ \$50.00</p> 	<p>LEAF</p> <p>COR04X02X15LF</p> <p>W 4 7/8"</p> <p>D 2 3/4"</p> <p>H 15 1/4"</p> <p>\$ \$26.66</p> 
<p>HAMILTON</p> <p>COR04X05X10HA</p> <p>W 4 7/8"</p> <p>D 5 1/2"</p> <p>H 10 1/8"</p> <p>\$ \$26.40</p> 	<p>KIRKE</p> <p>COR04X05X09KI</p> <p>W 4 7/8"</p> <p>D 5 5/8"</p> <p>H 9 5/8"</p> <p>\$ \$28.58</p> 	<p>SALEM</p> <p>COR05X02X07SA</p> <p>W 5"</p> <p>D 2 1/2"</p> <p>H 7 7/8"</p> <p>\$ \$25.90</p> 	<p>COLTON</p> <p>COR05X02X09CO</p> <p>W 5"</p> <p>D 2 5/8"</p> <p>H 9 3/4"</p> <p>\$ \$27.22</p> 
<p>NICOLE</p> <p>COR05X03X06NI</p> <p>W 5"</p> <p>D 3 1/2"</p> <p>H 6 1/4"</p> <p>\$ #N/A</p> 	<p>ATTICA</p> <p>COR05X03X08AT</p> <p>W 5"</p> <p>D 3 5/8"</p> <p>H 8 3/8"</p> <p>\$ \$24.84</p> 	<p>SALEM</p> <p>COR05X06X14SA</p> <p>W 5"</p> <p>D 6"</p> <p>H 14"</p> <p>\$ \$61.30</p> 	<p>HESTIA</p> <p>COR05X10X10HE</p> <p>W 5"</p> <p>D 10"</p> <p>H 10"</p> <p>\$ \$45.11</p> 
<p>LISBON</p> <p>COR05X04X09LI</p> <p>W 5 1/8"</p> <p>D 3 3/4"</p> <p>H 8 7/8"</p> <p>\$ \$17.81</p> 	<p>DYLAN</p> <p>COR05X05X08DY</p> <p>W 5 1/8"</p> <p>D 4 1/2"</p> <p>H 7 7/8"</p> <p>\$ \$15.43</p> 	<p>ROSE</p> <p>COR05X02X08RO</p> <p>W 5 1/4"</p> <p>D 2 3/4"</p> <p>H 8 1/8"</p> <p>\$ \$30.17</p> 	<p>★ EDINBURGH</p> <p>COR05X03X08ED</p> <p>W 5 1/4"</p> <p>D 3 1/4"</p> <p>H 8 3/8"</p> <p>\$ \$17.72</p> 











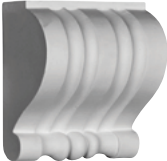





<p>DEVON</p> <p>COR05X05X09DE</p> <p>W 5 1/4"</p> <p>D 5 1/4"</p> <p>H 9 1/2"</p> <p>\$ \$35.62</p> 	<p>DAMON</p> <p>COR05X05X12DA</p> <p>W 5 1/4"</p> <p>D 5 3/8"</p> <p>H 12 1/4"</p> <p>\$ \$29.42</p> 	<p>HILLSBOROUGH</p> <p>COR05X02X07HI</p> <p>W 5 3/8"</p> <p>D 2 1/2"</p> <p>H 7 3/4"</p> <p>\$ \$17.81</p> 	<p>ELSINORE</p> <p>COR05X03X08EL</p> <p>W 5 3/8"</p> <p>D 3 1/8"</p> <p>H 8 1/4"</p> <p>\$ \$14.25</p> 
<p>ACANTHUS</p> <p>COR05X04X15AC</p> <p>W 5 3/8"</p> <p>D 4 1/8"</p> <p>H 15 1/2"</p> <p>\$ \$95.48</p> 	<p>EMERY</p> <p>COR05X02X08EM</p> <p>W 5 1/2"</p> <p>D 2 3/4"</p> <p>H 8 1/4"</p> <p>\$ \$17.72</p> 	<p>ROYAL</p> <p>COR05X02X09MO</p> <p>W 5 1/2"</p> <p>D 2 3/4"</p> <p>H 9 3/8"</p> <p>\$ \$24.96</p> 	<p>BREMEN</p> <p>COR05X03X09BR</p> <p>W 5 1/2"</p> <p>D 3 7/8"</p> <p>H 11 3/4"</p> <p>\$ \$39.57</p> 
<p>ADONIS</p> <p>COR05X04X09AD</p> <p>W 5 1/2"</p> <p>D 4 1/2"</p> <p>H 9"</p> <p>\$ \$46.22</p> 	<p>ACANTHUS</p> <p>COR05X10X05AC</p> <p>W 5 1/2"</p> <p>D 5 3/8"</p> <p>H 10 5/8"</p> <p>\$ \$63.95</p> 	<p>ODESSA</p> <p>COR05X04X12OD</p> <p>W 5 3/4"</p> <p>D 4 3/4"</p> <p>H 12 3/8"</p> <p>\$ \$46.17</p> 	<p>ABERDEEN</p> <p>COR06X20X30AB </p> <p>W 5 3/4"</p> <p>D 20 1/8"</p> <p>H 30"</p> <p>\$ \$174.52</p> 
<p>STOCKPORT</p> <p>COR05X04X17ST</p> <p>W 5 7/8"</p> <p>D 4 1/4"</p> <p>H 17 3/4"</p> <p>\$ \$43.41</p> 	<p>HAMILTON</p> <p>COR07X06X20HA</p> <p>W 5 7/8"</p> <p>D 8"</p> <p>H 20"</p> <p>\$ \$66.48</p> 	<p>DEVON</p> <p>COR06X07X13DE</p> <p>W 6"</p> <p>D 7"</p> <p>H 13 1/4"</p> <p>\$ \$54.61</p> 	<p>HESTIA</p> <p>COR08X06X12HE</p> <p>W 6"</p> <p>D 8"</p> <p>H 12"</p> <p>\$ \$47.49</p> 
<p>PERALTA</p> <p>COR08X06X18PE</p> <p>W 6"</p> <p>D 8"</p> <p>H 18"</p> <p>\$ \$73.61</p> 	<p>PIEDMONT</p> <p>COR06X11X16PE</p> <p>W 6"</p> <p>D 11"</p> <p>H 16 1/4"</p> <p>\$ \$75.72</p> 	<p>OLIVE</p> <p>COR06X03X07OL</p> <p>W 6 1/8"</p> <p>D 3 1/8"</p> <p>H 7 1/2"</p> <p>\$ \$14.03</p> 	<p>JACKSON</p> <p>COR06X04X14JA</p> <p>W 6 1/8"</p> <p>D 4 1/4"</p> <p>H 14 1/2"</p> <p>\$ \$51.52</p> 
<p>CHESTERFIELD</p> <p>COR06X04X09CH</p> <p>W 6 1/8"</p> <p>D 4 5/8"</p> <p>H 9 1/2"</p> <p>\$ \$26.05</p> 	<p>ALEXA</p> <p>COR06X05X20AL</p> <p>W 6 1/8"</p> <p>D 5"</p> <p>H 19 7/8"</p> <p>\$ \$37.99</p> 	<p>LEAF</p> <p>COR06X02X08LF</p> <p>W 6 1/4"</p> <p>D 2 7/8"</p> <p>H 8 1/4"</p> <p>\$ \$14.87</p> 	<p>HAMPSHIRE</p> <p>COR06X18X04HA</p> <p>W 6 1/4"</p> <p>D 4 3/8"</p> <p>H 18 1/8"</p> <p>\$ \$92.38</p> 
<p>QUENTIN</p> <p>COR06X05X09QU</p> <p>W 6 3/8"</p> <p>D 5 5/8"</p> <p>H 9"</p> <p>\$ \$43.81</p> 	<p>LEANDROS</p> <p>COR06X03X09LN</p> <p>W 6 1/2"</p> <p>D 3 3/8"</p> <p>H 9"</p> <p>\$ \$39.57</p> 	<p>MEDWAY</p> <p>COR06X03X10ME</p> <p>W 6 1/2"</p> <p>D 3 5/8"</p> <p>H 10"</p> <p>\$ \$49.52</p> 	<p>ROSE</p> <p>COR06X03X10RO</p> <p>W 6 1/2"</p> <p>D 3 5/8"</p> <p>H 10 1/8"</p> <p>\$ \$28.74</p> 

WIDTH
DEPTH
HEIGHT



BRACKETS & CORBELS



<p>ELSINORE</p> <p>COR07X04X07EL </p> <p>W 6 1/2" D 3 3/4" H 7 1/8" \$ \$16.62</p> 	<p>EDWARDS</p> <p>COR07X07X12ED</p> <p>W 6 1/2" D 7 3/8" H 12" \$ \$29.68</p> 	<p>GIANA</p> <p>COR06X11X20GI</p> <p>W 6 1/2" D 11" H 20" \$ \$90.78</p> 	<p>GIANA</p> <p>COR06X14X26GI</p> <p>W 6 1/2" D 14 1/2" H 26" \$ \$97.77</p> 
<p>HOLMDEL</p> <p>COR06X05X10HO</p> <p>W 6 5/8" D 5 1/4" H 10" \$ \$32.84</p> 	<p>GRAPE</p> <p>COR06X13X03GR</p> <p>W 6 3/4" D 3 1/2" H 13 3/4" \$ \$78.16</p> 	<p>OAKLEAF</p> <p>COR06X04X10OA</p> <p>W 6 3/4" D 4 3/8" H 10 3/4" \$ \$27.02</p> 	<p>ARTIS</p> <p>COR06X03X11AR</p> <p>W 6 7/8" D 3 1/2" H 11" \$ \$26.40</p> 
<p>SEVILLE</p> <p>COR07X05X11SE</p> <p>W 6 7/8" D 4 5/8" H 11" \$ \$20.18</p> 	<p>SPRINGTIME</p> <p>COR07X03X09SP</p> <p>W 7" D 3 1/2" H 9" \$ \$52.81</p> 	<p>FLORAL</p> <p>COR07X03X09FL</p> <p>W 7" D 3 1/2" H 9" \$ \$18.39</p> 	<p>NICOLE</p> <p>COR07X04X09NI</p> <p>W 7 1/8" D 3 3/4" H 8 5/8" \$ \$44.52</p> 
<p>FOREST</p> <p>COR07X04X08FO</p> <p>W 7 1/8" D 4 1/8" H 8 1/4" \$ \$23.89</p> 	<p>TRADITIONAL</p> <p>COR07X07X05TR</p> <p>W 7 1/8" D 5 1/8" H 7 1/2" \$ \$26.29</p> 	<p>NADIA</p> <p>COR07X03X10NA</p> <p>W 7 1/4" D 3" H 10 1/8" \$ \$21.81</p> 	<p> NADIA</p> <p>COR07X04X11NA</p> <p>W 7 1/4" D 3 1/2" H 10 1/2" \$ \$16.62</p> 

POMPEII
 COR07X03X08PO
W 7 3/8"
D 3 1/4"
H 8 3/4"
\$ \$27.52



FRANKLIN
 COR07X05X12FR
W 7 3/8"
D 5 1/8"
H 12 1/8"
\$ \$26.12



WAKEFIELD
 COR07X05X11WA
W 7 3/8"
D 5 3/8"
H 11"
\$ \$27.49



TYRONE
 COR07X15X24TY
W 7 3/8"
D 15"
H 23 5/8"
\$ \$141.28



TRISTAN
 COR07X04X07TN
W 7 1/2"
D 4"
H 7 1/4"
\$ \$37.22



EDWARDS
 COR08X08X16ED
W 7 1/2"
D 8 1/8"
H 15 3/4"
\$ \$47.49



LEAF
 COR07X04X11LF
W 7 3/4"
D 3 7/8"
H 11"
\$ \$29.98



FLOWER
 COR07X04X12FW
W 7 3/4"
D 4 1/2"
H 12 1/4"
\$ \$29.40



DEVON
 COR07X06X14DE
W 7 3/4"
D 6 1/2"
H 14 1/4"
\$ \$72.23



**PERFECT FOR
 INTERIOR OR EXTERIOR
 APPLICATIONS**



METZ
 COR07X04X12ME
W 7 7/8"
D 4 1/2"
H 12 1/8"
\$ \$42.93



BEADED
 COR07X05X13BE
W 7 7/8"
D 5 1/8"
H 13 3/8"
\$ \$78.16



NEXUS
 COR08X06X11NE
W 7 7/8"
D 6 1/8"
H 11 3/4"
\$ \$82.44



SCROLL LEAF
 COR07X08X18SC
W 7 7/8"
D 8 3/4"
H 18 1/4"
\$ \$151.47



WINDSOR
 COR08X04X12WI
W 8"
D 4"
H 12"
\$ \$60.52



ACANTHUS
 COR08X05X14AC
W 8"
D 5"
H 14 7/8"
\$ \$76.71



ACANTHUS
 COR08X06X23AC
W 8"
D 6"
H 22 7/8"
\$ \$138.88



MIDDLESBOROUGH
 COR08X08X20MD
W 8 1/8"
D 7 7/8"
H 20 1/8"
\$ \$71.23



FAIRFAX
 COR08X06X28FA
W 8 1/4"
D 6 7/8"
H 28 1/8"
\$ \$160.42



ACANTHUS
 COR14X08X05AC
W 8 1/2"
D 5"
H 14 1/2"
\$ \$85.27



WIDTH
DEPTH
HEIGHT



BRACKETS & CORBELS

ROSE

COR08X05X11RO

W 8 1/2"
D 5 1/4"
H 11 3/8"
\$ \$80.02



GIANA

COR08X22X26GI

W 8 1/2"
D 22 1/2"
H 26"
\$ \$176.08



LEAF

COR08X06X13LF

W 8 5/8"
D 6"
H 13 7/8"
\$ \$35.31



FOREST

COR08X04X11FO

W 8 3/4"
D 4 5/8"
H 11"
\$ \$38.12



COLONIAL

COR09X09X16CO

W 8 3/4"
D 8 3/4"
H 16 3/8"
\$ \$49.86



ALEXANDRIA

COR09X17X05AL

W 9 1/2"
D 5 1/2"
H 17 3/8"
\$ \$103.02



MARSEILLE

COR09X20X06MA

W 9 1/2"
D 6 5/8"
H 20 1/8"
\$ \$106.58



MIDDLESBOROUGH

COR09X07X11MD

W 9 5/8"
D 7 3/4"
H 11"
\$ \$80.33



LINUS

COR09X03X15LI

W 9 3/4"
D 3 7/8"
H 15 3/4"
\$ \$65.97



CHESTERFIELD

COR13X10X13CH **NEW**

W 10"
D 13"
H 13"
\$ \$93.79



MONIQUE

COR10X05X37MO

W 10 1/8"
D 5 7/8"
H 37"
\$ \$355.13



DAMON

COR10X07X40DA

W 10 1/8"
D 7 5/8"
H 40 1/8"
\$ \$170.96



SCROLL LEAF

COR10X11X25SC

W 10 3/8"
D 11 5/8"
H 25 1/2"
\$ \$400.18



ANGEL

COR11X05X13AN

W 11 1/8"
D 5 1/2"
H 13 3/8"
\$ \$60.52



ANGEL

COR11X05X40AN-L

W 11 1/4"
D 5 5/8"
H 40 1/2"
\$ \$286.37



ANGEL

COR11X05X40AN-R

W 11 1/4"
D 5 5/8"
H 40 1/2"
\$ \$286.37



STRASBOURG

COR11X08X20SG

W 11 5/8"
D 8 5/8"
H 20 1/4"
\$ \$84.31



LYON

COR11X05X14LY

W 11 3/4"
D 5 7/8"
H 14 1/8"
\$ \$109.10



COSMO

COR13X12X20CO

W 13"
D 12"
H 20 1/2"
\$ \$165.02



RUTLEDGE: SUR34X06X12RU



W 6 3/8" **D** 12" **H** 34 1/8" **\$** \$260.00

MARSEILLE: SUR27X06X08MA



W 6 1/2" **D** 8 1/8" **H** 27 3/8" **\$** \$154.34

COLTON: SUR41X07X07CO



W 7 7/8" **D** 7" **H** 41 1/4" **\$** \$172.14

SCROLL LEAF: SUR34X08X08SC



W 7 7/8" **D** 7 7/8" **H** 34" **\$** \$375.16

DEVON: SUR20X09X05DE



W 8 5/8" **D** 5 3/8" **H** 20 1/8" **\$** \$141.75

FAIRFAX: SUR39X09X09FA



W 8 5/8" **D** 9 1/2" **H** 39 1/4" **\$** \$273.35

WIDTH
DEPTH
HEIGHT



SURROUNDS

MONIQUE: SUR42X09X08MO



W 9 1/4" **D** 8 1/4" **H** 41 3/4" **\$** \$288.19

SCROLL LEAF: SUR35X10X11SC



W 9 7/8" **D** 11 1/8" **H** 34 5/8" **\$** \$338.35

CLASSIC: SUR09X29X06CL



W 9 7/8" **D** **H** 29 1/2" **\$** \$178.71

FLORAL: SUR39X10X08FL



W 10 1/4" **D** 8 1/4" **H** 39 3/8" **\$** \$178.08

QUEENSTOWN: SUR42X12X13QU



W 11 7/8" **D** 12 3/4" **H** 41 3/4" **\$** \$287.30

**SHIPS
OUT IN
24-72
HOURS**



<p>LEGACY: ROS04X00LE</p>  <p>W H P \$ 4" 4" 5/8" \$5.94</p>	<p>ATTICA: ROS04X04AT</p>  <p>W H P \$ 4" 4" 3/4" \$7.12</p>	<p>KENDALL: ROS04X04KD</p>  <p>W H P \$ 4" 4" 1" \$19.93</p>	<p>JACKSON: ROS04X04X00CL</p>  <p>W H P \$ 4" 4" 7/8" \$7.72</p>	<p>LEANDROS: ROS03X03LE</p>  <p>W H P \$ 4 1/8" 4 1/8" 1 1/4" \$7.12</p>
<p>SELLEK: ROS04X04SK</p>  <p>W H P \$ 4 1/8" 4 1/8" 1 7/8" \$7.12</p>	<p>BALTIMORE: ROS04X04BA</p>  <p>W H P \$ 4 1/8" 4 1/8" 5/8" \$7.12</p>	<p>LEAF: ROS04X04LE</p>  <p>W H P \$ 4 1/8" 4 1/8" 3/4" \$10.09</p>	<p>DOVER: ROS04X04DR</p>  <p>W H P \$ 4 3/8" 4 3/8" 1 1/4" \$7.12</p>	<p>LEANDROS: ROS05X05LE</p>  <p>W H P \$ 4 3/8" 4 3/8" 1 1/4" \$7.12</p>
<p>KAYA: ONL04X04X01KA</p>  <p>W H P \$ 4 3/8" 4 3/8" 3/4" \$5.70</p>	<p>STAR: ROS05X05ST</p>  <p>W H P \$ 4 1/2" 4 1/2" 5/8" \$9.50</p>	<p>PALMETTO: ROS05X05PM</p>  <p>W H P \$ 4 3/4" 4 3/4" 5/8" \$8.31</p>	<p>VERSAILLES: ROS04X04VE</p>  <p>W H P \$ 4 3/4" 4 3/4" 3/4" \$17.81</p>	<p>HAVEN: ONL05X05X01HV</p>  <p>W H P \$ 4 7/8" 4 7/8" 3/4" \$7.19</p>
<p>KAYA: ONL05X05X01KA</p>  <p>W H P \$ 5 1/4" 5 1/4" 3/4" \$10.68</p>	<p>LANARKSHIRE: ROS04X04X00LA</p>  <p>W H P \$ 5 3/4" 5 3/4" 5/8" \$10.09</p>	<p>FAIRFAX: ROS15X15FA</p>  <p>W H P \$ 5 7/8" 5 7/8" 3/4" \$10.68</p>	<p>BALTIMORE: ROS06X06BA</p>  <p>W H P \$ 6 1/8" 6 1/8" 7/8" \$8.31</p>	<p>ACANTHUS: ROS07X07AC</p>  <p>W H P \$ 6 1/8" 6 1/8" 3/4" \$15.43</p>
<p>PALMETTO: ROS08X08PM</p>  <p>W H P \$ 7 7/8" 7 7/8" 5/8" \$13.06</p>	<p>LAUREN: ROS01X01LA</p>  <p>OD P \$ 1 1/4" 1/2" \$4.75</p>	<p>ANDREA: ONL02X02X01AD</p>  <p>OD P \$ 1 1/2" 3/8" \$6.05</p>	<p>HURLEY: ROS02X02HU</p>  <p>OD P \$ 2 1/8" 1/4" \$5.34</p>	<p>★ FLOWER: ROS01X01FL</p>  <p>OD P \$ 2 3/8" 3/4" \$4.75</p>
<p>★ STOCKPORT: ROS02X02ST</p>  <p>OD P \$ 2 1/2" 3/8" \$5.34</p>	<p>FLOWER: ROS02X02FL</p>  <p>OD P \$ 2 1/2" 1/8" \$5.34</p>	<p>NADIA: ROS02X02NA</p>  <p>OD P \$ 2 1/2" 1/2" \$5.34</p>	<p>LOERA: ROS02X02LO</p>  <p>OD P \$ 2 3/4" 1/4" \$10.68</p>	<p>BLACKTHORNE: ROS02X02BL</p>  <p>OD P \$ 2 3/4" 3/8" \$5.34</p>

LOGAN: ROS03LO



OD P \$
3 1/8" 5/8" \$7.12

MONIQUE: ROS03X03MO



OD P \$
3 1/8" 5/8" \$5.94

AMELIA: ROS03X03AM



OD P \$
3 3/8" 3/8" \$5.94

LYRE: ROS03X03LY



OD P \$
3 3/8" 1/2" \$4.75

ARTIS: ROS03X03AR



OD P \$
3 1/2" 5/8" \$5.94

SOUTHAMPTON: ROS04X03SO



W H P \$
3 3/4" 3" 3/4" \$7.12

EMERY: ONL04X04X01EM



OD P \$
3 3/4" 1/2" \$6.83

ARTIS: ROS04X04AR



OD P \$
3 3/4" 3/8" \$5.94

FLOWER: ROS04FL



OD P \$
3 7/8" 3/4" \$8.31

★ **FLORAL: ROS03X03FL**



OD P \$
3 7/8" 1/2" \$7.12

HELENE: ROS03X03HE



OD P \$
3 7/8" 5/8" \$7.12

HELENE: ONL04X04X01HE



OD P \$
4 1/8" 5/8" \$5.70

TRADITIONAL: ROS04X01TR



OD P \$
4 1/2" 3/4" \$7.72

★ **MARIA: ROS04X04MA**



OD P \$
4 3/4" 1 1/4" \$7.12

MONIQUE: ROS04X04MO



OD P \$
4 7/8" 5/8" \$7.72

LISBON: ROS05X00LI



OD P \$
5" 3/8" \$7.72

BORDEAUX: ROS05X01BO



OD P \$
5" 3/4" \$7.72

FLOWER: ROS05X01FL



OD P \$
5" 3/4" \$7.72

BRONTES: ROS05X05BO



OD P \$
5" 5/8" \$7.72

NORFOLK: ROS05X05NO



OD P \$
5" 1" \$8.31

ALEXA: ONL05X05AL



OD P \$
5" 1" \$9.26

TRADITIONAL: ONL05X05TR



OD P \$
5" 7/8" \$9.26

MEDWAY: ROS02X02ME



OD P \$
5 1/2" 1 1/8" \$8.31

★ **WATFORD: ROS05X04WA**



W H P \$
5 7/8" 4 1/2" 1/2" \$5.94

BORDEAUX: ROS06X06BO



OD P \$
5 7/8" 5/8" \$7.12

LYRE: ROS05X05LY



OD P \$
5 7/8" 7/8" \$8.31

MULLIN: ROS05X05MU



OD P \$
5 7/8" 1 5/8" \$8.31

SUNFLOWER: ROS06SN



OD P \$
5 7/8" 1 1/2" \$11.28

CHESTERFIELD: ROS06X06CH



OD P \$
6" 1 1/8" \$8.31

KINSLEY: ROS06X05KI



W H P \$
4 1/2" 6 1/8" 3/4" \$10.68

OUTSIDE DIAMETER
PROJECTION



WIDTH
HEIGHT

ROSETTES

★ **CLASSIC: ROS06X05CL**



W H P \$
6 1/8" 4 1/2" 3/8" \$10.09

PALMETTO: ROS06PM



OD P \$
6 1/4" 1 1/2" \$11.28

ASHLEY: ROS06AS



OD P \$
6 1/4" 7/8" \$11.28

STOCKPORT: ROS06X06ST



OD P \$
6 1/2" 7/8" \$15.39

MADRID: ROS04MA



W H P \$
4 3/8" 6 3/4" 3/4" \$11.87

MILAN: ROS06X06MI



OD P \$
6 3/4" 1 1/4" \$16.62

OXFORD: ROS07X03OX



W H P \$
7 1/8" 3 1/8" 5/8" \$5.94

★ **MARCELLA: ROS07X03MA**



W H P \$
7 1/4" 3 3/8" 3/8" \$10.68

KEPLER: ROS07X07KP



OD P \$
7 1/2" 7/8" \$9.50

KENT: ROS07X07KE



OD P \$
7 5/8" 1 3/8" \$9.50

LION: ROS08X08LI



OD P \$
7 3/4" 2" \$11.87

WAKEFIELD: ROS08X08WA



OD P \$
8 5/8" 1" \$9.50

GALVESTON: ONL09X09X02GL



OD P \$
8 7/8" 1 1/2" \$12.47

KENT: ROS11X11X01KE



OD P \$
11 3/4" 1 3/8" \$21.37

LION: ROS14X14LI



OD P \$
13 3/4" 3 5/8" \$27.31





URETHANE ONLAYS

Our urethane onlays and appliques are meticulously molded for delicate, intricate detail. Elegant and crisp craftsmanship offer beauty and ornamentation perfect for making your project a standout feature. With deep relief and smooth texture, it's easy to paint or faux finish to achieve a high-end look for less. Made of the highest quality urethane, these embellishments offer a lasting and authentic historical design perfect for upgrading furniture, cabinets, fireplaces, vent hoods, doors and more.

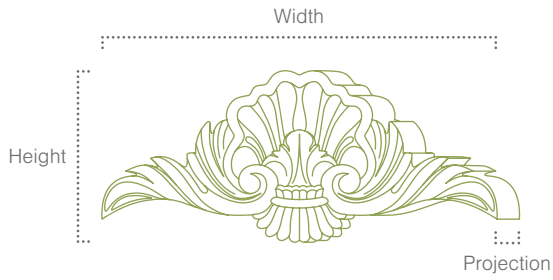

Onlays take ordinary, plain cabinets, furniture, fireplace mantels, ceilings and more to a new level of sophistication. Infuse your personality by creating a one-of-a-kind piece with your favorite onlay.

Scrolls



Star



Shell



Left & Right



**SAME
DESIGN**

**MANY
SIZES**

SMALL SCROLL: APL11X02X01SC



W H P \$
11 1/2" 2 7/8" 3/4" \$15.43

MEDIUM SCROLL: APL23X05X01SC



W H P \$
23 1/8" 5 7/8" 1 1/8" \$29.09

LARGE SCROLL: APL36X09X01SC



W H P \$
36 3/4" 9 3/4" 1 3/8" \$52.24

MINI SHELL: APL11X06X01SH



W H P \$
11 1/2" 6" 1 3/8" \$22.56

SMALL SHELL: APL16X08X01SH



W H P \$
16 1/4" 8 3/4" 1 5/8" \$29.68

LARGE SHELL: APL28X15X02SH



W H P \$
28 3/4" 15 1/8" 2 7/8" \$78.36

HELENE: ONL01X02HE



W H P \$
1 1/8" 2 3/4" 3/8" \$3.74

RALSTON: ONL01X06X01RA



W H P \$
1 3/8" 5 7/8" 3/4" \$7.12

LEAF: ONL01X03LE



W H P \$
1 5/8" 3 1/8" 1/4" \$4.16

SWINDON: ONL02X02SW



W H P \$
2 1/8" 2 1/4" 3/8" \$4.16

HARVEST: ONL02X03X00HA



W H P \$
2 1/4" 2 7/8" 3/8" \$7.12

SHELL: ONL15X02X01SH



W H P \$
2 1/4" 15 5/8" 3/4" \$19.95

COLE: ONL02X04X01CO



W H P \$
2 3/8" 3 5/8" 5/8" \$7.12

★ KEPLER: ONL02X02X01KP



W H P \$
2 1/2" 2 1/2" 1/4" \$4.16

FEDERAL: ONL02X03X01FE



W H P \$
2 1/2" 3 1/4" 3/8" \$3.08

MILTON: ONL02X15X00MI



W H P \$
2 5/8" 15 1/4" 1/4" \$26.12

SHELL: ONL03X03X01SH



W H P \$
2 5/8" 3 3/8" 1/2" \$7.12

MEDWAY: ONL03X02X01ME



W H P \$
3 7/8" 2" 5/8" \$5.94



ANTHONY: ONL02X02AT

W	H	P	\$
2 3/4"	2 3/8"	3/8"	\$4.16

GRAPE: ONL02X04GR

W	H	P	\$
2 3/4"	4 1/8"	3/8"	\$7.12

FLEUR-DE-LIS: ONL04X03X01FL

W	H	P	\$
2 3/4"	4"	1/2"	\$4.27

ELSINORE: ONL03X02EL

W	H	P	\$
3"	2 3/4"	3/8"	\$7.12

BORDEAUX: ONL03X02X00BO

W	H	P	\$
3"	1 3/4"	3/8"	\$7.12

FOLIAGE: ONL03X04X01LF

W	H	P	\$
3"	4 1/2"	1/2"	\$7.12

BOW: ONL03X02X01BW

W	H	P	\$
3 1/8"	2 3/8"	3/8"	\$5.94

SOUTHAMPTON: ONL03X03SO

W	H	P	\$
3 1/8"	3 1/8"	1/2"	\$5.94

FEDERAL: ONL03X05X01FE

W	H	P	\$
3 1/8"	5"	3/4"	\$7.12

GENEVIEVE: ONL03X05X01GE

W	H	P	\$
3 1/8"	5 1/8"	5/8"	\$7.12

NADIA: ONL03X05X01NA

W	H	P	\$
3 1/8"	5 1/8"	5/8"	\$7.12

FLEUR-DE-LIS: ONL03X04X01FL

W	H	P	\$
3 3/8"	4 1/8"	1/2"	\$7.12

KINSLEY: ONL03X05X01KI

W	H	P	\$
3 3/8"	4 1/2"	1/2"	\$7.12

TURIN: ONL03X06X00TU

W	H	P	\$
3 3/8"	6 1/8"	3/8"	\$8.31

CLASSIC: ONL07X03X01CL

W	H	P	\$
3 1/2"	7 1/8"	5/8"	\$13.06

MENTON: ONL04X08X01ME

W	H	P	\$
3 1/2"	8 1/4"	7/8"	\$11.87

FLOWERS: ONL03X05X01FL

W	H	P	\$
3 3/4"	5 7/8"	5/8"	\$7.12



★ **EDINBURGH:** ONL03X03ED



W 3 3/4" **H** 3 3/4" **P** 1/4" **\$** \$5.94

FERARA: ONL03X03FE



W 3 7/8" **H** 3 7/8" **P** 3/8" **\$** \$8.31

URN: ONL04X07X01UR



W 3 7/8" **H** 6 3/4" **P** 1" **\$** \$20.54

COLE: ONL04X05X01CO



W 4" **H** 5 1/2" **P** 1 1/4" **\$** \$7.12

FLEUR-DE-LIS: ONL06X04X01FL



W 4" **H** 6" **P** 5/8" **\$** \$4.98

HARVEST: ONL06X04X01HA



W 4" **H** 6 1/8" **P** 3/4" **\$** \$6.41

BORDEAUX: ONL03X04X01BO



W 4 1/8" **H** 3 1/4" **P** 3/4" **\$** \$5.70

MONIQUE: ONL04X03X01MO



W 4 1/8" **H** 3 7/8" **P** 1/2" **\$** \$8.31

GRIFFIN: ONL04X06X01GR



W 4 1/8" **H** 6 1/8" **P** 5/8" **\$** \$7.12

MILTON: ONL04X07X01MI



W 4 1/8" **H** 6 7/8" **P** 5/8" **\$** \$8.31

TREVISO: ONL04X04TR



W 4 1/4" **H** 4 1/2" **P** 1/2" **\$** \$7.12

EMILY: ONL04X04X01EY



W 4 1/4" **H** 4 1/4" **P** 1/2" **\$** \$6.76

FLOWER: ONL04X06X01FL



W 4 1/4" **H** 6 1/4" **P** 7/8" **\$** \$8.31

MARCELLA: ONL04X04X01MA



W 4 3/8" **H** 3 5/8" **P** 5/8" **\$** \$7.12

FEDERAL: ONL04X09FE



W 4 3/8" **H** 9" **P** 1 3/8" **\$** \$10.43

HARVEST: ONL04X06X01HA



W 4 1/2" **H** 6 1/2" **P** 1/4" **\$** \$3.45

FLOWERS: ONL04X10X01FL



W 4 1/2" **H** 10" **P** 5/8" **\$** \$12.78

BEADED: ONL04X05X01BE



W 4 5/8" **H** 5 3/8" **P** 1" **\$** \$5.94

HARVEST: ONL05X11X02HA



W 4 5/8" **H** 10 5/8" **P** 1 5/8" **\$** \$24.34

KEPLER: ONL04X06X01KP



W 4" **H** 5 1/2" **P** 7/8" **\$** \$7.12



ROBIN: ONL04X06RB

W	H	P	\$
4 3/4"	6 1/4"	1 1/8"	\$8.31

EATON: ONL05X05X01EA

W	H	P	\$
4 3/4"	4 3/4"	5/8"	\$7.12

BENSON: ONL05X06X01BE

W	H	P	\$
4 3/4"	5 3/4"	3/4"	\$8.31

SHELL: ONL05X06X01SH

W	H	P	\$
4 3/4"	5 7/8"	3/4"	\$8.31

★ **SHELL:** ONL04X04SH

W	H	P	\$
4 7/8"	4 7/8"	7/8"	\$5.94

DAUPHINE: ONL04X09X01DA

W	H	P	\$
4 7/8"	9 1/2"	1"	\$15.35

ANGEL: ONL05X03X01AN

W	H	P	\$
5"	2 3/4"	5/8"	\$7.12

FLORAL: ONL05X03X01FL

W	H	P	\$
5"	3"	1/2"	\$7.12

RIBBON: ONL05X03X01RI

W	H	P	\$
5"	3 1/2"	1/2"	\$7.12

GENOVA: ONL05X03GE

W	H	P	\$
5 1/8"	3 7/8"	1/2"	\$7.12

WASHINGTON: ONL05X03X01WA

W	H	P	\$
5 1/8"	2 1/2"	3/8"	\$7.12

COLE: ONL05X05CO

W	H	P	\$
5 1/8"	5 1/8"	3/4"	\$13.06

URN: ONL05X06X01UR

W	H	P	\$
5 1/8"	6 7/8"	1 1/8"	\$20.78

VERSAILLES: ONL05X06X01VE

W	H	P	\$
5 1/8"	6 3/8"	7/8"	\$10.68

AMELIA: ONL05X02X01AM

W	H	P	\$
5 3/8"	2 3/8"	7/8"	\$7.12

FRUIT: ONL05X10FR

W	H	P	\$
5 3/8"	9 3/4"	1 3/8"	\$11.69



BORDEAUX: ONL05X02X01BO



W 5 1/2" **H** 2 3/4" **P** 3/4" **\$** \$7.12

NEXUS: ONL05X04X01NE



W 5 1/2" **H** 4 5/8" **P** 3/4" **\$** \$11.28

HILLSBOROUGH: ONL05X06HI



W 5 1/2" **H** 6 3/4" **P** 1" **\$** \$11.87

GRAPE: ONL05X08X01GR

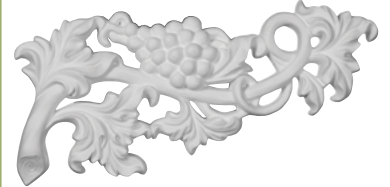

W 5 1/2" **H** 8 5/8" **P** 1" **\$** \$21.37

BOW: ONL06X02X01BW



W 5 1/2" **H** 2" **P** 1/2" **\$** \$7.12

CRAWLEY: ONL06X03X01CR



W 5 1/2" **H** 2 5/8" **P** 3/4" **\$** \$7.12

HARVEST: ONL08X06X01HA



W 5 1/2" **H** 8 1/4" **P** 1 1/8" **\$** \$8.54

WINGS: ONL05X01X01WI



W 5 5/8" **H** 1 3/8" **P** 1/2" **\$** \$7.12

UPGRADE THE ORDINARY TO EXTRAORDINARY

OXFORD: ONL03X06X01OX



W 5 3/4" **H** 3 1/8" **P** 3/4" **\$** \$5.70

COSMO: ONL04X06X01CO



W 5 3/4" **H** 4 3/8" **P** 1 1/8" **\$** \$6.83

FLOWER: ONL05X06X01FL



W 5 3/4" **H** 6 1/2" **P** 5/8" **\$** \$10.47

MONIQUE: ONL05X05X01MO



W 5 7/8" **H** 5 1/8" **P** 5/8" **\$** \$12.78

EDWARDS: ONL06X02X00ED



W 5 7/8" **H** 1 3/4" **P** 3/8" **\$** \$7.12

LUNEL: ONL06X07X01LU

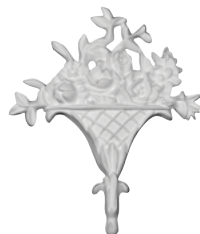

W 5 7/8" **H** 6 7/8" **P** 3/4" **\$** \$9.50

AVERY: ONL22X06X01AV



W 5 7/8" **H** 22 1/4" **P** 1" **\$** \$30.27

BEADED: ONL06X08X01BE



W 6" **H** 8 1/2" **P** 1 1/2" **\$** \$10.09



GLADSTONE: ONL06X06X01GL

W H P \$
6 1/8" 6 1/8" 5/8" \$10.68

COLE: ONL06X07X01CO

W H P \$
6 1/8" 6 7/8" 1" \$5.58

SHELL: ONL06X01X00SH

W H P \$
6 1/4" 1 3/8" 3/8" \$7.12

LEAF: ONL06X08X01LF

W H P \$
6 1/4" 8 3/4" 3/4" \$8.31

REECE: ONL06X56X02RE

W H P \$
6 1/4" 56 3/4" 2 1/8" \$130.59

WREATH: ONL06X03X01WR

W H P \$
6 3/8" 2 5/8" 5/8" \$8.31

SCROLL: ONL06X05X01SC

W H P \$
6 3/8" 4 1/2" 5/8" \$8.31

LEAF: ONL06X10X02LE

W H P \$
6 3/8" 10 3/8" 2" \$17.45

STAR: ONL06X06X01ST

W H P \$
6 1/2" 6 1/2" 5/8" \$8.31

ANGEL: ONL06X07X01AN

W H P \$
6 1/2" 7 1/8" 1 3/8" \$14.61

DUBLIN: ONL07X02X01DU

W H P \$
6 1/2" 2 3/8" 3/4" \$8.31

ANGEL: ONL07X03X01AN

W H P \$
6 1/2" 2 5/8" 1/2" \$8.31

MODERN: ONL07X04X01SH

W H P \$
6 1/2" 3 5/8" 3/4" \$8.31

GENOVA: ONL06X02GE

W H P \$
6 3/4" 2 3/4" 1/4" \$8.31

QUENTIN: ONL06X03QU

W H P \$
6 3/4" 3 1/8" 5/8" \$9.50

MENTON: ONL06X12ME

W H P \$
6 3/4" 12 3/8" 1 1/4" \$15.95

LENS: ONL06X13LE

W H P \$
6 3/4" 13 1/2" 1 5/8" \$21.98

NADIA: ONL07X07X01NA

W H P \$
6 3/4" 6 3/4" 1 3/8" \$9.50

URN: ONL07X09X01UR

W H P \$
6 3/4" 8 3/4" 1 1/4" \$14.25

GLADSTONE: ONL07X03X01GL

W H P \$
6 7/8" 2 5/8" 1/2" \$8.31

FLOWER: ONL08X12X01FL



W H P \$
8 1/4" 12 1/2" 1 1/4" \$14.25

GRAPE: ONL08X20X01GR



W H P \$
8 1/4" 20 1/8" 1 5/8" \$31.93

WREATH: ONL07X02X01WR



W H P \$
7" 2 5/8" 5/8" \$9.50

OSLO: ONL07X03X01OS

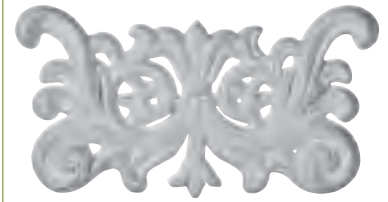

W H P \$
7 1/8" 3 3/4" 5/8" \$10.68

SCROLL: ONL07X04X01SC



W H P \$
7 1/8" 3 3/4" 3/4" \$8.31

GRAPE: ONL07X09X01GR



W H P \$
7 1/8" 9 1/4" 1 1/8" \$17.81

FLOWERS: ONL07X16X01FL



W H P \$
7 1/8" 16" 1 1/8" \$23.02

MADRID: ONL07X10X02MA



W H P \$
7 1/4" 10" 1 5/8" \$37.40

BENSON: ONL07X06X01BE

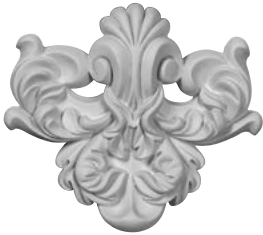

W H P \$
7 3/8" 6 1/2" 1 3/8" \$21.37

DELFINA: ONL07X03X01DL



W H P \$
7 3/8" 3 1/8" 3/4" \$8.31

KENT: ONL07X04X01KE



W H P \$
7 1/2" 3 7/8" 5/8" \$11.87

HURLEY: ONL07X11HU



W H P \$
7 5/8" 11 7/8" 1/2" \$16.49

COSMO: ONL08X08X01CO

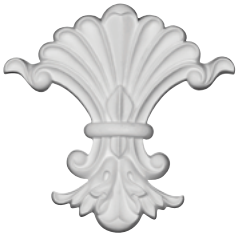

W H P \$
7 5/8" 7 1/2" 1 3/8" \$10.68

ASHFORD: ONL07X03X01AS



W H P \$
7 3/4" 3 1/8" 3/4" \$9.50

HARVEST: ONL08X02X01HA



W H P \$
7 3/4" 2 3/8" 5/8" \$7.12

VICEROY: ONL08X03X01VI



W H P \$
7 3/4" 2 5/8" 5/8" \$9.50

MODENA: ONL08X04X01MO



W H P \$
7 7/8" 4 3/8" 3/4" \$9.50

CARRILLO: ONL05X08X01CI



W H P \$
8" 4 3/4" 3/4" \$10.39

PESARO: ONL08X09X01PE



W H P \$
8" 9 7/8" 1 1/4" \$11.87

PESARO: ONL08X12X01PE



W H P \$
8" 12 1/8" 1" \$21.37



GENEVIEVE: ONL08X08X01GE



W	H	P	\$
8 1/8"	8 1/8"	3/4"	\$13.06

WINGS: ONL08X01X01WI



W	H	P	\$
8 1/8"	1 3/4"	5/8"	\$9.50

SHELL: ONL08X05X00SH



W	H	P	\$
8 1/4"	5 1/4"	5/8"	\$8.31

STAR: ONL08X08X01ST



W	H	P	\$
8 1/4"	8 1/4"	1"	\$11.87

EMERY: ONL08X04X00EM



W	H	P	\$
8 1/4"	4 3/4"	3/4"	\$17.81

ASHFORD: ONL09X03X01AS



W	H	P	\$
8 1/2"	3"	1/2"	\$10.68

★ **SCROLL:** ONL08X03X01SC



W	H	P	\$
8 5/8"	3 1/8"	7/8"	\$10.68

EDINBURGH: ONL08X04X01ED



W	H	P	\$
8 5/8"	3 7/8"	5/8"	\$13.06

DUBLIN: ONL08X07DU

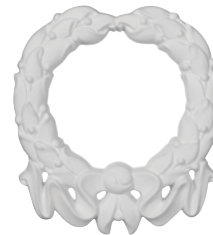

W	H	P	\$
8 5/8"	7 7/8"	3/4"	\$17.81

NEXUS: ONL17X09X01NE



W	H	P	\$
8 5/8"	16 1/2"	1 1/8"	\$40.18

JACKSON: ONL09X13X01JA



W	H	P	\$
8 3/4"	12 5/8"	1 1/4"	\$19.00

BEDFORD: ONL16X08X02BE



W	H	P	\$
8 3/4"	16 3/8"	2"	\$20.06

ASHFORD: ONL08X04X01AS



W	H	P	\$
8 7/8"	4 3/4"	3/4"	\$14.25

OXFORD: ONL05X09X01OX



W	H	P	\$
8 5/8"	4 7/8"	7/8"	\$7.12

DANIELA: ONL09X02X01DN



W H P \$
9" 2 1/2" 3/4" \$13.06

WINGS: ONL09X02X01WI



W H P \$
9" 2" 5/8" \$11.87

EMERY: ONL09X03ER



W H P \$
9" 3 7/8" 3/4" \$14.25

BORDEAUX: ONL09X04X01BO



W H P \$
9" 4 3/4" 1 1/8" \$13.06

NORWICH: ONL09X05X01NO

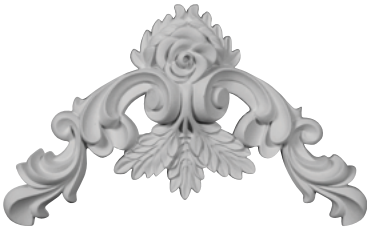

W H P \$
9" 5 1/2" 1 1/8" \$24.93

SHELL: ONL09X05X01SH



W H P \$
9" 5 3/8" 1 1/8" \$8.31

LUNEL: ONL09X12X01LU



W H P \$
9" 12 1/8" 1 1/4" \$14.25

RALSTON: ONL18X09X02RA



W H P \$
9" 17 7/8" 1 3/4" \$50.52

ARTIS: ONL05X05AR

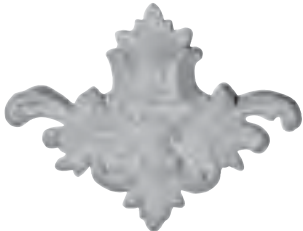

W H P \$
9 1/8" 7 1/4" 3/4" \$11.87

VERSAILLES: ONL05X09X01VE



W H P \$
9 1/4" 5 1/2" 3/4" \$13.54

VERSAILLES: ONL09X03X01VE



W H P \$
9 1/4" 3" 3/4" \$15.43

ATTICA: ONL09X11X01AT



W H P \$
9 1/4" 11 3/4" 1 1/8" \$21.33

FINLEY: ONL09X02X01CL



W H P \$
9 3/8" 2 1/8" 7/8" \$10.68

COSMO: ONL09X06X01CO



W H P \$
9 3/8" 5 1/2" 1" \$10.68

NICOLE: ONL09X04NI



W H P \$
9 1/2" 4 5/8" 3/8" \$11.87

AMELIA: ONL10X07X01AM



W H P \$
9 1/2" 7 1/4" 1" \$13.06

NEEDHAM: ONL08X04X01NE



W H P \$
8 7/8" 4 1/2" 1" \$7.12

CAN BE PAINTED, GEL STAINED OR
FAUX FINISHED



STRASBOURG: ONL04X10X01SG



W H P \$
9 7/8" 3 3/4" 7/8" \$11.76

KENT: ONL09X06KE



W H P \$
9 7/8" 6 1/4" 1/2" \$11.87



FLEUR-DE-LIS: ONL09X11X01FL



W H P \$
9 7/8" 11 7/8" 1 7/8" \$16.62

FLORAL: ONL10X01X01FL



W H P \$
10 1/4" 1 5/8" 1/4" \$11.87

WREATH: ONL10X11X01WR



W H P \$
10 1/4" 11 3/8" 1" \$20.54

FLOWER: ONL10X12X02FL



W H P \$
10 1/4" 24" 1 5/8" \$38.37

WAKEFIELD: ONL10X02X00WA



W H P \$
10 1/2" 2 1/2" 5/8" \$5.94

COLE: ONL11X03X01CO



W H P \$
10 1/2" 2 5/8" 5/8" \$11.87

WINGS: ONL10X02X01WI



W H P \$
10 5/8" 2 1/4" 3/4" \$11.87

BENSON: ONL10X04X01BN



W H P \$
10 5/8" 3 7/8" 5/8" \$15.43

★ **GLADSTONE:** ONL10X05X01GL



W H P \$
10 5/8" 5 1/4" 7/8" \$13.06

MONIQUE: ONL10X05X01MO



W H P \$
10 5/8" 5 3/4" 1 3/8" \$22.90

SHELL: ONL10X11X01SH



W H P \$
10 5/8" 11 3/4" 1 1/8" \$19.00

FLOWER: ONL10X13X01FB



W H P \$
10 5/8" 13 1/4" 1 3/4" \$24.93

GRAPE: ONL10X13X02GR



W H P \$
10 5/8" 13 3/8" 1 5/8" \$23.74

WREATH: ONL11X02X01WR



W H P \$
10 5/8" 2 1/8" 3/4" \$11.87

GENEVIEVE: ONL11X11X01GN



W H P \$
10 5/8" 10 5/8" 3/4" \$22.08

GENOVA: ONL11X06X02GE



W H P \$
10 7/8" 6 1/8" 1 1/2" \$32.76

BEADED: ONL11X05X01BE



W H P \$
11" 5 5/8" 1 1/8" \$9.50



SCROLL: ONL11X08GD



W H P \$
11" 3 1/8" 1/2" \$16.62

WREATH: ONL11X04WR



W H P \$
11 1/4" 4 3/4" 5/8" \$16.62

LEAF: ONL11X01X01LF



W H P \$
11 3/8" 1 7/8" 1/2" \$11.87

SALEM: ONL11X06X01SA



W H P \$
11 3/8" 6 1/2" 1 1/2" \$22.43

MODENA: ONL11X10X01MO



W H P \$
11 3/8" 10 5/8" 1" \$30.87

NORWICH: ONL11X06X01NO



W H P \$
11 1/2" 6 3/8" 1 3/8" \$22.43

BAILE: ONL11X02X01BI



W H P \$
11 5/8" 1 3/4" 3/4" \$13.06

WINGS: ONL12X02X01WI



W H P \$
11 5/8" 2" 1/2" \$11.87

ORLEANS: ONL11X03X01OL



W H P \$
11 3/4" 3 3/4" 1 1/4" \$15.43

PEARL: ONL11X03X01PE



W H P \$
11 3/4" 3 1/2" 7/8" \$14.25

PALMETTO: ONL11X07X01PM



W H P \$
11 3/4" 7 7/8" 1" \$13.06

SALERNO: ONL11X11SA



W H P \$
11 3/4" 11 3/4" 1" \$17.81

COLE: ONL11X2X01CO



W H P \$
11 3/4" 2 3/4" 5/8" \$15.43

COLE: ONL12X03X01CO



W H P \$
11 3/4" 3 1/8" 1/2" \$18.76

VERSAILLES: ONL06X12X01VE



W H P \$
11 7/8" 6 1/4" 7/8" \$24.22

BOW: ONL12X03X01BW



W H P \$
11 7/8" 3 1/8" 7/8" \$8.31

MARCELLA: ONL12X04X01MA



W H P \$
12" 3 3/4" 5/8" \$15.43

SHELL: ONL12X10X01SH



W H P \$
12" 10 1/2" 1" \$15.43

ODESSA: ONL12X12X00OD



W H P \$
12" 12" 7/8" \$17.81



DEEPRELIEFDESIGN

COLE: ONL12X14X01CO



W H P \$
12" 14 5/8" 1 1/4" \$21.37

COLE: ONL12X06X01CO



W H P \$
12 1/8" 6 3/4" 5/8" \$22.56

CARRILLO: ONL06X12X01CI



W H P \$
12 1/4" 6 1/8" 1 1/8" \$23.27

PALMETTO: ONL12X02X01PA



W H P \$
12 1/4" 2 3/4" 5/8" \$19.46

★ KEPLER: ONL12X04KE



W H P \$
12 3/8" 4 3/8" 1/4" \$14.25

EDWARDS: ONL12X04X01ED



W H P \$
12 3/8" 4" 7/8" \$14.25

BENSON: ONL12X10X01BE



W H P \$
12 1/2" 10 5/8" 1 1/2" \$22.56

MARCELLA: ONL13X05X01MA



W H P \$
12 5/8" 5" 1 3/8" \$14.25

VINYARD: ONL12X03X01VN



W H P \$
12 3/4" 3 1/2" 5/8" \$16.62

VERSAILLES: ONL13X03X01VE



W H P \$
13" 3" 3/4" \$19.00

AMELIA: ONL13X05X01AM



W H P \$
13" 5 1/8" 1 1/8" \$28.02

EDWARDS: ONL13X05X01ED



W H P \$
13 1/2" 5 3/4" 1/2" \$16.62

MONIQUE: ONL13X20X01MO



W H P \$
13 1/2" 20" 1 1/4" \$56.99

PALMETTO: ONL13X05X01PM



W H P \$
13 5/8" 5 1/8" 1" \$16.62

FLOWER: ONL05X14X01FL



W H P \$
13 3/4" 4 3/4" 1 1/4" \$27.84

KENT: ONL13X03X01KE



W H P \$
13 3/4" 3" 3/4" \$16.62

NADIA: ONL13X05X01NA



W H P \$
13 3/4" 5 1/2" 1" \$16.62

SHELL: ONL13X09X01SH



W H P \$
13 3/4" 9 3/4" 1 3/8" \$23.74

HERA: ONL14X21X08HE



W H P \$
13 3/4" 20 7/8" 7 7/8" \$123.47

SHELL: ONL14X04X01SH



W H P \$
14 3/8" 4 1/2" 1" \$16.62

NORFOLK: ONL14X07X01NO



W H P \$
14 3/8" 7 7/8" 1 1/2" \$24.93

SEA SHELL: ONL15X09X01SE



W H P \$
15" 9 1/4" 1 1/8" \$30.27

ATHENA: ONL15X20X10AT



W H P \$
15" 20 1/8" 10 1/4" \$165.14

VERSAILLES: ONL15X06X01VE

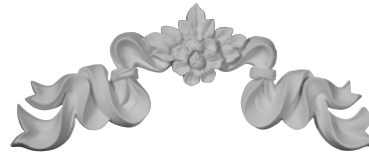

W H P \$
15 1/4" 6 1/4" 1" \$22.43

HAMILTON: ONL15X09X01HA



W H P \$
15 1/4" 9 1/4" 1 1/8" \$22.56

SHIPS OUT IN 24-72 HOURS

FLORAL: ONL15X04X01FL



W H P \$
15 5/8" 4" 3/4" \$17.81

ODESSA: ONL23X00OD



W H P \$
15 3/4" 14 3/4" 5/8" \$28.49

SCROLL: ONL16X04X01FO



W H P \$
16" 4 3/8" 1 1/2" \$19.00

ASHFORD: ONL16X07AS



W H P \$
16" 7 1/8" 5/8" \$21.12

SHELL: ONL16X08X01SH



W H P \$
16" 8 7/8" 1 1/2" \$56.35

COLE: ONL16X04X01CO



W H P \$
16 1/8" 4 3/8" 3/4" \$14.25

HESTIA: ONL16X17X08HE



W H P \$
16 1/8" 16 7/8" 8 1/2" \$122.17

RALSTON: ONL09X16X02RA



W H P \$
16 3/8" 8 7/8" 2" \$45.71



MARCELLA: ONL16X04X01MA



W H P \$
16 3/8" 4 3/4" 3/4" \$16.62

ZEUS: ONL17X17X08ZE



W H P \$
16 3/4" 17 3/8" 8 1/4" \$121.57



ASHFORD: ONL16X05AS



W H P \$
16 7/8" 5 7/8" 3/8" \$20.18

PIEDMONT: ONL07X07PI



W H P \$
17" 10 5/8" 3/4" \$11.87

VERSAILLES: ONL17X03X01VE



W H P \$
17 1/8" 3" 7/8" \$21.37

TEMPLE: ONL18X18X02TE



W H P \$
18 1/8" 18 1/8" 2 1/4" \$42.74

SHELL: ONL18X12X01SH



W H P \$
18 1/4" 12 3/8" 1 3/4" \$40.36

PALMETTO: ONL18X12X01PM



W H P \$
18 3/8" 12 1/4" 1" \$29.68

SWINDON: ONL18X09X01SW



W H P \$
18 1/2" 9 7/8" 3/4" \$21.37

BEADED: ONL18X13X01BE



W H P \$
18 1/2" 13 1/2" 1 1/2" \$17.81

KINSLEY: ONL08X19X02KI



W H P \$
18 3/4" 8 1/2" 1 3/4" \$54.97

BANNER: ONL19X10X01BA



W H P \$
18 7/8" 9 1/2" 5/8" \$20.54

GRAPE: ONL19X05X01GR



W H P \$
19 1/4" 5 3/8" 7/8" \$35.49

EMERY: ONL19X11X01EM



W H P \$
19 1/4" 11 1/2" 1 5/8" \$34.43

FLEUR-DE-LIS: ONL19X24X02FL



W H P \$
19 3/8" 23 5/8" 2" \$49.86

DERIA: ONL20X24X02DR



W H P \$
19 1/2" 24 1/4" 2 1/8" \$61.73

PERALTA: ONL19X10X01PE



W H P \$
19 5/8" 10 5/8" 1 3/8" \$21.37

MARSEILLE: ONL19X09X01MA



W H P \$
19 3/4" 9 7/8" 1 1/8" \$21.37

VALENCE: ONL20X08X01VA



W H P \$
20 1/2" 8 7/8" 1 3/8" \$26.12

KINSLEY: ONL21X26KI



W H P \$
21 1/4" 25 5/8" 1 1/4" \$56.99

GRAPE: ONL21X04X01GR



W H P \$
21 3/8" 4 5/8" 1 3/8" \$26.12

MODENA: ONL22X20MO



W H P \$
21 5/8" 19 3/4" 2 3/8" \$105.66

ROSE & RIBBON: ONL22X12X01RO

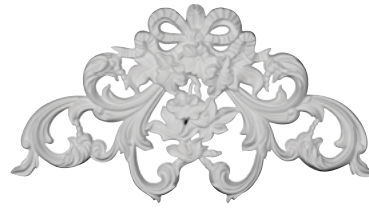

W H P \$
22 1/8" 12" 1 1/8" \$26.12

SAVONA: ONL22X08SA



W H P \$
22 1/4" 8 7/8" 1 1/8" \$49.69

EDWARDS: ONL22X18ED



W H P \$
22 1/4" 18 3/8" 2 1/4" \$51.05

MARCELLA: ONL22X06X01MA



W H P \$
22 1/2" 6 3/4" 1 1/8" \$24.93

SCROLL: ONL23X07X01SC



W H P \$
23 1/2" 7 1/4" 1 7/8" \$45.79

JACKSON: ONL24X09X01JA



W H P \$
24 3/8" 9 3/8" 1 3/4" \$52.24

DUBLIN: ONL25X05X01DU



W H P \$
25" 5 1/2" 1 3/8" \$29.68

TURIN: ONL26X16X01TU



W H P \$
26" 16 1/2" 1" \$52.24

ANGEL: APL28X09X02SC



W H P \$
28 1/2" 9 5/8" 2 3/4" \$73.61

PESCARA: ONL34X05X01PE



W H P \$
34 1/4" 5 1/4" 1 3/4" \$49.86

RALSTON: ONL14X30X02RA

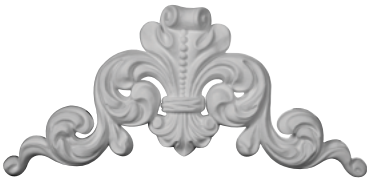

W H P \$
29 1/2" 13 3/4" 2 1/8" \$112.60

MODENA: ONL30X12X01MO



W H P \$
30 1/2" 12" 1 7/8" \$48.68

QUEENSTOWN: ONL31X14X02QU



W H P \$
31" 14 1/4" 2 3/8" \$52.24

★ **LEGACY:** ONL32X09X01LE



W H P \$
32 1/4" 8 7/8" 1 5/8" \$49.86

COLE: ONL32X10X02CO



W H P \$
32 1/4" 10 1/4" 2 1/2" \$80.73

PESCARA: ONL34X06X02PE



W H P \$
34 1/8" 5 7/8" 1 5/8" \$28.49

EMILY: ONL10X34X02EY



W H P \$
34 1/4" 10 1/4" 2" \$92.49



SHELL: ONL34X05X01SH

W	H	P	\$
34 1/2"	5 1/2"	1 3/4"	\$52.24

FLOWER: ONL35X12X02FB

W	H	P	\$
35 1/8"	12 1/2"	2 1/8"	\$102.01

HAVEN: ONL36X16X03HA

W	H	P	\$
35 1/2"	16 1/8"	3 3/8"	\$105.66

HARVEST: ONL08X36X02HA

W	H	P	\$
35 3/4"	7 7/8"	1 5/8"	\$81.80

GLADSTONE: ONL36X15X03GL

W	H	P	\$
36 1/4"	15 1/4"	2 3/4"	\$80.73

HAVEN: ONL11X37X02HV

W	H	P	\$
36 3/4"	11 3/8"	1 5/8"	\$104.71

VALENCE: ONL36X13VA

W	H	P	\$
36 3/4"	13 3/4"	1 3/4"	\$68.86

GRAPE: ONL39X08X02GR

W	H	P	\$
39"	8 7/8"	1 3/8"	\$54.61

MARSEILLE: ONL08X53X02MA

W	H	P	\$
40 1/2"	8"	1 5/8"	\$92.49

FLOWER: ONL40X12FB

W	H	P	\$
40 1/2"	12 1/4"	2 3/4"	\$56.99



ANGEL: APL42X21X03AN

W	H	P	\$
42 1/4"	21 1/4"	3 1/8"	\$123.47

KENDALL: ONL42X08KD

W	H	P	\$
42 3/8"	8 3/8"	2 1/2"	\$56.99

QUENTIN: ONL43X04X01QU

W	H	P	\$
43 1/4"	7"	1 1/4"	\$66.48

GLADSTONE: ONL43X14X03GL

W	H	P	\$
43 3/8"	13 3/4"	3 1/8"	\$105.66

MEDWAY: ONL46X09X01ME

W	H	P	\$
46"	9"	1 1/8"	\$75.98

VICEROY: ONL48X06X02VI

W	H	P	\$
48"	6"	2 1/4"	\$80.73



URETHANE DROPS & SWAGS

Our urethane drops and swags are the perfect accent pieces to cabinetry, furniture, fireplace mantels, ceilings and more. Each pattern is carefully crafted after traditional and historical designs. Each polyurethane piece is easily installed, just like wood pieces, with simple adhesives. It comes factory primed and ready for paint, faux finish, gel stain, marbleizing and more to make your project extra special.

214.613.2285 | Info@ArchitecturalBling.com | ArchitecturalBling.com

<p>MILTON: ONL01X04MI</p>  <p>W 1 1/8" H 4 3/4" P 1/4" \$ \$5.02</p>	<p>HILLSBOROUGH: ONL01X05X00HI</p>  <p>W 1 1/4" H 4 1/2" P 3/8" \$ \$6.72</p>	<p>SHELL: ONL01X07X01SH</p>  <p>W 1 1/4" H 6 3/4" P 1/2" \$ \$6.72</p>	<p>HILLSBOROUGH: ONL02X06X01HI</p>  <p>W 1 5/8" H 5 7/8" P 3/4" \$ \$6.72</p>
<p>MILTON: ONL02X07X01MI</p>  <p>W 1 3/4" H 6 1/2" P 3/4" \$ \$6.72</p>	<p>★ DOGWOOD: ONL02X19DG</p>  <p>W 2" H 19 5/8" P 3/4" \$ \$23.83</p>	<p>RIBBON: ONL02X03X00RI</p>  <p>W 2 3/8" H 3" P 3/8" \$ \$6.72</p>	<p>ASHFORD: ONL02X07X01AS</p>  <p>W 2 3/8" H 6 7/8" P 5/8" \$ \$6.72</p>



COLE: ONL03X07X01CO



W	H	P	\$
2 3/4"	6 7/8"	3/4"	\$6.72

BARCELONA: ONL03X11X01BA



W	H	P	\$
3"	11 3/4"	1 3/4"	\$13.80

ROSE: ONL03X08X01RO



W	H	P	\$
3 1/8"	8 1/4"	1"	\$12.87

VERSAILLES: ONL03X09X01VE



W	H	P	\$
3 1/2"	9 1/2"	5/8"	\$17.43

HILLSBOROUGH: ONL03X19X01HI



W	H	P	\$
3 7/8"	19 1/4"	1 1/4"	\$23.83

ASHLEY: ONL05X09X01AS



W	H	P	\$
4 1/2"	9 1/8"	7/8"	\$8.96

JUNIPER: ONL05X10X02JU



W	H	P	\$
4 1/2"	10 1/8"	2"	\$11.20

WREATH: ONL04X19X01WR



W	H	P	\$
4 5/8"	19 1/2"	1 3/8"	\$23.83

BIRD: ONL04X11X01BI



W	H	P	\$
4 3/4"	11 3/4"	1 3/8"	\$10.08

VERSAILLES: ONL04X11X01VE



W	H	P	\$
4 3/4"	11 3/8"	7/8"	\$20.12

MILTON: ONL05X13X01MI



W	H	P	\$
5 1/8"	13"	1"	\$16.31

ROSE: ONL05X15X02RO



W	H	P	\$
5 1/8"	15 3/4"	1 5/8"	\$21.72

VERSAILLES: ONL05X16X01VE



W	H	P	\$
5 3/4"	16 1/8"	1"	\$24.14

ROSE AND RIBBON: ONL06X09RO



W	H	P	\$
6 1/2"	9"	1"	\$11.29

CHESTERFIELD: ONL06X05X01CH



W	H	P	\$
6 7/8"	5 1/8"	5/8"	\$10.46

ROSE: ONL07X22X02RO



W	H	P	\$
7 1/8"	22"	2"	\$36.20

VERSAILLES: ONL08X09X01VE



W	H	P	\$
8 1/2"	9"	3/4"	\$19.31

FLOWER: ONL10X12X01FL



W	H	P	\$
10 5/8"	12 5/8"	3/4"	\$21.72

DUBLIN: ONL21X15X01DU



W	H	P	\$
21 1/8"	15 3/8"	1 1/8"	\$27.66

RIBBON: ONL25X27RI



W	H	P	\$
24 3/4"	27 3/8"	1"	\$67.09

GENOVA DROP

LEFT: ONL03X13X01GE-L RIGHT: ONL03X13X01GE-R

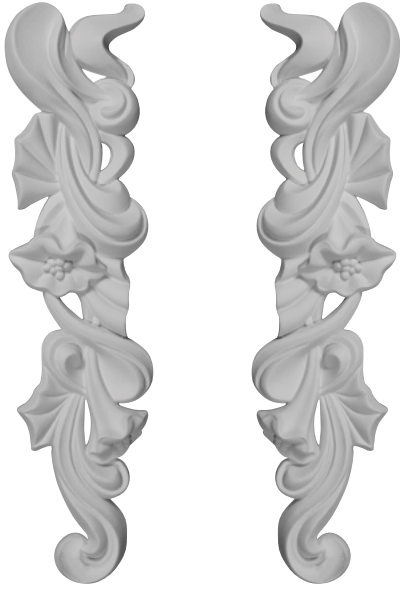

W 3 1/8" H 13 1/8" P 7/8" LEFT \$ \$21.73 RIGHT \$ \$22.06

OSLO DROP

LEFT: ONL05X33OS-L RIGHT: ONL05X33OS-R

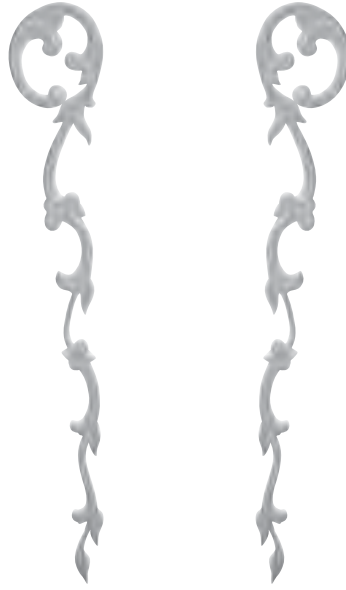

W 5 7/8" H 33 1/8" P 3/8" LEFT \$ \$41.40 RIGHT \$ \$41.40

FLOWER BELL DROP

LEFT: ONL06X37FL-L RIGHT: ONL06X37FL-R

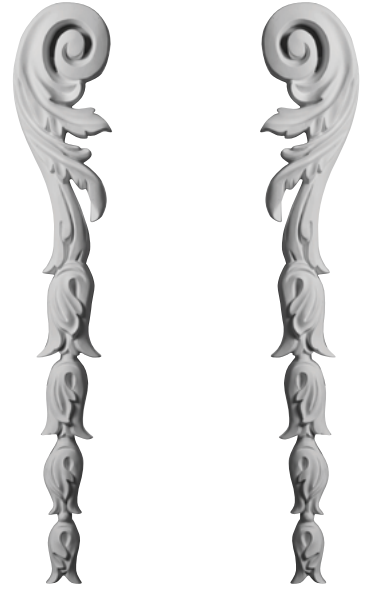

W 6" H 37 3/8" P 1 1/8" LEFT \$ \$40.49 RIGHT \$ \$40.49

SOUTHAMPTON: ONL04X02SO

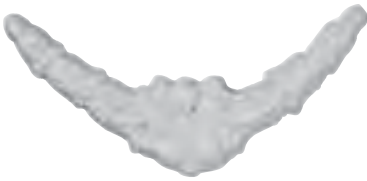

W 4 1/8" H 2" P 3/8" \$ \$6.50

BELL: ONL09X03X01BL

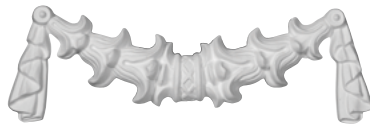

W 9 1/2" H 3 1/8" P 5/8" \$ \$13.68

DOLE: ONL09X02DO



W 9 5/8" H 2 1/8" P 7/8" \$ \$14.82

CENON: ONL10X02CE



W 10 1/4" H 2 3/8" P 5/8" \$ \$12.54

EMERY: ONL10X02X01EM



W 10 1/4" H 2 3/8" P 5/8" \$ \$13.68

FEDERAL: ONL13X05FE



W 12 5/8" H 5 1/8" P 5/8" \$ \$3.86

ROSE: ONL14X07X02RO



W 14 1/4" H 7" P 2" \$ \$20.56

CLASSIC: ONL15X07X01CL

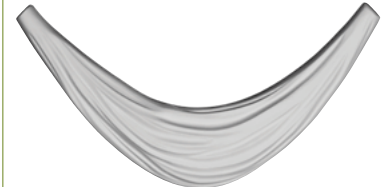

W 15 7/8" H 7 7/8" P 1 3/8" \$ \$13.44

MATERO: ONL16X09MA



W 16 1/8" H 9 7/8" P 3/4" \$ \$20.07

CLASSIC: ONL17X06X01CL



W 17 1/4" H 6 1/4" P 1 1/8" \$ \$16.80

ANTHONY: ONL17X11X01AT



W 17 1/2" H 11" P 1 1/2" \$ \$23.64

OSLO: ONL18X09X01OS



W 18" H 9" P 1 1/4" \$ \$24.55



ROSE: ONL18X12RO

W	H	P	\$
18 1/4"	12"	2 1/8"	\$24.30

★ **FLORAL:** ONL18X07X01FL

W	H	P	\$
18 7/8"	7"	1 3/8"	\$24.58

BOW: ONL19X06BF

W	H	P	\$
19"	6 1/2"	1 1/8"	\$17.64

SALEM: ONL23X07X02SA

W	H	P	\$
23"	7"	2"	\$39.87

DUBLIN: ONL24X10X01DU

W	H	P	\$
23 5/8"	10 1/4"	1 3/8"	\$35.62

ODESSA: ONL24X12X02OD

W	H	P	\$
24"	12"	2 1/2"	\$37.92

PALMETTO: ONL07X26X01PA

W	H	P	\$
26 1/4"	7 1/4"	1 1/8"	\$30.24

DUBLIN: ONL29X10X01DU

W	H	P	\$
28 7/8"	9 5/8"	1 3/8"	\$27.66

PALMETTO: ONL07X31X01PA

W	H	P	\$
30 1/2"	7 3/4"	1"	\$42.11

REECE: ONL31X11X02RE

W	H	P	\$
31"	11"	2 1/2"	\$45.01

CLASSIC: ONL32X14CL

W	H	P	\$
31 7/8"	14 1/4"	2"	\$55.05



FLORAL OR
CLASSIC
PICK YOUR
FAVORITE



URETHANE LEFT & RIGHT ONLAYS

Our left and right urethane onlays are perfect for framing in a feature or pairing with wall panels for a luxurious style. Delicate, intricate details, with deep relief and smooth texture, grant a high-end look for less. Made of the highest quality urethane, these embellishments offer a lasting upscale quality to furniture, cabinets, fireplaces, frames, doors and more.



GRANADA

LEFT: ONL02X05X01GR-L RIGHT: ONL02X05X01GR-R

W	H	P	LEFT \$	RIGHT \$
1 5/8"	5 1/8"	1/2"	\$7.12	\$7.12

WINGS

LEFT: ONL03X05X01WI-L RIGHT: ONL03X05X01WI-R

W	H	P	LEFT \$	RIGHT \$
2"	7 1/2"	3/4"	\$12.36	\$12.36

EDWARDS

LEFT: ONL02X05X01ED-L RIGHT: ONL02X05X01ED-R

W	H	P	LEFT \$	RIGHT \$
2"	5"	5/8"	\$7.12	\$7.12

GRANADA

LEFT: ONL02X07X01GR-L RIGHT: ONL02X07X01GR-R

W	H	P	LEFT \$	RIGHT \$
2 1/8"	7 3/8"	5/8"	\$12.78	\$12.78

MEDWAY

LEFT: ONL02X06X01ME-L RIGHT: ONL02X06X01ME-R

W	H	P	LEFT \$	RIGHT \$
2 1/4"	5 7/8"	5/8"	\$7.12	\$7.12

HILLSBOROUGH

LEFT: ONL02X06X01HI-L RIGHT: ONL02X06X01HI-R

W	H	P	LEFT \$	RIGHT \$
2 1/2"	6 1/4"	5/8"	\$11.09	\$11.09

ODESSA

LEFT: ONL07X02OD-L RIGHT: ONL07X02OD-R

W	H	P	LEFT \$	RIGHT \$
2 3/4"	7 3/4"	3/8"	\$17.59	\$17.59

ATTICA

LEFT: ONL03X05X01AT-L RIGHT: ONL03X05X01AT-R

W	H	P	LEFT \$	RIGHT \$
3"	4 7/8"	3/4"	\$12.36	\$12.36

ROBIN

LEFT: ONL03X06X01RB-L RIGHT: ONL03X06X01RB-R

W	H	P	LEFT \$	RIGHT \$
3"	6 3/8"	7/8"	\$9.50	\$9.50

OXFORD

LEFT: ONL063X04X01OX-L RIGHT: ONL063X04X01OX-R

W	H	P	LEFT \$	RIGHT \$
3 1/8"	4 3/4"	5/8"	\$12.36	\$12.36

ROBIN

LEFT: ONL03X09X01RB-L RIGHT: ONL03X09X01RB-R

W	H	P	LEFT \$	RIGHT \$
3 1/8"	9 1/8"	7/8"	\$9.50	\$9.50

WAKEFIELD

LEFT: ONL03X01WA-L RIGHT: ONL03X01WA-R

W	H	P	LEFT \$	RIGHT \$
3 1/4"	1 5/8"	1/4"	\$12.56	\$12.56

LEGACY

LEFT: ONL03X05X01LE-L RIGHT: ONL03X05X01LE-R

W	H	P	LEFT \$	RIGHT \$
3 3/8"	5"	1/2"	\$19.90	\$19.90

MEDWAY

LEFT: ONL04X06X01ME-L RIGHT: ONL04X06X01ME-R

W	H	P	LEFT \$	RIGHT \$
3 5/8"	6 3/8"	5/8"	\$9.50	\$9.50

ROBIN

LEFT: ONL04X10X01RB-L RIGHT: ONL04X10X01RB-R

W	H	P	LEFT \$	RIGHT \$
3 5/8"	9 1/2"	7/8"	\$9.50	\$9.50

NEEDHAM

LEFT: ONL03X06X01NE-L RIGHT: ONL03X06X01NE-R



W	H	P	LEFT \$	RIGHT \$
3 7/8"	6 3/4"	3/4"	\$12.78	\$12.78

HARVEST

LEFT: ONL04X08X01HA-L RIGHT: ONL04X08X01HA-R



W	H	P	LEFT \$	RIGHT \$
4"	8 1/8"	1 1/8"	\$5.94	\$5.94

ZEPHYR

LEFT: ONL04X07X01ZE-L RIGHT: ONL04X07X01ZE-R

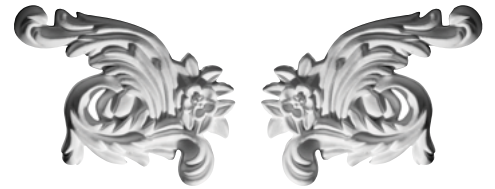

W	H	P	LEFT \$	RIGHT \$
4 1/4"	7"	7/8"	\$11.17	\$11.17

COLTON

LEFT: ONL04X06X00CO-L RIGHT: ONL04X06X00CO-R



W	H	P	LEFT \$	RIGHT \$
4 1/4"	5 3/4"	3/8"	\$8.31	\$8.31

CORNELIA

LEFT: ONL04X08X01CN-L RIGHT: ONL04X08X01CN-R



W	H	P	LEFT \$	RIGHT \$
4 3/8"	7 7/8"	7/8"	\$9.50	\$9.50

OSLO

LEFT: ONL04X03OS-L RIGHT: ONL04X03OS-R



W	H	P	LEFT \$	RIGHT \$
4 1/2"	3 7/8"	1/4"	\$12.56	\$12.56

ZADLO

LEFT: ONL04X08X01ZA-L RIGHT: ONL04X08X01ZA-R



W	H	P	LEFT \$	RIGHT \$
4 1/2"	8 5/8"	1"	\$10.68	\$10.68

ANGEL

LEFT: ONL05X07X02AN-L RIGHT: ONL05X07X02AN-R



W	H	P	LEFT \$	RIGHT \$
4 1/2"	7 1/8"	2 3/8"	\$11.87	\$11.87

EDWARDS

LEFT: ONL05X05X01ED-L RIGHT: ONL05X05X01ED-R

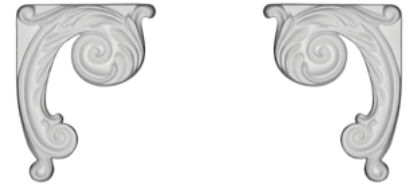

W	H	P	LEFT \$	RIGHT \$
4 1/2"	4 1/2"	5/8"	\$10.68	\$10.68

MEDWAY

LEFT: ONL04X03ME-L RIGHT: ONL04X03ME-R



W	H	P	LEFT \$	RIGHT \$
4 3/4"	3"	1/2"	\$11.29	\$11.29

HELENE

LEFT: ONL04X03X00HE-L RIGHT: ONL04X03X00HE-R

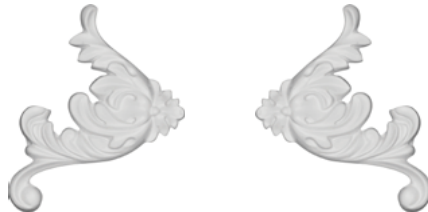

W	H	P	LEFT \$	RIGHT \$
4 3/4"	3 3/4"	5/8"	#N/A	\$5.34

LOERA

LEFT: ONL05X06X01LO-L RIGHT: ONL05X06X01LO-R



W	H	P	LEFT \$	RIGHT \$
4 3/4"	5 7/8"	7/8"	\$9.50	\$9.50

ANGEL

LEFT: ONL05X06X01AN-L RIGHT: ONL05X06X01AN-R



W	H	P	LEFT \$	RIGHT \$
5 1/8"	6 5/8"	1 1/8"	\$7.98	\$7.98

MARIA

LEFT: ONL05X02X00MA-L RIGHT: ONL05X02X00MA-R



W	H	P	LEFT \$	RIGHT \$
5 1/4"	2 1/2"	7/8"	\$6.60	\$6.60

OAK LEAF

LEFT: ONL05X03X01OL-L RIGHT: ONL05X03X01OL-R



W	H	P	LEFT \$	RIGHT \$
5 1/2"	3 1/2"	5/8"	\$11.94	\$11.94



BREMEN

LEFT: ONL06X12X01BR-L RIGHT: ONL06X12X01BR-R

W	H	P	LEFT \$	RIGHT \$
5 1/2"	11 1/2"	1"	\$11.87	\$11.87

WELLINGTON

LEFT: ONL05X03WE-L RIGHT: ONL05X03WE-R

W	H	P	LEFT \$	RIGHT \$
5 5/8"	3"	1/2"	\$18.86	\$18.86

MEDWAY

LEFT: ONL06X03X01ME-L RIGHT: ONL06X03X01ME-R

W	H	P	LEFT \$	RIGHT \$
5 3/4"	3 1/8"	5/8"	\$7.12	\$7.12

VERSAILLES

LEFT: ONL05X08X01-L RIGHT: ONL05X08X01-R

W	H	P	LEFT \$	RIGHT \$
5 7/8"	8 5/8"	3/4"	\$18.48	\$18.48

GALWAY

LEFT: ONL05X09X01GA-L RIGHT: ONL05X09X01GA-R

W	H	P	LEFT \$	RIGHT \$
5 7/8"	9 3/4"	1"	\$9.50	\$9.50

COLTON

LEFT: ONL06X04X01CO-L RIGHT: ONL06X04X01CO-R

W	H	P	LEFT \$	RIGHT \$
5 7/8"	4"	1/2"	\$11.87	\$11.87

MEDWAY

LEFT: ONL06X07X01ME-L RIGHT: ONL06X07X01ME-R

W	H	P	LEFT \$	RIGHT \$
5 7/8"	6 3/4"	7/8"	\$9.50	\$9.50

CHATEAU

LEFT: ONL06X02X01CH-L RIGHT: ONL06X02X01CH-R

W	H	P	LEFT \$	RIGHT \$
5 7/8"	2 3/8"	1/2"	\$9.50	\$9.50

SEVILLE

LEFT: ONL04X06X01SE-L RIGHT: ONL04X06X01SE-R

W	H	P	LEFT \$	RIGHT \$
6 1/8"	4 1/8"	5/8"	\$9.57	\$9.57

MEDWAY

LEFT: ONL07X16X01ME-L RIGHT: ONL07X16X01ME-R

W	H	P	LEFT \$	RIGHT \$
6 5/8"	16"	1 1/4"	\$15.43	\$15.43

SELLEK

LEFT: ONL06X02SK-L RIGHT: ONL06X02SK-R

W	H	P	LEFT \$	RIGHT \$
6 3/4"	2"	1/2"	\$18.86	\$18.86

PIEDMONT

LEFT: ONL07X03PE-L RIGHT: ONL07X03PE-R

W	H	P	LEFT \$	RIGHT \$
7 1/2"	3 7/8"	1/2"	\$9.31	\$9.31

PERFECT FOR
INTERIOR OR EXTERIOR
APPLICATIONS



SCROLL LEAF

LEFT: ONL04X07X01LF-L RIGHT: ONL04X07X01LF-R

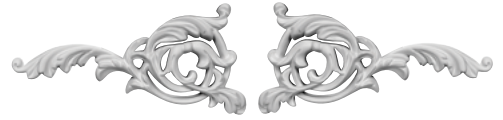

W	H	P	LEFT \$	RIGHT \$
7 3/4"	4 1/8"	3/4"	\$11.17	\$11.17

FLORAL

LEFT: ONL03X07X01FL-L RIGHT: ONL03X07X01FL-R



W	H	P	LEFT \$	RIGHT \$
7 3/4"	3"	7/8"	\$11.17	\$11.17

COLTON

LEFT: ONL07X07X01CO-L RIGHT: ONL07X07X01CO-R

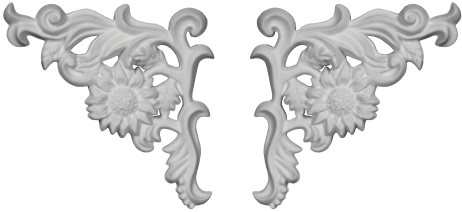

W	H	P	LEFT \$	RIGHT \$
7 7/8"	7 7/8"	3/4"	\$17.04	\$17.04



MEDWAY

LEFT: ONL07X04ME-L RIGHT: ONL07X04ME-R



W	H	P	LEFT \$	RIGHT \$
7 7/8"	4 1/8"	3/4"	\$9.42	\$9.42

CHATEAU

LEFT: ONL08X03X01CH-L RIGHT: ONL08X03X01CH-R



W	H	P	LEFT \$	RIGHT \$
8"	3 1/8"	1/2"	\$22.44	\$22.44

VERSAILLES

LEFT: ONL08X13X01VE-L RIGHT: ONL08X13X01VE-R

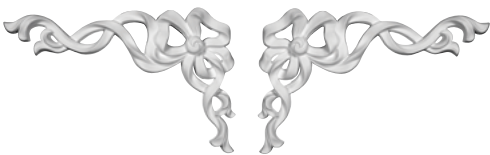

W	H	P	LEFT \$	RIGHT \$
8 1/4"	13"	7/8"	\$21.33	\$21.33

ANGEL

LEFT: ONL08X08X01AN-L RIGHT: ONL08X08X01AN-R



W	H	P	LEFT \$	RIGHT \$
8 1/4"	8 5/8"	7/8"	\$12.26	\$12.26

DYLAN

LEFT: ONL08X03X01DY-L RIGHT: ONL08X03X01DY-R



W	H	P	LEFT \$	RIGHT \$
8 1/4"	3 1/2"	1"	\$7.12	\$7.12

GRAPE

LEFT: ONL08X04X01GR-L RIGHT: ONL08X04X01GR-R



W	H	P	LEFT \$	RIGHT \$
8 5/8"	4 3/8"	3/4"	\$18.48	\$18.48

ERYN

LEFT: ONL08X02X00EN-L RIGHT: ONL08X02X00EN-R



W	H	P	LEFT \$	RIGHT \$
8 3/4"	2 3/4"	1/2"	\$5.94	\$5.94

TERRONES

LEFT: ONL08X07TS-L RIGHT: ONL08X07TS-R



W	H	P	LEFT \$	RIGHT \$
8 7/8"	7 1/8"	3/8"	\$17.59	\$17.59



BONETTI

LEFT: ONL08X05X00BO-L RIGHT: ONL08X05X00BO-R



W	H	P	LEFT \$	RIGHT \$
8 7/8"	5 7/8"	3/4"	\$9.50	\$9.50

FAIRFAX

LEFT: ONL09X09X01FA-L RIGHT: ONL09X09X01FA-R



W	H	P	LEFT \$	RIGHT \$
9"	9"	1 1/8"	\$15.43	\$15.43

ANGEL

LEFT: ONL09X13X04AN-L RIGHT: ONL09X13X04AN-R



W	H	P	LEFT \$	RIGHT \$
9 1/4"	13 3/8"	4"	\$26.12	\$26.12

IRWIN

LEFT: ONL09X07X00IR-L RIGHT: ONL09X07X00IR-R



W	H	P	LEFT \$	RIGHT \$
9 1/2"	7 1/2"	3/4"	\$9.50	\$9.50

DAMON

LEFT: ONL05X09X01DA-L RIGHT: ONL05X09X01DA-R

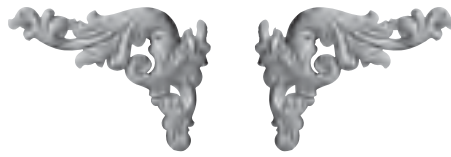

W	H	P	LEFT \$	RIGHT \$
9 3/4"	5 1/4"	5/8"	\$19.39	\$19.39

FRANKLIN

LEFT: ONL09X08X00FN-L RIGHT: ONL09X08X00FN-R



W	H	P	LEFT \$	RIGHT \$
9 3/4"	8 1/2"	7/8"	\$8.31	\$8.31

POMPEII

LEFT: ONL10X09X01PO-L RIGHT: ONL10X09X01PO-R



W	H	P	LEFT \$	RIGHT \$
10 5/8"	9 3/8"	1 1/8"	\$26.02	\$26.02

SEVILLE

LEFT: ONL10X09X01SE-L RIGHT: ONL10X09X01SE-R



W	H	P	LEFT \$	RIGHT \$
10 5/8"	9 3/8"	1 1/8"	\$26.02	\$26.02

VERSAILLES

LEFT: ONL11X15X01VE-L RIGHT: ONL11X15X01VE-R



W	H	P	LEFT \$	RIGHT \$
11"	15 3/4"	1 1/8"	\$24.87	\$24.87

MONIQUE

LEFT: ONL11X05X01MO-L RIGHT: ONL11X05X01MO-R



W	H	P	LEFT \$	RIGHT \$
11"	5 1/2"	1"	\$22.28	\$22.28

KINSLEY

LEFT: ONL12X16KI-L RIGHT: ONL12X16KI-R



W	H	P	LEFT \$	RIGHT \$
11 3/4"	15 3/4"	1 3/8"	\$28.13	\$28.13

DIJON

LEFT: ONL11X06X01DI-L RIGHT: ONL11X06X01DI-R



W	H	P	LEFT \$	RIGHT \$
11 3/4"	6 3/8"	1"	\$21.94	\$21.94

MEDWAY

LEFT: ONL12X05X01ME-L RIGHT: ONL12X05X01ME-R



W	H	P	LEFT \$	RIGHT \$
11 7/8"	4 7/8"	7/8"	\$9.50	\$9.50

ANGEL

LEFT: ONL12X17X06AN-L RIGHT: ONL12X17X06AN-R



W	H	P	LEFT \$	RIGHT \$
11 7/8"	17 3/8"	5 1/2"	\$58.17	\$58.17

AMBER

LEFT: ONL12X04X01AE-L RIGHT: ONL12X04X01AE-R



W	H	P	LEFT \$	RIGHT \$
12"	4 3/4"	1 3/8"	\$11.87	\$11.87

LAUREN

LEFT: ONL12X06X00LN-L RIGHT: ONL12X06X00LN-R



W	H	P	LEFT \$	RIGHT \$
12"	6"	3/4"	\$10.68	\$10.68

GORLEEN

LEFT: ONL12X01X00GO-L RIGHT: ONL12X01X00GO-R



W	H	P	LEFT \$	RIGHT \$
12 1/4"	1 1/4"	3/4"	\$8.31	\$8.31

KATHERYN

LEFT: ONL12X11X01KT-L RIGHT: ONL12X11X01KT-R

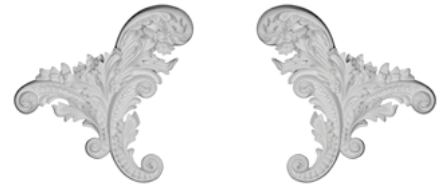

W	H	P	LEFT \$	RIGHT \$
12 1/4"	11 1/4"	1 1/8"	\$11.87	\$11.87

JAMIE

LEFT: ONL12X05X01JA-L RIGHT: ONL12X05X01JA-R



W	H	P	LEFT \$	RIGHT \$
12 3/8"	5 1/2"	1 3/8"	\$11.87	\$11.87

GRAPE

LEFT: ONL12X06X01GR-L RIGHT: ONL12X06X01GR-R



W	H	P	LEFT \$	RIGHT \$
12 5/8"	6 3/4"	1"	\$21.33	\$21.33

EMILY

LEFT: ONL10X13X01EY-L RIGHT: ONL10X13X01EY-R

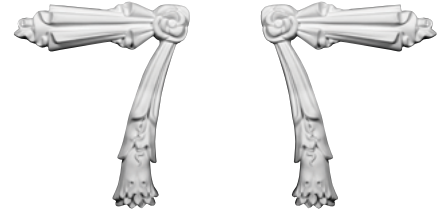

W	H	P	LEFT \$	RIGHT \$
12 3/4"	9 7/8"	1 1/4"	\$29.27	\$29.27

KIRKE

LEFT: ONL13X06X00KI-L RIGHT: ONL13X06X00KI-R



W	H	P	LEFT \$	RIGHT \$
13"	6 1/4"	3/4"	\$9.50	\$9.50

JUNIPER

LEFT: ONL14X07X00JU-L RIGHT: ONL14X07X00JU-R



W	H	P	LEFT \$	RIGHT \$
14 1/2"	7"	3/4"	\$10.68	\$10.68

AVERY

LEFT: ONL08X15X01AV-L RIGHT: ONL08X15X01AV-R



W	H	P	LEFT \$	RIGHT \$
15 3/8"	8 3/8"	1"	\$22.74	\$22.74

EDWARDS

LEFT: ONL16X20ED-L RIGHT: ONL16X20ED-R

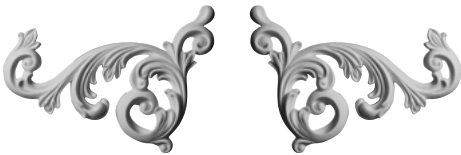

W	H	P	LEFT \$	RIGHT \$
15 3/4"	19 5/8"	1 3/8"	\$35.73	\$35.73

ROBIN

LEFT: ONL15X05RB-L RIGHT: ONL15X05RB-R



W	H	P	LEFT \$	RIGHT \$
15 3/4"	5 1/8"	1 1/8"	\$18.86	\$18.86

SCROLL

LEFT: ONL15X07LO-L RIGHT: ONL15X07LO-R



W	H	P	LEFT \$	RIGHT \$
15 3/4"	7 1/8"	1"	\$18.86	\$18.86

LOGAN

LEFT: ONL17X06X01LO-L RIGHT: ONL17X06X01LO-R



W	H	P	LEFT \$	RIGHT \$
17 1/4"	6 1/4"	1 1/8"	\$23.74	\$23.74

EDINBURGH

LEFT: ONL17X07X01ED-L RIGHT: ONL17X07X01ED-R



W	H	P	LEFT \$	RIGHT \$
17 1/2"	7"	1 1/8"	\$28.87	\$28.87

BONETTI

LEFT: ONL17X11X01BO-L RIGHT: ONL17X11X01BO-R



W	H	P	LEFT \$	RIGHT \$
17 5/8"	11 3/4"	1 1/4"	\$34.43	\$34.43



SCROLL

LEFT: ONL17X07X01PA-L RIGHT: ONL17X07X01PA-R



W	H	P	LEFT \$	RIGHT \$
17 3/4"	7 3/8"	1 1/8"	\$36.28	\$36.28

AVERY

LEFT: ONL19X11X01AV-L RIGHT: ONL19X11X01AV-R



W	H	P	LEFT \$	RIGHT \$
19 1/8"	11"	5/8"	\$16.62	\$16.62

LANARKSHIRE

LEFT: ONL23X04X00LA-L RIGHT: ONL23X04X00LA-R



W	H	P	LEFT \$	RIGHT \$
23 3/8"	4 1/2"	3/4"	\$37.92	\$37.92

ELSINORE

LEFT: ONL26X06X01EL-L RIGHT: ONL26X06X01EL-R



W	H	P	LEFT \$	RIGHT \$
26 3/4"	6 5/8"	1 1/8"	\$41.36	\$41.36

SUSSEX

LEFT: ONL26X10X01SU-L RIGHT: ONL26X10X01SU-R



W	H	P	LEFT \$	RIGHT \$
26 3/4"	10 3/4"	1 5/8"	\$47.87	\$47.87

AVERY

LEFT: ONL30X15X01AV-L RIGHT: ONL30X15X01AV-R



W	H	P	LEFT \$	RIGHT \$
29 3/4"	15 1/4"	1"	\$30.87	\$30.87



GENOVA DROP

LEFT: ONL03X13X01GE-L RIGHT: ONL03X13X01GE-R

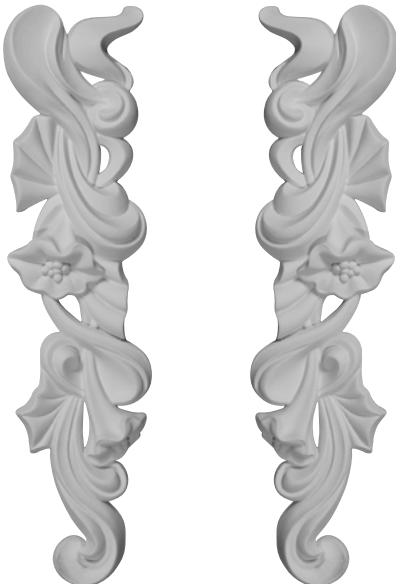

W	H	P	LEFT \$	RIGHT \$
3 1/8"	13 1/8"	7/8"	\$23.38	\$23.38

FLOWER BELL DROP

LEFT: ONL06X37FL-L RIGHT: ONL06X37FL-R



W	H	P	LEFT \$	RIGHT \$
6"	37 3/8"	1 1/8"	\$42.92	\$42.92

IDEAL
FOR CABINETRY
AND FURNITURE
PAIR WITH
PANEL MOULDING
& CENTER ONLAYS
FOR A CUSTOM LOOK

SMALL TRADITIONAL

LEFT: SB08X05TR-L RIGHT: SB08X05TR-R



W	H	P	LEFT \$	RIGHT \$
8"	5"	1/2"	\$15.43	\$15.43

ANTONIO

LEFT: SB08X05AN-L RIGHT: SB08X05AN-R



W	H	P	LEFT \$	RIGHT \$
8"	5 7/8"	5/8"	\$15.43	\$15.43

PEARL

LEFT: SB08X06PE-L RIGHT: SB08X06PE-R



W	H	P	LEFT \$	RIGHT \$
8"	6 1/2"	3/4"	\$15.43	\$15.43

TYRONE

LEFT: SB08X05TY-L RIGHT: SB08X05TY-R



W	H	P	LEFT \$	RIGHT \$
8 3/8"	5 7/8"	5/8"	\$15.43	\$15.43

FLOWER

LEFT: SB08X06FL-L RIGHT: SB08X06FL-R



W	H	P	LEFT \$	RIGHT \$
8 5/8"	6 1/4"	5/8"	\$15.43	\$15.43

ASHFORD

LEFT: SB08X07AS-L RIGHT: SB08X07AS-R



W	H	P	LEFT \$	RIGHT \$
8 3/4"	7 1/8"	5/8"	\$15.43	\$15.43

VICTORIAN

LEFT: SB09X07VI-L RIGHT: SB09X07VI-R

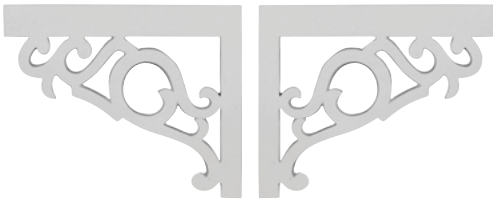

W	H	P	LEFT \$	RIGHT \$
8 3/4"	7 1/8"	3/4"	\$13.06	\$13.06

BREMEN

LEFT: SB08X05BR-L RIGHT: SB08X05BR-R

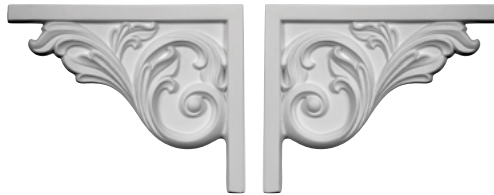

W	H	P	LEFT \$	RIGHT \$
8 3/4"	7 5/8"	5/8"	\$15.43	\$15.43



NESTOR

LEFT: SB09X07NS-L RIGHT: SB09X06ER-L



W	H	P	LEFT \$	RIGHT \$
9"	6 1/4"	5/8"	\$16.62	\$16.62

AUSTIN

LEFT: SB09X06ER-R RIGHT: SB09X07NS-R



W	H	P	LEFT \$	RIGHT \$
9"	6 1/2"	1/2"	\$15.43	\$15.43

ABERDEEN

LEFT: SB09X07AB-L RIGHT: SB09X07AB-R

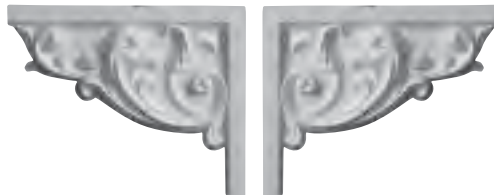

W	H	P	LEFT \$	RIGHT \$
9"	7"	3/4"	\$19.00	\$19.00

FLORAL

LEFT: SB09X07FL-L RIGHT: SB09X07FL-R



W	H	P	LEFT \$	RIGHT \$
9"	7 1/4"	5/8"	\$17.81	\$17.81

ATTICA

LEFT: SB09X07AT-L RIGHT: SB09X07AT-R



W	H	P	LEFT \$	RIGHT \$
9"	7 1/4"	3/4"	\$17.81	\$17.81

TELMA

LEFT: SB10X07TE-L RIGHT: SB10X07TE-R



W	H	P	LEFT \$	RIGHT \$
10 5/8"	7"	5/8"	\$16.62	\$16.62



VINCENT

LEFT: SB11X06VI-L RIGHT: SB11X06VI-R



W	H	P	LEFT \$	RIGHT \$
11"	6 1/4"	5/8"	\$16.62	\$16.62

WIDTH
HEIGHT
PROJECTION

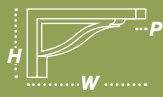

STAIRBRACKETS

LEGACY

LEFT: SB11X06LE-L RIGHT: SB11X06LE-R



W	H	P	LEFT \$	RIGHT \$
11"	6 3/8"	1/2"	\$16.62	\$16.62

PEARL

LEFT: SB11X07PE-L RIGHT: SB11X07PE-R



W	H	P	LEFT \$	RIGHT \$
11"	7"	5/8"	\$17.81	\$17.81



SPRINGTIME

LEFT: SB11X07SP-L RIGHT: SB11X07SP-R



W	H	P	LEFT \$	RIGHT \$
11"	7"	5/8"	\$17.81	\$17.81

SALEM

LEFT: SB11X07SA-L RIGHT: SB11X07SA-R



W	H	P	LEFT \$	RIGHT \$
11 1/4"	7 1/4"	1/2"	\$8.08	\$8.08

ASHFORD

LEFT: SB11X07AS-L RIGHT: SB11X07AS-R



W	H	P	LEFT \$	RIGHT \$
11 3/8"	7 5/8"	5/8"	\$17.81	\$17.81

LARGE TRADITIONAL

LEFT: SB11X07TR-L RIGHT: SB11X07TR-R

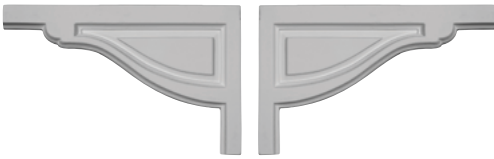

W	H	P	LEFT \$	RIGHT \$
11 3/4"	7 3/8"	1/2"	\$17.81	\$17.81

ACANTHUS

LEFT: SB11X07AC-L RIGHT: SB11X07AC-R



W	H	P	LEFT \$	RIGHT \$
11 3/4"	7 3/4"	3/4"	\$17.81	\$17.81

ATTICA

LEFT: SB11X07AT-L RIGHT: SB11X07AT-R



W	H	P	LEFT \$	RIGHT \$
11 3/4"	7 7/8"	3/4"	\$21.37	\$21.37

FLORAL

LEFT: SB11X07FL-L RIGHT: SB11X07FL-R



W	H	P	LEFT \$	RIGHT \$
11 3/4"	7 7/8"	3/4"	\$21.37	\$21.37

ASHFORD

LEFT: SB12X07MO-L RIGHT: SB12X07MO-R

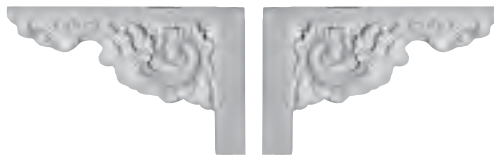

W	H	P	LEFT \$	RIGHT \$
12"	7 7/8"	7/8"	\$17.81	\$17.81

SCROLL

LEFT: SB12X06SC-L RIGHT: SB12X06SC-R



W	H	P	LEFT \$	RIGHT \$
12 3/8"	6 5/8"	3/4"	\$17.81	\$17.81



URETHANE SCONCES & SHELVES

These shelves are truly unique in design and function. Primarily used in decorative applications, urethane shelves can make a dramatic difference in kitchens, bathrooms, entryways, small spaces and more. This material is also perfect for exterior applications, as it will not rot or crack and is impervious to insect infestations. It comes factory primed ready for paint, faux finish, gel stain, and more. The versatility and durability of these shelves make them a great solution to display your favorite things.

WALL SHELF

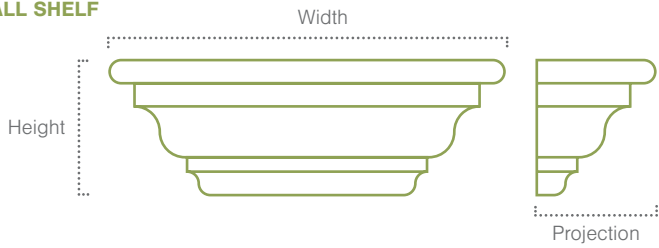

CORNER SHELF

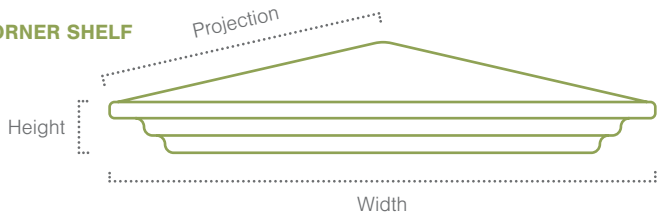

SCONCE

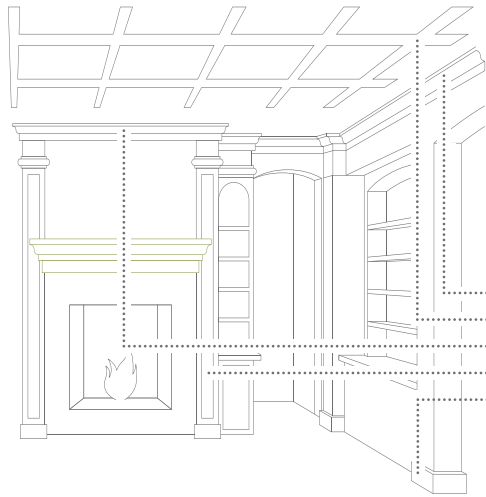

Sconces & Shelves compliment other features, such as crown moulding, baseboard, crossheads, pilasters and coffered ceilings.

- Crown Moulding
- Coffered Ceilings
- Crossheads
- Pilasters
- Baseboard

Smooth

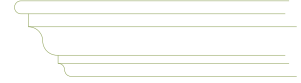

Ornate



Egg & Dart

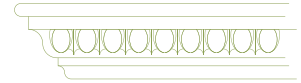



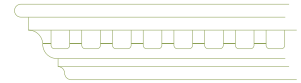

Dentil





CLASSICMINISHELF

PRODUCT #	W	H	P	\$
				
SH60X03X03CL	60"	2 5/8"	3 1/8"	\$76.10
				
SH48X03X03CL	48"	2 5/8"	3 1/8"	\$63.88
				
SH36X03X03CL	36"	2 5/8"	3 1/8"	\$49.27
				
SH30X03X03CL	30"	2 5/8"	3 1/8"	\$38.94
				
★ SH12X03X03CL	12"	2 5/8"	3 1/8"	\$23.74

CORNERSHELF

PRODUCT #	W	H	P	\$
SH23X16X03	22 7/8"	2 5/8"	16 1/4"	\$72.30



BACK&INSTALLATION



WIDTH
HEIGHT
PROJECTION



SCONCES & SHELVES

CORNERSHELF

PRODUCT #	W	H	P	\$
SH23X16X04EG	22 3/4"	3 7/8"	16 1/8"	\$94.74



BACK & INSTALLATION



EGG & DART SHELF

PRODUCT #	W	H	P	\$
SH60X04X05EG	60"	3 7/8"	5 1/4"	\$121.57



SH48X04X05EG	48"	3 7/8"	5 1/4"	\$102.81
--------------	-----	--------	--------	----------



SH36X04X05EG	36"	3 7/8"	5 1/4"	\$77.88
--------------	-----	--------	--------	---------



SH30X04X05EG	30"	3 7/8"	5 1/4"	\$67.31
--------------	-----	--------	--------	---------



SH24X04X05EG	24"	3 7/8"	5 1/4"	\$49.86
--------------	-----	--------	--------	---------



SH12X04X05EG	12"	3 7/8"	5 1/4"	\$33.72
--------------	-----	--------	--------	---------



CORNERSHELF

PRODUCT #	W	H	P	\$
SH23X16X05TI	22 3/4"	5 3/8"	16 1/8"	\$122.17



BACK & INSTALLATION



TIRANA SHELF

PRODUCT #	W	H	P	\$
SH60X05X05TI	60"	5 1/2"	5 1/8"	\$168.35



SH48X05X05TI	47"	5 1/2"	5 1/8"	\$130.95
--------------	-----	--------	--------	----------



SH36X05X05TI	36"	5 1/2"	5 1/8"	\$106.02
--------------	-----	--------	--------	----------

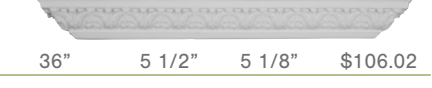

SH30X05X05TI	30"	5 1/2"	5 1/8"	\$86.07
--------------	-----	--------	--------	---------

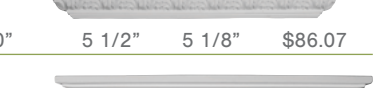







SH24X05X05TI	24"	5 1/2"	5 1/8"	\$68.62
--------------	-----	--------	--------	---------



SH12X05X05TI	12"	5 1/2"	5 1/8"	\$37.40
--------------	-----	--------	--------	---------



CLASSICSHELF

PRODUCT #	W	H	P	\$
				
SH60X04X04CL	60"	4 1/2"	4 1/2"	\$121.57
				
SH48X04X04CL	48"	4 1/2"	4 1/2"	\$99.72
				
SH36X04X04CL	36"	4 1/2"	4 1/2"	\$74.79
				
SH30X04X04CL	30"	4 1/2"	4 1/2"	\$71.71
				
SH24X04X04CL	24"	4 1/2"	4 1/2"	\$49.86
				
SH12X04X04CL	12"	4 1/2"	4 1/2"	\$28.02

CORNERSHELF







PRODUCT #	W	H	P	\$
SH23X16X04CL	22 3/4"	4 1/2"	16 1/8"	\$93.56



BACK&INSTALLATION



DENTILSHELF

PRODUCT #	W	H	P	\$
				
SH60X04X04DE	60"	4 1/2"	4 1/8"	\$106.02
				
SH48X04X04DE	48"	4 1/2"	4 1/8"	\$87.26
				
SH36X04X04DE	36"	4 1/2"	4 1/8"	\$68.62
				
SH30X04X04DE	30"	4 1/2"	4 1/8"	\$59.24
				
SH24X04X04DE	24"	4 1/2"	4 1/8"	\$49.86
				
SH12X04X04DE	12"	4 1/2"	4 1/8"	\$28.02

CORNERSHELF

PRODUCT #	W	H	P	\$
SH23X16X05DE	22 3/4"	4 5/8"	16 1/4"	\$103.52

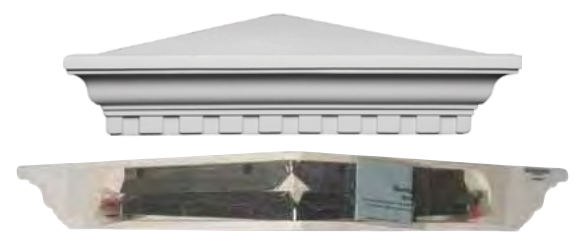

BACK&INSTALLATION



WIDTH
HEIGHT
PROJECTION



SCONCES & SHELVES

CORNERSHELF

PRODUCT #	W	H	P	\$
SH23X16X04VE	22 3/4"	4 3/8"	16 1/8"	\$99.72



BACK&INSTALLATION



VERSAILLESHELF

PRODUCT #	W	H	P	\$
-----------	---	---	---	----



SH60X04X04VE	60"	4 3/8"	4 1/8"	\$155.88
--------------	-----	--------	--------	----------



SH48X04X04VE	48"	4 3/8"	4 1/8"	\$128.45
--------------	-----	--------	--------	----------



SH36X04X04VE	36"	4 3/8"	4 1/8"	\$90.70
--------------	-----	--------	--------	---------



SH30X04X04VE	30"	4 3/8"	4 1/8"	\$78.24
--------------	-----	--------	--------	---------



SH24X04X04VE	24"	4 3/8"	4 1/8"	\$62.92
--------------	-----	--------	--------	---------



SH12X04X04VE	12"	4 3/8"	4 1/8"	\$29.91
--------------	-----	--------	--------	---------

CORNERSHELF

PRODUCT #	W	H	P	\$
SH23X16X07VI	22 3/4"	7 1/4"	16 1/8"	\$122.17



BACK&INSTALLATION



VICTORIANSHELF

PRODUCT #	W	H	P	\$
-----------	---	---	---	----



SH48X07X09VI	48"	7 3/8"	9 1/8"	\$196.37
--------------	-----	--------	--------	----------



SH36X07X09VI	36"	7 3/8"	9 1/8"	\$153.98
--------------	-----	--------	--------	----------



SH30X07X09VI	30"	7 3/8"	9 1/8"	\$126.80
--------------	-----	--------	--------	----------



SH24X07X09VI	24"	7 3/8"	9 1/8"	\$107.80
--------------	-----	--------	--------	----------



SH18X07X09VI	18"	7 3/8"	9 1/8"	\$77.88
--------------	-----	--------	--------	---------

RIBBON: SH09X04X12CH



W H P \$
9 3/4" 12 1/8" 4 1/2" \$24.93

SHELL: SH10X06X07SH



W H P \$
10 3/8" 7 3/8" 6" \$25.52

ANGEL: SH12X07X07AN



W H P \$
12 1/4" 6 7/8" 6 7/8" \$54.25

HILLSBOROUGH: SH13X06X03HI



W H P \$
13 1/8" 6 5/8" 3 3/4" \$28.24

TURIN: SH09X15X05TU



W H P \$
14 5/8" 8 7/8" 5" \$47.01

HURLEY: SH14X16X04HU



W H P \$
15 3/4" 14" 3 7/8" \$57.70

RIBBON: SH17X09X05CH



W H P \$
17 5/8" 9 1/4" 5 7/8" \$37.99

HILLSBOROUGH: SH20X06X04HI



W H P \$
20" 6 3/4" 4" \$48.68

DUNDEE: SH20X10X16DU



W H P \$
20 3/4" 16 7/8" 10 3/8" \$86.41



ODESSA: SH23X07X04OD



W H P \$
23 1/4" 7 1/8" 3 7/8" \$49.74

ACANTHUS: SH08X24X04AC



W H P \$
23 7/8" 7 7/8" 4 3/8" \$67.67

WAKEFIELD: SH31X04X08WA



W H P \$
31 1/2" 4 3/4" 7 7/8" \$85.22

★ **TRADITIONAL:** SCO07X06X16TR



W H P \$
7" 16 1/2" 6 7/8" \$139.31

★ **SEA SHELL:** SCO07X08X16SH



W H P \$
7 1/2" 16 1/8" 8" \$104.46

SEA SHELL: SCO10X05X12AS



W H P \$
10 1/8" 12 1/2" 5 1/2" \$35.61

SPIRAL: SCO10X05X12SH



W H P \$
10 1/8" 12 1/2" 5 1/2" \$36.12

SHELL: SCO11X07X06SH



W H P \$
11 3/8" 6 5/8" 7 1/8" \$26.18

WIDTH
HEIGHT
PROJECTION



SCONCES & SHELVES

SPANISH: SCO12X12X18SS



W H P \$
12 3/8" 18 3/8" 12 3/8" \$74.68

ASHTON: SCO12X06X04AS



W H P \$
12 1/2" 4 7/8" 6 1/4" \$30.07

TRADITIONAL: SCO12X06X04TR



W H P \$
12 3/4" 4 7/8" 6 1/4" \$20.18

ANGEL: SCO14X06X15AN-R



W H P \$
13 7/8" 15 1/8" 6 7/8" \$63.88

BASIN: SCO14X06X06BA



W H P \$
14 1/8" 6" 6 7/8" \$36.72

ANGEL: SCO14X06X15AN-L



W H P \$
14 1/8" 15 1/8" 6 7/8" \$63.88

SHELL: SCO15X04X09SH



W H P \$
15" 9 5/8" 4 5/8" \$82.52

ASHFORD: SCO16X06X08AS



W H P \$
16 1/8" 6 1/4" 8 1/4" \$42.63



TRADITIONAL: SCO16X06X08TR



W H P \$
16 1/8" 6 1/4" 8 1/4" \$35.53

OAK LEAF: SCO16X17X08OL



W H P \$
16 1/8" 17 3/4" 8 5/8" \$106.58

BEADED: SCO16X08X05BD



W H P \$
16 1/4" 5" 8 1/4" \$74.68

PRINCESS: SCO16X20X06PR



W H P \$
16 1/2" 20 7/8" 6 3/4" \$99.47

ROSE: SCO17X10X08RO-L



W H P \$
17 3/4" 10 1/4" 8 1/4" \$53.30

ROSE: SCO17X10X08RO-R



W H P \$
17 3/4" 10 1/4" 8 1/4" \$53.30

RIBBON: SCO19X07X06RI



W H P \$
19 1/2" 6 5/8" 7 5/8" \$74.68

RIBBON: SCO19X08X06RI



W H P \$
19 7/8" 6 5/8" 7 7/8" \$53.25

ANGEL: SCO23X14X09AN



W H P \$
23 5/8" 14 1/8" 9 1/2" \$99.47

Architectural Specifications

Architectural Bling Polyurethane



1.1 Product Description

- 1.1.1 Architectural Bling pounds per cubic foot. The Architectural Bling urethane process provides a greater skin density than core density for increased durability.
- 1.1.2 All products are manufactured with a white or semi-white color coating. Further, these products receive a primer coat finish before they are shipped to customers. The combination of the integral shell-like skin, the barrier coat, and the primer top coat provide an excellent substrate for durable finishes.
- 1.1.3 Ultra violet rays do not affect properly coated products.
- 1.1.4 The compressive strength of polyurethane products falls within the 300-400 P.S.I. range. (The parts are not intended for structural use).
- 1.1.5 The tensile strength of polyurethane products falls within the 350-400 P.S.I. range. (The parts are not intended for structural use.)
- 1.1.6 The degree of flexibility of any given polyurethane product is determined by the size and shape of its cross section.
- 1.1.7 Architectural Bling urethane has a closed cell structure which provides protection from most solvents and renders it almost completely hydrophobic. It will not rot.
- 1.1.8 All Architectural Bling urethane products do not support the growth of mildew and fungus and further provide no nutritional value for other organisms such as small rodents.

1.2 Submittals

- 1.2.1 Submit Architectural Bling urethane product data and shop drawings for customer approval.

2.1 Acceptable Manufacturer

- 2.1.1 Architectural Bling, Inc.
1410 G Avenue
Plano, TX 75074
Phone: 214.613.2285
Email: Admin@ArchitecturalBling.com
Web: ArchitecturalBling.com

3.1 Installation

- 3.1.1 Architectural Bling, Inc. urethane products are handled in the same manner as wood millwork.
- 3.1.2 Architectural Bling adhesives: refer to model PL Premium.
- 3.1.3 Fasteners refer to nails, screws, bolts etc.
- 3.1.4 Architectural Bling adhesives and fasteners must be used for installing all Architectural Bling products on concrete, metal, vinyl or wood. Adhesive must be used on all joints to ensure the beauty of your installation for years to come.

Architectural Specifications

Architectural Bling Polyurethane



3.2 Finishing

- 3.2.1 Architectural Bling, Inc. products are supplied with a white or beige primer base coat, ready for finishing top coat. A good quality exterior or latex or oil base paint may be used on rigid Architectural Bling product. The surface must be clean, dry, and free from all greases or waxes before all finish work has begun.

3.3 Warranty

- 3.3.1 Architectural Bling, Inc. warrants its urethane product upon the following conditions against defects in materials and workmanship for the product's lifetime when used and installed under recommended conditions. Purchaser and installer must inspect each piece prior to installation. Both parties waive all defects which could have been discovered by reasonable inspection prior to installation.
- 3.3.2 Warranty will automatically be void if Architectural Bling installation methods are not used as per section on Installation.
- 3.3.3 In the event claim is made under this warrant, Architectural Bling has the right to inspect the part and determine at their discretion, that the parts supplied are defective. Architectural Bling will repair, or if necessary, replace the defective parts if returned freight prepaid to Architectural Bling place of manufacturing. If Architectural Bling determines the parts cannot be repaired or replaced, Architectural Bling will refund to the distributor the amount paid to Architectural Bling for the said defective parts.
- 3.3.4 Architectural Bling shall have no liability to any person, firm, or corporation whatsoever for incidental or consequential damages such as but not limited to labor, finishing, parts damaged by freight carriers, freight, installation, lost profits, and lost sales or the like.
- 3.3.5 No purchaser may take any deduction or credit against any amount owed to Architectural Bling or make any charge back without the expressed written consent of Architectural Bling, Inc..
- 3.3.6 No purchaser may take any deduction or credit against any amount owed to Architectural Bling or make any charge back without the expressed written consent of Architectural Bling, Inc..



Section 1 General Product & Company Information

Address Architectural Bling, Inc.
Dallas Design District
105 Turtle Creek Blvd - Suite 150
Dallas, TX 75207

Telephone 214.613.2285

Fax

Chemical Name MSDS Polyurethane

Section 2 Hazardous Ingredients

Hazards None Known

Section 3 Physical / Chemical Characteristics

Density 5 - 42 lbs per cubic foot

Boiling Point Vapor N/A Material is Solid

Pressure Melting N/A Material is Solid

Point Vapor Density N/A

Evaporation Rate N/A

Appearance N/A

Odor Exterior - White, Off-White, or
Yellow Interior - White or Yellow
None

Section 4 Fire & Explosion Hazard Data

Flash Point in EXCESS of 750 degrees F

Extinguishing Method Dry Chemical, CO₂, Foam, or Water

Special Fire fighting Procedures Wear approved self-contained breathing apparatus

Unusual Fire & Explosion Hazard N/A zero VOC

Section 5 Reactivity Data

Stability Stable - Yes
Unstable - No

Conditions to Avoid Avoid an open flame in Excess of 750 degrees F

Hazardous Decomposition Products Combustion may form CO, CO₂, Benzene, Nitrogen Oxides,
and/or Hydrogen Cyanide.

Hazardous Polymerization None will occur



Section 6 Health Hazard Data

Acute	Cutting, Grinding, or Sanding polyurethane foam can generate dust. This dust may cause respiratory irritation if inhaled.
Routes of Entry	
Skin	Possible
Ingestion	Possible
Threshold Limit Value (TLV)	None Established
Chronic	None Known
Signs/Symptoms of Exposure	Eye and/or respiratory tract irritation. Redness and/or swelling on areas of contact.
Emergency/First Aid	
Inhalation	Remove from area if dust is inhaled. Consult physician if irritation continues.
Eye Contact	Flush eyes with water. Consult physician if irritation continues.

Section 7 Precautions for Safe Handling and Disposal:

Waste Disposal Method:	Disposal in accordance with local, state, and federal regulations for disposal of solid waste.
Special Precautions:	N/A N/A
Steps to be taken if material is released or spilled	

Section 8 Control Measures

Respiratory Protection:	No Respirator necessary.
Ventilation:	Adequate ventilation when cutting or sanding is required.
Protective Gloves:	Not necessary, but suggested.
Eye Protection:	Safety glasses with eye shields when cutting or moving.
Other Protective Clothing or Equipment:	Eye wash station should be available.

NOTE: All information in this document is believe to be accurate as of 8/1/2015

Architectural Bling® Thermoformed PVC Millwork General Information & Limited Lifetime Warranty

Architectural Bling warrants its line of PVC products including those listed below, as follows

Architectural Bling warrants to the owner of a property on which any of the above products have been installed that they are free from manufacturing defects which result in cracking, splitting, and excessive fading under normal weather conditions for a lifetime. This warranty is subject to the following limitations

1. The warranted product must have been installed in accordance with the manufacturer's installation instructions. Products not installed in this manner will not be warranted.
2. Architectural Bling shall solely determine whether the product was installed according to its installation instructions.
3. In the case of a claim of excessive fading, the homeowner is advised that some degree of fading over time is expected. Therefore, Architectural Bling shall solely determine whether the amount of fading in any particular case is excessive. Architectural Bling will not be held responsible for fading, peeling, cracking or any other deterioration of finishes applied by any third parties.
4. The owner shall have the burden of establishing to Architectural Bling's reasonable satisfaction the date of purchase of the product on which a claim is made.
5. In the event of a claim during the warranty period, Architectural Bling at its sole option will either a) repair or replace the warranted product's without charge to the owner, or b) if Architectural Bling is unable to repair the product in a commercially reasonable fashion and if Architectural Bling is unable to replace the product for example, because it has been discontinued, or notwithstanding that the product may be repaired or replaced, the homeowner nevertheless chooses to accept a refund, Architectural Bling will refund to the homeowner a sum equal to the actual price paid for the product at the time of purchase less reasonable depreciation from the date of purchase, which shall be determined as outlined above, to the date of the claim.
6. This warranty excludes reasonable travel expenses and labor charges incurred by Architectural Bling and/or its contractors in removing and/or replacing a warranted product.
7. If Architectural Bling attempts a reasonable number of times to repair a defective product under this warranty but those attempts are unsuccessful, Architectural Bling at its option may either replace the product or pay a refund to the homeowner as provided above.
8. This warranty will not cover claims for the following a) damage to or failure of a warranted product resulting from acts of the owner or the installer, b) damage to or failure of the product resulting from unreasonable use or the failure to reasonably maintain the product after the date of purchase.
9. THE PROVISIONS OF THIS WARRANTY ARE IN LIEU OF ANY OTHER WARRANTY EXPRESS OR IMPLIED INCLUDING SPECIFICALLY, BUT NOT LIMITED TO ANY WARRANTY OF MERCHANTABILITY OR FITNESS FOR A PARTICULAR PURPOSE.
10. THE OBLIGATIONS AND LIABILITIES OF ARCHITECTURAL BLING UNDER THIS WARRANTY OR UNDER ANY IMPLIED WARRANTY WHICH IS APPLICABLE DESPITE THE PRECEDING DISCLAIMER ARE IN LIEU OF ALL OTHER OBLIGATIONS OR LIABILITIES INCLUDING, WITHOUT LIMITATION, LIABILITY FOR INCIDENTAL, CONSEQUENTIAL AND/OR ANY OTHER DAMAGES BASED UPON ANY THEORY OF RECOVERY AT LAW OR IN EQUITY INCLUDING SPECIFICALLY ANY THEORY OF NEGLIGENCE, BREACH OF CONTRACT, BREACH OF WARRANTY, OR STRICT LIABILITY.

Architectural Bling® Urethane Millwork General Information & Limited Lifetime Warranty

Before you use or install any Architectural Bling urethane products, please review the information below.

Architectural Bling urethane products:

- Should be used for decorative applications only (unless clearly stated otherwise in catalog)
- Easier to repair than wood. With the use of wood filler or automotive filler, dents or gashes of any size can be quickly filled.
- Will resist all natural elements, except for direct sunlight to the unpainted yellow/tan underside of the millwork. Urethane products must be properly painted within 30 days of installation. We recommend painting the product before installation and touching it up after installation is completed. Exterior products must be painted with an exterior grade 100% acrylic latex paint and UV protectant as needed.
- It is important to fill damaged or cut surfaces within a few days.
- Withstand temperatures of above 140°F.
- Should never be installed with mechanical fasteners only. Best installation requires non-corrosive fasteners along with urethane base PL Premium Adhesive.
- Smaller molding profiles should not be stored in extreme heat. Architectural Bling urethane products should be acclimated for two days prior to installation.
- May require altered installation procedures to meet local specifications. Please check local building codes prior to installing.

Architectural Bling Urethane Millwork Limited Lifetime Warranty

Architectural Bling provides a LIFETIME WARRANTY to the original purchaser of our line of urethane millwork. This LIFETIME WARRANTY provides that the urethane material will be free from manufacturer defects in material and workmanship under approved normal use.

If a defect is discovered in an Architectural Bling urethane product and the above conditions have been met, the customer should notify us in writing within thirty (30) days of discovering the said defect. The customer may be required to return the product to Architectural Bling for evaluation when applicable. Architectural Bling will then review the product and installation methods, and determine if replacement, repair, or refund is appropriate. This warranty does not cover or include labor, transportation costs, or any other expenses incurred in connection with the purchase, use, or installation of the item(s). Replacements, repairs, or refunds are the only options under this limited warranty.

Architectural Bling defines seacoast as within three (3) miles from a coastal seashore. If you live in a seacoast environment, the warranty coverage is different for certain product components due to environmental factors, such as salt spray and other abrasive materials. Additional maintenance including preferred coatings is required in a seacoast environment.

This limited warranty does not cover damage from the result of mishandling in transportation, acts of God, customer modifications, vandalism, misuse, abuse, improper maintenance, unreasonable care, or other causes that did not arise from manufacturer defects in workmanship and/or materials. No person, retailer, sales rep, dealer, service facility, or entity of any type is authorized to change, modify, or amend the terms of this limited warranty in any manner. Architectural Bling shall not be liable to the customer or to any other entity for any incidental or consequential damages or loss of profit from any defect in any items.

Architectural Bling® PVC Millwork General Information & Limited Lifetime Warranty

Terms: Subject to the terms and conditions of this Warranty, Architectural Bling warrants to the Homeowner that PVC products are free from manufacturing defects in material and workmanship if installed according to our installation instructions, and will not rot, peel, flake, corrode, blister, split, chip, fade excessively or fade unevenly when exposed evenly. While you own your home, this Warranty will remain in effect for your lifetime. This warranty is not transferable. Architectural Bling reserves the right to discontinue, modify or otherwise alter any of its products, including color, without prior notice. This Warranty is made exclusively and specifically to the person(s) who both owns and continuously resides in the home on which the products are installed (herein "Homeowner") if that person is the original purchaser of Architectural Bling's product(s) covered under this warranty. This warranty is also made to a Homeowner who purchases a newly constructed residence on which the product is installed directly from the builder. Where Architectural Bling's product(s) are installed on a structure (i) not occupied exclusively by the Homeowner (including his or her immediate family), (ii) used for income producing purposes, or (iii) used in a public or semi-public application, such as (but not limited to) a condominium, apartment building, house of worship, school, medical facility, senior living facility, government building, hotel, etc., then the warranty is made solely to the original owner of the structure ("Commercial Owner") and is not transferable.

The term of the Commercial Owner's warranty is 50 years, prorated below. If Architectural Bling determines that its product(s) have a manufacturing defect covered under the Terms of this Warranty, Architectural Bling will at its option, either (1) refund the purchase price of the material, or (2) replace any product it determines has a manufacturing defect. In no event shall ABling be responsible for any labor charges. In the event of repair, replacement, refinishing or coating, the warranty applicable to the original product(s) shall apply to the repaired, replaced, refinished or coated product and will extend for the balance of the original term of the warranty period. These remedies are the sole remedies for any defect of the product.

Number of years after installation	Covered on prorated basis:
Up to 5	100%
6	90%
7	80%
8	70%
9	60%
10-12	50%
13-15	30%
16-50	20%

Normal Weathering is defined as exposure to ultraviolet sun light and extremes of weather and atmosphere, which will cause any colored or painted surface to fade, darken, chalk or acquire a surface accumulation of dirt or stains. The severity of these conditions depends on air quality, the geographic location of the property and other local conditions over which ABling has no control. ABling shall determine, at its discretion, whether the siding is suffering from normal weathering (which is not covered by warranty). This conclusion shall be based on whether the product(s) evidences a change in color in excess of the Hunter Units as calculated according to ASTM D2244, as outlined in the chart herein. Product(s) must have been exposed to the same weathering conditions and not partially covered by other materials such as shutters, awnings, porticos or other materials.

Owner	Normal Delta E	Proration Schedule
Original Homeowner	4	100%
Commercial Homeowner	4	Follows product coverage above

THIS WARRANTY IS GIVEN IN LIEU OF ALL OTHER WARRANTIES, LIABILITIES OR OBLIGATIONS OF ARCHITECTURAL BLING, INC, EITHER EXPRESSED OR IMPLIED, EXCEPT THAT THE DURATION OF ANY IMPLIED WARRANTIES OF MERCHANTABILITY AND FITNESS FOR A PARTICULAR PURPOSE ARE LIMITED IN TIME TO THE DURATION OF THIS WARRANTY. ARCHITECTURAL BLING SHALL IN NO EVENT BE LIABLE FOR CONSEQUENTIAL OR INCIDENTAL OR SPECIAL DAMAGES OF ANY KIND. YOUR EXCLUSIVE REMEDY SHALL BE ENFORCEMENT OF THIS WARRANTY UPON THE TERMS AND CONDITIONS HERIN CONTAINED. NO REPRESENTATIVE OF ARCHITECTURAL BLING OR ITS DISTRIBUTORS OR DEALERS IS AUTHORIZED TO MAKE ANY CHANGE OR MODIFICAITON TO THIS WARRANTY.

Some States do not allow limitations on how long an implied warranty lasts, so the foregoing limitation may not apply to you.

Some States do not allow the exclusion or limitation of incidental or consequential damages, so the above limitation or exclusion may not apply to you.

Architectural Bling PVC Millwork Limited Lifetime Warranty

Architectural Bling provides a LIFETIME WARRANTY to the original purchaser of our line of PVC millwork. This LIFETIME WARRANTY provides that the PVC material will be free from manufacturer defects in material and workmanship under approved normal use.

Architectural Bling's warranty covers only manufacturing defects identified above. This warranty does not cover damage caused by other factors, including but not limited to: normal weathering (defined below), misuse, negligence or improper installation, failure to provide reasonable maintenance to prevent accumulation of dirt, mildew, staining materials, pollution, exposure to chemical products or incompatible cleaners, alterations like applying incompatible coatings, stains or varnishes (see technical information for compatible coatings if any), improper handling or storage, defects in the wall structure (materials or construction) on which Architectural Bling's products are installed which cause failure, such as movement, cracking or settling of the wall, foundation or building, deformation caused by high heat sources including but not limited to grills, fire pits, foil sheathing, low e-glass windows and low e-glass doors, damage caused by animals or insects, impact of foreign objects, hail, lightning, fire, hurricane, tornadoes, or other Acts of God, vandalism, intentional damage, riot or insurrection.

The claimant must provide date of installation and proof of property ownership. The claimant may be required to submit a sample of the defective materials for analysis. This sample may need to be removed from the property at the property owner's expense. Architectural Bling will analyze the material claimed to be defective and determine the validity of the claim.



The Architectural Bling Collections

3D Wall Panels
Crown Moulding
Crown Moulding Systems
Moulding Blocks
Panel Moulding
Panel Moulding Systems
Casing
Baseboard
Rosettes
Appliques & On lays
Drops & Swags
Stair Brackets
Sconces & Shelves
Brackets
Corbels
Niches
Ceiling Medallions
Ceiling Rings
Ceiling Domes
Ceiling Tiles

Plinths & Bases
Capitals
Surrounds
Balustrade
Rustic Timber Brackets
Rustic Timber Corbels
Rustic Timber Raftertails
Rustic Timber Outlookers
Rustic Timber Gable Brackets
Rustic Timber Gable Vents
PVC Gable Vents
Urethane Gable Vents
Steel Brackets
Iron Brackets
Wood Ceiling Medallions
Wood Crown Moulding
Wood Brackets
Wood Corbels
Wood Capitals & Bases
Wood Cabinet Columns

214.613.2285

Sales@ArchitecturalBling.com



174368

ARCHITECTURAL
BLING Inc.
Phone 214.613.2285
4020 N MacArthur Blvd.
Suite 122-270
IRVING, Tx 75038

www.ArchitecturalBling.com