

Fixed Pole Top Rack FXL-90

Specifications:

Array Size: Up to 90 square feet of solar modules

Overall Dimensions: 140" North-South (maximum)
126" East-West (maximum)

Mounting Pole: 6" Schedule 40 pipe (not provided by Zomeworks)

Recommended Pole Height: 9' above ground

Estimated Shipping Weight: 300 pounds, 3 packages, ships as class 60 and class 85 freight

Seasonal angle: 7.5° to 60° adjustable in 7.5° increments

Maximum Rail Length: 140"

Options: Some module layouts require an extra rail set
Stainless Steel Hardware (call for price)
Epoxy Primer (call for price)

Construction: Mild Steel H-frame and gimbal, extruded Aluminum module mounting rails

Wind Rating: 3 second wind gust up to 90 MPH

Hardware: Rack hardware is Zinc plated grade 5 and grade 8, module mounting hardware is Stainless Steel

Warranty: 10 year limited warranty

Retail Price: \$1,238.00 + shipping
\$335.00 for the extra rail set (if needed)

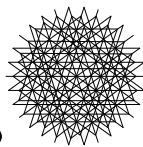
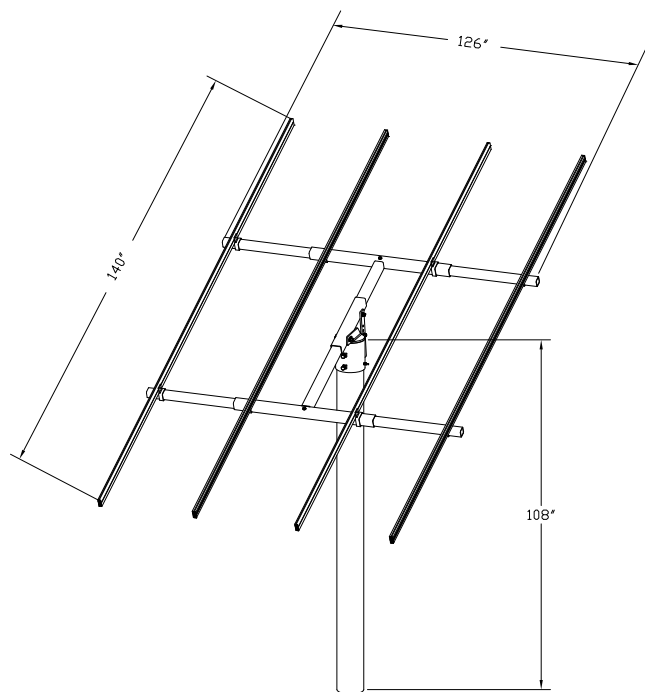

ZOMEWORKS CORPORATION

Post Office Box 25805 (1011 Sawmill Rd. NW) Albuquerque, New Mexico 87125

Website: www.zomeworks.com Email: zomework@zomeworks.com

[800] 279-6342 [505] 242-5354 phone [505] 243-5187 fax