

## Base Cabinets - ADA Compliant

- standard base cabinets are ADA compliant if specified 34" high
- see the Base section of this catalog for a complete selection of base cabinets



**1000**



**1102**



**1162**



**1212**

## ADA Sink / Vanity

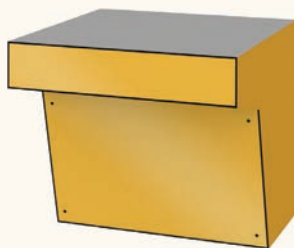

**1136**

W: 30", 36", 42", 48"  
H: 34"  
D: 24.25"

- all clearance dimensions in conformance with Federal Register Volume 56, No. 144, Rules & Regulations
- removable face panel for plumbing access
- specify finished ends
- accommodates 5.5" deep sink with rear outlet
- laminate countertop, or as specified
- in-wall blocking recommended, center at 30.25" a.f.f.

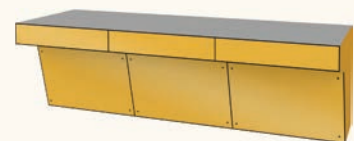
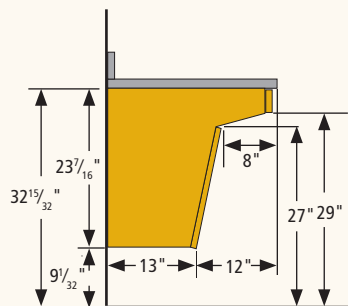

Model 1136 can be installed in runs where more capacity is needed.

## ADA Sink Apron & Panel



**1137**

W: 30" - 48"  
H: 30", 34"  
D: 23.25"

- panel, apron, and blocking only
- supported by other structure
- use ADA support #0474 for wide spans

## ADA Sink, Convertible



Open



Closed

**41000**

W: 39"  
H: 34"  
D: 24.25"

- pocket doors slide into side of cabinet, bottom raises up, and base folds back into cabinet
- "standard" sink cabinet appearance
- clearance dimensions conform with Federal Register Vol. 56, No. 144 rules and Regulations
- accommodates 5.5" deep sink with rear outlet

## Systems 90® - ADA Compliant

- Systems 90 is ADA compliant if specified 32" to 34" high
- see the Systems 90 section of this catalog for the complete selection of Systems 90 cabinets

### Worktop

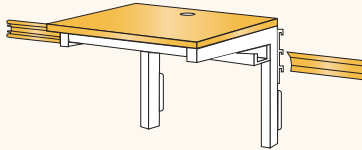

#### 40046 - standard laminate

- W: 24" - 60" (6" increments)  
 H : 23", worktop adjusts to 30", 33", 36"  
 D : 25", 30"
- flat top
  - brackets with 1.5" x 1.5" lateral support tubes
  - grommet hole
  - cable tray

### Open, Drawer



#### 40150

- W: 12" - 36" (3" increments)  
 H : 24"  
 D : 24.25"
- 1 drawer
  - 1 adjustable shelf

### Door



#### 40175 (shown) 40176 (reversed)

- W: 12" - 24" (3" increments)  
 H : 24"  
 D : 24.25"
- 1 door
  - 1 adjustable shelf

### Door, Drawer



#### 40185 (shown) 40186 (reversed)

- W: 12" - 24" (3" increments)  
 H : 24"  
 D : 24.25"
- 1 - 6" drawer
  - 1 door
  - 1 adjustable shelf

### Drawers



#### 40215

- W: 12" - 48" (3" increments)  
 H : 24"  
 D : 24.25"
- 2 - 6" drawers
  - 1 - 12" drawer

### Door

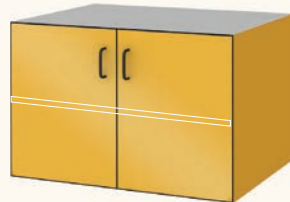

#### 40245

- W: 27" - 36" (3" increments)  
 H : 24"  
 D : 24.25"
- 2 doors
  - 1 adjustable shelf

### Open, Drawer



#### 40280

- W: 27" - 36" (3" increments)  
 H : 24"  
 D : 24.25"
- 2 - 6" drawers
  - 2 doors
  - 1 adjustable shelf

### 6" Drawers, Drawers



#### 40285

- W: 27" - 48" (3" increments)  
 H : 24"  
 D : 24.25"
- 2 - 6" top drawers
  - 1 intermediate drawer
  - 1 deep bottom drawer

### Heavy Duty Table



#### 20401

- W: 36", 48", 60", 72", 84"  
 H : 32", 34"  
 D : 25", 30", 36"
- steel frame finished in black powder coat
  - fixed height
  - 25" D table accepts standard Systems 90® cabinets
  - levelers

### Heavy Duty Table, Mobile



#### 20400

- W: 36", 48", 60", 72", 84"  
 H : 32", 34"  
 D : 25", 30", 36"
- steel frame finished in black powder coat
  - fixed height
  - 25" D table accepts standard Systems 90® cabinets
  - casters, 2 locking

### Heavy Duty Table Height Adjustable



#### 30020

- W: 36", 48", 60", 72", 84"  
 H : 27" - 36", adjustable  
 D : 25", 30", 36"
- steel frame finished in black powder coat
  - height adjustable on 1" increments
  - 25" D table accepts standard Systems 90® cabinets
  - levelers

### Heavy Duty Table, Mobile Height Adjustable



#### 30025

W: 36", 48", 60", 72", 84"  
H : 27" - 36", adjustable  
D : 25", 30", 36"

- steel frame finished in black powder coat
- height adjusts on 1" increments
- 25" D table accepts standard Systems 90° cabinets
- casters, 2 locking

### Medium Duty C-Frame Table



#### 41006

W: 36" - 72" (6" increments)  
H : 32", 34"  
D : 25", 30"

- steel frame finished in black powder coat
- horizontal stiffeners
- fixed height
- plastic laminate top and back
- levelers

### Medium Duty C-Frame Table Mobile



#### 41008

W: 36" - 72" (6" increments)  
H : 32", 34"  
D : 25", 30"

- steel frame finished in black powder coat
- horizontal stiffeners
- fixed height
- plastic laminate top and back
- casters, 2 locking

### Medium Duty C-Frame Table Height Adjustable



#### 41010

W: 36" - 72" (6" increments)  
H : 27" - 36" adjustable  
D : 25", 30"

- steel frame finished in black powder coat
- horizontal stiffeners
- height adjustable on 1" increments
- plastic laminate top and back
- levelers

### Medium Duty C-Frame Table Mobile, Height Adjustable



#### 41012

W: 36" - 72" (6" increments)  
H : 27" - 36" adjustable  
D : 25", 30"

- steel frame finished in black powder coat
- horizontal stiffeners
- height adjustable on 1" increments
- plastic laminate top and back
- casters, 2 locking

### Heavy Duty C-Frame Table



#### 41014

W: 36" - 72" (6" increments)  
H : 32", 34"  
D : 25", 30", 36"

- steel frame finished in black powder coat
- heavy duty twin vertical supports
- fixed height
- plastic laminate top and back
- levelers

**Heavy Duty C-Frame Table, Mobile**



**41016**

W: 36" - 72" (6" increments)  
 H : 32", 34"  
 D : 25", 30", 36"

- steel frame finished in black powder coat
- heavy duty twin vertical supports
- fixed height
- plastic laminate top and back
- casters, 2 locking

**Heavy Duty C-Frame Table, Height Adjustable**



**41018**

W: 36" - 72" (6" increments)  
 H : 27" - 36" adjustable  
 D : 25", 30", 36"

- steel frame finished in black powder coat
- heavy duty twin vertical supports
- height adjustable on 1" increments
- plastic laminate top and back
- levelers

**Heavy Duty C-Frame Table, Mobile, Height Adjustable**



**41020**

W: 36" - 72" (6" increments)  
 H : 27" - 36" adjustable  
 D : 25", 30", 36"

- steel frame finished in black powder coat
- heavy duty twin vertical supports
- height adjustable on 1" increments
- plastic laminate top and back
- casters, 2 locking

**Computer Carrel - Stand Alone or Starter Unit**



**30545**

W: 36", 42", 48"  
 H : 30" countertop  
 36" end panel height  
 D : 29"

- cable management tray
- electrical plug strip
- levelers
- laminate construction with high impact edging
- optional CPU holder mounts below countertop

**Computer Carrel - Add-on Unit**



**30546**

W: 35", 41", 47"  
 H : 30" countertop  
 36" end panel height  
 D : 29"

- cable management tray
- electrical plug strip
- levelers
- laminate construction with high impact edging
- optional CPU holder mounts below countertop

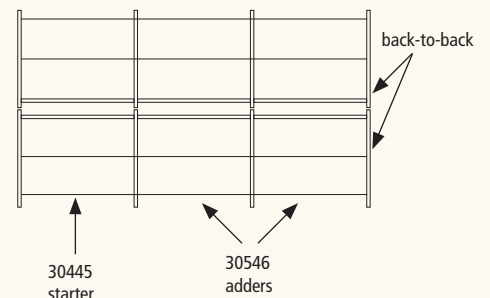
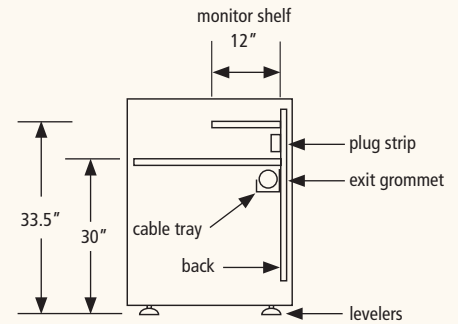

### Dual Computer Desk with Sight Panel for Independent Study



#### 30265

W: 60"  
H : 44" sight panel  
32" counter top  
D : 48"

- 3 section sight panel
- tackboard on right panel
- cable management tray with end grommets
- 2 countertop grommets (1 for each computer)

### Dual Computer Desk with Sight Panel for Independent Study



#### 30266

W: 60"  
H : 44" sight panel  
32" counter top  
D : 48"

- 3 section sight panel
- tackboard on right panel
- 1 - open compartment each side:  
18" W x 6.6" H x 18" D
- cable management tray with end grommets
- 2 countertop grommets (1 for each computer)

### Dual Computer Desk with Sight Panel for Independent Study



#### 30267

W: 60"  
H : 44" sight panel  
32" counter top  
D : 48"

- 3 section sight panel
- tackboard on right panel
- 1 - drawer each side:  
18" W x 6.6" H x 19" D
- cable management tray with end grommets
- 2 countertop grommets (1 for each computer)

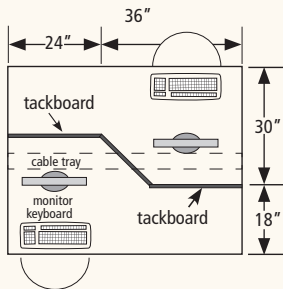

↑  
**This detail for  
computer desks  
above.**

**This detail for  
computer desks  
below.**

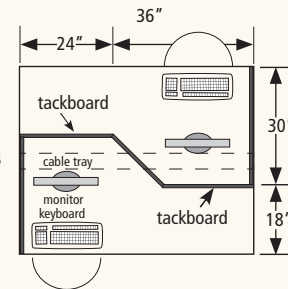

### Dual Computer Desk with Surround Panel for Independent Study



#### 30268

W: 60"  
H : 44" sight panel  
32" counter top  
D : 48"

- 5 section sight panel
- tackboard on right panel
- cable management tray with end grommets
- 2 countertop grommets (1 for each computer)

### Dual Computer Desk with Surround Panel for Independent Study



#### 30269

W: 60"  
H : 44" sight panel  
32" counter top  
D : 48"

- 5 section sight panel
- tackboard on right panel
- 1 - open compartment each side:  
18" W x 6.6" H x 18" D
- cable management tray with end grommets
- 2 countertop grommets (1 for each computer)

### Dual Computer Desk with Surround Panel for Independent Study



#### 30270

W: 60"  
H : 44" sight panel  
32" counter top  
D : 48"

- 5 section sight panel
- tackboard on right panel
- 1 - drawer each side:  
18" W x 6.6" H x 19" D
- cable management tray with end grommets
- 2 countertop grommets (1 for each computer)

**Science Pedestal Group**

This free standing science pedestal is designed for four students, including access by two or four students in wheelchairs. The countertop height of 34" and clearance of 29" under the apron meet ADA guidelines. The pedestal can be configured with cabinets on two sides, or with no storage. A continuous steel frame supports the worktop, cabinets, apron surrounds, removable pedestal panels, and mechanical and electrical services.

**20190 (shown)**

W: 54"  
H: 34"  
D: 54"

**Cabinets:**

W: 20"  
H: 17"  
D: 15.125"

**Pedestal:** 24" x 24"

**Top:** Specify Flat Epoxy or Marine Edge Epoxy

**Accessories:** top, sink, pedestal & apron with steel inner structure, rod sockets. Cabinets as specified below.

**Mechanical/Electrical fixturing:** Includes tamper resistant cold water and gas fixtures, apron mounted ground fault duplex receptacles, and burette rod sockets. Specify rods and crossbars separately.

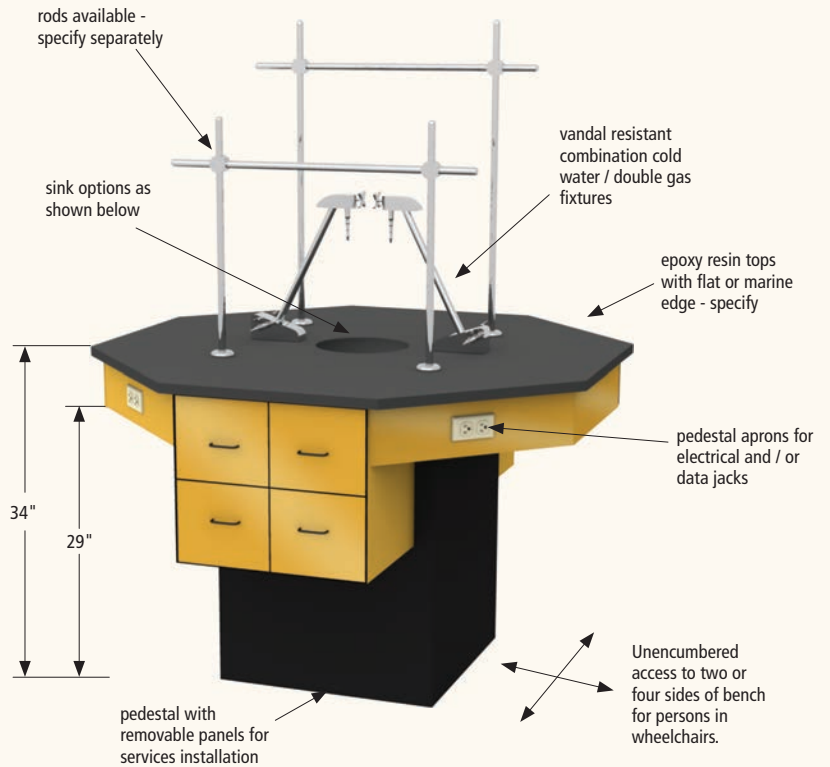

Top and Sink Configuration	Storage Cabinet Configuration	Cabinet Options		
		4 drawers 2 sides	2 doors 2 sides	no storage
2 cold water fixtures 4 gas valves 4 aprons w/duplex AC receptacle 4 rod sockets round sink		20190	20191	20193
2 cold water fixtures 4 gas valves 2 aprons w/duplex AC receptacle 4 rod sockets trough sink		20195	20196	20198
1 cold water fixture 2 gas valves 2 aprons w/duplex AC receptacle 4 rod sockets short trough sink		20225	20226	20228
4 aprons w/duplex AC receptacle 4 rod sockets no sink		20235	20236	20238

- Service piping, electrical conduit, drainlines, and traps are not included.
- Upright rod assemblies and or burette rods for the above units must be specified separately.

(Prices subject to change without notice)

BL Material, 144 Allen Blvd Suite B, Farmingdale, NY 11735, 631-246-1780 Web Site: info@blmaterials.com

**Computer Module - Stationary**



**50020**

- W: 34" overall (32" kneespace)  
 H: 35" overall (31" worktop, 29" kneespace)  
 D: 30"
- splash guard worktop
  - levelers
  - cable tray & grommets

**Computer Module - Mobile**



**50025**

- W: 34" overall (32" kneespace)  
 H: 35" overall (31" worktop, 29" kneespace)  
 D: 30"
- splash guard worktop
  - welded steel U-channel frame and casters
  - cable tray & grommets

**Computer Module-Stationary**

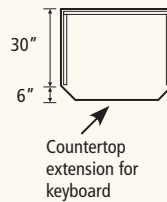

**50030**

- W: 34" overall (32" kneespace)  
 H: 35" overall (31" worktop, 29" kneespace)  
 D: 36"
- splash guard worktop with 6" keyboard extension
  - levelers
  - cable tray & grommets

**Computer Module - Mobile**



**50035**

- W: 34" overall (32" kneespace)  
 H: 35" overall (31" work top, 29" kneespace)  
 D: 36"
- splash guard worktop with 6" keyboard extension
  - welded steel U-channel frame and casters
  - cable tray & grommets

**Computer Module - Stationary**

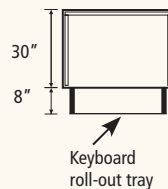

**50040**

- W: 34" overall (32" kneespace)  
 H: 38" overall (34" worktop, 29" kneespace)  
 D: 30" (38" with keyboard tray extended)
- splash guard worktop
  - keyboard tray pulls out with outboard keepers
  - cable tray & grommets

**Computer Module-Mobile**



**50045**

- W: 34" overall (32" kneespace)  
 H: 38" overall (34" worktop, 29" kneespace)  
 D: 30" (38" with keyboard tray extended)
- splash guard worktop
  - keyboard tray pulls out with outboard keepers
  - welded steel U-channel frame and casters
  - cable tray & grommets

**Wide or Two Student Computer Module Stationary**



**50050**

- W : 64" overall  
 H : 35" overall (31" worktop, 29" kneespace)  
 D : 30"
- splash guard worktop
  - cable tray & grommets

**Wide or Two Student Computer Module Mobile**



**50055**

- W : 64" overall  
 H : 35" overall (31" worktop, 29" kneespace)  
 D : 30"
- splash guard worktop
  - cable tray & grommets
  - welded steel U-channel frame and casters

**Wide or Two Student Computer Module Stationary**

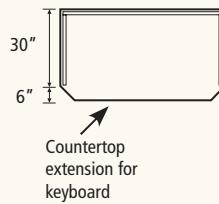
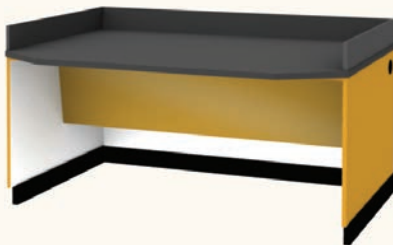

**50060**

- W : 64" overall  
 H : 35" overall (31" worktop, 29" kneespace)  
 D : 36"
- splash guard worktop with 6" keyboard bump-out
  - cable tray & grommets

**Wide or Two Student Computer Module Mobile**



**50065**

- W : 64" overall  
 H : 35" overall (31" worktop, 29" kneespace)  
 D : 36"
- splash guard worktop with 6" keyboard bump-out
  - cable tray & grommets
  - welded steel U-channel frame and casters

**Wide or Two Student Computer Module Stationary**

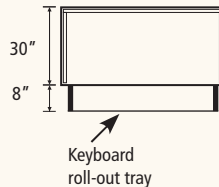

**50070**

- W : 64" overall  
 H : 38" overall (34" worktop, 29" kneespace)  
 D : 30" (38" with keyboard tray extended)
- splash guard worktop
  - keyboard tray pulls out with outboard keepers
  - cable tray & grommets

**Wide or Two Student Computer Module Mobile**



**50075**

- W : 64" overall  
 H : 38" overall (34" worktop, 29" kneespace)  
 D : 30" (38" with keyboard tray extended)
- splash guard worktop
  - keyboard tray pulls out with outboard keepers
  - cable tray & grommets
  - welded steel U-channel frame and casters



### Two Position Sit Down Computer Group



#### 30200

W: 66"

H : 32"

D : 30"

- ADA height
- knee space clear width is 31 .5"
- pre-drilled grommets and cable tray for cord management
- use alone as an island. or in a run of traditional science tables, or in runs of other computer modules
- surround splash protects against adjacent wet areas
- shown with power & data drop, by others

### Mobile Instructors Desk-Chemistry, ADA



#### 20045

W: 60"

H : 32"

D : 30"

- 1 - 12" wide, double sided storage cabinet with 5 locking drawers (2 lowest drawers have false bottom for optimum reach) and 2 pull-out boards
- 1 - 12" x 27" sink cabinet with fixtures, waste & water storage. Lock

#### Accessories:

- 1 epoxy cup sink (3" x 6") with poly outlet and disc strainer
- 1 cold water fixture with electric pump & 2 three-way switches
- 1 single gas cock, 1 single air cock with 10' supply hose
- 3 duplex AC receptacles, 1 is GFCI type for complete circuit protection
- 2 upright rods, 1 crossbar & 2 rod sockets
- 2 pull-out boards, laminate
- 2 - 2.5 gallon polyethylene tanks
- Refer to ADA Products section for complete selection of ADA instructor's desks

### Mobile Instructor's Desk



#### 50100

W: 60"

H : 32"

D : 30"

- 1 - 12" wide double-sided cabinet with 1 drawer each side, 1 pull-out board each side. and 1 door each side
- knees pace. 36" W x 29" H
- 1 - 12" wide double-sided cabinet with 1 drawer each side, 1 door each side
- laminate or epoxy resin top, specify
- casters, 2 locking

**Mobile Instructor's Desk-Biology**

**50105**
**W:** 60"

**H:** 32"

**D:** 30"

- 1 - 12" wide double-sided cabinet with 5 drawers (2 lowest drawers have false bottom for optimum reach), 2 pull-out boards, and 1 apron with duplex outlet
- kneespace 36" W x 29" H
- 1 - 12" wide sink cabinet with 2 doors, 2 duplex outlets (1 each side), 2 water pump switches (1 each side), and power inlet
- laminate or epoxy resin top, specify
- casters, 2 locking

**Accessories:**

- 1 epoxy resin cup sink (3" x 6") with poly outlet and disc strainer
- 1 cold water fixture with electric pump and 2 switches
- 1 single gas cock with 10' supply hose
- 1 single air cock with 10' supply hose
- 3 duplex outlets, 1 outlet is GFCI and protects all outlets
- 2 - 2.5 gallon polyethylene tanks for supply / waste

**BLM Extractor  
Series I ADA Design**



- 60045 - 48" hood with laminate chase**
- 60046 - 60" hood with laminate cabinets**
- 60047 - 72" hood with laminate cabinets**

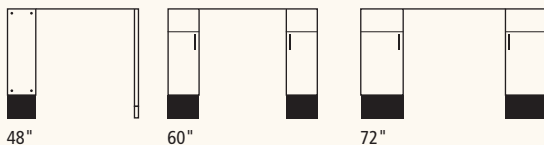

**Sizing**

W: (Hood)	48", 60", 72"
W: (Cabinet & Top)	48", 60", 72"
W: (Kneespace)	36"
H : (Hood)	57.25" + 7.5" raised sash
H : (with Cabinet)	92" + 7.5" raised sash
D : (Hood)	33.25"
D : (Cabinet)	22.5"

**Air Data**

Product No.	CFM at 100 LFM	Static pressure at Hood	Duct size
60045	833	.25 inches	10" dia
60046	1100	.34 inches	10" dia
60047	1367	.34 inches	10" dia

The ADA Design Airfoil conventional bypass hood is specially designed for the safety and comfort of disabled operators.

**Standard Design**

**Special Safety Features:** The ADA Design fume hood is constructed to accommodate a seated operator as well as allowing comfortable standing operation. All service controls and instructions are within easy reach and sight while seated and the standard sash is counter weighted for effortless control. The worktop, in addition to the standard marine edge, has a forward steel trough to provide secondary operator protection from spillage.

**Air Management:** Constant exhaust volume, drawing air efficiently through the sash when open or through the bypass chamber when sash is closed.

**Superstructure:** Outer wall is chemical resistant powder-coated sheet steel interior lining is U.L listed poly resin unless otherwise specified. Double wall construction provides a 5" chase area, for plumbing and electrical fixtures within walls.

**Airfoil:** Front openings is framed with a 45° angle fascia that substantially reduces the turbulence of air entering the hood. The bottom horizontal airfoil directs a current of air at countertop level to purge heavy fumes or spillage.

**Ratings:** U.L. 1805, ASHRAE 110-1995. Class B hood.

**Cabinets:** 8" toe base and cabinet bottom restrictor accommodate "low reach" minimums.

**Standard Features**

- chemical resistant powder coat exterior finish
- full frame construction
- vapor sealed fluorescent light fixture (bulbs included) accessed from inside the air chamber
- shaft drive sash allows easy lifting from anywhere along the sash
- sash stop
- combination horizontal / vertical sash
- louvered front panel for bypass
- air flow alarm
- U.L. listed poly resin liner
- flush-mount airfoil
- painted steel containment trough under airfoil
- 10" round stainless steel duct collar
- plastic laminate base cabinet(s) or chase

**Options**

- stainless steel sash
- stainless steel airfoil
- automatic sash return
- push button sash
- chain and sprocket sash drive
- electrical accessories
- plumbing fixtures
- ¼ turn ball valves
- epoxy tops
- alarms
- LED lighting
- ceiling enclosures
- lattice assembly
- chemical resistant exterior and/or interior plastic laminate base cabinet(s)
- powder coat steel base cabinet(s)
- stainless steel base cabinet(s)

See pages 20.18.0 - 20.20.0 for accessories.

- Mechanical & Electrical Fixtures Furnished Loose.
- No Piping, Conduit, Traps or Blowers Included.

(Prices subject to change without notice)

BL Material, 144 Allen Blvd Suite B, Farmingdale, NY 11735, 631-246-1780 Web Site: info@blmaterials.com