

# Health and safety in roof work



## Health and safety in roof work (Fifth Edition)

You can buy this book at <https://books.hse.gov.uk/>

This is a web version of the printed edition Health and safety in roof work (Fifth Edition).

Working on roofs is a hazardous activity because it involves working at height. Roof work accounts for a quarter of all deaths in the construction industry. Falls through fragile materials, such as roof lights and asbestos cement roofing sheets, account for more of these deaths than any other single cause. Not all the people killed while working on roofs are trained roofers: many people accessing roofs are maintenance workers. There are also many serious injuries, often resulting in permanent disabilities.

This fifth edition contains guidance on how to plan and work safely on roofs. It covers new buildings, repair, maintenance, cleaning work and demolition. It also includes some guidance for people not directly carrying out work on a roof, such as clients, designers and specifiers.

Roof work is an issue not just for construction companies. Other workers, such as building maintenance staff and surveyors, can also fall from or through roofs. This guidance will be useful to anyone planning, arranging or supervising roof work, including:

- directors and partners of companies who carry out roof work;
- clients of projects involving roof work;
- designers and specifiers of buildings and components;
- principal contractors for projects that include roof work;
- owners of buildings where roof work may take place;
- trade union safety representatives and employees' safety representatives;
- anyone carrying out roof work, including employees and the self-employed; and safety consultants and advisers.



a Williams Lea company

Published by TSO (The Stationery Office), part of Williams Lea,  
and available from:

**Online**

**[www.tsoshop.co.uk](http://www.tsoshop.co.uk)**

**Mail, Telephone, Fax & E-mail**

TSO

PO Box 29, Norwich, NR3 1GN

Telephone orders/General enquiries: 0333 202 5070

Fax orders: 0333 202 5080

E-mail: [customer.services@tso.co.uk](mailto:customer.services@tso.co.uk)

Textphone 0333 202 5077

**TSO@Blackwell and other Accredited Agents**

TSO@Blackwell and other Accredited Agents

Published with the permission of the Health and Safety Executive on behalf of the Controller of Her Majesty's Stationery Office

© Crown copyright 2020

First published 1987

Second edition 1998

Third edition 2008

Reprint with amendments 2010

Fourth edition 2012

Fifth edition 2020

This information is licensed under the Open Government Licence v3.0. To view this licence, visit  
<http://www.nationalarchives.gov.uk/doc/open-government-licence> The logo for the Open Government Licence (OGL), consisting of the letters 'OGL' in a bold, sans-serif font.

Any enquiries regarding this publication should be sent to: [copyright@hse.gov.uk](mailto:copyright@hse.gov.uk)

Some images and illustrations in this publication may not be owned by the Crown and cannot be reproduced without permission of the copyright owner. Where we have identified any third party copyright information you will need to obtain permission from the copyright holders concerned. Enquiries should be sent to [copyright@hse.gov.uk](mailto:copyright@hse.gov.uk)

Printed in the United Kingdom for The Stationery Office.

This guidance is issued by the Health and Safety Executive. Following the guidance is not compulsory, unless specifically stated, and you are free to take other action. But if you do follow the guidance you will normally be doing enough to comply with the law. Health and safety inspectors seek to secure compliance with the law and may refer to this guidance.

# CONTENTS

<b>Preface</b>	<b>5</b>
<b>Introduction</b>	<b>7</b>
Why is this guidance needed?	7
What is this publication about?	7
Who should read this publication?	8
Other useful information sources	8
The law	8
<b>Planning for safety</b>	<b>9</b>
Hierarchy for work at height	9
Training and competency	10
Risk assessments and method statements	10
Fragility	11
Safe access to the roof	12
Safe place of work on the roof	15
Weather conditions	18
Temporary roofs	20
Electricity at work	20
Escape in case of fire	22
Working near gas flues/extraction vents	23
<b>Types of work</b>	<b>24</b>
Inspection and survey	24
Refurbishment and re-roofing	25
Ancillary works	26
Maintenance and cleaning	26
Stripping and dismantling roofs	27
Short-duration work	29
<b>Types of roof</b>	<b>31</b>
Flat roofs	31
Demarcation of access routes and work areas	33
Slated and tiled (pitched) roofs	34
Fragile roofs and surfaces	40
Profiled sheeting	45
<b>Protecting the public</b>	<b>50</b>
<b>Dealing with health risks</b>	<b>52</b>
Manual handling	52
Harmful dusts and chemicals	54
Biological hazards	58
Welfare for all construction sites	58
Vibration, noise and sun exposure	59

<b>Training and competence for roof workers</b>	<b>61</b>
<b>Construction (Design and Management) Regulations 2015</b>	<b>63</b>
The role of the client	63
The role of the principal designer	64
The health and safety file	65
The role of the designer	65
The role of the principal contractor	71
The role of the contractor	71
<b>Appendix 1 Issues for method statements in roof work</b>	<b>72</b>
<b>Appendix 2 Use of safety nets</b>	<b>75</b>
<b>Appendix 3 Use of personal fall-protection systems</b>	<b>78</b>
<b>Appendix 4 Fragility: tests and specifications</b>	<b>83</b>
<b>Appendix 5 Demolition involving asbestos cement roof sheets</b>	<b>85</b>
<b>Appendix 6 Hot work</b>	<b>89</b>
<b>Appendix 7 Edge protection</b>	<b>92</b>
<b>References and further reading</b>	<b>93</b>
<b>Further information</b>	<b>96</b>

# PREFACE

Every year many construction site workers are killed or injured because of their work, and many others suffer ill health. The hazards are not, however, restricted to people working on sites. Children and other members of the public are also killed or injured because construction activities have not been adequately controlled.

The construction industry's performance has steadily improved, but the rates of death, serious injury and ill health are still the highest of all industries. These deaths, injuries and ill health cause pain and suffering. They also have a cost in terms of industrial injuries claims, medical treatment, and lost time at work. The aim of this publication is to help everyone involved in construction – specifically roof work activities (including activities often not considered as roof work, such as maintenance and surveying) – to identify the main causes of accidents and ill health and to explain how to identify the hazards and prevent or control the risks. The guidance is simple and will have general relevance to everyone in the construction process, but particularly to people directly involved in roof work. It will refer to other documents, some relevant to particular groups, depending on the subject they address.



# INTRODUCTION

## Why is this guidance needed?

- 1 Working on roofs can be hazardous because it involves work at height. Roof work accounts for a quarter of all deaths in the construction industry. Falls from an unprotected edge or through fragile materials, such as roof lights and asbestos cement roofing sheets, account for the majority of these deaths. There are also many serious injuries, often resulting in permanent disabilities.
- 2 Remember that not all people killed or injured while working on roofs are trained roofers – many people accessing roofs are in fact carrying out other tasks, such as maintenance and surveying.
- 3 These accidents occur across the whole range of roof work from the simplest repairs to large-scale construction projects. More than half of the fall-from-height deaths in the construction industry are roof-work-related. Falls from height are the biggest killer in construction (see Figure 1).

## What is this publication about?

- 4 This publication contains guidance on how to plan and work safely on roofs. It covers new buildings, repair, maintenance, cleaning work and demolition. It also includes guidance for people not directly carrying out the work on the roof, eg clients, surveyors, designers and specifiers.
- 5 The main risks that need to be addressed are falls through fragile roofing materials/assemblies and from unprotected roof edges. In most cases, straightforward physical protection measures can prevent accidents occurring. However, too often a lack of foresight and poor management control mean that protection is neglected during high-risk work, leading to accidents.

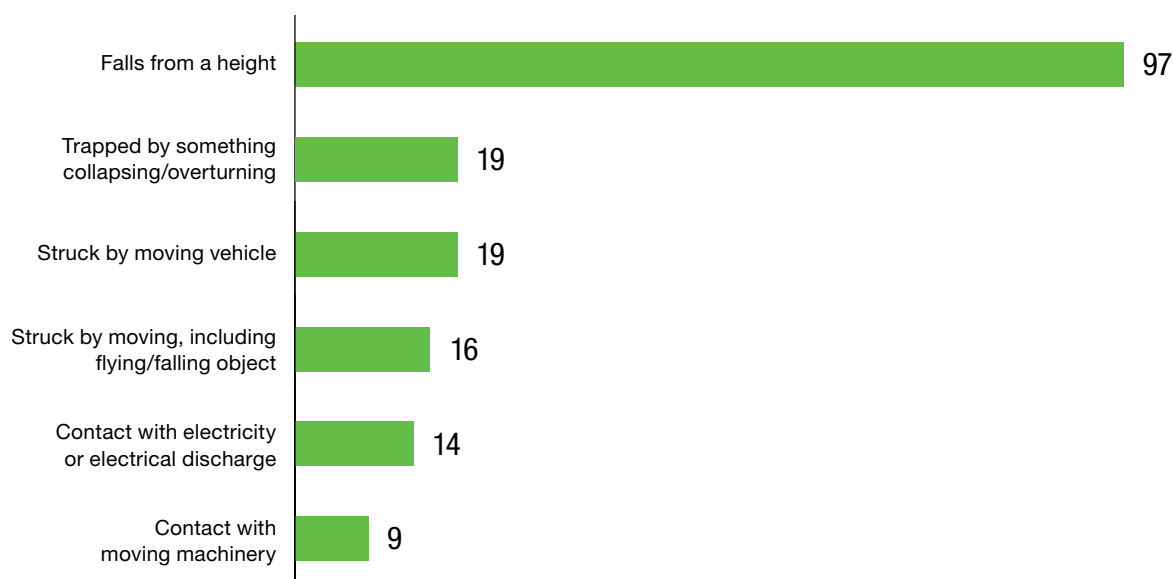

**Figure 1** Falls are the biggest killer in construction (Fatal accidents in construction – 2011–2016)

A roofer was part of a gang who were re-sheeting a large steel portal frame warehouse. Approximately 50% of the roof was netted underneath. The roofer was moving a sheet from a storage pile at the opposite end of the building when he fell through an uncovered fragile roof light in an area of the roof that was not protected by nets.

A 50-year-old maintenance worker was killed when he fell through a fragile roof light panel as he was checking roof repair work carried out by other contractors. The covers, which had been provided when the repair work was carried out, had been removed and the roof light panels were unprotected.

6 Not all the safeguards in this guidance will be relevant in all circumstances. Anyone who is planning the work should consider the extent and nature of the risks in the specific job and then plan a safe method of work from there. This guidance is structured to identify precautions that are applicable to all roof work. It also includes precautions that are particularly relevant to different types of roof and different types of work. However, risks are significant in all roof work and high standards of safety are necessary to provide adequate protection.

### Who should read this publication?

7 Roof work is an issue not just for construction companies. Other workers, such as building maintenance staff and surveyors, can fall from or through roofs. This guidance will be useful to anyone planning, arranging or supervising roof work or work on roofs including:

- directors and partners of companies who carry out roof work;
- clients of projects involving roof work;
- designers and specifiers of buildings and components;
- principal contractors for projects that include roof work;
- owners of buildings where roof work may take place;
- trade union safety representatives and employees' safety representatives;
- anyone carrying out roof work, including employees and the self-employed; and
- safety consultants and advisers.

### Other useful information sources

8 This publication does not repeat detailed guidance available about other topics or equipment common to construction work in general. However, the reference section gives a list of useful publications and indicates where you can find such advice.

### The law

9 There is a range of law relevant to roof work health and safety. The principal elements are:

- the Health and Safety at Work etc Act 1974;
- the Work at Height Regulations 2005;
- the Management of Health and Safety at Work Regulations 1999;
- the Construction (Design and Management) Regulations 2015;
- the Lifting Operations and Lifting Equipment Regulations 1998; and
- the Provision and Use of Work Equipment Regulations 1998.

10 The construction pages of the HSE website contain more information on these legal requirements: <http://www.hse.gov.uk/construction/index.htm>



# PLANNING FOR SAFETY

11 Planning is vital to ensure safety in any size of building or roof work project, from short-duration minor work, such as surveying or replacing a few tiles on a house, to the major refurbishment of an existing property. Planning by all parties involved helps to make sure the work is carried out safely, efficiently and without undue delay.

12 Where they apply, the Construction (Design and Management) Regulations 2015 (CDM)<sup>1</sup> identify the role of each party of a construction project and set out specific requirements to follow. For more information, see the chapter entitled 'Construction (Design and Management) Regulations 2015'.

13 However, not all roof work falls within the definition of construction work (eg gutter cleaning), and in this case CDM would not apply. It is therefore essential that the hazards associated with working at height are recognised and understood by the client or customer who commissions or arranges for the work to be carried out and the designer, where there is one. (Note that a designer may be a contractor who produces a specification or scheme of work and may not be from a professional design or architectural practice.)

14 The client or customer must make sure that the individual or company they have employed to carry out roof work is competent to do so and is aware of the hazards and precautions to be taken for the work to be carried out safely. (For more information see paragraphs 18–22 and 303–316.) They should also make sure that any materials selected will not create additional hazards for future maintenance, access or demolition of the property (see paragraphs 319–331).

15 Roof work usually involves work at height and it is important to prevent or minimise risk when planning this work. Falls account for 50% of deaths in the construction industry (and a quarter of all workplace deaths in Great Britain). As part of this planning process, you must follow the hierarchy set out in the Work at Height Regulations 2005 to make sure that risks are controlled so far as is reasonably practicable. In these Regulations there is no distinction between low and high falls, so for any work at height (where a fall is liable to cause personal injury), appropriate precautions are required to prevent or minimise that risk.

## Hierarchy for work at height

16 The Work at Height Regulations 2005 set out a hierarchy of measures which must be followed systematically;

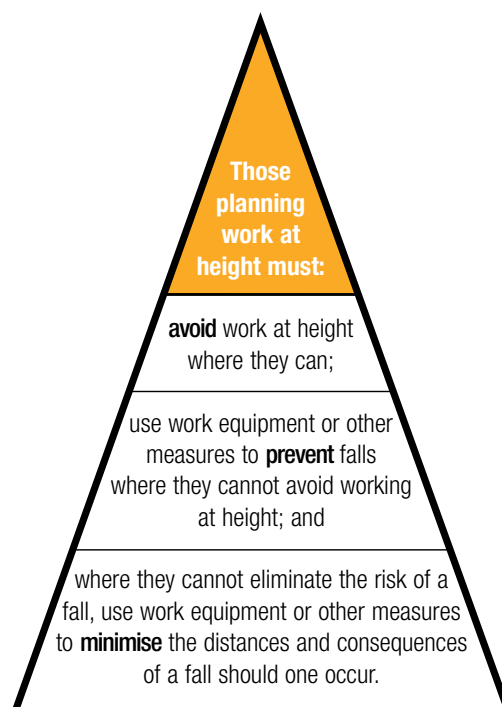

Figure 2 Hierarchy for work at height

only when one level is not reasonably practicable may the next level down be considered (see Figure 2). This hierarchy ranks risk control measures that place prevention before protection; those that place total workforce protection before individual protection; and those that place passive control (requiring no action by the operative) before active control (requiring action such as clipping on with lanyards).

17 People in control of planning the work must, in other words:

- always consider measures that protect everyone who is at risk (ie collective protection systems such as scaffolds, nets or soft landing systems) before measures that protect only the individual (ie personal protection measures such as a harnesses);
- always consider passive systems such as edge protection (where the individual does not have to do anything to activate the system) before active systems such as harnesses (which the worker has to clip on); and
- make sure work is carried out only when weather conditions do not put the health and safety of workers in danger.

See Table 1 for practical examples.

## **Training and competency**

18 As stated in paragraph 1, roof work is a hazardous activity, so it is essential that anyone wishing to have roof work carried out makes sure that the workers/contractors they choose to carry out the work are competent to do so.

19 A contractor should be able to demonstrate:

- sufficient knowledge of the particular type of roof work they are being asked to carry out and the risks it will entail; and
- current and sufficient experience of the latest techniques, standards and materials to enable them to carry the work out safely, including any relevant training or qualifications. This training should cover safe working practices and, if required, the selection, pre-use inspection and use of personal fall-protection equipment.

20 It is important that contractors have up-to-date knowledge, experience and training. Although experience is a major factor, if it is based on poor or inadequate initial training or out-of-date knowledge it can be worthless. People must understand the reasons why safe working practices are necessary.

21 It is also helpful to ask whether the contractor has adequate resources to be able to complete the job safely, such as providing suitable on-site supervision and labour.

22 Checking whether a contractor is a member of a reputable trade organisation that is relevant to the work activity is also useful as some provide guarantees, have a complaints procedure, and inspect the credentials of members and their work.

## **Risk assessments and method statements**

23 A competent person should carry out a risk assessment before work starts on a roof. It needs to be appropriate to the scale and complexity of the work. In all cases, the competent person should make sure that the hazards are identified, the degree of risk is determined and appropriate control measures are put in place.

24 A method statement is a useful way of recording the hazards involved in specific work-at-height tasks and communicating the risk and precautions required to everyone involved in the work. It should identify working positions and access routes to and on the roof, and show:

- how falls are to be prevented, or where this is not possible, minimised;
- how danger to people at work below, and to the public, from falling materials is to be controlled;
- how risks to health will be controlled;
- how other risks identified at planning and survey stages are to be controlled, eg handling hot bitumen;
- what equipment will be needed;
- what competence and/or training is needed;
- who will supervise the job on site;
- how changes in the work will be dealt with without affecting safe working; and
- who will check that the system is effectively controlling risk.

25 The method statement should be clear and illustrated by simple sketches or photos where necessary. There should be no ambiguities or generalisations that could lead to confusion. They should be produced for the benefit of people carrying out the work and their immediate supervisors and not be overcomplicated.

26 Equipment needed for safe working should be clearly identified and available before work starts. Workers should know what to do if the work method needs to be changed. This should then avoid 'ad hoc' methods of work on site and the use of improvised equipment, which can often lead to accidents. See Appendix 1 for further information.

## **Fragility**

27 All roofs should be treated as fragile until a competent person has confirmed they are not (see Appendix 4).

28 Falling through a fragile roof is one of the main causes of accidents during roof work, occurring in both the construction of new roofs and maintenance of old ones, so it is important to consider fragility when planning any roof work task. Although the installation of 'non-fragile' roofs, including roof lights, in new buildings is now commonplace, people who work on roofs should not be complacent. Eventually even these materials will become fragile due to a number of factors:

- the fixings were badly secured, leading to excessive wear around the fixing;
- the fixing washers have failed due to overtightening, leading to sheet and fixing corrosion;
- the protective surface of the profiled sheeting was damaged by foot traffic or careless destacking and laying during construction or during the roof maintenance phase, which will lead to an early breakdown of the sheet's performance;
- any slip or fall onto the roof may damage the assembly, which could lead to early corrosion failure;
- external atmospheric conditions (eg saline or factory processes) may lead to early failure of the sheet's performance;
- the sheets and fixings have reached the end of their design life; and
- poorly ventilated, cold flat roofs can cause a timber substrate to rot internally, rendering the surface fragile.

## Safe access to the roof

29 Where it has been determined that access to the roof is required, safe access to a work area requires careful planning, particularly where work progresses along the roof. Typical methods to access roofs are:

- general access scaffolds;
- stair towers;
- fixed or mobile scaffold towers;
- mobile access equipment;
- ladders; and
- roof access hatches.

### *General access scaffolds*

30 A general access scaffold can provide safe access to roof level and a working platform around the edge of the roof, as well as providing space to store materials. Often, a loading bay can be erected and can help with materials handling on the roof.

31 Access scaffolds, including loading bays, are some of the commonest types of 'temporary works' used on roofing projects. Temporary works are an engineered solution used to support or protect an existing structure or the permanent works during construction, or to provide access. The construction of most types of permanent works will require the use of some form of temporary works and the correct design and execution of these is an essential element of risk prevention and mitigation.

32 Unless a scaffold is assembled to a generally recognised standard configuration, such as BS EN 12811-4<sup>2</sup> or National Access Scaffolding Confederation's (NASC) Technical Guidance TG20:13<sup>3</sup> for tube and fitting scaffolds, or similar guidance from manufacturers of system scaffolds, it should be designed by a competent person, to make sure it will have adequate strength, rigidity and stability while it is erected, used and dismantled. For more information on which types of scaffold require a design see <http://www.hse.gov.uk/construction/safetytopics/scaffoldinginfo.htm>

33 Scaffold should:

- be designed, erected, altered and dismantled only by suitably qualified and experienced scaffolders and the work should be carried out under the direction of a competent supervisor;
- never be erected or dismantled over people or busy pavements. If the work presents a danger to the public you should apply for a road or pavement closure to eliminate the risk of a member of the public being injured. If this is not granted, erection and dismantling should be done inside a segregated area and during times when there are fewer members of the public in the vicinity;
- be based on a firm, level foundation. The ground or foundation should be capable of supporting the weight of the scaffold and any loads likely to be placed upon it. Be aware of any voids, such as basements or drains, and patches of soft, uneven ground, which could collapse when loaded. Provide extra support as necessary; and
- be braced and tied to a permanent structure or otherwise stabilised. Proprietary system scaffolds should be erected and tied in accordance with the manufacturer's instructions, which should be available from the supplier when the scaffold is hired or purchased.

34 On sites where people from more than one trade are working, the principal contractor and the roofing contractor should agree what is necessary and who will provide it. They should also agree who will carry out the necessary statutory inspections. Make sure that scaffolds are suitable and safe before your employees use them.

### ***Tower scaffolds and stair towers***

35 Tower scaffolds and stair towers can provide safe access if they are erected by a competent person and used correctly. However, inappropriate erection and misuse of tower scaffolds causes a number of accidents each year. Aluminium towers are light and can easily overturn if used incorrectly. Towers rely on all parts being in place to ensure adequate strength – they can collapse if sections are left out. Lightweight tower scaffolds may need to be tied to the building or held down using additional weight (kentledge) to prevent overturn, especially in strong winds.

36 The manufacturer or supplier has a duty to provide an instruction manual that explains the erection sequence, including any bracing requirements, and the height to which the tower can be erected safely. If the tower has been hired, the hirer has a duty to provide this information to their customer, who in turn must pass the information on to the workers erecting the tower.

37 Workers who erect towers should be trained and competent people who are following a safe method of work. There are two approved methods recommended by the Prefabricated Access Suppliers' and Manufacturers' Association (PASMA), which have been developed in co-operation with HSE: the 'advanced guard rail' and 'through the trap' (3T) systems. For further information on tower scaffolds see <http://www.hse.gov.uk/construction/safetytopics/scaffold.htm>

38 Stair towers are preferable to tower scaffolds or ladders as they allow materials such as small components or tools to be safely carried onto the roof (see Figure 3).

A roofer, aged 24, was killed when he fell from the edge of an industrial roof. He was doing re-sheeting work and a tower scaffold was provided for access to the roof level. Even with the outriggers in use, the tower was inadequately tied and so was unstable. The guard rails were also poorly fitted.

### ***Mobile access equipment***

39 A wide range of mobile access equipment is available, most of which comes under the umbrella term of mobile elevating work platform (MEWP). There are three basic types:

- scissor lift (gives a vertical lift only);
- telescopic boom (gives vertical lift and outreach and is generally known as a 'cherry picker'); and
- articulating and telescopic boom (often vehicle-mounted).

40 MEWPs are specifically designed to lift people to a position where they can carry out work from the work platform and then return to the starting level. Exiting the basket at height should be strictly controlled; it may only be undertaken where a rigorous risk assessment has been carried out as part of planning the job and indicates that this is the safest and most effective means of accessing a particular location.

41 For short-duration work, such as inspection and minor maintenance, MEWPs can provide safe access to the roof without having to leave the MEWP. Risks associated with scaffold erection can often be avoided if mobile access equipment is used rather than scaffolding. However, the equipment chosen should be appropriate for the ground conditions on the site. Follow the manufacturer's advice on the maximum wind speed at which the MEWP can be safely operated.

42 Equipment should be maintained in a safe condition and be operated only by trained and competent workers. See *The selection, management and use of mobile elevating work platforms* (GEIS6).<sup>4</sup>

### **Ladders**

43 Nearly a third of all reported fall-from-height fatal incidents in the construction industry involve ladders and stepladders. This is because, while ladders may provide safe access in some circumstances and despite being one of the most commonly used pieces of access equipment in the construction industry, they are often misused or inappropriate for the task.

44 Ask yourself:

- Is a ladder the best piece of access equipment to use in the first place?
- Is there a safer means that is further up the work-at-height hierarchy?
- What activity are you carrying out and how long might someone be working on the ladder?
- What length of ladder is required?
- Are workers expected to carry materials and tools or work on the ladder?
- Can the person using the ladder maintain three points of contact while on the ladder?

45 Where ladders are used, they need to be of the right type, ie a suitable grade of professional ladder or BS EN 131.<sup>5</sup> They should be in good condition and effectively secured to prevent movement. They should also extend over the working platform level by at least 1 m to provide a safe handhold at the stepping-off area. Inspect ladders regularly to make sure they have no visible defects, and where defects are found, take the ladder out of use.

A 48-year-old roofer was killed when he fell from an untied ladder as he attempted to carry bundles of tiles up it. The ladder was too short for the work in question and was being moved progressively along a wall while the work took place.

46 For more information and guidance on using ladders safely see the webpages on the HSE website: <http://www.hse.gov.uk/construction/safetytopics/ladders.htm>



**Figure 3** Stair towers provide good access. Make sure they are properly secured and erected (image courtesy of Turner Access)

## Safe place of work on the roof

47 A safe place of work, including safe access, should be provided for all roof work. There is a clear hierarchy for all work at height (see Figure 2 and Table 1); it helps guide people planning the work to provide the safest possible work area.

### Emergency rescue procedures

48 Under the Work at Height Regulations 2005 you must consider emergency procedures for circumstances such as stuck access equipment and deployed fall arrest, so that people can be rescued. There must be a plan in place that outlines how someone would be recovered if they fall.

49 The method of rescue needs to be proportionate to the risk and you should not rely on the emergency services. The method of rescue may be simple, such as putting a ladder up to a net and allowing the fallen person to descend, or lowering a worker hanging on a deployed lanyard onto the surface below. Once the rescue has been completed, standard first-aid procedures are recommended, including use of the recovery position where necessary: see [www.hse.gov.uk/firstaid/index.htm](http://www.hse.gov.uk/firstaid/index.htm)

50 A casualty who is experiencing symptoms such as light-headedness, nausea, sensations of flushing, tingling or numbness of the arms or legs, anxiety, visual disturbance or faintness, or who is unconscious while suspended in a harness should be rescued as soon as is safely possible. Elevation of the legs by the casualty or rescuer (where safely possible) may enable them to tolerate suspension for longer.

51 Call an emergency 999 ambulance or equivalent qualified paramedical or medical provider for anyone who becomes unconscious in harness or rope suspension, whether apparently recovered or

**Table 1** Practical examples of solutions using the hierarchy for work at height

The hierarchy	Example solutions
Avoid the need to work at height	Use a telescopic pole with a camera attachment to conduct roof inspections. There may also be applications or online tools that might help, or commercially operated drones fitted with cameras (provided Civil Aviation legislation is complied with)
	Off-site construction (eg prefabrication of roof sections) may remove/reduce the need for work at height or make it easier to control
<b>Where work at height cannot be avoided</b>	
Prevent a fall	A non-fragile roof with a 1 m high parapet all the way round provides an existing safe place of work
	Provide edge protection (such as a boarded scaffold with guard rails/safety netting) and suitable safe access onto the roof (eg a stair tower)
	Examples of edge protection include full scaffold, net barrier systems and proprietary solutions
	Mobile elevating work platforms (MEWPs) can provide a safe working platform. When working in boom lifts use a work-restraint system (eg harness with a short lanyard) which make it impossible for the operative to get to a position where they could fall
<b>Where the risk of a fall cannot be eliminated</b>	
Minimise the consequences of a fall, should one occur	Use safety nets to protect everyone working in the area
	Use beanbags or inflatable airbag systems, installed close under the work surface
	Personal fall-arrest systems are the last resort as they do not prevent the fall, only mitigate the consequences, and only protect the individual worker
	Provide additional measures, such as training, instruction and supervision, to prevent falls liable to cause personal injury

not. Removal to hospital is deemed unnecessary if there is no loss of consciousness and no apparent or suspected injury and the subject is without other symptoms; ie they have had a short fall for a short period of time in suspension and have either rescued themselves or been lowered from suspension.

52 In some situations, you may need to consider using other work equipment, such as MEWPs, personnel-riding baskets for cranes or proprietary rescue systems. Whatever system or method you decide on, include this information in the construction phase plan (where CDM applies) or in the method statement for the work. You should use the method statement to brief people who will be working at height and involved in a rescue plan.

53 The rescue plan should include:

- details of the rescue equipment to be used;
- configuration of the equipment for different types of rescue;
- identification of anchor points where necessary;
- limitations of the plan for adverse weather such as high winds; and
- the need for trained, competent rescue personnel.

### ***Materials handling***

A roofer working with his teenage son died when he fell from a tied access ladder. He was carrying rolls of roofing membrane up the ladder when one caught on the eaves and caused him to lose his balance and fall.

54 Well-planned materials handling has a significant impact on roof work safety; for example, it can:

- minimise the amount of time spent working at height;
- reduce the amount of travelling around the roof to collect materials;



**Figure 4(a)** Industrial hoist (images courtesy of HSS)



**Figure 4(b)** Domestic hoist



- reduce injuries caused by handling heavy and unwieldy components (eg large roof sheets or roof trusses)
- increase productivity; and
- reduce waste.

55 On smaller roofing jobs, small lifting appliances may be used (such as a gin wheel, gantry hoist or scaffold hoist). They are usually mounted near the edge of a roof so it is important to install suitable edge protection (such as guard rails and toe boards, or proprietary or netted solutions) to prevent the workers using the appliance from falling. See Figures 4(a) and (b).

56 Lifting appliances need a secure anchorage and you should allow for the force exerted by the person who is raising the load (see Figure 5).

57 Where practicable, edge protection should remain in position when raising or lowering material. Anyone who needs to be near the edge, eg for signalling or to help move the load, should wear a safety harness in work-restraint mode and attached to a suitable anchorage point (see Appendix 3). The harness should allow them only to reach the edge to pull the materials in and no further, so they are never in a position from which they could fall.

58 Every lifting appliance should be properly installed, maintained, inspected and, at all times, operated within its safe working load. All lifting appliances need a thorough examination. Please refer to *Lifting equipment at work: A brief guide* INDG290 (see Further reading).

59 Access to the area below a lifting point should be controlled when the lifting equipment is in use, eg by temporary fencing.

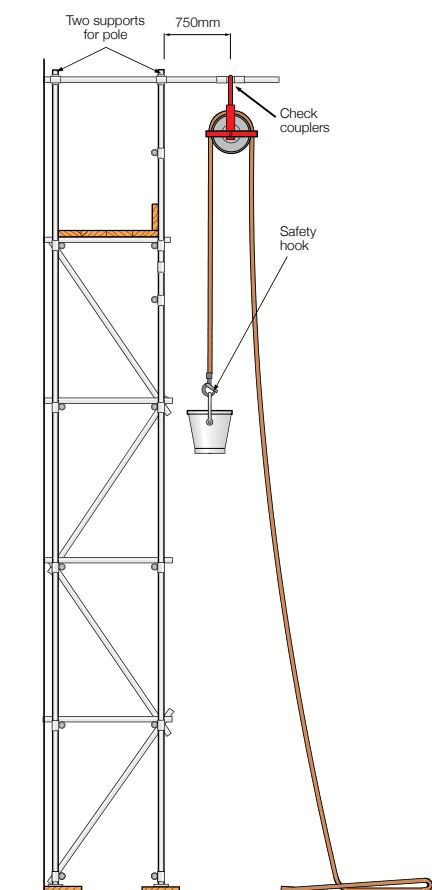

**Figure 5** Properly erected gin wheel (ties not shown)

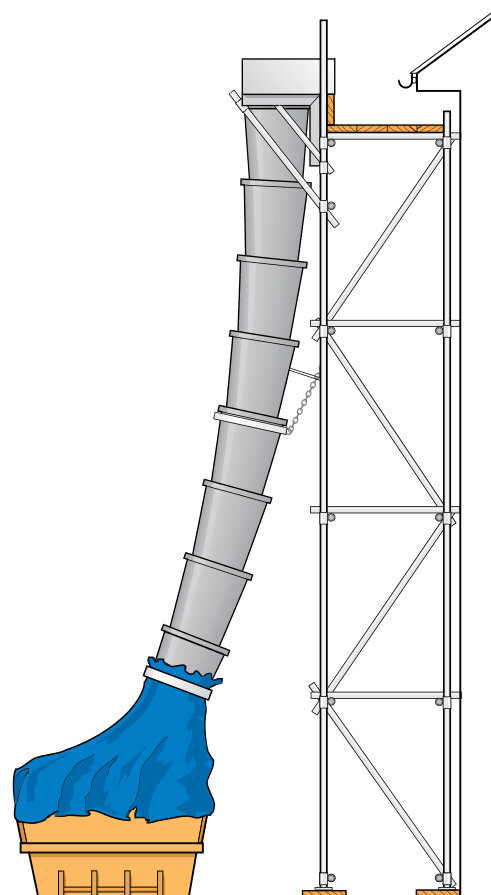

**Figure 6** Waste chutes make waste handling easier and safer



**Figure 7** Debris netting used in addition to safety netting may enable work to be carried out safely below roof workers (Image courtesy of Highersafe (North East) Ltd)

60 Ladders are usually not suitable for work that requires handling of heavy and/or awkward materials. When using ladders maintain three points of contact (small hand tools can be carried using a tool belt).

### ***Falling materials***

61 The public, as well as other workers, can be at risk when materials fall from roofs. These materials include roof sheets, fixings, tools, roof tiles, membranes, roofing felt and hot bitumen. At the planning stage of any job, consider what measures are needed to protect the public and other workers. More information is given in paragraphs 230–239; many of the measures described here will also be required to protect people at work. There are many measures you can use, such as debris nets, properly designed scaffold fans, covered walkways and proprietary or netted systems.

62 The safest option for removing waste materials from a roof is to use a rubble chute. See Figure 6.

A member of the public was seriously injured when hit by tiles thrown from a roof while it was being stripped. The use of a waste chute would have prevented the accident.

63 Control access by other trades when roof workers are working overhead as there is risk of falling materials. You should consider this when programming overlapping work. Where work is carried out below roof workers, effective measures will be required to prevent injury, such as a birdcage scaffold or suitable debris netting (see Figure 7).

A client (a major supermarket chain) identified and provided additional resources for the installation of safety nets and debris netting during the roofing phase of a new superstore. This allowed the roof workers to work quickly and safely within the protection of the nets. The addition of debris netting also allowed work to be carried out below them as the risk from falling materials was controlled. As a result, delays were minimised and savings were made on labour costs.

### **Weather conditions**

64 You should anticipate adverse weather conditions and take suitable precautions. The Work at Height Regulations 2005 specifically require that you consider weather conditions when planning any work at height. Rain, ice or snow can make a secure footing as slippery as a skating rink. A roof should always be inspected before work starts to see if conditions have changed and to check whether it is safe to work.

65 A sudden gust of wind can lead to loss of balance. Do not fix roof sheets and, in some circumstances, roofing membrane in windy weather: people can easily be thrown off balance while carrying a sheet up to or on the roof, particularly when handling large sheeting materials during work on industrial buildings.

66 It is not only in industrial roofing that you must take care in windy conditions. A slater or tiler cannot work safely in high winds as a roll of roofing membrane can become mobile if it is caught by the wind. On flat roofs, materials such as reinforced bitumen membranes, single-ply, spray-on adhesives, solvents and liquid roofing systems are equally affected. The effect of high wind upon hot bitumen when it is being poured can be extremely dangerous.

67 When deciding whether to begin, continue or suspend work, consider:

- wind speed (a competent contractor should use a hand-held anemometer to measure wind speed at the place of work);
- the measures already taken to prevent falls from the roof and whether these may be affected by the wind; and
- the position and height of the roof and the size of the material being handled.

68 Inspect sites at the end of the working day to make sure that loose materials, especially sheets, offcuts and fixings, are not left unsecured on the roof.

69 A standard method for relating wind speed to observed conditions at sea or on land is the Beaufort wind force scale. The National Federation of Roofing Contractors (NFRC) uses the descriptors in this scale to relate mean wind speeds to roofing operations (see Table 2).

**Table 2** Beaufort wind force scale as related to roofing operations

Description	Mph (min max)	Knots (min max)	M/sec (min max)
<b>Force 0 – Calm</b> Calm; smoke rises vertically	0–1	0–1	–
<b>Force 1 – Light air</b> Direction of wind shown by smoke drift, but not by wind vanes	1–3 Mean 2	1–3 Mean 2	0.5–1.8 Mean 1.1
<b>Force 2 – Light breeze</b> Wind felt on face; leaves rustle; ordinary vanes moved by wind	4–7 Mean 5.5	4–6 Mean 5	1.9–3.3 Mean 2.6
<b>Force 3 – Gentle breeze</b> Leaves and small twigs in constant motion; wind extends light flag	8–12 Mean 10	7–10 Mean 8.5	3.4–5.4 Mean 4.4
<b>Force 4 – Moderate breeze</b> Raises dust and loose paper; small branches are moved. Special care should be taken handling/fixing materials over 5 m long – approaching critical limit. <b>Care should be taken when handling lightweight insulation materials</b>	13–18 Mean 15.5	11–16 Mean 13.5	5.5–7.9 Mean 6.7
<b>Force 5 – Fresh breeze</b> Small trees in leaf begin to sway; crested wavelets form on inland waters. Special care should be taken in roof and vertical work. <b>Mean wind speed is approaching critical limit when all work must cease</b>	19–24 Mean 21.5	17–21 Mean 19	8–11 Mean 9.5
<b>Force 6 – Strong breeze</b> Large branches in motion; whistling heard in telegraph wires; umbrellas used with difficulty. <b>No fixing work anywhere should be in progress</b>	25–31 Mean 28	22–27 Mean 24.5	11.1–14.1 Mean 12.6

Reproduced by kind permission of NFRC

70 The NFRC's guide *Roofing and cladding in windy conditions*<sup>6</sup> provides more detail on how to assess the effects of high wind when working at height and includes guidance tables for sheeting and decking, slating and tiling, membrane roofing etc.

## Temporary roofs

71 In some situations, especially where a building remains occupied during roof repair or replacement, it is necessary to provide a temporary roof to protect the building. This can have the additional benefit of providing a working environment that is sheltered from the worst of the weather.

72 A variety of temporary roofing systems are available. Some integrated system roof scaffolds come with a set of pre-designed arrangements that need no further design work – so long as the manufacturer's requirements are fully complied with. All other temporary roof arrangements require a bespoke engineering design to be prepared and agreed before erection commences. This includes all temporary roofs built from tube and fitting components.

73 Note that the whole scaffold, from ground level up, must be included in the bespoke design, not just the temporary roof beams structure and cladding. Such a design will be more heavily constructed than a normal access scaffold. This is because temporary roofs experience far higher wind loadings than access scaffolds. Uplift can be a serious issue; both sheeted and open-frame scaffolds are vulnerable to being lifted by the wind and shaken apart. They may need reduced bay sizes and far more bracing and ties. The NASC publication TG9:18 *Guide to the design and construction of temporary roofs and buildings*<sup>7</sup> provides advice on designing temporary scaffold roofs.

74 As with all scaffolds, each open edge from which a worker could fall must be progressively built with edge protection. This includes all eaves and gable areas below the roof where access is needed to install the roof, and also the edges of the roof if workers (including scaffolders) will go onto the roof to erect, inspect or maintain it.

## Electricity at work

75 Accidental contact with and arcing from overhead electric power lines causes death and injury. Any work near overhead electric power lines or railway power lines must be planned to avoid danger. Avoid working underneath or near to overhead electric power lines.

76 Designers should consider changing the footprint of the building or relocating power lines to eliminate the risk of contact during construction and future maintenance. The electricity companies, known as distribution network operators (DNOs), own the majority of overhead power lines. Contact them for advice (and to tell them about the proposed work activity) as soon as it becomes clear that their power lines may be affected by the proposed work. Only they can relocate power lines.

77 Designers should take into account the length of metal roof sheets and other long conducting objects (metal finishing strips, scaffold tubes, ladders etc) likely to be manoeuvred near to power lines. They should also consider where these materials/equipment can be unloaded and stored safely in relation to the position of any power lines.

78 Where the risks from overhead power lines cannot be eliminated by design, principal contractors must manage the risks during the work. Risk assessments must be completed and precautions identified and implemented. The DNO that owns the equipment will provide guidance if asked. A risk assessment may identify that a power line must be switched off to allow some activities to take place safely. It may be necessary for a DNO to sheath conductors as an additional protective measure. You will need to pre-plan the work to enable the DNO to make provision for such arrangements. Often, requests are received for advice when the job is already in progress and the DNO is accused of being unhelpful because they cannot switch off lines or re-route them at short notice.

Two workers were electrocuted while carrying out external maintenance works to soffits and bargeboards. The rear of the property was inaccessible so they tried to gain access from an adjacent field. While they were attempting to place a two-stage aluminium ladder over the boundary the ladder came into contact with an 11 kV overhead line.

A roof worker was electrocuted when moving an aluminium ladder that contacted an 11 kV power line. He was repairing storm damage to the roof. The power lines ran parallel to the eaves less than 2 m away.

79 Clients and owners should make roofers aware of overhead power lines before any roof work starts. Only allow work to start once control measures have been agreed and implemented (the actions to take are the same as those for principal contractors; see paragraph 78).

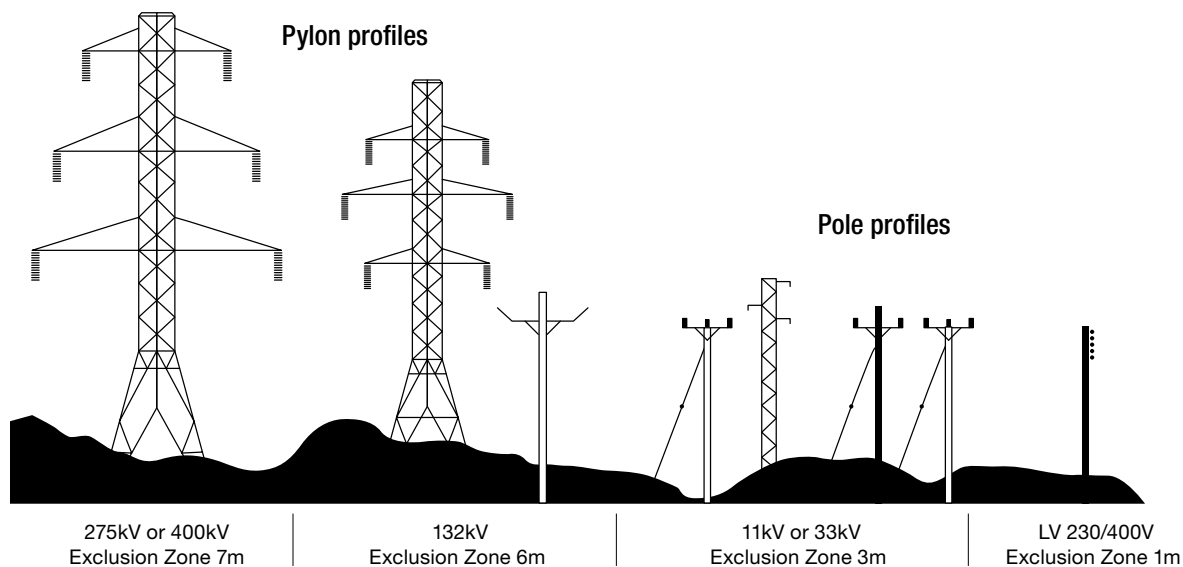

**Figure 8(a)** Minimum exclusion zone distance  
Western Power Distribution (WPD)

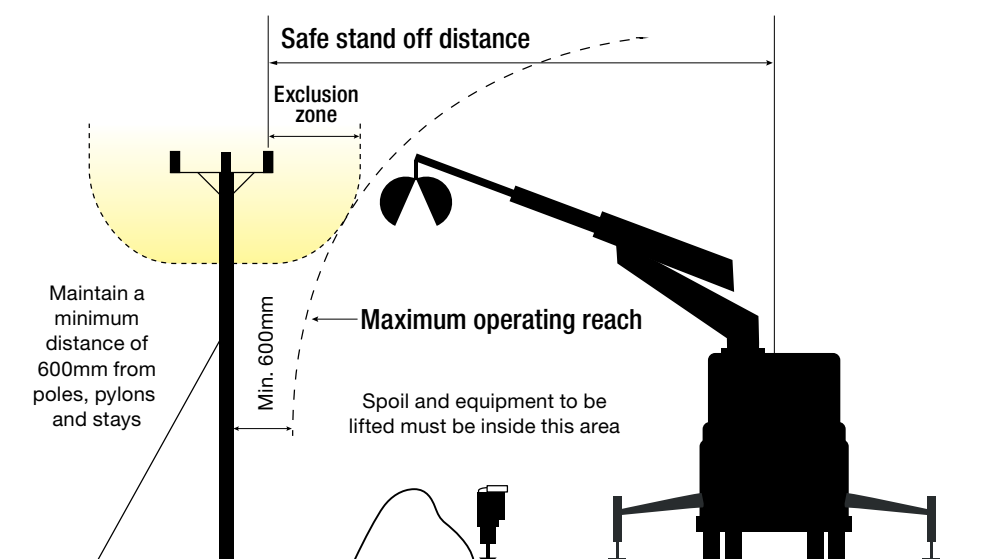

**Figure 8(b)** Exclusion zone (shown in yellow)  
Western Power Distribution (WPD)

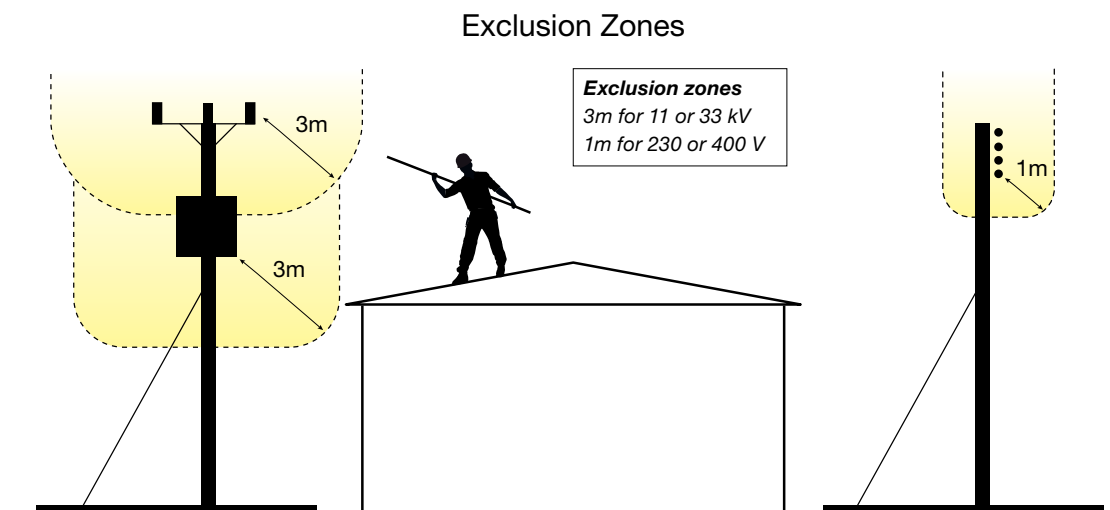

**Figure 9** Safe roof work needs to include consideration of exclusion zone size (this depends on the line voltage).

80 You must carry out a risk assessment where work is to be completed near overhead power lines and implement the precautions identified. If it is possible to maintain a distance of at least 15 m from steel towers and 9 m from wooden poles (measured at ground level horizontally from below the nearest wire) it is likely that you will need no additional precautions other than controlling access (but always follow precautions identified by the DNO). Where people, plant, equipment or materials need to approach more closely, the precautions implemented must make sure that the people can work safely.

81 Guidance on appropriate precautions to take can be found in the HSE publication *GS6 Avoiding danger from overhead power lines*<sup>8</sup> and the Energy Networks Association publication *Look out – look up!*<sup>9</sup> A DNO will provide guidance if asked. One way of establishing a safe system of work is to identify a stand-off distance; this is the closest approach that is safe for the work taking place. This is shown in Figures 8(a) and (b). What that distance is depends on the overhead line voltage (which determines the exclusion zone distance) and the maximum reach or length of equipment and materials. Added together, these give a safe stand-off distance. You need to take into account the size of the exclusion zone when planning roof work (see Figure 9). It is important to put control measures in place to maintain safe stand-off distances. As well as staying away from the lines or equipment, you should also stay at least 600 mm away from any part of poles, pylons and stay wires. If you are in any doubt about whether you can maintain the clearances described in *GS6* and *Look out – look up!* then you should contact your local DNO by dialing 105.

82 It is also important to remember that use of portable electrical tools can create hazards. For example, metal roof sheet edges can damage cable insulation. All electrical supplies to portable tools should be obtained from properly constructed and installed plugs and sockets of the industrial type. Where possible, use battery-operated tools. If this is not practicable use a reduced low-voltage system; this is sometimes referred to as 110-volt centre tapped to earth (CTE) system. All electrical equipment should be properly installed and maintained (see BS 7375).<sup>10</sup>

### Escape in case of fire

83 You should consider how to escape from the roof in case of fire. A fire could result from:

- construction work on a roof (eg welding or hot work using bitumen); or
- activities inside a building, including those under refurbishment.

84 In either case, the means of escape from the roof must be adequate, agreed and communicated before work begins. How complex this needs to be depends on the risk of being

trapped if there is a fire. It could mean, for example, making sure that mobile access equipment is always available in case of an emergency, or providing additional stair towers or (tied) ladders.

85 *Fire safety in construction* HSG168<sup>11</sup> provides further advice about managing fire safety in construction.

## Working near gas flues/extraction vents

A roofing contractor removed a chimney stack, leaving a gas appliance in a dangerous state. He was sentenced to prison, suspended for 24 months, in addition to paying a £5,000 fine and costs of £3,000.

86 If you are working near a gas flue or extraction vent you should establish what gases, fumes or vapours the system discharges and assess what controls are needed. Anyone undertaking building/roof work around a flue must make sure their work does not affect the flue or gas appliance in any way.

87 You should ensure that gas flues:

- do not become dislodged (eg during scaffold erection and dismantling);
- do not become blocked with material or covered over; and
- are sealed properly if extended.

Report any accidental damage immediately to the client.

# TYPES OF WORK

88 There are many reasons why someone may need to work on a roof, ranging from minor inspection to major re-roofing works. There are also many other reasons for accessing roofs, such as servicing or maintaining plant, installing or adjusting aerials or cleaning gutters. As a result, there are various safeguards to consider, depending on the type of work planned.

89 Remember that all roof work is potentially dangerous, however short-lived.

## Inspection and survey

90 If inspectors and surveyors cannot avoid going onto a roof, they will be exposed to serious hazards, so high safety standards will be required.

91 Inspection is often necessary where a problem (eg a leak) has been identified or before refurbishment. It should always be done with care and by people trained and experienced in assessing the risks involved. Initially, in accordance with the hierarchy, avoid work at height where possible – eg by remote inspection using drones (where permitted), mast photography or videography where only visual inspection is required. The operator remains at ground level and controls the direction and zoom of the camera. The pictures are then fed live to a screen where they can be viewed immediately. When using such systems, operators should take care to avoid overhead hazards such as electrical cables (see Figure 10).

92 Where you cannot avoid work at height, access to the roof should be planned and any risks associated with the work should be risk assessed and mitigated. If possible, carry out the work out from a safe place. This could be from an adjacent structure using binoculars, from mobile access equipment (see Figure 11) or from a secured tower scaffold or ladder. Some investigations can be carried out from below if the roof structure is exposed.



**Figure 10** Remote inspection mast with hand-held lightweight CCTV system (image courtesy of Survey Support Ltd)





**Figure 11** Powered access for inspecting a large fragile roof

93 Many modern roofs have fall-protection systems installed to allow gutter cleaning, maintenance and inspection. If they have been maintained and inspected properly by the client they should be used by people accessing the roof. However, people should be trained and competent to use the system before they are allowed on the roof.

A self-employed surveyor fell from a surveyor's sectional ladder as he was measuring a dormer window at roof level. It is thought that he overreached and the top section of the ladder (which had not been fixed at the bottom) moved, causing him to fall with the ladder from the roof.

A managing director, aged 54, was killed when he fell through a fragile roof light panel as he was inspecting some repair work that had been completed on his premises roof.

## Refurbishment and re-roofing

94 Roof refurbishment can be complex, is always high-hazard and demands careful planning – a high proportion of accidents occur where this work is being carried out:

- On any refurbishment or re-roofing job, all surfaces should be treated as fragile unless a competent person has confirmed otherwise (see Appendix 4).
- The precautions to prevent people falling through fragile parts of the roof should be clearly identified. They do not have to be complex but they must be effective. The Work at Height Regulations 2005 require that no person at work should pass across or near or work on, from or near a fragile surface where it is reasonably practicable to carry out the work safely without them doing so.
- Where practical, replace roof lights from below, using a proprietary replacement and fixing system or work from above by remaining in a MEWP cage.

95 To prevent accidents occurring:

- close liaison with the client will be necessary where premises remain occupied during refurbishment;
- a structural survey may be required to confirm the strength or stability of roof members; and
- a risk assessment should be carried out when deciding whether to refurbish or replace fragile roof coverings. For example, the decision on whether to clean and seal or replace an existing asbestos fibre cement roof should take into account the additional risks from work at height,

exposure to asbestos fibres and cost of future maintenance (see paragraph 260). Where you are planning cleaning, consider whether it is necessary – is it being carried out only for aesthetic reasons? If it is required, you must use a safe system (see paragraphs 187–202).

## Ancillary works

96 There are many ancillary tasks carried out on roofs other than roof work; in particular, fitting or adjusting television aerials or solar panels to buildings. Anyone carrying out these tasks should have received relevant training for working at height on roofs to ensure their safety. The work that is being undertaken may have relevant industry guidance e.g. *Guidelines: Health & safety in the signal reception and network industries*.<sup>12</sup>

97 Many roofs have plant such as air conditioning, heating systems on them that requires access by maintenance workers. Where regular access is required, you should provide permanent safe access routes and a safe working platform. If access is required only on an irregular or occasional basis, a suitable and sufficient risk assessment should inform the safe system of work.

## Maintenance and cleaning

98 Many accidents occur during maintenance and cleaning of roofs. Often little attention is paid to this short-term, low-value work. It is often done by people with no experience in work at height and on older roofs where additional control measures may be needed to make sure the risk of incident is sufficiently low.

**A casual worker, aged 23, was killed when he fell through a fragile roof light on an asbestos roof. He was power-washing the roof of a farm building and stepped off one of the boards he was using as a work area onto the fragile roof light.**

99 A high proportion of deaths are caused by falls through fragile materials, as in the example above. Any work on fragile roofs, however trivial it may seem, should be carefully assessed, planned and supervised.

100 People on roofs should be competent to carry out the work. Inexperienced workers will need formal training on health and safety, specifically regarding the hazards associated with roofing (eg fragile roofs or materials, including roof lights, weather conditions, and personal protective equipment (PPE) they are required to use) before they go onto a roof. Make sure they always work in an area where the supervisor can see them and speak to them.

101 Never allow inexperienced people to work on roofs unsupervised (see paragraphs 303–316 for more information).

102 Factors to take into account when assessing the risk include:

- roof lights that may have been obscured by paint, debris or vegetation or have weathered to a colour and texture that matches the rest of the roof;
- any repairs carried out in the past, especially if fragile roof sheets have been used for 'patching' an otherwise non-fragile roof. Such practices are highly dangerous;
- metal roof sheets that may have deteriorated with age and become fragile;
- wood wool slabs that may have been weakened by water damage;
- safety systems that have been installed have been inspected and are ready for use; and
- most roofing structures that are designed to be non-fragile will become fragile with time. Corrosion of fixings, sealants, washers sheet laps and the understructure will lead to general decay and become fragile.

For more information on fragile roofs see paragraphs 170–202.

103 A full survey, together with local knowledge, will help to identify such problems. In case of doubt, treat the roof as fragile. Follow the precautions described for working on or near fragile materials rigorously whatever the size of the job.

### Roof cleaning

104 A typical example of cleaning on a roof is cleaning valley gutters on an asbestos cement roof or a roof containing fragile roof lights. For information on control of asbestos when cleaning asbestos cement roofs see the guidance in the HSE publication *Cleaning weathered asbestos cement (AC) roofing and cladding*.<sup>13</sup>

105 There are systems available that provide long-term protection for these regular operations, and you should consider them for existing roofs (see Figure 29). The alternative is to provide extensive temporary protection for each operation. This can be less cost-effective and requires rigorous supervision. Figures 12 and 13 show safe ways to both inspect and carry out some cleaning activities on fragile roofs.

A foreman was cleaning cement dust, which had spilled from a silo vent, when he fell 3.5 m through an asbestos cement roof. He was walking down the valley gutter, which was 300 mm wide. No protection had been provided for fragile material and no other precautions were taken to prevent falls. He died from head injuries.

### Stripping and dismantling roofs

106 The stripping of roofs to reclaim various roofing materials during demolition has often involved unsafe working practices. Provide a suitable scaffold at eaves level to all elevations; this gives safe access to the roof and room for storage of materials. Inform the scaffolding contractor of the intended loading and take care not to exceed this. You may need to give specific guidance to site supervisors on the maximum number of tiles or slates per scaffold bay.

107 Timber battens deteriorate with age. Do not use them as footholds unless they have been inspected by a competent person who has confirmed that they are strong enough. If in doubt, regard them as fragile.



**Figure 12** Valley walker used during gutter cleaning. This provides a protective mesh covering to either side of the operative, which moves progressively along the roof as the worker moves forward. The protective covering eliminates the risk of a fall through the fragile material (image courtesy of Safesite Limited)



**Figure 13** Access system for short-term maintenance work on a fragile roof

108 Never use timber battens as anchorage points for harnesses.

109 The removal of roof coverings may introduce instability of the roof structure. Seek an engineer's advice to outline the stability measures required. As the roof is stripped, you must take steps to prevent internal falls, for example, through the roof joists. There are various options available including:

- boarding out or using proprietary covers for the roof joists to provide a suitable working platform (see Figure 14(a));
- erecting a birdcage scaffold underneath the work area;
- crate or platform/safety decking systems, which can be used to create a crash deck or working platform underneath the work area;
- using beanbags/airbags as soft landing systems (see Figures 14(b) and 14(c));
- netting the underside of the roof;
- where ground conditions are stable, consider using mobile access equipment; and
- harnesses as the last option considered. Use them only where appropriate safe anchorage points are available and there is sufficient space clear of obstructions below the working position should a fall occur.

**A teenager fell 10 m to his death while removing slates from a roof. The slates were being reclaimed before full demolition. They were stored on a small area of flat roof adjacent to the pitched roof. He was loading the slates onto an inclined hoist when he fell. No edge protection was provided at the flat roof.**

110 Mechanical handling devices and waste chutes (see Figures 4 and 6) are particularly useful in demolition where large quantities of waste and reclaimed materials are removed from roofs.

111 Demolition of buildings with fragile roof sheets or liners needs careful planning. CDM 2015 requires that all those (including clients) who appoint contractors are satisfied that they have the necessary competence and resources. Resources include the time needed to plan and carry out the work safely.

112 Asbestos cement sheet is a fragile material and you cannot rely on it to support someone's weight. If the asbestos cement sheets are in good condition and it is possible to provide safe access, preferably from underneath (eg using scissor lifts), take the sheets down whole from underneath. Do not drop or damage the sheets but lower them to the floor. Dispose of them by carefully transferring them to lockable vehicles or skips, or by wrapping them intact in heavy-duty sheet plastic. For advice on the disposal of waste asbestos sheets visit the government web pages on hazardous waste.<sup>14</sup>

113 If the roofing sheets are in poor condition (ie liable to break when handled), or if you cannot provide safe access and the risk of falling is too great, then remote demolition is preferred. This could be by machine, such as a pusher arm or deliberate controlled collapse. In this case, you should follow the precautions outlined in Appendix 5 to control the spread of asbestos.

114 While remote demolition can be necessary in some cases, do not do it without careful consideration. Where asbestos materials are involved, careful planning and suitable precautions are needed to reduce the spread of asbestos fibres.

**A demolition foreman was removing asbestos cement roof sheets from a factory roof when he fell 7.5 m through the fragile roof to the concrete floor below. He received multiple injuries from which he died four weeks later. No equipment was provided on the roof to allow the work to be carried out safely.**



**Figure 14(a)** Decking system that provides a working platform in the roof eaves (image courtesy of Oxford Safety Components Ltd)



**Figure 14(b)** Airbags being used as a fall mitigation measure during roof work (image courtesy of Airtek Safety Products Ltd)



**Figure 14(c)** Beanbags being used as a fall mitigation measure during roof work (image courtesy of Forest Safety Products Ltd)

## Short-duration work

115 To be classed as ‘short-duration’ work the task must have been assessed as low-risk and only taking a short amount of time. Though short-duration work is measured in minutes rather than hours, the task must still be risk-assessed and appropriate precautions and controls implemented. It might include tasks such as inspection, replacing a few tiles or minor adjustment to a television aerial. It may not be reasonably practicable to install the same level of safeguards as for longer tasks, such as a full independent scaffold or even edge protection for such work, but you will need to provide something in its place. The decision on the precautions to take will depend on an overall assessment of the risks involved. You should consider:

- duration of the work;
- complexity of the work;
- pitch of the roof;
- condition of the roof;
- type of roofing material (slate, tile or waterproof membrane);
- weather conditions;
- risk to workers putting up edge protection; and
- risk to other workers and the public.

116 The minimum requirements for short-duration work on a roof are:

- a safe means of access to the roof level; and
- a safe means of working on the roof, eg:
  - on a sloping roof, a properly constructed and supported roof ladder (BS 8634);<sup>15</sup> or
  - on a flat roof without edge protection, a harness with a sufficiently short lanyard, attached to a secured anchorage, that it prevents the wearer from reaching a position from which they could fall.

117 Mobile access equipment or proprietary access systems can provide a suitable working platform in some situations. They can be particularly appropriate for minor work, especially as they remove the need to go onto the roof surface (see Figure 15). Where this is not practicable, consider using work-restraint or fall-arrest systems.

118 When using fall-protection systems for short-duration roof work, fall-protection equipment (used as a work restraint) is preferable to fall arrest, as it prevents people falling by physically restricting their movement to a safe area. It should not be possible to reach any unprotected edge, hole or fragile material when relying on this type of system.

119 Fall arrest is not the same as work restraint (see Figure 16). Fall arrest relies on minimising injury once a fall has occurred. In both cases, seek specialist advice on anchorage points from the equipment supplier. Supervision and training are needed to make sure that the system of work adopted is understood by all and is maintained. A rescue plan is also necessary in the event that someone should fall.

120 Harnesses need to be suitable for the individual, who should be trained to fit and use them. They protect someone only when they are properly fitted and attached to a suitable anchorage point. There must be enough clear space below the work position to allow the fall to be arrested safely (see Appendix 3). They are not an easy option. See paragraphs 48–53 and Appendices 2 and 3 for further information on fall arrest.



**Figure 15** A mobile elevating work platform being used to replace a roof sheet

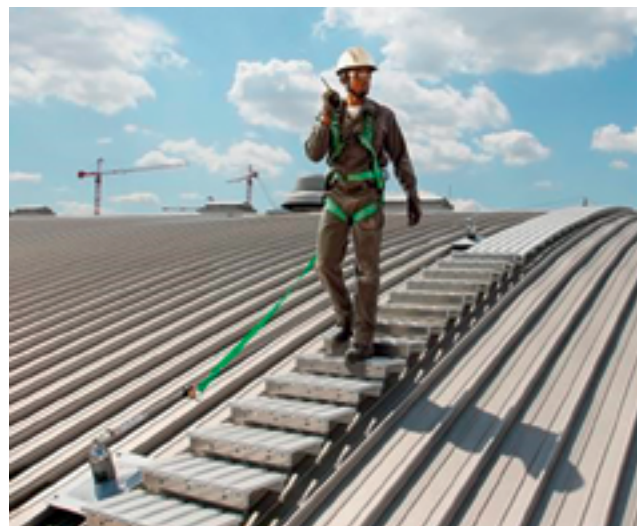

**Figure 16** Work-restraint harness used during short-term inspection on a roof (image courtesy of MSA Safety)

# TYPES OF ROOF

121 Paragraphs 122–229 explain the hazards characteristic of different roof types and the precautionary measures required to deal with them.

## Flat roofs

122 Flat roofs are generally accepted as being up to 10° in pitch and are usually waterproofed with a membrane such as reinforced bitumen membrane (RBM), roofing felt, single-ply membrane, liquid membranes or profiled metal sheeting.

123 On flat roofs, falls most frequently occur:

- from the edge of a completed roof;
- during surveying, inspection or construction;
- from the edge where work is being carried out;
- through openings or gaps; and
- through surfaces that are slippery or have become fragile, eg strawboard, unfixed profiled, metal decking or aged roof lights (see paragraphs 170–186 and Appendix 4).

124 Where the design of the roof does not provide permanent edge protection, such as a suitably strong parapet wall of at least 950 mm in height, temporary edge protection will be required (eg guard rails and toe boards, as in Figure 17, or other suitable proprietary edge protection systems). This should, when erected:



**Figure 17** Temporary flat-roof edge protection (image courtesy of Safesite Limited)

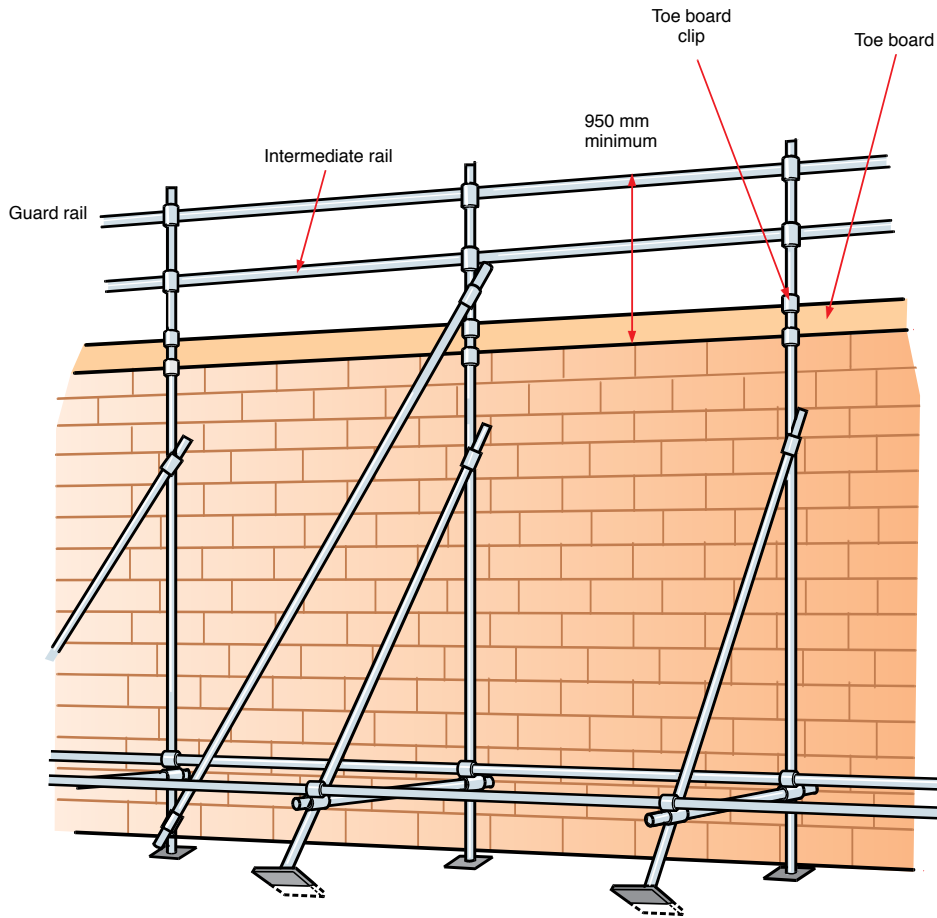

**Figure 18** Flat-roof edge protection supported at ground-floor level. Ground-level support allows work up to the roof edge without obstruction

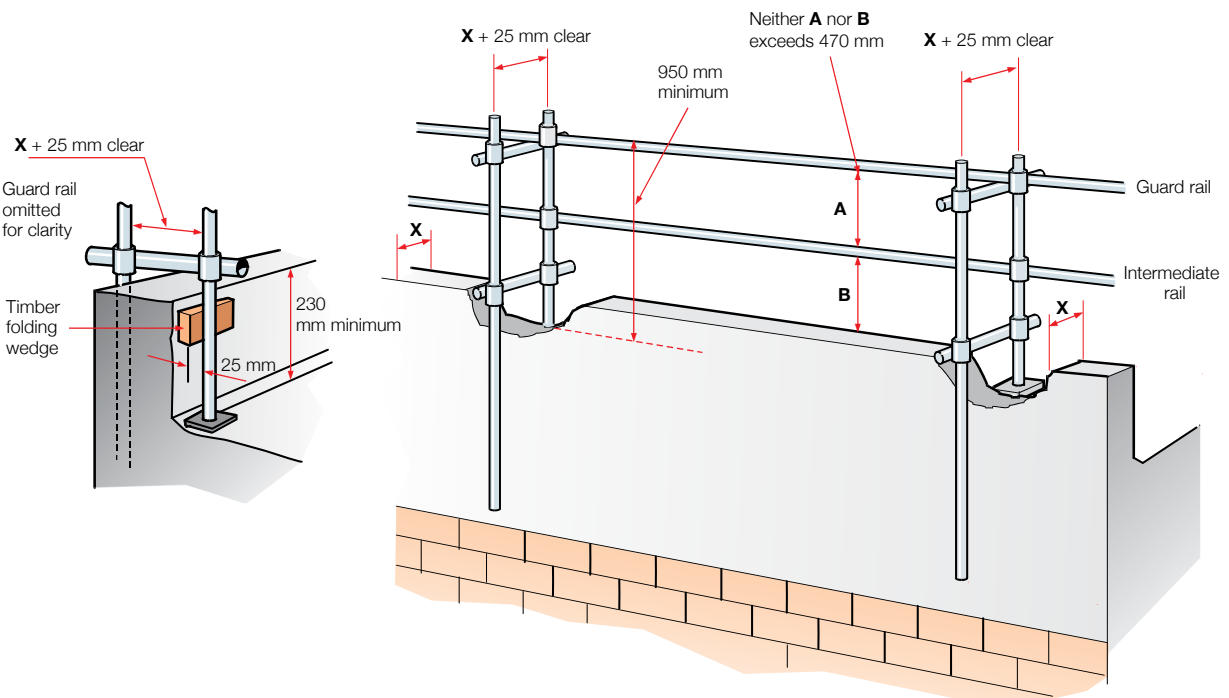

**Figure 19** Flat-roof edge protection supported on the roof edge upstand. The roof edge upstand must have adequate strength



- give protection for the full duration of the work;
- be strong and rigid enough to prevent people from falling and be able to withstand other loads likely to be placed on it (BS EN 13374 sets a suitable standard for this);<sup>16</sup> and
- be designed in such a way that it is not necessary to remove it to work at the edge of the roof.

If the temporary edge protection is fixed to a structure, the structure should be capable of supporting it.

125 Guard rails should preferably be supported at ground level, if the height of the building allows, so they do not obstruct work on the roof edge (see Figure 18). For a higher structure, they can be supported by an upstand at the edge of the roof if this is strong enough (see Figure 19). Guard rails can also be supported by appropriate frames, counterweights or scaffolding on the roof.

126 All temporary guard rails should meet the minimum legal standard contained in the Work at Height Regulations 2005, ie they should include:

- a main guard rail at least 950 mm above any edge from which people are liable to fall;
- a toe board, which should be suitable and sufficient to prevent the fall of any person, material or object, at least 150 mm high; and
- an intermediate guard rail, barrier or suitable alternative, positioned so that the unprotected gap is no greater than 470 mm.

127 For short-duration work on flat roofs, it may not be feasible to provide edge protection, but suitable alternative precautions will still need to be used (see paragraphs 115–120 for further guidance on short-duration work).

## Demarcation of access routes and work areas

128 Where limited work is being carried out on sections of a large roof it may not be reasonably practicable to install edge protection around the whole perimeter. Where a suitable and sufficient risk assessment justifies it, a simple form of continuous physical barrier a safe distance from the roof edge should demarcate the work area and any access route to it (access routes to the work area should be chosen such that they are as short and safe as reasonably practicable). The distance should be adequate to make sure that people working within the demarcated area cannot fall from the edge of the roof or through any fragile material. Where this method is used on roofs with a slight slope, it may be necessary to prevent materials rolling away beyond the 'safe' area. Such demarcation barriers do not need to meet the same design standards as edge protection.

129 In most circumstances it will be sufficient for the physical barrier to be a distance of at least 2 m from the edge or any fragile area. This will depend on the geometry of the roof and may need

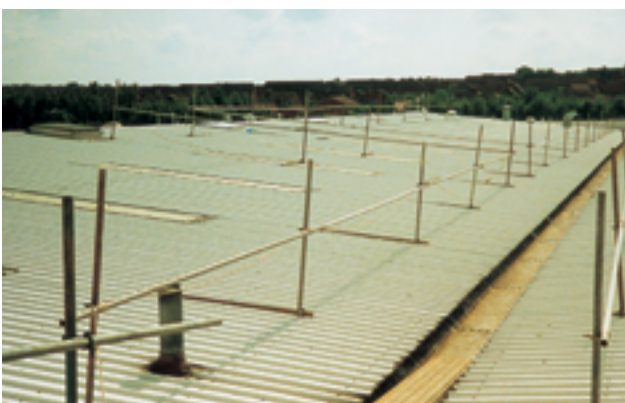

**Figure 20** Demarcation barriers on a large, non-fragile roof preventing access to the adjacent roof lights. The roof lights are at least 2 m from the barrier



**Figure 21** Craning a pre-assembled roof into position greatly reduces the need for work at height (image courtesy of the Trussed Rafter Association)

to be increased. This type of barrier is acceptable only when there are high levels of skilled, knowledgeable and experienced workers carrying out the work and where there is a high level of supervision and discipline to make sure that people do not go beyond the demarcated access route or work area.

130 There should be no unprotected holes, breaks or fragile material within the 'safe' area. If there are any, they should be protected with robust covers or continuous physical barriers. All barriers should be durable and immediately obvious to all, and should be secured or weighted to cope with wind conditions (see Figure 20). Bunting, tape or markings at foot level, such as a painted line, are not sufficient.

## Slated and tiled (pitched) roofs

131 On traditional pitched roofs, most falls occur:

- from the eaves;
- from the roof, typically slipping down the roof, then falling from the eaves;
- from the roof, falling internally, eg during roof truss erection, stripping roofs, installing membranes and re-roofing; and
- from gable ends.

132 To prevent falls, consider the following:

- hoisting and lowering of materials;
- gaining access to and egress from roof level;
- falls from access platforms;
- gaining access to and egress from platform to roof;
- falls from eaves, between trusses and from the verge;
- transporting roof materials to roof area;
- laying felt/underlay and/or insulation;
- fixing battens, trusses, slates or tiles;
- loading out with slates or tiles;
- gaining access to the ridge after slates or tiles are fitted;
- transporting materials and mortar to the ridge;
- fixing the ridge; and
- securing fall-protection systems.

### ***Roof truss erection***

133 Prefabrication of roof sections (including trusses and pre-formed gable ends), before delivery or on the ground on construction sites, allows completed sections or whole roofs to be craned into place. This greatly reduces the need for work at height (see Figure 21). A safe working platform will be required around the perimeter of the building to fix the trusses into position on the wall plate. Where such pre-assembly work takes place at ground level on site, work must be planned and designed with the truss designer, as lifting frames and spreader beams may be required to support the pre-assembled unit during lifting.

134 If it is not reasonably practicable to prefabricate roof sections and trusses need to be assembled in situ, a safe working platform will be required around the perimeter of the roof and (following the hierarchy of control for work at height) a safe working platform or proprietary decking system immediately beneath the underside of the trusses. This will prevent falls and assist the installation of trussed rafters, providing access within the trusses to fix bracing.

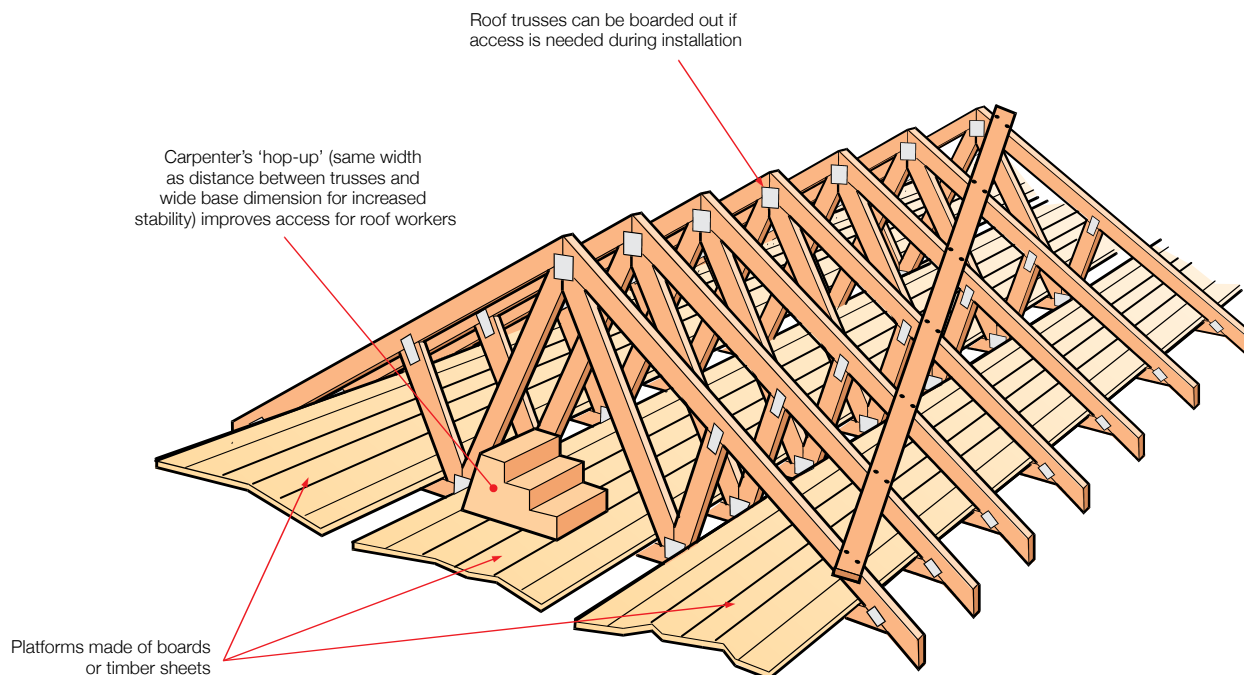

**Figure 22** Roof trusses can be boarded out if access is needed during installation. Hop-up platforms improve access

135 It may be possible to use working platforms supported by the bottom chord of trusses, if they are stable and capable of supporting the load (see Figures 14(a) and 22). Guard rails should be provided, unless truss members provide a similar standard of protection. Work below should be prohibited unless workers are protected from falling materials. Protection may be needed at the leading and side edges during installation of such platforms.

136 Where a robust risk assessment shows that platforms are not reasonably practicable then you must consider other forms of fall protection to reduce the distance and/or mitigate the effects of any fall from height. It might be appropriate to use nets or soft landing systems. Nets can be used if a safe clearance distance below the net and a suitable fixing point can be achieved; alternatively soft landing systems such as beanbags or airbags can be used (see Figure 14(b)–(c)).

137 Where nets or soft landing systems are used:

- they must be fit for purpose (consult the installer). For example, where blockwork is used to support nets, you must allow time for the mortar to cure and reach sufficient strength to sustain the load should a fall occur;
- the risk of injury during the fall, eg from striking parts of the rafters or blockwork, needs to be carefully assessed; and
- working platforms should be provided as far as reasonably practicable in addition to the measures taken to arrest a fall.

138 You must store rafters and rafter bundles so that they will be stable under all foreseeable loading conditions – see the *Trussed Rafter Association technical handbook*.<sup>17</sup> If they are to be stored on a scaffold make scaffold designers aware of this so they can consider additional loading in the design. The scaffold platform can be extended to allow for safe storage and butressing can be included to keep the trusses stable.

139 Use a crane or other mechanical handling device for lifting trusses, unless this is not reasonably practicable.

140 Good planning and design can avoid or reduce the need for manually handling roof trusses and this should be your aim. For instance, site layout designs can consider the need for crane locations. Work plans can then allow for crane areas to be clear of other activities when trusses are installed.

141 Roof trusses can vary a great deal in size and shape. There are several configurations, eg attic, duo-pitched, single-pitched, and laminated (or plied). Trusses can measure from a few metres wide and high to 20 m long and 5 m high.

142 Fabricated trusses vary widely in weight and if plied together with another can be a significant load. Truss weights should be checked before working with them. Attic (or 'room in roof') trusses are particularly heavy – they have large timber members to make up for the lack of triangulation timbers.

### Handling of roof trusses

143 Trusses should be mechanically handled. However, where a robust risk assessment clearly shows it is not reasonably practicable to do so, you should introduce a safe system of work to reduce the risks of musculoskeletal injury associated with manually handling roof trusses in teams. A comprehensive method statement and specific instruction and training will be required to make sure all handlers understand their role in the operation. Use the following recommendations:

- do not use manual handling where it is reasonably practicable to use lifting equipment;
- do not use manual handling for structures more than two storeys high;
- keep the area where the trusses are carried clear. Stockpiles of wood or other obstructions should not be present where team members may have to step across or around them to complete the task;
- operatives should not jump or step from level to level while supporting a truss; and
- make an effort to reduce general noise levels so team members can communicate more effectively and are better able to co-ordinate the handling task.

144 When handling the truss, enough team members will be needed on each level to which the truss is raised. Sufficient room is needed on each level for the members of the team and the truss. No member of the handling team should be exposed to the risk of a fall.

145 When truss handling in teams, there are risks of overexertion, repeated exposure to manual handling and musculoskeletal disorders (MSDs). There is also a risk of an accident as co-ordination within the team operation is vital. With team lifts, there is a chance that co-ordination and therefore control over the load could be lost.

### Planning installation of trussed rafters

146 Before you begin:

- check and read all assembly drawings and information provided by the truss supplier;
- use the truss layout drawings to identify the installation sequence. Make sure that the selected sequence allows all trusses to be installed;
- make sure scaffolding has been designed for the task and is complete and handed over ready for use;
- a safe working platform within the structure is strongly recommended;
- make sure hop-ups and scaffolding edge protection are in place; and
- make sure appropriate PPE is selected, correctly fitted and worn.

147 Work programming should include enough time for the supporting structure to gain sufficient strength before roof construction begins; eg blockwork should be adequately cured. Gable walls are usually unstable until tied into the roof assembly and can collapse during truss erection. Unless steps are taken to ensure stability, gable walls should be completed after the trussed rafter roof construction. Party wall construction in terraced units should follow the same principle unless

temporary restraint is provided. Safe access for the bricklayers will need to be planned in for any work that cannot be done from the eaves scaffold.

148 Truss packs and individual trusses must be adequately braced at all times so that they will be stable under foreseeable weather conditions during handling and installation:

- Where such bracing will rely on scaffolding, make the scaffold designers aware of this in advance. They will need to ensure the scaffold is constructed in accordance with a design drawing based on engineers' calculations to safely support the anticipated loads for this site.
- Where such bracing relies on other elements of the building seek the advice of a structural engineer to ensure these elements can support the number, size and weight of trusses intended.

149 Further information on the safe handling and installation of trussed rafters is available from the Trussed Rafter Association at [www.tra.org.uk](http://www.tra.org.uk)

### ***Open rafters***

150 You must consider and address the risk of people falling through the open rafters when fixing tile support systems or when laying underlay and fixing battens.

151 This is achieved by following the work-at-height hierarchy and putting in place measures that prevent a fall where it is reasonably practicable to do so. Where it is not reasonably practicable to prevent a fall, you must provide measures that mitigate the distance and consequences of a fall.

152 What is reasonably practicable will differ between new-build properties and strip and re-cover roofing jobs. Some examples of reasonably practicable measures include the following, although this list is not exhaustive:

- boarding out the inside of the roof using timber (see Figure 22);
- using proprietary decking systems (see Figure 14(a));
- inserting airbags or beanbags (see Figures 14(b) and (c));
- installing a safety net; or
- using boards in conjunction with a safe system of work.

### ***Sloping roofs – edge protection requirements***

153 Falls from sloping roofs are more likely if the pitch is steep, if the surface is slippery and in windy conditions. Moisture, ice, snow, moss and lichens all increase the risk of slipping (see paragraphs 64–70).

154 For work on sloping roofs, full edge protection is required on all roof elevations to which access is needed unless the work is of very short duration and low-risk. This is to prevent people and materials falling from the lower edge of the roof. The potential loading on edge protection when a person slides down a pitched roof onto it is much greater than when they fall against it on a flat roof. Make sure that the edge protection supplier knows the roof pitch when you specify edge protection.

155 Where roofs are steep, the edge protection system needs to be capable of safely containing a person sliding down the sloping surface. In all cases, the edge protection should be designed to minimise injury as well as to prevent a further fall. Such systems should either be designed and able to demonstrate how they achieve this or meet BS EN 13374.

156 If work on the roof requires access within 2 m of gable ends, then edge protection will be needed at those edges. If the access to the gable end is greater than 2 m the guidance in paragraphs 129–130 can be applied. At gable ends there should be one or more working platforms between the eaves' height and the ridge. The distance from the highest working platform to the ridge should be no more than 2 m.

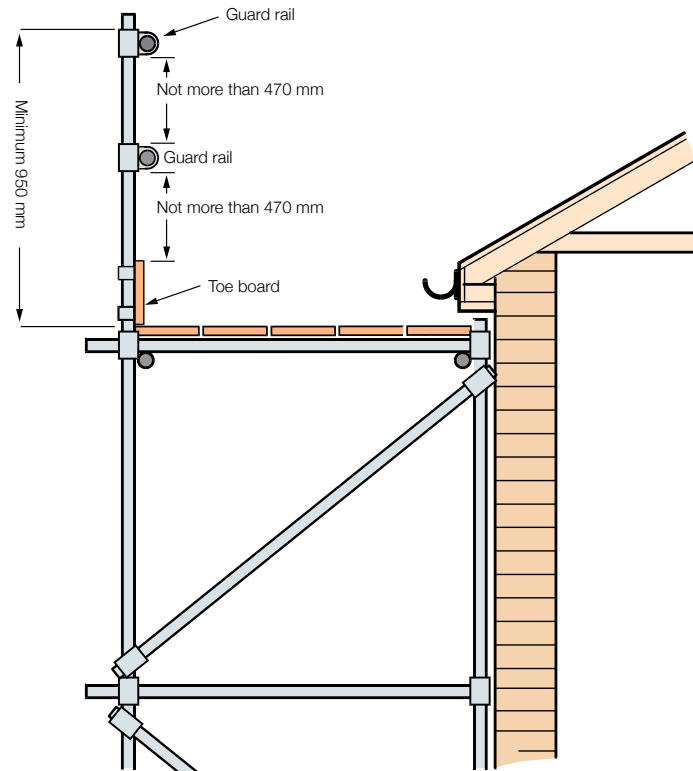

**Figure 23** Typical sloping roof edge protection

157 A scaffold platform at eaves level provides a good standard of edge protection, a working platform and storage space for materials (see Figure 23). The working platform should be as close as possible to the eaves and is recommended to be no greater than 300 mm below eaves level. Brick guards will be necessary if materials, eg roof slates, are stacked above toe board height. They can also reduce gaps between guard rails, but need to be designed for this purpose (taking account of the pitch of the roof) and securely fixed.

158 For short-duration work on a pitched roof (eg replacing a few tiles or slates) the decision on whether to erect edge protection will depend on a number of factors (see paragraphs 115–120).

159 The minimum standard for short-duration work on a pitched roof is:

- safe means of access to roof level; and
- a properly constructed and supported roof ladder (see paragraphs 164–169) or equivalent.

160 Roofers and other trades should avoid walking on the laid roof covering because tile/slate roof coverings, including ridges, hips and inclined valleys are not designed to be walked on and offer no firm footholds. This will mean bringing valleys, ridge and hip tiles through as the roof is covered and working in a planned way to cut down foot traffic on the finished roof. The method of work used should take into consideration the fact that a greater proportion of the tiles or slates will be fixed to the tile batten as required by BS 5534,<sup>18</sup> so it will not be possible to push tiles or slates back to provide a foothold.

161 Roof workers should not work directly on tiles or slates unless additional measures are provided to prevent falls, eg a roof ladder.

#### Slating direct to boarded roofs

162 For many years the use of metal 'spikes' or 'heels' has been an integral part of Scottish practice. It is still quite common to fix slates straight to boards, which means there are no battens



**Figure 24** A traditional chimney scaffold



**Figure 25** Proprietary system for access to roof and chimney

to be used as footholds. The metal 'spikes' are driven into the roof and are used as hop-ups by the roofers. For more information on this see the NFRC website ([www.nfrc.co.uk](http://www.nfrc.co.uk)) and the health and safety guidance sheet *Slater's heel*.<sup>19</sup>

### ***Chimney scaffolds***

163 For work on chimneys, a chimney scaffold should be used (see Figures 24 and 25), unless the work is minor or very short-duration (such as pointing or lead flashing inspection) and can be safely carried out from a correctly installed roof ladder.

### ***Roof ladders***

164 On most sloping roofs, suitable roof ladders or crawling boards will be essential, in addition to edge protection. Where a high standard of edge protection is provided, it may be safe to work without a roof ladder. This may apply if the pitch is shallow and the surface provides particularly good foothold and is non-fragile. In each case base the decision on a risk assessment.

165 Roof ladders or crawling boards should be:

- designed and fabricated to be fit for purpose;
- strong enough to support workers when spanning across the supports for the roof covering;
- long enough to span the supports (at least three rafters); and
- secured or placed to prevent accidental movement.

166 Roof ladders to BS 8634 will meet both the design requirements above and the anchorage requirements set out here. The anchorage at the top of the roof ladder should be by some method that does not depend on the ridge capping as this is liable to break away from the ridge. The anchorage should bear on the opposite slope by a properly designed and manufactured ridge hook (see Figure 26) or be secured by other means.

A 34-year-old self-employed roofer fell from the edge of a pitched roof to a two-storey house when his home-made roof ladder slid down the roof. He was replacing chimney pots and an access scaffold was in position, but only a single guard rail was fitted and he slid beneath this to his death.

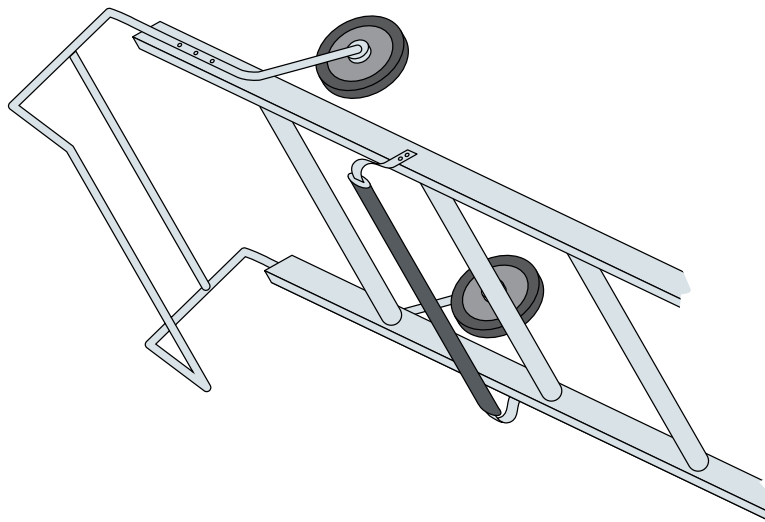

**Figure 26** Roof ladder. The ridge hook should be large enough to be clear of the ridge tile

167 Do not use eaves gutters as a footing or to support a roof ladder unless they are of adequate strength – this is not usually the case. Gutters normally used on houses are not suitable.

168 Where slated and tiled roofs are being covered, timber battens might provide a reasonably secure foothold, but only where the following criteria are adhered to and properly supervised:

- the battens are fixed to rafters set at centres not more than 600 mm apart;
- the battens are a minimum size of 50 mm x 25 mm (maximum span 600 mm) or 38 mm x 25 mm (maximum span 450 mm) and meet the grading requirements specified in BS 5534:2014+A2:Code of practice for slating and tiling and NFRC *Technical bulletin 33 Graded battens for slating and tiling*;<sup>20</sup>
- the battens are at least 1.2 m long to make sure they span a minimum of three trusses;
- the battens are fixed only with the recommended nails;
- the safe system of work dictates that the roofers never deliberately walk on the battens mid-span between the trusses; and
- the safe system of work dictates that the roofers always walk on the rafter line when installing the tiles and slates.

169 A roof ladder will always be required at some stage, eg towards the end of the job when the battens are covered by tiles.

A 50-year-old roofer was killed when he fell from the edge of a pitched roof. He was understood to have been carrying out extensive work to repair the roof following storm damage. There was no edge protection and the access ladder was not secured.

A self-employed roofer aged 29 was killed when he fell from the edge of a pitched roof. He was repointing a chimney stack and replacing some tiles on the roof and gained access using an extending ladder/roof ladder. However, there was no roof ladder on the rear elevation and he fell from the edge of the pitched roof at the rear of the property.

## Fragile roofs and surfaces

170 Falls through fragile surfaces account for nearly 20% of all the deaths in the construction industry. However, deaths caused by falls through fragile surfaces do not occur only in the



construction industry; people working in the maintenance sector are also affected and this involves a whole range of fragile surfaces.

171 The terms 'fragility' and 'fragile surfaces' are used in this publication to describe roof assemblies that will not support the weight of a person and any materials they may be carrying.

172 The test to show non-fragility for a roofing assembly has been drawn up by the Advisory Committee for Roof Safety (ACR) and is published in *Test for non-fragility of large element roofing assemblies*.<sup>21</sup> The test is discussed in greater detail in Appendix 4.

173 All designers and contractors should make sure that any non-fragile roof assemblies they design or fix have been tested in accordance with the above standard and are classified as non-fragile class C as a minimum for low-maintenance roofs, and class B for medium-maintenance roofs. Refer to the ACR's industry guide *Recommended practice for work on profiled sheeted roofs*<sup>22</sup> for more information.

174 Whatever roofing assembly has been specified, all non-fragile roofs will deteriorate with time and at some point the assembly will become fragile. All roofs, once fixed, should be treated as fragile until a competent person has confirmed that they are non-fragile.

175 In particular, the following are likely to be fragile, although this list is not exhaustive:

- old roof lights;
- old liner panels on built-up sheeted roofs;
- non-reinforced fibre cement sheets;
- corroded metal sheets, either as the primary waterproofing system or as the structural deck supporting a membrane roofing system;
- glass (including wired glass);
- rotted chipboard or similar;
- wood wool slabs; and
- some slates and tiles.

176 Wood wool (slabs) may fracture beneath someone's weight. You should treat the following as fragile:

- wood wool slabs less than 75 mm thick without a nylon net reinforcement;
- wood wool slabs with a nylon net reinforcement but less than 50 mm thick;
- wood wool slabs that are wet or previously damaged;
- all straw boards, but especially those affected by water; and
- all slabs where it is not possible to determine either their condition or the specific type that has been used.

177 Falls through fragile materials are a particular problem in both the roof work and building maintenance sectors. Everyone with responsibility for this type of work, at whatever level, should treat fall prevention as a priority. This is particularly important for small, short-term maintenance and cleaning jobs. See *ACR guidance note Safe working on fragile roofs or roofs with fragile elements*.<sup>23</sup>

A 60-year-old employee was killed when he fell through a fragile roof as he was helping to install a ventilation duct for a spray booth.

A self-employed builder, aged 52, fell while he was trying to repair damage to the asbestos cement roof of an industrial unit. He fell through a fragile roof light.

178 Fragile roof accidents are not inevitable. They can be prevented by careful design, planning, using suitable equipment and employing appropriate levels of monitoring and supervision.

179 If possible, arrange the work to avoid working on or passing near fragile material. If this is unavoidable, you should identify all fragile materials and put precautions in place to prevent or minimise the effects of a fall. This applies to all operations on the roof, whether construction, maintenance, repair, cleaning or demolition.

180 The hierarchy for work on fragile roofs is:

- work from underneath the roof using a suitable work platform;
- where this is not possible, consider using a MEWP that allows people to work from within the MEWP basket without standing on the roof itself;
- if access onto the fragile roof cannot be avoided, install perimeter edge protection and use staging to spread the load. Unless all the work and access is on staging or platforms that are fitted with guard rails, install safety nets underneath the roof or use a harness system; and
- where harnesses are used they need adequate anchorage points. They also rely on discipline, training and supervision to make sure that they are used consistently and correctly.

181 Some roof coverings can give a false sense of security to people working on or passing by them. They may be capable of carrying some distributed load, giving the impression that they can bear a person's weight, but they might not carry a concentrated load such as the heel of someone walking or someone stumbling and falling. A stumble may cause the roof to fail instantly like a trap door. For example, asbestos cement and other non-reinforced fibre cement sheetings are liable to shatter without warning under a stumble. They will also become more brittle with age.

182 A common but fatal belief persists that it is safe to walk along the line of the roof bolts above the purlins. Some roofing sheets (eg roof lights, asbestos cement and fibre cement) have their weakest point of impact within 150 mm of the purlin line since the purlin provides an edge to tear the sheets.

183 So walking the purlins is like walking a tightrope: one false step or loss of balance can lead to disaster. Although roofing sheets overlap to be weathertight, the double-skin section is still unsafe to walk on.



**Figure 27** In some light conditions, it is difficult to distinguish the roof lights from the metal sheets on this type of roof. The valley gutter is very narrow and the roof lights extend down to gutter level. Both of these features increase the risk during cleaning, maintenance and refurbishment

184 Roof lights discolour with age. They may have been painted to reduce glare, making them difficult to identify (see Figure 27). In some cases, insulation may have been applied externally to a roof that is generally load-bearing but contains fragile roof lights; this can obscure the roof lights. Roof surveyors should look for signs of repair etc.

**A labourer cleaning a gutter was seriously injured when he fell 9 m after stepping onto a roof light.**

185 If any material is applied that may disguise fragile parts of a roof, mark the fragile parts clearly (red screw or bolt caps may have been used, although these can bleach with age) and record this information. Include it in any health and safety file for the building or any permit-to-work system for the roof. Erect warning notices at all access points (see paragraphs 201–202).

186 In some situations the structure supporting the roof covering may deteriorate so much that the roof becomes 'fragile' and could fail catastrophically. Where the condition of an industrial roof is in any way suspect do not walk on it to conduct a survey. Undertake a remote inspection from the ground or access from a MEWP or an equivalent safe means of approaching the area.

### ***Preventing falls through fragile material***

187 Carefully consider whether the task warrants the risk involved in working at height on a fragile roof assembly. Can the work be avoided? Or can you provide a better job and longer-term solution by:

- over-roofing or re-roofing with a non-fragile assembly, instead of multiple repairs that may fail in the short term;
- replacing sheets, instead of using patch repairs; or
- where practical, replacing roof lights from below, using a proprietary replacement and fixing system.

188 Always make sure that the workers carrying out the tasks on the fragile roof or near fragile roof materials have the relevant skills, knowledge and experience. In addition, they must be adequately supervised; understand and follow the method statement to which they will be working; and have a thorough knowledge of the materials, equipment and tools they will be using.

189 You must provide a safe working platform on the roof and safe access to the working position when people are working on fragile roofs:

- platforms or coverings spanning the purlins must be provided and used to support the weight of anyone on the fragile material; and
- guard rails or coverings are required to prevent someone who is passing or working near fragile material from falling through.

190 You must secure the platforms or covering adequately against slippage.

191 You should establish boundaries on roofs with fragile materials, identifying 'safe' areas containing the workplace and safe routes to and from it. Access to the roof should be as close to the workplace as reasonably practicable, reducing the need to create demarcated access routes:

- the boundary should be at least 2 m from the nearest fragile material;
- the boundary does not need to comply with full edge protection standards, but there should be a continuous physical barrier (a painted line or bunting is not acceptable); and
- tight discipline is essential to make sure that everyone stays within the safe area at all times.

192 Stagings of a suitable and sufficient width fitted with guard rails meeting the standard in paragraph 126 can be used where the roof pitch permits. The roof structure needs to be strong enough to take the combined weight of the staging, guard rails, workers and any materials or

equipment used. There should be enough stagings available to allow the work to be carried out safely. Workers should not have to move stagings continually to progress over the roof. Stagings should also be long enough to provide adequate support across roof members. They should span across at least two purlins.

193 Where it is not practicable to maintain guard rails on both sides of the staging, other collective fall-protection measures will be required, eg:

- birdcage scaffolds;
- mobile towers or scaffold used as a crash deck;
- safety nets (as long as there is adequate clearance below) (see Figure 28); or
- soft landing systems.

194 Harness and line systems can also form part of the system of work but they are lower down the hierarchy for work at height as they rely on operator training and a high level of supervision. The quality of the attachment system is critical. There are also minimum heights below which the system will be ineffective; in this case, someone may hit the floor before the restraint is fully operational. See Appendix 3 for further guidance.

195 In most situations additional measures (usually in the form of fall protection such as safety nets or harnesses and running line systems) are required to protect workers using trolley systems from falling through a gap created when replacing an old sheet or roof light.

196 Make sure that at all times the work area is clean and tidy to avoid slips and trips, which may lead to falls.

197 Where a valley or parapet gutter is used for access it should be of a suitable width and of sufficient strength to resist all foreseeable loads. Take precautions to prevent anyone falling from any edge or through fragile material in the adjacent roof. Where access along gutters is necessary on a regular (even if infrequent) basis, permanent protection should be provided. Where practicable, this should provide collective rather than individual protection. Fixed covers (see Figure 29), for example, are preferable to running line systems.

198 Covers should be fitted far enough up the roof to protect anyone who falls against them. This is normally up to 2 m, depending on the roof pitch; shallower pitches will need more extensive coverage than steeper ones. Remember that protection (such as safety nets or a birdcage scaffold) is needed when covers are being installed. Valley gutters that are overhung by roof sheets so much that there is not enough space for someone's feet should not be used for access along the roof. It should be possible to clean the gutters without removing walkways or covers.

199 Roof lights should not extend within 2 m of valley gutters. Where fragile roof lights have already been fitted in this position and access is needed, consider permanently protecting the roof lights (see Figure 29).



**Figure 28** Safety netting used to minimise the distance and consequences of a fall for roof lights during roof works

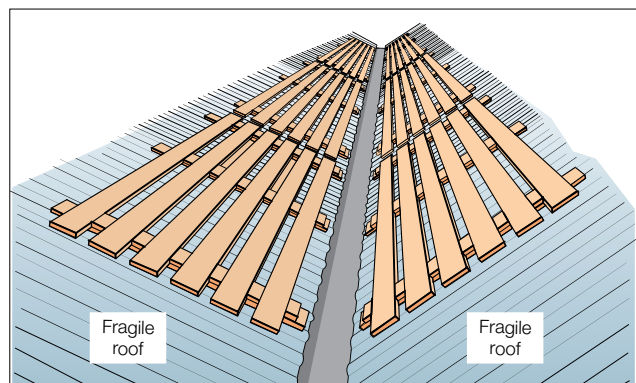

**Figure 29** Permanent protection installed at valley gutter (the protection should be supported by at least three purlins beneath the roof sheets)

200 Take precautions to prevent unauthorised access to fragile roofs. This will normally involve people at work, but you may also need to consider the likelihood of unauthorised public access, particularly by children (see Protecting the public: Your next move HSG151).<sup>24</sup> A risk assessment made under the Management of Health and Safety at Work Regulations 1999 is likely to require signs warning of the hazard and prohibiting access except under controlled conditions (eg governed by a permit-to-work regime). Access to permanently fixed ladders should be prevented whenever access is not required (eg by blocking or locking them off).



Figure 30 Typical fragile material warning sign

201 Figure 30 illustrates a suitable sign which should be fixed at the approaches to roofs with fragile coverings. Such signs should be durable, securely fastened and properly maintained. Any signs used should meet the requirements of the Health and Safety (Safety Signs and Signals) Regulations 1996.<sup>25</sup>

202 Such signs are not an alternative to a designer's duty to design out hazards at source. Their function is to warn of dangers on existing buildings and where the load-bearing properties of the roof assembly are either classed as fragile or are unclear because of ageing etc.

## Profiled sheeting

203 Paragraphs 203–229 deal with all roof work that uses large-element profiled sheeting, which typically will be industrial, large retail, commercial, sports complex and agricultural buildings.

204 The roofing system will generally be on a pitched roof of the following typical construction:

- built-up on-site assembly of liner, insulation and outer sheet;
- factory-assembled composite panel and laid as single unit; or
- single-skin application for unheated buildings.

205 The large-element sheeting will be fixed to steel or timber purlins.

## Design issues

206 Designers need to consider the following three factors which will influence safety during the construction, maintenance and demolition phases of profile sheet roofs:

- **Non-fragility:** Most industrial-grade profiled sheets, including roof lights, are now available to achieve a non-fragile status when installed. Designers should make sure that such specifications are followed during procurement and construction. A reduction in the thickness of the profiled sheeting, to save on cost, may result in a non-fragile specification becoming a fragile construction.
- **Longevity:** Whatever roofing assembly has been specified, all non-fragile roofs will deteriorate with time, and at some point the assembly will become fragile. Environmental issues may also affect longevity. Designers should therefore determine the design life of the roof and specify the roofing materials that will provide non-fragility for this period. Such information must be included in the health and safety file for the building.
- **Material weight:** With an increasing need to provide better-insulated and more airtight buildings there is a growing need for thicker, longer and therefore heavier roof panels. Designers must consider the safety issues with handling the materials that they specify.

### ***Systems of work***

207 Falls from profiled sheeted roofs commonly occur:

- through roofing that is or has become fragile;
- through gaps in partially completed roofs;
- through lining panels that were not designed to be non-fragile as a single underlay;
- through sheeting that is not fully fixed;
- from the leading/working edge or gable edge or eaves and gutter; and
- when loading out the roof.

208 The system of work needs to include all stages of the job, including delivery of materials (see Appendix 1). Simply loading out the frame with packs of sheets, as delivered, leads to workers travelling around the roof, passing open edges more often, to get the correct length of sheet or accessories.

209 Ways of minimising travel on the roof include:

- using hoists to deliver materials to the working position or to loading bays;
- providing access points convenient to the working positions;
- splitting packs of roof sheets to produce mixed packs in the correct sequence for fixing; and
- back-loading sheets onto the completed (load-bearing) sections of roof.

See Figures 31 and 32.

210 Safe working positions and the means of access to and from those positions should be planned in advance. Such planning should address the safety of all who may need to access or work on the roof and should consider using, for example:

- working platforms on the roof, fitted with guard rails and toe boards, or other edge protection;
- mobile access equipment;



**Figure 31** (above) Delivering sheets to roof level onto the completed load-bearing section and behind the leading edge (note that the roof lights include mesh protection and are non-fragile)



**Figure 32** (right) Loading bays should be designed for the actual weight of the materials to be placed on them and include an additional allowance for impact loads from mechanical handling (eg cranes or forklifts). A notice should clearly display the safe working load

- stair towers;
- safety nets; and
- suitable safety harnesses with suitable anchorage points.

211 It is not acceptable for open steelwork or gutters to be used as the access route or place of work.

212 Limit the weight of material to the amount that the structure can carry safely. Metal Z-section purlins can twist and collapse under heavy loading. Lash sheets to prevent them being dislodged or blown away. If necessary, use stops to prevent them slipping.

213 You can prevent falls from the edge of the building frame by fitting suitable protection. This may be by an independent scaffold and platform around the perimeter of the building or by barriers connected to a frame. Barriers connected to the frame should conform to BS EN 13374, see Appendix 7. The pitch of the roof will determine what class of BS EN 13374 edge protection is suitable. Pitches over 30° will require a class C edge protection system.

214 All profiled sheeting should be specified to be non-fragile when fully fixed. Contractors need to be aware that unfixed or partially fixed materials cause the roof assembly to be deemed fragile. Therefore, carefully developed systems of work must remain in place, including working edge protection and being fully netted out underneath.

215 Lining out the roof as quickly as possible to 'weatherproof' the shell means that roof workers have to return in a second pass to lay the insulation and top sheets if a built-up system is to be installed. Principal contractors should consider how this approach affects safe systems of work. Encourage the use of work-restraint systems or 'walkable' non-fragile liners. Other resources may be needed to achieve a safe system of work, eg safety nets.

A roofer, aged 49, was killed when he fell through the fragile inner lining of an industrial roof where some steel roofing sheets had been removed. He was working to progressively replace the roof sheets and roof lights on the roof when he stepped on the open section of the lining and fell through as he attempted to avoid a roof light panel in the vicinity.

216 Falls through gaps, eg for smoke vents, are a common cause of serious injuries and death. Designers can help by eliminating or reducing the number of openings. If there is a need for openings in the roof, consider the use of safety nets at the tender stage to protect both the gaps and the leading (working) edge.

### ***Leading edge protection***

217 Take precautions to protect against falls from roof edges and working ('leading') edges. Safety nets and birdcage scaffolds are the preferred options to prevent falls from leading edges. However, where these are not reasonably practicable you can consider using a harness with work-restraint lanyard and running line system, or temporary edge protection at the leading edge, eg trolley systems.

218 Safety nets give roof workers maximum freedom of movement, provided that they do not work beyond their boundary. They can be installed to minimise fall distances (see Appendix 2). They are effective where design details such as hips make other systems complex and difficult to manage. In a fall the chance of injury is reduced, compared to a similar fall in a harness or onto a birdcage scaffold. Safety nets protect the leading edge and gaps, fragile areas, etc

219 The Advisory Committee on Roof Safety gives guidance on the safe use of safety nets in *Recommended practice for use of safety nets for roof work*<sup>26</sup> and further guidance is available in a series of Fall Arrest Safety Equipment Training technical bulletins.<sup>27</sup>

220 Where it is not possible to use safety nets, other fall-protection systems may be used. Running lines designed to be used with a suitable harness/lanyard can be attached to the structure, to a

mobile anchor point or to a working platform. Running line systems should be designed and tested to make sure that they are fit for purpose. The quality of the attachment point is critical, as is the type of harness (belts are not acceptable for fall arrest). See Appendix 3 for further information.

221 Where a running line is attached to the structure, seek advice from the equipment supplier and the structural designer to make sure that the imposed loads can be sustained.

222 Where a mobile anchor or inertia reel system is used, minimise the number of workers approaching the leading edge to reduce the risk of tripping and snagging.

223 Remember that most inertia reel devices are designed for use only where the anchor point is directly above the user, ie in the vertical plane. This is to avoid problems such as poor inertia reel performance (allowing freefall to occur), the lifeline being cut or abraded over an edge, or pendulum swing. Therefore their safe application could be limited.

224 In any case personal fall-protection systems should not be your first choice when considering how to control risk from work at height. Avoidance, fall prevention (edge protection, MEWPs, scaffolds etc), and collective safeguards for reducing the height and mitigating the effects of falls (eg safety nets, airbags or mats) should be considered first (see Figure 33).

225 Temporary barriers will be needed to control access to areas where harnesses have to be worn. Where running line systems are used, strictly control access to the roof, eg during work breaks and at the end of the working day.

226 In most situations, additional measures (usually in the form of fall protection such as safety nets or harness and running line systems) are required to protect workers using trolley systems from falling through the gap created to lay a new sheet or through fragile material such as partially fixed liner sheets. Follow the manufacturer's recommendations on suitable anchorage points for running line systems. Horizontal guard rails on purlin trolleys or stagings are unlikely to be strong enough.

227 Trolley systems rely on the alignment of the supporting steelwork and the quality of the joints between purlins for the trolleys to run freely. Attempting to free trolleys that have jammed can be dangerous. They are not suitable where design details such as hips or dormers do not allow adequate support over the full length of the trolley.

228 For many reasons, trolley systems are often not practicable and should be used only where there is no safer alternative. Where trolleys are used:

- there should be a safe system for installing and/or assembling them on the roof specified in the method statement;
- the trolley attachment/locking system should be suitable for the purlin design;



**Figure 33** Use of safety nets during industrial roof work



- a safe system for moving trolleys should be established;
- the joints between the purlins must allow the trolley to slide freely. Even minor misalignment can cause the trolley to jam and lead to unsafe systems of work;
- there should be a safe means of access to the trolley;
- when used as edge protection, the trolley must always be locked in position; and
- if there is risk of falling from the end of the trolley, eg at an unprotected ridge, a suitable barrier should be provided.

### ***Material handling***

229 Material loads can be heavy due to the increasing thickness and length of components used. Manual handling should be avoided unless a robust risk assessment clearly shows that it is not reasonably practicable to do so.

# PROTECTING THE PUBLIC

230 The public may be at risk from falling materials or tools during roof work. Always take precautions to prevent materials falling where they may cause danger to anyone. This is particularly important where members of the public pass close to or below roof work. Where work has to be done and danger still exists, you may need to consider a pavement closure or diversion to make sure that the public are not put at risk for the duration of the work.

231 Appropriately designed birdcage scaffolds or debris netting can be used to retain falling materials. Whatever system you choose, it should be capable of retaining whatever is likely to fall. If material is stacked on a scaffold platform above the height of the toe board, proprietary brick guards will be needed to prevent material falling onto other workers or the public below.

232 Where the public pass below or near to the scaffold, then scaffold fans, tunnels or similar arrangements may be required. Figures 34(a)–(c) show examples of debris netting, scaffold fans and tunnels.

233 You should discuss the work proposed and measures to protect the public during the procurement of any scaffold. If at a later stage you need additional brick guards or debris netting you should consult the scaffolding installer about the increased wind loading and scaffold design.

234 Material may also fall through gaps in the working platform. Close boarding of the first lift of a scaffold or pavement gantry/tunnel, using either double boards with polythene sandwiched between or single boards, polythene cover and plywood cover, can be used to prevent any debris falling. Take care not to overload the scaffold. If there is any risk of drips of hot bitumen falling from the roof edge, physical protection or barriers at ground level may be necessary. See also Appendix 6.

A child walking along a pavement sustained head injuries when struck by a hammer dropped by a roof worker working on a residential property. A scaffold had been provided, but the edge protection was not adequate to contain falling materials.



**Figure 34(a)** Debris netting (image courtesy of Combisafe)

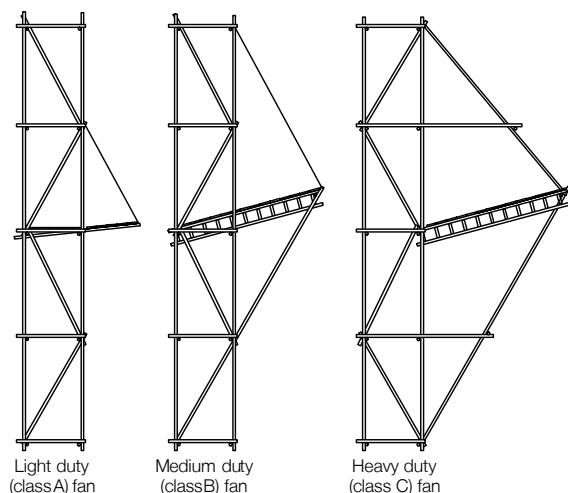

**Figure 34(b)** Scaffold fan classifications (permission to reproduce extracts is granted by BSI)



**Figure 34(c)** Tunnel

A member of the public suffered serious head injuries when he was struck by a falling slate. A terraced house was being re-roofed. No edge protection was provided, and no precautions were taken to prevent materials falling into the street.

235 Special precautions will be necessary where children may be put at risk (eg roof work at or near schools or play areas or to keep them off scaffolding). It is advisable for the company carrying out the work to contact the head teacher of the school to make them directly aware of the work and its location. Where possible, roof work at schools should be done in holidays.

236 Never throw waste materials (such as old slates, tiles etc) from the roof or scaffold (known as 'bombing'). Waste should be lowered in skips or baskets designed for the purpose, which will not spill material if snagged. Alternatively, you can use enclosed debris chutes (see Figure 6). Close off chutes to prevent their use when the skip below has been removed. Cover skips where necessary to protect the public from dust and flying materials.

237 Do not hoist materials over the public. Either:

- find an alternative place for hoisting, eg at the rear of the premises; or
- use an alternative means of raising materials; or
- choose a time when the footpath can be closed (by agreement with the local highways authority).

238 Where a bitumen or hot-melt boiler is sited at ground level, a suitable exclusion zone will be required so that the public cannot access the boiler area. This is particularly important when a school or other similar public building is being refurbished. Physical barriers are needed – not bunting or painted lines – and a responsible person must be in attendance at all times.

239 Further advice on protecting the public from the hazards of construction work is given in *Protecting the public: Your next move* HSG151.

# DEALING WITH HEALTH RISKS

240 Falls and other safety issues are not the only risks linked to roof work. There are some significant health risks as well. The most important ones are:

- manual handling;
- harmful dusts and chemicals; and
- vibration, noise and sun exposure.

241 Every year far more people are off work due to ill health caused in the workplace than as a result of any safety-related accident. Health risks need to be managed at least as well as safety risks. Do not wait for health problems to occur before putting in place control measures.

242 The main health risks that you need to be aware of are detailed below. For more information on these and other health risks go to: [www.hse.gov.uk/construction/healthtopics/index.htm](http://www.hse.gov.uk/construction/healthtopics/index.htm)

## Manual handling

243 Manual handling covers a wide variety of tasks including lifting, lowering, pushing, pulling and carrying. Common roof work tasks involve:

- loading out roof tiles;
- carrying mortar to roof level; and
- laying large roofing sheets.

244 If any of these tasks are not done properly there is a risk of accidents, injury and effects on health. This includes work-related musculoskeletal disorders (MSDs) such as back pain, upper and lower limb pain, and repetitive strain injuries of various sorts. Manual handling is one of the most common causes of ill health at work. Construction workers are particularly at risk and are off work due to back problems more than any other type of ill-health issue.

245 To help prevent MSDs try to avoid manual handling as far as possible. Ask, 'Does the load need to be handled manually at all?', or 'Can the work be done in a different way?' For example, can materials be delivered directly to where they are going to be used instead of being manually carried, pushed or pulled?

246 If manual handling cannot be avoided then think about whether the work can be automated, mechanised (see Figures 35(a)–(c) and 4(a)–(b)), or whether lifting equipment such as a gin wheel, gantry hoist or scaffold hoist can be used. Remember, the introduction of some solutions may introduce other risks that you will need to take into consideration.



**Figure 35(a)–(c)** Mechanical handling of large roof sheets (images courtesy of Advisory Committee on Roof Safety)

### ***Handling roof cladding***

247 Before work starts, designers and specifiers should consider reducing the length of roof sheets. This makes the sheets lighter and reduces their unwieldy nature, particularly against weather conditions when handled at height. These advantages should be considered alongside the need to minimise work on the roof during installation, maintenance and repair.

248 Alternatively, designers can specify oversized roof sheets and gutters so that it is not possible to handle them manually and they have to be mechanically handled. Mechanical handling is always preferable where it is possible (see Figure 4(a)).

249 Guidance on materials handling and storage for roof work involving steel frame buildings has been produced by the Steel Construction Institute.<sup>28</sup> It advises deliveries to be planned so that there is only the minimum need for storage on site without stopping progress of the work.



**Figure 36 (a)–(c)** 24-m long roof panels being mechanically lifted from ground level and installed on roof

250 However, there will still be some need to store materials on site. Where needed, the storage location should be:

- decided before delivery;
- as close as possible to where the materials need to be used;
- easily accessible; and
- away from any busy roads.

251 Wherever possible, offload materials directly from the delivery vehicle onto the roof. This avoids double handling of roof cladding packs and other materials.

252 When choosing where to store materials on the roof or scaffold, think carefully about where the load should go. Aim to minimise the need for further movement, but make sure the load does not damage the supporting structure or compromise others' safety.

### ***Handling composite roof panels***

253 Thicker and heavier composite roofing panels are now being used because of the laying of thicker insulation materials. These panels may be up to 30 m long and can weigh in excess of 250 kg. Installing these panels manually is dangerous and should not be undertaken. Handling teams are not appropriate as co-ordinating the workers is difficult.

254 Many types of mechanical handling equipment are available to avoid the need for manual lifting. Cranes, including mobile, telescopic and tower cranes, and self-erecting, trailer-mounted versions, are widely available for hire or purchase.

255 Figure 36(a)–(c) shows a mechanical means of lifting and positioning long roof sheets. This significantly reduces the amount of manual handling needed. Long sheets are delivered interleaved with alternate ones turned over before they are hoisted to roof level. A vacuum device is used to lift the sheets by crane. There are also types of large 'bags' which can be used to hoist large, heavy, flat materials.

### ***Other roof installation work***

256 As well as work on the roof structure and coverings, many other tasks are carried out on roofs. This includes more recent developments such as fitting wind turbines and solar panels. Think carefully about the best ways to mechanically lift and manoeuvre such items before the work is started.

## **Harmful dusts and chemicals**

257 Roof work can involve exposure to many different dangerous dusts and chemicals, which might be harmful on contact or give off toxic fumes and vapours. Avoid using and generating such hazardous substances where possible. Where this is not possible, use the least hazardous product available

that will perform satisfactorily and control the work to minimise the exposure to any harmful substances. Sometimes exposures cannot be avoided; to protect people it is very important to choose the safest method of work, considering the method of application. Remember also to use PPE such as masks and gloves, where appropriate, as a final barrier, and provide workers with appropriate information, instruction and training.

## **Asbestos**

258 Asbestos is the single biggest cause of work-related deaths in the UK. Asbestos-related diseases currently kill over 5000 people a year in Britain. However, as long as asbestos is in good condition and is not disturbed or damaged there is negligible risk. When disturbed or damaged, it can become a danger to health because asbestos fibres are released into the air and people can breathe them in. Although it is now illegal to use asbestos in the construction or refurbishment of any premises, many thousands of tonnes of it were used in the past in such things as insulation products for fireproof panels and in asbestos cement roofing material. Much of this material may still be in place. However, buildings built after 2000 are unlikely to contain asbestos-containing materials (ACM).

### **Identifying asbestos**

259 Everyone involved in roof work needs to be aware of ACMs, including clients, designers and contractors. Any asbestos in the proposed work area needs to be identified before work is commissioned and starts. This includes:

- the amount;
- where it is and what condition it is in;
- whether work is likely to disturb the material; and, if so
- how the material needs to be safely protected or removed.

260 For demolition and refurbishment work it is essential to get information from existing records (such as the client's survey, asbestos plan or register) and by commissioning a suitable survey before any construction work starts. The need to survey for asbestos and protect or remove it should be included in the initial project cost and programme.

### **Asbestos training**

261 Anyone who works with or is likely to come across ACMs needs to be aware of the risks. The minimum requirement is an asbestos awareness training course. This needs to cover the following topics:

- the properties of asbestos and its effects on health, including the increased risk of lung cancer for asbestos workers who smoke;
- the types, uses and likely occurrence of asbestos and ACMs in buildings and plant;
- the general procedures to be followed to deal with an emergency (eg an uncontrolled release of asbestos dust into the workplace); and
- how to avoid the risks of asbestos (eg no employee should carry out building work that disturbs the fabric of a building unless the employer has confirmed that ACMs are not present).

### **Common asbestos products**

262 Roof workers may come into contact with or disturb a number of ACMs. The commonest ones include:

- asbestos cement profiled sheets, flat sheets and slates;
- asbestos cement guttering and rainwater pipes;
- asbestos cement flue pipes passing through the roof;

- textured decorative coatings;
- asbestos-based felts and asbestos backing on metal sheets; and
- other products, such as floor tiles, mastics, sealants, rope seals and gaskets (in pipework etc), millboard, paper products, cloth (fire blankets etc) and bituminous products (roofing felt etc).

263 In general, work can be done on these products so long as workers have had training that includes safe work practices, control measures and protective equipment for working with these ACMs, and that the risk assessment for the work shows the concentration of asbestos fibres in the air will not exceed exposure limits.

#### **Licensed asbestos work**

264 There is a very high risk of asbestos fibre release when working on some roof materials. In particular, these include:

- insulation board (eg in soffits and roof linings);
- sprayed asbestos (eg on structural roof members and applied as a coating to asbestos cement sheets); and
- asbestos pipe insulation (eg in roof spaces).

265 Work involving these products is high-risk. The law requires it to be undertaken only by contractors with specialist knowledge, equipment and training who are licensed by HSE.

266 The HSE website ([www.hse.gov.uk/asbestos/index.htm](http://www.hse.gov.uk/asbestos/index.htm)) provides further information, including advice on:

- how to carry out work with ACMs;
- the type of controls necessary;
- what training is required; and
- what work must be carried out by licensed contractors.

#### ***Lead***

267 Lead remains a versatile and widely used material in roof work. It is used for flashing, rainwater goods and making difficult junctions watertight, as well as a roof covering in some instances. Working with lead can put workers' health at risk, causing symptoms including headaches, stomach pains and anaemia. Other serious health effects include kidney damage, nerve and brain damage and infertility. Roof workers can be exposed to lead when:

- carrying out hot work, cutting or joining lead materials; and
- removing or repairing old lead roofs.

268 Take into account any risks from lead before starting work. Where possible use alternatives such as glass-reinforced plastic (GRP), PVC, felt and plastics. Put in place steps to control exposure where lead is used. These include:

- good welfare, including hot water, soap and towel for washing hands and face;
- a place to eat and drink away from the work area;
- work methods that reduce the risk of exposure to lead fume and dust; and
- instruction and training for workers so that they understand the risks and the purpose of the control measures.

269 Employers should consult an appointed doctor about the medical surveillance that is appropriate for the work activities and workplace.



270 Lead can also present a manual handling problem due to its weight. Again, you can reduce this risk by using lighter alternatives such as GRP, PVC, felt or plastics. However, where lead is required, suitable mechanical lifting devices (such as hoists, cranes or appropriate gin wheels) should be used to eliminate or reduce the need to manually handle rolls of lead.

A client wanted a designer to produce a design with ornamental roof features. The initial intention was for the features to be made from cast iron, lead and copper, which would have required high-risk manual handling to lift them into position and fit them. Redesigning the features slightly allowed them to be produced as a single, lightweight GRP moulding, which could be easily lifted and bolted into place. The reduction in weight substantially reduced the potential for serious manual handling injury.

### ***Silica***

271 Silica is found in many types of stone and in concrete, including roof tiles. In dust form it will be released during cutting or grinding. Inhaling silica dust can lead to serious diseases, including lung cancer, and it is estimated that more than 500 workers die each year from these diseases due to silica exposure in the construction industry.

272 Even short periods of roof tile cutting can create high levels of silica dust. Where possible, cutting should be eliminated by using half- or one-and-a-half-size tiles. Where resizing is needed, use water to stop the dust getting into the air. Modern cut-off saws have an attachment for a water hose.

273 Do not cut tiles on the roof but in a designated, stable area set up for this purpose with appropriate local exhaust ventilation/extraction available. Avoid cutting directly on the scaffold boards.

274 Even with water suppression some silica dust will remain in the air and a mask should also be worn. Nuisance-grade dust masks do not protect the lungs; use either a FFP3 disposable mask or a half-mask with P3 filters. Wearers must be face-fit-tested to make sure the mask works correctly.

### ***Bitumen and asphalt***

275 Bitumen comes from natural heavy crude oil deposits or from petroleum refining. It is commonly used as an adhesive to bond reinforced bitumen membranes (RBMs) onto the deck or insulation board. The term is often interchanged with 'asphalt'.

276 Hot bitumen can create a number of health issues. These include:

- throat and eye irritation from the vapours;
- skin irritation/dermatitis; and
- burns.

277 These health issues can occur, in particular, where:

- natural ventilation is poor (eg by adjacent structures or when near to bitumen boilers);
- hot bitumen could get onto the skin when being used; suitable gloves and overalls need to be worn; or
- larger quantities of hot bitumen are being moved, particularly from the ground to the roof.

278 For precautions when working with hot bitumen see Appendix 6.

### ***Glues and solvents***

279 There are a variety of roofing products that use or contain glues and solvents. They can present risks through:

- breathing in vapours;
- contact with the skin or eyes; or
- eating and drinking food with contaminated hands.

280 The main effects are irritation of the skin, eyes and lungs; headache, nausea, dizziness and light-headedness. Exposure can damage co-ordination and increase the likelihood of accidents such as falling off ladders. Workers may lose concentration on important/difficult tasks and those affected may react more slowly to dangerous situations. Very high exposures can cause unconsciousness and even death; for example, where adhesives are used in unventilated confined spaces or where there is significant spillage. Many of these substances are also highly flammable.

281 The type of glues and solvents used will have a significant impact on the potential dangers. Because of this, designers should first consider whether a less harmful substance could be used. When selecting a glue or solvent it is important to find out about the risks linked to it. The information on the package label and the safety data sheet provided by the manufacturer should provide help on the control measures needed.

282 Possible control measures include:

- brush application rather than spraying;
- ventilation to dilute or extract the fumes;
- wearing a suitable and properly fitted mask;
- wearing suitable gloves to prevent skin contact; and
- adequate washing facilities.

283 Sufficient information, instruction and training will be needed to make sure that the risks and precautions are understood.

## Biological hazards

284 Not all hazardous substances are generated by work activities. Animal waste, decaying litter or pests may be found when people enter roof spaces and can cause ill health. Breathing in dust from dried bird droppings can cause psittacosis and contact through broken skin with rat urine can lead to Weil's disease (leptospirosis).

285 Do not use high-pressure water to remove droppings. This can cause dust from the droppings to get into the air where it could be breathed in. However, generally wetting down the work area is advised. Also consider containing the work area with plastic sheeting. If appropriate, use a P3 or FFP3 mask. Overalls should be worn, and replaced when they are soiled. Workers who may be susceptible to an infection should not be directly involved in the removal of droppings.

286 Leptospirosis enters the body through skin cuts and abrasions or through the mucous membrane lining of the nose, mouth and conjunctiva (eye). The organism may also be ingested via food or water contaminated by rat urine.

287 High standards of personal hygiene by provision and use of adequate welfare facilities are essential for controlling these risks.

## Welfare for all construction sites

288 Always provide good welfare facilities. They are the basis for controlling exposure to many common harmful substances. The minimum requirements of Schedule 2 of the Construction (Design and Management) Regulations 2015 are:

- washbasins with hot and cold or warm running water, in the immediate vicinity of clean and working toilets;
- sinks large enough to wash face, hands and forearms;
- soap and towels;
- somewhere to change, dry and store clothing;
- drinking water, and cups if needed; and
- a rest area to sit, make hot drinks and eat food.

289 Washing facilities should include showers if required by the nature of the work or for health reasons.

## Vibration, noise and sun exposure

### *Vibration*

290 Workers may be exposed to hand–arm vibration (HAV) when operating hand-held power tools such as cut-off saws or hammer drills. Regular and frequent exposure to HAV can lead to permanent ill health. Damage may occur to blood vessels, nerves and musculoskeletal structures. HAV can cause a range of painful and distressing symptoms including hand–arm vibration syndrome (HAVS) and carpal tunnel syndrome.

291 Where workers are exposed to HAV dangers, assess the extent of that exposure and either eliminate it or reduce it to as low a level as reasonably practicable.

292 Risk control should follow the hierarchy of using other work methods or equipment to prevent vibration exposure where possible. Otherwise, choose equipment with the least vibration exposure, ensuring that it is maintained and that parts are replaced as appropriate. Limit exposure times through work scheduling and rotations of tasks. Train the users of vibrating tools in the risks and how to minimise their exposure, and provide health surveillance where appropriate.

### Sources of vibration information

293 Information on the levels of vibration from the tools used should reflect normal use (ie equipment in use at work). Further guidance can be found at: <http://www.hse.gov.uk/construction/healthrisks/physical-ill-health-risks/vibration.htm>

### *Noise*

294 Frequent exposure to high noise levels causes irreversible damage to hearing, which may be accompanied by tinnitus (a sensation of noises or ringing in the ears). The longer the exposure and the higher the noise level, the sooner this damage will become noticeable.

295 Assess and control workers' exposure to noise from work activities. Once you have controlled risks to hearing to the lowest level practicable, provide hearing protection if risks remain.

296 Noise on construction sites usually comes from machinery and tools used for demolition, excavation or piling and from compressors and concrete mixers etc. Other operations, such as hammering, riveting and the use of cartridge-operated fixing tools, may also be a source of excessive noise. It is important to note that workers may be exposed to noise generated from other workers on a site – not just the noise that they themselves produce.

297 Manufacturers and suppliers of equipment have to provide information on the noise their equipment produces. Although loud noise is obvious, if someone has to shout to be heard at 2 metres away for part of the day, then there is likely to be damaging noise exposure.

### **Control**

298 Can the job be done in another way that does not involve using noisy equipment? If not, can you use quieter equipment that will get the job done in the most efficient way? Poor maintenance of tools can also lead to increased noise levels. Carrying out a noisy job well away from where other people are working will also help, as will moving workers out of the immediate vicinity and putting up signs to keep people out. Also give health surveillance to workers where there remains a risk to their health.

299 You can reduce noise levels by making sure the exhausts of compressors, generators and other plant are directed away from work areas. Screens faced with sound-absorbent materials can be placed around plant.

300 If it is not possible to eliminate the noise source or reduce the noise, provide workers with ear defenders (muffs or plugs). But remember that providing hearing protection is not a substitute for noise elimination and control at source.

301 Further guidance can be found at: <http://www.hse.gov.uk/construction/healthrisks/physical-ill-health-risks/noise.htm>

### ***Sun exposure***

302 Roof workers will be significantly exposed to sunlight. They are therefore at particular risk from heat exhaustion and the effects of ultraviolet (UV) radiation on the skin. Cancer of the skin is the commonest form of cancer, and simple precautions can significantly reduce the risks of skin cancer and heat exhaustion. For example:

- wearing suitable clothing, such as long sleeves and trousers made from high-wicking material with UV protection as well as head protection;
- using sunscreens of at least protection factor 15;
- taking suitable rest periods or rotating work to avoid lengthy exposures during the middle of the day;
- regularly drinking water; and
- wearing UV-resistant eye protection.

# TRAINING AND COMPETENCE FOR ROOF WORKERS

303 Roof work is potentially dangerous and roof workers need appropriate knowledge, skills and experience to carry it out safely and competently. When a contractor employs or appoints an individual to work on a construction site, they should make enquiries to ensure that the individual:

- has the skills, knowledge, training and experience to carry out the work they will be employed to do in a way that secures health and safety for anyone working on the site; or
- is in the process of obtaining them.

304 Passing the basic Construction Skills Health and Safety Test or an equivalent provides evidence of a threshold of health and safety knowledge appropriate for a new starter in construction.

305 Do not rely solely on industry certification cards or similar being presented as evidence that a worker has the right qualities. Nationally recognised qualifications, such as National Vocational Qualifications (NVQs) and Scottish Vocational Qualifications (SVQs), can provide contractors with assurance that the holder has the skills, knowledge, training and experience to carry out the task(s) for which they are appointed. Contractors should recognise that training on its own is not enough.

306 Newly trained individuals need to be supervised and given the opportunity to gain positive experience of working in a range of conditions.

307 Workers should be trained in safe working practices and health and safety issues specific to their trade. It is not enough to hope that they will 'pick up' safety on the job from other workers – they might simply be learning someone else's bad habits.

308 Training provided for roof workers should make sure that trainees gain an awareness of the following elements of health and safety knowledge:

- main provisions of the Work at Height Regulations 2005;
- the work-at-height hierarchy;
- interpreting risk assessments and method statements;
- fragile surfaces;
- edge protection;
- access and egress, eg stair towers and ladders;
- nets;
- manual handling;
- selection and type of work equipment, eg hoists;
- workplace inspections;
- scaffold awareness;
- asbestos awareness;
- harness training and inspection;

- rescue training;
- plant, eg MEWPs;
- environment, eg weather conditions;
- fitness to work; and
- tools and equipment.

309 Further specialist training will be required for specific types of roof work or for tasks such as tower scaffold erection, operating a MEWP, emergency rescue and net rigging.

310 Other workers, such as safety advisers, engineers, designers, quantity surveyors, maintenance staff and plant installers, also have to access roofs. They will need training in working at height (that reflects the activities they are expected to carry out) before they can be deemed competent to work on a roof.

311 Managers and supervisors need to be competent to deliver safety standards on site. To achieve this they will need health and safety training to:

- assess and prioritise the risks on a particular project;
- design safe systems of work that are appropriate to specific site conditions; and
- prepare clear, simple safety method statements that can be used and understood by site workers.

312 First-line supervisors need to be able to interpret a safety method statement and explain and follow a safe system of work.

313 Managers and supervisors who control roof work require specific training. For example, the Construction Skills 'Site Management Safety Training Scheme' five-day course for site managers, the two-day 'Site Supervisors' Safety Training Scheme', or equivalent courses.

314 Everyone who uses PPE should know how to use it effectively. For example:

- how to inspect the equipment to make sure that it will operate satisfactorily (see *Inspecting fall arrest equipment made from webbing or rope* INDG367);<sup>29</sup>
- how to fit and use a safety harness, following the manufacturer's recommendations; and
- how to check the face fit of a respirator or dust mask.

315 Every contractor carrying out roof work needs to make sure that a named individual is responsible for the health and safety functions. The named individual may need extra training in health and safety to meet their responsibilities properly. Contractors also need to have access to competent advice.

316 For further information on competence and training see the ACR's *Guidance note for competence and general fitness requirements to work on roofs*.<sup>30</sup> BS 8454:2006<sup>31</sup> also provides guidance and recommendations on the delivery of training and education for work at height, including rescue.

# CONSTRUCTION (DESIGN AND MANAGEMENT) REGULATIONS 2015

317 The Construction (Design and Management) Regulations 2015 (CDM 2015) apply to all construction projects. This section describes what dutyholders – clients, principal designers, designers, principal contractors and contractors – need to do to comply with CDM 2015.

318 HSE has produced guidance on CDM 2015 which can be consulted for more detail – *Managing health and safety in construction. Construction (Design and Management) Regulations 2015 (L153)*.

## The role of the client

319 A client is anyone who has construction work carried out for them. There are two types of clients:

- **Commercial clients** have construction work carried out as part of their business. This could be an individual, partnership or company and includes property developers, landlords and companies managing domestic properties.
- **Domestic clients** have construction work carried out for them but not in connection with a business – work is done on their own home or the home of a family member. CDM 2015 does not require domestic clients to carry out client duties as these normally pass to other dutyholders.

320 Clients, including those who own, occupy or have responsibility for a building, have an important role to play when arranging for roof work to be done. This includes considering the design and specification of a new building, appointing a contractor for refurbishment or organising an emergency repair.

321 The main duties of the client are to ensure that:

- there is enough time and other resource for the project;
- health and safety on their project is suitably managed;
- welfare facilities are provided on site;
- pre-construction information is provided to designers and contractors as soon as practicable; and
- where two or more contractors are likely to be working on the project, a principal designer and a principal contractor are appointed.

322 If the client fails to appoint a principal designer and/or a principal contractor, they must fulfil the duties of the principal designer and/or the principal contractor and ensure that:

- a construction phase plan is drawn up by the contractor;
- the principal designer prepares a health and safety file for the project.

323 Anyone responsible for appointing designers (including principal designers) or contractors (including principal contractors) to work on a project must ensure that those appointed have the skills, knowledge and experience to carry out the work in a way that secures health and safety.

324 The client should make sure that relevant pre-construction information is provided to anyone who needs it, so that work can be carried out safely.

325 The pre-construction information should cover:

- the major health and safety risks on the project;
- whether significant resources are needed to control these risks; and
- what specific competencies are required to carry out the work safely.

326 This could include information on:

- what an existing roof is made of;
- the age of an existing roof;
- previous modifications to an existing roof;
- the condition of the existing roof including its structure, covering and interface with other buildings, and rainwater goods;
- information on the structural condition of adjoining areas if removing the roof could compromise other weak parts of the building;
- existing arrangements for access to the roof;
- restrictions on availability of space for cranes;
- any relevant permit-to-work arrangements operated by the client;
- fire precautions on an occupied site; and
- areas where contractor access is prohibited.

327 If clients dictate the design details (eg that specific materials will be used) then they should comply with the duties placed on designers by CDM (see paragraphs 339–344).

328 Clients should take reasonable steps to make sure that the contractor's arrangements for managing the project allow the work to be carried out without risks to health and safety.

329 A construction phase plan is required for every construction project and is aimed at helping contractors plan and organise a job, and co-operate with others involved to make sure the work is carried out without risks to health and safety. It will include essential information such as key dates, build stages, and the identification of main dangers as well as explaining how important health and safety information is communicated to others.

330 If the construction project will last longer than 30 working days and have more than 20 workers working at any time or exceed 500 person-days HSE must be notified of the project. The client is responsible for completing the notification form (F10), which can be found on the HSE website (<https://www.hse.gov.uk/forms/notification/f10.htm>).

331 Unrealistic building or refurbishment programmes can lead to undue pressure on people carrying out the work. This can make it harder for contractors to plan for safe working, to prepare high-quality safety method statements and to review and amend systems of work. Clients have an important role here – they must not place unreasonable demands on the project.

## **The role of the principal designer**

332 The principal designer is an organisation or an individual in control of the pre-construction stage of a project with more than one contractor. During the pre-construction stage, design



elements can greatly affect the health and safety of people working on the project, and therefore a principal designer plays an important role in the management of health and safety throughout.

333 The principal designer should have:

- the technical knowledge of the construction industry relevant to the project;
- the skills, knowledge and experience to understand, manage and co-ordinate the pre-construction phase (in the case of an organisation, the organisational capability to carry out the role).

334 Principal designers must:

- plan, manage, monitor and co-ordinate health and safety in the pre-construction phase. In doing so they must take account of relevant information (such as an existing health and safety file) that might affect design work carried out both before and after the construction phase has started;
- help and advise the client in bringing together pre-construction information, and provide the information designers and contractors need to carry out their duties;
- work with any other designers on the project to eliminate foreseeable health and safety risks to anyone affected by the work and, where that is not possible, take steps to reduce or control those risks;
- ensure that everyone involved in the pre-construction phase communicates and co-operates, co-ordinating their work wherever required;
- liaise with the principal contractor, keeping them informed of any risks that need to be controlled during the construction phase.

## The health and safety file

335 The health and safety file is required only for projects involving more than one contractor.

336 During the pre-construction phase, the principal designer must prepare a health and safety file appropriate for the project. It must contain information relating to the project that is likely to be needed during any subsequent construction project to ensure the health and safety of any person.

337 The principal designer must make sure that the health and safety file is appropriately reviewed, updated and revised from time to time to take account of the work and any changes that have occurred.

338 During the project, the principal contractor must provide the principal designer with any information in the principal contractor's possession relevant to the health and safety file, for inclusion in the health and safety file.

## The role of the designer

339 Using their professional skills and judgement, designers can eliminate hazards at source and make risks easier to manage. This helps contractors to provide a safer place of work on the roof. Designers need to consider initial construction work as well as future maintenance, cleaning, proposed use and demolition requirements.

340 Under CDM, designers have a duty to eliminate hazards that may give rise to risks, and to reduce the risks from any remaining hazards so far as is reasonably practicable. Designers should also:

- make sure clients are aware of their duties;
- make sure that they themselves are competent;
- co-ordinate their work with others as necessary to manage risk;
- co-operate with the principal designer and others; and

- provide information for the health and safety file.

341 Designers have to avoid foreseeable risks, so far as is reasonably practicable, by:

- eliminating hazards from the construction, cleaning, maintenance, proposed use (workplace only) and demolition of any structure;
- reducing risks from any remaining hazard; and
- giving priority to design solutions that provide collective protection for all, rather than individual protection.

342 To avoid all foreseeable risks designers could, for example:

- eliminate unprotected fragile materials;
- eliminate or, where this is not possible, minimise the need for work at height during construction;
- eliminate or minimise inspection and maintenance requirements for the completed roof structure;
- identify and design in safe access and a safe place of work for maintenance and cleaning (see Figure 37);
- carefully consider where to site plant that will need maintenance. Are there alternatives to placing it on the roof? If not, is it in the best position on the roof for providing safe access?
- carefully consider the siting of roof lights and how they will be protected should access be necessary in the future;
- provide clear and unambiguous specifications for safety-critical elements of the design; and
- provide information relevant to construction and maintenance for inclusion in pre- construction information, tender documentation and in the health and safety file.

#### **Example of risk elimination through design**

On the major refurbishment of a large hangar, the fragile asbestos cement roof was replaced by load-bearing metal sheets. After consultation with the client, the roof lights were replaced by translucent vertical panels below eaves level. This reduced the risk of falls during re-roofing and any subsequent maintenance (see Figure 38).

#### **Examples of reduction/control of risk through design**

The designer of a new shopping centre with a glass atrium recognised the risk of falling during cleaning and maintenance of glazed areas. An access system using mobile gantries was designed and installed and an inspection regime established for the equipment.

The designer of a 'built-up' industrial roof made sure that all components, eg liner panels, top sheets, insulation and fixings, were the same modular width. This reduced the risk to roof workers. They were able to adopt a system of work that restricted the area of temporarily fixed liner panels to a single sheet width.

343 Outcomes such as those in the examples above are easier to achieve if there is good liaison between:

- designer and client, eg on access requirements for maintenance; and
- designers, contractors, specifiers and installers.

344 The designer should make sure that the client is aware of their duties under CDM.

345 Paragraphs 346–363 provide more detailed design guidance for particular roofing applications.

### ***Designing flat and low-pitch roofs***

346 Access to these roofs is often simple and because they are flat it is easy to walk around on them. Accidents happen not just to roof workers but also to engineers, surveyors, children, caretakers etc. The priority is to design out the risk at source, eg by specifying adequate built-in edge protection. Designers should consider the alternatives available in terms of their effectiveness in preventing falls, as well as cost, aesthetics and ease of build.

#### **Edge protection**

347 Edge protection options in order of effectiveness are:

- designed parapet (see Figure 39);
- guard rail at the roof edge (see Figure 40);
- permanent protected walkway for access to plant on the roof (see Figure 37);
- pre-formed sockets to support temporary edge protection guard rails; or
- running line (rigid and flexible-line horizontal restraint/fall-arrest systems) systems designed, installed and tested to the relevant standards (see Appendix 3).

348 Designers should take account of the provisions of the Workplace (Health, Safety and Welfare) Regulations 1992 if they are designing any structure that is to be used as a workplace.

### ***Designing industrial roofs***

349 The most important issue for designers is how to eliminate unprotected fragile material at height. Designers should carefully consider the potential to eliminate or reduce this hazard.



**Figure 37** (left) Permanent walkway giving safe access on a fragile roof (this walkway was retrofitted, but similar access can be included in initial designs)

**Figure 38** (above) Lighting panels installed in the wall rather than the roof

350 Whatever roof light and roofing sheet systems are used, test the assembly to determine fragility and pass the relevant information on to anyone who may need it (see Appendix 4).

351 The health and safety file should include relevant information from the supplier, such as:

- test results on the initial material strength;
- the effects of UV radiation on material properties; and
- fixing specifications, including type, number and position.

### Roof lights

352 For roof lights designers should carefully consider the potential to eliminate or reduce this hazard. The decision on whether to include roof lights should take account of the risks associated with temporary gaps during construction, and the risks when access to the roof is needed later, eg during inspection, maintenance or cleaning.

353 Where roof lights are required designers should consider:

- specifying non-fragile roof lights;
- fitting roof lights designed to project above the plane of the roof and that cannot be walked on (these reduce the risk but they should still be capable of withstanding a person falling onto them; see Figure 41);
- protecting roof lights, eg by means of mesh or grids fitted below the roof light or between the layers of a built-up roof light (see Figure 42); or
- specifying roof lights with a design life that matches that of the roof, taking account of the likely deterioration due to UV exposure, environmental pollution and internal and external building environments.

354 Where existing fragile roof lights are present, covers can be retrofitted (see Figure 43).

### Roofing sheets

355 The safest option for roof sheets is to specify a material that will be non-fragile for the design life of the roof. The norm should be to specify non-fragile roof sheets unless there are particular design requirements that dictate other materials. These design criteria should be clearly documented.

356 Consider the specification of reinforced fibre cement sheets. These should still be considered fragile and appropriate precautions are needed when people work on or near them. However, they offer a less fragile alternative to non-reinforced sheets.



**Figure 39** Parapet edge protection included as an integral design feature



**Figure 40** Permanent guard rail retrofitted during refurbishment work. Similar protection can be included in initial designs (image courtesy of Safesite Limited)

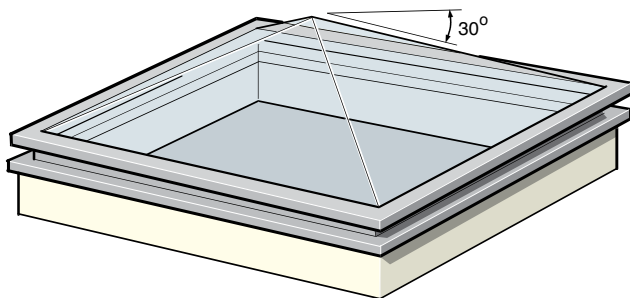

**Figure 41** Typical 'out of plane' polycarbonate roof light

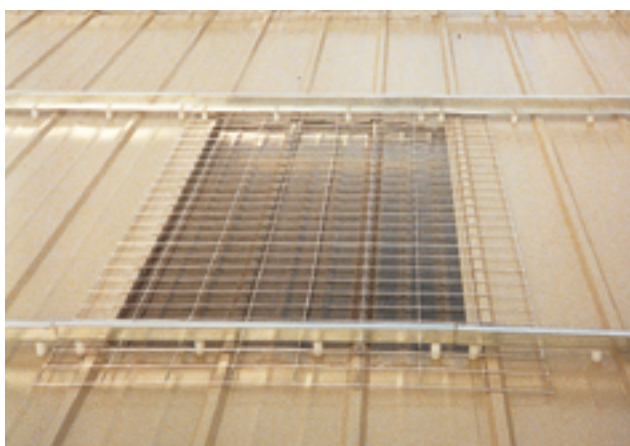

**Figure 42** Galvanised mesh reinforcement between sheets of twin-skin roof light



**Figure 43** Covers can be fitted to existing roofs or included as part of the design (image courtesy of Safesite Limited)

357 There are usually times during the laying of a built-up roof when coverings are not load-bearing, eg when not fully fixed. Designers need to consider this carefully and aim to eliminate or minimise this condition. The specification of liner sheets (thickness and profile) and, equally important, the fixing method should be assessed with these criteria in mind. The designer should supply precise information on the fixing configuration(s) that are load-bearing for a particular span and cladding material combination (see Appendix 4) so that contractors can develop a safe system of work.

A roof worker was working over a temporarily fixed roof liner panel, putting in permanent fixings. He fell 10 m to his death when the end of the sheet buckled under his weight.

358 Composite roof sheets are quicker to fix and are often immediately load-bearing independent of fixings. However, safe systems of work for handling these heavier sheets will need to be

developed and the designer should consider this hazard and potential solutions (see paragraphs 243–256).

359 Handling very long roofing sheets can be dangerous for roof workers and others, even in moderate winds. Designers need to decide the maximum wind speed in which these sheets can be laid. They then need to find out about likely local weather conditions and this should indicate whether the proposed sheet lengths are appropriate or not. See the advice on weather conditions given in paragraphs 64–70.

### **Roof maintenance**

360 Designers can help to reduce the amount of work done at height throughout the life of the structure. For example, they could:

- increase the maintenance life of roof elements;
- locate plant and equipment at low level wherever possible; and
- design gutter detailing to reduce blockages.

### ***Co-operating with others***

361 Good liaison between designers can achieve better standards at all stages of the work. A practical example is the effect of gutter design on systems of work when the roof is laid. Roof workers and others commonly use gutters for access at eaves level along the roof. Gutters should be used as access only if the structural strength of the gutter and the quality of the fixings are suitable and sufficient. Areas used for access at height must be stable, strong enough and of sufficient dimensions to allow safe passage of people and any plant or materials they require and be fitted with handrails or other means to prevent falls. Problems can often be avoided if designers consult each other and one takes into account means of access if it will be required for some users.

362 There are a number of issues where the design of the frame of the structure directly affects the roof workers' systems of work. For example:

- if running lines are to be used during erection, anchorage points need to be designed into the frame at appropriate points;
- the design and sizing of purlins and the alignment of the joints between purlins can determine whether a trolley system can be used successfully;
- the position of anti-sag rods can affect systems of work; and
- the design of eaves beams affects the installation of nets and edge protection.

Resolving these issues requires close co-ordination between frame and cladding designers.

### ***Designing trussed roofs***

363 Designers of trussed roofs can contribute to safe working by:

- designing both permanent and temporary bracing so that it can be fixed from a safe place;
- designing slinging points and lifting attachments, which allow truss bundles to be unslung from a safe place such as the eaves scaffold;
- designing permanent bracing to allow trusses to be pre-assembled into complete roof structures or modules on the ground and lifted into position;
- specifying slinging points for such assemblies; and
- giving information on the bracing required before a working platform can be supported by the trusses.

## The role of the principal contractor

364 Principal contractors set the practical on-site safety standards and make sure that they are followed. They should:

- make sure that all those they appoint are competent for the type of work;
- make sure that the overall work programme gives enough time for work to be done safely by the roofing subcontractor, taking account of likely weather conditions;
- allow time to consider method statements and liaise with the client and principal designer on the implications of design changes;
- devise a work programme that reflects the need to control access to areas below roof work where there is danger of falling materials;
- clearly specify at the tender stage the resources allocated to control and manage risks such as falls from height; and
- make sure that relevant information is passed to the roofing contractor.

365 Principal contractors need to make sure that a suitable construction phase plan is in place before construction starts. The plan should state how health and safety will be managed during the construction phase, identify risks specific to the type of work, and include suitable and sufficient measures to address the risks, including any site rules. Any work at height is potentially high-risk, so the plan should include enough detail for the risks to be controlled.

366 The principal contractor may require contractors to submit written safety method statements. The method statements can help the principal contractor assess the contractor's competence, and can help plan and co-ordinate work on site to minimise risks to health and safety for all site workers. Where written safety method statements are submitted, the principal contractor should have arrangements to review and approve them.

367 Principal contractors need to monitor contractors to make sure they comply with the construction phase plan and should take positive action to remedy matters if risk is not being effectively controlled.

## The role of the contractor

368 Contractors need to:

- implement a safe system of work. A site-specific safety method statement can help with this;
- make sure that they and their employees are competent to carry out their specific tasks safely, including supervision on site;
- co-operate with the principal contractor, and help develop and implement the construction phase plan; and
- produce a construction phase plan if they are the only contractor (see paragraph 365).

# APPENDIX 1 ISSUES FOR METHOD STATEMENTS IN ROOF WORK

1 This appendix is not a method statement. It lists the issues that method statements need to cover for roof work.

2 Working on any roof can be an extremely hazardous activity and requires close attention to detail at all stages. There should be a job-specific method statement in writing, agreed and understood by all parties before work starts. Rigorous monitoring and supervision are needed to make sure that the agreed method is followed in practice. There should also be a system to allow necessary changes to be made and confirmed.

3 Method statements should be clear, concise and include simple sketches where necessary.

4 Except for the simplest jobs, where the necessary precautions are straightforward and can be easily repeated (eg using a proper roofing ladder to replace a ridge tile), you should prepare method statements relating specifically to the job in hand. They should clearly describe the precautions and systems of work identified during the risk assessment. Everyone involved in the work needs to know what the method statement says and what they have to do – if they cannot understand the precautions or systems then they should not carry out the work. Make sure you have arrangements for supervision during the work to check that procedures are followed.

5 The method statement should cover the following areas:

- safe access;
- edge protection and other fall prevention such as working platforms;
- fall mitigation systems such as nets or airbags/beanbags and rescue plans if necessary;
- fragile materials;
- reducing the need for workers to move about the roof, eg by arranging for the right materials to be lifted to the right place at the right time;
- making sure that warning signs are displayed on existing roofs, particularly at roof access points; and
- supervision.

## Further information

6 The general questions listed in Table 3 are particularly relevant to low-pitch industrial roofs consisting of liner sheet, insulation layer and profiled metal top sheet. Non-standard or unusual systems will need further consideration. You may also need to address risks specific to an individual site (eg the presence of overhead power lines). This is not an exhaustive checklist, but is intended to act as a prompt when method statements are prepared and reviewed.



7 The Construction Industry Advisory Committee (CONIAC) has produced *Safety Steps*, a range of guidance documents to assist those planning work-at-height activities. See [www.accessindustryforum.org.uk/safety-steps](http://www.accessindustryforum.org.uk/safety-steps). These documents can be freely used to assist with preparing training materials, such as tool box talks, and educational campaigns. They can also be used as a tool to review adequacy of existing policies and procedures.

**Table 3** Checklist for preparing method statements for low-pitch industrial roof

Risk of falling, eg getting on/off ladders at eaves	<p>Access to roof:</p> <p>Have you discussed access points with the roofing team to reduce travel over the roof to a minimum?</p> <p>If ladders are used (as opposed to tower scaffolds or stair towers, which are preferred), is equipment available for hoisting or craning components up?</p>
Risk of falling when walking past open edges to fetch materials	<p>Materials handling:</p> <ul style="list-style-type: none"> <li>■ How are roofing packs loaded out onto the roof?</li> <li>■ Is this planned to reduce travel when fetching sheets and does it allow for protected routes/ safe access?</li> <li>■ Splitting packs of different sheet size and reassembling them at ground level can save travel at height. Back-loading sheets onto the completed roof can reduce travel past open edges.</li> </ul>
Risk of falling from the building when unslinging	<p>Cranes:</p> <ul style="list-style-type: none"> <li>■ If one is used, who will accept the load or unslung it?</li> <li>■ How will they be protected from falling?</li> <li>■ Have you considered using mobile access equipment for this task?</li> </ul>
Risk of falling outside the building frame exists at all stages of work. Gable ends are particularly hazardous	<p>Edge protection:</p> <ul style="list-style-type: none"> <li>■ Does the programme make sure that eaves, gable ends and other open edges are protected before work starts? Protection will also be required at ridges unless work progresses at the same rate on both roof slopes.</li> <li>■ What are the access arrangements for workers installing edge protection?</li> </ul>
Risk of falling on both sides of gutter, ie inside and outside the building frame	<p>Gutter fixing:</p> <ul style="list-style-type: none"> <li>■ How will workers be protected from falling? Peripheral edge protection erected for roof workers will not be sufficient at this phase.</li> <li>■ Has the use of mobile access equipment been considered as a priority?</li> <li>■ If the use of a running line or harness and lanyard is specified, who will erect and test the line, and are workers properly trained and competent in their use?</li> </ul>

<p>Risk of falling from partly completed roof</p>	<p>Leading edge protection:</p> <ul style="list-style-type: none"> <li>■ How will you protect the leading edge? Has the use of safety nets been considered in the light of legal duties and risk assessment for the total roofing operation?</li> <li>■ Stagings used as working platforms should be stable and of adequate width with handrails/running lines specified to suit the working practices.</li> <li>■ Work done while kneeling or bending needs careful attention as the worker's centre of gravity can extend over the leading edge.</li> <li>■ What method is specified for moving stagings?</li> <li>■ Is the method of work to be adopted when laying the first sheet specified? Some architectural features, eg hip ends, will require the working methods to be modified. These should be fully described.</li> <li>■ Has fixing ridge capping/flashing been included in the system of work? Is effective edge protection provided at the gable end of the ridge?</li> <li>■ Does the method statement make it clear at what stage of construction materials such as liner panels become load-bearing? The number and type of fixings required should be stated. Until this is achieved, they must be treated as fragile materials, ie unable to sustain someone's weight, and protection should be provided as above.</li> <li>■ Have any fragile materials been specified by the designer? If so, the principal designer should review the decision as a matter of urgency in terms of duties under CDM.</li> <li>■ For refurbishment work on existing roofs, are there any fragile materials on the roof? These will have to be protected. How will this be achieved? If covers are used, are they strong enough, taking account of the span required? How will they be fixed and what is the system for their removal?</li> <li>■ Zoning the roof into working and non-working areas can reduce the number of fragile areas that need to be protected. Specify the system for marking out the zones and for doing the work. If barriers marking the edge of the zones are within 2 m of fragile material, then they should be a continuous physical barrier – painted lines and warning tape are not suitable.</li> <li>■ Zoning should take account of travel to the working area by the roof workers and the need for materials to be moved around the roof. The system should protect all fragile areas within working zones and adjacent to access routes.</li> </ul>
<p>Systems control</p>	<p><b>Communication:</b> What are the arrangements for communicating the method statement and agreeing it with the roofing team?</p> <p><b>Supervision:</b> What are the arrangements for making sure that the work proceeds according to the method statement?</p> <p><b>Modifications:</b> What are the arrangements for agreeing any modifications to the method statement and communicating them to the roofing gang?</p> <p><b>Validation:</b> What are the arrangements for making sure that the company safety adviser or other nominated competent person has reviewed, and is satisfied with, the system of work proposed?</p>

# APPENDIX 2 USE OF SAFETY NETS

- 1 Safety nets can be employed effectively to reduce the distance of potential falls and to minimise their effects. They offer collective, passive safety as they protect everyone working within their boundary without those workers having to act to be protected. They allow a broad range of activity to continue with minimum restriction.
- 2 Safety nets have high energy absorption, and offer a 'soft landing' that minimises injury. Always fit them as close as possible to the underside of the working platform to minimise the distance and consequences of a fall.
- 3 Allow adequate clearance below the net for it to function properly and avoid the risk of the faller striking objects or the floor before being arrested. Limits are specified in BS EN 1263-2<sup>34</sup> and BS 8411.<sup>33</sup> This is generally referred to as 'clearance distance'.
- 4 Lightweight, square mesh nets offer the flattest span (less than 10% sag). In most roof work it is possible to position such a net so that, even at the point of maximum sag, it is less than 2 m from the roof surface. In this position the net is an effective guard – this standard should be reached wherever possible. Riggers should always aim to rig safety nets as close as possible to the roof surface.
- 5 Safety nets overlaid with an appropriate fine-mesh debris cover can also protect people who have to work or pass below. Think about the type of materials likely to fall, such as fixings or tools, when choosing the overlay material. Safety nets also have the advantage that materials are contained by the net and do not bounce.
- 6 While safety nets are designed to catch people, they can also be used to retain or control debris – although debris within the net can also injure anyone subsequently falling into it. The effect of debris in the net will depend on the mass, shape, nature and falling height of the debris. Therefore if it is assessed that debris might fall into the net and cannot be regularly cleared, obtain advice from a competent person as to any limitations that should be observed. Following the impact of any heavy objects into the nets, take the nets out of service for checking or testing, and repair them when necessary.

7 Safety nets can be used effectively:

- to minimise injury due to falls from leading edges, through liner panels or through temporarily fixed materials in new-build roofing;
- to guard roof lights and fragile roof materials during cleaning, maintenance and replacing the roof; and
- to minimise injury from falls during roof truss erection, eg when fitting diagonal bracing.

### Relevant standards

8 Safety nets should be manufactured to the requirements of European Standard BS EN 1263-1.<sup>32</sup> They should be erected in accordance with BS EN 1263-2<sup>34</sup> and the guidance given in BS 8411.<sup>33</sup>

9 There are four types or systems of safety net. ‘System S’ nets (used in the horizontal plane) are the type normally used to protect roofers.

10 When rigging safety nets it is important to maintain their energy-absorbing characteristics. If there are too many fixing points the net will become more rigid and impose larger loads on the user, the structure and the net itself. Too few fixing points and the net will sag and deflect too much under load. Follow the manufacturer’s recommendations and BS EN 1263 on the number and spacing of fixing points. Check that the supporting structure is capable of resisting the expected anchorage loads.

11 Always rig safety nets as close as possible to the working level. Install nets in accordance with BS EN 1263-2. Where reasonably practicable, they should be not more than 2 m below the working level. Where safety nets conforming to Class A and in system ‘S’ are subject to falls greater than 2 m, their individual area should be not less than 35 m<sup>2</sup> and their shortest side should be not less than 5 m. Where you cannot meet either of these two criteria use a Class B net. Safety nets of smaller areas should be installed only after consultation with a competent person.

12 When using attachment devices, seek advice from the manufacturer and check the rigger is competent working with these devices.

**Table 4** Fall heights and catching widths

Fall height	Catching width
<1.0 m	>2.0 m
<3.0 m	>2.5 m
<6.0 m	>3.0 m

### Anchorage points

13 An individual anchor point capacity of 6 kN, applied at 45° to the horizontal, should be available with a combined capacity over an adjacent series of anchor points of 4 kN, 6 kN and 4 kN. In general, purlins, sheeting rails and tube and fitting handrails will not meet these requirements, although evidence to demonstrate otherwise from a competent person may be appropriate.

14 When installing safety nets in phases the safety net must extend beyond the leading edge of the work by at least 3 m to allow for the likely horizontal trajectory of anyone falling from that edge.

## Erection

15 Safety nets can be connected to the structure by tie ropes, attachment devices (some of which may be rigged remotely from the ground) or specially designed attachment points on the structure.

16 Assess the risk to riggers erecting, moving and dismantling nets and establish a safe system of work. At all times follow this hierarchy:

- install nets remotely from ground level without working at height;
- use MEWPs;
- use ladders for short-duration work upon completion of a risk assessment;
- use specialist rigging techniques;
- roped access techniques may be appropriate in some buildings. This is specialised work and should be undertaken only by workers/contractors trained and competent to carry it out (see *IRATA International code of practice for industrial rope access*).<sup>35</sup>

17 Workers who erect nets should be aware of the relevant standards, trained and competent to carry out the work safely.

## Rescue

18 It is important to have a rescue plan in place before rigging nets. This plan must be workable, with necessary equipment available for use. In many situations, the rigging contractor is not on site when someone may need recovery. The responsibility for making sure a person can be rescued rests with the principal contractor (where CDM applies) or the person in control of the site.

19 Safety nets and attachment systems should be properly maintained by a competent person (usually employed by the rigger). Ideally there should be an audit trail from the manufacturer through to the last use. Document this information and keep it readily available for inspection.

## Repairs

20 Safety nets should be repaired only by a competent person. It is best practice to carry out repairs away from the site in a controlled environment, with each repair documented and information readily available for inspection. Use tags or affix labels to the repair to aid identification on site.

## Further information

21 Further information on safety nets is available from the Fall Arrest Safety Equipment Training (FASET) association at [www.faset.org.uk](http://www.faset.org.uk)

# APPENDIX 3 USE OF PERSONAL FALL-PROTECTION SYSTEMS

1 Personal fall-protection systems are at the lower end of the work-at-height hierarchy. First consider avoidance, fall prevention (eg guard rails, MEWPs or scaffolds) and collective safeguards (eg airbags or beanbags). The two most common types of personal fall-protection system used in roof work are work restraint and fall arrest. The most important points are summarised below.

2 For guidance on other types of personal fall protection (such as work positioning or rope access), you should seek the advice of individuals or companies who are trained and experienced in the use of such techniques.

## Selecting precautions

3 When selecting the precautions to use to protect against falls from a roof, you must follow the hierarchy of measures set out in Hierarchy for work at height (paragraphs 16–17). When applying the hierarchy to a personal fall-protection system, consider the relevant features of work-restraint and fall-arrest systems set out in Table 5.

## Training and supervision

4 A personal fall-protection system relies on the user's competence and discipline to make sure it is used consistently and effectively. Supervising people under your control is as important as training them.

5 Personal fall-protection systems are not foolproof and their safe use is not always common sense. Without proper training in fitting, use, maintenance, installation and equipment limitations, all that a system can provide is a false sense of security.

6 Give adequate information, instruction, training and supervision when a personal fall-protection system is used; for example, how to:

- select the correct product(s) for the work situation;
- wear a harness and adjust it to the body;
- use and adjust a lanyard and other equipment;
- self-rescue or assist others after a fall;
- inspect any equipment and recognise significant defects;
- assemble any system(s) correctly; and
- recognise the system and attach it safely to approved anchor points.

7 The initial training can be provided by the supplier of the personal fall-protection system or by trainers who have been trained and assessed by the equipment supplier(s). Assess the trainees' competence by getting them to do some typical tasks.

8 Provide refresher training at appropriate intervals, then assess the trainees' competence by again getting them to do some typical tasks at height.

9 Do not expose trainees to additional risk while they do tasks during training. Before they begin training, the training organisation should carry out a risk assessment and put in place any necessary control measures, such as a back-up or secondary safety rope.

## General considerations

10 There are a number of elements to a personal fall-protection system: typically an anchor point, a connecting element such as an adjustable or fixed length lanyard, and a full body harness.

Examples include:

- an energy-absorbing lanyard, a full body harness and a suitable and sufficient anchorage and anchor;
- a horizontal anchor line with multiple anchor points that can accommodate several workers using full body harnesses and energy-absorbing lanyards;
- a retractable type fall arrester, a full body harness and an anchor device, eg a sling that can be tethered to structural steelwork (the steelwork must be suitable for the attachment of a fall-arrest system).

11 Make sure that all of the elements are compatible with each other. You may need to check with the manufacturers and/or suppliers as to the compatibility of the elements that make up your chosen system.

12 Take into account the size, mass and number of users when you select the appropriate fall-protection system. Refer to the manufacturer's user instructions for advice.

13 Most of the elements that make up a personal fall-protection system should be tested and conform to the requirements of the relevant European standards and carry a CE mark, accompanied by the notified body's registration number. However, some anchor systems of types A, C and D may not be CE-marked, in which case they should conform to BS EN 795.<sup>36</sup>

14 The safe performance of a personal fall-protection system depends on it being connected to a suitable anchorage and anchor device. If someone falls and the anchor and/or anchor device fails, the system will be of no benefit at all. Verify (by calculation or testing) the suitability of the anchor device and its supporting structure to withstand the imposed loads and particularly any fall-arrest loads without the risk of failure.

15 For example, a guard rail forming part of an edge protection system will have enough structural strength to act as edge protection. However, it is unlikely to have been designed to withstand the dynamic forces resulting from fall arrest. Before it is used as an anchor point for a fall-arrest system, have its strength assessed by a competent engineer.

**Table 5** Features of work-restraint and fall-arrest systems

Work restraint system	Fall arrest system
Prevents falls	Minimises the distance and/or consequences of a fall
Provides personal protection – not collective	Provides personal protection – not collective
Is an active system – not passive	Is an active system – not passive

16 When you are using horizontal anchor lines (sometimes referred to as 'running lines'), it is important to limit the number of workers to that prescribed by the manufacturer, and to obtain performance calculations of end forces before use. This is because forces in horizontal anchor lines

can be magnified many times at the anchor points in the event of a fall. In addition to the number of workers, take into account their mass and the length of lanyard designed for the system.

## Inspecting equipment and anchors

17 All parts of a personal fall-protection system should be subject to an inspection regime that includes pre-use checks and periodic detailed examinations. It may also require additional interim inspections.

18 Keep equipment clean and dry, and store it properly. Dry any wet equipment thoroughly before storage. Do not alter or repair equipment unless this has been authorised by the manufacturer.

### *Pre-use checks*

19 Before each use, a competent person (preferably the user) should visually inspect the equipment and check it by hand, in accordance with the manufacturer's instructions. If any defects are found do not use the equipment. The checks should include any tensioned safety lines.

### *Detailed examination of equipment*

20 Periodic detailed examinations should be carried out by a competent person in accordance with the manufacturer's instructions. Keep a record of the examination. The recommended minimum frequencies for such examinations are as follows:

- Do not use equipment made from webbing, rope or textiles unless it has been examined in detail at least **once in the preceding six months** because of its susceptibility to wear, damage and degradation. Detailed guidance on inspecting equipment made from webbing or rope is given in *Inspecting fall-arrest equipment made from webbing or rope* INDG367.
- Do not use other parts, including anchors/anchor systems, unless they have been examined in detail at least **once in the preceding 12 months**.

### *Interim inspections*

21 Interim detailed examinations may be required in addition to pre-use checks and six- or 12-monthly detailed examinations. They will be required where the employer's risk assessment has identified a risk that could result in the system deteriorating significantly before the next planned inspection, eg exposure to grit blasting or paints or chemicals. Keep a record of the interim examination.

### *Inspection after a fall*

22 If a personal fall-protection system has had to arrest a fall, or has been subject to other high-impact loads, do not use any of the elements in that system until they have either undergone a detailed examination or been replaced in accordance with the manufacturer's instructions.

### *Inspection of rescue equipment*

23 The manufacturer may supply certain items of personal fall-protection equipment for rescue purposes in sealed transparent packaging. If the seal is not broken, these items do not require interim inspections. However, after a specified period (often three years), you must return them to the manufacturer for inspection and resealing.

24 Additional guidance is given in:



- BS 8437:2005 + A1:2012 Code of practice for selection, use and maintenance of personal fall protection systems and equipment for use in the workplace<sup>37</sup> and
- Inspecting fall-arrest equipment made from webbing or rope INDG367.

## Work-restraint systems

25 Work-restraint systems are sometimes referred to, inaccurately, as fall-restraint systems. In a work-restraint system, the position of the anchor point(s), when combined with the user's PPE, allows a worker to carry out their job but prevents them from reaching any position from which they could fall. This type of system increases user safety and reduces the need for rescue provision. Where practicable use a work-restraint system in preference to a fall-arrest system.

26 A working area will often have more than one edge or another place from which a worker could fall. For example, a particular roof area may have edges along the eaves and along the gables; it may also contain fragile roof lights. Make sure that the work-restraint system prevents the user from reaching any location from which they could fall.

## Fall-arrest systems

27 Fall-arrest systems should incorporate some form of energy absorber or an energy-dissipating element. This must make sure that, in the event of a fall, the forces on the user do not exceed 6 kN and that the system will help reduce the transfer of forces to the structure to which it is attached.

28 For a fall-arrest system to function correctly there must be adequate clearance beneath the work area.

29 If a fall-arrest system is in use the employer should consider and plan for rescuing or retrieving a fallen worker. There should always be a rescue plan in place, with the necessary equipment and trained people to carry out a rescue in safety without putting more workers at risk. Rescue a fallen worker as quickly as possible (see Emergency rescue procedures, paragraphs 48–53).

### Example

A system comprising a full body harness and a 2 m long lanyard with an energy absorber, anchored to a 20 m horizontal anchor line at foot level, could require up to 7.75 m of clearance below the anchorage. This is made up as follows:

Original length of the lanyard plus shock absorber	2.0 m
Maximum allowable shock absorber extension	1.75 m
Deflection of the anchor line cable during the fall arrest	1.5 m
Allowance for displacement of the worker, stretch in the full body harness and the clearance below the user's feet after the arrest	2.5 m
<b>Total</b>	<b>7.75 m</b>

30 It is good practice to install fall-arrest system anchor points as high above the user as possible, as this reduces forces, risk of injury and, in the event of a fall, makes rescue easier. Do not install anchors below foot level.

31 If you are using retractable-type fall arresters (sometimes called 'inertia reels'), anchor them vertically above the user so that the extendable line between the reel and the user runs largely vertically. If you wish to use a retractable-type fall arrester in any other orientation you should get

confirmation from the manufacturer that it has been tested and found safe for use in the desired orientation.

32 If there is a risk that, in the event of a fall, the lanyard or extendable line from a retractable-type fall arrester will come into direct contact with the edge of the structure during the fall arrest, it is important to use only equipment tested for this particular circumstance. You must seek confirmation from the manufacturer that the device is fit for the purpose for which you wish to use it. Failure to follow this advice could lead to the catastrophic failure of the personal fall-protection system.

33 Several national and European standards apply to personal fall-protection systems and the individual elements such as lanyards, harnesses and anchors. The two British Standards below give general advice and list the other relevant standards:

- BS 7883:2005<sup>38</sup> Code of practice for the design, selection, installation, use and maintenance of anchor devices conforming to BS EN 795; and
- BS 8437:2005 + A1: Code of practice for selection, use and maintenance of personal fall-protection systems and equipment for use in the workplace.

34 The Work at Height Safety Association website contains guidance notes on the use of personal fall-protection equipment: [www.wahsa.org.uk](http://www.wahsa.org.uk)

# APPENDIX 4 FRAGILITY: TESTS AND SPECIFICATIONS

1 There is a widely accepted standard of performance within the UK to define what a ‘non-fragile profiled sheeted roof assembly’ is. The test to show non-fragility for a roofing assembly has been drawn up by the Advisory Committee for Roofsafety (ACR) and is published in *Test for non-fragility of large element roofing assemblies*.

2 UK manufacturers of profiled roofing sheets are aware of the performance requirements of the ACR non-fragility tests. They have designed their products for the industrial, commercial and agricultural roofing markets such that, when they are fully fixed to their fixing requirements, the roof assembly will be non-fragile. The ACR test has seen a dramatic improvement in the technical performance of all industrial profiled sheeting since it was first published in 2000.

3 There are three categories to passing the ACR test:

- **Non-fragile class C:** The roof assembly retains a dropped load after one drop but fails to retain the load on the second drop. This is the minimum standard now accepted for a non-fragile roof. In practice, this means that if someone slipped and fell onto a class C roof, it is likely that they would damage the roof such that it would need repairs to maintain weather resistance and a non-fragile status.
- **Non-fragile class B:** The roof assembly retains a dropped load after two drops. In practice, this means that a person could fall twice in the same area and the roof would still support their weight. However, class B means that damage will have been done to the roof that may impair its long-term weather resistance and reduce the time that the non-fragile status is maintained.
- **Non-fragile class A:** The roof assembly retains a dropped load after two drops and there are no signs of any damage to the roof assembly that will affect the roof’s long-term weather resistance.

4 The ACR test is a demanding test with good safety factors built in. A class C performance is fully acceptable as a standard of non-fragility. A class B rating will normally be achieved with profiled metal assemblies and profiled roof lights. A class A rating is unlikely to be achieved using normally accepted profiled materials. A class A rating would typically be required where vehicle access was required on the roof.

5 Achieving a non-fragile roof, including all roof lights, at the construction phase is now commonplace and anything less should not be accepted.

6 However, as non-fragile roofs become more common, there is a serious risk that roof workers become complacent and do not recognise that a non-fragile roof will, at some point in time, become fragile. Fragility will eventually occur for one or many of the following reasons:

- the fixings were badly fixed, leading to excessive wear around the fixing;
- the fixing washers have failed due to overtightening, leading to sheet and fixing corrosion;
- the protective surface of the profiled sheeting was damaged by foot traffic during construction or during the roof maintenance phase, which will lead to an early failure of the sheet’s performance;

- any slip or fall onto the roof may damage the assembly, which could lead to early corrosion failure;
- external atmospheric conditions could lead to early failure of the sheet's performance, eg saline or factory process;
- the sheets and fixings have reached the end of their design life; and/or
- if a roof was built before 2000, it may well have been fragile when constructed.

7 Further information on how to work with fragile roofs can be found in *Safe working on fragile roofs or roofs with fragile elements*.

# APPENDIX 5 DEMOLITION INVOLVING ASBESTOS CEMENT ROOF SHEETS

1 If a building contains any asbestos it should be removed before demolition in accordance with the Control of Asbestos Regulations 2012 and the *Managing and working with asbestos. Control of Asbestos Regulations 2012. Approved Code of Practice and guidance* L143.<sup>39</sup>

2 Some asbestos-containing materials may be removed only by licensed contractors once they have notified HSE. The person in control of the demolition job must make sure this has been done before starting any further removal or demolition works.

3 Demolition involving asbestos cement sheets is not licensed work (providing the 4-hour and 10-minute control limits are not exceeded) but it may be notifiable to HSE. For notifiable non-licensed work (NNLW), employers have additional requirements: to notify work with asbestos to the relevant enforcing authority; to make sure medical examinations for removal workers are carried out; and to maintain registers of work (health records).

4 An employer needs to decide before starting work whether it is notifiable. To do this they will need to consider the task(s) to be undertaken and the nature and condition of the material; see the summary in paragraph 7. More detailed advice is given on HSE's website: [www.hse.gov.uk/asbestos/licensing/notifiable-non-licensed-work.htm](http://www.hse.gov.uk/asbestos/licensing/notifiable-non-licensed-work.htm). Normal weathering does not attract notification duties.

5 There are two general methods available to contractors intending to demolish structures of this type:

- by hand; or
- by remote methods.

6 To choose the most suitable method, demolition contractors have to weigh up the following factors:

- the exposure of worker(s) to asbestos fibres;
- contamination of the surrounding environment by asbestos dust and, in particular, exposing anyone downwind of the site to asbestos fibres;
- the risk of falling, especially through the asbestos cement roof;
- how difficult the asbestos is to access;
- the condition of the asbestos; and
- whether the sheets can be removed intact or nearly intact.

7 Each job must be considered on its merits but, in general, removal of individual sheets intact by hand will not be notifiable as NNLW. However, remote demolition by machine involving deliberate breakage of sheets and the consequent potential release of, and exposure to, asbestos fibres will be notifiable as NNLW.

## Risk of exposure and contamination

8 Asbestos cement is a grey, hard, brittle material normally containing 10–15% asbestos fibre. It is a dense material, with a density greater than 1 tonne/m<sup>3</sup>. When soaked in water for at least 15 minutes it will absorb less than 30% of its own weight of water as the asbestos fibres are tightly bound with cement.

9 To release the asbestos fibres from the asbestos cement, the material needs to be aggressively abraded. Activities such as sawing, drilling, wire brushing or crushing the material by tracking back and forth with heavy machinery are likely to produce dust containing asbestos fibres if the material is dry.

10 Any material containing more than 0.1% asbestos is classified as 'hazardous waste' and can be carried on the road only by a registered waste carrier consigning it to a licensed asbestos dump. In England your local Environment Agency area office (SEPA in Scotland or NRW/CNC in Wales) will be able to advise on disposal. Note that the 0.1% asbestos content definition within environmental legislation relates only to classification for transport and disposal. It does not relate in any way to the danger from exposure to asbestos fibres during this work.

## Risk of falling

11 Many asbestos cement products (such as roof sheets, slates, cladding, downpipes and gutters) are located at height and are fragile, and therefore present a risk of falls. Asbestos cement sheet is a fragile material in accordance with the *Test for non-fragility of large element roofing assemblies* (see paragraphs 170–202).

## Demolition

### ***Method 1 – by hand***

12 Demolition by hand is the preferred option due to the higher potential for asbestos fibre release and the need for clean-up of debris from remote demolition.

13 When you are working with asbestos-containing materials, there must be a written, adequate and sufficient risk assessment. Workers must be correctly supervised, trained, and understand and follow the method statement to which they will be working. They must have a thorough knowledge of the materials, equipment and tools they will be using, all in accordance with the ACOP *Managing and working with asbestos* L143.

14 If the asbestos cement sheets are in reasonable condition and you can provide safe access and a safe work surface (see paragraphs 170–202) then take the sheets down whole –do not drop or damage them. Remove the sheets from underneath using MEWPs (eg scissor lifts or cherry pickers). Bolts, or other fasteners which hold the sheets, should be removed by careful cutting from underneath where possible using bolt cutters or mechanically undone. Some bolts may have to be cut from above. Lower the sheets to the ground. The sheets are best disposed of by careful transfer to lockable lorries or skips, or by wrapping intact in heavy-duty sheet plastic.

### ***Method 2 – remote***

15 In some circumstances remote demolition by machine, such as pusher arm or deliberate controlled collapse, is necessary (eg if the asbestos sheets are in poor condition and liable to break when handled, or if safe access cannot be provided and the risk of falling is too great).

16 Remote demolition should give rise to personal fibre levels of less than 0.1 f/ml. Cleaning up dry dust and debris has the potential for elevated fibre levels so dust suppression and other control methods and respiratory protective equipment (RPE) will be required.

17 To reduce the potential for airborne and physical spread of dust and fibres and exposure for others, contractors should take precautions including the following:

- Carry out and complete the work before demolishing the rest of the structure.
- Segregate the work area and keep out unauthorised personnel;
- Keep the ground clear of other items and materials.;
- Keep the material wet with gentle spraying.
- Remove waste and debris from the site by hand as soon as possible to prevent it being disturbed, eg by moving vehicles. If you cannot remove the material immediately, cover it with heavy-duty polythene.
- Take care not to drive plant over asbestos cement sheet.
- Pick broken asbestos cement sheet by hand where possible. If you are gathering it by mechanical means wet it well to minimise fibre release. Do not bulldoze it into a pile. Do not use toothed buckets.
- Place any fine debris or waste liable to generate dust in suitable closed containers. Larger pieces of asbestos cement are best disposed of by careful transfer to covered lorries or skips.;
- Label containers for asbestos waste (eg bags or skips) correctly and dispose of them at a licensed waste tip.
- Carry out perimeter air monitoring for reassurance purposes to ensure that there is no spread of asbestos fibres outside the work area.

## Personal protective equipment

18 PPE and RPE should be worn by all workers physically involved in the removal and cleaning-up activities. RPE must be suitable and adequate; for example, disposable masks rated at FFP3. Workers should be fit-tested for the RPE and males should be clean-shaven when wearing it. Provide workers with disposable overalls; these should be safely disposed of with the masks as hazardous waste at the end of every shift. RPE will not be necessary for enclosed vehicle cab operators where cab air is filtered and windows and doors are kept closed.

## Training

19 People who carry out any work on asbestos materials must be trained and supervised properly. You need training even if you have worked with asbestos in the past. Training must include detailed information on:

- recognising asbestos;
- how asbestos can affect your health;
- the added dangers of smoking;
- the uses and likely locations for asbestos in buildings;
- what work you are allowed to do by law;
- what the law requires you to do;
- what methods to use;
- what equipment you need to do the job properly;
- how to choose, use and look after PPE;
- recognising and dealing with other dangers, such as work at height;
- decontamination of yourself and work areas;

- emergency procedures; and
- waste disposal.

20 Refresher training is needed every year, or more often if:

- work methods change;
- the type of equipment used changes; or
- the type of work changes a lot.

21 Supervise the task – make sure workers follow the rules.

22 See Managing and working with asbestos. *Control of Asbestos Regulations 2012. Approved Code of Practice and guidance* L143 for more specific information about training and work with asbestos.

### **Public concerns**

23 To members of the public the remote method appears noisy, dusty and often uncontrolled. People are often concerned about this type of demolition when they know or suspect the building was roofed or clad with asbestos cement. To alleviate concerns, contractors are advised to:

- keep the neighbours informed about the work;
- consult the local environmental health department; and
- carry out regular airborne monitoring downwind of the site.



# APPENDIX 6 HOT WORK

1 Hot work is any process that generates flames, sparks or heat. It is important to consider at the design stage whether such works can be designed out to reduce risk, particularly where buildings are occupied. For example, can cold roofing products be used to replace those that require hot application? Common hot work processes in roofing include:

- cutting;
- grinding;
- welding;
- torch-on roofing;
- bitumen boilers and hot-melt systems; and
- drying substrates with a torch before application of roof system.

2 Providing the right equipment, keeping it in good condition and training workers in basic good practice will help to reduce accidents to workers and the public.

## Drying substrates

3 In many types of waterproofing system the substrate needs to be completely dry before it will accept the new waterproofing. Torching is the traditional method for drying, but it presents a significant fire risk. Before torching the area, thoroughly inspect it for any combustible materials on the surface (eg timber boards, dry leaves and nests) and any gaps in the substrate or open cavities where combustible materials may have been left behind. The area may then need further preparation or an alternative to flame-torching used.

## Bitumen and hot-melt boilers

4 Hot liquid bitumen is widely used in work on flat roofs using either a traditional boiler or hot-melt systems. Three types of risk need to be controlled when using these systems:

- fire and explosion risk from storage and use of liquefied petroleum gas (LPG);
- risk of burning from contact with hot bitumen; and
- risk of respiratory irritation from excessive inhalation of bitumen fumes.

5 When you are setting up any boiler, follow these basic safety guidelines:

- Stand the boiler on a firm, level surface, which should be non-combustible and capable of carrying the load. Set up the boiler in a well-ventilated area and never inside a building or in any enclosed space.
- When the boiler is based on the roof surface, set it in a tray with a greater capacity than the contents of the boiler to contain any spillage. Set the tray on a fire-resistant material.
- Set up the gas cylinder at least 3 m away from the boiler during use, unless you are fitting a suitable protective shield.

- Store all additional gas cylinders safely at least 6 m away.
- Gas hoses should be armour braided, at least 4 m in length, in good condition and properly connected. A pressure regulator of no more than 2 bar must be fitted to all gas cylinders.
- Check for leaks before use eg with a leak detection spray— never use a naked flame.
- Do not smoke or allow others to smoke.
- Have at least one fire extinguisher close by (9 litre foam or 9 kg dry powder). Never use water to combat a bitumen fire. Ideally, also keep two boxes of sand (or similar) to hand.
- Keep a bucket of cold water near the workspace for use only in the case of bitumen burn.
- Protect the boiler with suitable barriers where other workers or the public may have access.
- When the gas cylinders are not in use, store them in a well-ventilated and secure area.
- Keep other combustibles (such as paper, packaging etc) well away from the gas cylinders;
- Make sure that all lifting equipment used, eg pulleys, blocks or ropes, is suitable and in good condition, before and after each job.
- For hot-melt boilers, check the power lead for damage and wear and make sure that the main power source is no more than 20 m from the boiler.

#### 6 While heating the bitumen:

- Follow the manufacturer's instructions on lighting up. Where possible remove the burner from under the boiler, light and then replace it. This avoids a build-up of gas under the boiler during the lighting process.
- Do not exceed the recommended operating temperature for the particular grade of bitumen used.
- When heating from cold, keep heating rates low until the bitumen is clearly liquid and any water has been driven off.
- Add bitumen carefully – avoid splashing.
- Never use gas-fired bitumen heating boilers for heating cut-back bitumens. These bitumens contain solvents which can be easily ignited by such open-flame heating – a rapidly escalating fire would ensue.

#### 7 Precautions during the use of bitumen and hot-melt systems:

- Keep water away from hot bitumen.
- Never use a ladle to remove bitumen – use the draw-off tap.
- Wear suitable eye protection, foot protection and gloves.
- Wear suitable clothing to avoid skin contact with splashes
- Minimise exposure to fumes by working, as far as reasonably practicable, on the upwind side of the hot works, and if required, by wearing appropriate RPE
- Do not heat the bitumen drums unless they are designed for that purpose.
- Keep the lid on the boiler as much as possible. For hot-melt boiler keep the lid closed at all times while paddles are engaged.
- In the case of a boiler fire, close the lid immediately, then turn off the gas supply valve and move the gas cylinder away from the area.
- Never leave the boiler unattended when lit or hot.
- Make sure that bitumen does not boil over. If this does occur, turn off the gas supply valve and move the cylinder away from any spilled or burning bitumen.
- Regularly check the boiler temperature and level. Ideally use a boiler with thermostatic controls.
- Carry bitumen in proper containers, eg lidded buckets, and always set them down on non-combustible surfaces.

- Keep the area around the boiler itself, and the route from the boiler to where the bitumen is used, clear of obstructions, including gas hoses, power cables and combustible material.

8 After using bitumen and hot-melt systems:

- Turn off gas at the cylinder first and then release remaining gas from the hose.
- Prevent build-up of bitumen on the outside of the boiler by regularly removing drips and splashes. Deal with any excessive spillages promptly.
- Turn off the burner and allow it to cool before any maintenance or repairs. The bitumen should be solid before moving or towing the boiler on a lorry or trailer.

9 At all times when using bitumen and hot-melt systems:

- Boilers should only be operated by a trained worker.
- Make sure the boiler does not overheat or run low.
- Turn the gas off before leaving the boiler unattended, even for a short time.
- Never apply direct heat to pipes or valves, or to the outside of the boiler.
- Follow general advice on safe storage and use of LPG given in Code of practice 44: the storage of gas cylinders<sup>40</sup> and Code of practice 10: the use of LPG in containers installed on mobile equipment.<sup>41</sup>

10 Workers and supervisors should be trained in specific first-aid procedures for bitumen burns. This should be supported by written instructions clearly available on site. A concise burns handling card can be downloaded from the safety page on the Refined Bitumen Association website: <https://www.eurobitume.eu/home/>. Further information is given in industry codes of practice for the safe operation of propane-fired bitumen boilers.<sup>42</sup>

### Further guidance on hot work

11 Further guidance is available in the following publications:

- Guidance for the safe installation of torch-on reinforced bitumen membranes and use of gas torches in the workplace<sup>43</sup>
- Safe drying and preparation of roof substrates prior to installation of liquid waterproofing systems<sup>44</sup>
- Fire Safety in Construction HSG168.

# APPENDIX 7 EDGE PROTECTION

1 When working on roofs, new or old, it is essential to protect workers from falling from the edge of the roof. 'Edge protection' is the term commonly used to describe measures that can be used to prevent workers falling from the roof edge.

2 There are a number of popularly used systems:

- tube and fitting guard rail;
- proprietary guard rail systems;
- netting systems.

3 The most appropriate system will depend on several factors:

- duration of work;
- type of roof;
- roof slope;
- size and weight of materials being used; and
- available attachment points.

4 The decision on which type of edge protection to use must be made by a competent person who has all of the information about the work that is to be undertaken. Similarly, the person who installs the edge protection must be competent in its installation and dismantling.

5 Edge protection systems are selected primarily based on the gradient of the surface for which they are to provide protection. Where roofs are pitched the edge protection system needs to be capable of containing a person sliding down the sloping surface. At the other end of the spectrum, if the work is to be carried out on a non-fragile flat roof then a free standing weighted edge protection system which is designed to comply to EN 13374 class A may be adequate. Consider using a system that is also appropriate to the duration of the work. For example, an access platform that requires minutes to position to carry out minor work may involve less risk of working at height than a comprehensive scaffolding solution which takes many hours to install and dismantle.

6 BS EN 13374 is the European norm for edge protection design.

7 For industry guidance on the use of various edge protection systems and their applications see:

- Edge Protection Federation Code of practice 2014. A guide to the selection and use of temporary edge protection systems<sup>45</sup>
- Practical methods of providing edge protection for working on roofs<sup>46</sup>

# REFERENCES AND FURTHER READING

## References

- 1 *Managing health and safety in construction. Construction (Design and Management) Regulations 2015.* L153 HSE 2007 [www.hse.gov.uk/pubns/books/l153.htm](http://www.hse.gov.uk/pubns/books/l153.htm)
- 2 BS EN 12811-4:2013 *Temporary works equipment.* British Standards Institution
- 3 TG20:13 *Good practice guidance for tube and fitting scaffolding.* NASC 2013 [www.nasc.org.uk](http://www.nasc.org.uk)
- 4 *The selection, management and use of mobile elevating work platforms* GEIS6 HSE 2014 <http://www.hse.gov.uk/pubns/geis6.pdf>
- 5 BS EN 131 *Ladders. Terms, types, functional sizes* British Standards Institution
- 6 *Roofing and cladding in windy conditions* NFRC 2017 [www.nfrc.co.uk](http://www.nfrc.co.uk)
- 7 TG9:18 *Guide to the design and construction of temporary roofs and buildings* NASC 2018 [www.nasc.org.uk](http://www.nasc.org.uk)
- 8 *Avoiding danger from overhead power lines. Guidance note (fourth edition)* GS6 HSE 2013 <http://www.hse.gov.uk/pubns/g6.pdf>
- 9 *Look out – look up! A guide to the safe use of mechanical plant in the vicinity of electricity overhead lines* Energy Networks Association [www.energynetworks.org/electricity/](http://www.energynetworks.org/electricity/)
- 10 BS 7375:2019 *Distribution of electricity on construction and demolition sites. Code of practice* British Standards Institution
- 11 *Fire safety in construction.* HSG168 HSE 2010 <http://www.hse.gov.uk/pubns/priced/hsg168.pdf>
- 12 *Guidelines: Health & safety in the signal reception and network industries* January 2019 Confederation of Aerial Industries
- 13 *Cleaning weathered asbestos cement (AC) roofing and cladding* A12 HSE 2017 <http://www.hse.gov.uk/pubns/guidance/a12.pdf>
- 14 *Disposing of hazardous waste.* <https://www.gov.uk/dispose-hazardous-waste>
- 15 BS 8634:2017 *Portable roof ladders. Specification* British Standards Institution
- 16 BS EN 13374:2013 *Temporary edge protection systems. Product specification. Test methods* British Standards Institution

- 17 *Trussed Rafter Association technical handbook* 2007 Trussed Rafter Association  
<http://bookshop.trada.co.uk/bookshop/view/EE5278E9-2F94-46F6-897B-F81BCD17EEB9/>
- 18 BS 5534:2014 +A2:2018 *Slating and tiling for pitched roofs and vertical cladding. Code of practice* British Standards Institution
- 19 *Health & Safety Guidance Sheet e Slater's heel* NFRC 2009 [www.nfrc.co.uk](http://www.nfrc.co.uk)
- 20 *Graded battens for slating and tiling. Technical bulletin 33* NFRC [www.nfrc.co.uk](http://www.nfrc.co.uk)
- 21 *The Red Book. Test for non-fragility of large element roofing assemblies.* ACR[M]001: 2014 Fifth edition <https://www.the-acr.org/publications/the-red-book/>
- 22 *The Orange Book. Recommended practice for work on profiled sheeted roofs* ACR[CP]001:2016 Rev 5 <https://www.the-acr.org/publications/the-orange-book/>
- 23 *The Green Book. Safe working on fragile roofs or roofs with fragile elements* ACR[CP]002:2017 Third edition <https://www.the-acr.org/publications/the-green-book/>
- 24 *Protecting the public: Your next move* HSG151 HSE 2009 [www.hse.gov.uk/pubns/books/hsg151.htm](http://www.hse.gov.uk/pubns/books/hsg151.htm)
- 25 *Safety signs and signals. The Health and Safety (Safety Signs and Signals) Regulations 1996. Guidance on Regulations* L64 HSE 2015 [www.hse.gov.uk/pubns/books/l64.htm](http://www.hse.gov.uk/pubns/books/l64.htm)
- 26 *The Blue Book. Recommended practice for use of safety nets for roofwork* ACR[CP]003:2016 Rev 2 <https://www.the-acr.org/publications/the-blue-book/>
- 27 Technical Bulletins 1–31 Fall Arrest Safety Equipment Training (FASET)  
<https://www.faset.org.uk/guidance-2/technical-bulletins/>
- 28 *Best practice for the specification and installation of metal cladding and secondary steelwork* P346 Steel Construction Institute 2007 <http://mcrma.co.uk/wp-content/uploads/2015/10/Best-Practice-for-Specification-of-Cladding-Secondary-Steel.pdf>
- 29 *Inspecting fall arrest equipment made from webbing or rope* Leaflet INDG367 HSE 2002 [www.hse.gov.uk/pubns/conindex.htm](http://www.hse.gov.uk/pubns/conindex.htm)
- 30 *The Black Book: Guidance note for competence and general fitness requirements to work on roofs* ACR (CP)005:2012 <https://www.the-acr.org/publications/the-black-book/>
- 31 BS 8454:2006 *Code of practice for the delivery of training and education for work at height and rescue* British Standards Institution
- 32 BS EN 1263-1:2014 *Temporary works equipment. Safety nets. Safety requirements, test methods* British Standards Institution
- 33 *BS 8411:2019 Code of practice for safety nets on construction sites and other works* British Standards Institution
- 34 BS EN 1263-2:2014 *Temporary works equipment. Safety nets. Safety Requirements for the positioning limits.* British Standards Institution
- 35 *IRATA International code of practice for industrial rope access* Industrial Rope Access Trade Association 2014 <https://www.irata.org/publications>
- 36 BS EN 795:2012. *Personal fall protection equipment. Anchor devices.* British Standards Institution

- 37 BS 8437:2005 + A1:2012 *Code of practice for selection, use and maintenance of personal fall protection systems and equipment for use in the workplace* British Standards Institution
- 38 BS 7883:2005 *Code of practice for the design, selection, installation, use and maintenance of anchor devices conforming to BS EN 795* British Standards Institution
- 39 *Managing and working with asbestos. Control of Asbestos Regulations 2012. Approved Code of Practice and guidance* L143 HSE 2013 [www.hse.gov.uk/pubns/books/l143.htm](http://www.hse.gov.uk/pubns/books/l143.htm)
- 40 *Storage of full and empty LPG cylinders and cartridges. Code of practice 44* LP Gas Association 2004 <https://www.uklpg.org/resources/codes-of-practice>
- 41 *The use of LPG in containers installed on mobile equipment. Code of practice 10* LP Gas Association 2018 <https://www.uklpg.org/resources/codes-of-practice>
- 42 *Model code of safe practice part 11: Bitumen safety code* (Fourth edition, revised) Energy Institute 2005 <https://publishing.energyinst.org/topics/environment/model-code-of-safe-practice-part-11-bitumen-safety-code>
- 43 *Guidance for the safe installation of torch-on reinforced bitumen membranes and use of gas torches in the workplace.* <https://www.nfrc.co.uk/safe2torch>
- 44 *Safe drying and preparation of roof substrates prior to installation of liquid waterproofing systems. Guidance note 13.* Liquid Roofing and Waterproofing Association 2017 <http://www.lrwa.org.uk/>
- 45 *Code of practice 2014. A guide to the selection and use of temporary edge protection systems.* Edge Protection Federation [www.epf-uk.org](http://www.epf-uk.org)
- 46 *The Purple Book. Practical methods of providing edge protection for working on roofs* <https://www.the-acr.org/publications/the-purple-book/>

## Further reading

- CDM 2015 – Construction work sector guidance for designers* Fourth edition (C755) CIRIA 2015 [www.ciria.org](http://www.ciria.org)
- First aid in work* [www.hse.gov.uk/first-aid/index.htm](http://www.hse.gov.uk/first-aid/index.htm)
- Lifting equipment at work. A brief guide* Leaflet INDG290 (rev 1) HSE 2013 <http://www.hse.gov.uk/pubns/indg290.pdf>
- Managing asbestos in buildings. A brief guide* Leaflet INDG223 (rev5) [www.hse.gov.uk/pubns/indg223.htm](http://www.hse.gov.uk/pubns/indg223.htm)
- Managing for health and safety* HSG65 (Third edition) 2013 [www.hse.gov.uk/pubns/books/hsg65.htm](http://www.hse.gov.uk/pubns/books/hsg65.htm)
- Risk assessment. A brief guide to controlling risks in the workplace* Leaflet INDG163 (rev4) HSE 2014 <http://www.hse.gov.uk/pubns/indg163.pdf>
- Safety Steps. Access Industry Forum. <https://accessindustryforum.org.uk/safety-steps/>

## FURTHER INFORMATION

For information about health and safety visit <https://books.hse.gov.uk> or <http://www.hse.gov.uk>. You can view HSE guidance online and order priced publications from the website. HSE priced publications are also available from bookshops.

To report inconsistencies or inaccuracies in this guidance email: [commissioning@wlt.com](mailto:commissioning@wlt.com).

British Standards can be obtained in PDF or hard copy formats from BSI <http://shop.bsigroup.com> or by contacting BSI Customer Services for hard copies only Tel: 0846 086 9001 email: [cservices@bsigroup.com](mailto:cservices@bsigroup.com).

The Stationery Office publications are available from The Stationery Office, PO Box 29, Norwich NR3 1GN  
Tel: 0333 202 5070 Fax: 0333 202 5080.  
E-mail:[customer.services@tso.co.uk](mailto:customer.services@tso.co.uk) Website: [www.tso.co.uk](http://www.tso.co.uk). They are also available from bookshops.

Statutory Instruments can be viewed free of charge at [www.legislation.gov.uk](http://www.legislation.gov.uk) where you can also search for changes to legislation.



