



# Rex Consolidated

## FASTENERS



## OUR PRODUCTS

WE ARE ONE OF THE FASTEST GROWING MANUFACTURERS OF 4.6,4.8,5.8,8,8.8,9.8,10.9,12.9, GRADE IN M.S EN8D, HIGH TENSILE,BORON, STAINLESS STEEL & ALUMINUM, COLD FORGED FASTENERS,COLD FORGED SHOULDER BOLTS, SPECIAL BOLTS, STEP BOLTS, RIVETS & ALL TYPE OF COLD FORGED COMPONENTS WITH SIZE RANGING FORM M3 TO M16.OUR SPECIALTY LIES IN PRODUCING THESE COMPONENTS AS PER DRAWING AND CONFORMING TO NATIONAL AND INTERNATIONAL STANDARDS LIKE IS, DIN, BS, JIS AND U.S.

## QUALITY POLICIES

WE ARE COMMITTED TO DELIVER HIGH QUALITY PRODUCTS AT RIGHT COST AND AT RIGHT TIME.

## QUALITY ASSURANCE

WE ARE COMMITTED TOWARDS OFFERING OUR CLIENTS WITH A QUALITATIVE RANGE OF FASTNERS AND FORGED COMPONESTS.WE ENSURE TO MAINTAIN QUALAITY AT EACH LEVEL OF THE BUSINESS OPERATIONS.OUR IN-HOUSE QUALITY CONTROL LAB IS FULLY EQUIPPED TO CHECK THE QUALITY OF THE PRODUCTS RIGHT FROM THE PROCUREMENTS OF THE RAW MATERIAL TILL THE FINAL FINISH.CAPITALIZING ON OUR WIDE INDUSTRY EXPERIENCE, WE HAVE BEEN ABLE TO SATISFY OUR CLIENTS WITH THE PRODUCTS AS PER THEIR SEPCIFICATIONS AND REQUIREMENTS.

## ABOUT US

### **Welcome to Rex Consolidated!**

Rex Consolidated is a leading provider of high-quality solutions across multiple industries. With a diverse portfolio spanning sealants and gaskets, rotating beacon mounting brackets (DIN14620), fuel tank accessories and components, building construction and hardware components, fasteners, agri components, trailer parts, and precision engineering of metal parts and components—including for defense and aerospace applications—we are your one-stop destination for reliable, innovative, and precision-engineered products.

In the sealants and gaskets segment, we offer a comprehensive range of products designed to meet the most demanding sealing requirements across various industries. Our sealants and gaskets are engineered for durability, reliability, and superior performance, ensuring leak-proof seals and enhanced safety.

For rotating beacon mounting brackets (DIN14620), our precision-engineered solutions provide secure and efficient mounting options for beacon installations, meeting industry standards and ensuring optimal performance in diverse applications.

In the field of fuel tank accessories and components, Rex Consolidated offers a wide array of high-quality products designed to enhance the functionality, safety, and efficiency of fuel tank systems. From fuel caps to vent valves, we deliver solutions that meet the stringent requirements of the automotive, marine, and aerospace sectors.

Our expertise in building construction and hardware components encompasses a range of products designed to meet the needs of modern construction projects. From hinges and handles to brackets and connectors, our products are engineered for durability, strength, and ease of installation.

In the fasteners segment, Rex Consolidated offers a comprehensive range of fastening solutions tailored to the needs of various industries. From standard bolts and nuts to specialized fasteners, we provide products that meet the highest standards of quality, reliability, and performance.

Our range of agri components is designed to support agricultural machinery and operations with durable, field-tested parts. From linkages and implements to precision-cut wear components, we help maximize productivity and reliability in farming environments.

Rex Consolidated also specializes in trailer parts, offering robust, reliable solutions including axle components, couplers, jacks, lighting brackets, and structural fittings. Engineered for safety, endurance, and optimal load handling, our trailer parts serve both commercial and industrial hauling needs.



# QUALITY CONTROL AND TESTING

- **Magnetic Particle Inspection Machine**
- **Optical Inspection Machine, Dimensional Inspection**
- **Profile Projector**
- **Precision Measuring System (VMM)**
- **Salt Spray Tester**
- **Plating Thickness Testing**
- **Surface Roughness Tester**
- **Dimensional and Metallurgical Inspection Machine (Laser and Eddy Current Based)**
- **Rockwell Hardness Testers**
- **Spectrometer**
- **Metallurgical Microscope**
- **Brinell Hardness Tester**
- **Digital Rockwell cum superficial Hardness Tester**
- **Micro hardness tester with Image Analyzer**
- **Electronic Universal Testina Machine**



# MANUFACTURING PROCESS

- **Wire Processing**
- **Tooling**
- **Cold Forging**
- **Thread Rolling**
- **Heat Treatment**
- **Hot Forging**
- **Machining**
- **Surface Treatment**

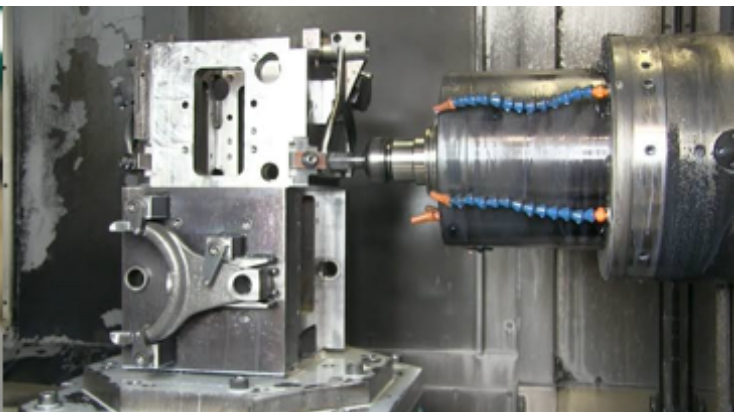



# HEX-HEAD BOLT

**DIN Standards : DIN933 (Full Thread), DIN931 (Partial-Thread)**

**Diameter : M4 to M52**

**Grades : 8.8, 10.9, 12.9, 14.9, Stainless Steel A2, Stainless Steel A4**

**Length : 6mm to 600mm**



**At Rex Consolidated, we specialize in manufacturing hex head screws that meet the highest standards of durability, precision, and reliability. Designed for versatility, these screws are ideal for a wide range of applications across industries such as automotive, construction, and heavy machinery.**

## **Product Features:**

- **Variety of Lengths and Thread Sizes:** We offer hex head screws in a diverse range of dimensions, ensuring the perfect fit for your project requirements.
- **Material Options:** Our screws are available in multiple materials, including stainless steel, carbon steel, and alloy steel, with optional coatings for enhanced corrosion resistance.
- **Precision Engineering:** Each screw is crafted with exacting standards to deliver superior performance under demanding conditions.

**Whether you need standard configurations or custom solutions, Rex Consolidated is your trusted partner for high-quality hex head screws that exceed expectations**

# SOCKET-HEAD BOLT

**Diameter : M4 to M52**

**DIN Standard :**

**Grades : 8.8, 10.9, 12.9, 14.9,  
Stainless Steel A2, Stainless  
Steel A4**

**Length : 6mm to 600mm.**



**Precision-machined socket head bolts designed for high-strength, space-constrained assemblies.**

**Manufactured from alloy and stainless steel grades with fine or coarse threads.**

**Ideal for critical load-bearing joints in machinery and automotive components.**

**Available in hex socket, button head, and countersunk styles.**

**Conforms to DIN, ISO, and ASTM standards for industrial performance.**



# CARRIAGE BOLTS

**DIN Standard : DIN603**

**Diameter : M4 to M52**

**Grades : 8.8, 10.9, 12.9, 14.9,  
Stainless Steel A2, Stainless  
Steel A4**

**Length : 6mm to 600mm**



**At Rex Consolidated, we specialize in manufacturing high-quality Carriage Bolts (DIN 603) that offer superior strength, durability, and a smooth, polished finish. Designed for a variety of applications, our carriage bolts are trusted in industries such as construction, automotive, and woodworking.**

## **Product Features**

### **Robust Design:**

**Featuring a round head and square neck, our carriage bolts ensure a secure, non-slip fit, making them ideal for structural and aesthetic applications.**

### **Versatile Material Options:**

**Available in stainless steel, carbon steel, and galvanized finishes to meet diverse environmental and strength requirements.**

### **Precision Manufacturing:**

**Produced to stringent DIN 603 standards, these bolts provide consistent performance, ensuring long-term reliability and strength.**

**Whether for structural projects or custom applications, Rex Consolidated's carriage bolts deliver unmatched quality and performance.**





## SPECIAL BOLTS

**DIN Standard : DIN603**

**Diameter : M4 to M52**

**Grades : 8.8, 10.9, 12.9, 14.9,  
Stainless Steel A2,  
Stainless Steel A4**

**Length : 6mm to 600mm**



**At Rex Consolidated, we specialize in manufacturing high-quality Carriage Bolts (DIN 603) that offer superior strength, durability, and a smooth, polished finish. Designed for a variety of applications, our carriage bolts are trusted in industries such as construction, automotive, and woodworking.**

### **Product Features**

#### **Robust Design:**

**Featuring a round head and square neck, our carriage bolts ensure a secure, non-slip fit, making them ideal for structural and aesthetic applications.**

#### **Versatile Material Options:**

**Available in stainless steel, carbon steel, and galvanized finishes to meet diverse environmental and strength requirements.**

#### **Precision Manufacturing:**

**Produced to stringent DIN 603 standards, these bolts provide consistent performance, ensuring long-term reliability and strength.**

**Whether for structural projects or custom applications, Rex Consolidated's carriage bolts deliver unmatched quality and performance.**



## STUDS

**Diameter : M6 to M100**

**Length : Upto 2000mm**



**Rex Consolidated's Studs are crafted for high-strength and precision fastening, making them ideal for critical applications in automotive, construction, and heavy equipment industries. With a focus on durability and precision, our studs ensure reliable connections in bolted assemblies.**

### **Product Features**

- ✓ **Wide Range of Sizes:** Offered in various lengths, diameters, and thread types (fully threaded, double-ended, and tap-end) for diverse applications.
- ✓ **High-Quality Materials:** Available in stainless steel, alloy steel, and high-strength carbon steel, with coatings like black oxide, zinc plating, and PTFE for corrosion resistance.
- ✓ **Industry Compliance:** Manufactured to meet ASTM, ISO, and DIN standards, ensuring superior load distribution, tensile strength, and wear resistance. For demanding applications requiring robust and secure fastening, Rex Consolidated's studs provide unmatched reliability and strength.



## U-BOLTS

**Produced as per customer specifications.**

**Grades : 4.6, 5.6, 8.8, 10.9, 12.9, 14.9, Stainless Steel A2, Stainless Steel A4**

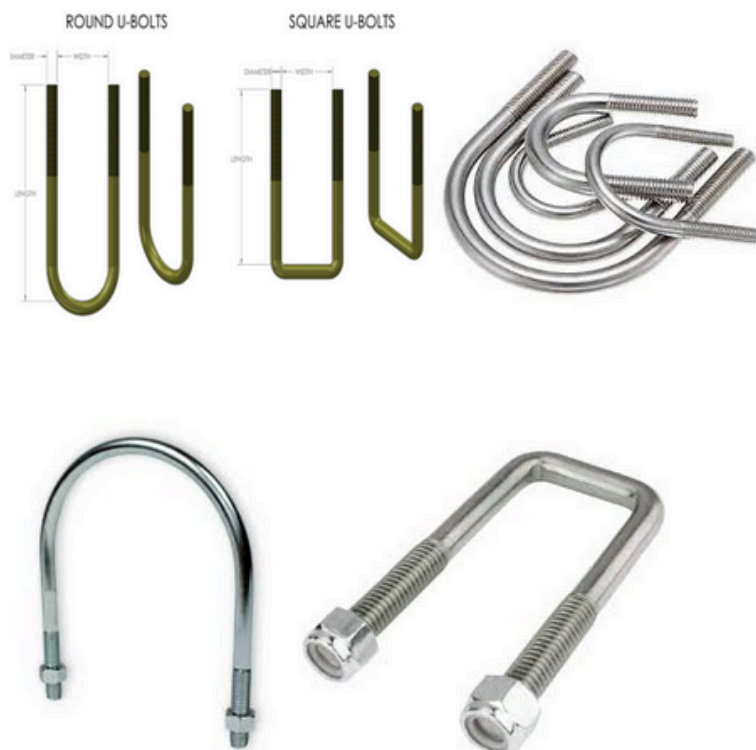

**Rex Consolidated's U-Bolts are designed for secure and stable clamping of pipes, tubes, and structural components across multiple industries. Built for durability, our U-bolts offer robust fastening solutions for both static and dynamic loads.**

### **Product Features**

- ✓ **Versatile Sizing:** Available in various diameters, thread types, and lengths to accommodate different pipe and structural mounting needs.
  - ✓ **Superior Material Selection:** Manufactured from stainless steel, carbon steel, and alloy steel, with anti-corrosion finishes such as hot-dip galvanizing and zinc plating.
  - ✓ **Reliable Strength:** Designed for high tensile strength and excellent load-bearing capacity, ensuring long-term performance in harsh environments.
- Ideal for automotive, construction, and industrial applications, Rex Consolidated's U-bolts provide dependable and secure fastening solutions.**



## DOUBLE U-BOLTS

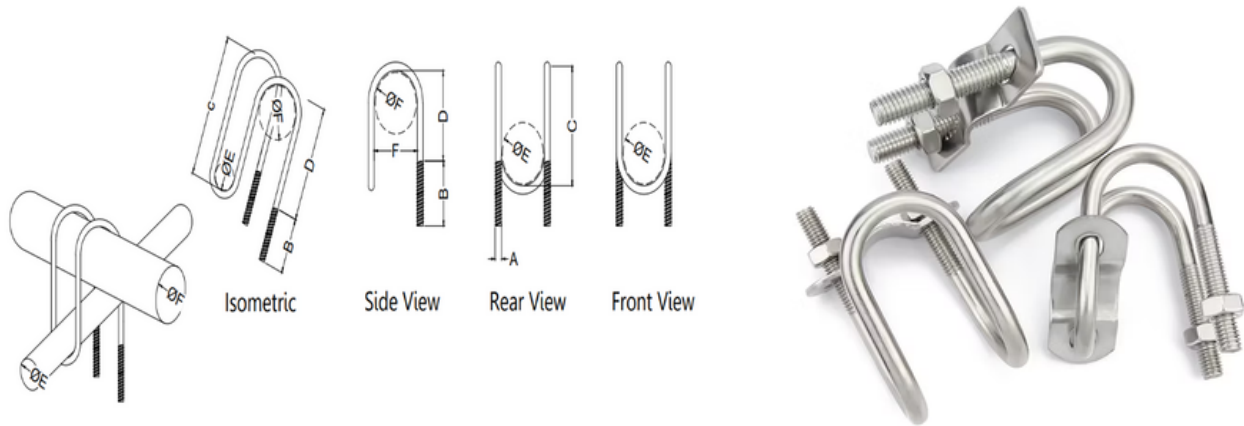

- **Heavy-duty double U bolts for securing pipes, axles, and structural elements.**
- **Engineered with equal thread lengths on both ends for balanced load distribution.**
- **Offered in galvanized, zinc-plated, and stainless steel finishes for corrosion resistance.**
- **Available in standard and custom sizes for trailers, tanks, and suspension systems.**
- **Backed by rigorous dimensional and tensile testing.**

# Rivets



**Rex Consolidated offers a broad range of Rivets designed for reliable, permanent fastening solutions. With applications spanning automotive, construction, and aerospace industries, our rivets ensure strong and durable connections.**

## **Product Features**

### **Wide Range of Types:**

**Choose from solid, blind, and tubular rivets to meet specific fastening needs across various materials and thicknesses.**

### **High-Strength Materials:**

**Manufactured from aluminum, stainless steel, and other alloys to provide optimal strength, corrosion resistance, and lightweight solutions.**

### **Precision Engineering:**

**Our rivets are produced with exacting tolerances to ensure secure fastening and long-lasting durability in high-stress environments.**



**For dependable and versatile fastening solutions, Rex Consolidated's rivets are the perfect choice.**



# STANDARD NUTS / MUTTERN



**Running a holiday sale or weekly special? Definitely promote it here to get customers excited about getting a sweet deal.**

<p><b>DIN934 Hexagonal Nut</b></p> <p>Material : 8.8 Galvanised Steel, Stainless Steel A2, Stainless Steel A4, Brass, Nickel Plated, Raw Steel</p>		<p>Stainless Steel Square Nut, DIN 557 Stainless Steel Square Nuts. Available in A2 / 304 and A4 / 316 Stainless Steel. All manufactured to DIN 557 standard.</p>	
<p><b>DIN980</b></p>		<p><b>Wing Nut</b></p>	
<p><b>DIN6927</b></p>		<p><b>Weld nut</b> DIN 928,929 DIAMETER: M4-M12, 5/32-1/2"</p>	
<p><b>DINI4440 / DINI4441</b></p>		<p><b>BRASS NUT</b></p>	
<p><b>DIN6923 / DIN EN 1661</b> DIAMETER : M4-M12 , 5/32-1/2"</p>		<p><b>TEE NUT</b></p>	
<p><b>DIN985,982 (Nylock Nut)</b></p>		<p><b>DOOM NUT</b></p>	
		<p><b>CAGE NUTS</b></p>	
		<p><b>SLOTTED NUT</b></p>	



## THREADED ROD DIN-975



**Sizes : 6 mm to 30 mm**

**ASTM Size :**

**Diameter: 1/4" to 2"**

**Lengths: 1' to 12'**

**Tube Quantities: 1 to 50 depending on  
diameter**

### **TECHNICAL SPECIFICATION:**

**The company manufactures superior quality Threaded Rods that are used in a number of industrial as well as mechanical applications. Our Industrial Threaded Rods are specially designed to suit the specific requirements of the industry. We make them available in both standard as well as customized ranges. These treaded rods are fabricated from the best quality base materials such as stainless steel so that they become doubly enduring and long lasting in nature. They have high tensile strengths that resist them from any abrasion for a longer period of time. Besides, we stand amidst the reliable Industrial Threaded Rods in Exporters.**

# WASHERS



**Rex Consolidated's Washers are crafted for precision and durability, providing essential support for fasteners in various mechanical and structural applications. Our washers are designed to evenly distribute load and prevent damage to the fastening surface.**

## **Product Features**

### **Range of Sizes:**

**Available in a wide variety of diameters and thicknesses to suit different bolt and screw sizes, ensuring a perfect fit for every application.**

### **Material Variety:**

**Offered in stainless steel, carbon steel, and brass, with finishes like zinc plating or black oxide for enhanced corrosion resistance.**

### **High-Quality Standards:**

**Conforming to industry standards, our plain washers ensure optimal performance, load distribution, and surface protection.**

**Whether for automotive, construction, or general use, Rex Consolidated's plain washers provide reliable and efficient support for your fastening needs.**



## DOWEL PINS & CLEVIS PINS



**Precision-ground dowel pins for alignment, and clevis pins for quick locking mechanisms.**

**Made from hardened steel, stainless steel, or brass as per customer need.**

**Ideal for locating, joining, or pivoting in mechanical assemblies.**

**Available with grooves, holes, or straight shanks for versatile use.**

**Offered in metric and imperial sizes with tight tolerances.**











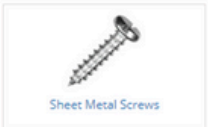
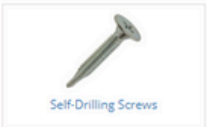

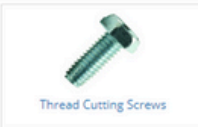
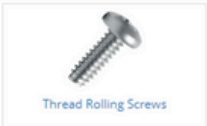
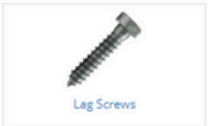

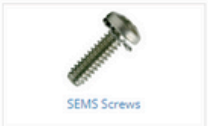
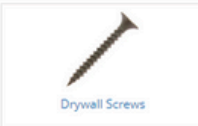
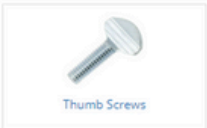
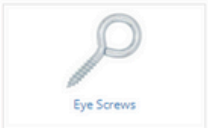
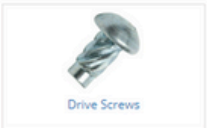
# SCREW

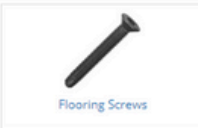
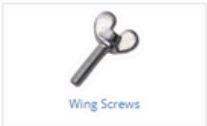

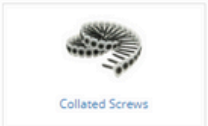
Socket Set Screws

Socket Jam Screws

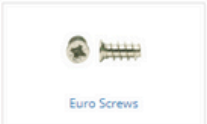
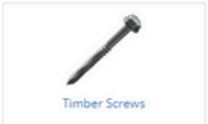
Square Head Set Screws

 Machine Screws	 Sheet Metal Screws	 Self-Drilling Screws	 Wood Screws	 Thread Cutting Screws
 Thread Rolling Screws	 Lag Screws	 Tamper-Resistant Screws	 SEMS Screws	 Drywall Screws
 Thumb Screws	 Eye Screws	 Drive Screws	 Binding Post Barrels	 Flooring Screws
 Wing Screws	 Weld Screws	 Dowel Screws	 Collated Screws	 Binding Post Mating Screws
 Binding Post Screw Sets	 Accordion Screws	 Euro Screws	 Timber Screws	 Jack Screws

**We offer prototype development services to help you test your product before going into full production. Our team will work with you to refine your design and ensure the final product meets your specifications.**

## ALLEN BOLT



**At Rex Consolidated, we are proud to manufacture high-quality Allen bolts (DIN 912) that combine strength, precision, and reliability. Engineered for demanding applications, our Allen bolts are widely used across industries such as automotive, aerospace, and construction.**

### **Product Features**

#### **Diverse Dimensions:**

**Our Allen bolts are available in a variety of lengths and thread sizes, making them suitable for projects requiring precise fittings.**

#### **Material Versatility:**

**Offered in stainless steel, carbon steel, and alloy steel, with optional finishes such as zinc plating or black oxide for superior corrosion resistance.**

#### **Precision Engineering:**

**Manufactured to exacting DIN 912 standards, these bolts deliver exceptional performance and secure fastening under high-stress conditions.**

**Whether you need Allen bolts for standard applications or custom requirements, Rex Consolidated is your trusted source for premium-quality fastening solutions.**



# ANCHOR FASTENER



**Our state-of-the-art facility is equipped with the latest technology to ensure efficient and accurate production. We pride ourselves on delivering quality products on time and within budget.**

**Heavy-duty anchor bolts and fasteners for concrete, masonry, and structural installations.**

**Designed for secure embedment and vibration resistance in static loads.**

**Available in wedge, sleeve, and chemical anchor variants.**

**Zinc-plated, hot-dip galvanized, or stainless options for harsh environments.**

**Certified for use in construction, infrastructure, and industrial foundations.**





# SPIRAL RETAINING RING

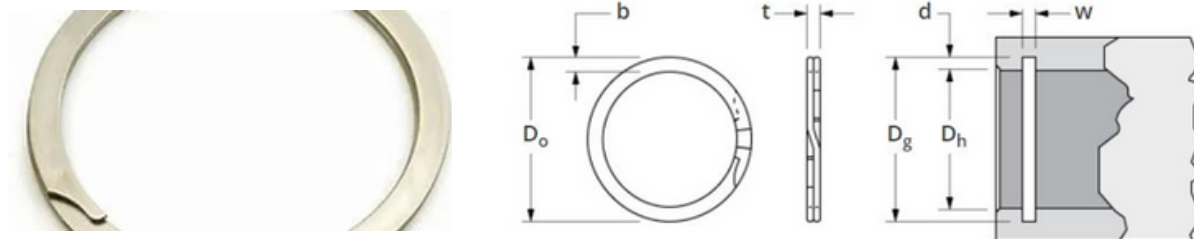

Round Retaining Rings



Support Rings



External Interlocking Rings



External Poodle Rings



External Spiral Rings



External Push-On Rings



Internal Push-On Rings



Retaining Ring Kits



External Crescent Rings



Internal Spiral Rings



E-Clips



Internal Retaining Rings



External Retaining Rings

**We offer competitive pricing for all of our industrial manufacturing services without compromising on quality. Contact us today for a quote.**

**Compact, flexible retaining rings designed to hold components on shafts or in bores.**

**Manufactured with spring steel or stainless for lasting grip and performance. Used in automotive, gearbox, and mechanical assemblies.**

**Offers 360° contact for better load distribution than standard snap rings.**

**Available in internal and external types, with or without lug.**

# EYE BOLT

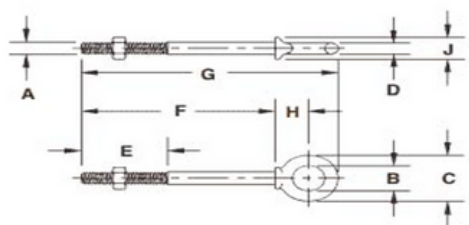

Shank Diameter & Length (in.)	G-277 Stock No. Galv.	Working Load Limit* (lbs.)	Weight Per 100 (lbs.)	Dimensions (in.)									
				A	B	C	D	E	F	G	H	J	
1/4 x 2	1045014	650	6.60	.25	.50	.88	.19	1.50	2.00	2.94	.50	.47	
1/4 x 4	1045032	650	9.10	.25	.50	.88	.19	2.50	4.00	4.94	.50	.47	
5/16 x 2 1/4	1045050	1200	12.50	.31	.62	1.12	.25	1.50	2.25	3.50	.69	.56	
5/16 x 4 1/4	1045078	1200	18.80	.31	.62	1.12	.25	2.50	4.25	5.50	.69	.56	
3/8 x 2 1/2	1045096	1550	21.40	.38	.75	1.38	.31	1.50	2.50	3.97	.78	.66	
3/8 x 4 1/2	1045112	1550	25.30	.38	.75	1.38	.31	2.50	4.50	5.97	.78	.66	
1/2 x 3 1/4	1045130	2600	42.60	.50	1.00	1.75	.38	1.50	3.25	5.12	1.00	.91	
1/2 x 6	1045158	2600	56.60	.50	1.00	1.75	.38	3.00	6.00	7.88	1.00	.91	
5/8 x 4	1045176	5200	68.60	.62	1.25	2.25	.50	2.00	4.00	6.44	1.31	1.12	
5/8 x 6	1045194	5200	102.40	.62	1.25	2.25	.50	3.00	6.00	8.44	1.31	1.12	
3/4 x 4 1/2	1045210	7200	144.50	.75	1.50	2.75	.62	2.00	4.50	7.44	1.56	1.38	
3/4 x 6	1045238	7200	167.50	.75	1.50	2.75	.62	3.00	6.00	8.94	1.56	1.38	
7/8 x 5	1045256	10600	225.00	.88	1.75	3.25	.75	2.50	5.00	8.47	1.84	1.56	
1 x 6	1045292	13300	366.30	1.00	2.00	3.75	.88	3.00	6.00	9.97	2.09	1.81	
1 x 9	1045318	13300	422.50	1.00	2.00	3.75	.88	4.00	9.00	12.97	2.09	1.81	
1 1/4 x 8	1045336	21000	650.00	1.25	2.50	4.50	1.00	4.00	8.00	12.72	2.47	2.28	
1 1/4 x 12	1045354	21000	795.00	1.25	2.50	4.50	1.00	4.00	12.00	16.72	2.47	2.28	
1 1/2 x 15	1045372	24000	1425.00	1.50	3.00	5.50	1.25	6.00	15.00	20.75	3.00	2.75	

At Rex Consolidated, our precision machining services are designed to meet the high standards of the industrial manufacturing industry. We use only the best equipment and materials to ensure maximum performance.

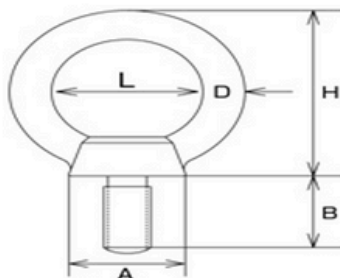

Metric Thread SUS304

(mm)

Item Code	D	L	H	B	A	Thrd.	Wt. (g)	WLL	
								(kgf)	(kN)
IBF-6M	5	14.5	26.5	14	13	M-6	18	50	0.49
IBF-8M	6.3	20	33.3	15	16	M-8	33	80	0.78
IBF-10M	8	25	41.5	18	20	M-10	70	150	1.47
IBF-12M	10	30	51	22	25	M-12	125	220	2.16
NEW IBF-14M	12.5	35	60	27	30	M-14	220	330	3.23
IBF-16M	12.5	35	60	27	30	M-16	220	450	4.41
NEW IBF-18M	16	40	71	30	35	M-18	370	540	5.29
IBF-20M	16	40	71	30	35	M-20	380	630	6.18
NEW IBF-22M	18	45	81	35	40	M-22	575	800	7.84
IBF-24M	20	50	90	38	45	M-24	760	950	9.31



## WHEEL BOLT



**Our team of experts can handle all of your custom fabrication needs, from design to installation. We have the experience and expertise to create unique solutions for your industrial manufacturing needs.**

**Durable and high-strength wheel bolts for commercial vehicle and trailer applications.**

**Cold-forged and heat-treated for fatigue resistance under road stress.**

**Available with ball seat, flat seat, or conical seat types.**

**Threaded to precise tolerances for safe and secure fastening.**

**Compliant with industry safety and load-bearing standards.**



# AUTOMOTIVE FASTENERS



Automotive Bolt Covers



Automotive Cable Straps



Automotive Plug Gaskets



Automotive Pins



Automotive Bushings



Automotive License Plate Nuts



Automotive Fastener Assortment Kits



Automotive Vacuum Caps



Automotive Plugs



Automotive Shims



Automotive Bumpers



Automotive Moulding Fasteners



Automotive Washers



License Plate and Headlight Screws



Automotive Rivets

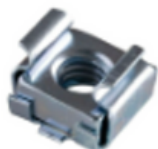

Cage Nuts



Automotive Grommets



Automotive Bolts



Spring Nuts



Automotive Nuts



Automotive Clips and Clamps



Automotive Retainers

**We offer prototype development services to help you test your product before going into full production. Our team will work with you to refine your design and ensure the final product meets your specifications.**

**Comprehensive range of fasteners used across automotive body, chassis, and engine systems.**

**Includes clips, rivets, push pins, panel fasteners, and high-torque bolts.**

**Tested for vibration, corrosion, and thermal cycling performance.**

**Designed to meet OEM and Tier 1 quality benchmarks.**

**Custom kitting and labeling available for assembly line integration.**





# FASTENER ASSORTMENT KITS



**We offer prototype development services to help you test your product before going into full production. Our team will work with you to refine your design and ensure the final product meets your specifications.**

**Conveniently organized kits containing mixed fasteners for repair, service, or field work.**

**Includes nuts, bolts, washers, pins, and clips in assorted sizes and materials.**

**Packed in sturdy boxes with labeled compartments for easy access.**

**Ideal for workshops, maintenance teams, and on-the-go technicians.**

**Customizable kits available for dealer and aftermarket channels.**

## THREAD SEALANT

**Thread sealants are specialized compounds used to seal and secure threaded joints in a wide range of industrial, plumbing, automotive, and mechanical applications. They prevent leakage of gases and liquids by filling gaps and providing a tight, durable seal between threaded metal or plastic parts.**



## THREAD LOCKER

**Thread lockers are advanced adhesive compounds designed to lock and seal threaded fasteners, preventing loosening caused by vibration, shock, or thermal expansion. Used widely across industries, they improve the reliability and safety of bolted assemblies by keeping threads firmly in place.**







## CONTACT INFORMATION

REX Consolidated  
80 DLF Industrial Area Phase 1  
Faridabad Haryana-121003  
India

© Copyright 2022 Invicta India Pvt. Ltd.

All information and data stated in this Product Range document has been compiled with utmost care. Nevertheless, Invicta accepts no liability for any errors, omissions or other inaccuracies contained herein. Subject to change without notice. Reprinting or reproduction, in whole or in part, including of photographs, illustrations or graphics, is not permitted without the prior written consent of Invicta India Pvt. Ltd.. We reserve all rights in connection with this document.

Any similarity or resemblance is unintended and is merely a coincidence. The vehicle applications cited in this Product Range document may possibly be valid only up to the date printed on the last of the document. All references made in this Product Range document to the item numbers of vehicle manufacturers and/or competitors are provided for the purpose of comparison only. Such information is not allowed to be used in invoices issued to vehicle owners.

For enquiries, please email us : [rahul@invictaindia.com](mailto:rahul@invictaindia.com)

All drawings & illustrations are the property right of INVICTA and cannot be copied, duplicated or re-printed in any form without the prior written consent from INVICTA

Invicta Copyright @ 2022  
All Right Reserved