

Table of Contents

Tap Connectors

Mechanical (Bolted)H-3 - H-20

Compression.....H-21 - H-40

Transformer and Equipment.....H-41 - H-43



Compression Splices

Service EntranceH-46 - H-48

NeutralH-49

Jumper.....H-50 - H-54

Repair Sleeve.....H-55

Full Tension.....H-56 - H-70



Deadend Fitting and Accessories

LoopH-72 - H-73

Primary and Strain Bus.....H-74 - H-75

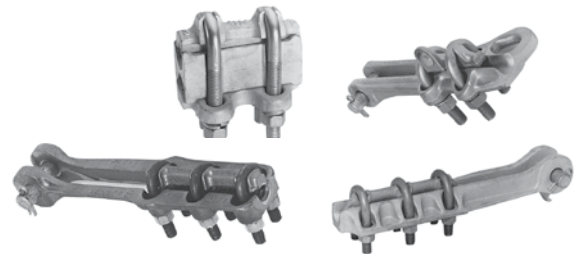

Compression Terminals and Accessories.....H-77 - H-82



Table of Contents

Tap Connectors

Mechanical (Bolted)	H-3 - H-20
Types KS, KS-3.....	H-4
Type SC.....	H-5
Type KSU.....	H-5
Type KVS.....	H-6
Type KVSW.....	H-6
Type KVSU.....	H-7
Type KVS-A.....	H-8
Type VG.....	H-9
Type UC-L.....	H-10
Type UCK-UL.....	H-10
Type CP-A.....	H-11
Type VP.....	H-12
Type UW-R.....	H-12
Type UC.....	H-13
Type CP.....	H-13
Type QPX.....	H-14
Type VT.....	H-15
Types UCG-R, UCG-RS.....	H-16
Types UC-R, UC-RS.....	H-16
Type UCT.....	H-17
Type UCT for Copper.....	H-18
Type UC-KIT.....	H-19
Type UC-COVER.....	H-19
Type UCTCOVER.....	H-19
Type LSC.....	H-20
Compression	H-21 - H-40
Compression Tap Connectors.....	H-21
Type YC-C.....	H-22
Type YP-C.....	H-22
Type YC-A.....	H-23
Type YP-U.....	H-24
Type YPC-U.....	H-25
Type YC-U.....	H-26
Types YPC-A-U, YPC-R-U.....	H-26
Type CC.....	H-27
Seven Connector Selector Chart	H-28
Types YHO, YHD.....	H-29
Types YHN, YHR.....	H-30
LOKTAP™.....	H-31
Type YCT.....	H-32
Type YOT.....	H-32
Type YTU-R-R.....	H-33
Type YTA-R-2N.....	H-34
Types YKA-R-2N, YKA-A-2N.....	H-35
Type YSA-R-2N.....	H-36
Type YTA-2N.....	H-36
Type YKA-R-2N.....	H-37
Type YCB-R.....	H-38
Types YCB-U, YCB-R-U.....	H-39
Types J990, J1252.....	H-39
Types YHO-J, YHD-J, YHN-J.....	H-40

Transformer and Equipment	H-41 - H-43
Type E-C-G.....	H-41
Types KC22J12T13, EQC632C.....	H-42
Type YA-2LH.....	H-42
Type YE-LH.....	H-43
Types YE-R, YE-W.....	H-43

Mechanical (Bolted) Tap Connectors

The BURNDY line of mechanical tap connectors is the most complete, dependable and economical available. These mechanical connectors consist of service, parallel, and midspan types.

Generally the alloys and hardware used depend on whether the connector is for a strain or current carrying application, and is made of aluminum or copper. Particular alloys and hardware are selected for strength, conductivity, durability, ductility and resistance to corrosion.

In a copper connector, high strength alloys are used in mechanical clamping components and high conductivity alloy in current carrying elements.

Aluminum clamp type connectors are made of alloy 356, which is impervious to stress corrosion. In its heat-treated state, it has high strength and is used for both current carrying and clamping elements.

Hardware is high strength and corrosion-resistant. In copper connectors, DURIMUM™, a silicon bronze alloy, is used. Anodized aluminum alloy 2024-T4 bolts and 6061-T6 nuts are used in aluminum connectors. They provide the best combination of strength, resistance to galling and corrosion, and their thermal coefficient of expansion is most suitable for aluminum. To insure dependable connections, bolts should be tightened to the recommended torque values shown in the specific product table or in the table below.

These mechanical tap connectors are mainly used in overhead distribution systems to provide primary service taps and/or secondary service drop connections to the end users.

A few of the key features and benefits of these connectors are:

Features and Benefits

- High strength alloys provides efficient and reliable performance
- Range taking designs accommodate a large range of conductors in either groove; reducing inventory needs to a minimum
- Matched groove designs ensure maximum contact with conductors accommodated
- Hex bolts, nuts, and washers provide high contact pressure and rapid assembly

Recommended Tightening Torque		Standard Wrench Size	
Bolt Size	Recommended Torque (Inch Lbs.)	Bolt	Nut
DURIMUM™ Silicon Bronze and Galvanized Hardware			
1/4 - 20	80	7/16	7/16
5/16 - 18	180	1/2	1/2
3/8 - 16	240	9/16	9/16
1/2 - 13	480	3/4	3/4
5/8 - 11	660	15/16	15/16
3/4 - 10	1050	1-1/8	1-1/8
Aluminum Hardware*			
1/2 - 13	300	3/4	3/4
5/8 - 11	480	15/16	15/16
3/4 - 10	620	1-1/8	1-1/8

* Aluminum bolts are lubricated.

If no tightening torque is listed in the following catalog pages, use values in table above.

Torque Range	Recommended BURNDY® Torque Wrench
30 - 150 in-lbs	BTW30150
150 - 750 in-lbs	BTW150750



SERVIT® Types KS, KS-3

Split-bolt connectors for copper, copperweld

Material: Copper

Compact, high strength, high copper alloy SERVIT® split-bolt has free-running threads and easy to grip wrench flats. Highly resistant to season cracking and corrosion, the SERVIT® connectors provide maximum pressure and assure a secure connection on all combinations of run and tap conductors. Type KS-3 accommodates 3 maximum size conductors.

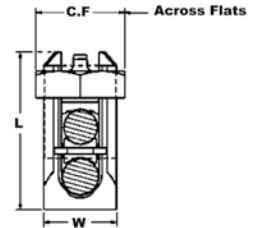
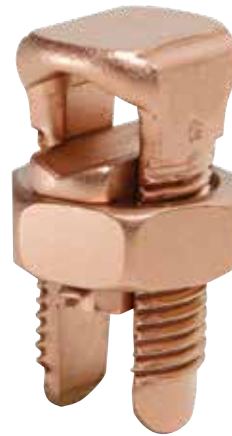

Catalog Number	L	W	Conductor						▲ Recommended Tightening Torque(in-lb)	Wrench Size (across flats)
			Copper		Copperweld					
			Range for Equal Run and Tap	Min. Tap with Max. Run	Maximum Run and Tap					
					Sol.	Str.	Type A	Type D		
† KS90	0.85	0.38	12 Str. - 10 Str.	16 Str.	#10	—	—	—	80	1/2
† KS15	0.85	0.38	10 Str. - 8 Str.	14 Str.	#8	—	—	—		
† KS17	1.14	0.45	8 Str. - 6 Sol.	14 Str.	#6	3 #12	8A	9-1/2D	165	5/8
* KS173	0.98	0.70	8 Str. - 6 Sol.	16 Str.	#6	3 #12	8A	9-1/2D		
† KS20	1.20	0.51	8 Str. - 4 Sol.	14 Str.	#4	3 #10	6A	8D		11/16
* KS203	1.17	0.78	8 Str. - 4 Sol.	14 Str.	#4	3 #10	6A	8D		
† KS22	1.50	0.60	6 Str. - 2 Sol.	14 Str.	#2	3 #8	4A	6D	275	3/4
* KS223	1.33	0.84	6 Str. - 2 Sol.	14 Str.	#2	3 #8	4A	6D		
† KS23	1.54	0.62	6 Str. - 2 Str.	14 Str.	#1	3 #7	3A	5D		7/8
† KS25	1.77	0.73	4 Str. - 1/0 Str.	14 Str.	2/0	3 #5	2A	4D	385	1
† KS26	1.94	0.82	2 Str. - 2/0 Str.	14 Str.	3/0	7 #7	—	—		1-1/16
† KS27	1.86	1.17	1 Str. - 3/0 Str.	8 Sol.	—	—	—	—	500	1-3/8
† KS29	2.07	1.17	1 Str. - 250	8 Str.	4/0	7 #5	—	—	650	1-7/16
† KS31	2.51	1.41	1/0 Str. - 350	1/0 Str.	—	19 #8	—	—		2
† KS34	2.79	1.48	2/0 Str. - 500	2/0 Str.	—	19 #6	—	—	825	2-3/16
KS39	3.29	1.94	4/0 Str. - 750	4/0 Str.	—	19 #5	—	—	1000	2-3/8
KS44	3.73	2.19	300 - 1000	4/0 Str.	—	—	—	—	1100	2-9/16

▲ Listed torque values are for maximum conductor combinations accommodated. Consult UL486 Tables 7-4, 7-5, 7-6 for smaller conductor combinations.

See note page A-2

* Not UL Listed or CSA Certified.

† In addition to UL Listed for wire connectors and CSA Certified, these items are also UL rated for direct burial.

To ensure proper tightening torque use BURNDY® BTW Torque Wrenches.

SERVIT® Cover Type SC
 Split-bolt SERVIT® Connector Cover

Material: Plastic



Used indoors or outdoors this compact, one-piece plastic SERVIT® cover, saves time and material, eliminates costly taping of split-bolts. Positive latch snaps easily and quickly over connector, ideal for tight quarters. Self positioning plastic fingers wrap around wires fully insulating joint. UL Listed for 600 volt indoor application. Three covers accommodate a range of 6 SERVIT® sizes through 2/0 Stranded.

Catalog Number	Conductor Range				*For Use with	For Use with
	Range for Equal Run/Tap		Min. Tap/Max. Run			
	Min.	Max.	Min.	Max.		
SC4	8 Str.	6 Sol.	14 Str.	6 Sol.	KS17	—
SC4	8 Str.	4 Sol.	14 Str.	4 Sol.	KS20	—
SC2	6 Str.	2 Sol.	14 Str.	2 Sol.	KS22	KSA6
SC2	6 Str.	2 Str.	14 Str.	2 Str.	KS23	KSA4
SC2/0	4 Str.	1/0 Str.	14 Str.	1/0 Str.	KS25	KSA2
SC2/0	2 Str.	2/0 Str.	14 Str.	2/0 Str.	KS26	KSA1/0

* UL Listing of Type SC Cover applies to use on BURNDY® SERVIT® Type KS and equivalent split-bolt connectors, when indicated strip length is maintained, maximum indicated conductor sizes are not exceeded, and connector is properly located within recess provided for it.

Universal SERVIT® Type KSU
 Split-bolt connectors for copper, copperweld, AAC, ACSR, AAAC, Steel

Material: Copper (Tin Plated)

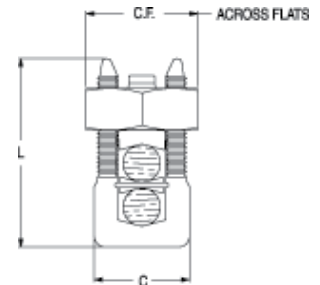

Tin-plated, high strength copper alloy SERVIT® connector with spacer. Spacer separates dissimilar conductors and provides long contact length that prevents high pressure point contacts between run and tap conductors. Use of PENETROX™ joint compound recommended with Aluminum and ACSR to limit oxide growth and increase life of connection. To ensure proper tightening torque use of BURNDY® Torque Wrenches Type BTW is recommended.

Catalog Number	L	C	Run		Tap		Max. Conductor			Recommended Tightening Torque in-lb	Wrench Size (across Flats)
			Copper & Aluminum	ACSR / AAAC / 5005	Copper & Aluminum	ACSR / AAAC / 5005	Steel				
							Sol. 3 Str. Nom. BWG Dia.				
KSU17	0.92	0.42	12 Sol. - 6 Sol.	8 (6-1)	12 Sol. - 6 Sol.	8 (6-1)	8	—	5/32	165	5/8
KSU20	1.05	0.48	10 Sol. - 4 Sol.	6 (6-1)	10 Sol. - 4 Sol.	6 (6-1)	6	8	7/32		11/16
KSU22	1.25	0.57	10 Sol. - 2 Sol.	6 (6-1) - 4 (7-1)	10 Sol. - 2 Sol.	6 (6-1) - 4 (7-1)	4	6	1/4	275	3/4
KSU23	1.48	0.59	8 Str. - 2 Str.	3 (6-1) - 2 (6-1)	8 Sol. - 2 Str.	6 (6-1) - 2 (6-1)	—	4	5/16		13/16
KSU25	1.77	0.70	2 Str. - 1/0 Str.	3 (6-1) - 1 (6-1)	10 Str. - 1/0 Str.	6 (6-1) - 1 (6-1)	—		3/8	385	15/16
KSU26	1.93	0.79	2 Str. - 2/0 Str.	1 (6-1) - 1/0 (6-1)	8 Str. - 2/0 Str.	6 (6-1) - 1/0 (6-1)			7/16		1-1/16
KSU27	2.34	1.12	1 Str. - 3/0 Str.	1 (6-1) - 2/0 (6-1)	8 Sol. - 3/0 Str.	8 (6-1) - 2/0 (6-1)			1/2	500	1-3/8
KSU29	2.50	1.58	1 Str. - 250	2/0 (6-1) - 4/0 (6-1)	8 Str. - 250	6 (6-1) - 4/0 (6-1)	5/8		650	1-11/16	
KSU31	2.88	1.36	1/0 Str. - 350	3/0 (6-1) - 4/0 (6-1)	4 Str. - 350	4 (6-1) - 4/0 (6-1)			825		1-13/16
KSU34	3.12	1.47	400 - 500	336 (30-7) - 477 (18-1)	2 Str. - 500	2 (6-1) - 477 (18-1)	—				

OKLIP™ Type KVS

Connector for Copper, Copperweld

Material: Copper



Compact, two-piece, high strength, high copper alloy OKLIP™ connector recommended for heavy duty connections. Neoprene rings hold bolts in place during installation. Installed with ordinary wrench.

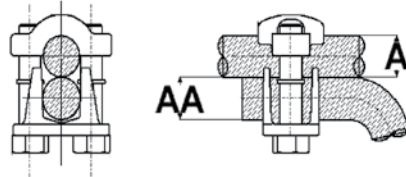

Catalog Number	Conductor					Recommended Tightening Torque (in-lb)	Wrench Size (Cross flats)
	Copper		Copperweld				
	Run (A)	Tap (AA)	Max. Run & Tap				
		Sol.	Str.	Type V			
KVS26	1 Str. - 2/0 Str.	6 Str. - 2/0 Str.	3/0	7 #8	—	180	1/2
KVS28	1/0 Str. - 4/0 Str.	10 Str. - 4/0 Str.	4/0	7 #6	V3/0	250	9/16
KVS31	250 - 350 kcmil	10 Str. - 350 kcmil	—	19 #8	V250	325	3/4
KVS34	400 - 500 kcmil	10 Str. - 500 kcmil	—	19 #6	V350	375	3/4
KVS40	400 - 800 kcmil	3/0 Str. - 800 kcmil	—	19 #5	—	500	3/4
KVS44	500 - 1000 kcmil	3/0 Str. - 1000 kcmil	—	—	—	500	15/16

To ensure proper tightening torque use BURNDY® BTW Torque Wrenches.

OKLIP™ Type KVSW

Connector for Copper, Copperweld

Material: Copper

Similar to OKLIP™ Type KVS except for high copper alloy spacer that separates run and tap conductor. Provides high contact pressure, confines conductor strands, and assures vibration proof connection. Longer peened bolt permits swivel action for easier installation.



Catalog Number	Conductor		Wrench Size (Cross Flats)	Torque in - lb
	Run	Tap		
KVSW26	2 Str. - 2/0 Str.	6 Sol. - 2/0 Str.	1/2	180
KVSW28	1/0 Str. - 4/0 Str.	6 Sol. - 4/0 Str.	9/16	250
KVSW31	250 - 350 kcmil	4 Sol. - 350 kcmil	3/4	325
KVSW34	400 - 500 kcmil	4 Str. - 500 kcmil	3/4	375
KVSW40	400 - 800 kcmil	4/0 - 800 kcmil	3/4	500
KVSW44	500 - 1000 kcmil	250 - 1000 kcmil	15/16	500

To ensure proper tightening torque use BURNDY® BTW Torque Wrenches.

Universal OKLIP™ Type KVSU

Connector for Copper, Copperweld, AAC†, AAC†

Material: Copper (Tin Plated)

Compact, high strength, tin-plated copper alloy two-piece connector with spacer and tin-plated silicon bronze DURIMUM™ hardware. Recommended for heavy duty connections. Spacer separates dissimilar conductors and provides long contact length. Neoprene ring prevents loss of shorter bolt during installation. Longer peened bolt permits swivel action for easier installation. Use of PENETROX™ joint compound is recommended with aluminum and ACSR conductor.

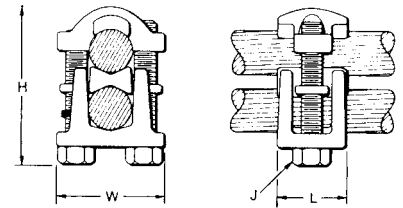

Catalog Number	Conductor								H	J	L	W	Rec. Tightening Torque (in-lb)	Wrench Size (Cross Flats)
	Run		Tap		Run		Tap							
	Copper & Alum.	ACSR, AAAC, & 5005	Copper & Alum.	ACSR, AAAC, & 5005	Copper Sol., Copperweld Sol.	Steel Nom. Dia.	Copper Sol., Copperweld Sol.	Steel Nom. Dia.						
KVSU26	2 Str. - 2/0 Str.	3 - 2/0	6 Str. - 2/0 Str.	6 - 2/0	1 - 3/0	5/16 - 7/16	#6 - 3/0	3/16 - 7/16	2	5/16	1	1-1/2	180	1/2
KVSU28	1/0 Str. - 4/0 Str.	1/0 - 4/0	6 Str. - 4/0 Str.	6 - 4/0	2/0 - 4/0	3/8 - 1/2	#6 - 4/0	5/32 - 1/2	2-3/8	3/8	1-1/8	1-3/4	250	9/16
KVSU31	250 - 350 kcmil	4/0 - 300	#5 - 350	6 - 300	—	9/16 - 5/8	#6 - 4/0	3/16 - 5/8	2-5/8	1/2	1-3/8	2-1/8	325	3/4
KVSU34	400 - 500 kcmil	336.4 - 397.5	#4 - 500	5 - 397.5	—	3/4 - 3/4	#4 - 4/0	7/32 - 3/4	3	1/2	1-1/2	2-1/4	375	3/4
KVSU40	400 - 800 kcmil	336.4 - 715.5	4/0 - 800	3/0 - 715.5	—	3/4 - 1	—	1/2 - 1	3-1/2	1/2	1-5/8	2-1/2	500	3/4
KVSU44	500 - 1000 kcmil	397.5 - 900	4/0 - 1000 kcmil	4/0 - 900	—	7/8 - 1-1/8	—	1/2 - 1-1/8	4	3/8	2	3	500	5/16

† Accommodates compressed conductors within diameter range.
 To ensure proper tightening torque use BURNDY® BTW Torque Wrenches.

OKLIP™ Type KVS-A

Connector for Copper, Copperweld, AAC†, ACSR†, AAAC

Material: Aluminum

Three-piece, high-conductivity, non-copper bearing aluminum alloy connector with thick spacer and aluminum hardware. Hardware in KVS26A and KVS28A is stainless steel. Recommended for heavy duty dissimilar metal applications. Spacer separates conductors and provides long contact length. Belted entrances prevent chafing and permit easier assembly of conductors. Longer, peened bolt, permits swivel action for easier installation. Neoprene ring prevents loss of shorter bolt. PENETROX™ joint compound recommended with aluminum and ACSR.

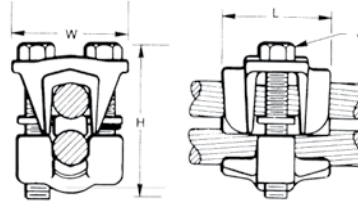

Catalog Number	Conductor			
	Run		Tap	
	Copper & Aluminum†	ACSR†, AAAC, & 5005	Copper & Aluminum†	ACSR†, AAAC, & 5005
KVS26A	2 Str. - 2/0 Str.	#4 - 2/0	10 Str. - 2/0 Str.	#6 - 2/0
KVS28A	1/0 Str. - 4/0 Str.	1/0 - 4/0	10 Str. - 4/0 Str.	#6 - 4/0
KVS31A	250 - 350	4/0 - 336.4	6 Str. - 350 kcmil	#6 - 336.4 kcmil
KVS34A	400 - 500	336.4 - 397.5	4 Str. - 500 kcmil	#5 - 397.5 kcmil
KVS40A	400 - 800	336.4 - 715.5 kcmil	3/0 Str. - 800 kcmil	3/0 - 715.5
KVS44A	500 - 1000	397.5 - 900 kcmil	3/0 Str. - 1000 kcmil	3/0 - 900 kcmil

† Accommodates compressed conductors within diameter range.
To ensure proper tightening torque use BURNDY® BTW Torque Wrenches.

THESE CONNECTORS CAN ACCOMMODATE ACSR CONDUCTORS OVER ARMOR ROD WITHIN THE DIAMETER RANGE INDICATED.

Application Over Armor Rod

Catalog Number	Conductor Range by Diameter			H	J	L	W
	Min. Run Dia.	Min. Tap Dia.	Max Run & Tap Dia.				
KVS26A	0.28	0.11	0.44	2	5/16	1-3/8	1-5/8
KVS28A	0.36	0.11	0.56	2-3/8	3/8	1-5/8	2
KVS31A	0.56	0.18	0.68	3	1/2	2	2-5/8
KVS34A	0.72	0.21	0.81	3-3/8	1/2	2-1/2	2-5/8
KVS40A	0.72	0.47	1.03	4	1/2	3-1/8	3
KVS44A	0.80	0.47	1.16	4-1/2	5/8	3-1/2	3-3/8

WISEIT™ Type VG Connector for Copper

Material: Copper

Copper WISEIT™ connectors are easy to install and will not swivel. The interlocking parts will not rotate out of the body. Supplied with hex head bolts; VG1 size has a slotted hex bolt.

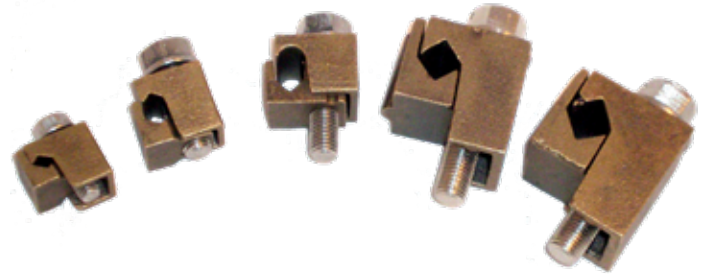

Features and Benefits

- Single tool installation keeps other hand free to contain conductors
- Compact profile after installation facilitates taping and alignment with conductors
- Accommodates a wide range of conductors and minimizes number of connectors required
- Side installation of conductors eliminates having to separate pieces during installation
- Copper alloy body design provides combination of strength and corrosion resistance

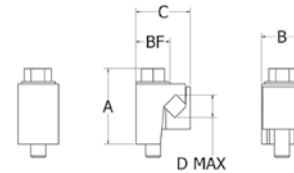

Catalog Number	Conductor Range ①		A	B	C	Bolt Head (Hex.)	Recommended Torque (In-Lb)
	Max. 2 Conductor	Min. 2 Conductor					
VG1 ②	6 Sol.	10 Sol.	0.94"	0.63"	0.75"	3/8" (Slotted)	110 lbs/in
VG2	4 Str.	8 Str.	1.09"	0.70"	0.81"	9/16"	110 lbs/in
VG3	2 Sol.	6 Sol.	0.98"	0.83"	0.94"	9/16"	150 lbs/in
VG4	1/0 Str.	4 Sol.	1.70"	1.00"	1.33"	9/16"	180 lbs/in
VG5	2/0 Str.	3 Sol.	1.80"	0.98"	1.28"	9/16"	180 lbs/in

① Connectors are capable of accepting any combination of conductors of conductors within specified maximum range (example: VG1 can accept 7 Sol. - 9 Str. combination)

② The VG1 hardware has a slotted hex. The other sizes are unslotted. Hardware is stainless steel.

Universal Parallel Groove Clamp, Type UC-L

For Copper, Copperweld, AAC†, ACSR†, AAAC, Steel

Material: Copper (Tin Plated)

Interlocking finger design accommodates large range of conductor sizes. Tin-plated, cast of high copper alloy, and clamped with plated steel bolt. PENETROX™ joint compound recommended with aluminum and ACSR.

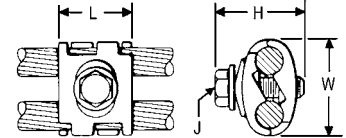

Catalog Number	Copper & Alum. (Either Groove)	ACSR†, 6201, 5005	Copperweld	Steel		Dimensions				Wrench (Cross flats)	Torque in - lb
				Nom. Dia.	AWG	L	H	J	W		
UC8W26L	8 Sol. - 2/0 Str.	6 - 1/0	8 Sol. - 7 #7	5/32 - 7/16	8 Sol. - 4-3 Str.	1	1-1/2	5/16	1-7/16	1/2	180
UC2W28L	2 Sol. - 4/0 Str.	3 - 4/0	3 #8 - 7 #6	9/32 - 9/16	4 - 3 Str. - 4 - 3 Str.	1-1/8	1-1/2	3/8	1-3/4	9/16	250

† Accommodates compact and compressed conductors within diameter range. To ensure proper tightening torque use BURNDY® BTW Torque Wrenches. Torque values are for max. conductor sizes.

Universal Parallel Groove Clamp, Type UCK-UL

For Copper, Copperweld, AAC, ACSR, AAAC, Steel

Material: Copper (Tin Plated)



Interlocking finger design accommodates large range of conductor sizes. Tin-plated, cast of high copper alloy, and clamped with silicon bronze DURIMUM™ bolt. PENETROX™ joint compound recommended with ACSR. Applications include grounding for the Cable TV industry.

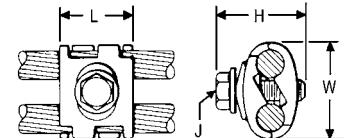

Catalog Number	For Use With:	Conductor Range				Dimensions				Wrench Size (Cross flats)	Torque in - lb
		Groove A		Groove B		L	H	J	W		
		Maximum Size	Minimum Size	Maximum Size	Minimum Size						
UCK1UL †	Aluminum or Galvanized Steel Strand to Copper or Copper Bonded Steel Wire	1/0 ACSR 7/16 Galvanized Steel Strand	#6 ACSR	2/0 Str. Copper 7/16 Copperweld, 2A Copperweld	#8 Sol. Copper 9-1/2D Copperweld	1	1-7/16	5/16	1-7/16	1/2	180
UCK2UL	Aluminum or Galvanized Steel Strand to Aluminum or Galvanized Steel Strand	1/0 ACSR 7/16 Galvanized Steel Strand	#6 ACSR	1/0 ACSR or 7/16 Galvanized Steel Strand	#6 ACSR					1/2	180
UCK3UL	Copper to Copper	2/0 Str. Copper 7/16 Copperweld 2A Copperweld	#8 Sol. Copper 9-1/2D Copperweld	2/0 Str. Copper 7/16 Copperweld 2A Copperweld	#8 Sol. Copper 9-1/2D Copperweld					1/2	180

† Accommodates compact and compressed conductors within diameter range. To ensure proper tightening torque use BURNDY® BTW Torque Wrenches. Torque values are for max. conductor sizes.

Parallel Groove Clamp, Type CP-A

For Copper, Copperweld, AAC†, ACSR, AAAC, Steel

Material: Aluminum (Cast), Aluminum Hardware

Type CP-A Parallel Groove Clamps are recommended for tap or parallel connections. High strength, high conductivity aluminum body and hardware provide corrosion resistant assembly. Long contact surface for excellent contact and full conductivity. PENETROX™ joint compound recommended for all combinations.

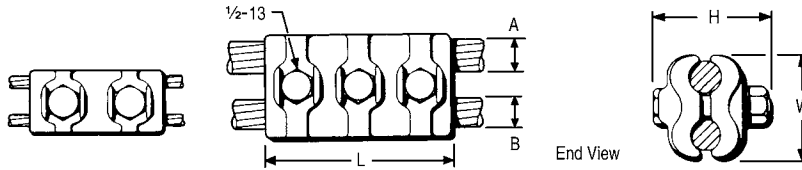

Fig. 1

Fig. 2

Catalog Number	Groove A		Groove B		Fig. No.	Dimensions			Wrench Size (cross flats)	Torque in - lb
	ACSR, 6201, 5005	Copper & Aluminum	ACSR, 6201, 5005	Copper & Aluminum		L	H	W		
CP26A26A	1/0	3/0 Sol. - 2/0 Str.	1/0	3/0 Sol. - 2/0 Str.	1	4"	2-7/8"	2.13	3/4	480
CP27A27A	2/0 101.8 (12-7) 110.8 (12-7)	4/0 Sol. - 3/0 Str.	2/0 101.8 (12-7) 110.8 (12-7)	4/0 Sol. - 3/0 Str.						480
CP28A28A	3/0 134.6 (12-7)	4/0 Str.	3/0 134.6 (12-7)	4/0 Str.						480
CP29A29A	4/0 159 (12-7) 203 (8-7)	250 266.8	4/0 159 (12-7) 203 (8-7)	250 266.8						480
CP30A30A	176.9 (12-7) 190.8 (12-7) 266.8 (18-1, 6-7, 26-7)	300	176.9 (12-7) 190.8 (12-7) 266.8 (18-1, 6-7, 26-7)	300	2	4-1/2"	2.38	3/4	480	
CP31A31A	211.3 (12-7) 300 (26-7, 30-7) 336.4 (18-1)	336.4 350	211.3 (12-7) 300 (26-7, 30-7) 336.4 (18-1)	336.4 350					480	
CP32A32A	203.2 (16-19) 336.4 (26-7, 30-7) 397.5 (18-1)	397.5 400	203.2 (16-19) 336.4 (26-7, 30-7) 397.5 (18-1)	397.5 400					480	
CP34A34A	397.5 (26-7, 30-7) 477 (18-1)	450 477 500	397.5 (26-7, 30-7) 477 (18-1)	450 477 500					480	
CP37A37A	500 (30-7) 556.5 (24-7, 26-7, 30-7) 636 (36-1) 605 (24-7)	636	500 (30-7) 556.5 (24-7, 26-7, 30-7) 636 (36-1) 605 (24-7)	636	5-1/4"	3-3/8"	3.00		480	

† Accommodates compact and compressed conductors within diameter range. For other sizes contact factory.
Not recommended for copper to copper applications. Use copper connector.
To ensure proper tightening torque use BURNDY® BTW Torque Wrenches.

Parallel Groove Clamp, Type VP For Copper

Material: Copper

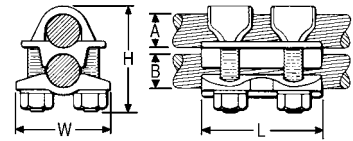

Multiple V-bolt connector especially suited for flexible or extra flexible conductors. Made of high strength, high conductivity copper. Clamping elements accommodate a range of conductor sizes in either groove. V-bolts provide high pressure and compress the conductor over long contact area. Also recommended for jumper connections.

Catalog Number	Groove A	Groove B	Dimensions			Wrench Size (Cross flats)	Torque in - lb
			L	H	W		
VP2828	1/0 Str. - 4/0 Str.	1/0 Str. - 4/0 Str.	2-3/4"	2-1/8"	1.75"	9/16	250
VP3030	1/0 Str. - 300	1/0 Str. - 300	3-1/8"	2-1/2"	2.00"	11/16	325
VP3430	300 - 500		3-1/4"	3-1/8"	2.50"	3/4	375
VP3434		300 - 500					
VP4030	500 - 800	1/0 Str. - 300	3-1/2"	4-3/8"	2.88"	7/8	500
VP4040		500 - 800	3-3/4"				
VP4440	750 - 1000	500 - 800	3-7/8"	5"	3.19"	15/16	600
VP4646	1000 - 1500		4-1/2"	5-3/8"	3.50"		

To ensure proper tightening torque use BURNDY® BTW Torque Wrenches.

CLIPIT™ Dead End Clamp, Type UW-R For AAC†, ACSR†, AAAC

Material: Aluminum (Cast)

High strength aluminum casting with galvanized steel U-bolt, extra long aluminum spacer, and caps that confine strands. Holding strength of installations using two CLIPIT™ deadends exceeds rated breaking strength of conductor. Use of PENETROX™ joint compound is recommended.

RUS Accepted

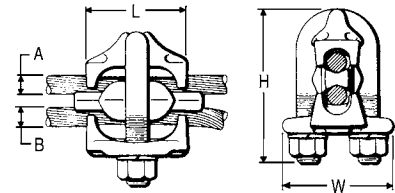
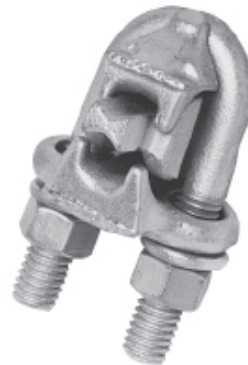

Catalog Number	Run A		Tap B		Dimensions			Wrench	Torque in - lb
	ACSR, 6201, 5005	Aluminum	ACSR, 6201, 5005	Aluminum	L	H	W		
UW2R	6 - 2	6 Str. - 2 Str.	6 - 2	6 Str. - 2 Str.	1-1/2"	2-5/8"	1.82"	9/16	240
UW25R	6 - 1/0	6 Str. - 2/0 Str.	6 - 1/0	6 Str. - 2/0 Str.	1-7/8"	2-7/8"	1.98"		240

† Accommodates compact and compressed conductors within diameter range.
To ensure proper tightening torque use BURNDY® BTW Torque Wrenches.

Parallel Groove Clamp, Type UC For Copper

Material: Copper

Type UC connector accommodates large range of conductors in either groove, reducing inventory to a minimum. Interlocking finger design provides firm grip with maximum contact length. High strength, corrosion resistant silicon bronze hardware. One wrench installation.

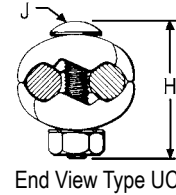

Fig. 1

Catalog Number	Conductor (Either Groove)	Fig.	Dimensions				Wrench Size (Cross flats)	Torque in - lb
			L	H	J	W		
UC6W25	6 Sol. - 1/0 Str.	1	1-3/4"	1-5/8"	3/8"	1-3/8"	9/16	240
UC4W28	4 Sol. - 4/0 Str.	2	2-1/8"	2"		1-3/4"		240
UC2W30	2 Sol. - 300			2-3/8"	2-1/8"	2"		240
UC2834	4/0 Str. - 500	3	4-1/4"	2-7/8"	1/2"	2-1/2"	3/4	480
UC3040	300 - 800			3-3/8"		3"		480
UC3444	500 - 1000			3-5/8"		3-1/2"		480

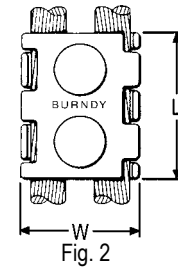

Fig. 2

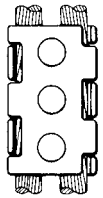

Fig. 3

To ensure proper tightening torque use BURNDY® BTW Torque Wrenches

Parallel Groove Clamp, Type CP For Copper

Material: Copper

High strength, high copper alloy Type CP clamps are recommended for heavy duty parallel connections. Silicon bronze DURIUM™ hardware and cast copper body provides corrosion resistant assembly. Long contact surface provides excellent and assures full conductivity.



Fig. 1

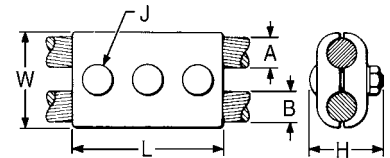

Fig. 2

Catalog Number	Groove		Fig.	Dimensions			Wrench Size (Cross flats)	Torque in - lb
	A	B		L	J	W		
CP2C2C	2 Str.	2 Str.	1	2-1/2"	3/8"	1-1/4"	9/16	240
CP2525	1/0 Str.	1/0 Str.		3"		1-5/8"		240
CP2626	2/0 Str.	2/0 Str.						240
CP2828	4/0 Str.	4/0 Str.	2	4"	1/2"	2"	3/4	240
CP2929	250	250						240
CP3434	500	500		5"		2-1/2"		480

For other sizes contact factory.

To ensure proper tightening torque use BURNDY® BTW Torque Wrenches

VERSITAP™ Connector, Type QPX

For Copper, Copperweld

Material: Copper

The VERSITAP™ Type QPX connector is recommended for Tee, Cross, Parallel, Butt, and Tap connections. Range-taking, only requires 10 connectors to accommodate conductor sizes from #6 Stranded to 1000 kcmil. Edges are rounded for easy taping. Made of high strength, high conductivity copper alloy and supplied with silicon bronze DURIMUM™ hardware.

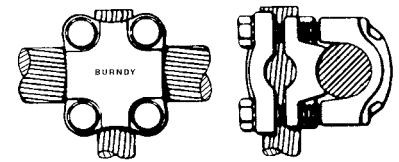
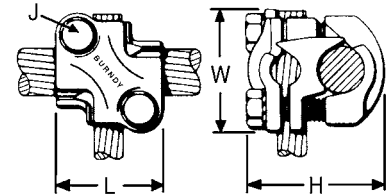

PARALLEL



TAP

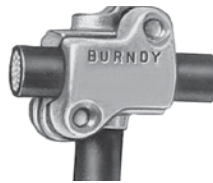

TEE



CROSS



BUTT

Catalog Number	Run			Tap			Dimensions				Wrench Size (Cross Flats)	Torque in - lb
	Copper Str - RUN	Copperweld Solid - RUN	Copperweld Str - RUN	Copper Str - TAP	Copperweld Solid - TAP	Copperweld Str - TAP	L	H	J	W		
QPX2C2C	6 Str. - 2 Str.	5 Sol. - 3 #7	8A - 4A	6 Str. - 2 Str.	5 Sol. - 3 #7	8A - 4A	1-3/8	1.50	5/16	1-3/8	1/2	150
QPX282C	1 Str. - 4/0 Str.	7 #9 - 7 #5	3A - 3/0V	6 Str. - 2 Str.	5 Sol. - 3 #7	8A - 4A		2.06		1-9/16		250
QPX2828				1 Str. - 4/0 Str.	7 #9 - 7 #5	3A - 3/0V	1-7/8	2.38	3/8	1-13/16	9/16	250
QPX342C	250 - 500 kcmil	19 #19 - 19 #6	4/0 EK	6 Str. - 2 Str.	5 Sol. - 3 #7	8A - 4A	1-3/8	2.50	5/16	1-7/8	1/2	250
QPX3428				1 Str. - 4/0 Str.	7 #9 - 7 #5	3A - 3/0V	1-3/4	2.75		3/8		2-1/16
QPX3434				250 - 500 kcmil	19 #19 - 19 #6	4/0 EK	2	3.00	2-3/16		250	
QPX442C	500 - 1000 kcmil	19 #6	—	6 Str. - 2 Str.	5 Sol. - 3 #7	8A - 4A	1-3/8	2.63	5/16	2-1/4	1/2	250
QPX4428			—	1 Str. - 4/0 Str.	7 #9 - 7 #5	3A - 3/0V	1-7/8	2.88		3/8		2-7/16
QPX4434			—	250 - 500 kcmil	19 #19 - 19 #6	4/0 EK	2	3.06	2-9/16		250	
QPX4444			—	500 - 1000 kcmil	19 #6	—	2-5/8	3.44		250		

To ensure proper tightening torque use BURNDY® BTW Torque Wrenches

T-Connector, Type VT
V-bolt clamping for Copper

Material: Copper



High copper alloy T-connector for cable run, cable tap. V-bolt clamping elements accommodate a large range of cable and are particularly suited for extra flexible cable. One-wrench installation.

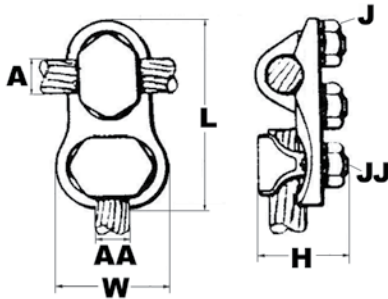

Catalog Number	Conductor		H	L	W	Torque Ratings			
	Run (A)	Tap (AA)				Wrench 1	Wrench 2	Torque 1	Torque 2
VT2C2C	8 AWG - 2 AWG	8 AWG - 2 AWG	1-3/8"	2-3/8"	1"	7/8	7/8	275	275
VT2525	6 AWG - 1/0	6 AWG - 1/0	1-5/8"	2-5/8"	1-1/4"	1	1	385	385
VT2825	1/0 - 4/0 AWG			3-1/8"	1-1/4"	9/16	1	250	385
VT2828				3-3/8"	1-3/4"	9/16	9/16	250	250
VT3025	1/0 - 300 kcmil	6 AWG - 1/0	1-7/8"	3-3/8"	1-1/8"	11/16	1	325	385
VT3030		1/0 - 300 kcmil		3-1/2"	2"	11/16	11/16	325	325
VT3425	300 kcmil - 500 kcmil	6 AWG - 1/0	2-3/8"	3-5/8"	1-1/4"	3/4	1	375	385
VT3428		1/0 - 4/0 AWG		3-1/2"	1-3/4"	9/16	3/4	250	250
VT3430		1/0 - 300 kcmil		3-5/8"	2"	3/4	1	480	385
VT3434		300 kcmil - 500 kcmil		3-3/4"	2-1/4"	3/4	3/4	480	480
VT4040	500 kcmil - 800 kcmil	500 kcmil - 800 kcmil	2-5/8"	4-3/8"	2-5/8"	7/8	7/8	600	600
VT4425	750 kcmil - 1000 kcmil	6 AWG - 1/0	2-7/8"	4-3/4"	1-1/4"	15/16	1	660	385
VT4428		1/0 - 4/0 AWG		4-1/8"	1-3/4"	15/16	9/16	660	240
VT4834	1500 kcmil - 2000 kcmil	300 kcmil - 500 kcmil	4-1/4"	5-1/4"	2-1/4"	1-1/8	3/4	1050	480

To ensure proper tightening torque use BURNDY® BTW Torque Wrenches

TAPIT™ Parallel Clamp, Types UCG-R, UCG-RS

For Copper, AAC†, ACSR†, AAAC

Material: Aluminum

Multi-purpose parallel groove clamp made of high strength, high conductivity, non-copper bearing aluminum alloy. Properly proportioned to minimize stress corrosion and deterioration by galvanic action.

Interlocking fingers on connect body halves prevent mismatching. Square shank, hex head, round collar, high strength galvanized steel bolt allows one or two-wrench installation. Available pre-filled with PENETROX™ joint compound, and stripsealed to limit oxide growth and to increase the life of the connection.

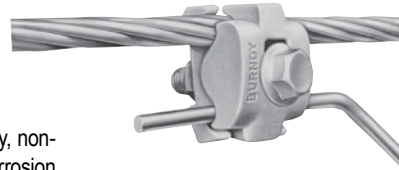

RUS Accepted

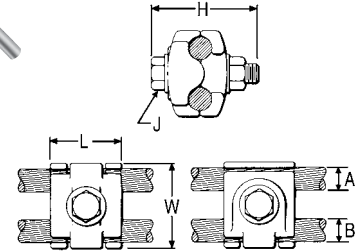

Catalog Number		Groove A		Groove B		Dimensions				Wrench Size	Torque In-lb
With Stripseal	Without Stripseal	Copper & Aluminum†	ACSR†, 6201, & 5005	Copper & Aluminum†	ACSR†, 6201, & 5005	L	H	J	W		
UCG25R2RS**	UCG25R2R**	6 Sol. - 1/0 Str.	8 Str. - 1/0 Str.	6 Sol. - 2 Str.	8 - 2	1-1/8"	1-7/8"	5/16"	1-3/8"	1/2	180
UCG25RS	UCG25R	8 Str. - 1/0 Str.	6 - 1/0	8 Str. - 1/0 Str.*	6 - 1/0	1-3/8"	2-1/8"	3/8"	1-5/8"	9/16	240
UCG28RS	UCG28R	1/0 Str. - 4/0 Str.	1/0 - 4/0	1/0 Str. - 4/0 Str.	6 - 4/0	1-3/8"	2-1/5"	3/8"	1"	3/4	480
UCG32RS	UCG32R	1/0 Str. - 397.5	1/0 - 336.4	8 Str. - 2/0 Str.	6 - 1/0	1-1/2"	2-5/8"	3/8"	2-1/8"	9/16	240

* Maximum recommended combinations: 1/0 Aluminum or ACSR Run - #2 Str. Copper Tap; 1/0 Copper Run - 1/0 Aluminum or ACSR Tap.

† Accommodates compact and compressed conductors within diameter range.

** Supplied with galvanized steel, square shank bolt.

Not recommended for copper to copper applications. Use a copper connector to increase connection life.

For proper installations use BURNDY® BTW Torque Wrenches.

TAPIT™ Parallel Clamp, Types UC-R, UC-RS

For Copper, AAC†, ACSR†, AAAC

Material: Aluminum

High strength, high conductivity, non-copper bearing aluminum alloy, properly proportioned to minimize stress corrosion and deterioration by galvanic action. Keying tabs on connector body halves prevent mismatching. Square shank, high strength galvanized steel bolt allows one wrench installation. Available pre-filled with PENETROX™ joint compound and stripsealed.



RUS Accepted

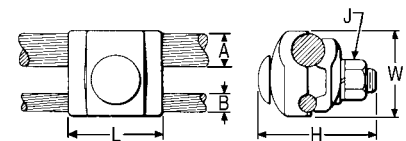

Catalog Number		Groove A		Groove B		Dimensions				Wrench	Torque
With Stripseal	Without Stripseal	Copper & Aluminum†	ACSR†, 6201, & 5005	Copper & Aluminum†	ACSR†, 6201, & 5005	L	H	J	W		
UC25R2RS	UC25R2R	8 Sol. - 1/0 Str.	6 - 1/0	8 Sol. - 2 Str.	6 - 2	1-1/8"	1-5/8"	5/16"	1-3/8"	1/2	180
UC28RS	UC28R	1/0 Str. - 4/0 Str.	1/0 - 4/0	8 Sol. - 1/0 Str.	6 - 1/0	1-3/8"	2-3/8"	3/8"	1-7/8"	9/16	240
UC32RS	UC32R	1/0 Str. - 397.5	336.4	6 Sol. - 2/0 Str.	6 - 1/0	1-1/2"	2-3/8"	3/8"	2-1/4"	9/16	240
—	UC33R	4/0 Str. - 400	336.4	6 Sol. - 2/0 Str.	6 - 2/0	1-3/4"	2-3/4"	1/2"	2-1/4"	3/4	480

* Maximum recommended combinations: 4/0 Aluminum or ACSR Run - #2 Str. Copper Tap.

† Accommodates compact and compressed conductors within diameter range.

Not recommended for copper to copper applications. Use a copper connector to increase connection life.

For proper installations use BURNDY® BTW Torque Wrenches.

FASTAP™ with Lineman Assist™, Type UCT
 For Copper, AAC, ACSR, AAAC, ACAR, Messenger Guy

Material: Aluminum (Galvanized Steel Hardware)

The BURNDY® FASTAP™ with Lineman Assist™ mechanical connector utilizes a spring system that acts as a third hand to assist in installation. This system helps secure the tap conductor while installing on Primary, Secondary, and service applications. The duck bill handle simplifies installation by providing a handle to easily hold the connector while wearing dielectric gloves. Conductor side entry facilitates installation and also helps keep inhibitor in the connector. Supplied strip sealed and pre-filled with PENETROX™ joint compound to limit oxide growth and increase the life of the connection.

Variations:

- Remove "S" for no PENETROX™
- Add "SS" for stainless steel hardware
- Add "C" to include a cover
- Add "HN" for shear nut
- Cover may be ordered separately (UCTCOVER)
- * Not available with cover or shear nut

— Not recommended for Copper to Copper applications; use Copper FASTAP™ connector (see next page)

To ensure proper tightening torque, use BURNDY® BTW Torque Wrenches.

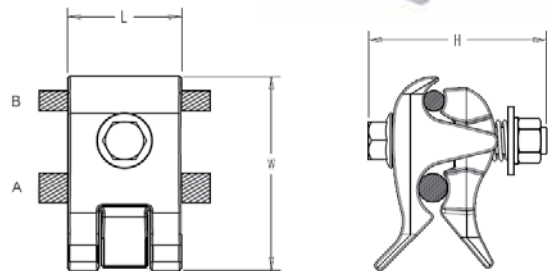

Catalog Number	Conductor Range				Conductor Diameter				Torque (in-lb)	Wrench Size	# of Bolts	Dimensions		
	Groove A (Run)		Groove B (Tap)		Groove A (Run)		Groove B (Tap)					L	H	W
	Copper & Aluminium	ACSR, 6201 & 5005	Copper & Aluminium	ACSR, 6201 & 5005	Min	Max	Min	Max						
UCT26RS	8 Sol - 2/0 Str	6 Str - 2/0 Str	8 Sol - 2/0 Str	6 Str - 2/0 Str	0.13	0.45	0.13	0.45	250	9/16	1	1.62	2.62	2.50
UCT32RS	1 Sol - 400	2 Str - 336.4	8 Sol - 4/0 Str	6 Str - 4/0 Str	0.29	0.73	0.13	0.56	250	9/16	1	1.62	2.62	2.82
UCT41R28RS*	250 Str - 650 Str	4/0 (6/1) - 556.5 (30/7)	6 Sol - 4/0 Str	6 Str - 4/0 Str	0.56	0.95	0.16	0.56	480	3/4	1	2.66	4.37	4.57
UCT41R41RS*	250 Str - 650 Str	4/0 (6/1) - 556.5 (30/7)	250 Str - 650 Str	4/0 (6/1) - 556.5 (30/7)	0.56	0.95	0.46	0.95	480	3/4	2	4.20	4.37	5.23

Copper FASTAP™ with Lineman Assist™, Type UCT For Copper

Material: Copper
(Silicon Bronze / Stainless Hardware)

The BURNDY® FASTAP™ with Lineman Assist™ mechanical connector utilizes a spring system that acts as a third hand to assist in installation. This system helps secure the tap conductor while installing on Primary, Secondary, and service applications. The duck bill handle simplifies installation by providing a handle to easily hold the connector while wearing dielectric gloves. Conductor side entry facilitates installation and also helps keep inhibitor in the connector.

Variations:

- Add "SS" for stainless steel hardware
- Add "C" to include a cover
- Add "HN" for shear nut
- Cover may be ordered separately (UCTCOVER)

To ensure proper tightening torque, use BURNDY® BTW Torque Wrenches.

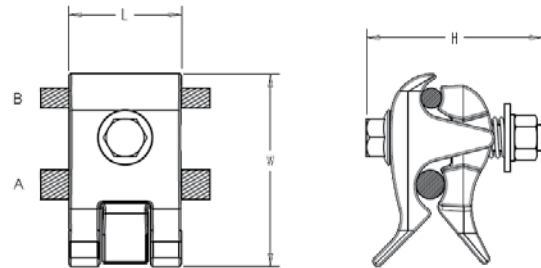

Catalog Number	Conductor Range		Conductor Diameter				Torque (in-lb)	Wrench Size	Dimensions		
	Groove A (Run)	Groove B (Tap)	Groove A (Run)		Groove B (Tap)				L	H	W
	Copper	Copper	Min	Max	Min	Max					
UCT26	8 Sol - 2/0 Str	8 Sol - 2/0 Str	0.13	0.45	0.13	0.45	240	9/16	1.62	2.62	2.50
UCT32	1 Sol - 400	8 Sol - 4/0 Str	0.29	0.73	0.13	0.56	240	9/16	1.62	2.62	2.82

Connector/Cover Kit, Type UC-KIT

Includes Type UC connector and Cover

Type UC connector accommodates a large range of copper conductors in either groove. Kits include the connector and cover.

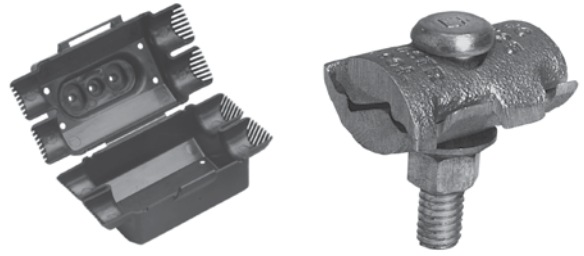

Catalog Number	Conductor (Either Groove)	Dimensions				Wrench	Torque
		L	H	J	W		
UC6W25CONKIT	6 Sol. - 1/0 Str.	1-3/4"	1-5/8"	[3/8]"	1-3/8"	9/16	240
UC4W28CONKIT	4 Sol. - 4/0 Str.	2-1/8"	2"		1-3/4"		

Note: For connectors with break-away bolt contact factory.

TAPIT™ Connector Cover, Type UC-COVER

For Select Types UC, UCG Tap Connector

High density polyethylene cover accommodates several sizes of Types UC and UCG connectors. One piece design; simply slip over the connector and snap shut. Supplied in black.



Catalog Number: UCCOVER1BOX25 For use with following connectors:

UCG25R2RS	UCG25R2R
UCG25RS	UCG25R
UCG28RS	UCG28R
UC25R2RS	UC25R2R
UC28RS	UC28R
UC6W25	UC4W25

FASTAP™ Connector Cover, Type UCTCOVER

For Select Types UCT, UCG Tap Connectors

High density polyethylene cover accommodates all FASTAP™ connectors and select Type UCG connectors. One piece design; simply slip over the connection and snap shut. Supplied in black.

Catalog Number: UCTCOVER For use with following connectors:

UCT26
UCT32
UCT26RS
UCT32RS
UCG32RS
UCG26RS



Lightning Shield Clamp, Type LSC

For AAC and ACSR Primary Covered Conductor (Tree Wire)

Material: Aluminum (Cast)

Cast aluminum lightning shield clamp with a galvanized steel eye bolt for use on covered aluminum and ACSR primary overhead distribution conductors (Tree Wire). These clamps are designed to protect the Tree Wire from burn-down causing service interruption during high lightning activity. For further application details, contact the factory.

Conductor groove is pre-filled with PENETROX™ A-13 oxide inhibitor, which is compatible with cable insulation and individually bagged.

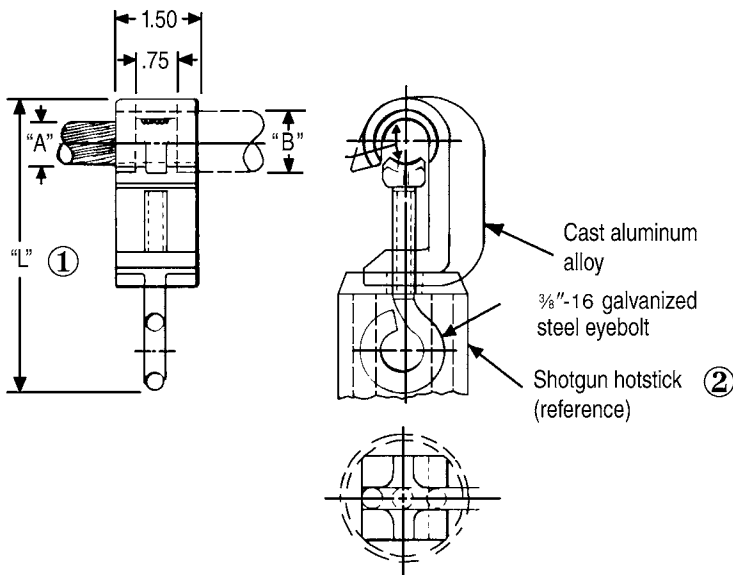
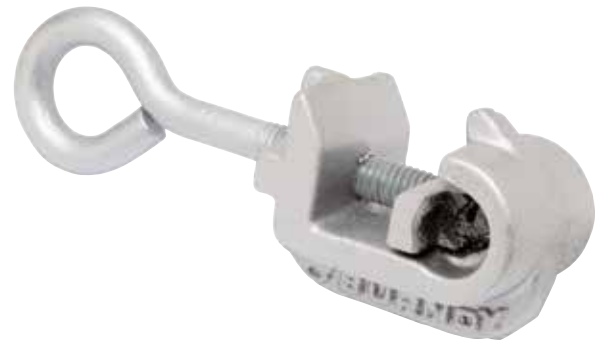

① Approx. assembly length over eyebolt with cable clamped. Also approx. eyebolt position when shipped.

② Assembly can be installed using a shotgun hotstick as shown. Assembly instructions are supplied with each connector.

Catalog Number	Cable	Accommodates Cable Dia. "A"	Insul. Dia. "B" (Max.)	"L"
LSC1/0	1/0 Str. ACC - 1/0 ACSR	0.368 - 0.398	0.65"	4.50"
LSC1/01	1/0 Str. AAC - 1/0 ACSR	0.368 - 0.398	0.83"	4.50"
LSC556	4/0 Str. - 556.5 AAC	0.528 - 0.858	1.16"	5.90"
LSC5561	4/0 Str. - 556.5 AAC	0.528 - 0.858	1.34"	5.90"

Compression Tap Connectors General Overview

The BURNDY line of compression connectors are wide range-taking; accommodate copper, aluminum and ACSR; are easy to install; and are dependable and economical. They are designed to be installed with BURNDY® “matched” hand, hydraulic, and power-driven hydraulic tooling. The connector line consists of C-shaped, Figure 3, Figure 6-shaped, and HYCRIMP™ tap connectors, disconnectable T-taps, terminals and STIRRUP™ connectors.

The copper CRIMPIT™ is a range-taking, reversible, C-shaped compression tap connector for combinations of copper conductors. Twelve connectors take tap combinations from #10 AWG through 4/0, and all sizes are installed with dies that also install aluminum connectors. Sizes accommodating conductors up to #2 may be installed with the MD6 and OUR840 type tools. All sizes may be installed with the 35 or 750 family of tools. They make “hot” installation easy by permitting the lineman to grip the CRIMPIT™ in the compression tool and then place it on the line. The tap is then inserted and the CRIMPIT™ is compressed. Massive C-shape forces tap and line conductors together to form dependable, low-cost, low-resistance connections.

The CABELOK™ CRIMPIT™ is a range-taking universal and reversible, Figure 3-shaped aluminum compression tap connector with an adjustable spacer which separate the conductors. It accommodates combinations of copper, aluminum, and ACSR conductors from #6 up to 4/0, and is installed with the common O and D3 dies. The broad range capacity of each CABELOK™ CRIMPIT 2 reduces the number of connectors required and simplifies connector selection.

The spacer holds the run or tap in place permitting the lineman either to approach the line with the connector held in the tool and with the tap in the connector, or to assemble the connector and tap on the line and then bring up the tool to crimp.

Each CABELOK™ CRIMPIT™ is pre-filled with PENETROX™ joint compound and individually bagged. These packages are clearly marked with the entire conductor range of the connector as well as pertinent tooling information. The open side of the CABELOK™ CRIMPIT™ makes “hot” installations easy by allowing the connector to be carried to the energized line in the crimping tool (MD6, 35, or 750 families hot-line styles).

The Figure 6-shaped aluminum compression tap connector is one of the widest range-taking compression tap connectors available. It accommodates copper, aluminum, or ACSR conductors in very broad ranges. Only four connectors are required to accommodate a range from #6 to 600 kcmil. This broad range is made possible by the long ram stroke of the 35 and 750 series tools.

HYCRIMP™ compression tap connectors accommodate ACSR, stranded copper or aluminum, solid copper or aluminum, and compact conductors. Seventeen sizes are available to accommodate all conductors from #6 solid to 954 kcmil compact. All HYCRIMP™ connectors can be installed with industry standard O, D, N and R dies. Each connector is factory-filled with BURNDY® PENETROX™ joint compound, and individually boxed for ease of handling, identification, and installation.

The BURNDY® line of disconnectable T-taps and jumper loop slices offer an economical approach to sectionalizing or isolating equipment on energized lines. They combine the best features of compression and mechanical connectors. The pads can be easily assembled or separated from each other with hot-line tools.

The STIRRUP™ combines a compression C-shaped Figure 6-shaped or H-shaped element for the run conductor, and a factory installed bail which accommodates a hot-line clamp. The line element can be gripped in the tool and carried to the line and then crimped.

Note: Aluminum bodied compression tap connectors are not recommended for making copper to copper connections. Two connectors are recommended when feeding a line in both directions.

Overhead Distribution

Compression Tap Large Range Taking
COPPER CRIMPIT™ Types YC-C, YP-C

Copper CRIMPIT™ Connector, Type YC-C For Copper, Copperweld

Material: Copper
UL Listed 90° C, Up to 35 kV ♦

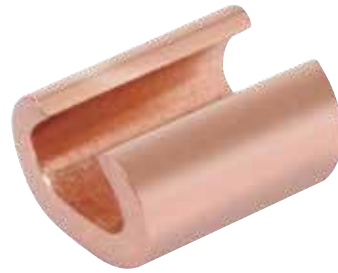

Range-taking compression tap connector made of pure copper. Designed to be gripped in the jaws or dies of installation tool, then slipped directly over line for easy installation. Also used for deadending applications.

Copperweld-Copper Conductors

8A - Use CRIMPIT™ accommodating 6 Str. Copper

6A - Use CRIMPIT™ accommodating 4 Str. Copper

4A - Use CRIMPIT™ accommodating 2 Str. Copper

2A - Use CRIMPIT™ accommodating 1/0 & 2/0 Copper

** Multiple crimp die set. Makes more than one crimp per tool compression. Figure () indicates number of compressions.

† Not UL Listed.

‡ Number of crimps.

* U Die with adapter PUADP1.

§ Not UL Listed or CSA Certified with this conductor size in run.

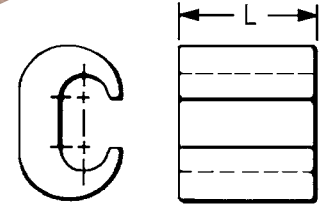

RUS Accepted

Catalog Number	Run	Tap	L	▲ Die Index	Tools, Die Set, Catalog Number and (‡No. of Crimps) ▲			CRIMPIT™ for 1 Str. Copper	
					MD6	OUR840	35, 750 Series, Y45, 46 Series*	Run	Tap
YC10C10 †	12 Sol.-10 Str.	12 Sol.-10 Str.	.32	238	W238 (1)	W238 (1)	U238 (1)	—	—
YC8C8	8 Sol.-8 Str.	10 Sol.- 8 Str.	.50	162	W162 (2)	W162 (2)	U162** (1)	—	—
YC4C8	6 Sol.-4 Str.	8 Sol.- 8 Str.	.62	BG or 5/8	BG (2) WBG** (1)	XBG (2) XNBG (2)	UBG (1)	—	—
YC4C6		6 Sol.- 6 Str.	.57						
YC4C4		6 Sol.- 4 Str.							
YC2C4	4 Sol.-2 Str.	8 Sol.- 4 Str.	.67	C	WC (2)	—	UC (1)	1 Str. §	6, 8 Str., 8 Sol.
YC2C2	2 Sol.-2 Str.	2 Sol.- 2 Str.	.92	E or O	—	—	UE (3) UO (1)	—	—
YC26C2	1/0 Str.-2/0 Str.	8 Sol.- 2 Str.						1 Str. §	1 or 2 Str.
YC26C26		1/0 Str.- 2/0 Str.						—	—
YC28C2	3/0 Str.-4/0 Str.	6 Sol.- 2 Str.	1.07	F or D3	—	—	UF (3) UD3** (1)	—	—
YC28C26		1/0 Str.- 2/0 Str.							
YC28C28		3/0.- 4/0 Str.							

Copper CRIMPIT™ Tap Connector, Type YP-C For Copper

Material: Copper

Figure "6" shaped, wide range-taking copper compression tap connector for primary service taps and secondary service drops. Connector can be gripped in tool and slipped over the line for easy installation.

Catalog Number	D	Run	Tap	Die Index	Tools, Die Set Catalog Number, & (# of Crimps) 35, 750 Series, Y45 †, 46 Series ‡
YP2C2	0.75	6 Sol. - 2 Str.	6 Sol. - 2 Str.	O	UO (1)
YP28C28	1.00	2/0 Sol. - 4/0 Str.	2/0 Sol. - 4/0 Str.	D	UD3 (1)
YP29C26	0.75	1/0 Sol. - 250	4 Sol. - 2/0 Str.		

† U Die with adapter PT6515.

‡ U Die with adapter PUADP1.

For faster installations use BURNDY® PATRIOT® family of battery tools.

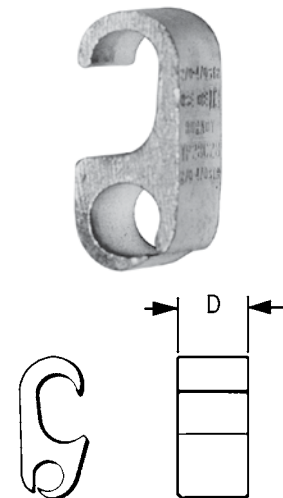

Aluminum CRIMPIT™ Connector, Type YC-A

For AAC (Stranded, Compressed, Compact), ACSR, AAAC

Material: Aluminum

Range-taking C-shaped aluminum compression tap or deadending connector designed to eliminate effects of cold flow. Can be gripped in tool and slipped over line for easy crimping. Pre-filled with PENETROX™ joint compound and stripealed to limit oxide growth and increase the life of the connection.

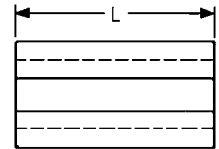

Catalog Number	Run		Tap		L	Die Index	Tools, Die Set Catalog Number, & (# of Crimps)	
	Aluminum	ACSR, 6201, 5005	Aluminum	ACSR, 6201, 5005			MD7, MD6	35, 750 Series, Y45 †, 46 Series ‡
YC4A6	6 Sol. - 4 Str.	6	6 Sol. & Str.	—	1-1/4"	5/8 or BG	BG (4) WBG (2)*	UBG (2)*
YC4A4			4 Sol. & Str.	6				
YC2A4	2 Sol. & Str.	4 - 2	4 Sol. & Str.	6	1-1/2"	C	WC (4)	UC (2)*
YC2A2			2 Sol. & Str.	4 - 2				
YC25A4	1/0 Str.	1/0	6 Str. - 4 Str.	6 - 4	1-1/2"	C	WC (4)	UC (2)*
YC25A2			2 Sol. & Str.	2	2-1/4"	C	WC (6)	UC (3)*
YC25A25			1/0 Str. - 2/0 Str.	1/0 Str. - 2/0 Str.	1/0	1-3/4"	Q	WQ (6)*
YC26A25	1/0 Str. - 2/0 Str.	1/0 - 2/0	1/0 Str.	1/0	2-1/2"	D**	—	UD (3)
YC26A26			2/0 Str.	2/0				
YC28A2	3/0 Str. - 4/0 Str.	3/0 - 4/0	6 Sol. - 2 Str.	6 - 2	2-3/4"	H	—	UH (3)
YC28A25			1/0 Str.	1/0				
YC28A26			2/0 Str.	2/0				
YC28A28			3/0 Str. - 4/0 Str.	3/0 - 4/0				
YC33R26	300 - 397.5	336.4 (18-1) (26-7)	2 Str. - 2/0 Str.	2 - 1/0	1-1/2"	R	—	UR (2)

* Multiple crimp die set; makes more than one crimp per tool compression.

Figure indicates number of compressions.

** Index number "D" is not "D3" Cabelok CRIMPIT™ die.

† U Die with adapter PT6515.

‡ U Die with adapter PUADP1.

For faster installations use BURNDY® PATRIOT® family of battery tools.

CABELOK™ CRIMPIT™ Connector, Type YP-U

For Copper, AAC (Stranded, Compressed, Compact),
ACSR, AAAC



Material: Aluminum

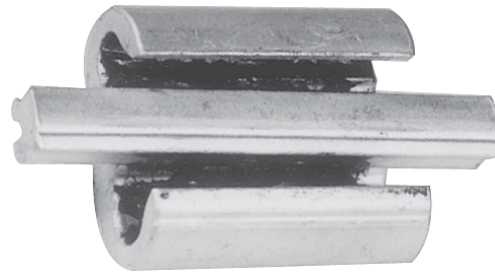

Wide range-taking, universal, and reversible, Figure 3-shaped aluminum connector with adjustable overhanging spacer that separates conductors. Spacer holds run or tap in place permitting lineman to either approach the line ready to crimp, or to assemble connector and tap on run and then crimp. Massive aluminum design minimizes conductor corrosion due to galvanic action. Pre-filled with PENETROX™ joint compound and stripealed to limit oxide growth and increase the life of the connection. Conductor range and tooling information clearly printed on both connector and packaging.

RUS Accepted

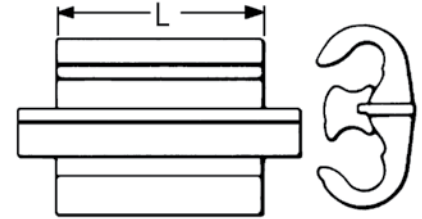

Catalog Number	Conductor (See Chart Below for Compressed Conductor)						L	Die Index	Tools, Die Set Catalog Number, & (# of Crimps)	
	Groove A			Groove B					MD7, MD6	35, 750 Series, Y45 †, 46 Series ‡
	Solid	Stranded	ACSR	Solid	Stranded	ACSR				
YP2U3*	6, 4, 3, 2	6, 4, 3	6, 4	6, 4, 3, 2	6, 4, 3	6, 4	1-1/2"	O	WO (4)	UO (1)
YP26AU2	1, 1/0, 2/0, 3/0	2, 1, 1/0, 2/0	3, 2, 1, 1/0	6, 4, 3, 2, 1, 1/0	6, 4, 3, 2, 1	6, 4, 3, 2				
YP25U25**	2/0, 3/0	1, 1/0, 2/0	1, 1/0	2/0, 3/0	1, 1/0, 2/0	1, 1/0	1-5/8"	D3	MD6 (4)	UD3 (1)
YP27AU4	2/0, 3/0, 4/0	1, 0, 2/0, 3/0	1/0, 2/0	6, 4, 3, 2	6, 4, 3	6, 4				
YP27AU2				2, 1, 1/0	3, 2, 1	4, 3, 2				
YP27AU26	3/0, 4/0	2/0, 3/0	2/0	2/0, 3/0	1/0, 2/0	1, 1/0, 2/0				
YP28U2	—	4/0	3/0, 4/0	2, 1, 1/0	4, 3, 2, 1	4, 3, 2				
YP28U26				2/0, 3/0	1/0, 2/0	1, 1/0, 2/0	3-1/2"	MD6 (9)	UD3 (2)	

Catalog Number	Compressed Conductor				L	Die Index	Tool, Die Set Catalog No., & (# of Crimps)	
	Groove A		Groove B				MD7, MD6	35, 750 Series, Y45 †, 46 Series ‡
	Stranded Aluminum	ACSR	Stranded Aluminum	ACSR				
YP2U3	6, 4, 3, 2	6, 4, 3	6, 4, 3, 2	6, 4, 3	1-1/2"	O	WO (4)	UO(1)
YP26AU2	2, 1, 1/0, 2/0	2, 1, 1/0, 2, 0	6, 4, 3, 2, 1	6, 4, 3, 2, 1				
YP25U25	1/0, 2/0	1/0, 2/0	1/0, 2/0	1/0, 2/0	1-5/8"	D3	MD6 (4)	UD3 (1)
YP27AU4	2/0, 3/0	1/0, 2/0, 3/0	6, 4, 3	6, 4, 3				
YP27AU2			3, 2, 1	4, 3, 2, 1				
YP27AU26	3/0	2/0, 3/0	1/0, 2/0, 3/0	1/0, 2/0				
YP28U2	4/0, 250, 266.8	4/0, 266.8, (18/1)	3, 2, 1	4, 3, 2, 1				
YP28U26			1/0, 2/0, 3/0	1/0, 2/0	3-1/2"	MD6 (4)	UD3 (1)	
YP28U28			3/0, 4/0	3/0, 4/0	3/0, 4/0	2-3/4"	—	UD3 (2)

* TAKES UP to #2 ACSR maximum in either groove if other wire is #2 solid or smaller.
 ** TAKES DOWN to #2 ACSR minimum in either groove if other groove wire is 1/0 stranded or larger.
 † U Die with adapter PT6515.
 ‡ U Die with adapter PUADP1.

Not recommended for copper to copper applications. Use a copper connector to increase connection life.

For faster installations use BURNDY® PATRIOT® family of battery tools.

Universal CRIMPIT™ Connector, Type YPC-U

For Copper, AAC (Stranded, Compressed, Compact),
ACSR, AAAC

Material: Aluminum

Extra wide range universal connector. Two dies and 5 connectors take run sizes from 1/0 to 600 kcmil and tap sizes #6 to 400 kcmil. Wide range acceptance made possible by long ram travel of BURNDY® HYPRESS™ tools. Figure 6-shape separates run and tap wires, minimizing galvanic corrosion of conductors. Connector can be gripped in tool and slipped over line for easy installation. Pre-filled with PENETROX™ joint compound and stripsealed to limit oxide growth and increase the life of the connection.

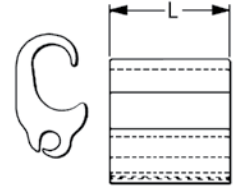
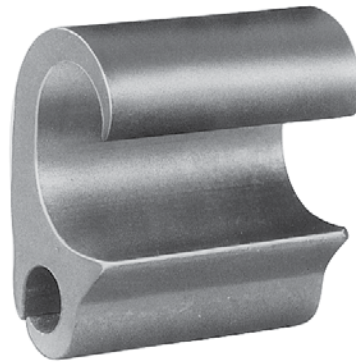

- ① 2/0 Str. Cu Aluminum and 2/0 ACSR may also be installed in run when tap is 3/0 Str. or larger.
- ② YPC28U4 only may be installed with MD6 HYTOOL™ and the BCT500HS with D3 groove.

- † U Die with adapter PT-6515.
- ‡ U Die with adapter PUADP-1.
- Not recommended for copper to copper applications.
- Use a copper connector to increase connection life.
- For faster installations use BURNDY® PATRIOT® family of battery tools.

Catalog Number	Run		Tap		L	Die Index	Tools, Die Set Catalog Number, & (# of Crimps)		
	Aluminum & Copper	ACSR, 5005	Aluminum & Copper	ACSR, 5005			35, 750 Series	Y45 †	46 Series ‡
YPC28U4	3/0 - 4/0 Str. & 4/0 - 250, 266.8 Alum. Compressed	3/0 - 4/0 & 4/0, 266.8 (18/1) ACSR Compressed	6, 4, 3 Str. 6, 4, 3, 2 Sol. & 6, 4, 3 Alum. Compressed	6, 4, 3 ACSR Compressed	1-5/8	D3 ②	UD3 (1)	UD3 (1)	UD3 (1)
YPC28U26	1/0 (7) - 4/0 (7)	1/0 - 4/0	3 Sol. - 2/0 (7)	4 - 1/0	2-3/4	D3	UD3 (2)	—	—
YPC28U28 ①	3/0 - 4/0 Str. 4/0 Sol. & 4/0, 250, 266.8 Alum. Compressed	3/0 - 4/0 Str. & 3/0, 4/0, 266.8 (18/1) ACSR Compressed	2/0 - 4/0 Str. 4/0 Sol. & 3/0, 4/0, 250, 266.8 Alum. Compressed	2/0 - 4/0 Str. & 3/0, 4/0, 266.8 (18/1) ACSR Compressed	2-3/4	D3	UD3 (2)	UD3 (2)	UD3 (2)
YPC28R28A	3/0 - 4/0 Str. & 4/0 - 250, 266.8 Alum. Compressed	3/0 - 4/0 & 4/0, 266.8 (18/1) ACSR Compressed	3/0 - 4/0 Str. & 4/0 Alum. Compressed	3/0 & 4/0 ACSR Compressed	2-3/4	D3	UD3 (2)	UD3 (2)	UD3 (2)
YPC33R26U	250 (37) - 400 (37)	266.8 (18-1) - 397.5 (18-1)	6 Sol. - 2/0 (19)	6 - 1/0	2-1/8	N	UN (2)	SN (2)	PN (2)
YPC33R28R	250 (37) - 477 (37)	266.8 (18-1) - 397.5 (18-1)	2/0 (19) - 4/0 (19)	2/0 - 4/0	8-7/8	N	UN (3)	SN (3)	PN (3)
YPC33R33R	250 (37) - 400 (37)	266.8 (18-1) - 397.5 (18-1)	250 (37) - 400 (37)	266.8 (18-1) - 397.5 (18-1)	8-7/8	N	UN (3)	SN (3)	PN (3)
YPC38R26U	477 (19) - 600 (61)	397.5 (26-7) - 556.5 (18-1)	6 Sol. - 2/0 (19)	6 - 1/0	2-1/8	N	UN (2)	SN (2)	PN (2)
YPC36A32	397.5 (19) - 600 (61)	336.5 (26-7) - 556.5 (18-1)	2/0 (7) - 400 (37)	2/0 (6-1) - 397.5 (18-1)	5	Z	—	SZ (3)	—
YPC36A36	397.5 (19) - 600 (61)	336.5 (26-7) - 556.5 (18-1)	397.5 (19) - 600 (61)	397.5 (26-7) - 556.5 (18-1)	6-3/4	Z	—	SZ (4)	—
YPC40A32	600 (61) - 800 (61)	556.6 (18-1) - 795 (26-7)	2/0 (7) - 400 (37)	2/0 (6-1) - 397.5 (18-1)	5	T	—	ST (3)	—
YPC40A36	600 (61) - 800 (61)	556.6 (18-1) - 795 (26-7)	397.5 (19) - 600 (61)	336.4 (26-7) - 556.5 (18-1)	5	T	—	ST (3)	—
YPC40A40	600 (61) - 954 (61)	556.6 (18-1) - 795 (26-7)	600 (61) - 954 (61)	556.5 (18-1) - 795 (26-7)	9-7/8	T	—	ST (6)	—

Universal CRIMPIT™ Connector, Type YC-U

For Copper, AAC (Stranded, Compressed, Compact), ACSR, AAAC

Material: Aluminum

Figure 6-shaped, wide range-taking aluminum compression tap connector for smaller primary service taps and secondary service drops. Minimizes galvanic corrosion of conductors. Connector can be gripped in tool and slipped over line for easy installation. Installed with aluminum CRIMPIT™ connector dies. Pre-filled with PENETROX™ joint compound and stripsealed to limit oxide growth and increase the life of the connection.

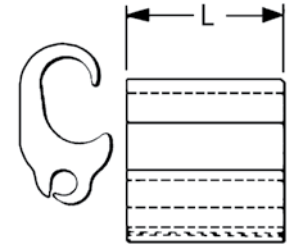

Catalog Number	Run		Tap		L	Die Index	Die Set Catalog No., & (# of Crimps) 35, 750 Series, Y45 †, 46 Series ‡
	Aluminum & Copper	ACSR, 6201, 5005	Aluminum & Copper	ACSR, 6201, 5005			
YC4U1	4 Sol. - 4 Str.	4	6 Sol. - 1 Str.	6 - 1 Str.	1-7/8	D*	UD (2)
YC1U1	2 Str. - 1 Str.	2					
YC28U26	1/0 Str. - 4/0 Str.	1/0 - 4/0	6 Sol. - 1/0 Str.	6 - 1/0	2-1/8	H	UH (2)
YC33R26U	300 - 400	266.8 (6-7) - 336.4 (30-7)				R	UR (2)

* Die Index "D" is not Die Index "D3" (CABLELOK™ & Universal CRIMPIT™ Die).

† U Die with adapter PT6515.

‡ U Die with adapter PUADP1.

Not recommended for copper to copper applications. Use a copper connector to increase connection life.

For faster installations use BURNDY® PATRIOT® family of battery tools.

Street Lighting Tap, Types YPC-A-U, YPC-R-U

For Copper, AAC (Stranded, Compressed, Compact), ACSR, AAAC

Material: Aluminum

Compact compression connector designed to tap small lighting wires from secondaries. Figure 6-shape separates run and tap, minimizing galvanic corrosion. Connector can be gripped in tool and slipped over line for easier installation. Pre-filled with PENETROX™ joint compound and stripsealed to limit oxide growth and to increase the life of the connection.

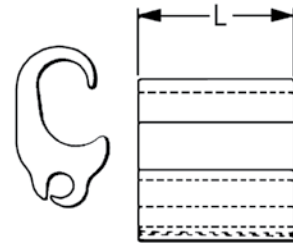
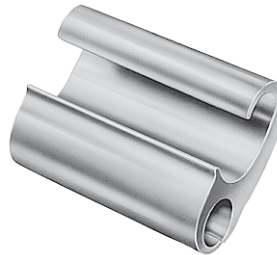

Catalog Number	Run				Tap	L	Die Index	Tools, Die Set Catalog Number, & (# of Crimps)		
	ACSR	Compressed ACSR	Aluminum & Copper	Compressed Aluminum	Aluminum & Copper			MD7, MD6	35 and 750 Series, Y45 †, Y46 ‡	OUR840
YPC2A8U	6 - 4	6 - 2	4 - 2 Sol. 6 - 2 Str.	4 - 2	14 Sol. - 8 Str.	5/8	BG or 5/8	BG (1) WBG (1)*	UBG (1)	XBG
YPC26R8U	2 - 3/0	1 - 3/0	1 - 3/0	1/0 - 3/0	14 Sol. - 8 Str.	3/4	O	WO (2)	UO (1)	WO

* Multiple crimp die set, makes more than one crimp per tool compression.

Figure indicates number of compressions.

Not recommended for copper to copper applications. Use a copper connector to increase connection life.

For faster installations use BURNDY® PATRIOT® family of battery tools.

CRIMPIT™ Connector Cover, Type CC

For all O, D, and N Die Tap Connectors

Material: Polyethylene

High density polyethylene cover accommodates most industry connectors in the O, D, and N range. Four sizes cover the full #6 to 600 kcmil conductor range. One piece design, no extra hardware needed. Simply slip over connector and snap shut. Supplied in black.



Catalog Number	Maximum Connector Length	Connector Series Accommodated
CCO	2-1/2	O Die
CCD	2-3/4	D Die
CCN	2-1/8	Short N Die
CCNL	5-3/16	Long N Die and YP28U26

HYCRIMP™ H-Shaped Connector, Types YHO, YHD
For Aluminum (Stranded, Compressed, Compact), Copper, ACSR, AAAC, Steel

Material: Aluminum

Wide range, universal, reversible, Figure H aluminum connector. Conductors are separated by the shape of the connector. Bendable tabs secure both run and tap conductors freeing lineman's hands to work with installation tool. Massive aluminum design minimizes corrosion due to galvanic corrosion. Pre-filled with PENETROX™ joint compound and stripsealed to limit oxide growth and increase life of the connection. Individually packaged; conductor ranges and tooling information clearly printed on connector and packaging.

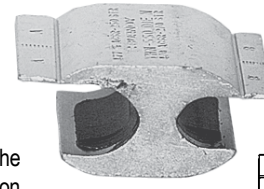

RUS Accepted

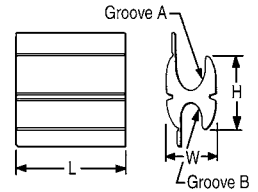

Handtool or Hydraulic 7 Connector Program														
Catalog Number	Code No.	Conductors (See Below for Compact Conductors)								Dimensions			Installation Data	
		Groove A (Run)				Groove B (Tap)							Tool Series, Die Set Cat. No. & (# Crimps)	
		Wire Diameter Range	Sol.	Str.	ACSR	Wire Diameter Range	Sol.	Str.	ACSR	H	L	W	MD78 MD68	35, 750, Y45†, 46‡
YHO100	1	0.162-0.332	#6 - #1	#6 - #1	#6 (6/1) - #2 (7/1)	0.162-0.332	#6 - #1	#6 - #1	6 (6/1) - 2 (7/1)	1.12	1.25	0.70	⊙ (4)	UO (2)
YHO150	2	0.260-0.419	#1 - 2/0	#3 - 2/0	#3 (6/1) - 1/0 (6/1)	0.162-0.332	#6 - 1/0	#6 - #1	6 (6/1) - 2 (7/1)	1.13	1.50	0.70	⊙ (5)	UO (2)
YHD200	5	0.398-0.470	3/0 - 4/0	2/0 - 3/0	1/0 (6/1) - 2/0 (6/1)	0.162-0.332	#6 - 1/0	#6 - #1	6 (6/1) - 2 (7/1)	1.45	1.62	0.89	⊙ (5)	UD3 (2)
YHD250	4	0.475-0.563	250 - 300	4/0	3/0 (6/1) - 4/0 (6/1)	0.162-0.332	#6 - 1/0	#6 - #1	6 (6/1) - 2 (7/1)	1.47	1.62	0.89	⊙ (5)	UD3 (2)
YHD300	4	0.336-0.470	2/0 - 4/0	#1 (3) - 3/0	#1 (6/1) - 2/0 (6/1)	0.336-0.447	2/0 - 3/0	#1 - 2/0	1 (6/1) - 2/0 (6/1)	1.42	1.62	0.89	⊙ (5)	UD3 (2)
YHD350	6	0.461-0.563	250 - 300	3/0 - 4/0	3/0 (6/1) - 4/0 (6/1)	0.336-0.447	2/0 - 3/0	#1 - 2/0	1 (6/1) - 2/0 (6/1)	1.42	2.25	0.89	⊙ (7)	UD3 (3)
YHD400	7	0.461-0.563	250 - 300	3/0 - 4/0	3/0 (6/1) - 4/0 (6/1)	0.461-0.563	250 - 300	3/0 - 4/0	3/0 (6/1) - 4/0 (6/1)	1.40	2.50	0.84	⊙ (7)	UD3 (3)

Compact Conductors								Installation Data		
Catalog Number	Code No.	Groove A (Run)			Groove B (Tap)			Tool Series, Die Set Catalog No. & (# of Crimps)		Die Index
		Wire Diameter Range	Compact ACSR	Compact CU or AL	Wire Diameter Range	Compact ACSR	Compact CU or AL	MD78 MD68	35, 750, Y45†, 46‡	
YHO100	1	0.162 - 0.332	#6 - #1	#6 - #4 - #1	0.162 - 0.332	#6 - #1	#6 - #1	⊙ (4)	UO (2)	O
YHO150	2	0.260 - 0.419	#2 - 1/0	#2 - 2/0	0.162 - 0.332	#6 - #1	#6 - #1	⊙ (5)	UO (2)	O
YHD200	3	0.398 - 0.470	2/0 - 3/0	3/0	0.162 - 0.332	#6 - #1	#6 - #1	⊙ (5)	UD3 (2)	D3
YHD250	5	0.475 - 0.563	4/0 - 266.8	4/0 - 266	0.162 - 0.332	#6 - #1	#6 - #1	⊙ (5)	UD3 (2)	D3
YHD300	4	0.336 - 0.470	1/0 - 3/0	1/0 - 3/0	0.336 - 0.447	1/0 - 2/0	1/0 - 3/0	⊙ (5)	UD3 (2)	D3
YHD350	6	0.461 - 0.563	3/0 - 266.8	4/0 - 266	0.336 - 0.447	1/0 - 2/0	1/0 - 3/0	⊙ (7)	UD3 (3)	D3
YHD400	7	0.461 - 0.563	3/0 - 266.8	4/0 - 266	0.461 - 0.563	3/0 - 266.8	4/0 - 266	⊙ (7)	UD3 (3)	D3

Handtool or Hydraulic 4 Connector Program													
Catalog Number	Conductors (See Below for Compact Conductors)								Dimensions			Installation Data	
	Groove A (Run)				Groove B (Tap)							Tool Series, Die Set Cat. No. & (# of Crimps)	
	Wire Dia. Range	Sol.	Str.	ACSR	Wire Dia. Range	Sol.	Str.	ACSR	H	L	W	MD78 MD68	35, 750, Y45†, 46‡
YHO125	0.162 - 0.398	#6 - 2/0	#6 - 1/0	6 (6/1) - 1/0 (6/1)	0.162 - 0.332	#6 - 1/0	6 - #1	#6 (6/1) - #2 (7/1)	1.15	1.62	0.70	O	UO (2)
YHD250	0.475 - 0.563	250 - 300	4/0	3/0 (6/1) - 4/0 (6/1)	0.162 - 0.332	#6 - 1/0	6 - #1	#6 (6/1) - #2 (7/1)	1.47	1.62	0.89	D3	UD3 (2)
YHD350	0.461 - 0.563	250 - 300	3/0 - 4/0	3/0 (6/1) - 4/0 (6/1)	0.336 - 0.447	2/0 - 3/0	#1 - 2/0	#1 (6/1) - 2/0 (6/1)	1.42	2.25	0.89	D3	UD3 (3)
YHD400	0.461 - 0.563	250 - 300	3/0 - 4/0	3/0 (6/1) - 4/0 (6/1)	0.461 - 0.563	4/0	3/0 - 4/0	3/0 (6/1) - 4/0 (6/1)	1.40	2.50	0.84	D3	UD3 (3)

Compact Conductors							Installation Data			
Catalog Number	Groove A (Run)			Groove B (Tap)			Tool Series, Die Set Catalog No. & (No. of Crimps)		Die Index	
	Wire Diameter Range	Compact ACSR	Compact CU or AL	Wire Diameter Range	Compact ACSR	Compact CU or AL	MD78 MD68	35, 750, Y45†, 46‡		
YHO125	0.162 - 0.398	#6 - 2/0	#6 - 1/0	0.162 - 0.332	#6 - #1	#6 - #1	O	UO (2)	O	
YHD250	0.475 - 0.563	4/0 - 266.8	4/0 - 266	0.162 - 0.332	#6 - #1	#6 - #1	D3	UD3 (2)	D3	
YHD350	0.461 - 0.563	3/0 - 266.8	4/0 - 266	0.336 - 0.447	#1 - 2/0	1/0 - 3/0	D3	UD3 (3)	D3	
YHD400	0.461 - 0.563	3/0 - 266.8	4/0 - 266	0.461 - 0.563	3/0 - 266.8	4/0 - 266	D3	UD3 (3)	D3	

† U Die with adapter PT6515

‡ U Die with adapter PUADP1

⊙ See previous page for Seven Connector Selector Chart.

⊙ Permanent dies in tool install all sizes.

Not recommended for copper to copper applications. Use a copper connector to increase connection life.

HYCRIMP™ Connector, Types YHN, YHR

For Aluminum (Stranded, Compressed, Compact), Copper, ACSR, AAAC, Steel

Material: Aluminum

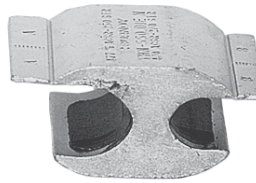

RUS Accepted

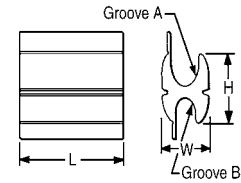

N Die Connectors*													
Catalog Number	Conductors (See Below for Compact Conductors)							Dimensions			Installation Data		
	Groove A (Run)			Groove B (Tap)							Tool, Die Set Catalog No. & (# of Crimps)		
	Wire Diameter Range	Str.	ACSR	Wire Diameter Range	Sol.	Str.	ACSR	H	L	W	35 and 750 Series	Y45	46 Series
YHN450	0.522 - 0.743	4/0 - 400	4/0 (6/1) - 397.5 (18/1)	0.522 - 0.743	336 - 477	4/0 - 400	4/0 (6/1) - 397.5 (18/1)	1.86	3.50	1.25	U-N (3)	S-N (3)	P-N (3)
YHN500	0.522 - 0.814	4/0 - 500	4/0 (6/1) - 477.0 (18/1)	0.162 - 0.447	#6 - 3/0	#6 - 2/0	#6 (6/1) - 2/0 (6/1)	1.96	1.62	1.28	U-N (2)	S-N (2)	P-N (2)
YHN525	0.522 - 0.814	4/0 - 500	4/0 (6/1) - 477.0 (18/1)	0.522 - 0.814	-	4/0 - 500	4/0 (6/1) - 477.0 (18/1)	1.82	4.50	1.23	U-N (3)	S-N (3)	P-N (3)
YHN550	0.573 - 0.814	250 - 500	266.8 (18/1) - 477.0 (18/1)	0.410 - 0.563	3/0 - 300	2/0 - 4/0	2/0 (6/1) - 4/0 (6/1)	1.90	2.00	1.28	U-N (2)	S-N (2)	P-N (2)
YHN600	0.573 - 0.814	250 - 500	266.8 (18/1) - 477.0 (18/1)	0.574 - 0.684	336 - 400	250 - 350	266.8 (18/1) - 336.4 (18/1)	2.00	3.50	1.28	U-N (3)	S-N (3)	P-N (3)

Compact Conductors							Installation Data			
Catalog Number	Groove A (Run)			Groove B (Tap)			Die Index	Tool, Die Set Catalog No. & (# of Crimps)		
	Wire Diameter Range	Compact ACSR	Compact CU or AL	Wire Diameter Range	Compact ACSR	Compact CU or AL		35 and 750 Series	Y45	46 Series
YHN450	0.522 - 0.743	266.8 - 477	250 - 500	0.522 - 0.743	266.8 - 477	250 - 500	N	UN (3)	SN (3)	PN (3)
YHN500	0.522 - 0.814	266.8 - 556.5	250 - 556	0.162 - 0.447	#6 - 2/0	#6 - 3/0	N	UN (2)	SN (2)	PN (2)
YHN525	0.522 - 0.814	266.8 - 556.5	250 - 556	0.522 - 0.814	266.8 - 556.5	250 - 556	N	UN (3)	SN (3)	PN (3)
YHN550	0.573 - 0.814	300 - 556.5	300 - 556	0.410 - 0.563	2/0 - 266.8	3/0 - 266.8	N	UN (2)	SN (2)	PN (2)
YHN600**	0.573 - 0.814	300 - 556.5	300 - 556	0.574 - 0.684	300 - 397.5	300 - 397.5	N	UN (3)	SN (3)	PN (3)

R Die Connectors*												
Catalog Number	Conductors (See Below for Compact Conductors)							Dimensions			Tool, Die Set Catalog No. & (# of Crimps)	
	Groove A (Run)			Groove B (Tap)							Y45	46 Series
	Wire Diameter Range	Str.	ACSR	Wire Diameter Range	Sol.	Str.	ACSR	H	L	W		
YHR700	.666 - .893	336 - 600	300 - 556 (18/1)	.398 - .684	3/0 - 350	2/0 - 350	1/0 - 336.4 (18/1)	3.04	3.50	1.74	SKR (3)	PKR (3)
YHR750	.666 - .893	336 - 600	300 - 556 (18/1)	.666 - .893	N/A	350 - 600	300 - 556 (18/1)	3.04	4.62	1.74	SKR (4)	PKR (4)
YHR800	.879 - 1.108	600 - 900	556.5 (18/1) - 795 (26/7)	.398 - .684	3/0 - 350	2/0 - 350	1/0 - 336.4 (18/1)	3.05	3.50	1.74	SKR (3)	PKR (3)
YHR850	.879 - 1.108	600 - 900	556.5 (18/1) - 795 (26/7)	.666 - .893	N/A	350 - 600	300 - 556 (18/1)	3.04	4.62	1.74	SKR (4)	PKR (4)
YHR900	.879 - 1.108	600 - 900	556.5 (18/1) - 795 (26/7)	.879 - 1.108	N/A	600 - 900	556.5 (18/1) - 795 (26/7)	2.97	4.62	1.74	SKR (4)	PKR (4)
YHR950	.666 - 1.165	336 - 1000	336.4 (18/1) - 954 (45/7)	.666 - 1.165	N/A	336 - 1000	336.4 (18/1) - 954 (45/7)	3.14	6.00	1.66	SKR (5)	PKR (5)

Compact Conductors							Installation Data		
Catalog Number	Groove A (Run)			Groove B (Run)			Die Index	Tool, Die Set Catalog No. & (# of Crimps)	
	Wire Diameter Range	Comp. ACSR	Compact CU or AL	Wire Diameter Range	Comp. ACSR	Compact CU or AL		Y45	46 Series
YHR700	.666 - .893	397 - 636	477 - 636	.398 - .684	2/0 - 397 (18/1)	3/0 - 397.5	KR	SKR (3)	PKR (3)
YHR750	.666 - .893	397 - 636	477 - 636	.666 - .893	397 - 636	477 - 636	KR	SKR (4)	PKR (4)
YHR800	.879 - 1.108	795 - 954	795 - 954	.398 - .684	2/0 - 397 (18/1)	3/0 - 397.5	KR	SKR (3)	PKR (3)
YHR850	.879 - 1.108	795 - 954	795 - 954	.666 - .893	397 - 636	477 - 636	KR	SKR (4)	PKR (4)
YHR900	.879 - 1.108	795 - 954	795 - 954	.879 - 1.108	795 - 954	795 - 954	KR	SKR (4)	PKR (4)
YHR950	.666 - 1.165	-	-	.666 - 1.165	N/A	-	KR	SKR (5)	PKR (5)

* HYCRIMP™ connectors can be installed with competitor R dies.
 ** Die Index ST and SZ may also be used on sizes 700 - 900 only. SKR required for 950 and S-Z.
 For faster installations use BURNDY® PATRIOT® family of battery tools.
 Not recommended for copper to copper applications. Use a copper connector to increase connection life.

LOKTAP™ Connector, Types YHO, YHD
For Aluminum, Copper

LOKTAP™ compression connectors are high quality, range-taking devices which accommodate combinations of aluminum to copper, and aluminum to aluminum conductors. BURNDY® seven connector program accommodates a conductor range from #6 Solid to 4/0 ACSR. In addition, LOKTAP™ connectors are designed to be installed with BURNDY® mechanical or hydraulic tools and matching O and D3 die set.

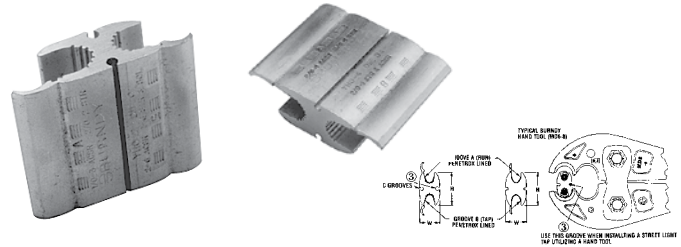

Handtool or Hydraulic 7 Connector Program ①														
Catalog Number	① Code No.	Conductors (See Below for Compact Conductors)								Dimensions			Installation Data	
		Groove A (Run)				Groove B (Tap)							② MD7, MD6	35, 750 Series Y45†, 46†
		Wire Diameter Range	Sol.	Str.	ACSR	Wire Diameter Range	Sol.	Str.	ACSR	H	L	W		
YHO1	1	0.162 - 0.328	#6 - #1	#6 - #1	#6 - #2	0.162 - 0.328	#6 - #1	#6 - #1	#6 - #2	1.11	1.25	0.67	(4)	UO (2)
YHO2	2	0.260 - 0.419	#1 - 2/0	3 - 2/0	#3 - 1/0	0.162 - 0.332	#6 - 1/0	#6 - #1	#6 - #2	1.12	1.50	0.64	(5)	UO (2)
YHD3	3	0.398 - 0.470	3/0 - 4/0	2/0 - 3/0	1/0 - 2/0	0.162 - 0.332	#6 - 1/0	#6 - #1	#6 - #2	1.47	1.88	0.76	(5)	UD3 (2)
YHD4	4	0.336 - 0.470	2/0 - 4/0	1 - 3/0	#1 - 2/0	0.336 - 0.477	2/0 - 3/0	#1 - 2/0	#1 - 2/0	1.42	1.88	0.83	(5)	UD3 (2)
YHD5	5	0.475 - 0.563	250 - 300	4/0	3/0 - 4/0	0.162 - 0.332	#6 - 1/0	#6 - #1	#6 - #2	1.47	1.88	0.87	(5)	UD3 (2)
YHD6	6	0.461 - 0.563	250 - 300	3/0 - 4/0	3/0 - 4/0	0.336 - 0.447	2/0 - 3/0	#1 - 2/0	#1 - 2/0	1.42	2.25	0.83	(6)	UD3 (3)
YHD7	7	0.461 - 0.563	250 - 300	250 - 300	3/0 - 4/0	0.461 - 0.563	200 - 300	3/0 - 4/0	3/0 - 4/0	1.40	2.52	0.84	(7)	UD3 (3)

Compact Conductors								Installation Data		
Catalog Number	① Code No.	Groove A (Run)			Groove B (Tap)			Tool Series, Die Set Catalog No. & (# of Crimps)		Die Index
		Wire Diameter Range	Compact ACSR	Compact CU or AL	Wire Diameter Range	Compact ACSR	Compact CU or AL	② MD7, MD6	35, 750, Y45†, 46†	
YHO1	1	0.162 - 0.328	#6 - #1	#6 - #1	0.162 - 0.328	#6 - #1	#6 - #1	(4)	UO (2)	O
YHO2	2	0.260 - 0.419	#2 - 1/0	#2 - 2/0	0.162 - 0.332	#6 - #1	#6 - #1	(5)	UO (2)	O
YHD3	3	0.398 - 0.470	2/0 - 3/0	3/0	0.162 - 0.332	#6 - #1	#6 - #1	(5)	UD3 (2)	D3
YHD4	4	0.336 - 0.470	1/0 - 3/0	1/0 - 3/0	0.336 - 0.447	1/0 - 2/0	1/0 - 3/0	(5)	UD3 (2)	D3
YHD5	5	0.475 - 0.563	4/0 - 266	4/0 - 266	0.162 - 0.332	#6 - #1	#6 - #1	(5)	UD3 (2)	D3
YHD6	6	0.461 - 0.563	3/0 - 266.8	4/0 - 266	0.336 - 0.447	1/0 - 2/0	1/0 - 3/0	(6)	UD3 (3)	D3
YHD7	7	0.461 - 0.563	3/0 - 266.8	4/0 - 266	0.461 - 0.563	3/0 - 266.8	4/0 - 266	(7)	UD3 (3)	D3

Handtool or Hydraulic 4 Connector Program													
Catalog Number	Conductors (See Below for Compact Conductors)								Dimensions			Installation Data	
	Groove A (Run)				Groove B (Tap)							② MD7, MD6	35, 750, Y45†, 46†
	Wire Dia. Range	Sol.	Str.	ACSR	Wire Dia. Range	Sol.	Str.	ACSR	H	L	W		
YHO125	0.162 - 0.398	#6 - 2/0	#6 - 1/0	#6 - 1/0	.162 - .332	#6 - 1/0	#6 - #1, 19 Str.	#6 - #2	1.15	1.62	0.70	UO (2)	
YHD5	0.475 - 0.563	250 - 300	4/0	3/0 (6/1) - 4/0 (6/1)	0.162 - 0.332	#6 - 2	#6 - 1/0	#6 - #1	1.47	1.88	0.87	UD3 (2)	
YHD6	0.461 - 0.563	250 - 300	3/0 - 4/0	3/0 (6/1) - 4/0 (6/1)	0.336 - 0.447	#1 - 2/0	2/0 - 3/0	#1 - 2/0	1.42	2.25	0.83	UD3 (3)	
YHD7	0.461 - 0.563	250 - 300	250 - 300	3/0 (6/1) - 4/0 (6/1)	0.461 - 0.563	3/0 - 4/0	200 - 300	3/0 - 4/0	1.40	2.52	0.84	UD3 (3)	

Compact Conductors							Installation Data	
Catalog Number	Groove A (Run)			Groove B (Tap)			Tool, Die Set No. & (# of Crimps)	Die Index
	Wire Dia. Range	Compact ACSR	Compact CU or AL	Wire Dia. Range	Compact ACSR	Compact CU or AL		
YHO125	0.162 - 0.398	#6 - 2/0	#6 - 1/0	.126 - .332	#6 - #1	#6 - #1	UO (2)	O
YHD5	0.475 - 0.563	4/0 - 266	4/0 - 266	.162 - 0.332	#6 - #1	#6 - #1	UD3 (2)	D3
YHD6	0.461 - 0.563	3/0 - 266.8	4/0 - 266	.338 - 0.447	1/0 - 2/0	1/0 - 3/0	UD3 (3)	D3
YHD7	0.461 - 0.563	3/0 - 266.8	4/0 - 266	.461 - 0.563	3/0 - 266.8	4/0 - 266	UD3 (3)	D3

① See page H-27 for Seven Connector Selector Chart.
 ② PERMANENT DIES IN TOOL INSTALL ALL SIZES.
 ③ "C" grooves accommodate #10 Sol. #14 Sol. range, .116"-.064". No "C" grooves on Cat. #YHO125. When utilizing "C" groove(s) apply PENETROX™ A13 prior to wire installation. If utilizing two (2) "C" groove taps, installation to be made with HYDRAULIC TOOL ONLY. All four (4) grooves CANNOT be utilized if using a hand tool. When hand tool is used, only one (1) "C" groove can be used; connector MUST be positioned as shown in drawing.

† U Die with adapter PT6515.
 ‡ U Die with adapter PUADP1.

HYTEE™ T-Tap Connector, Type YCT For Copper

Material: Tin Plated Copper

One-piece, copper compression tap connector with U-shaped run element and tubular tap for joining hard and medium-hard drawn copper. Preformed run element simplifies installation on larger conductors. Uses same die as equivalent full-tension sleeve.

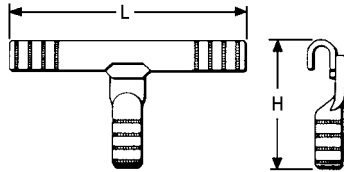

Conductors			H	L	Die Index	Run		Tap	
Catalog Number	Run	Tap				Tool Series, Die Set Catalog Number, & (Crimps per End)			
						MD7, MD6	35, 750, Y45 †, 46 ‡	MD6	35, 750, Y45 †, 46 ‡
YCT2626	2/0 (7, 12, 19)	2/0 (7, 12, 19)	3.26"	5.62"	166	W166 (4)	U166/U459 (2)	W166 (6)	U-166 (3)
YCT2828	4/0 (7, 12, 19)	4/0 (7, 12, 19)	4.00"	5.72"	168	—	U168(2)	—	U-168 (3)

† U Die with adapter PT6515.
‡ U Die with adapter PUADP1.

For faster installations use BURNDY® PATRIOT® family of battery tools.

HYTEE™ T-Tap Connector, Type YOT For Copper

Material: Tin Plated Copper

Cast copper T-tap connector with two-piece line element and tubular tap for joining hard and medium drawn copper. Design simplifies installation on large conductors. Uses same die as equivalent sleeve.

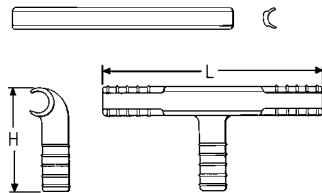

Catalog Number	Run	Tap	H	L	Die Index	Run		Tap	
						Tool Series, Die Set Catalog Number, & (Crimps per End)			
						35, 750, Y45 †, 46 ‡	Y60B	35, 750, Y45 †, 46 ‡	60
YOT3434	500 (19, 37)	500 (19, 37)	4.82"	10.38"	210	U210 (6)	L210 (2)	U210 (6)	L210 (2)

† U Die with adapter PT6515.
‡ U Die with adapter PUADP1.

For faster installations use BURNDY® PATRIOT® family of battery tools.

T-Tap Connector, Type YTU-R-R

For Copper, AAC (Stranded, Compressed, Compact),
ACSR, AAAC

Material: Aluminum

One-piece heavy-wall aluminum compression tap connector for secondary service drop and transformer tap to primary or secondary. Connector can be gripped in tool for easy installation. Pre-filled with PENETROX™ joint compound, stripsealed and capped to limit oxide growth and to increase the life of the connection.

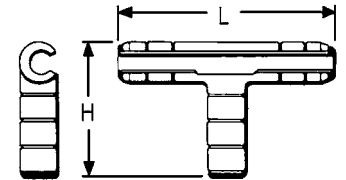
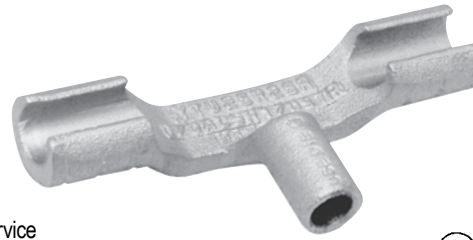

Catalog Number	Run			Tap			H	L	Tool Series, Die Set Catalog Number, & (Crimps per End)					
	ACSR, 6201, 5005	Aluminum	Copper	ACSR, 6201, 5005	Aluminum	Copper			Run			Tap		
									Die Index	MD7, MD6	35, 750, Y45†, 46 Series‡	Die Index	MD7, MD6	35, 750, Y45, 46 Series‡
YTU25R4W	1/0 80 (8-1)	1/0 (7, 19)	1/0 (7, 12, 19)	#6	#4 (7) #4 SLD	#4 (7) #4 Sol.	2-3/8	4-7/8	C	WC (2)	UC (1)*	BG	BG (3) WBG (1)*	UBG (1)*
YTU25R25R				1/0 80 (8-1)	1/0 (7, 19)	—								
YTU26R26R	2/0	2/0 (7, 19)	2/0 (7, 12, 19)	2/0	2/0 (7, 19)	2/0 (7, 12, 19)	3-3/8	7	L	WL (4)	UL (2)	L	—	UL (2)
YTU27R27R	3/0	3/0 (7, 19)	3/0 (7, 12, 19)	3/0	3/0 (7, 19)	3/0 (7, 12, 19)								
YTU28R28R	4/0	4/0 (7, 19)	4/0 (7, 12, 19)	4/0	4/0 (7, 19)	4/0 (7, 12, 19)								
YTU30R30R	266.8 (18-1, 26-7, 6-7)	266.7 (7, 19, 37) 250 (19, 37) 300 (19, 37)	250 (12, 19, 37) 300 (19, 37)	266.8 (18-1, 26-7, 6-7)	266.7 (7, 19, 37) 250 (19, 37) 300 (19, 37)	250 (12, 19, 37)	4-3/8	8-3/4	M	—	UM (3)	M	—	UM (3)
YTU321R2R	300 (26-7) 336.4 (18-1)	350 (19, 37) 336.4 (19, 37)	350 (19, 37)	2	2 (7 STR.)	2 (3, 7 Str.)	2-5/8	6-5/8	M			BG	BG (3) WBG (1)*	UBG (1)*
YTU321R26R				2/0	2/0 (7, 19)	2/0 (7, 12, 19)	3-1/2	8-5/8	M			L	—	UL (2)
YTU321R27R				3/0	3/0 (7, 19)	3/0 (7, 12, 19)								
YTU321R28R				4/0	4/0 (7, 19)	4/0 (7, 12, 19)								
YTU321R321R				336.4 (18-1) 300 (26-7)	336.4 (19, 37) 350 (19, 37)	350 (19, 37)	—	—	M			M	—	UM (2)
YTU33R26R				336.4 (30.7) (26-7) 397.5 (18.1)	397.5 (19, 37) 400 (19, 37)	400 (19, 37)	2/0	2/0 (7, 19)	2/0 (7, 12, 19)			3-1/2	8-5/8	M
YTU33R28R	4/0	4/0 (7, 19)	4/0 (7, 12, 19)				M	L	—					
YTU33R33R	400 (19, 37)	336.4 (30-7, 26-7) 397.5 (181)	400 (19, 37)				397.5 (19, 37) 400 (19, 37)	400 (19, 37)	4-3/8			8-3/4	M	M

* Multiple crimp die set, makes more than one crimp per tool compression. Figure indicates number of compressions.

† U Die with adapter PT6515

‡ U Die with adapter PUADP1.

Not recommended for copper to copper applications. Use a copper connector to increase connection life.

For faster installations use BURNDY® PATRIOT® family of battery tools.

Disconnectable T-Tap with Pad, Type YTA-R-2N

For Copper, AAC (Stranded, Compressed, Compact),
ACSR, AAAC

Material: Aluminum

Aluminum primary T-Tap connector with slotted tap pad designed for easy disconnecting of tap conductor. Tap pad accommodates compression terminals Types YKA-R-2N and YKA-A-2N and has positioning socket for proper alignment. On sizes larger than 336.4 ACSR, the Type YTA-R-2N run element has two piece interlocking key with lifting eye to simplify hotline installations. Catalog number does not include mating terminal.

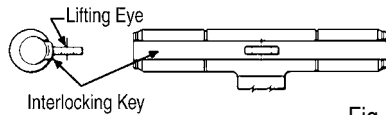
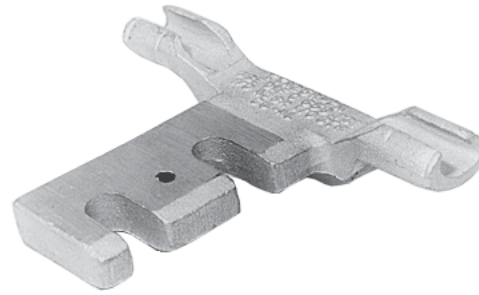

Fig. 2

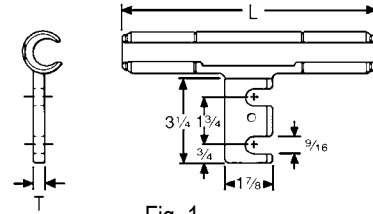

Fig. 1

Catalog Number	ACSR, 6201, 5005	Copper	Aluminum	Fig. No.	L	T	Die Index	Tool Series, Die Set Catalog Number, & (# of Crimps per End)				
								MD7, MD6	35, 750	Y45 †	46 ‡	60
YTA2R2N	2	2 (3, 7) 1 (7)	2 (7) 1 (7)	1	6-1/8	3/8	BG or 243	BG (2) W-BG (1)* W243 (2)	U-BG (1)* U243 (1)			
YTA25R2N	1/0	1/0 (7, 12, 19)	1/0 (7, 19)	1				247 C 659	W-C (4) W247 (1)	U659 (1) U-C (1) U247 (1)		
YTA26R2N	2/0	2/0 (7, 12, 19)	2/0 (7, 19)	1	7-7/8		L or 251	W-L (4)	U-L (2) U251 (3)			
YTA27R2N	3/0	3/0 (7, 12, 19)	3/0 (7, 19)	1								
YTA28R2N	4/0	4/0 (7, 12, 19)	4/0 (7, 19)	1								
YTA321R2N	300 (26-7) 336.4 (18-1)	350 (19, 37)	336.4 (19, 37, 61) 350 (19, 37, 61)	1	9-1/2	1/2	M		U-M (3) U317 (4)			
YTA33R2N	336.4 (26-7, 30-7) 397.5 (18-1)	400 (19, 37)	397.5 (19, 37, 61) 400 (19, 37, 61)	1								
YTA361R2N	477 (18-1)	—	—	2	13-1/8			—				
YTA37R2N	477 (24-7, 26-7, 30-7)	—	556.6 (19, 37)	2						U-M (5)		
YTA39R2N	556.5 (24-7, 26-7)	—	636 (37) 650 (61)	2	16-1/4			608	U608 (9)			L608 (3)
YTA43R2N	605 (30-19) 605 (30-9) 636 (24-7, 26-7, 30-19) 666.6 (24-7)	—	795 (37, 61)	2	16-1/2	3/4	292 or 319	—		S929 (9) S319 (9)	P929 (9) P319 (9)	L929 (9) P319 (9)
YTA391A2N	—	—	795 (37, 61)	2						342		S342 (9)

* Multiple crimp die set, makes more than one crimp per tool compression. Figure indicates number of compressions.

† U Die with adapter PT6515.

‡ U Die with adapter PUADP1.

For faster installations use BURNDY® PATRIOT® family of battery tools.

Disconnectable Terminal with Fixed Hardware Types YKA-R-2N, YKA-A-2N

For AAC (Stranded, Compressed, Compact), Copper, ACSR, AAAC

Material: Aluminum

Aluminum compression terminal with fixed hardware and positioning pin for making disconnectable tap or jumper connections. Used with slotted YTA-R-2N T-Tap or YSA-R-2N terminal. Supplied with aluminum bolts and washer-face, self locking nuts. Prefilled with PENETROX™ joint compound, capped, and stripsealed to limit oxide growth and to increase the life of the connection.

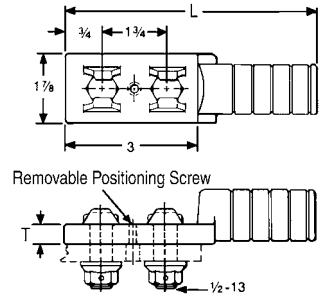

Catalog Number	ACSR, 6201, 5005	Copper	Aluminum	L	T	Bolt Length	Die Index	Tool Series, Die Set Catalog Number, & (Number of Crimps per End)				
								MD7, MD6	35, 750	Y45 †	46 ‡	60 Series
YKA2R2N	2	1 (7) 2 (3, 7)	1 (7) 2 (7)	5-1/2	3/8	1-3/4	BG or 243	BG (8) WBG (4)* W243 (4)	UBG (3)* U243 (2)	—	—	—
YKA25R2N	1/0	1/0 (7, 19)	1/0 (7, 19)	5-5/8			C or 659	WC (6)	UC (3)* U629 (2)	—	—	—
YKA26R2N	2/0	2/0 (7, 19)	2/0 (7, 19)	6			L or 251	—	UL (2) U251 (3)	—	—	—
YKA27R2N	3/0 110.8 (12-7)	3/0 (7, 19)	3/0 (7, 19)									
YKA28R2N	4/0	4/0 (7, 19)	4/0 (7, 19)									
YKA30R2N	266.8 (18-1, 6-7, 26-7)	250 (12, 19, 37) 300 (19, 37)	250 (7, 37) 266 (19)	7-1/4			M or 317	—	UM (3) U317 (4)	—	—	—
YKA321R2N	336.4 (18-1) 300 (26-7)	350 (19, 37)	300 (37, 61) 350 (37, 61)									
YKA33R2N	336.4 (26-7, 30-7) 397.5 (18-1)	—	397.5 (19) 400 (37)									
YKA361R2N	397.5 (26-7, 30-7) 477 (18-1)	—	477 (19, 37) 500 (37, 61)									
YKA37R2N	477 (24-7, 26-7, 30-7)	—	556.5 (19, 37)	7-3/8			M	—	UM (3)	—	—	—
YKA34CA2N	397.5 (26-7, 30-7) 477 (18-1)	500 (19, 37)	477 (19, 37) 500 (37, 61)	—	352 or 579	—	—	S352 (6) S579 (6)	P352 (6) P579 (6)	L352 (9) L579 (9)		
YKA391A2N	—	—	795 (37, 61)	9-1/2	3/4	2-1/2	342	—	—	S342 (6) P342 (6)	L342 (9)	

* Multiple crimp die set, makes more than one crimp per tool compression. Figure indicates number of compressions.

† U Die with adapter PT6515.

‡ U Die with adapter PUADP1.

For faster installations use BURNDY® PATRIOT® family of battery tools.

Disconnectable Terminal with Slotted Pad, Type YSA-R-2N

For AAC (Stranded, Compressed, Compact), Copper, ACSR, AAAC

Material: Aluminum

Aluminum compression terminal with slotted pad and positioning socket for making disconnectable tap or jumper connections. Used with Type YKA-R-2N fixed hardware terminal. Pre-filled with PENETROX™ joint compound, stripsealed, and capped to limit oxide growth and to increase the life of the connection.

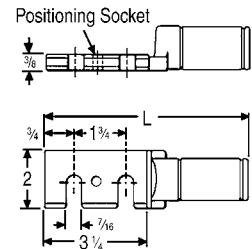

Catalog Number	ACSR, 6201, 5005	Copper	Aluminum	L	Die Index	Tool Series, Die Set Catalog Number, & (Number of Crimps)	
						MD7, MD8	35, 750, Y45 †, 46 ‡
YSA2R2N	2	2 (3, 7) 1 (7)	2 (7) 1 (7)	6-1/4	BG or 243	BG (8) WBG (4)* W243 (4)	UBG (3)* U243 (2)
YSA25R2N	1/0	1/0 (7, 19)	1/0 (7, 19)		C or 659	—	—
YSA26R2N	2/0	2/0 (7, 19)	2/0 (7, 19)	6-5/8	L or 251	—	UL U251
YSA28R2N	4/0	4/0 (7, 19)	4/0 (7, 19)				
YSA30R2N	266.8 (18-1, 6-7, 26-7)	250 (12, 19, 37) 300 (19, 37)	250 (37) 266.8 (7, 19)	7-3/4	M or 317	—	UM (3) U317 (4)
YSA321R2N	336.4 (18-1) 300 (26-7)	350 (19, 37)	300 (37, 61) 350 (37, 61)				
YSA37R2N	477 (24-7, 26-26-7, 30-7)	—	556.5 (19, 37)	7-7/8	M	—	UM (3)

* Multiple crimp die set, makes more than one crimp per tool compression. Figure indicates number of compressions.

† U Die with adapter PT6515.

‡ U Die with adapter PUADP1.

For faster installations use BURNDY® PATRIOT® family of battery tools.

Disconnectable T-Tap, Type YTA-2N

For Copper

Material: Copper

Cast copper primary T-Tap connector with slotted tap pad for easy disconnecting of tap conductor. Tap pad accommodates compression terminal Type YKA-2N. On sizes larger than 4/0, the YTA-2N run element has a two-piece, interlocking key with lifting eye that simplifies hot installations. Catalog number does not include terminal or hardware.

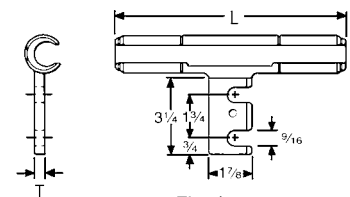
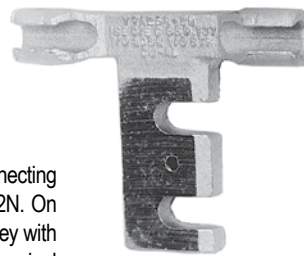

Fig. 1

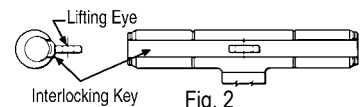

Fig. 2

Catalog Number	Conductor	Fig. No.	C	L	T	Die Index	Tool Series, Die Set Catalog Number, & (Number of Crimps)		
							MD7, MD6	35, 750, Y45, 46	60
YTA2C2N	2 (7)	1	1-1/2	5-5/8	3/8	163	W163 (3) Crimps Overlap	U163 (1)*	—
YTA262N	2/0 (7, 19)			7-3/8		166	W166 (6)	U166 (3)	—
YTA282N	4/0 (7, 12, 19)			7-5/8		168	—	U168 (4)	—
YTA342N	500 (19, 37, 61)	2	2	11-7/8	1/2	210	—	U210 (6)	L210 (2)

* Multiple crimp die set, makes more than one crimp per tool compression. Figure indicates number of compressions.

† U Die with adapter PT6515.

‡ U Die with adapter PUADP1.

For faster installations use BURNDY® PATRIOT® family of battery tools.

Disconnectable Terminal with Fixed Hardware Type YKA-R-2N

For Copper

Material: Tin Plated Copper

Tin-plated copper compression terminal with fixed hardware for making disconnectable tap or jumper connections. Used with slotted Type YTA-2N T-tap or Type YSA-R-2N terminal. Supplied with tin-plated DURIMUM™ bolts and washer-face nuts.

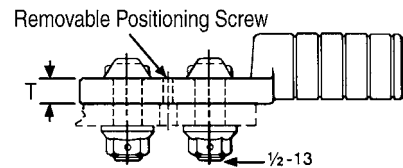
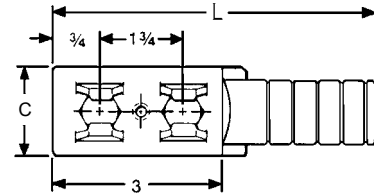

Catalog Number	Conductor	C	L	T	Die Index	Tool Series, Die Set Catalog Number, & (Number of Crimps)		
						MD7, MD6	35, 750, Y45†, 46‡	60 Series
YKA6C2N	6 (7)	7/8	5	3/8	163	W163 (2) Crimps Overlap	U163 (1)*	—
YKA2C2N	2 (7)							
YKA262N	2/0 (7, 19, 37)	1	5-1/4	1/4	166	W166 (4)	U166 (3)	
YKA282N	4/0 (7, 12, 19, 37)	1-1/4	5-3/8	3/8	168	—	U168 (3)	L168 (1)
YKA302N	300 (19, 37, 61)	1-1/2	5-1/2		170		U170 (5)	L170 (1)
YKA342N	500 (19, 37, 61)	1-7/8	6-1/2	210	U210 (6)		L210 (2)	
YKA442N	1000 (61)	2	7-5/8	345	—		L345 (4)	

* Multiple crimp die set, makes more than one crimp per tool compression. Figure indicates number of compressions.

† U Die with adapter PT6515.

‡ U Die with adapter PUADP1.

For faster installations use BURNDY® PATRIOT® family of battery tools.

STIRRUP™ Hot-Line Clamp Adapters, Type YCB-R For AAC (Stranded, Compressed, Compact), ACSR, AAAC

Material: Aluminum; Tin Plated Copper Bail

Permanent compression hot-line clamp adapter with aluminum run and copper bail. Accommodates any standard copper hot-line clamp on bail elements. Permits hot-line tapping without arcing or chafing damage to aluminum conductor. Installed with standard tools and dies. Prefilled with PENETROX™ joint compound and stripsealed to limit oxide growth and increase the life of the connection.

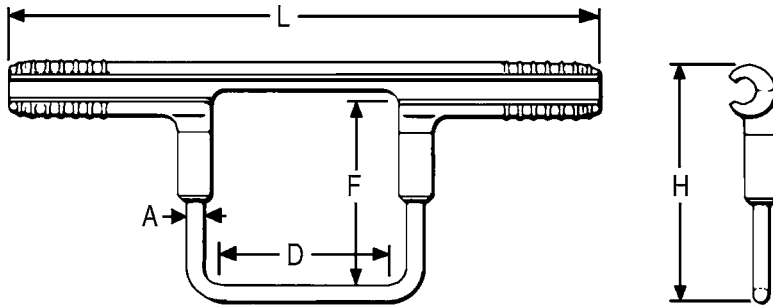

Catalog Number	Aluminum	ACSR, 6201, 5005	A	H	L	D	F	Die Index	Tool Series, Die Set Catalog Number, & (Crimps per End)	
									MD7, MD6	35, 750, Y45 †, 46 ‡
YCB2R	2 Str. - 6 Sol.	2-4	2 Sol.	3-3/4	9	2-1/2	2-1/2	BG	BG (6) WBG (2)*	UBG (2)*
YCB25R	1/0 (7, 19)	1/0 - 80 (8-1)	2 Sol.	5	9-3/4	2-1/2	3-1/2	C	WC (4)	UC (2)*
YCB26R	2/0 (7, 19)	2/0	1/0 Sol.	5	11-1/8	3-1/2	3-1/2	L	WL (4)	UL (2)
YCB27R	3/0 (7, 19)	3/0	1/0 Sol.	5	11-1/8	3-1/2	3-1/2	L	WL (4)	UL (2)
YCB28R	4/0 (7, 19)	4/0	1/0 Sol.	5	11-1/8	3-1/2	3-1/2	L	WL (4)	UL (2)
YCB321R	350 (19, 37) 336.4 (19, 37)	336.4 (18-1) 300 (26-7)	1/0 Sol.	5-3/8	12-3/4	3-1/2	3-1/2	M	—	UM (3)
YCB33R	400 (19, 37) 397.5 (19, 37)	336.4 (26-4, 30-7) 397.5 (18-1)	1/0 Sol.	5-3/8	12-3/4	3-1/2	3-1/2	M	—	UM (3)
YCB35R	500 (37, 61) 477 (19, 37)	397.5 (26-7) (30-7)	1/0 Sol.	5-3/8	12-3/4	3-1/2	3-1/2	M	—	UM (3)
YCB361R	477 (19, 37)	477 (18-1)	1/0 Sol.	5-1/4	13-1/4	3-1/2	3-1/2	317	—	U317 (3)

* Multiple crimp die set, makes more than one crimp per tool compression. Figure indicates number of compressions.

† U Die with adapter PT6515.

‡ U Die with adapter PUADP1.

For faster installations use BURNDY® PATRIOT® family of battery tools.

CRIMPIT™ STIRRUP™, Types YCB-U, YCB-R-U

For AAC (Stranded, Compressed, Compact), ACSR, AAAC

Material: Aluminum

Tension Rating: ANSI C119.4 Class 3 (Non Tension)

Combines Figure 6-shaped aluminum CRIMPIT™ tap connector with tin-plated copper bail. Can be gripped in tool and slipped over line for easy installation. Five sizes accept a range from #4 to 600 kcmil. Prefilled with PENETROX™ joint compound and stripealed to limit oxide growth and to increase the life of the connection.

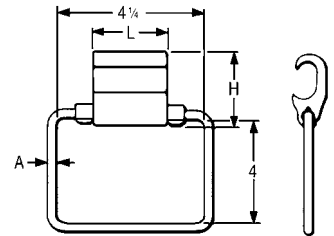

Catalog Number	Aluminum	ACSR, 6201, 5005	A	H	L	Die Index	Tool Series, Die Set Catalog Number, & (Number of Crimps)		
							35, 750	Y45	46
YCB4U1	4 Sol. - 4 (7)	4	2 Sol.	1-1/2	1-7/8	D	UD (2)	†	‡
YCB1U1	2 (7) - 1 (7)	2		1-5/8					
YCB28U26	1/0 (7) - 4/0 (19)	1/0 - 4/0		2	2-1/8	H	UH (2)		
YCB33R26U	300 (37) - 400 (37)	266.8 (6-7) - 336.4 (30-7)	1/0 Sol.	R		UR (2)			
YCB38R26U	397.5 (19) - 600 (61)	336.4 (26-7) - 556.5 (18-1)		N		UN (2)	SN (2)	PN (2)	

* Index number "D" is not "D3" Cabelok CRIMPIT™ die.

† U Die with adapter PT6515

‡ U Die with adapter PUADP1.

For faster installations use BURNDY® PATRIOT® family of battery tools.

Hot-Line Clamp Bails, Types J990, J1252

Material: Tin Plated Copper

Designed to make hot-line clamp adapter using HYCRIMP™, CABELOK™ CRIMPIT™ or Figure 6-shaped CRIMPIT™ connectors. Where hot sticks are used, the CABELOK™ CRIMPIT™ or Figure 6-shaped CRIMPIT™ are recommended. The line can be approached with the connector and bail held in the tool. Bails are tin-plated, hard drawn copper.

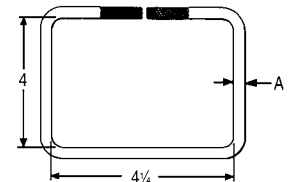

Recommended Connector & Bail Combinations						
HYCRIMP™ Cat. No.	CABELOK™ CRIMPIT™ Cat. No.	Bail Cat. No.	A	Run Conductors Accommodated		
				Sol. Al	Str. Al	ACSR
YHO100	YP2U3	J990	#2	6 - 2	6 - 3 (7 Str.)	6,4
YHO150	YP26AU2			1 - 2/0	3 (3 Str.) - 1/0	3 - 1/0
YHD200	YP27AU4			3/0 - 4/0	2/0 - 3/0	1/0, 2/0
YHD250	YPC28U4			—	4/0	3/0, 4/0
YHD300	YP27AU26	J1252	2/0	3/0	2/0, 3/0	2/0
YHD350	YP28U26			—	4/0	3/0, 4/0
—	YPC28U26	J990	#2	—	1/0 (7) - 4/0	1/0 - 4/0
		J1252	2/0			
YHN500	YPC33R26U	J990	#2	—	250 (37)	266.8 (18-1)
		J1252	2/0			

* For additional run & tap conductors see specific connector catalog page.

HYCRIMP™ STIRRUP™ Tap Connectors with Bail, Types YHO-J, YHD-J, YHN-J

For AAC (Stranded, Compressed, Compact), ACSR

Material: Aluminum; Tin Plated Copper Bail

Utilizes H-Frame Aluminum Tap Connectors along with tin-plated copper bail. Bendable tabs secure run and bail freeing the lineman's hands to work with the installation tool. Conductor grooves are prefilled with PENETROX™ joint compound and stripsealed to limit oxide growth and increase the life of the connection.

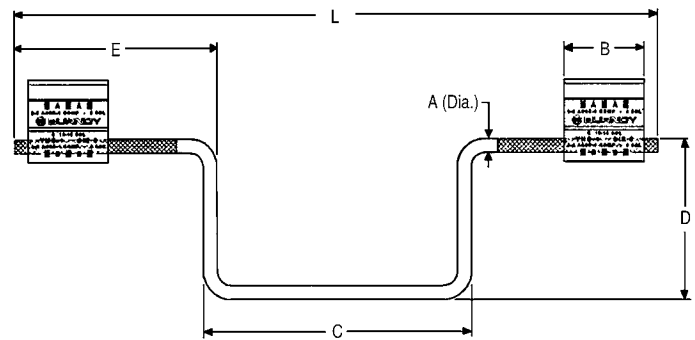

Catalog Number	Run Conductor Accommodates			A	B	C	D	E	L	Die Index	Tool Series, Die Set Catalog Number, & (# of Crimps)	
	Sol. Al	Str. Al	ACSR								① MD7-8 MD6-8	35, 750, Y45 †, 46 ‡
YHO100J1444	6-1	6-1 (7 Str.)	6-2	2 Sol. (0.258)	1.50	5.00	3.00	3.75	12.00	O	(4)	U-O (2)
YHO150J1444	1-2/0	3-2/0	3-1/0		1.75	5.00	3.00	3.75	12.00	O	(5)	U-O (2)
YHD200J1444	3/0 - 4/0	2/0 - 3/0	1/0 - 2/0		1.88	5.00	3.00	3.75	12.00	D3	(5)	UD-3 (2)
YHD250J1444	250 - 300	4/0	3/0 - 4/0		1.88	5.00	3.00	3.75	12.00	D3	(5)	UD-3 (2)
YHD300J1496	2/0 - 4/0	#1 - 3/0	#1 - 2/0	2/0 Sol. (0.365)	1.88	5.00	4.75	5.62	15.50	D3	(5)	UD-3 (2)
YHD350J1496	250 - 300	3/0 - 4/0	3/0 - 4/0		2.50	5.00	4.75	5.62	15.50	D3	(7)	UD-3 (2)
YHN500J1496	—	4/0 - 500	4/0 - 477 (18/1)		2.00	5.00	4.75	5.62	15.50	N	—	U-N (2)

① Permanent dies in tool install all sizes.

† U Die with adapter PT6515

‡ U Die with adapter PUADP1.

For faster installations use BURNDY® PATRIOT® family of battery tools.

Transformer and Equipment Tap Connectors

General Overview

Transformer and equipment tap connectors are specifically designed to provide single or multi-tap connections from secondary transformer outlets, disconnects, circuit breaker panels, and other equipment pads or bar.

Transformer Tap Adapter, Type E-C-G

For Copper

Material: Copper

Tension Rating: ANSI C119.4 Class 3 (Non Tension)

Multi-tap, range-taking cast copper alloy connector designed to take 2, 3, or 4 conductors from a single secondary transformer outlet.

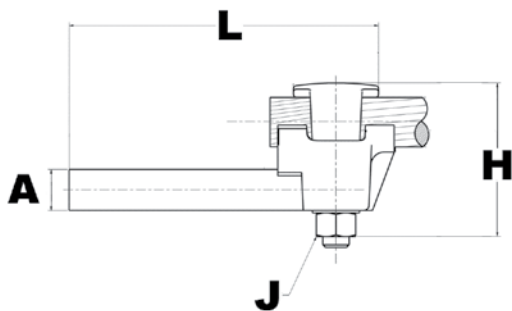

Fig.1

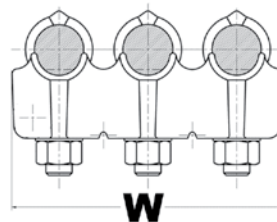

Fig.2

Catalog Number	Number of Conductors	Conductor Size	A dia.	D	H	J	L	W
E2C34G1	2	1/0 -500 kcmil	0.78	3-3/4	3-7/8	1/2 - 13	6 - 1/4	3-1/2
E3C34G1	3							5-1/4
E4C34G1	4							6-7/8

Transformer Ground Connectors, Types KC22J12T13, EQC632C

For Copper

Material: Copper

Fits all standard EEI-NEMA distribution transformers as tank grounding terminal.

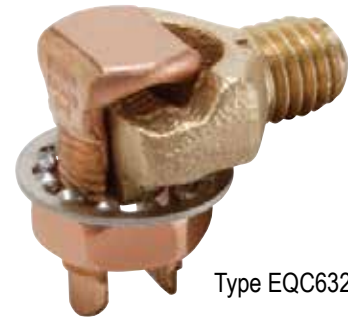

Type EQC632C

TYPE KC	Ranges
KC22J12T13	8 Sol. - 2 Sol.
KC26	2 Sol. - 2/0 Str.
KC34J12T13	3/0 - 500 Str.
EQC632C	8 Sol. - 2 Str.

Both, one-wrench installation.

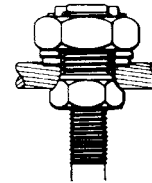

Type KC22B2

1/2-13
stud size

HYSEALUG™ Terminal with Shrouded Barrel, Type YA-2LH

For Copper

Material: Copper

Tin-plated, pure copper 2-hole NEMA compression terminal with shrouded barrel for terminating insulated copper conductor to transformers and other equipment. Shroud prevents seepage of water or moisture into conductor strands and minimizes taping.

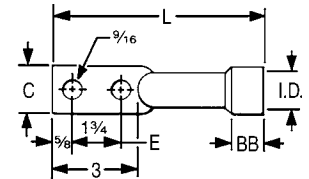
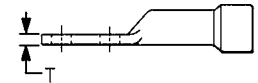

Catalog Number	Conductor	BB	Shroud Inside Diameter	C	L	T	Tool Series, Die Set Catalog Number, & (Number of Crimps)	
							MD7, MD6	35, 750, Y45 †, 46 ‡
YAB4C2LH72	4 Str.	5/8	0.57	3/4	6-1/4	1/8	W161 (2)	U4CRT (2)
YAB2C2LH74	2 Str.	3/4	0.58		6-1/2		W162 (4)	U2CRT (2)
YAB2C2LH75			0.91		W163 (4)		U25RT (2)	
YAB252LH70	1/0 Str.	1	0.69	7/8	6-3/4	3/8	W163 (4)	U25RT (2)
YAB252LH71			0.98		6-1/4		W241 (2)	U26RT (2)
YA262LH89	2/0 Str.		1.04		6-1/4		W241 (2)	U26RT (2)
YA282LH114	4/0 Str.		0.86	1	6-5/8	1/8	W-BG or W243 (2)	U28RT (2)
YA282LH115			1.24				W166 (4)	U29RT (2)
YA292LH91	250	1.25	1-1/8	1-1/4	7	1/8	—	U30RT (2)
YA302LH85	300	0.92	1-1/4		7-5/8		W-0 (5)	U31RT (2)
YA312LH90	350	1.40	1-3/8		7-3/4		1/4	—
YA342LH110	500	1-1/2	1.14	1-1/2	7-3/4	1/4	—	U34RT (2)
YA342LH111			1.88				—	U34RT (2)

† U Die with adapter PT6515

‡ U Die with adapter PUADP1.

HYSEALPLUG™ Transformer Pin Terminal, Type YE-LH

For Copper

Material: Copper

Tension Rating: ANSI C119.4 Class 3
 (Non Tension)

Oil and water-tight terminal with shrouded, tin-plated, copper barrel, and brazed plug. Recommended for terminating insulated copper conductor at cutout, transformer and arrester; or for joining insulated copper riser to overhead conductor. Shroud prevents seepage of water or moisture into conductor strands and minimizes taping. To obtain a tight fit on some insulations in the shroud it may be necessary to either "pencil" the insulation down, or build it up with tape.

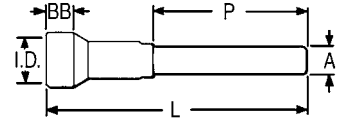

Catalog Number	Conductor	BB	Shroud Inside Dia.	A Dia.	L	P	Tools, Die Set Catalog Number, & (# of Crimps)	
							MD6, MD7	35, 750, Y45 †, 46 ‡
YE2CLH128	2 Str.	3/4	0.58	2 Sol.	9	6	W162 (4)	U2CRT (2)
YE2CLH129			0.91					
YE25LH97	1/0 Str.	1	0.98	1/0 Sol.	11-1/8	8	W163 (4)	U25RT (2)
YE26LH88	2/0 Str.		0.73	2/0 Sol.	11-3/8		W241 (2)	U26RT (2)
YE26LH89			1.04				W241 (2)	
YE28LH128	4/0 Str.		1.24	4/0 Sol.	11-1/2		WBG or W243 (2)	U28RT (2)
YE31LH96	350	1.03	12-1/4		WO (5)	U31RT (2)		
YE34LH119	500	1.14	13-1/4		—	—	U34RT (2)	
YE34LH120		1.88						

† U Die with adapter PT6515.

‡ U Die with adapter PUADP1.

For faster installations use BURNDY® PATRIOT® family of battery tools.

HYPLUG™ Pin Terminal, Types YE-R, YE-W

For AAC (Stranded, Compressed), ACSR, AAAC

Material: Aluminum

Tension Rating: ANSI C119.4
 Class 3
 (Non Tension)

In 1989 BURNDY® began shipping an improved pin type connector. A proprietary coating system was developed through intense research efforts which vastly prolongs the life of this type of connection. To help identify the new product, a hex-shaped crimp is now used on the pin interface crimp and overhead color-coded end caps are utilized.

Aluminum HYPLUG™ with tin-plated copper plug for terminating aluminum or ACSR cable at cutout, transformer, and arrester. Plug may be bend to desired angle for easier insertion. Three die sets accommodate #4 Stranded to 500 kcmil. Prefilled with PENETROX™ A13 joint compound and sealed with color-coded end caps.

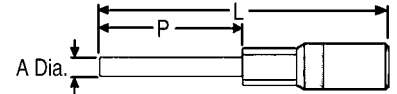

Catalog Number	Conductor		A Dia.	L	P	Color Code	Die Index	Tool Series, Die Set Catalog Number		
	Alum.	ACSR						MD7, MD6	35, 750, Y45 †, 46 ‡	60 Series
YE6R25	5, 6 Str.	6	4 Sol.	4-5/8	2-1/2	Blue	K-5/8-1, 243, BG, 8A	BG WBG W243	UBG U243 UK5/81T	L243
YE4R25	3, 4 Str.	4				Orange				
YE1WAG1	#1 Sol. (.289)	—	0.25	8.58 (218)	6	Red	K-5/8-1, 243, BG	BG WBG W243	UBG U243 UK5/81T	L243
YE2WAG5	#2 Sol. (.258)	—				Orange				
YE2R25	1, 2 Str.	2	2 Sol.	4-5/8	2-1/2	Red	K-5/8-1, 243, BG, 8A	BG WBG W243	UBG U243 UK5/81T	L243
YE25R25	1/0 Str.	1/0				Yellow				
YE26R60	2/0 Str.	2/0	1/0 Sol.	9-1/2	6	Gray	249 840 11A	W249 or WK840	U249 UK840T	L249
YE27R60	3/0 Str.	3/0				Black				
YE28R60	4/0 Str.	4/0				Pink				
YE30R60	300	266.8 (26/7) (18/1)	4/0 Sol.	10-5/8	6	Blue	317, 705, K-1-1/8-1	—	U317 U705 UK1181T	L317
YE32R60	350-400	336.4 (26/7) (18/1)				Green				
YE361R60	477, 500	477 (18/1)	9/16	11-7/8	6	Pink	608	—	U608	L608
YE39R60	600	556.5 (24/7) (26/7)	5/8			Yellow				

BURNDY® furnishes many special versions of YE-R including: pin length variations, factory applied pin angles, etc.

Contact your BURNDY® representative for your special needs.

* All crimps overlap

†U Die with adapter PT6515.

‡U Die with adapter PUADP1.

For faster installations use BURNDY® PATRIOT® family of battery tools.

Table of Contents

Compression Splices	H-45
Service Entrance	
Type ES.....	H-46
Type YSU.....	H-47
Type YSD.....	H-48
Neutral	
Types YSS, YCS-R, YDS-AT.....	H-49
Jumper	
Types YCS, YDS.....	H-50
Type YCU-A.....	H-50
Type YCS-R.....	H-51
Type YCS-RL.....	H-52
Type YCS-A.....	H-53
Type YCR.....	H-53
Type YCR-R-G.....	H-54
Repair Sleeve	
Types YCU-R, YOU-R.....	H-55
Type YCU-R for ACSR Static Wire.....	H-55
Types YDS-W, YDS.....	H-56
Full Tension	
Types YDS, YDS-C.....	H-57
Types YDS-A, YDS-AT.....	H-58
Types YDS-RL, YDS-LT.....	H-59
Type YDS-RLNI.....	H-61
Types YDS-A, YDS-AT.....	H-62
Type YDS-RLY.....	H-63
Types YDS-R SET, YDS-RP1, YDS-RP2.....	H-64
Types YDS-R, YDS-RE.....	H-66
Types YDS-E, YDS-H, YDS-U.....	H-66
Type YDSR-RL.....	H-67
Type YDR-R.....	H-68
Type YDS-K.....	H-69
Type YTS-E.....	H-69
Types YDS-KT, YDS-F.....	H-70
Type YDS-M-T.....	H-70

Compression Splices General Overview

The BURNDY line of service, full-tension, and jumper sleeves provide a dependable, economical, and easy-to-install method of splicing overhead transmission and distribution lines.

A major part of the Total BURNDY® Compression Program, they are available for copper, aluminum, ACSR, COPPERWELD, ALUMOWELD, Steel, 6201, 5005, ACSR/AW, AWA, and compressed forms for aluminum and ACSR. Each is clearly marked with the installation Die Index number and knurls are provided which show the installer the correct number of crimps and the spacing required. Connections made with BURNDY® INSULINK™ and HYSPLICE™ sleeves have a lower resistance than an equal length of conductor.

HYSPLICE™ sleeves are tapered or chamfered at the ends; externally to provide gradual reduction of pressure on the conductor, and internally to facilitate conductor insertion.

Service Sleeve Design

Service entrance connectors are available insulated (INSULINK™) or uninsulated (LINKIT™). Both are installed with the one-hand OH25 and OUR840 HYTOOL™ or the MD6 HYTOOL™. The INSULINK™ features polyethylene caps which seal out dirt and moisture, and grip the cable insulation leaving both hands free for crimping. The aluminum insert is anchored to the nylon jacket so that it will not move when crimped, ensuring that the insert is always under the die. The jacket is color coded for easy identification of conductor size.

The aluminum LINKIT™ minimizes the effects of galvanic corrosion. It is designed for easy location of crimps, and is color coded.

The service HYSPLICE™ connectors are partial-tension sleeves for splicing the neutral conductor of triplex service. They are installed with MD6, OUR840 and the OH25 HYTOOL™ on aluminum and ACSR conductors from #6 to 1/0.

Copper HYSPLICE™ Sleeve Design

Full-tension holding strength and high conductivity of BURNDY® copper HYSPLICE™ sleeves are accomplished through the combined action of correct contact length, proper number of circular crimps of precisely controlled depth that perform a current carrying and keying function between the conductor and the sleeve.

Aluminum HYSPLICE™ Sleeve Design

HYSPLICE™ sleeves for aluminum conductor not only satisfy the basic tension requirements, but also deal with the problems of "cold flow" of aluminum and the oxide film which forms on the strands. "Cold flow" is compensated for by carefully coordinating the design of the sleeve and its associated installation die. To offset the effects of the non-conductive oxide film present on the surfaces of aluminum cable. BURNDY® HYSPLICE™ sleeves are pre-filled with PENETROX™ joint compound and capped or stripealed. A solid center barrier forces the PENETROX™ around the cable strands during insertion.

ACSR HYSPLICE™ Sleeve Design

Two-Piece, Full-tension HYSPLICE™

Two-piece, full-tension HYSPLICE™ for ACSR consists of an inner steel sleeve for joining the steel core, and an outer aluminum sleeve for connecting the aluminum strands. To install the two-piece HYSPLICE™, the cable is cut, the aluminum sleeve slid onto the cable, aluminum strands cut back and the steel sleeve installed. The aluminum sleeve is then centered over the steel sleeve, PENETROX™ joint compound injected (PENETROX™ is brushed on cable prior to centering aluminum sleeve on smaller sizes), and the sleeve is crimped.

Single-sleeve, Full-tension UNISPLICE™

The UNISPLICE™ is as easy to install as aluminum full-tension sleeves. The single, heavy walled aluminum sleeve is filled with a special inhibiting compound containing grit particles which key the steel strand in place. The UNISPLICE™ eliminates cutting back of aluminum strands, the need for a separate steel sleeve, and careful position of the aluminum outer sleeve before crimping.

Since the standard pull-out tests are inadequate for evaluating UNISPLICE™ performance, BURNDY® has developed the sustained-tension test that subjects a connector-conductor assembly to a 168 hour sustained load equal to 90% of the conductor strength. This test simulates a service life of 30-40 years at 60% of the conductor strength.

Jumper Sleeves

Since the holding strength required for jumper sleeves is less than that required for full-tension sleeves, the jumper HYSPLICE™ sleeve is shorter. Aluminum, ACSR, sleeves are pre-filled with PENETROX™ joint compound and installed with the same tools and dies as the full-tension sleeves.

INSULINK™ Service Entrance Splices, Type ES

For AAC (Stranded, Compressed, Compact**), Copper, ACSR, AAAC

Material: Aluminum (Insulated)

Pre-insulated service entrance compression connector installed with OH25, OUR840, and MD6 HYTOOL™ as well as the 35 and 750 HYPRESS™ tools. Polyethylene caps prevent dirt from accumulating in barrel, grip cable for easy two-hand installation, and seal out moisture. Aluminum connector is anchored to jacket, assuring the connector is under the die when crimping. Nylon jacket insulated connectors electrically and protects against water and weather. Superior color coding. Prefilled with PENETROX™ joint compound and stripsealed to limit oxidation and to increase the life of the connection. Do not use insulated sealed connectors on bare conductors, refer to LINKIT™ connectors.



RUS Accepted

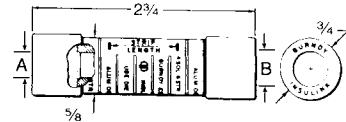

- Not for use on bare conductors.
- ▲ Accommodates 1/0 stranded aluminum and copper, concentric, compressed and compact conductors.
- ** Accommodates compact conductors where stated in the table.
- * For faster installations use BURNDY® PATRIOT® family of battery tools.

Catalog Number	Side A ■			Side B ■			Die Index	Installation Tooling* (# of Crimps per End)			
	ACSR, 6201, 5005	Aluminum & Copper	Color Code	ACSR, 6201, 5005	Aluminum & Copper	Color Code		Dieless OH25	MD6/MD7 Series	OUR840	35, 750 Series
ES8W8W	—	10 Str. 8 Sol.	Brown	—	10 Str. 8 Sol.	Brown	BG or 5/8	(1)	WBG (1)*	XNBG (1)*	UBG (1)*
ES6W8W		8 Str. 6 Sol. #8 AL Compt	Green	—	8 Str. 6 Sol. #8 AL Compt	Green					
ES6W6W				—	10 Str. 8 Sol.	Brown					
ES4W8W	6	5, 6 Str. 4 Sol.	Blue	—	8 Str. 6 Sol. #8 AL Compt	Green					
ES4W6W				6	5, 6 Str. 4 Sol.	Blue					
ES4W4W				—	10 Str. 8 Sol.	Brown					
ES2W8W	4	3, 4 Str. 2 Sol.	Orange	—	8 Str. 6 Sol. #8 AL Compt	Green					
ES2W6W				6	5, 6 Str. 4 Sol.	Blue					
ES2W4W				4	3, 4 Str. 2 Sol.	Orange					
ES2W2W				—	10 Str. 8 Sol.	Brown					
ES2R8W	2	1 Str. 2 Str. #1 AL Compt #2 AL Compt	Red	—	8 Str. 6 Sol. #8 AL Compt	Green					
ES2R6W				6	5, 6 Str. 4 Sol.	Blue					
ES2R4W				4	3, 4 Str. 2 Sol.	Orange					
ES2R2W				2	1 Str. 2 Str. #1 AL Compt #2 AL Compt	Red					
ES2R2R				—	8 Str. 6 Sol. #8 AL Compt	Green					
ES25R6W	1/0, 1	1/0 Str. 1-19 Str.	Yellow	6	5, 6 Str. 4 Sol.	Blue					
ES25R4W				4	3, 4 Str. 2 Sol.	Orange					
ES25R2W				2	2 Str. 1 Str. #1 AL Compt #2 AL Compt	Red					
ES25R2R				1/0, 1	1/0 Str.	Yellow					
ES25A25A	—	1/0 Str. ▲	Yellow	—	—	—					
ES25A4W	6			5, 6 Str. 4 Sol.	Blue						
ES25A2W	4			3, 4 Str. 2 Sol.	Orange						

5/8" LINKIT™ Service Entrance Splices, Type YSU

For AAC (Stranded, Compressed, Compact**), Copper, ACSR, AAAC

Material: Aluminum (Uninsulated)

Heavy-walled aluminum tubing with solid barrier minimizes galvanic corrosion of conductors. Accommodates neutral strands of Type SE Service Entrance conductor as well as other conductors. Installed with standard tooling. Color coded, prefilled with PENETROX™ joint compound and stripsealed to limit oxidation and increase the life of the connection.



RUS Accepted

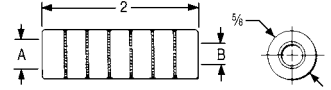

▲ Accommodates 1/0 standard aluminum and copper concentric, compressed and compact conductors.

** Accommodates compact conductors where stated in the table.

* For faster installations use BURNDY® PATRIOT® family of battery tools.

Catalog Number	Side A			Side B			Die Index	Installation Tooling* (# of Crimps per End)			
	ACSR, 6201, 5005	Aluminum & Copper	Color Code	ACSR, 6201, 5005	Aluminum & Copper	Color Code		Dieless OH25	MD6/MD7 Series	OUR840	35, 750 Series
YSU6W6W	—	8 Str. 6 Sol. #8 Al Compt	Green	—	8 Str. 6 Sol. #8 Al Compt	Green	243 BG or 5/8	(1)	WBG (1)*	XNBG (1)*	UBG (1)*
YSU4W8W	6	5, 6 Str. 4 Sol. #4 Al Compt	Blue	—	8 Sol. 10 Str.	Brown					
YSU4W6W				—	6 Sol. 8 Str. #8 Al Compt	Green					
YSU4W4W				6	5, 6 Str. 4 Sol. #4 Al Compt	Blue					
YSU2W8W				4	3, 4 Str. 2 Sol.	Orange					
YSU2W6W	—	6 Sol. 8 Str. #8 Al Compt	Green								
YSU2W4W	6	5, 6 Str. 4 Sol. #4 Al Compt	Blue								
YSU2W2W	4	3, 4 Str. 2 Sol.	Orange								
YSU2R8W	2	2 Str. 1 Str. #1 Al Compt #2 Al Compt	Red	—	8 Sol. 10 Str.	Brown					
YSU2R6W				—	6 Sol. 8 Str. #8 Al Compt	Green					
YSU2R4W				6	5, 6 Str. 4 Sol. #4 Al Compt	Blue					
YSU2R2W				4	3, 4 Str. 2 Sol.	Orange					
YSU2R2R				2	2 Str. 1 Str. #1 Al Compt #2 Al Compt	Red					
YSU25R6W	1/0	1/0 Str. 2/0 Al Compt 1/0 Al Compt	Yellow	—	8 Str. 6 Sol. #8 Al Compt	Green					
YSU25R4W				6	5, 6 Str. 4 Sol. #4 Al Compt	Blue					
YSU25R2W				4	3, 4 Str. 2 Sol.	Orange					
YSU25R2R				2	2 Str. 1 Str. #1 Al Compt #2 Al Compt	Red					
YSU25R25R				1/0	1/0 Str. 2/0 Al Compt 1/0 Al Compt	Yellow					
YSU25A25A	1-1	1/0 Str. ▲	Yellow	1/0	1/0 Str.	Yellow					

.840 LINKIT™ Service Entrance Splices, Type YSD

For AAC (Stranded, Compressed, Compact**), Copper, ACSR, AAAC

Material: Aluminum (Uninsulated)

Aluminum compression sleeve with solid center barrier. Designed for commercial and heavy residential services. Installed with standard tooling. Prefilled with PENETROX™ joint compound, capped and stripsealed to limit oxidation and to increase the life of the connection.

* Multiple crimp die set, makes more than one crimp per tool compression.

Figure indicates number of compressions.

** Accommodates compact conductors where stated in the table.

*** For faster installations use BURNDY® PATRIOT® family of battery tools.



RUS Accepted

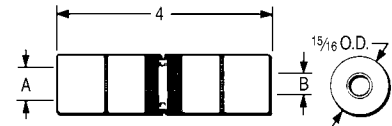

Catalog Number	Side A			Side B			Die Index	Installation Tooling *** (Number of Crimps per End)		
	ACSR, 6201, 5005	Aluminum & Copper	Color Code	ACSR, 6201, 5005	Aluminum & Copper	Color Code		MD6/MD7 Series	OUR840	35, 750* Series
YSD25R25R	1/0	1/0 Str. 2/0 AL Compt	Yellow	1/0	1/0 2/0 ALCompt	Yellow	249 K840	WK840 (7) W249 (4)	X840 (7) X249 (8)	UK840 (4) U249 (2)
YSD26R2W	2/0	2/0 Str. 3/0 AL Compt	Gray	4	3, 4 Str. 2 Sol. #2 AL Compt	Orange				
YSD26R2R				2	2 Str. 1 Sol. 1/0 AL Compt	Red				
YSD26R25R				1/0	1/0 Str. 2/0 AL Compt	Yellow				
YSD26R26R				2/0	2/0 Str. 3/0 AL Compt	Gray				
YSD27R2W				3/0	3/0 Str. 4/0 AL Compt	Black				
YSD27R2R	2	2 Str. 1 Sol. 1/0 AL Compt	Red							
YSD27R25R	1/0	1/0 2/0 ALCompt	Yellow							
YSD27R26R	2/0	2/0 Str. 3/0 AL Compt	Gray							
YSD27R27R	3/0	3/0 Str. 4/0 AL Compt	Black							
YSD28R2W	4/0	4/0 Str. 300 AL Compt	Pink	4	3, 4 Str. 2 Sol. #2 AL Compt	Orange				
YSD28R2R				2	2 Str. 1 Sol. 1/0 AL Compt	Red				
YSD28R25R				1/0	1/0 2/0 ALCompt	Yellow				
YSD28R26R				2/0	2/0 Str. 3/0 AL Compt	Gray				
YSD28R27R				3/0	3/0 Str. 4/0 AL Compt	Black				
YSD28R28R				4/0	4/0 Str. 300 AL Compt	Pink				

HYSPLICE™ Service Entrance, Short Span Lines (Neutrals), Types YSS, YCS-R, YDS-AT

For AAC (Stranded, Compressed, Compact**), Copper, ACSR, AAAC

Material: Aluminum

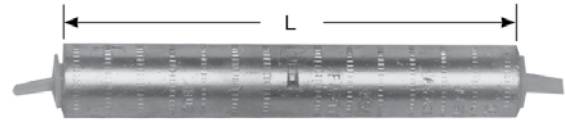

Single aluminum sleeve designed for service drop or short span overhead distribution lines. Installed with OH25 hand tool and other standard tooling. Prefilled with PENETROX™ joint compound and stripsealed to limit oxidation and increase the life of the connection.

Catalog Number	Conductor	L	Die Index	Color Code	Tool Series, Die Set Catalog Number*** & (Crimps per End)		OH25 Applications	
					MD7, MD6	35, 750, Y45†, 46‡	Conductor	OH25 (Indents per End)
YSS6RG2	6 ACSR 4 Sol. Al	4.00	BG	Blue	BG (6) WBG (3)*	UBG (3)*	—	—
YSS6R	6 ACSR 4 Sol. Al	4.72	162	Blue	W162 (4)	U162 (2)*	—	—
YDS4WA	4 Sol. Al	2-5/8	162	Orange	W162 (4)	U162 (1)*	—	—
YDS4CA	4 Str. Al (7)							
YSS4R	4 ACSR 2 Sol. Al 4 Al (7)	3.78	BG or 5/8	Orange	BG (6) WBG (3)*	UBG (3)*	4 7 Al (3) 4 5005 Al (2) 4 5005 Al (3) 4 (6-1) ACSR (3) 4 (6-1) ACSR (2) 4 (7-1) ACSR (3) 4 (7-1) ACSR (2) 2 Sol. Al (3) 2 Sol. Al (2)	
YSS2R	2 ACSR 2 Al (7)	3.78	BG or 5/8	Red	BG (6) WBG (3)*	UBG (3)*	2 (6-1) ACSR (3) 2 (7-1) ACSR (3) 2 (7-1) ACSR (2) 2 7 Al (3)	
YDS25AT	1/0 (7)	7-1/4	243	Yellow	W243(6)	U243(3)	1/0 7 Al	(4)
YCS25R	1/0 ACSR	7.09	243	Yellow	BG (12) WBG (6)*	UBG (6)*	1/0 (6-1) ACSR 1/0 (6-1) ACSR	(2) (3)

* Multiple crimp die set; makes more than one crimp per tool compression. Figure indicates number of compressions.

** Accommodates compact conductors where stated in the table.

† U Die with adapter PT6515

‡ U Die with adapter PUADP1.

*** For faster installations use BURNDY® PATRIOT® family of battery tools.

HYSPLICE™ Single Sleeve Jumpers, Types YCS, YDS

For Copper

Material: Copper

Tension Rating: ANSI C119.4 Class 1A
(Normal Tension)

Loop HYSPLICE™ connector designed to withstand jumper loop tensile and vibration stresses up to 60% RBS. Made of pure copper tubing, installed with standard tools and dies.

RUS Accepted.

* Multiple crimp die set; makes more than one crimp per tool compression. Figure indicates number of compressions.

† UDie with adapter PT6515.

‡ U Die with adapter PUADP1.

For faster installations use BURNDY® PATRIOT® family of battery tools.



Catalog Number	Conductor	L	Die Index	Tool Series, Die Set Catalog Number, & (Crimps per End)		
				MD7, MD6	35, 750, Y45†, 46‡	60
YDS8W	8 Sol.	1-5/8	171	W171 (1)	U171 (1)*	—
YDS6W	6 Sol.	2-5/8	161	W161 (2)	U161 (1)*	—
YDS4W	4 Sol.	2-1/2	162	W162 (4)	U162 (1)*	—
YDS2W	2 Sol.	3-3/4	163	W163 (6)	U163 (2)*	—
YDS6C	6 (7)	2-3/4	161	W161 (2)	U161 (1)*	—
YDS4C	4 (7)	2-5/8	162	W162 (4)	U162 (1)*	—
YDS2C	2 (7), 3 (3)	3-5/8	163	W163 (6)	U163 (2)*	—
YDS1C	1 (7, 19)	3-1/8	164	W164 (6)	U164 (3)*	—
YCS25	1/0 (7, 19)	3-3/8	165	W165 (3)	U165 (3)	—
YCS26	2/0 (7, 11, 12, 19)	3-3/8	166	W166 (6)	U166 (3)	—
YCS27	3/0 (7, 19)	3-1/4	167	—	U167 (3)	—
YCS28	4/0 (7, 12, 19)	3-1/8	168	—	U168 (3)	L168 (1)
YCS29	250 (7, 37, 19)	3-5/8	169	—	U169 (4)	L169 (2)
YCS30	300 (19, 37)	5-3/8	170	—	U170 (4)	L170 (1)
YCS31	350 (12, 19, 37)	5-3/8	267	—	U267 (6)	L267 (2)
YCS32	400 (19, 37)	5-3/4	209	—	U209 (6)	L209 (2)
YCS34	500 (19, 37)	5-1/8	210	—	U210 (6)	L210 (2)
YCS39	750 (37)	6-7/8	627	—	—	L627 (3)
YCS44	1000 (61, 37)	7-3/4	345	—	—	L345 (4)

Repair Sleeve, Type YCU-A

For AAC (Stranded, Compressed, Compact)

Material: Aluminum



For restoring conductivity to damaged conductors. Made of cast aluminum. Use same die as equivalent full-tension sleeve. Use of PENETROX™ joint compound required.

Catalog Number	Conductor	L	Die Index	Tool Series, Die Set Catalog Number, & (Number of Crimps)				
				MD7, MD6	35, 750	Y45	46	60
YCU2CA	2 (7)	7-5/8	163	W163 (27)	U163 (9)*	†	‡	—
YCU25A	1/0 (7)	8-3/4	243	W243 (20)	U243 (10)	†	‡	—
YCU28A	4/0 (7, 19)	11-7/8	249	W249 (28)	U249 (14)	†	‡	L249 (7)
YCU291A	266.8 (7)	11-5/8	251	—	U251 (20)	†	‡	L251 (10)
YCU301A	336.4 (19,37)	11-5/8	321	—	U321 (20)	†	‡	L231 (10)

* Multiple crimp die set; makes more than one crimp per tool compression. Figure indicates number of compressions.

† UDie with adapter PT6515.

‡ U Die with adapter PUADP1.

For faster installations use BURNDY® PATRIOT® family of battery tools.

HYSPLICE™ Single Sleeve Jumper, Type YCS-R

For AAC (Stranded, Compressed), ACSR, AAAC

Material: Aluminum

Tension Rating: ANSI C119.4 Class 2
 (Partial Tension)

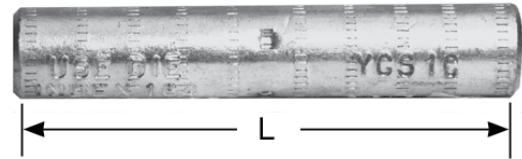

RUS Accepted

HYSPLICE™ sleeve designed to withstand jumper loop tensile and vibration stresses. Made of aluminum with staked-in cable stop. Installed with same die as equivalent full tension sleeves. Prefilled with PENETROX™ joint compound, stripsealed and capped to limit oxide growth and increase the life of the connection.

Catalog Number	Conductor		L	Die Index	Tool Series, Die Set Catalog Number, & (Crimps per End)				
	ACSR, 6201, 5005	All Aluminum			MD7, MD6	35, 750	Y45	46	60
YCS4R	4	4 (7)	5	237	W237 (4)	U237 (2)	†	‡	—
YCS2R	2	2 (7)	5	239	W239 (4)	U239 (2)	†	‡	—
YCS25R	1/0	1/0 (7, 19)	7-1/8	243	WBG (5) W243 (7)	UBG (6)* U243 (4)	†	‡	—
YCS26R	2/0	2/0 (7, 19)	7	245	W245 (8)	U245 (4)	†	‡	—
YCS27R	3/0 110.8 (12-7)	3/0 (7, 19)	5-3/4	247	W247 (6)	U247 (3)	†	‡	—
YCS28R	4/0	4/0 (7, 19)	5-3/4	249	W249 (6)	U249 (3)	†	‡	L249 (2)
YCS30R	266.8 (6/7, 18-1, 26/7)	266.8	6-1/2	251	W251 (12)	U251 (6)	†	‡	L251 (3)
YCS321R	336.4 (18-1) 300	336.4 (19)	6-1/2	490	—	U490 (5)	†	‡	L490 (2)
YCS33R	336.4 (26-7, 30-7)	397.5 (19)	8-3/4	316	—	U316 (6)	†	‡	L316 (2)
YCS35R	397.5 (18-1, 26-7, 30-7)	477 (19, 37) 500 (37, 61)	8-7/8	317	—	U317 (6)	†	‡	L317 (2)
YCS361R	477 (18-1)	500 (37, 61)	8-1/4	327	—	U327 (6)	†	‡	L327 (2)
YCS37R	477 (24-7, 26-7, 30-7) 556.5 (18-1)	556.5 (19, 37)	8-3/4	261	—	U261 (6)	†	‡	L261 (2)
YCS39R	556.5 (24-7, 26-7)	—	10-3/4	608	—	U608 (9)	†	‡	L608 (3)
YCS43R	605 (30-19) 636 (24-7, 26-7, 30-19) 666.6 (24-7, 54-7)	795 (37)	10-5/8	292 or 319	—	—	S292 (6) S319 (6)	P292 (6) P319 (6)	L292 (3) L319 (3)
YCS453R	795 (36-1, 45-7)	—	10-5/8	292	—	—	S292 (6)	P292 (6)	L292 (3)
YCS45R	795 (26-7, 54-7)	900 (61, 91)	10-5/8	352	—	—	S352 (6)	P352 (6)	L352 (3)

† U Die with adapter PT6515

‡ U Die with adapter PUADP1.

For faster installations use BURNDY® PATRIOT® family of battery tools.

UNISPLICE™ Single Sleeve Jumper, Type YCS-RL

For AAC (Stranded, Compressed, Compact), ACSR, AAAC

Material: Aluminum

Tension Rating: ANSI C119.4 Class 2
(Partial Tension)

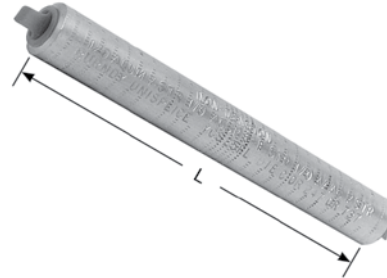

Aluminum jumper sleeve, with cable stop, designed to be installed with same dies as equivalent full-tension UNISPLICE™. Withstands jumper loop-tensile and vibration stresses. Prefilled with PENETROX™ joint compound, stripsealed and capped to limit oxide growth and increase the life of the connection.

Catalog Number	Conductor †††	L	Die Index	Tool Series, Die Set Catalog Number, & (Crimps per End)	
				MD7, MD6	35,Y750, Y45†, 46‡
YCS25RL	1/0 ACSR (6-1) 1/0 6201 (7) 1/0 5005 (7) 1/0 AAC (7)	6-1/4	C or 247 or 702	WC (12) W702 (6)*	U247 (3)
YCS26RL	2/0 ACSR (6-1) 2/0 6201 (7) 2/0 5005 (7) 2/0 AAC (7)	5-5/8	659	—	U659 (3)
YCS28RL	4/0 ACSR (6-1) 4/0 6201 (7) 4/0 5005 (7) 4/0 AAC (7)	5-1/4	654	—	U654 (3)
YCS321RL	336.4 ACSR (18-1) 336.4 AAC (19)	5-1/4	655	—	U655 (3)
YCS341RL	397.5 AAC (19) 397.5 ACSR (18-1) 400 AAC (37, 61) 336.4 ACSR (18-1) 336.4 ACSR (26-7) 336.4 ACSR (30-7)	5-5/8	327	—	U327 (4)

* MD6 NON-BOW Dies produce straight sleeves without rotating tool.

† U Die with adapter PT6515

‡ U Die with adapter PUADP1.

††† Accommodates ACSR with aluminized steel core.

For faster installations use BURNDY® PATRIOT® family of battery tools.

HYSPLICE™ Jumper Loop, Type YCS-A

For AAC (Stranded, Compressed, Compact)

Material: Aluminum

Tension Rating: ANSI C119.4 Class 1A
 (Normal Tension)



HYSPLICE™ sleeve designed to withstand jumper loop tensile and vibration stresses up to 60% RBS. Made of aluminum with staked-in cable stop. Installed with same die as equivalent full-tension sleeve. Made from electrolytic grade aluminum. Surface oxides removed at factory and sealed. Pre-filled with PENETROX™ A joint compound, stripsealed and capped to limit oxide growth and to increase life of connection. For ACSR splices use the YCS-R or YCS-RL.

† U Die with adapter PT-6515
 ‡ U Die with adapter PUADP-1.
 For faster installations use BURNDY® PATRIOT® family of battery tools.

Catalog Number	Conductor	L	Die Index	Tool Series, Die Set Catalog Number, & (Crimps per End)				
				MD7, MD6	35, 750	Y45	46	60
YCS26A	2/0 (7)	5-1/8	245	W245 (4)	U245 (2)	†	‡	—
YCS28A	4/0 (7, 19)	4	249	W249 (4)	U249 (2)	†	‡	L249 (1)
YCS301A	336.4 (19, 37)	4-3/8	321	—	U321 (3)	†	‡	L321 (2)
YCS311A	397.5 (19)	5-5/8	468	—	U468 (4)	†	‡	—
YCS331A	477 (19, 37, 61) 500 (19, 37, 61)	6-1/4	317	—	U317 (4)	†	‡	L317 (2)
YCS351A	556.5 (19, 37)	8-3/4	261	—	U261 (6)	†	‡	L261 (2)
YCS361A	636 (37)	7-3/8	469	—	—	S469 (4)	P469 (4)	L469 (2)
YCS391A	795 (37, 61)	10-1/2	342	—	—	S342 (4)	P342 (6)	L342 (3)

Jumper Sleeve Reducer, Type YCR

For Copper

Material: Copper

Tension Rating: ANSI C119.4 Class 1A
 (Normal Tension)

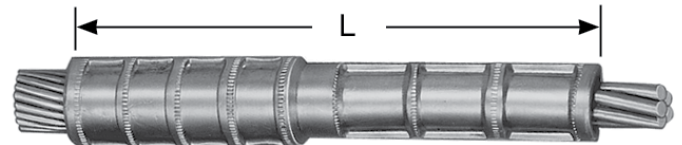

Copper sleeve designed to join different size copper conductors on transmission jumper applications. Installed with same dies as full-tension sleeves.

* Multiple crimp die set; makes more than one crimp per tool compression. Figure indicates number of compressions.
 † U Die with adapter PT6515.
 ‡ U Die with adapter PUADP1.
 For faster installations use BURNDY® PATRIOT® family of battery tools.

Catalog Number	Copper Conductor		L	Tool Series, Die Set Catalog Number, & (Crimps per End)							
				Side A				Side B			
	Side A	Side B		Die Index	MD7, MD6	35, 750, Y45†, 46‡	60	Die Index	MD6	35, 750, Y45†, 46‡	60
YCR2625	2/0 (7, 12, 19)	1/0 (7, 19)	3-3/8	166	W166 (6)	U166/U459	L166 (1)	165	W165 (3)	U165/U205	L165 (1)
YCR2725	3/0 (7, 19)	1/0 (7, 19)	3-1/2	167	—	U167/U568	L167 (1)	165	W165 (3)	U165/U205	L165 (1)
YCR2825	4/0 (7, 12, 19)	1/0 (7, 19)	3-3/8	168	—	U168 (3)	L168 (1)	165	W165 (3)	U165/U205	L165 (1)

HYSPLICE™ Single Sleeve Reducer Jumper, Type YCR-R-G

For AAC (Stranded, Compressed), ACSR, AAAC, Copper

Material: Aluminum

Tension Rating: ANSI C119.4 Class 2
(Partial Tension)

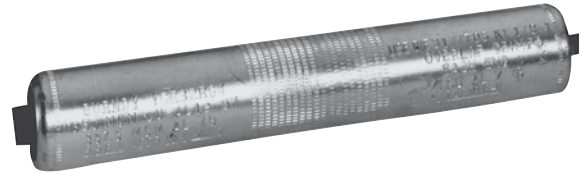

Heavy-walled aluminum sleeve designed to connect all aluminum or ACSR to copper conductors, in all service conditions encountered in transmission and distribution. Sleeve has solid center barrier and is prefilled with PENETROX™ joint compound, stripealed and capped to limit oxide growth and increase life of connection.

* Crimps overlap on both ends.
† U Die with adapter PT6515
‡ U Die with adapter PUADP1
For faster installations use BURNDY® PATRIOT® family of battery tools.

Catalog Number	Side A		Side B		L	O.D.	Tool Series, Die Set Catalog Number, & (Crimps per End)							
	ACSR, 6201, 5005	Aluminum, Copper	ACSR, 6201, 5005	Aluminum, Copper			Die Index	35, 750, Y45 †, 46 ‡	60					
YCR25RG6	1/0 (6-1)	1/0 (7, 12, 19)	1/0 (6-1)	1/0 (7, 12, 19)	6-3/8	1-1/16	654 or 705	U654 U705 Crimps Overlap	L654 Crimps Overlap					
YCR26RG2	2/0 (6-1)	2/0 (7, 12, 19)	1/0 (6-1)	1/0 (7, 12, 19)										
YCR26RG3			2/0 (6-1)	2/0 (7, 12, 19)										
YCR27RG5	3/0 (6-1)	3/0 (7, 12, 19)	1/0 (6-1)	1/0 (7, 12, 19)										
YCR27RG6			2/0 (6-1)	2/0 (7, 12, 19)										
YCR28RG5	4/0 (6-1)	4/0 (7, 12, 19)	1/0 (6-1)	1/0 (7, 12, 19)										
YCR28RG6			2/0 (6-1)	2/0 (7, 12, 19)										
YCR28RG7			3/0 (6-1)	3/0 (7, 12, 19)										
YCR28RG8			4/0 (6-1)	4/0 (7, 12, 19)										
YCR291RG2	266.8 (18-1)	250 (19, 37) 266.8 (7, 12, 19)	2/0 (6-1)	2/0 (7, 12, 19)						7-3/8	1-1/4	317 or 705	U317 U705 Crimps Overlap	L317 Crimps Overlap
YCR291RG3			3/0 (6-1)	3/0 (7, 12, 19)										
YCR291RG4			4/0 (6-1)	4/0 (7, 12, 19)										
YCR291RG5			266.8 (18-1)	250 (19, 37) 266.8 (7, 12, 19)										
YCR30RG4	266.8 (26-7)	300 (19, 37) 366.4 (19)	1/0 (6-1)	1/0 (7, 12, 19)										
YCR30RG6			3/0 (6-1)	3/0 (7, 12, 19)										
YCR30RG7			4/0 (6-1)	4/0 (7, 12, 19)										
YCR32RG1	336.4 (18-1) (26-7)	350 (19, 37) 397.5 (19)	1/0 (6-1)	1/0 (7, 12, 19)	6-5/8									
YCR32RG2			2/0 (6-1)	2/0 (7, 12, 19)										
YCR32RG3			3/0 (6-1)	3/0 (7, 12, 19)										
YCR32RG4			4/0 (6-1)	4/0 (7, 12, 19)										
YCR32RG5			266.8 (18-1)	250 (19, 37) 266.8 (7, 12, 19)										
YCR32RG6			266.8 (26-7)	300 (19, 37) 366.4 (19)										
YCR32RG7			336.4 (18-1) (26-7)	350 (19, 37) 397.5 (19)										

Compression Repair Sleeve, Types YCU-R, YOU-R
For ACSR (Stranded, Compressed, Compact)

Material: Aluminum

For restoring conductivity to damaged conductors. Made of cast aluminum. Sizes up through 266.8 are U-shaped. For 300 and larger, sleeves are two-piece interlocking elements. Use same dies as equivalent full-tension sleeve. Use of PENETROX™ joint compound required.

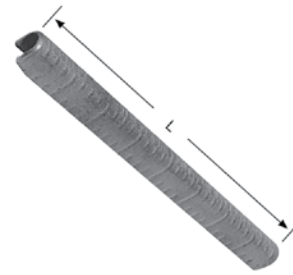

Catalog Number	Conductor	L	Die Index	Tool Series, Die Set Catalog Number & (Number of Crimps)				
				MD7, MD6	35, 750	Y45	Y46	60
YCU4R	4 (6-1), (7-1) 4AAC	6-1/4	237	W237 (12)	U237 (6)	†	‡	—
YCU4RG1	4 (7-1)	8-1/4	239	W239 (16)	U239 (8)	†	‡	—
YCU2R	2 (6-1, 7-1)	8-1/4	239	W239 (16)	U239 (8)	†	‡	—
YCU25R	1/0 (6-1)	8-3/4	243	W243 (20)	U243 (10)	†	‡	—
YCU26R	2/0 (6-1)	10	245	W245 (24)	U245 (12)	†	‡	—
YCU27R	3/0 (6-1)	10	247	W247 (24)	U247 (12)	†	‡	—
YCU28R	4/0 (6-1)	11-7/8	249	W249 (28)	U249 (14)	†	‡	L249 (7)
YCU30R	266.8 (6-1, 18-1, 26-7)	11-5/8	251	—	U251 (20)	†	‡	L251 (10)
YOU32R	300 (26-7)	13	316	—	U316 (21)	†	‡	L316 (7)
YCU321R	336.4 (18-1)	11-5/8	547, 655, 490	—	U490 (20)	†	‡	L490 (10)
YOU33R	336.4 (26-7, 30-7)	13	316	—	U316 (21)	†	‡	L316 (7)
YOU35R	397.5 (18-1, 26-7, 30-7)	13	317, 426	—	U317 (21)	†	‡	L317 (7)
YOU361R	477 (18-1)	12-47/50	327	—	U327 (21)	†	‡	L327 (7)
YOU37R	477 (24-7, 26-7, 30-7)	12-47/50	261, 318	—	U261 (21)	†	‡	L261 (7)
YOU39R	556.5 (24-7, 26-7)	13-3/4	608	—	U608 (24)	†	‡	L608 (8)
YOU41R	605 (24-7, 54-7)	13-3/4	292, 578, 319	—	—	S292 (24)	P292 (24)	L292 (8)
YOU43R	605 (30-19) 636 (26-7, 30-19) 666.6 (24-7, 54-7)	13-3/4	292, 319, 578	—	—	S292 (24) S319 (24)	P292 (24) P319 (24)	L292 (8) L319 (8)
YOU421R	636 (36-1)	13-3/4	292, 578	—	—	S292 (24)	P292 (24)	L292 (8)
YOU453R	715.5 (26-7) 795 (36-1)	13-3/4	292, 578	—	—	S292 (24)	P292 (24)	L292 (8) L578 (8)
YOU44R	715.5 (54-7)	13-3/4	319	—	—	S319 (24)	P319 (24)	L319 (8)
YOU45R	795 (26-7, 54-7)	13-3/4	352, 579	—	—	S352 (24) S579 (24)	P352 (24) P579 (24)	L352 (8) L579 (8)
YOU48R	900 (54-7) 954 (54-7)	14-1/4	575	—	—	—	—	L575 (10)
YOU49R	1033.5 (54-7)	14-1/4	422	—	—	—	—	L422 (10)

† U Die with adapter PT6515.

‡ U Die with adapter PUADP1.

For faster installations use BURNDY® PATRIOT® family of battery tools.

HYSPLICE™ Repair Sleeve Type YCU-R
For ACSR “Static Wire”

Material: Aluminum with Staked-In Cable Stop

HYSPLICE™ sleeve designed to withstand jumper loop tensile and vibration stresses. Made of aluminum with staked-in cable stop. Installed with same die as equivalent full tension sleeves. Prefilled with PENETROX™ joint compound.

RUS Accepted

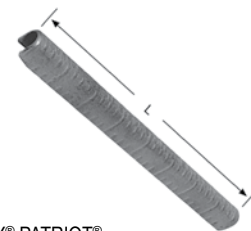

† U Die with adapter PT-6515.

‡ U Die with adapter PUADP-1.

For faster installations use BURNDY® PATRIOT® family of battery tools.

Catalog Number	Conductor	L	Die Index	Tool Series, Die Set Catalog Number & (Number of Crimps)		
				MD7, MD6	35, 750, Y45†, 46‡	60
YCU27R	110.8 (12-7)	10	247	W247 (24)	U247 (12)	—
YCU28R	159 (12-7)	11-7/8	249	W249 (28)	U249 (14)	L249 (7)
YCU30R	190.8 (12-7)	11-5/8	251	—	U251 (20)	L251 (10)

HYSPLICE™ Single Sleeve, Types YDS-W, YDS For Solid Copper

Material: Copper

Tension Rating: ANSI C119.4 Class 1
(Full Tension)

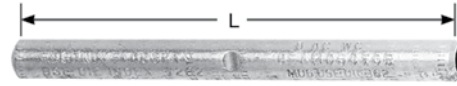

RUS Accepted

Type YDS-W sleeves are designed to develop full rated breaking strength of hard drawn and medium hard drawn solid copper conductor. Made of pure copper tubing, installed with standard tooling.

Catalog Number	Solid Conductor	L	Die Index	Tool Series, Die Set Catalog Number, & (Crimps per End)		
				MD7, MD6	35, 750, Y45†, 46‡	60
YDS8WG1	8 Sol.	1-7/8	161	W161 (1)	U161 (1)	—
YDS8W	8 Sol.	1-1/2	171	W171 (1)	U171 (1)*	—
YDS6W	6 Sol.	2-5/8	161	W161 (2)	U161 (1)*	—
YDS4W	4 Sol.	2-1/2	162	W162 (4)	U162 (1)*	—
YDS3W	3 Sol.	2-7/8	163, 308	W163 (4)	U163 (2)* U308 (2)*	—
YDS2W	2 Sol.	3-3/4	163	W163 (6)	U163 (2)*	—
YDS1W	1 Sol.	5-7/8	164	W164 (8)	U164 (4)*	—
YDS75	1/0 Sol.	6-1/4	165	W165 (6)	U165/U205 (6)	—
YDS76	2/0 Sol.	6-5/8	166	W166 (12)	U166/U459 (6)	—
YDS78	4/0 Sol.	7-7/8	168	—	U168 (9)	L168 (3)

* Multiple crimp die set; makes more than one crimp per tool compression.

Figure indicates number of compressions.

† U Die with adapter PT6515.

‡ U Die with adapter PUADP1.

For faster installations use BURNDY® PATRIOT® family of battery tools.

HYSPLICE™ Single Sleeve, Types YDS, YDS-C
 For Stranded Copper

Material: Copper

Tension Rating: ANSI C119.4 Class 1
 (Full Tension)



Made of pure copper tubing. Designed to develop the full rated breaking strength of hard drawn or medium hard drawn copper conductor. Installed with standard tooling.

Catalog Number	Stranded Conductor	L	Die Index	Tool Series, Die Set Catalog Number, & (Crimps per End)		
				MD7, MD6	35, 750, Y45†, 46‡	60
YDS6C	6 (7)	2-3/4	161	W161 (2)	U161 (1)*	—
YDS4C	4 (7)	2-5/8	162	W162 (4)	U162 (1)*	—
YDS3C3	3 (3)	5-1/4	163	W163 (9)	U163 (3)*	—
YDS2C	2 (7)	3-5/8	163	W163 (6)	U163 (2)*	—
YDS2C3	2 (3)	3-5/8	163	W163 (6)	U163 (2)*	—
YDS1C	1 (7, 19)	4-1/4	164	W164 (6)	U164 (3)*	—
YDS1C3	1 (3)	6-1/4	459	W166 (3)	U459 (6)	—
YDS25	1/0 (7, 19)	5-3/8	165	W165 (6)	U165 / U205 (6)	—
YDS26	2/0 (7, 12, 19)	6	166	W166 (12)	U166 / U459 (6)	—
YDS27	3/0 (7, 19)	6-3/4	167	—	U167 / U568 (7)	—
YDS28	4/0 (7, 12, 19)	6-7/8	168	—	U168 (9)	L168 (3)
YDS29	250 (7, 12, 37)	7-1/2	169	—	C169 (9)	L169 (3)
YDS30	300 (19, 37)	8-1/8	170	—	U170 (13)	L170 (3)
YDS31	350 (12, 19, 37)	10-1/4	267	—	U267 (12)	L267 (4)
YDS32	400 (19, 37)	12-3/4	209	—	U209 (15)	L209 (5)
YDS34	500 (19, 37)	11-5/8	210	—	U210 (15)	L210 (5)
YDS39	750 (37)	12-3/4	627	—	—	L627 (7)
YDS44	1000 (61, 37)	15-1/4	345	—	—	L345 (10)

* Multiple crimp die set; makes more than one crimp per tool compression.
 Figure indicates number of compressions.
 † U Die with adapter PT6515.
 ‡ U Die with adapter PUADP1.
 For faster installations use BURNDY® PATRIOT® family of battery tools.

HYSPLICE™ Single Sleeve, Types YDS-A, YDS-AT

For AAC (Stranded, Compressed, Compact)

Material: Aluminum

Tension Rating: ANSI C119.4 Class 1
(Full Tension)



Full Tension HYSPLICE™ sleeve made of aluminum tubing with staked-in cable stop. Sizes 1/0 and large tapered for gradual transition of stress. Installed with standard tools and dies. Prefilled with PENETROX™ joint compound, stripsealed, and capped to limit oxide growth and increase connection life.

Catalog Number	Conductor	L	Die Index	Tool Series, Die Set Catalog Number & (Number of Crimps)				
				MD7, MD6	35, 750	Y45	46	60
YDS6WA	6 (1)	3	161	W161 (2)	U161 (1)*	†	‡	—
YDS4WA	4 (1)	2-5/8	162	W162 (4)	U162 (1)*	†	‡	—
YDS2WA	2 (1)	3-7/8	163	W163 (6)	U163 (2)	†	‡	—
YDS6CA	6 (7)	3	161	W161 (2)	U161 (1)*	†	‡	—
YDS4CA	4 (7)	2-5/8	162	W162 (4)	U162 (1)*	†	‡	—
YDS2CA	2 (7)	3-7/8	163	W163 (6)	U163 (2)	†	‡	—
YDS25AT	1/0 (7)	7-1/4	BG 243	WBG (12) W243 (6)	UBG (6) U243 (3)	†	‡	—
YDS26AT	2/0 (7)	9-1/4	245	W245 (9)	U245 (5)	†	‡	—
YDS27AT	3/0 (7,19)	7-1/4	247	W247 (8)	U247 (4)	†	‡	L247 (3)
YDS28AT	4/0 (7, 19)	10-1/2	249	W249 (12)	U249 (6)	†	‡	L249 (3)
YDS29AT	250 (19)	7-1/2	616	—	U616 (6)	†	‡	—
YDS291AT	266.8 (7,19)	8-5/8	251	—	U251 (7)	†	‡	L251 (4)
YDS301AT	336.4 (19, 37)	9-7/8	321	—	U321 (8)	†	‡	L321 (4)
YDS31AT	350 (19)	11	490	—	U490 (9)	†	‡	L490 (3)
YDS311AT	397.5 (19)	12-1/4	468	—	U468 (10)	†	‡	—
YDS331AT	477 (19)	12-3/4	317	—	U317 (9)	†	‡	L317 (3)
YDS351AT	556.5 (19, 37)	12-3/4	261	—	U261 (9)	†	‡	L261 (3)
YDS361AT	636 (37)	13-1/2	469	—	—	S469 (8)	P469 (8)	L469 (4)
YDS391AT	795 (37), 800 (61)	13-5/8	342	—	—	S342 (8)	P342 (8)	L342 (4)
YDS431AT	954 (37, 61)	17-5/8	352	—	—	S352 (10)	P352 (10)	L352 (5)

* Multiple crimp die set; makes more than one crimp per tool compression.

Figure indicates number of compressions.

† U Die with adapter PT6515.

‡ U Die with adapter PUADP1.

For faster installations use BURNDY® PATRIOT® family of battery tools.

UNISPLICE™ Single Sleeve, Types YDS-RL, YDS-LT

For AAC (Stranded, Compressed), ACSR, AAAC

Material: Aluminum

Tension Rating: ANSI C119.4 Class 1
(Full Tension)

Single-sleeve aluminum UNISPLICE™ connector is designed to splice ACSR as simply as aluminum. Prefilled with PENETROX™ joint compound, stripsealed, and capped to limit oxide growth and increase the life of the connection. Eliminates strand stripping, installing separate steel sleeve and filling with joint compound. Ends ACSR joint failure due to faulty positioning of sleeve and lack of joint compound. Simplifies hot-line splicing. Electrical and mechanical performance equal to two-piece sleeves.

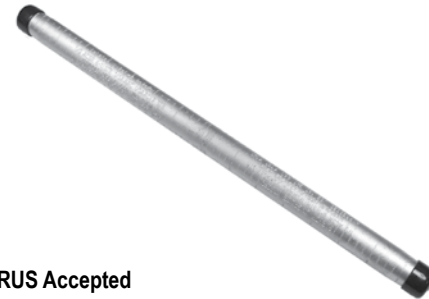

RUS Accepted

Catalog Number	Conductor †††	L	Die Index	Tool Series, Die Set Catalog Number, & (Crimps per End)			
				MD7, MD6	35, 750, Y45†, 46‡	60	644 and 444S Series
YDS4RL	4 ACSR (7-1) 4 ACSR (6-1) 4 6201 (7) 4 5005 (7) 4 AAC (7)	11-7/8	BG, or 243, or 687	BG (24) WBG (11)* W243 (9) W687 (11)**	UBG (9)* U243 (6)	L243 (3)	4
YDS2RL	2 ACSR (6-1) (7-1) 2 6201 (7) 2 5005 (7) 2 AAC (7)	10-1/4	BG, or 243, or 687	BG (20) WBG (10)* W243 (10) W687 (10)**	UBG (8)* U243 (5)	L243 (3)	4
YDS021RL	2 ACSR (7-1) 2 ACSR (6-1) 2 6201 (7) 2 AAC (7)	11-1/4	C, or 167, or 247, or 702	WC (30) W247 (14) W702 (11)**	U167/U568 (16) U247 (7)	L167 (7)	4
YDS25RL	1/0 ACSR (6-1) 1/0 6201 (7) 1/0 5005 (7) 1/0 AAC (7)	13-7/8	C, or 167, or 247, or 660, or 702	WC (30) W660 (14) W702 (12)**	U167/U568 (14) U660 (7) U247 (7)	L167 (5)	5
YDS26RL	2/0 ACSR (6-1) 2/0 6201 (7) 2/0 5005 (7) 2/0 AAC (7)	13-1/2	659	—	U659 (11) Crimps Overlap	—	5
YDS27RL	3/0 ACSR (6-1) 3/0 6201 (7) 3/0 5005 (7) 3/0 AAC (7)	18-1/4	658	—	U658 (16) Crimps Overlap	—	7
YDS28RL	4/0 ACSR (6-1) 4/0 6201 (7) 4/0 5005 (7) 4/0 AAC (7)	18-1/4	654	—	U654 (18) Crimps Overlap	—	7
YDS321RL	336.4 ACSR (18-1) 336.4 AAC (19) 350 AAC	18-1/4	655	—	U655 (21) Crimps Overlap	—	7

* Multiple crimp die set; makes more than one crimp per tool compression. Figure indicates number of compressions.

** MD6 NON-BOW Dies produce straight sleeves without rotating tool.

‡ U Die with adapter PUADP1.

† U Die with adapter PT6515.

†† Accommodates compact conductor.

††† Accommodates ACSR with aluminized steel core.

For faster installations use BURNDY® PATRIOT® family of battery tools.

UNISPLICE™ Single Sleeve, Types YDS-RL, YDS-LT

For AAC (Stranded, Compressed), ACSR, AAAC

(Continued)

Catalog Number	Conductor	Code	L	Die Index	Tools, Die Set Catalog Number, & (Crimps per End)		
					35, 750, Y45†, 46†	60	644 and 444S Series
YDS30LT	312.8 6201	BUTTE	—	317	U317	L317	—
YDS32LT	394.5 6201 394.5 5005 (336.4 E.C. Equiv.)	CANTON RADIANT	14-1/2	642	U642 (12)	L642 (4)	—
YDS341RL	397.5 ACSR (18-1) 419.6 5005	REDE	22	327	U327 (18)	—	9
YDS361RL	477 (18-1) 556.5 (18-1) 587.2 5005	RUBLE	23-1/4	720 788	U-788 (31) Crimps Overlap	L720 Crimps Overlap	9
YDS36LT	559.5 6201 559.5 5005 (477 E.C. Equiv.)	DARIEN REMEX	16	667	P667**	L667 Crimps Overlap	—

** 46 Series tools only.

For faster installations use BURNDY® PATRIOT® family of battery tools.

UNISPLICE™ Single Sleeve, Type YDS-RLNI

For AAC (Stranded, Compressed), ACSR, AAAC

Material: Aluminum

Tension Rating: ANSI C119.4 Class 1
(Full Tension)



RUS Accepted

Single-sleeve aluminum UNISPLICE™ connectors are designed to splice ACSR as simply as all aluminum. Prefilled with PENETROX™ joint compound, stripsealed, and capped to limited oxide growth and increase life of the connection. Eliminates strand stripping, installing separate steel sleeve and filling with joint compound. Ends ACSR joint failure due to faulty positioning of sleeve and lack of joint compound.

Simplifies hot-line splicing. Electrical and mechanical performance equal to two-piece sleeves. **The UNISPLICE™ Type YDS-RLNI connectors are to be installed with the 644 or 444S family of next and indentor tools only.**

Catalog Number	Conductor †††	L	Installation Tools / # of Crimps
			644 / 444S Series
YDS4RLNI	4 ACSR (7-1) 4 ACSR (6-1) 4 6201 (7) 4 5005 (7) 4 AAC (7)	10.2	4
YDS2RLNI	2 ACSR (6-1) (7-1) 2 6201 (7) 2 5005 (7) 2 AAC (7)	10.2	4
YDS021RLNI	2 ACSR (7-1) 2 ACSR (6-1) 2 6201 (7) 2 AAC (7)	10.2	4
YDS25RLNI	1/0 ACSR (6-1) 1/0 6201 (7) 1/0 5005 (7) 1/0 AAC (7)	12.4	5
YDS26RLNI	2/0 ACSR (6-1) 2/0 6201 (7) 2/0 5005 (7) 2/0 AAC (7)	12.4	5
YDS27RLNI	3/0 ACSR (6-1) 3/0 6201 (7) 3/0 5005 (7) 3/0 AAC (7)	17.4	7
YDS28RLNI	4/0 ACSR (6-1) 4/0 6201 (7) 4/0 5005 (7) 4/0 AAC (7)	17.4	7
YDS321RLNI	336.4 ACSR (18-1) 336.4 AAC (19) 350 AAC	17.5	7
YDS341RLNI	397.5 ACSR (18-1) 419.6 5005	22.0	9
YDS361RLNI	477 (18-1) 556.5 (18-1) 587.2 5005	23.3	9

†† Accommodates compact conductor.

††† Accommodates ACSR with aluminized steel core.

For faster installations use BURNDY® PATRIOT® family of battery tools.

HYSPLICE™ Single Sleeve, Types YDS-A, YDS-AT

For AAC (Stranded, Compressed, Compact);
 Installed with BURNDY or EEI Dies

Material: Aluminum

Tension Rating: ANSI C119.4 Class 1
 (Full Tension)



Full-tension HYSPLICE™ sleeve made of aluminum tubing with staked-in cable stop. Sizes 1/0 and larger are tapered for gradual transition of stress. Installed with standard BURNDY® tooling. Prefilled with PENETROX™ joint compound, stripsealed and capped, to limit oxide growth and increase the life of the connection.

Catalog Number	Conductor	L	EEI Die Index	Index	Tools, Die Set Catalog Number (Crimps per End)	
					MD7, MD6	35, 750, Y45†, 46‡
YDS2CA	2 (7)	3-7/8	6A	693	W693 (8)	U693 (2)
YDS25AT	1/0 (7)	7-1/4	8A	243	W243(6)	U243(3)
YDS27AT	3/0 (7,19)	7-1/4	10A	694	W694 (8)	U694 (4)
YDS28AT	4/0 (7, 19)	10-1/2	11A	249	W249 (12)	U249 (6)
YDS311AT	397.5 (19)	12-1/4	13A	655	—	U655 (10)
YDS331AT	477 (19)	12-3/4	14A	317	—	U317 (9)

† U Die with adapter PT6515.

‡ U Die with adapter PUADP1.

For faster installations use BURNDY® PATRIOT® family of battery tools.

UNISPLICE™ Single Sleeve, Type YDS-RLY
For AAC (Stranded, Compressed) , ACSR, AAAC

Material: Aluminum

Tension Rating: ANSI C119.4 Class 1
(Full Tension)

Similar to the single-sleeve aluminum UNISPLICE™ connectors Type YDS-RL in most ways, the Type YDS-RLY are specifically designed to eliminate possible conductor basketing (bird caging) on ACSR. Installed by crimping form end of connector towards center with standard installation tooling. Supplied prefilled with PENETROX™ joint compound, stripsealed, and capped to limit oxide growth and increase the life of the connection. Factory installed tape on pressure relief holes must be in place when conductors are inserted.

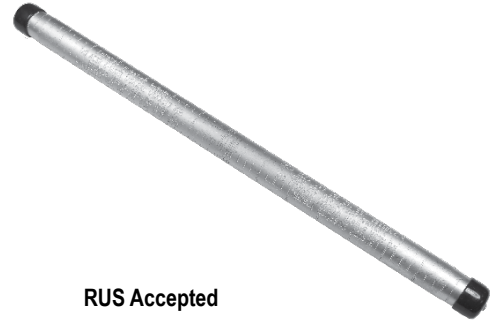

RUS Accepted

* Multiple crimp die set; makes more than one crimp per tool compression. Figure indicates number of compressions.

** MD6 NON-BOW Dies produce straight sleeves without rotating tool.

‡ U Die with adapter PUADP1.

† U Die with adapter PT6515.

††† Accommodates ACSR with aluminized steel core.

For faster installations use BURNDY® PATRIOT® family of battery tools.

Catalog Number	Conductor †††	L	Die Index	Tool Series, Die Set Catalog Number, & (Crimps per End)			
				MD7, MD6	35, 750, Y45†, 46‡	60	644 and 444S Series
YDS4RLY	4ACSR (7-1) 4ACSR (6-1) 4 6201 (7) 4 5005 (7) 4AAC (7)	12-1/2	BG, or 243, or 687	BG (20) WBG (10)* W687 (10)**	UBG (8)* U243 (6)	L243 (3)	4
YDS2RLY	2ACSR (6-1) 2 6201 (7) 2 5005 (7) 2AAC (7)	12-3/8	BG, or 243, or 687	BG (20) WBG (10)* W687 (10)**	UBG (8)* U243 (6)	L243 (3)	4
YDS021RLY	2ACSR (7-1) 2ACSR (6-1) 2 6201 (7) 2AAC (7)	14-3/8	C, or 167, or 247, or 702	WC (24) W702 (11)**	U167 (12) U247 (6)	L167 (6)	4
YDS25RLY	1/0 ACSR (6-1) 1/0 6201 (7) 1/0 5005 (7) 1/0 AAC (7)	17	C, or 167, or 247, or 660, or 702	WC (30) W660 (14) W702 (12)**	U167/U568 (14) U660 (7) U247 (7)	L167 (5)	5
YDS26RLY	2/0 ACSR (6-1) 2/0 6201 (7) 2/0 5005 (7) 2/0 AAC (7)	15	659	—	U659 Crimps Overlap	—	5
YDS27RLY	3/0 ACSR (6-1) 3/0 6201 (7) 3/0 5005 (7) 3/0 AAC (7)	21	658	—	U658 Crimps Overlap	—	7
YDS28RLY	4/0 ACSR (6-1) 4/0 6201 (7) 4/0 5005 (7) 4/0 AAC (7)	21	654	—	U654 Crimps Overlap	—	7
YDS321RLY	336.4 ACSR (18-1) 336.4 AAC (19)	20-1/2	655	—	U655 Crimps Overlap	—	7

Overhead Distribution

Compression Splices - Two Sleeve Full Tension
HYSPLICE™ Types YDS-R SET, YDS-RP1, YDS-RP2

HYSPLICE™ Two Sleeve, Types YDS-R SET, YDS-RP1 (Aluminum), YDS-RP2 (Steel)

For ACSR (Stranded, Compressed, Compact)

Material: Aluminum (Outer Sleeve)
 Steel (Inner Sleeve)

Tension Rating: ANSI C119.4 Class 1
 (Full Tension)



RUS Accepted

Two-piece, full tension HYSPLICE™ connectors, consist of an aluminum outer sleeve and steel inner sleeve. Tapered outer sleeve provides gradual transition of stress. Filler holes provided for PENETROX™ joint compound. Sizes 1/0 and larger are supplied with plugs for filler hole. Installed with standard tooling and dies (Series 35 and Series 750 platforms install through 556). Aluminum and steel sleeves can be ordered separately or in sets.

* Multiple crimp die set; makes more than one crimp per tool compression. Figure indicates number of compressions.

† U Die with adapter PT6515.

‡ U Die with adapter PUADP1.

For faster installations use BURNDY® PATRIOT® family of battery tools.

Catalog Number			Conductor	L	Die Index	Tools, Die Set Catalog Number, & (Crimps per End)		
Set	Sleeves					MD7, MD6	35, 750, Y45†, 46‡	60
YDS021R	Steel Alum.	YDS25RP2 YDS021RP1	2 (7/1) Sparate	4.75" 17.00"	242 241	W242 (8) W241 (10)	U242 (4) U241 (5)	—
YDS1R	Steel Alum.	YDS1RP2 YDS1RP1	1 (6/1) Robin	4.13" 16.63"	240 241	W240 (6) W241 (10)	U240 (3) U241 (5)	—
YDS25R	Steel Alum.	YDS25RP2 YDS25RP1	1/0 (6/1) Raven	4.75" 17.00"	242 243	W242 (8) W243 (12)	U242 (4) U243 (6)	—
YDS26R	Steel Alum.	YDS26RP2 YDS26RP1	2/0 (6/1) Quail	5.25" 19.75"	242 245	W242 (8) W245 (15)	U242 (4) U245 (8)	—
YDS27R	Steel Alum.	YDS27RP2 YDS27RP1	3/0 (6/1) Pigeon	5.25" 16.75"	248 247	W248 (16) W247 (12)	U248 (8) U247 (6)	L248 (3)* L247 (4)*
YDS28R	Steel Alum.	YDS28RP2 YDS28RP1	4/0 (6/1) Penguin	5.13" 18.88"	248 249	W248 (14) W249 (14)	U248 (7) U249 (7)	L248 (4)* L249 (4)
YDS291R	Steel Alum.	YDS1RP2 YDS291RP1	266.8 (18 - 1)	4-1/8" 19-3/4"	240 251	W240 (6) —	U240 (3) U251 (12)	— L251 (6)
YDS30R	Steel Alum.	YDS30RP2 YDS30RP1	266.8 (26/7) Owl 266.8 (26/7) Partridge	6.00" 19.75"	250 251	—	U250 (10) U251 (10)	L250 (3) L251 (5)
YDS321R	Steel Alum.	YDS25RP2 YDS321RP1	336.4 (18/1) Merlin	4.75" 17.88"	242 490	W242 (8) —	U242 (4) U490 (10)	L242 (2)* L490 (4)
YDS32R	Steel Alum.	YDS32RP2 YDS33RP1	336.4 (26/7) Linnnet 336.4 (30/7) Oriole	6.88" 22.25"	252 316	—	U252 (9) U316 (9)	L252 (3) L316 (3)
YDS33R	Steel Alum.	YDS41RP2 YDS33RP1	336.4 (30/7) Oriole	8.63" 22.25"	305 316	—	U305 (9) U316 (9)	L305 (3) L316 (3)
YDS34R	Steel Alum.	YDS34RP2 YDS35RP1	397.5 (26/7) Ibis 397.5 (30/7) Lark	6.25" 25.63"	253 317	—	U253 (9) U317 (12)	L253 (3) L317 (4)
YDS35R	Steel Alum.	YDS44RP2 YDS35RP1	397.5 (30/7) Lark	8.00" 25.63"	255 317	—	U255 (12) U317 (12)	L255 (4) L317 (4)
YDS361R	Steel Alum.	YDS27RP2 YDS361RP1	477.0 (18/1) Pelican	5.25" 25.63"	248 327	W248 (16) —	U248 (8) U327 (16)	L248 (4)* L327 (5)
YDS326R	Steel Alum.	YDS34RP2 YDS37RP1	477.0 (24/7) Flicker 477.0 (26/7) Hawk 477.0 (30/7) Hen	6.25" 26.38"	253 261	—	U253 (9) U261 (12)	L253 (3) L261 (4)
YDS36R	Steel Alum.	YDS36RP2 YDS37RP1	477.0 (26/7) Hawk	7.88" 26.38"	350 261	—	U350 (12) U261 (12)	L350 (4) L261 (4)

**HYSPLICE™ Two Sleeve, Types YDS-R SET,
 YDS-RP1 (Aluminum), YDS-RP2 (Steel)**

For ACSR (Stranded, Compressed, Compact)
 (Continued)



RUS Accepted

Catalog Number		Conductor	L	Die Index	Tool Series, Die Set Catalog Number, & (Crimps per End)				
Set	Sleeves				35, 750,	Y45	46	60	
YDS392R	Steel	YDS41RP2 YDS39RP1	556.5 (24-7)	8-5/8 26-1/8	305 608	U305 (9)	†	‡	L305 (3)
	Alum.					U608 (15)	†	‡	L608 (5)
YDS40R	Steel	YDS44RP2 YDS39RP1	556.5 (26-7)	8 26-1/8	255 608	U255 (12)	†	‡	L255 (4)
	Alum.					U608 (15)	†	‡	L608 (5)
YDS42R	Steel	YDS43RP2 YDS43RP1	636 (24-7)	8 32-1/2	254 319	—	S254 (15)	P254 (15)	L254 (5)
	Alum.					—	S319 (18)	P319 (18)	L319 (6)
YDS43R45RS	Steel	YDS45RP2 YDS43RP1	636 (26-7)	9 32-1/2	320 319	—	S320 (15)	P320 (15)	L320 (5)
	Alum.					—	S319 (18)	P319 (18)	L319 (6)
YDS43R43RS	Steel	YDS43RP2 YDS43RP1	666.6 (24-7)	8 32-1/2	254 319	—	S254 (15)	P254 (15)	L254 (5)
	Alum.					—	S319 (18)	P319 (18)	L319 (6)
YDS451R49RS	Steel	YDS49RP2 YDS451RP1	795 (26-7)	10 32-1/2	419 579	—	—	P419 (21)	L419 (7)
	Alum.					—	S579 (13)	P579 (13)	L579 (6)
YDS45R45RS	Steel	YDS45RP2 YDS45RP1	795 (54-7)	9 32-1/2	320 352	—	S320 (15)	P320 (15)	L320 (5)
	Alum.					—	S352 (12)	P352 (12)	L352 (6)
YDS451R34RS	Steel	YDS34RP2 YDS451RP1	900 (45-7)	6-1/4 32-1/2	253 579	U253 (9)	†	‡	L253 (3)
	Alum.					—	S579	P579	L579 (6)
YDS49R	Steel	YDS49RP2 YDS49RP1	1033.5 (54-7)	10 37	419 422	—	—	—	L419 (7)
	Alum.					—	—	—	L422 (8)
YDS50R	Steel	YDS36RP2 YDS49RP1	1113 (45-7)	7-7/8 37	350 422	U350 (12)	†	‡	L350 (4)
	Alum.					—	—	—	L422 (8)

† U Die with adapter PT6515.

‡ U Die with adapter PUADP1.

For faster installations use BURNDY® PATRIOT® family of battery tools.

For ACSR “Static” Wire

Catalog Number		Conductor	L	Die Index	Tool Series, Die Set Catalog Number, & (Crimps per End)			
Set	Sleeves				MD7, MD6	35, 750, Y45†, 46‡	60	
YDS011R	Steel	YDS27RP2 YDS011RP1	80 (8/1)	5-1/4 19-3/4	248 245	W248 (16)	U248 (8)	—
	Alum.					W245 (12)	U245 (6)	—
YDS251R	Steel	YDS34RP2 YDS251RP1	101.8 (12/7)	6-1/4 22-1/4	253 316	—	U253 (9)	L253 (3)
	Alum.					—	U316 (9)	L316 (3)
YDS261R	Steel	YDS41RP2 YDS261RP1	134.6 (12/7)	8-5/8 22-1/4	305 316	—	U305 (9)	L305 (3)
	Alum.					—	U316 (9)	L316 (3)
YDS271R	Steel	YDS44RP2 YDS271RP1	159 (12/7)	8 25-5/8	255 317	—	U255 (12)	L255 (4)
	Alum.					—	U317 (12)	L317 (4)

† U Die with adapter PT6515.

‡ U Die with adapter PUADP1.

HYSPLICE™ Two Sleeve, Types YDS-R, YDS-RE

For ACSR

Material: Aluminum (Outer Splice)
Steel (Inner Splice)

Tension Rating: ANSI C119.4 Class 1
(Full Tension)



Two-piece, full tension HYSPLICE™ splices, made of aluminum outer sleeve and steel sleeve for steel core. Designed to be installed with BURNDY® EEI dies. BURNDY® and EEI die index numbers are clearly marked on the sleeve.

Catalog Number Aluminum & Steel Sleeve Set	Catalog Number Aluminum Sleeve	Conductor	Aluminum Outer Sleeve					Catalog Number Steel Sleeve	Steel Inner Sleeve				
			L	EEI Die #	Die Index	Tools, Die Set Catalog No., & (Crimps per End)			LL	EEI Die #	Die Index	Tools, Die Set Catalog No., & (Crimps per End)	
						MD6	35, 750, Y45†, 46‡					MD6	35, Y750, Y45†, 46‡
YDS2RE	YDS021REP1	2 (6-1)	17-1/8	6A	693	W693 (20)	U693 (5)	YDS2REP2	4-1/8	1S	690	W690 (8)	U690 (4)
YDS021RE	—	2 (7-1)		8A	243	W243 (10)	U243 (5)	YDS25REP2	4-3/4	2S	691	W691 (9)	U691 (3)
—	YDS25RP1	1/0 (6-1)	19-3/4	9A	245	W245 (12)	U245 (6)	—	5-1/4	4S	692	W692 (12)	U692 (6)
—	YDS26RP1	2/0 (6-1)	16-3/4	10A	694	W694 (12)	U694 (6)	YDS27RP2	5-1/4	5S	248	W248 (8)	U248 (8)
YDS27RE	YDS27RP1	3/0 (6-1)	18-7/8	11A	249	W249 (14)	U249 (7)	YD28REP2	5-1/4	5S	248	W248 (8)	U248 (8)
YDS28RE	YDS28RP1	4/0 (6-1)	17-7/8	13A	655	—	U655 (9)	YDS25REP2	4-3/4	2S	691	W691 (9)	U691 (3)
—	—	336.4 (18-1)	25-1/2	14A	327	W327	U327 (16)	YDS27RP2	5-1/4	5S	248	W248 (8)	U248 (3)
YDS361R	YDS361RP1	477 (18-1)											

† U Die with adapter PT6515.

‡ U Die with adapter PUADP1.

For faster installations use BURNDY® PATRIOT® family of battery tools.

HYSPLICE™ Two Sleeve, Types YDS-E, YDS-H, YDS-U

For Steel

Material: Steel

Tension Rating: ANSI C119.4 Class 1
(Full Tension)



Full tension HYSPLICE™ sleeves designed for HS, EHS, Utilities (UT), or Siemens-Martin (SM) galvanized steel guy, messenger, and "Static" conductor. Made of hot-rip galvanized seamless milled steel tubing lined with silicone carbide particles.

* Multiple crimp die set; makes more than one crimp per tool compression. Figure indicates number of compressions.

† U Die with adapter PT6515.

‡ U Die with adapter PUADP1.

For faster installations use BURNDY® PATRIOT® family of battery tools.

Catalog Number	Conductor			L	Die Index	Tools, Die Set Catalog Number, & (Crimps per End)	
	Size	Str.	Grade			35, 750, Y45†, 46‡	60
YDS250E	1/4	7	EHS	6-3/4	609	U609 (10)	—
YDS312H	5/16	7	HS	10-5/8	257	U257 (20)	L257 (5)*
YDS312E	5/16	7	EHS	8-1/2	305	U305 (6)	L305 (3)
YDS375H	3/8	7	HS, UT	9	304	U304 (12)	L304 (4)
YDS500H	1/2	7	HS	9-5/8	293	—	L293 (6)

**UNISPLICE™ Single Sleeve Replacement Splice,
Type YDSR-RL**

For AAC (Stranded, Compact), ACSR, AAAC

Material: Aluminum

Tension Rating: ANSI C119.4 Class 1A
(Full Tension)

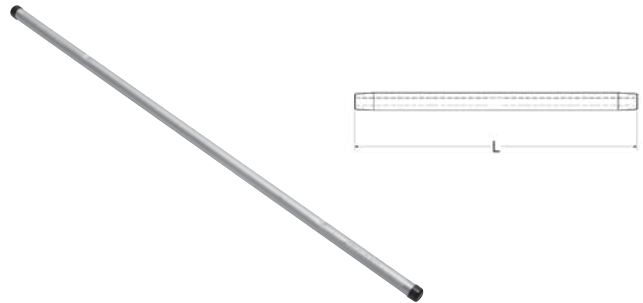

Single sleeve aluminum UNISPLICE™ replacement splices are designed to facilitate the permanent replacement of existing line splices, including automatic type. Utilizing all the benefits of the standard UNISPLICE™ connectors, the extra long Replacement UNISPLICE™ Type YDSR-RL fills the gap of a cutout splice and eliminates the need to find like conductor. It also reduces installation time of the current standard methods by half, reducing the total number of splices necessary from two to one. All splices are prefilled with PENETROX™ joint compound, stripsealed, and capped to limit oxide growth and to increase the life of the connection.

- ① U Die with adapter PT-6515.
- ② U Die with adapter PUADP-1.
- * Multiple crimp die set; makes more than one crimp per tool compression. Figure indicates number of compressions.
- ** MD6 NON-BOW Dies produce straight sleeves without rotating tool.
- † Overlap Crimps
- For faster installations use BURNDY® PATRIOT® family of battery tools.

Catalog Number	Conductor		L	Die Index	Installation Tooling Data (# of crimps per end)					
	AWG / kcmil	Str.			MD7, MD6 HYTOOL™	35	750	Y45 ①	46 ②	644 and 444S Series
YDSR4RL	4 ACSR 4 6201 4 5005 4 AAC	6-1; 7-1 7 7 7	24.63"	BG 687 243	WBG (11)* W687 (9)** W243 (11)	UBG (9)* U243 (6)	UBG (9) U243 (6)	UBG (9) U243 (6)	UBG (9) U243 (6)	4
YDSR2RL	2 ACSR 2 6201 2 5005 2 AAC	6-1; 7-1 7 7 7	28.00"	BG 687 243	WBG (20) W687 (10)** W243 (10)	UBG (8)* U243 (5)	UBG (8) U243 (5)	UBG (8) U243 (5)	UBG (8) U243 (5)	4
YDSR25RL	1/0 ACSR 1/0 6201 1/0 5005 1/0 AAC	6-1 7 7 7	34.13"	C 167 247 660 702	WC (30) W247 (14) W660 (15) W702 (14)**	U167/U568 (15) U247 (8) U660 (8)	U167/U568 (15) U247 (8) U660 (8)	U167/U568 (15) U247 (8) U660 (8)	U167/U568 (15) U247 (8) U660 (8)	4
YDSR26RL	2/0 ACSR 2/0 6201 2/0 5005 2/0 AAC	6-1 7 7 7	35.50"	659	—	U659 † (11)	U659 † (11)	U659 † (11)	U659 † (11)	5
YDSR27RL	3/0 ACSR 3/0 6201 3/0 5005 3/0 AAC	6-1 7 7 7	42.25"	658	—	U658 † (16)	U658 † (16)	U658 † (16)	U658 † (16)	5
YDSR28RL	4/0 ACSR 4/0 6201 4/0 5005 4/0 AAC	6-1 7 7 7	45.75"	654	—	U654 † (18)	U654 † (18)	U654 † (18)	U654 † (18)	7
YDSR321RL	336.4 ACSR 336.4 AAC 350.0 AAC	18-1 19 19	45.75"	655	—	U655 † (21)	U655 † (21)	U655 † (21)	U655 † (21)	7
YDSR341RL	397.5 ACSR 419.6 5005	18-1 19	49.50"	327	—	U327 (18)	U327 (18)	U327 (18)	U327 (18)	7
YDS361RL	477 (18-1) 556.5 (18-1) 587.2 5005	18-1 18-1 19	23.21"	720 788	—	U-788 † (31)	U-788 † (31)	U-788 † (31)	U-788 † (31)	9

UNISPLICE™ Reducer Splice; Type YDR-R For AAC (Stranded, Compressed), ACSR, AAAC

Material: Aluminum

Tension Rating: ANSI C119.4 Class 1
(Full Tension)

Single-sleeve aluminum UNISPLICE™ reducer is designed to splice ACSR as simply as all aluminum. Prefilled with PENETROX™ joint compound, stripsealed, and capped to limit oxide growth and increase the life of the connection. Eliminates strand stripping, installing separate steel sleeve and filling with joint compound. Electrical and mechanical performance equal to two-piece sleeves.

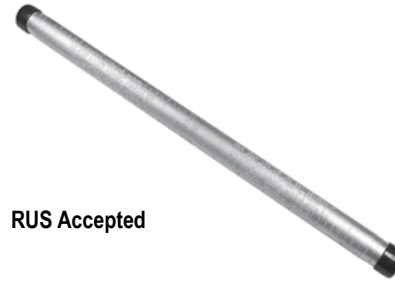

RUS Accepted

Catalog Number	Side A		Side B		L	OD	Tools, Die Set Catalog Number (# crimps per side)			
	ACSR, 6201, 5005	Aluminum	ACSR, 6201, 5005	Aluminum			Die Index	MD6 / MD7 Series	35 and 750 Series	644 and 444S Series
YDR2R4RG1	#2 (6/1)	#2	#4 (6/1)	#4	11.91	0.66	BG 243	WBG (10) W243 (12)	UBG (1) U243 (6)	4
YDR25R4RL	1/0 (6/1)	1/0	#4 (6/1)	#4	12.93	0.80	167 247 K737	W167 (32) W247 (16) WK737 (32)	U167 (14) U247 (7) UK737 (14)	5
YDR25R2RL	1/0 (6/1)	1/0	#2 (6/1)	#2	12.93	0.80	167 247 K737	W167 (32) W247 (16) WK737 (32)	U167 (14) U247 (7) UK737 (14)	5
YDR27R25RL	3/0 (6/1)	3/0	1/0 (6/1)	1/0	18.18	0.91	658	—	U658 (16 overlap) U658 (11 spaced)	7
YDR28R26R	4/0 (6/1)	4/0	2/0 (6/1)	2/0	18.65	1.02	654	—	U654 (18 overlap) U654 (12 spaced)	7
YDR28R27R	4/0 (6/1)	4/0	3/0 (6/1)	3/0	18.65	1.02	654	—	U654 (18 overlap) U654 (12 spaced)	7
YDR391RL321RL	556.5 (18/1)	—	336.4 (18/1)	—	16.27	1.40	318/261	—	U261 (12)	7

* Multiple crimp die set; makes more than one crimp per tool compression. Figure indicates number of compressions. For faster installations use BURNDY® PATRIOT® family of battery tools.

HYSPLICE™, Type YDS-K For Copperweld

Material: Copper

Tension Rating: ANSI C119.4 Class 1
(Full Tension)



Full tension HYSPLICE™ designed to exceed the minimum rated breaking strength of 30% conductivity extra high strength Copperweld and lower strength conductors. Made of pure copper tubing. Installed with standard BURNDY® tools and dies.

* Multiple crimp die set; makes more than one crimp per tool compression. Figure indicates number of compressions.
† U Die with adapter PT-6515.
‡ U Die with adapter PUADP-1.
For faster installations use BURNDY® PATRIOT® family of battery tools.

Catalog Number	Conductor	L	Die Index	Tool Series, Die Set Catalog Number, & (Crimps per End)		
				MD7, MD6	35, 750, Y45†, 46‡	60
YDS8WK	8 Sol.	3-3/4	285, or 162	W162 (6)	U285 (2)	—
YDS6WK	6 Sol.	4-3/8	276, or 162	W162 (6)	U276 (6)	—
YDS3K10	(3 #10)	4-7/8	403	—	U403 (3)*	—
YDS3K8	(3 #8)	5-5/8	205	—	U205 (5)	—
YDS3K7	5/16 (7 #10) (3 #7)	10	167	—	U167/U568 (10)	L167 (4)
YDS3K6	11/32 (7#9) (3#6)	9-1/2	331	—	U331 (9)	L331 (3)
YDS3K5	3/8 (7 #8) (3 #5)	6-7/8	259	—	U259 (6)	L259 (2)
YDS7K7	7/16 (7 #7)	6-7/8	328	—	—	L328 (3)
YDS7K6	1/2 (7 #6)	9-3/8	260	—	—	L260 (4)
YDS7K5	9/16 (7 #5)	11-3/8	344	—	—	L344 (6)

Single Sleeve Splice, Type YTS-E For EHS Steel

Material: Aluminum

Tension Rating: ANSI C119.4 Class 1
(Full Tension)

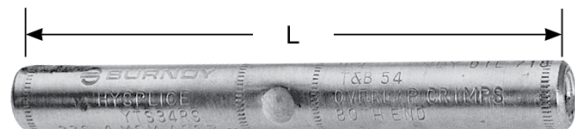

RUS Accepted

Full tension splice for EHS steel guy, messenger, or "static" cable. Sleeve is prefilled with PENETROX™ joint compound, stripsealed, and capped to limit oxide growth and increase the life of the connection.

Catalog Number	Conductor †	L	Tool Series, Die Sets	
	EHS Steel		Die Index	60*
YTS375E	3/8" 7 Str.	10-3/8	723	L723
YTS438E	7/16" 7 Str.	11-7/8	726	L726

* Overlap crimps.

† Sleeve is high strength aluminum alloy for optimum corrosion resistance.

For faster installations use BURNDY® PATRIOT® family of battery tools.

HYSPlice™, Types YDS-KT, YDS-F For Copperweld, Copper

Material: Copper

Tension Rating: ANSI C119.4 Class 1
(Full Tension)

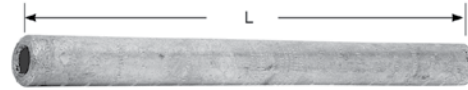

RUS Accepted

Full tension HYSPlice™ splice is made of pure copper tubing. Type YDS-KT is tapered to provide gradual transition of stress on Type "A" conductor. HYSPlice™ Type YDS-F connectors are recommended for Type "F" conductor.

Catalog Number	Conductor	L	Die Index	Tools, Die Set Catalog Number, & (Crimps per End)		
				MD7, MD6	35, 750, Y45†, 46‡	60
YDS8KT	8A	5	162 or 202	W162 (4)	U202 (4)*	—
YDS6KT	6A	6-1/8	162 or 203	W162 (5)	U203 (5)*	—
YDS4KT	4A	6-3/8	163 or 204	W163 (5)	U204 (10)	—
YDS2KT	2A	7-3/4	205	—	U205	—
YDS3K6	11/32 (7#9) (3#6)	9-1/2	331	—	U331 (9)	L331 (3)
YDS2F	2F	6-1/4	329	—	U329 (4)	—
YDS25F	1/0F	8-3/4	568	—	U167/U568 (8)	—
YDS26F	2/0F	9-5/8	552	—	U552 (11)	—
YDS28F	4/0F	11-7/8	331	—	U331 (12)	L331(4)

* Multiple crimp die set; makes more than one crimp per tool compression. Figure indicates number of compressions.

† U Die with adapter PT6515.

‡ U Die with adapter PUADP1.

For faster installations use BURNDY® PATRIOT® family of battery tools.

Single Sleeve Splice, Type YDS-M-T For Alumoweld

Material: Aluminum

Tension Rating: ANSI C119.4 Class 1
(Full Tension)



RUS Accepted

Full tension splice for Alumoweld transmission lines. Five connectors accommodate eight conductor sizes. Sleeve is pre-filled with PENETROX™ joint compound and capped.

* Overlap crimps.

† U Die with adapter PT6515.

‡ U Die with adapter PUADP1.

††† Sleeve is high strength aluminum alloy for optimum corrosion resistance.

For faster installations use BURNDY® PATRIOT® family of battery tools.

Catalog ††† Number	Conductor ALUMOWELD	L	Tools, Die Sets		
			Die Index	35, 750, Y45†, 46‡	60
YDS7M10T	7 #10, 3 #7	10	676 or 721	U676 (8)	L721
YDS7M9T	7 #9, 3 #6	10-3/8	677	U677 (10)	—
YDS7M8T	7 #8, 3 #5	12-1/4	668 or 723	U668 (13)	L723
YDS7M7T	7 #7	14-1/2	678 or 726	U678 (19)	L726
YDS7M6T	7 #6	15-1/8	679 or 726	U679 (2)	L726

Table of Contents

Deadend Fitting and Accessories	H-72
Loop	
Type UP-R.....	H-72
Type BC.....	H-73
Type M.....	H-73
Primary and Bus Strain	
Type CUW-E.....	H-74
Type DUW.....	H-74
Types CUW-A-E, CUW-R-E.....	H-75
Types DUW-A, DUW-A-E.....	H-75

Deadend Fittings and Accessories

General Overview

The deadend method selected for any particular application will depend upon the nature of the application, the size of the conductor, holding strength required, and preference for mechanical or compression devices.

Secondaries are commonly deadended by bending wire around a spool insulator and snubbing with the same connectors used for the secondary to service drop connection. On copper conductor, connectors such as U-bolt deadend Type BC, SERVIT® Type KS, OKLIP™ connector Type KVS or CRIMPIT™ Type YC-C are recommended. These connectors provide high holding strength without damaging conductor strands. On aluminum wires, CLIPIT™ UW-R, mechanical connector is recommended.

The same methods can also be used on primaries. However, the straight line clamp Type CUW-A-E is more popular for this application. They are easier to install on either hot or de-energized lines. They are particularly well suited to hot-line maintenance, and allow easy re-sagging of conductors.

Straight line types are also popular for deadending strain buses. These are normally large, hard to handle conductors that do not lend themselves to snub or "quadrant" types. Types DUW or CUW-E are recommended for copper conductor and DUW-A and DUW-AE for aluminum and ACSR. The pulling eye on the DUW-A-E is in line with the cable to make installation easier.

Heavy Duty Parallel Clamp Type UP-R

For AAC (Stranded, Compressed, Compact†), ACSR†, AAAC, Copper

Material: Aluminum

Heavy duty aluminum connector for feeder, subtransmission, and primary distribution. Massive design and large spacer give maximum protection against galvanic action and overload conditions. Spacing of U-bolts, tapered bell mouths, and modified V groove minimize cold flow, eliminate cable damage, and produce wiping action on conductors. Spacer taps confine cable strands to prevent splaying. Captured, heat treated aluminum alloy U-bolts. PENETROX™ joint compound recommended for all combinations.

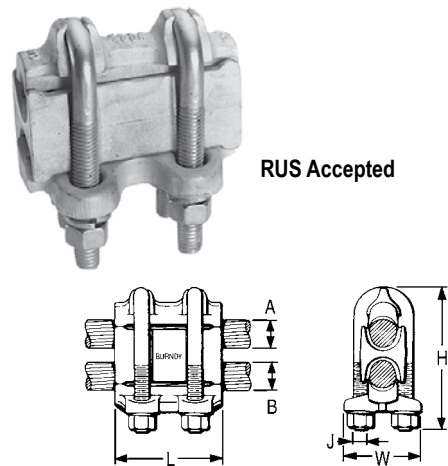

Catalog Number	Groove A		Groove B		Dimensions			
	ACSR †, 6201, 5005	Copper or Aluminum †	ACSR †, 6201, 5005	Copper or Aluminum †	H	J	L	W
UP34R	110.8 (12-7) - 397.5 (18-1)	3/0 Str. - 400	110.8 (12.7) - 397.5 (18-1)	3/0 Str. - 400	4-5/8	1/2-13	4	2-5/8
UP45R36R	336.4 (30-7) - 795 (30-19)	397.5 - 954	110.8 (12-7) - 447 (18-1)	3/0 Str. - 500	5-1/4	1/2-13	4	2-7/8
UP45R	336.4 (30-7) - 795 (30-19)	397.5 - 954	336.4 (30-7) - 795 (30-19)	397.5 - 954	6-1/4	5/8-11	4-1/2	3-1/4

† Accommodates compact and compressed conductors within diameter range.
To ensure proper tightening torque use BURNDY® BTW torque wrenches.

Deadend Clamp, Type BC
For Guy Wire

Material: Copper

Deadend clamp for Guy Wire, Type BC is supplied with DURIMUM™ silicon bronze U-bolt, nuts, and washers. Saddle is made of high strength corrosion resistant copper alloy.

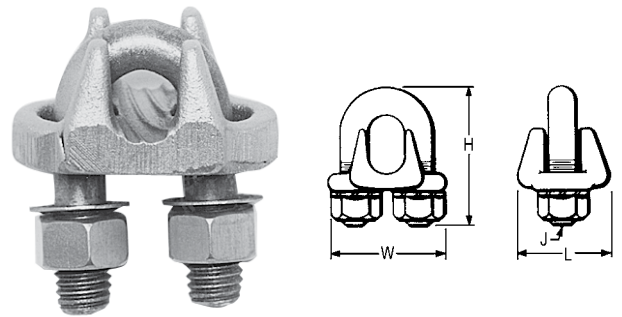

Catalog Number	Copper	Guy Wire	Dimensions			
			H	J	L	W
BC2C	2 Sol.	5/16	2	3/8	1-1/4	1-3/4
BC25	1/0 Str.	3/8			1-3/8	
BC28	2/0 Str. - 4/0 Str.	1/2	2-3/8	1/2	1-3/4	2-1/4

Deadend Thimble, Type M
For Copper, Guy Wire

Material: Copper

High strength corrosion resistant copper alloy thimble groove to fit any size guy wire used for deadending. Generous radius prevents kinking or overstressing outer strands of wire.

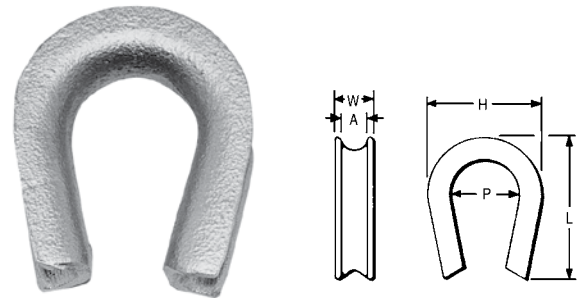

Catalog Number	Groove Size A	Dimensions			
		H	L	P	W
M20	5/16	1-5/8	1-7/8	7/8	5/8
M30	3/8	1-7/8	2-1/8	1	
M40	7/16	1-3/4	2-5/8	1-1/8	
M50	1/2	1-7/8	2-1/4		
M60	5/8	2-1/4	2-5/8	1-3/8	7/8
M70	3/4	2-5/8	3-1/4	1-1/2	1
M80	7/8	3	3-3/8	1-3/4	1-1/4
M90	1	3-3/8	3-3/4	2	1-3/8

Deadend Clamp, Type CUW-E

For Copper

Material: Copper

High strength, two-bolt, cast copper alloy strain clamp with single saddle designed for short span distribution and strain bus application. Galvanized steel clevis pin, and U-bolts.



Catalog Number	Conductor Range	Dimensions		
		H	L	W
CUW34E	4/0 Str. - 500	3	7-3/8	4
CUW44E	500 - 1000	3-3/8	8-3/4	4-1/2

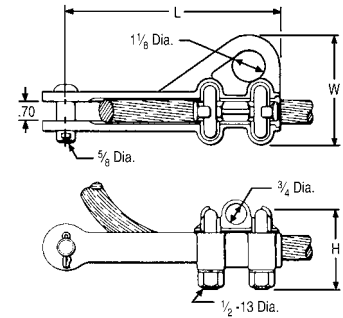

To ensure proper tightening torque use BURNDY® BTW torque wrenches.

Deadend Clamp, Type DUW

For Copper

Material: Copper

High strength, corrosion resistant copper alloy strain clamp with three DURIMUM™ silicon bronze U-bolts and single serrated saddle. Galvanized steel clevis pin.



Catalog Number	Conductor	Dimensions			
		H	J	L	W
DUW28	1 Str. - 4/0 Str.	2-1/2	3/8	9-7/8	2-1/4
DUW31	4/0 Str. - 350	2			2-3/8
DUW34	350-500	2-5/8	1/2		2-3/4
DUW44	500-1000	2-7/8		11-3/8	3-1/4

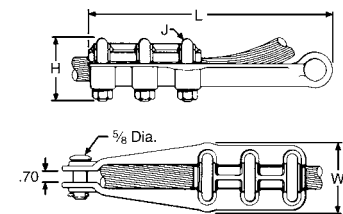

To ensure proper tightening torque use BURNDY® BTW torque wrenches.

Deadend Clamp, Types CUW-A-E, CUW-R-E

For AAC (Stranded, Compressed†), ACSR†, AAAC

Material: Aluminum

High strength, aluminum clamp for deadending primary distribution lines. Straight-line design with hot stick lifting-eye, pulling-eye, and captured, angled U-bolts, facilitates installation and maintenance, especially on hot-line work. Snub-pocket V-shaped, range-taking conductor groove, and galvanized steel U-bolts provide high holding strength.



RUS Accepted

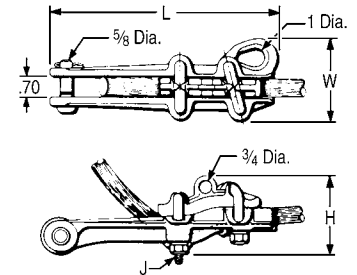

Catalog Number	Aluminum †	ACSR †, 6201, 5005	Dimensions			
			H	J	L	W
CUW26RE1	2 Str. - 2/0 (19)	4 - 2/0	3	3/8-16	8	3
CUW30AE	1/0 (7) - 300	1/0 - 266.8 (18-1)	3-5/8	1/2-13	10	3-1/2
CUW32RE	3/0 (7) - 350	3/0 - 336.4 (26-7)	4	1/2-13	10	3-5/8
CUW361RE	4/0 - 500	4/0 - 477 (18-1)	4-1/8	1/2-13	11	3-5/8
CUW391AE	336.4 - 795	300 (26-7) 636 (26-7)	4-7/8	1/2-13	11	4-1/8

† Accommodates compressed conductors within diameter range.
 To ensure proper tightening torque use BURNDY® BTW torque wrenches.

Deadend Clamp, Types DUW-A, DUW-A-E

For AAC (Stranded, Compressed†), ACSR†, AAAC

Material: Aluminum

High strength cast aluminum alloy clamp recommended for strain bus applications. Three galvanized steel U-bolts, single saddle, and headed clevis pin provide high holding strength. Type DUW-A-E has a pulling-eye in line with conductor for easier installation.

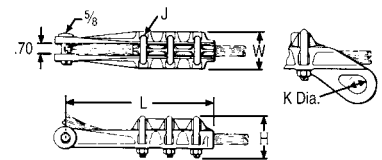
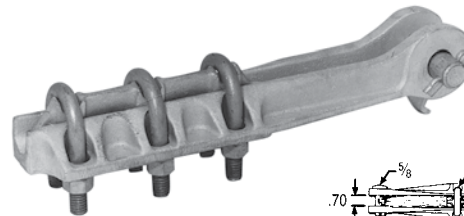

Catalog Number		Conductor		Dimensions				
Without Pulling Eye	With Pulling Eye	Aluminum †	ACSR †, 6201, 5005	H	J	K	L	W
DUW28A	—	1 - 4/0	2 (7-1) - 4/0	2	3/8	0.88	9-1/2	2-1/4
DUW44A	DUW44AE	500-1000	397.5 (30.7) - 900 (54-7)	3-3/8	1/2	1.25	11-1/4	3-5/8

† Accommodates compressed conductors within diameter range.
 To ensure proper tightening torque use BURNDY® BTW torque wrenches.

Table of Contents

Compression Terminals and Accessories.....	H-77
Types YCA-2N, YCAB-4N.....	H-77
Type YCA-RL-2N.....	H-78
Types YCA-R-N, YCAK-R-N.....	H-79
Type YAK-A-2G.....	H-81
Types YCAK-A, YRA.....	H-82

Compression Terminals and Accessories

General Overview

Compression terminals are used to make convenient and reliable connections to switch pads, transformers, and other electrical equipment. They accommodate either copper, aluminum, ACSR, ACAR, Alumoweld, or steel conductor and come with one, two, or four hole NEMA drilled pads to match the equipment drilling. Standard copper and aluminum terminals are also listed in the compression section (Section C of BURNDY® Master Catalog).

HYLUG™ Terminals, Types YCA-2N, YCAB-4N

For Copper

Material: Copper



Compression HYLUG™ terminals designed for terminating copper conductors to switch pads and other substation or switch yard apparatus. NEMA standard mounting holes. Made of pure copper. Installed with same die as equivalent full-tension jumper loop and repair sleeves.

Catalog Number	Conductor	Fig. No.	C	L	T	Die Index	Tool Series, Die Set Catalog Number, & (Number of Crimps)		
							MD7, MD6	35, 750, Y45†, 46‡	60
YCA252N	1/0 (7, 19)	1	7/8	5-3/8	1/8	165	W165 (3)	U165/U205 (3)	—
YCA262N	2/0 (7, 19, 37)		1	5-1/4	1/4	166	W166 (6)	U166/U459 (3)	—
YCA272N	3/0 (7, 19)		1-1/8	5-3/8		167	—	U167/U568 (3)	L167 (1)
YCA282N	4/0 (7, 12, 19)		1-1/4		168	—	U168 (3)	L168 (1)	
YCAB284N	4/0 (7, 12, 19)	2	3	5-5/8	3/8	—	—	—	
YCA292N	250 (7, 19, 37)	1	1-3/8			169	—	U169 (4)	L169 (1)
YCA302N	300 (19, 37)		1-1/2	5-1/2	170	—	U170 (5)	L170 (1)	
YCA312N	350 (12, 19, 37)		1-5/8	6-1/2	1/2	267	—	U267 (6)	L267 (2)
YCA322N	400 (19, 37)			6-3/4		209	—	U209 (6)	L209 (2)
YCAB324N	400 (19, 37)	2	3	7-1/8	3/8	—	—	—	
YCA342N	500 (19, 37)	1	1-7/8	6-1/2		210	—	U210 (6)	L210 (2)
YCAB344N	500 (19, 37)	2	3	6-7/8	1/2	—	—	—	
YCA392N	750 (37, 61)	1	2-3/8	7-1/4	5/8	627	—	—	L627 (3)
YCAB394N	750 (37, 61)			7-1/2			1/2	—	—
YCAB444N	1000 (61)	2	3	7-7/8	5/8	345	—	—	L345 (4)

YCAB have brazed pads.

† U Die with adapter PT6515

‡ U Die with adapter PUADP1

To ensure proper tightening torque use BURNDY® BTW torque wrenches.

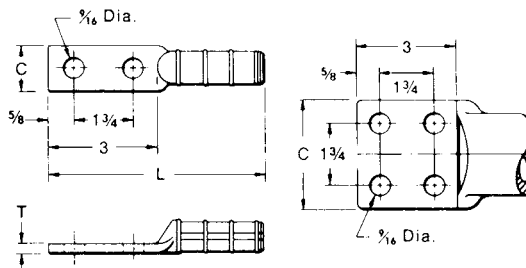

Fig. 1

Fig. 2

HYLUG™ Terminals, Type YCA-RL-2N

For AAC (Stranded, Compressed, Compact), ACSR, AAAC

Material: Aluminum

Aluminum compression HYLUG™ for terminating overhead conductors to switch pads and other substation or switch yard apparatus. NEMA standard mounting holes. Installed with same die as equivalent full tension UNISPLICE™. Prefilled with PENETROX™ joint compound, stripsealed, and capped to limit oxide growth and increase the life of the connection.

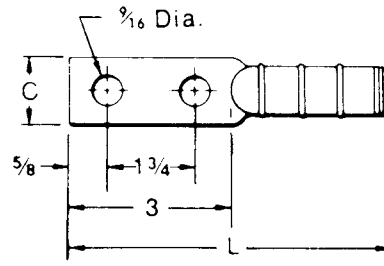
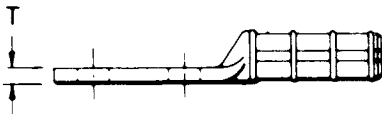

Catalog Number	Conductor	C	L	T	Die Index	Tools, Die Set Catalog Number, & (Number of Crimps)		
						MD7, MD6	35, 750, Y45†, 46‡	
YCA4RL2N	4 ACSR (6-1, 7-1) 4 6201 (7) 4 AAC (7)	7/8	6	3/8	BG, 243, 687	WBG (8) Fixed BG (8) W687 (4)	U243	
YCA2RL2N	2 ACSR (6-1, 7-1) 2 6201 (7) 2 AAC (7)							
YCA25RL2N	1/0 ACSR (6-1) 1/0 6201 (7) 1/0 AAC (7) 1/0 5005 (7)	1-1/8	7		C, 247, 702	WC (12) W702 (4)**	U247 (3)	
YCA26RL2N	2/0 ACSR (6-1) 2/0 6201 (7) 2/0 AAC (7) 2/0 5005 (7)				6-1/2	6-1/2	659	—
YCA27RL2N	3/0 ACSR (6-1) 3/0 6201 (7) 3/0 AAC (7)	1-1/4	658				—	U658 (3)
YCA28RL2N	4/0 ACSR (6-1) 4/0 6201 (7) 4/0 AAC (7) 4/0 5005 (7)	1-1/2	654				—	U654 (3)
YCA321RL2N	336.4 ACSR (18-1) 336.4 AAC (19) 500 AAC	1-5/8	655				—	U655 (3)

† U Die with adapter PT6515.

‡ U Die with adapter PUADP1.

** MD6 NON-BOW Dies produce straight sleeves without rotating tool.
For faster installations use BURNDY® PATRIOT® family of battery tools.

HYLUG™ Terminals, Types YCA-R-N, YCAK-R-N
 For AAC (Stranded, Compressed, Compact), ACSR, AAAC

Material: Aluminum

Aluminum compression HYLUG™ for terminating jumper loops and equipment taps at switchpads and other substation apparatus, or to Type YDW-R deadends. NEMA standard mounting holes. Installed with same dies as equivalent full-tension sleeves. Prefilled with PENETROX™ joint compound, stripealed, and capped to limit oxide growth and increase the life of the connection.

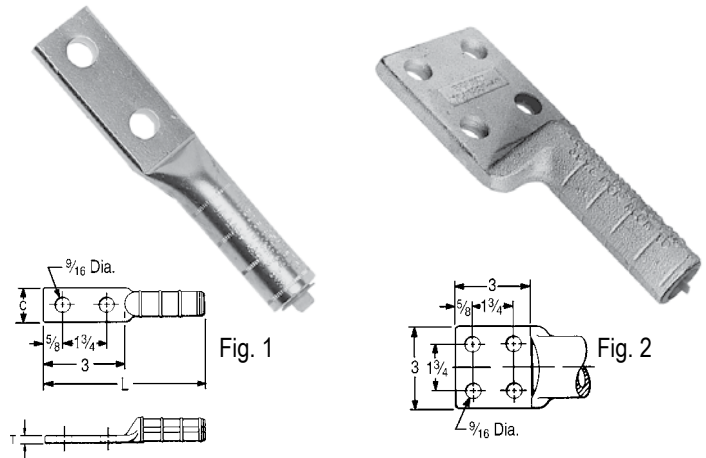

Catalog Number	Conductor		Fig No.	C	L	T	Die Index	Die Set, Tool Series Catalog Number, & (Number of Crimps)				
	ACSR, 6201, 5005	Aluminum						MD7, MD6 Series	35, 750	Y45	46	60
YCA4R2N	4	4 (7)	1	1-1/4	5-5/8	1/4	237	W237 (3)	U237 (2)	†	‡	—
YCA2R2N	2	2 (7)		7/8	6-1/4		KS18 243 BG or 8A	239	W239 (3)	U239 (2)	†	‡
YCA25R2N	1/0	1/0 (7,19)	2	3	6-7/8	3/8	245AA	BG (8) WBG (4)* U243 (2)	U-BG (4)	†	‡	—
YCAK25R4N				3	6-7/8	3/8		BG (8) WBG (4)* U243 (2)	U243 (2)	†	‡	L243 (1)
YCA26R2N	2/0	2/0 (7,19)	1	1	6-3/8	1/4	247	W245 (4)	U245 (2)	†	‡	L245 (1)
YCA27R2N	3/0 - 110.8 (12-7)	3/0 (7,19)		1-1/8	6-3/4			249	W247 (6)	U247 (3)	†	‡
YCA28R2N	4/0 (6-1, 6-7)	4/0 (7,19)	2	1-1/4	6-7/8	3/8	249	K840 249 11A	U249 (3)	†	‡	L249 (2)
YCAK28R4N				3	7-3/8			249	11A	†	‡	L249 (2)
YCA30R2N	266.8	266.8 (7,19)	1	1-1/2	6-3/4	3/8	251	—	U251 (4)	†	‡	L251 (2)
YCAK30R4N	(18-1, 6-7 26-7)			2	3			7-3/8	—	†	‡	L251 (2)
YCA321R2N	336.4 (18-1)	336.4 (19) - 350 (19, 37, 61)	1	1-1/2	7	3/8	321	—	U321 (4)	†	‡	L321 (2)
YCAK321R4N				2	3			7-1/8	—	†	‡	L321 (2)
YCA33R2N	336.4 (26-7, 30-7) 397.5 (18-1)	397.5 (19)	1	1-5/8	7-1/4	3/8	316	—	U316 (4)	†	‡	L316 (2)
YCAK33R4N				2	3			7-3/8	—	†	‡	L316 (2)
YCA35R2N	397.5 (26-7, 30-7)	477 (19, 37) - 500 (37, 61)	1	1-7/8	7-1/2	3/8	317	—	U317 (4)	†	‡	L317 (2)
YCAK35R4N				2	3			7-3/8	—	†	‡	L317 (2)
YCA361R2N	477 (18-1)	500 (37, 61)	1	1-7/8	7-5/8	7/16	327	—	U327 (4)	†	‡	L327 (2)
YCAK361R4N				2				3	—	†	‡	L327 (2)
YCA37R2N	556.5 (18-1)	556.5 (19, 37)	1	2	8-1/8	3/8	261	—	U261 (5)	†	‡	L261 (2)
YCAK37R4N	477 (24-7, 26-7, 30-7)			2				3	—	†	‡	L261 (2)
YCA39R2N	556.5 (24-7, 26-7)	—	1	2-1/8	8-3/8	1/2	608	—	U608 (6)	†	‡	L608 (2)
YCAK39R4N				2				3	8-1/8	—	†	‡
YCAK361A4N	—	636 (37)	2	3	8-1/8	1/2	469	—	—	—	P469 (6)	L469 (2)

* Multiple crimp die set; makes more than one crimp per tool compression. Figure indicates number of compressions.
 † U Die with adapter PT6515.
 ‡ U Die with adapter PUADP1.

YCA HYLUGS™ are made from heavy walled tubing. YCA4R-2N, YCA2R-2N and all YCAK HYLUGS™ are cast aluminum alloy. For faster installations use BURNDY® PATRIOT® family of battery tools.

(Table continued on next page.)

HYLUG™ Terminals, Types YCA-R-N, YCAK-R-N For AAC (Stranded, Compressed, Compact), ACSR, AAAC (Continued)

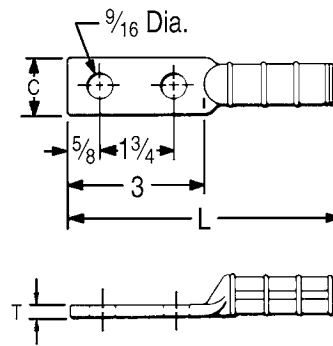

Fig. 1

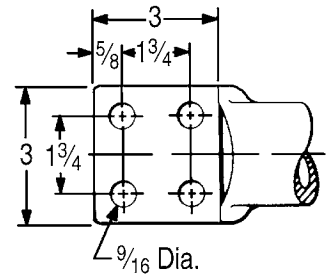

Fig. 2

Catalog Number	Conductor		Fig No.	C	L	T	Die Index	Die Set, Tools Catalog Number, & (Number of Crimps)		
	ACSR, 6201, 5005	Aluminum						Y45	46	60
YCA43R2N	605 (30-19)	795 (37, 61)	1	2-1/2	10-1/4	3/4	292 or 319	S292 (6) S319 (6)	P292 (6) P319 (6)	L292 (3) L319 (3)
YCAK43R4N	636 (24-7, 26-7, 30-19) 666.6 (24-7)	700 (61) 750 (61)	2	3	9-5/8					
YCA391A2N	—	795 (37)	1	2-3/8	10-1/8	5/8	342	S342 (6)	P342 (6)	L342 (3)
YCAK391A4N	—	750 (61)			9-7/8					
YCAK453R4N	795 (36-1) 715.5 (26-7) 795 (45-7)	—	2	3	9-5/8	5/8	292*, 578	S292 (6)	P292 (6)	L292 (3)
YCA44A2NG2	—	1000	1	2-3/8	11	5/8	342	S342 (6)	P342 (6)	L342 (3)
YCA45R2N	795 (26-7, 54-7)	900 (61, 91)			2-1/2					
YCAK45R4N		954 (37, 61) 1000 (61)	—	—	9-5/8	5/8	352	S352 (6) S579 (6)	P352 (6) P579 (6)	352 (3) L579 (3)
YCA48R4N	900 (54-7) 954 (54-7) (45-7) 1033.5 (45-7) (36-1)	—	2	3	10	3/4	575	—	—	L575 (3)
YCA441A4N	—	1033.5 (37, 61) - 113 (61)								
YCA451A4N	1113 (54-19)	1272 (61)	—	—	10-1/4	5/8	422	—	—	L422 (3)

* Multiple crimp die set; makes more than one crimp per tool compression.
Figure indicates number of compressions.
YCA HYLUGS™ are made from heavy walled tubing.
YCA4R-2N, YCA2R-2N and all YCAK HYLUGS™ are cast aluminum alloy.
For faster installations use BURNDY® PATRIOT® family of battery tools.

Stacking HYLUG™ Terminals, Type YAK-A-2G
For AAC (Stranded, Compressed)

Material: Aluminum

Cast aluminum HYLUG™ with a special tongue configuration for stacking of conductors on two and four hole NEMA transformer or equipment terminal pads. Up to eight conductors may be staked on one four hole NEMA pad. These stackable HYLUG™ terminals are prefilled with PENETROX™ joint compound, stripsealed, and capped to limit oxide growth and increase the life of the connection.

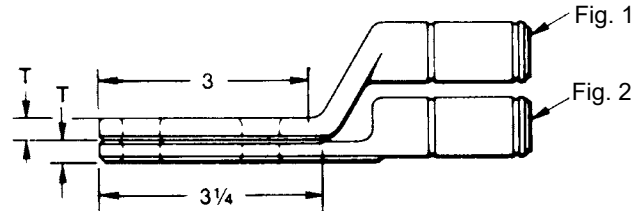
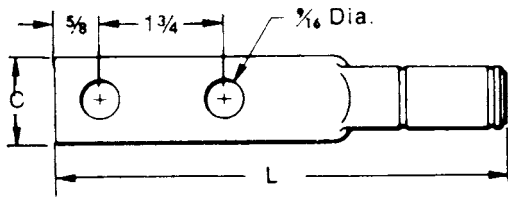
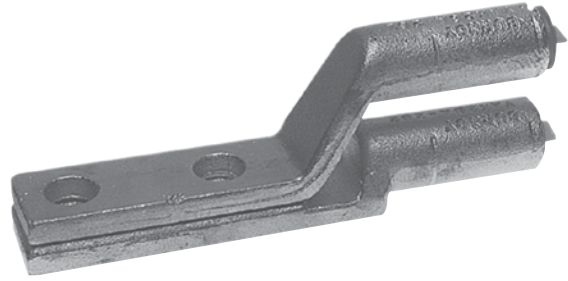

Catalog Number	Fig No.	Conductor	C	L	T	Die Index	Tool Series, Die Set & (Number of Crimps)			
							MD7, MD6 Series	35, 750	Y45	46
YAK2CA2G1	1	2 Str.	7/8	5-5/8	1/4	BG K-5/8 243	BG (3) WBG (1) W243 (1)	UBG (1) UK581T (3) U243 (1)	†	‡
YAK2CA2G2	2									
YAK25A2G1	1	1/0 Str.	1-1/8	6-1/4	5/16	249 K-840	W249* WK840*	U249*	†	‡
YAK25A2G2	2									
YAK28A2G1	1	4/0 Str.**	1-5/8	6-7/8	3/8	299 705	—	U31ART* U705	†	‡
YAK28A2G2	2									
YAK29A2G1	1	250	1-5/8	7-3/4	7/16	317 705	—	U317* U705*	†	‡
YAK31A2G1	1	350								
YAK31A2G2	2	350	1-5/8	7-3/4	7/16	317 705	—	U317* U705*	†	‡
YAK311A2G1	1	397.5								
YAK311A2G2	2	397.5	1-5/8	8-1/4	5/8	608 722 786	—	U608* U786*	† S786* S722*	‡ P786* P722*
YAK34A2G1	1	500								
YAK34A2G2	2	500	1-5/8	8-1/4	5/8	608 722 786	—	U608* U786*	† S786* S722*	‡ P786* P722*
YAK361A2G1	1	600								
YAK361A2G2	2	636	1-5/8	8-1/4	5/8	608 722 786	—	U608* U786*	† S786* S722*	‡ P786* P722*
YAK39A2G1	1	700								
YAK39A2G2	2	750	1-5/8	8-7/8	5/8	302	—	—	S44ART*	P44ART*
YAK44A2NG8	1	1000								
YAK44A2NG7	2	1000	1-5/8	8-7/8	5/8	302	—	—	S44ART*	P44ART*

* Overlap crimps.

** Accommodates 4/0 Str., Al or Cu.

† U Die with adapter PT6515.

‡ U Die with adapter PUADP1.

For faster installations use BURNDY® PATRIOT® family of battery tools.

Aluminum HYLUG™ Terminals, Types YCAK-A, YRA For AAC (Stranded, Compressed), ACSR, Copper

Material: Aluminum

Aluminum HYLUG™ terminals for joining aluminum and copper cable to transformer and equipment pads. HYLUG™ terminals are prefilled with PENETROX™ joint compound, stripsealed, and capped to limit oxide growth and increase the life of the connection. Installed with standard tooling, five die sets install fourteen terminal sizes.

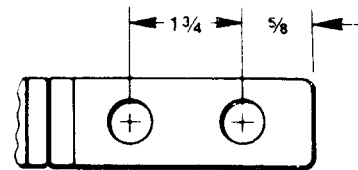
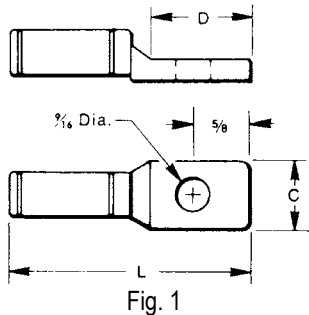
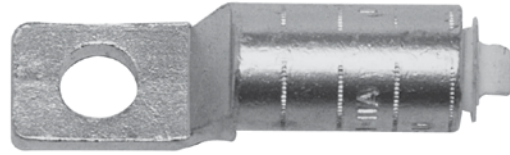

Fig. 2

Catalog Number	Fig No.	Conductor			C	D	L	Die Index	Die Set, Tool Catalog Number & (Number of Crimps)			
		Copper	Aluminum Conc.& Compact	ACSR					MD7, MD6 Series	35, 750	Y45	46
YRA8CU1	1	6 Sol. - 8 Sol.	8 Str.	—	15/16	1-1/16	2-9/16	BG 243	BG (3) K 5/8 243 (1)	UBG (1) UK5/81T (3) U243 (1)	†	‡
YRA6CU1		4 Sol. - 6 Str.	4 Sol. - 6 Str.	6 (6-1)								
YRA4CU1		2 Sol. - 4 Str.	2 Sol. - 4 Str.	4 (6-1, 7-1)								
YRA1CU1		1 Str. - 2 Str.	1 Str. - 2 Str.**	2 (6-1, 7-1)								
YRA25A1		—	1/0 Str.	—								
YRAL4CU		2 Sol. - 4 Str.	2 Sol. - 4 Str.	4 (6-1, 7-1)		1-1/4	3-1/4	249 K840	W249* WK840*	U249* UK840	†	‡
YRAL1CU		1 Str. - 2 Str.	1 Str. - 2 Str.	2 (6-1, 7-1)								
YRA25U		1/0 Str.	1/0 Str.	1/0 (6-1)								
YRA26U		2/0 Str.	2/0 Str.	2/0 (6-1)								
YRA27U		3/0 Str.	3/0 Str.	—								
YRA28U		4/0 Str.	4/0 Str.	—		1-1/4	3	5-5/8	317 705	—	U317* U705*	† S705*
YCAK28A2G1*	4/0 Str.	4/0 Str.	—									
YCAK29A2G1*	250	250	4/0 (6-1)									
YCAK31AG1*	350	350	—									
YCAK31A2G1*			—									
YCAK34A2G3*	500	500	—	1-1/2	3	6-1/2	608 786	—	U608* U786*	† S786*	‡ P786*	
YCAK36A2G1*	—	600	—									
YCAK39A2G2*	—	750	—									
YCAK44A2G2*	—	1000	—									
YCAK44A2G2*	—	—	—									1-11/16

* Overlap crimps.

** YRA1CU-1 not recommended for 2 comp. conductor.

† U Die with adapter PT6515.

‡ U Die with adapter PUADP1.

For faster installations use BURNDY® PATRIOT® family of battery tools.