

Lay-In Wireway Type 1 Screw Cover - Painted & Galvanized Data Sheet

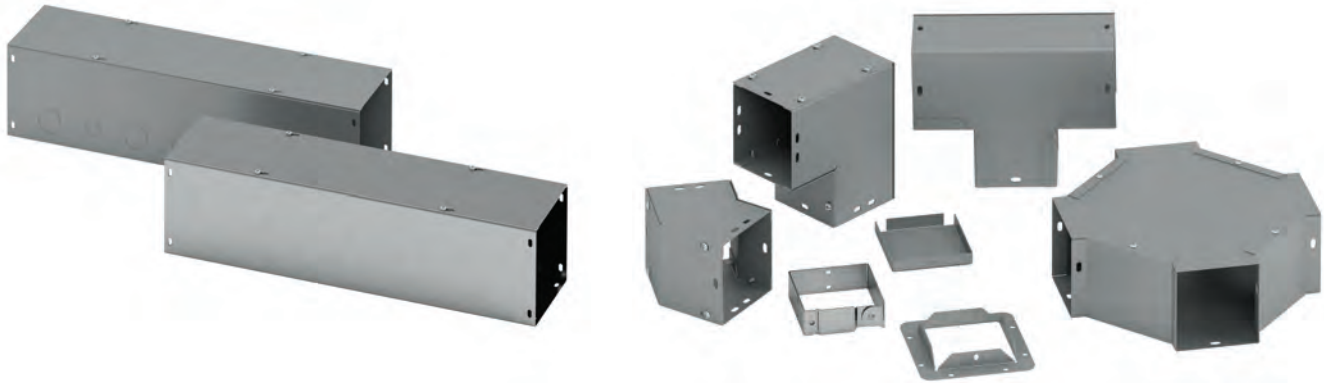

Application

- Houses runs of control and power cable
- Used for cable and wire junction, distribution and termination

Standards

- UL 870 listed, Type 1
- CSA C22.2 No. 26 certified, Type 1
- Conforms to NEMA standard for Type 1

Finish

- Wash and phosphate undercoat or galvanized steel
- ANSI 61 gray acrylic electrocoat finish

Accessories

- Sealing devices
- Touch-up paint
- See Accessories section

Construction

- Wireway body and cover are fabricated from code gauge steel or galvanized steel, (see table, pages 9 & 10)
- Wireway body has mounting holes on the back
- Wireway is available with or without knockouts
- Wireway fittings have no knockouts, ends are available with or without knockouts
- Cover is secured to the body with plated screws
- Keyhole slots are furnished on the wireway cover which allow easy access to the inside without removing the screws
- Wireway exceeding 72 inches in length has two overlapping covers
- Variety of fittings allow runs which can change direction, junction and terminate
- Standard wireway connectors (sold separately) have a gate feature which can swing completely open allowing for lay-in of wire and cable
- Interchangeable with Type 1 Hinge Cover Wireway and Fittings when HSCA connector is used, (see page 17)

Discount Schedule: A2

Subclass: AK1 (painted) & Z40 (galvanized)

Notes: We can provide special sizes, finishes and other modifications. Consult the factory for your special requirements.

Lay-In Wireway Type 1 Screw Cover - Painted & Galvanized Catalog Number

Subclass: Painted - AK1 & Galvanized - Z40

Wireway Catalog Number				Wireway Size				Gauge	Knockout Quantity	
Painted		Galvanized		Height x Depth x Length A x B x C		D			Top	Bottom
KO	No KO	KO	No KO	in.	mm	in.	mm			
2212 G	2212 G NK	--	2212 GGV NK	2.50 x 2.50 x 12.00	64 x 64 x 305	1.25	32	16	3	3
2224 G	2224 G NK	2224 GGV	2224 GGV NK	2.50 x 2.50 x 24.00	64 x 64 x 610	1.25	32	16	7	7
2236 G	2236 G NK	2236 GGV	2236 GGV NK	2.50 x 2.50 x 36.00	64 x 64 x 914	1.25	32	16	11	11
2248 G	2248 G NK	--	2248 GGV NK	2.50 x 2.50 x 48.00	64 x 64 x 1219	1.25	32	16	15	15
2260 G	2260 G NK	2260 GGV	2260 GGV NK	2.50 x 2.50 x 60.00	64 x 64 x 1524	1.25	32	16	23	23
22120 G	22120 G NK	22120 GGV	22120 GGV NK	2.50 x 2.50 x 120.00	64 x 64 x 3048	1.25	32	16	39	39
--	3312 G NK	--	--	3.00 x 3.00 x 12.00	76 x 76 x 305	1.50	38	16	3	3
--	3324 G NK	--	--	3.00 x 3.00 x 24.00	76 x 76 x 610	1.50	38	16	7	7
--	3336 G NK	--	--	3.00 x 3.00 x 36.00	76 x 76 x 914	1.50	38	16	11	11
--	3348 G NK	--	--	3.00 x 3.00 x 48.00	76 x 76 x 1219	1.50	38	16	15	15
--	3360 G NK	--	--	3.00 x 3.00 x 60.00	76 x 76 x 1524	1.50	38	16	19	19
--	3372 G NK	--	--	3.00 x 3.00 x 72.00	76 x 76 x 1829	1.50	38	16	23	23
--	33120 G NK	--	--	3.00 x 3.00 x 120.00	76 x 76 x 3048	1.50	38	16	39	39
4412 G	4412 G NK	4412 GGV	4412 GGV NK	4.00 x 4.00 x 12.00	102 x 102 x 305	2.75	70	16	3	3
4418 G	4418 G NK	--	4418 GGV NK	4.00 x 4.00 x 18.00	102 x 102 x 457	2.75	70	16	5	5
4424 G	4424 G NK	4424 GGV	4424 GGV NK	4.00 x 4.00 x 24.00	102 x 102 x 610	2.75	70	16	7	7
4436 G	4436 G NK	4436 GGV	4436 GGV NK	4.00 x 4.00 x 36.00	102 x 102 x 914	2.75	70	16	11	11
4448 G	4448 G NK	4448 GGV	4448 GGV NK	4.00 x 4.00 x 48.00	102 x 102 x 1219	2.75	70	16	15	15
4460 G	4460 G NK	4460 GGV	4460 GGV NK	4.00 x 4.00 x 60.00	102 x 102 x 1524	2.75	70	16	19	19
4472 G	4472 G NK	4472 GGV	4472 GGV NK	4.00 x 4.00 x 72.00	102 x 102 x 1829	2.75	70	16	23	23
44120 G	44120 G NK	44120 GGV	44120 GGV NK	4.00 x 4.00 x 120.00	102 x 102 x 3048	2.75	70	16	39	39
--	6412 G NK	--	--	6.00 x 4.00 x 12.00	152 x 102 x 305	4.25	108	16	3	3
--	6418 G NK	--	--	6.00 x 4.00 x 18.00	152 x 102 x 457	4.25	108	16	5	5
--	6424 G NK	--	--	6.00 x 4.00 x 24.00	152 x 102 x 610	4.25	108	16	7	7
--	6436 G NK	--	--	6.00 x 4.00 x 36.00	152 x 102 x 914	4.25	108	16	11	11
--	6448 G NK	--	--	6.00 x 4.00 x 48.00	152 x 102 x 1219	4.25	108	16	15	15
--	6460 G NK	--	--	6.00 x 4.00 x 60.00	152 x 102 x 1524	4.25	108	16	19	19
--	6472 G NK	--	--	6.00 x 4.00 x 72.00	152 x 102 x 1829	4.25	108	16	23	23
--	64120 G NK	--	--	6.00 x 4.00 x 120.00	152 x 102 x 3048	4.25	108	16	39	39
6612 G	6612 G NK	6612 GGV	6612 GGV NK	6.00 x 6.00 x 12.00	152 x 152 x 305	4.25	108	16	3	3
6618 G	6618 G NK	--	6618 GGV NK	6.00 x 6.00 x 18.00	152 x 152 x 457	4.25	108	16	5	5
6624 G	6624 G NK	6624 GGV	6624 GGV NK	6.00 x 6.00 x 24.00	152 x 152 x 610	4.25	108	16	7	7
6636 G	6636 G NK	6636 GGV	6636 GGV NK	6.00 x 6.00 x 36.00	152 x 152 x 914	4.25	108	16	11	11
6648 G	6648 G NK	6648 GGV	6648 GGV NK	6.00 x 6.00 x 48.00	152 x 152 x 1219	4.25	108	16	15	15
6660 G	6660 G NK	6660 GGV	6660 GGV NK	6.00 x 6.00 x 60.00	152 x 152 x 1524	4.25	108	16	19	19
6672 G	6672 G NK	6672 GGV	6672 GGV NK	6.00 x 6.00 x 72.00	152 x 152 x 1829	4.25	108	16	23	23
66120 G	66120 G NK	66120 GGV	66120 GGV NK	6.00 x 6.00 x 120.00	152 x 152 x 3048	4.25	108	16	39	39
8812 G	8812 G NK	8812 GGV	8812 GGV NK	8.00 x 8.00 x 12.00	203 x 203 x 305	6.00	152	14	3	3
8818 G	8818 G NK	--	8818 GGV NK	8.00 x 8.00 x 18.00	203 x 203 x 457	6.00	152	14	5	5
8824 G	8824 G NK	8824 GGV	8824 GGV NK	8.00 x 8.00 x 24.00	203 x 203 x 610	6.00	152	14	7	7
8836 G	8836 G NK	8836 GGV	8836 GGV NK	8.00 x 8.00 x 36.00	203 x 203 x 914	6.00	152	14	11	11
8848 G	8848 G NK	8848 GGV	8848 GGV NK	8.00 x 8.00 x 48.00	203 x 203 x 1219	6.00	152	14	15	15
8860 G	8860 G NK	8860 GGV	8860 GGV NK	8.00 x 8.00 x 60.00	203 x 203 x 1524	6.00	152	14	19	19
8872 G	8872 G NK	8872 GGV	8872 GGV NK	8.00 x 8.00 x 72.00	203 x 203 x 1829	6.00	152	14	23	23
88120 G	88120 G NK	88120 GGV	88120 GGV NK	8.00 x 8.00 x 120.00	203 x 203 x 3048	6.00	152	14	39	39

See page 10 for 10"x10" and 12"x12" wireway.

Notes: Dimensions are in inches. Millimeters shown are for reference only. Data subject to change without notice.

Cable & Wire Management

Lay-In Wireway Type 1 Screw Cover - Painted & Galvanized Illustration Sheet and Catalog Number

Subclass: Painted - AK1 & Galvanized - Z40

Wireway Catalog Number				Wireway Size			D		Knockout Quantity	
Painted		Galvanized		Height x Depth x Length Ax B x C		in.	mm	Gauge	Top	Bottom
KO	No KO	KO	No KO	in.	mm					
101012 G	101012 G NK	--	101012 GGV NK	10.00 x 10.00 x 12.00	254 x 254 x 305	8.00	203	14	3	3
101024 G	101024 G NK	--	101024 GGV NK	10.00 x 10.00 x 24.00	254 x 254 x 610	8.00	203	14	7	7
101036 G	101036 G NK	--	101036 GGV NK	10.00 x 10.00 x 36.00	254 x 254 x 914	8.00	203	14	11	11
101048 G	101048 G NK	--	101048 GGV NK	10.00 x 10.00 x 48.00	254 x 254 x 1219	8.00	203	14	15	15
101060 G	101060 G NK	--	101060 GGV NK	10.00 x 10.00 x 60.00	254 x 254 x 1524	8.00	203	14	19	19
101072 G	101072 G NK	--	101072 GGV NK	10.00 x 10.00 x 72.00	254 x 254 x 1829	8.00	203	14	23	23
1010120 G	1010120 G NK	--	1010120 GGV NK	10.00 x 10.00 x 120.00	254 x 254 x 3048	8.00	203	14	39	39
121212 G	121212 G NK	--	121212 GGV NK	12.00 x 12.00 x 12.00	305 x 305 x 305	10.00	254	14	3	3
121224 G	121224 G NK	--	121224 GGV NK	12.00 x 12.00 x 24.00	305 x 305 x 610	10.00	254	14	7	7
121236 G	121236 G NK	--	121236 GGV NK	12.00 x 12.00 x 36.00	305 x 305 x 914	10.00	254	14	11	11
121248 G	121248 G NK	--	121248 GGV NK	12.00 x 12.00 x 48.00	305 x 305 x 1219	10.00	254	14	15	15
121260 G	121260 G NK	--	121260 GGV NK	12.00 x 12.00 x 60.00	305 x 305 x 1524	10.00	254	14	19	19
121272 G	121272 G NK	--	121272 GGV NK	12.00 x 12.00 x 72.00	305 x 305 x 1829	10.00	254	14	23	23
1212120 G	1212120 G NK	--	1212120 GGV NK	12.00 x 12.00 x 120.00	305 x 305 x 3048	10.00	254	14	39	39

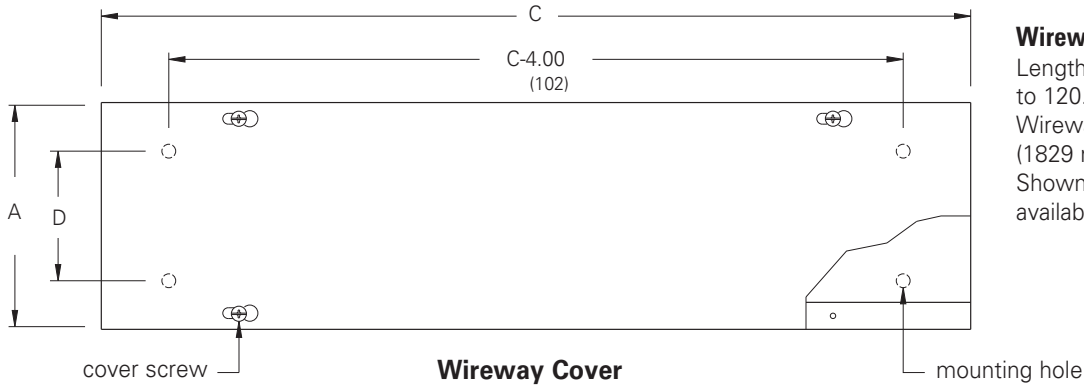

Wireway Section

Lengths from 12.00" (305 mm) to 120.00" (3048 mm). Wireway exceeding 72.00" (1829 mm) has two covers. Shown with KO's, also available without.

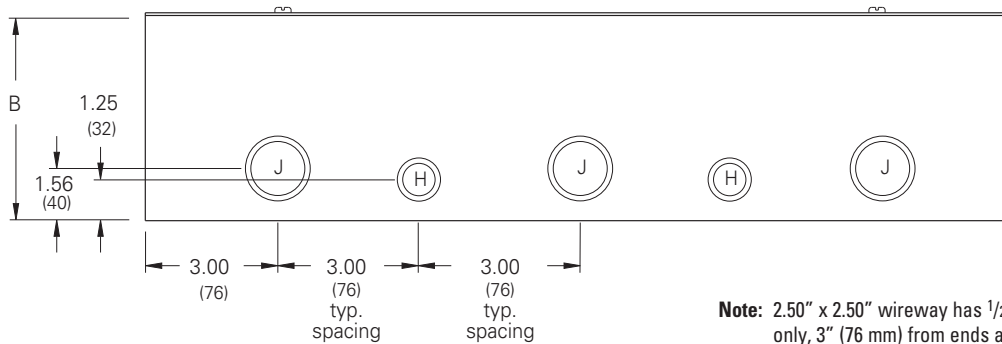

Knockout sizes:
H = 3/4" or 1/2" conduit
J = 1 1/4" or 1" conduit

Note: 2.50" x 2.50" wireway has 1/2" and 3/4" 2-way knockouts (H) only, 3" (76 mm) from ends and 3" (76 mm) on center. Additional mounting holes are furnished when C dimension is over 60.00" (1524 mm).

Notes: Dimensions are in inches. Millimeters shown are for reference only. Data subject to change without notice.

Lay-In Wireway Type 1 Screw Cover - Painted & Galvanized Illustration Sheet and Catalog Number

Subclass: Painted - AK1 & Galvanized - Z40

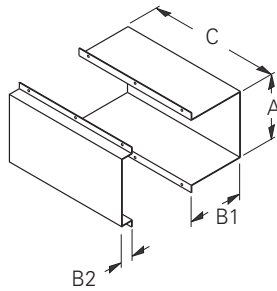

Telescopic Fitting

Adjustable length up to 10.00" (254 mm). Wraps around the two near joining wireway lengths to achieve a continuous run.

End

Used to terminate wireway or fitting. 2.50" x 2.50" (64 mm x 64 mm) through 8.00" x 8.00" (203 mm x 203 mm) ends have a 1.50"-1.25" concentric 2-way KO. 10.00" x 10.00" (254 mm x 254 mm) ends and larger have a 3.00" - 2.50" concentric 2-way KO for terminating on pipe or conduit. Also available without KO.

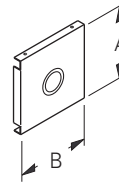

Telescopic Fitting

Catalog Number		A		B1		B2		C	
Painted	Galvanized	in.	mm	in.	mm	in.	mm	in.	mm
22 FTF	22 FTFGV	2.75	70	1.75	44	1.12	28	12.00	305
33 FTF	--	3.25	83	2.25	57	1.12	28	12.00	305
44 FTF	44 FTFGV	4.25	108	3.25	83	1.12	28	12.00	305
64 FTF	--	6.25	159	3.25	83	1.12	28	12.00	305
66 FTF	66 FTFGV	6.25	159	5.25	133	1.12	28	12.00	305
88 FTF	88 FTFGV	8.25	210	7.25	184	1.12	28	12.00	305
1010 FTF	1010 FTFGV	10.25	260	9.25	235	1.12	28	12.00	305
1212 FTF	1212 FTFGV	12.25	311	11.25	286	1.12	28	12.00	305

End

Catalog Number				A		B		
KO	Painted		Galvanized		in.	mm	in.	mm
	No KO	KO	No KO	KO				
22 E	22 E NK	22 EGV	22 EGV NK	2.50	64	2.50	64	
33 E	33 E NK	--	--	3.00	76	3.00	76	
44 E	44 E NK	44 EGV	44 EGV NK	4.00	102	4.00	102	
64 E	64 E NK	--	--	6.00	152	4.00	102	
66 E	66 E NK	66 EGV	66 EGV NK	6.00	152	6.00	152	
88 E	88 E NK	88 EGV	88 EGV NK	8.00	203	8.00	203	
1010 E	1010 E NK	1010 EGV	1010 EGV NK	10.00	254	10.00	254	
1212 E	1212 E NK	1212 EGV	1212 EGV NK	12.00	305	12.00	305	

See drawing for KO sizes.

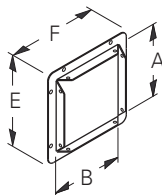

Wireway End Flange

Allows for a secure connection of wireway to an adjoining enclosure or wall.

Connector

Swing gate allows for lay-in of wire and cable.

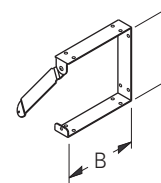

Wireway End Flange

Catalog Number		A		B		E		F	
Painted	Galvanized	in.	mm	in.	mm	in.	mm	in.	mm
22 GF	22 GFGV	2.50	64	2.50	64	4.00	102	4.00	102
33 GF	--	3.00	76	3.00	76	4.50	114	4.50	114
44 GF	44 GFGV	4.00	102	4.00	102	5.50	140	5.50	140
64 GF	--	6.00	152	4.00	102	7.50	191	5.50	140
66 GF	66 GFGV	6.00	152	6.00	152	7.50	191	7.50	191
88 GF	88 GFGV	8.00	203	8.00	203	9.50	241	9.50	241
1010 GF	1010 GFGV	10.00	254	10.00	254	11.50	292	11.50	292
1212 GF	1212 GFGV	12.00	305	12.00	305	13.50	343	13.50	343

Connector

Catalog Number	A		B	
Galvanized	in.	mm	in.	mm
22 C	2.50	64	2.50	64
33 C	3.00	76	3.00	76
44 C	4.00	102	4.00	102
64 C	6.00	152	4.00	102
66 C	6.00	152	6.00	152
88 C	8.00	203	8.00	203
1010 C	10.00	254	10.00	254
1212 C	12.00	305	12.00	305

Notes: Dimensions are in inches. Millimeters shown are for reference only. Data subject to change without notice.

Cable & Wire Management

Lay-In Wireway Type 1 Screw Cover - Painted & Galvanized Illustration Sheet and Catalog Number

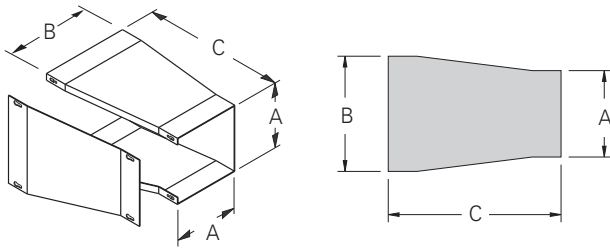

Reducer

B dimensions (see catalog table), correspond to the large end opening. Used to reduce or enlarge wireway runs.

Catalog Number		A		B		C	
Painted	Galvanized	in.	mm	in.	mm	in.	mm
2233 FR	--	2.50	64	3.00	76	6.00	152
3344 FR	--	3.00	76	4.00	102	8.00	203
4466 FR	--	4.00	102	6.00	152	10.00	254
6688 FR	--	6.00	152	8.00	203	12.00	305
881010 FR	--	8.00	203	10.00	254	12.00	305
10101212 FR	--	10.00	254	12.00	305	16.00	406

Wireway Hangers

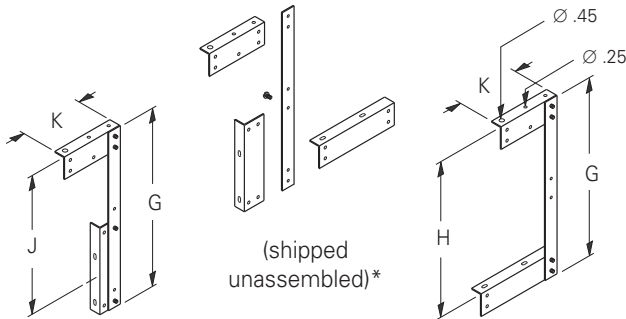

Side Cover Assembly

For those installations where the wireway cover must be removed from the side.

Top Cover Assembly

For those installations where the wireway cover must be removed from the top.

Catalog Number		G		H		J		K	
Painted	Galvanized	in.	mm	in.	mm	in.	mm	in.	mm
22 FH	--	8.50	216	6.50	165	6.50	165	2.87	73
33 FH	--	10.50	267	8.50	216	9.00	229	3.87	98
44 FH	--	12.50	318	10.50	267	10.37	263	4.87	124
66 FH	--	16.50	419	14.50	368	13.50	343	5.87	149
88 FH	--	20.50	521	18.50	470	16.75	425	6.87	174
1010 FH*	--	24.50	622	22.50	572	19.75	502	7.87	200
1212 FH*	--	28.50	724	26.50	673	22.75	578	8.87	225

*Hangers are shipped welded in the top cover assembly position.

Subclass: Painted - AK1 & Galvanized - Z40

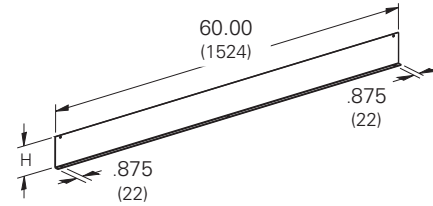

Barrier, Bolt-On

For those installations that require separated wiring compartments.

Barrier Kit, 60" Bolt-On

Catalog Number	Size		Length		H	
	in.	mm	in.	mm	in.	mm
22-12BK*	2.50 x 2.50	64 x 64	60.00	1524	1.88	48
33-12BK*	3.00 x 3.00	76 x 76	60.00	1524	2.25	57
44-12BK*	4.00 x 4.00	102 x 102	60.00	1524	3.00	76
66-12BK*	6.00 x 6.00	152 x 152	60.00	1524	4.50	114
88-12BK*	8.00 x 8.00	203 x 203	60.00	1524	6.00	152
1010-12BK*	10.00 x 10.00	254 x 254	60.00	1524	8.00	203
1212-12BK*	12.00 x 12.00	305 x 305	60.00	1524	10.50	267

*Not UL or CSA listed fitting.

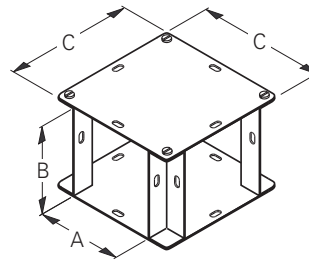

90° Elbow-Tee-Cross

Designed for left or right 90° turns or as a tee or cross by removing closure plates. Includes two (2) closure plates and hardware.

90° Elbow - Tee - Cross

Catalog Number		A		B		C	
Painted	Galvanized	in.	mm	in.	mm	in.	mm
22 LTX	22 LTXGV	2.50	64	2.50	64	4.50	114
33 LTX	--	3.00	76	3.00	76	5.00	127
44 LTX	44 LTXGV	4.00	102	4.00	102	6.00	152
64 LTX	--	6.00	152	4.00	102	8.00	203
66 LTX	66 LTXGV	6.00	152	6.00	152	8.00	203
88 LTX	88 LTXGV	8.00	203	8.00	203	10.00	254
1010 LTX	1010 LTXGV	10.00	254	10.00	254	12.00	305
1212 LTX	1212 LTXGV	12.00	305	12.00	305	14.00	356

Notes: Dimensions are in inches. Millimeters shown are for reference only. Data subject to change without notice.

Lay-In Wireway Type 1 - Painted & Galvanized Illustration Sheet and Catalog Number

**Wireway 90° Elbows
Screw Cover**

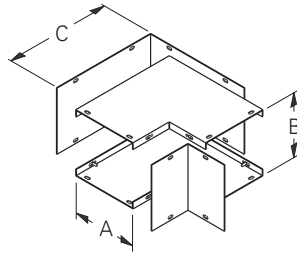
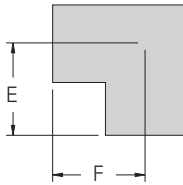

Combo Opening

Specially designed for removing either the inside or outside cover to allow a continuous run with 90° turns.

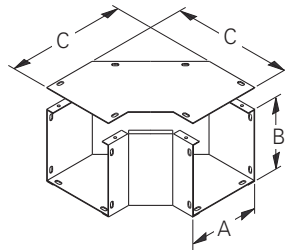
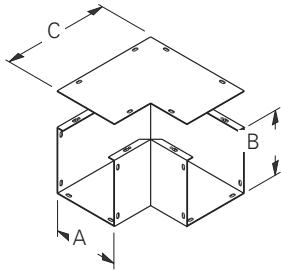

Side Opening

Side cover is removable to allow a continuous run on designs with 90° turns.

Sweep Elbow

Side cover design with a larger radius for 90° sweeping turns.

**Wireway 90° Elbows
Hinged Cover**

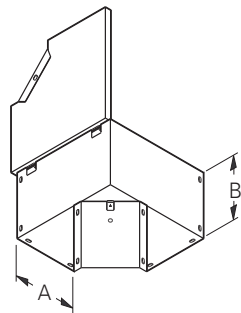
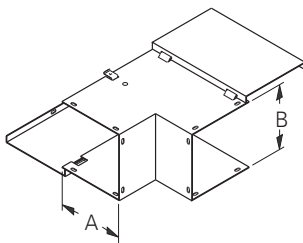

Outside Opening

Specifically designed to have the outside covers hinge open to allow a continuous run with 90° turns.

Side Opening

Side cover is hinged to allow a continuous run on designs with 90° sweeping turns.

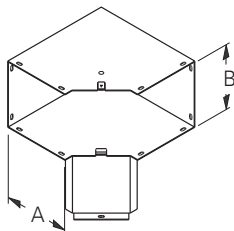

Inside Opening

Specifically designed to have only the inside cover hinge open to allow a continuous run with 90° turns.

Subclass: Painted - AK1 & Galvanized - Z40

90° Elbow - Screw Cover

Catalog Number		A		B		C		E		F	
Painted	Galvanized	in.	mm	in.	mm	in.	mm	in.	mm	in.	mm
22 L COMBO	22 L COMBOGV	2.50	64	2.50	64	5.59	142	4.28	109	4.28	109
33 L COMBO	--	3.00	76	3.00	76	6.09	155	4.50	114	4.50	114
44 L COMBO	44 L COMBOGV	4.00	102	4.00	102	7.09	180	5.00	127	5.00	127
64 L COMBO	--	4.00	102	6.00	152	10.09	256	5.00	127	5.00	127
66 L COMBO	66 L COMBOGV	6.00	152	6.00	152	10.09	256	7.00	178	7.00	178
88 L COMBO	88 L COMBOGV	8.00	203	8.00	203	12.09	307	8.00	203	8.00	203
1010 L COMBO	1010 L COMBOGV	10.00	254	10.00	254	14.09	358	9.00	229	9.00	229
1212 L COMBO	1212 L COMBOGV	12.00	305	12.00	305	16.09	409	10.00	254	10.00	254
22 L SIDE	--	2.50	64	2.50	64	5.59	142	4.28	109	4.28	109
33 L SIDE	--	3.00	76	3.00	76	6.09	155	4.50	114	4.50	114
44 L SIDE	--	4.00	102	4.00	102	7.09	180	5.00	127	5.00	127
64 L SIDE	--	6.00	152	4.00	102	10.09	256	7.00	178	7.00	178
66 L SIDE	--	6.00	152	6.00	152	10.09	256	7.00	178	7.00	178
88 L SIDE	--	8.00	203	8.00	203	12.09	307	8.00	203	8.00	203
1010 L SIDE	--	10.00	254	10.00	254	14.09	358	10.00	254	9.00	229
1212 L SIDE	--	12.00	305	12.00	305	16.09	409	10.00	254	10.00	254
22 L SWEEP	22 L SWEEPGV	2.50	64	2.50	64	5.63	143	4.25	108	4.25	108
33 L SWEEP	--	3.00	76	3.00	76	8.41	214	6.84	174	6.84	174
44 L SWEEP	44 L SWEEPGV	4.00	102	4.00	102	9.41	239	7.34	186	7.34	186
64 L SWEEP	--	6.00	152	4.00	102	11.41	290	8.34	212	8.34	212
66 L SWEEP	66 L SWEEPGV	6.00	152	6.00	152	11.41	290	8.34	212	8.34	212
88 L SWEEP	88 L SWEEPGV	8.00	203	8.00	203	13.41	341	9.34	237	9.34	237
1010 L SWEEP	1010 L SWEEPGV	10.00	254	10.00	254	15.41	391	10.34	263	10.34	263
1212 L SWEEP	1212 L SWEEPGV	12.00	305	12.00	305	17.41	442	11.34	288	11.34	288

90° Elbow - Hinged Cover

Catalog Number		A		B		E		F	
Painted		in.	mm	in.	mm	in.	mm	in.	mm
33 FL IN		3.00	76	3.00	76	5.50	140	5.50	140
44 FL IN		4.00	102	4.00	102	6.00	152	6.00	152
66 FL IN		6.00	152	6.00	152	7.00	178	7.00	178
88 FL IN		8.00	203	8.00	203	8.00	203	8.00	203
1010 FL IN		10.00	254	10.00	254	9.00	229	9.00	229
1212 FL IN		12.00	305	12.00	305	10.00	254	10.00	254
33 FL OUT		3.00	76	3.00	76	5.50	140	5.50	140
44 FL OUT		4.00	102	4.00	102	6.00	152	6.00	152
66 FL OUT		6.00	152	6.00	152	7.00	178	7.00	178
88 FL OUT		8.00	203	8.00	203	8.00	203	8.00	203
1010 FL OUT		10.00	254	10.00	254	9.00	229	9.00	229
1212 FL OUT		12.00	305	12.00	305	10.00	254	10.00	254
33 FL SIDE		3.00	76	3.00	76	5.50	140	5.50	140
44 FL SIDE		4.00	102	4.00	102	6.00	152	6.00	152
66 FL SIDE		6.00	152	6.00	152	7.00	178	7.00	178
88 FL SIDE		8.00	203	8.00	203	8.00	203	8.00	203
1010 FL SIDE		10.00	254	10.00	254	9.00	229	9.00	229
1212 FL SIDE		12.00	305	12.00	305	10.00	254	10.00	254

Notes: Dimensions are in inches. Millimeters shown are for reference only. Data subject to change without notice.

Lay-In Wireway Type 1 Screw Cover - Painted & Galvanized Illustration Sheet and Catalog Number

Subclass: Painted - AK1 & Galvanized - Z40

Wireway 45° Elbows

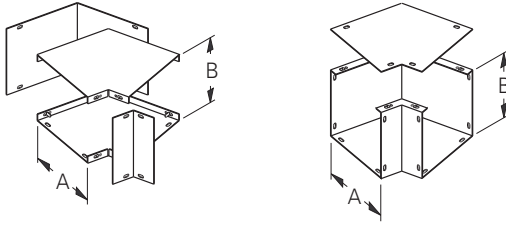

Combo Opening

Similar to the 90° elbow design except a 45° turn. Both inside and outside covers removable.

Side Opening

Similar to the 90° side opening design except for a 45° turn. Excellent for combining two to make a gradual sweeping 90° turn.

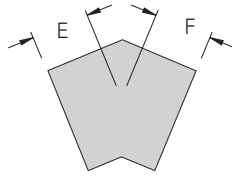

Tee

Side cover design where a "T" junction is necessary.

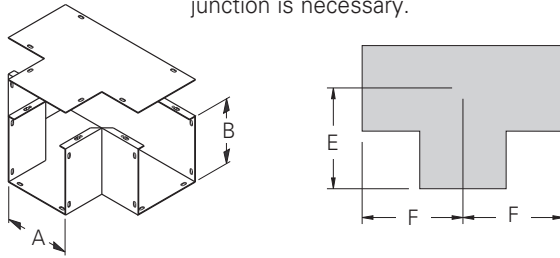

Cross

Side cover and broad body design to junction cable run in four directions.

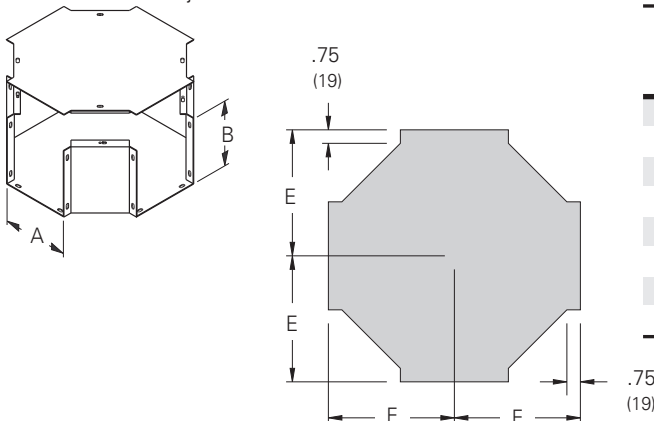

45° Elbow

Catalog Number		A		B		E		F	
Painted	Galvanized	in.	mm	in.	mm	in.	mm	in.	mm
2245 L COMBO	2245 L COMBOGV	2.50	64	2.50	64	1.72	44	1.72	44
3345 L COMBO	--	3.00	76	3.00	76	2.56	65	2.56	65
4445 L COMBO	4445 L COMBOGV	4.00	102	4.00	102	2.75	70	2.75	70
6445 L COMBO	--	4.00	102	6.00	153	2.75	70	2.75	70
6645 L COMBO	6645 L COMBOGV	6.00	153	6.00	153	3.18	81	3.18	81
8845 L COMBO	8845 L COMBOGV	8.00	203	8.00	203	3.62	92	3.62	92
101045 L COMBO	101045 L COMBOGV	10.00	254	10.00	254	4.06	103	4.06	103
121245 L COMBO	121245 L COMBOGV	12.00	305	12.00	305	4.50	114	4.50	114
2245 L SIDE	--	2.50	64	2.50	64	1.97	50	1.97	50
3345 L SIDE	--	3.00	76	3.00	76	2.56	65	2.56	65
4445 L SIDE	--	4.00	102	4.00	102	2.75	70	2.75	70
6445 L SIDE	--	6.00	153	4.00	102	3.18	81	3.18	81
6645 L SIDE	--	6.00	153	6.00	153	3.18	81	3.18	81
8845 L SIDE	--	8.00	203	8.00	203	3.62	92	3.62	92
101045 L SIDE	--	10.00	254	10.00	254	4.06	103	4.06	103
121245 L SIDE	--	12.00	305	12.00	305	4.50	114	4.50	114

Tee

Catalog Number		A		B		E		F	
Painted	Galvanized	in.	mm	in.	mm	in.	mm	in.	mm
22 T	22 TGV	2.50	64	2.50	64	4.25	108	4.25	108
33 T	--	3.00	76	3.00	76	4.50	114	4.50	114
44 T	44 TGV	4.00	102	4.00	102	5.00	127	5.00	127
64 T	--	6.00	153	4.00	102	7.00	178	7.00	178
66 T	66 TGV	6.00	153	6.00	153	7.00	178	7.00	178
88 T	88 TGV	8.00	203	8.00	203	8.00	203	8.00	203
1010 T	1010 TGV	10.00	254	10.00	254	9.00	229	9.00	229
1212 T	1212 TGV	12.00	305	12.00	305	10.00	254	10.00	254

Cross

Catalog Number		A		B		E		F	
Painted	Galvanized	in.	mm	in.	mm	in.	mm	in.	mm
22 X	22 XGV	2.50	64	2.50	64	4.25	108	4.25	108
33 X	--	3.00	76	3.00	76	5.62	143	5.62	143
44 X	44 XGV	4.00	102	4.00	102	6.12	155	6.12	155
64 X	--	6.00	152	4.00	102	7.12	181	7.12	181
66 X	66 XGV	6.00	152	6.00	152	7.12	181	7.12	181
88 X	88 XGV	8.00	203	8.00	203	8.12	206	8.12	206
1010 X	1010 XGV	10.00	254	10.00	254	9.12	232	9.12	232
1212 X	1212 XGV	12.00	305	12.00	305	10.12	257	10.12	257

Notes: Dimensions are in inches. Millimeters shown are for reference only. Data subject to change without notice.

Lay-In Wireway Type 1 Quick-Connect Hinge Cover Data Sheet

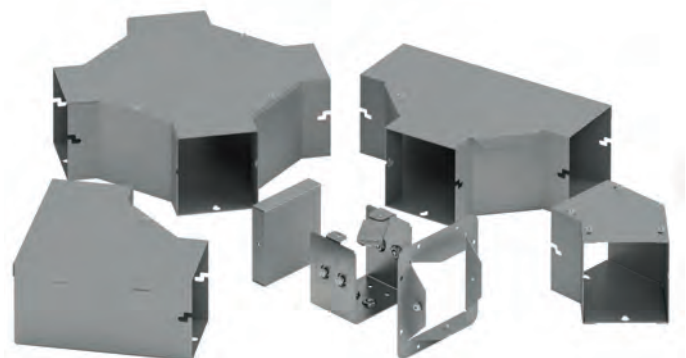
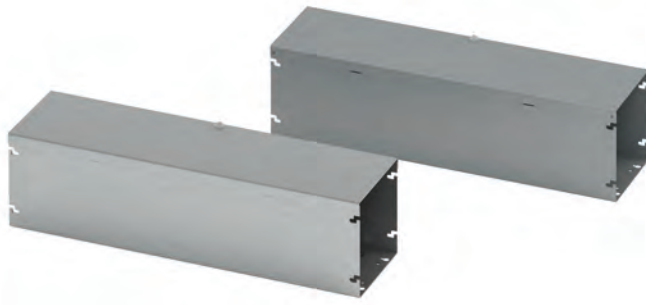

Reversible and removable hinge cover



Pre-installed hardware on quick connector

Application

- Houses runs of control and power cable
- Used for cable and wire junction, distribution and termination

Standards

- UL 870 listed, Type 1
- CSA C22.2 No. 26 certified, Type 1
- Conforms to NEMA standard for Type 1

Finish

- Wash and phosphate undercoat
- ANSI 61 gray acrylic electrocoat finish

Accessories

- Touch-up paint
- See Accessories section

Protected by U.S. Patents 7,525,044 & 7,762,042

Construction

- Wireway body and cover are fabricated from code gauge steel, (see table, page 16)
- Wireway body has mounting holes on the back
- Wireway is available with or without knockouts
- Wireway fittings have no knockouts, ends are available with or without knockouts
- Wireway exceeding 72 inches in length has two overlapping covers
- Variety of fittings allow runs which can change directions, junction and terminate
- Wireway connectors (sold separately) have a gate feature which can swing completely open allowing for lay-in of wire and cable
- Universal style connectors are also available for adapting to other manufacturer's wireway, (see page 17)
- Except for wireway ends, completely interchangeable with Type 1 screw cover wireway and fittings through use of the adapter style connector HSCA, (see page 17)

Discount Schedule: A2

Subclass: HS1

Notes: We can provide special sizes, finishes and other modifications. Consult the factory for your special requirements.

Lay-In Wireway Type 1 Quick-Connect Hinge Cover Illustration Sheet and Catalog Number

Subclass: HS1

Wireway Catalog Number		Wireway Size Height x Depth x Length		D		Gauge	Knockout Quantity	
KO	No KO	A x B x C		in.	mm		Top	Bottom
2212 HS	2212 HS NK	2.50 x 2.50 x 12.00	63 x 63 x 305	1.25	32	16	3	3
2224 HS	2224 HS NK	2.50 x 2.50 x 24.00	63 x 63 x 610	1.25	32	16	7	7
2236 HS	2236 HS NK	2.50 x 2.50 x 36.00	63 x 63 x 914	1.25	32	16	11	11
2248 HS	2248 HS NK	2.50 x 2.50 x 48.00	63 x 63 x 1219	1.25	32	16	15	15
2260 HS	2260 HS NK	2.50 x 2.50 x 60.00	63 x 63 x 1524	1.25	32	16	19	19
2272 HS	2272 HS NK	2.50 x 2.50 x 72.00	63 x 63 x 1829	1.25	32	16	23	23
22120 HS	22120 HS NK	2.50 x 2.50 x 120.00	63 x 63 x 3048	1.25	32	16	39	39
4412 HS	4412 HS NK	4.00 x 4.00 x 12.00	102 x 102 x 305	2.75	70	16	3	3
4424 HS	4424 HS NK	4.00 x 4.00 x 24.00	102 x 102 x 610	2.75	70	16	7	7
4436 HS	4436 HS NK	4.00 x 4.00 x 36.00	102 x 102 x 914	2.75	70	16	11	11
4448 HS	4448 HS NK	4.00 x 4.00 x 48.00	102 x 102 x 1219	2.75	70	16	15	15
4460 HS	4460 HS NK	4.00 x 4.00 x 60.00	102 x 102 x 1524	2.75	70	16	19	19
4472 HS	4472 HS NK	4.00 x 4.00 x 72.00	102 x 102 x 1829	2.75	70	16	23	23
44120 HS	44120 HS NK	4.00 x 4.00 x 120.00	102 x 102 x 3048	2.75	70	16	39	39
6612 HS	6612 HS NK	6.00 x 6.00 x 12.00	152 x 152 x 305	4.25	108	16	3	3
6624 HS	6624 HS NK	6.00 x 6.00 x 24.00	152 x 152 x 610	4.25	108	16	7	7
6636 HS	6636 HS NK	6.00 x 6.00 x 36.00	152 x 152 x 914	4.25	108	16	11	11
6648 HS	6648 HS NK	6.00 x 6.00 x 48.00	152 x 152 x 1219	4.25	108	16	15	15
6660 HS	6660 HS NK	6.00 x 6.00 x 60.00	152 x 152 x 1524	4.25	108	16	19	19
6672 HS	6672 HS NK	6.00 x 6.00 x 72.00	152 x 152 x 1829	4.25	108	16	23	23
66120 HS	66120 HS NK	6.00 x 6.00 x 120.00	152 x 152 x 3048	4.25	108	16	39	39
8812 HS	8812 HS NK	8.00 x 8.00 x 12.00	203 x 203 x 305	6.00	152	14	3	3
8824 HS	8824 HS NK	8.00 x 8.00 x 24.00	203 x 203 x 610	6.00	152	14	7	7
8836 HS	8836 HS NK	8.00 x 8.00 x 36.00	203 x 203 x 914	6.00	152	14	11	11
8848 HS	8848 HS NK	8.00 x 8.00 x 48.00	203 x 203 x 1219	6.00	152	14	15	15
8860 HS	8860 HS NK	8.00 x 8.00 x 60.00	203 x 203 x 1524	6.00	152	14	19	19
8872 HS	8872 HS NK	8.00 x 8.00 x 72.00	203 x 203 x 1829	6.00	152	14	23	23
88120 HS	88120 HS NK	8.00 x 8.00 x 120.00	203 x 203 x 3048	6.00	152	14	39	39
101012 HS	101012 HS NK	10.00 x 10.00 x 12.00	254 x 254 x 305	8.00	203	14	3	3
101024 HS	101024 HS NK	10.00 x 10.00 x 24.00	254 x 254 x 610	8.00	203	14	7	7
101036 HS	101036 HS NK	10.00 x 10.00 x 36.00	254 x 254 x 914	8.00	203	14	11	11
101048 HS	101048 HS NK	10.00 x 10.00 x 48.00	254 x 254 x 1219	8.00	203	14	15	15
101060 HS	101060 HS NK	10.00 x 10.00 x 60.00	254 x 254 x 1524	8.00	203	14	19	19
1010120 HS	1010120 HS NK	10.00 x 10.00 x 120.00	254 x 254 x 3048	8.00	203	14	39	39
121212 HS	121212 HS NK	12.00 x 12.00 x 12.00	305 x 305 x 305	10.00	254	14	3	3
121224 HS	121224 HS NK	12.00 x 12.00 x 24.00	305 x 305 x 610	10.00	254	14	7	7
121236 HS	121236 HS NK	12.00 x 12.00 x 36.00	305 x 305 x 914	10.00	254	14	11	11
121248 HS	121248 HS NK	12.00 x 12.00 x 48.00	305 x 305 x 1219	10.00	254	14	15	15
121260 HS	121260 HS NK	12.00 x 12.00 x 60.00	305 x 305 x 1524	10.00	254	14	19	19
1212120 HS	1212120 HS NK	12.00 x 12.00 x 120.00	305 x 305 x 3048	10.00	254	14	39	39

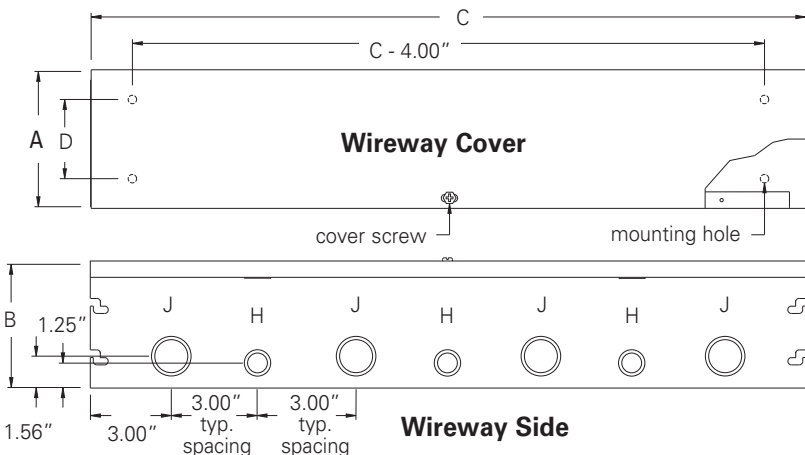

Wireway Section

Lengths from 12.00" (305 mm) to 120.00" (305 mm). Wireway exceeding 72.00" (1829 mm) has two covers. Shown with KO's, also available without.

Knockout sizes:
H = 3/4" or 1/2" conduit
J = 1 1/4" or 1" conduit

Notes: Additional mounting holes are furnished when C dimension is over 60.00" (1524 mm).

Dimensions are in inches. Millimeters shown are for reference only. Data subject to change without notice.

Lay-In Wireway Type 1 Quick-Connect Hinge Cover Illustration Sheet and Catalog Number

Subclass: HS1

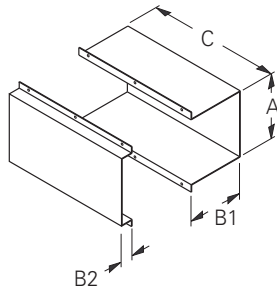

Telescopic Fitting

Adjustable length up to 10.00" (254 mm). Wraps around the two near joining wireway lengths to achieve a continuous run.

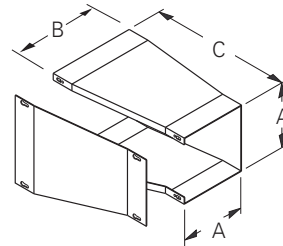

Reducer

B dimensions (see catalog table), correspond to the large end opening. Used to reduce or enlarge wireway runs. Removable cover is secured with screws.

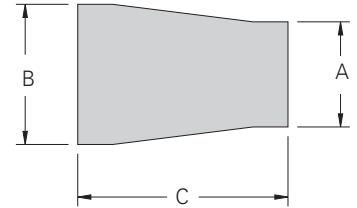

Telescopic Fitting

Catalog Number	A		B1		B2		C	
	in.	mm	in.	mm	in.	mm	in.	mm
22 FTF	2.75	70	1.75	44	1.12	28	12.00	305
33FTF	3.25	83	2.25	57	1.12	28	12.00	305
44 FTF	4.25	108	3.25	83	1.12	28	12.00	305
66 FTF	6.25	159	5.25	133	1.12	28	12.00	305
88 FTF	8.25	210	7.25	184	1.12	28	12.00	305
1010 FTF	10.25	260	9.25	235	1.12	28	12.00	305
1212 FTF	12.25	311	11.25	286	1.12	28	12.00	305

Reducer

Catalog Number	A		B		C	
	in.	mm	in.	mm	in.	mm
2233 FR *	2.50	63	3.00	76	6.00	152
3344 FR *	3.00	76	4.00	102	8.00	203
4466 FR *	4.00	102	6.00	152	10.00	254
6688 FR *	6.00	152	8.00	203	12.00	305
881010 FR *	8.00	203	10.00	254	12.00	305
10101212 FR *	10.00	254	12.00	305	16.00	406

* Requires use of HSCA Adapter Style Connector.

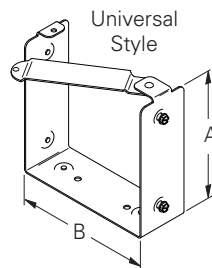
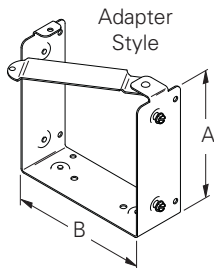
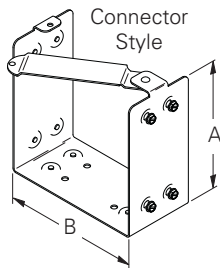

Connector

Swing gate allows for lay-in of wire and cable.

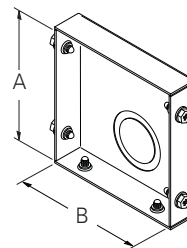

End

Used to terminate wireway or fitting. Shown with KO, also available without.

Drawing shows screws in place. Screws are actually packaged in plastic bags.

Connector

Catalog Number			A		B	
Connector Style	Adapter Style	Universal Style	in.	mm	in.	mm
22 HSC	22 HSCA	22 HSCU	2.50	63	2.50	63
44 HSC	44 HSCA	44 HSCU	4.00	102	4.00	102
66 HSC	66 HSCA	66 HSCU	6.00	152	6.00	152
88 HSC	88 HSCA	88 HSCU	8.00	203	8.00	203
1010 HSC	1010 HSCA	1010 HSCU	10.00	254	10.00	254
1212 HSC	1212 HSCA	1212 HSCU	12.00	305	12.00	305

HSC - Standard Quick Connector
HSCA - For adapting to Type 1 Screw Cover Wireway
HSCU - For adapting to competitive Wireway

End

Catalog Number		A		B		KO	
KO	No KO	in.	mm	in.	mm	in.	mm
22 HSE	22 HSE NK	2.50	63	2.50	63	1.50	38
44 HSE	44 HSE NK	4.00	102	4.00	102	1.50	38
66 HSE	66 HSE NK	6.00	152	6.00	152	1.50	38
88 HSE	88 HSE NK	8.00	203	8.00	203	1.50	38
1010 HSE	1010 HSE NK	10.00	254	10.00	254	3.00	76
1212 HSE	1212 HSE NK	12.00	305	12.00	305	3.00	76

Notes: Dimensions are in inches. Millimeters shown are for reference only. Data subject to change without notice.

Lay-In Wireway Type 1 Quick-Connect Hinge Cover Illustration Sheet and Catalog Number

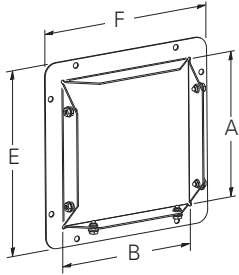

Wireway End Flange

Allows for a secure connection of wireway to an adjoining enclosure or wall.

Wireway End Flange

Catalog Number	A		B		E		F	
	in.	mm	in.	mm	in.	mm	in.	mm
22 HSF	2.50	63	2.50	63	4.00	102	4.00	102
44 HSF	4.00	102	4.00	102	5.50	140	5.50	140
66 HSF	6.00	152	6.00	152	7.50	191	7.50	191
88 HSF	8.00	203	8.00	203	9.50	241	9.50	241
1010 HSF	10.00	254	10.00	254	11.50	292	11.50	292
1212 HSF	12.00	305	12.00	305	13.50	343	13.50	343

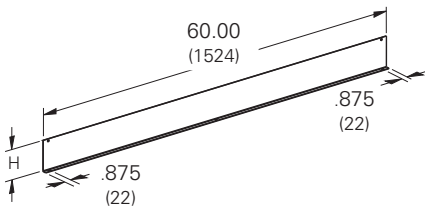

Barrier, Bolt-On

For those installations that require separate wiring compartments.

Barrier Kit, 60" Bolt-On

Catalog Number	Size		Length		H	
	in.	mm	in.	mm	in.	mm
22-12BK*	2.50 x 2.50	64 x 64	60.00	1524	1.88	48
33-12BK*	3.00 x 3.00	76 x 76	60.00	1524	2.25	57
44-12BK*	4.00 x 4.00	102 x 102	60.00	1524	3.00	76
66-12BK*	6.00 x 6.00	152 x 152	60.00	1524	4.50	114
88-12BK*	8.00 x 8.00	203 x 203	60.00	1524	6.00	152
1010-12BK*	10.00 x 10.00	254 x 254	60.00	1524	8.00	203
1212-12BK*	12.00 x 12.00	305 x 305	60.00	1524	10.50	267

*Not UL or CSA listed fitting.

Subclass: HS1

Wireway Hangers

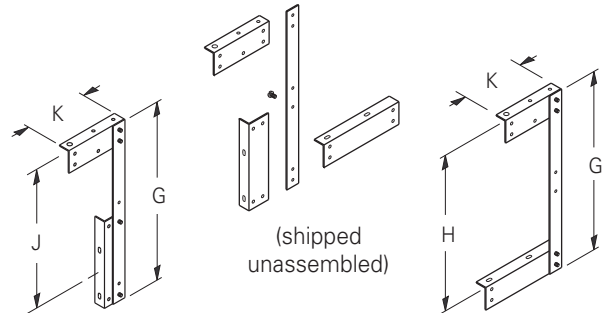

Side Cover Assembly

For those installations where the wireway cover must be hinged at the side.

Top Cover Assembly

For those installations where the wireway cover must be hinged at the top.

Wireway Hanger

Catalog Number	G		H		J		K	
	in.	mm	in.	mm	in.	mm	in.	mm
22 FH	8.50	216	8.50	216	6.50	165	2.87	73
44 FH	12.50	318	10.50	267	10.37	263	4.87	121
66 FH	16.50	419	14.50	394	13.50	340	5.87	146
88 FH	20.50	521	18.50	495	16.75	425	6.87	171
1010 FH **	24.50	622	22.50	571	17.25	438	7.87	200
1212 FH **	28.50	724	26.50	673	20.25	514	8.87	225

** Hangers are shipped welded in the top cover assembly position.

Notes: Dimensions are in inches. Millimeters shown are for reference only. Data subject to change without notice.

Lay-In Wireway Type 1 Quick-Connect Hinge Cover Illustration Sheet and Catalog Number

Subclass: HS1

Wireway 90° Elbows

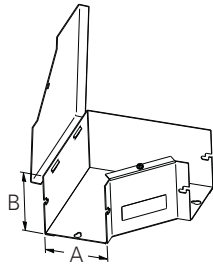
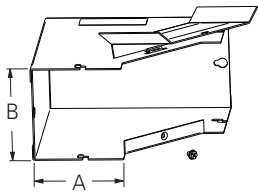

Inside Opening

Specifically designed to have only the inside cover hinge open to allow a continuous run with 90° turns.

Side Opening

Side cover is hinged to allow a continuous run on designs with 90° sweeping turns.

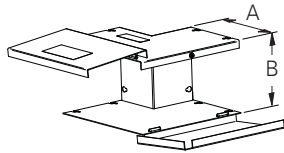

Outside Opening

Specifically designed to have the outside covers hinge open to allow a continuous run with 90° turns.

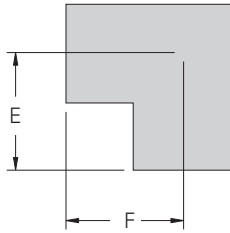

(outside opening)

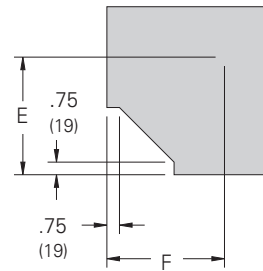

(inside and side opening)

Catalog Number	A		B		E		F	
	in.	mm	in.	mm	in.	mm	in.	mm
22 HSL IN	2.50	63	2.50	63	3.31	84	3.31	84
44 HSL IN	4.00	102	4.00	102	4.06	103	4.06	103
66 HSL IN	6.00	152	6.00	152	5.06	128	5.06	128
88 HSL IN	8.00	203	8.00	203	6.06	154	6.06	154
1010 HSL IN	10.00	254	10.00	254	7.06	179	7.06	179
1212 HSL IN	12.00	305	12.00	305	8.06	205	8.06	205
22 HSL OUT	2.50	63	2.50	63	3.38	86	3.38	86
44 HSL OUT	4.00	102	4.00	102	4.09	104	4.09	104
66 HSL OUT	6.00	152	6.00	152	5.09	129	5.09	129
88 HSL OUT	8.00	203	8.00	203	6.09	154	6.09	154
1010 HSL OUT	10.00	254	10.00	254	7.09	180	7.09	180
1212 HSL OUT	12.00	305	12.00	305	8.09	205	8.09	205
22 HSL SIDE	2.50	63	2.50	63	3.50	89	3.50	89
44 HSL SIDE	4.00	102	4.00	102	4.32	110	4.32	110
66 HSL SIDE	6.00	152	6.00	152	5.31	135	5.31	135
88 HSL SIDE	8.00	203	8.00	203	6.31	160	6.31	160
1010 HSL SIDE	10.00	254	10.00	254	7.31	185	7.31	185
1212 HSL SIDE	12.00	305	12.00	305	8.31	211	8.31	211

Wireway 45° Elbows

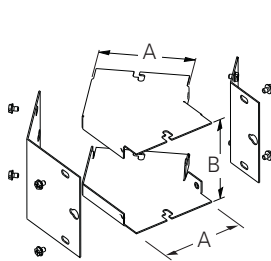

Combo Opening

Designed to achieve a 45° turn. Inside and outside removable covers are secured with screws.

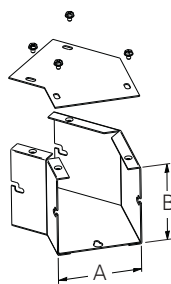

Side Opening

Designed to achieve a 45° turn and have the cover removed from the side. Excellent for combining two to make a gradual 90° sweep.

Catalog Number	A		B		E		F	
	in.	mm	in.	mm	in.	mm	in.	mm
2245 HSL COMBO	2.50	63	2.50	63	1.72	43	1.72	43
4445 HSL COMBO	4.00	102	4.00	102	2.75	70	2.75	70
6645 HSL COMBO	6.00	152	6.00	152	3.18	81	3.18	81
8845 HSL COMBO	8.00	203	8.00	203	3.62	92	3.62	92
101045 HSL COMBO	10.00	254	10.00	254	4.06	103	4.06	103
121245 HSL COMBO	12.00	305	12.00	305	4.50	114	4.50	114
2245 HSL SIDE	2.50	63	2.50	63	1.72	43	1.72	43
4445 HSL SIDE	4.00	102	4.00	102	2.75	70	2.75	70
6645 HSL SIDE	6.00	152	6.00	152	3.18	81	3.18	81
8845 HSL SIDE	8.00	203	8.00	203	3.62	92	3.62	92
101045 HSL SIDE	10.00	254	10.00	254	4.06	103	4.06	103
121245 HSL SIDE	12.00	305	12.00	254	4.50	114	4.50	114

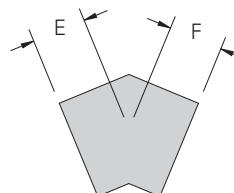

Notes: Dimensions are in inches. Millimeters shown are for reference only. Data subject to change without notice.

Lay-In Wireway Type 1 Quick-Connect Hinge Cover Illustration Sheet and Catalog Number

Subclass: HS1

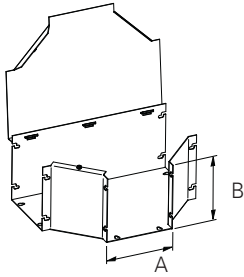

Tee
Side hinge cover design for applications where a "T" junction is necessary.

Catalog Number	A		B		E		F	
	in.	mm	in.	mm	in.	mm	in.	mm
22 HST	2.50	63	2.50	63	5.38	136	4.25	198
44 HST	4.00	102	4.00	102	6.15	156	6.12	155
66 HST	6.00	152	6.00	152	7.15	181	7.12	181
88 HST	8.00	203	8.00	203	8.15	207	8.12	206
1010 HST	10.00	254	10.00	254	9.15	232	9.12	231
1212 HST	12.00	305	12.00	305	10.15	258	10.12	257

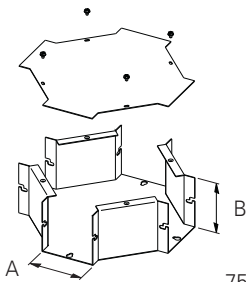
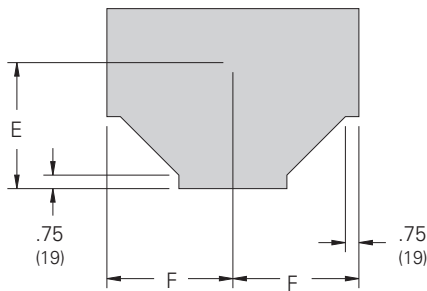

Cross
Side cover and broad body design to junction cable run in four directions. Removable cover is secured with screws.

Catalog Number	A		B		E		F	
	in.	mm	in.	mm	in.	mm	in.	mm
22 HSX	2.50	63	2.50	63	5.97	151	5.97	151
44 HSX	4.00	102	4.00	102	6.75	171	6.75	171
66 HSX	6.00	152	6.00	152	7.75	197	7.75	197
88 HSX	8.00	203	8.00	203	8.75	222	8.75	222
1010 HSX	10.00	254	10.00	254	9.75	247	9.75	247
1212 HSX	12.00	305	12.00	305	10.75	273	10.75	273

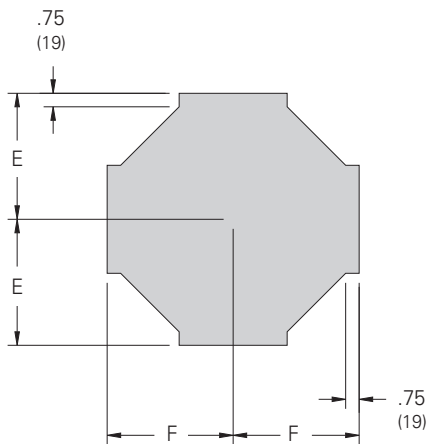

Notes: Dimensions are in inches. Millimeters shown are for reference only. Data subject to change without notice.

Lay-In Wireway Type 3R EnviroShield™ System Data Sheet

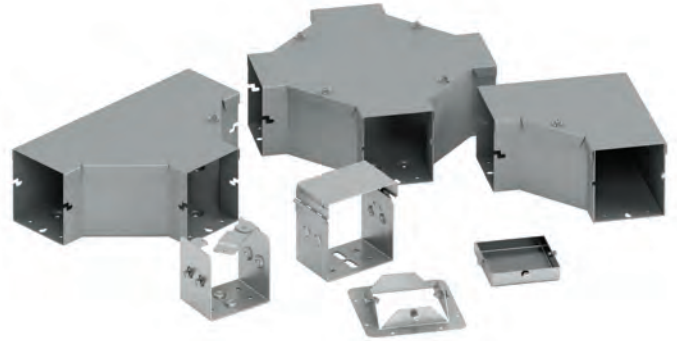

Install inside connector in wireway ends and tighten



Install and secure hinged covers



Install outside connector around wireway splice location



Latch shut (padlock can be installed if desired)

Application

- Houses runs of power, control and communication cable
- Used for cable and wire junction, distribution and termination

Standards

- UL 870 listed, Type 3R
- CSA C22.2 No. 26 certified, Type 3R
- Conforms to NEMA standard for Type 3R

Material & Finish

- Galvanealed steel with ANSI 61 gray acrylic electrocoat finish and zinc plated hardware
- Aluminum with stainless steel hardware

Accessories

- Sealing devices
- Touch-up paint
- See Accessories section

Protected by U.S. Patents 7,525,044 & 7,762,042

Construction

- Wireway body and cover are fabricated from code gauge steel, or brushed aluminum (see page 22)
- Wireway body has embossed mounting holes on the back
- Cover is secured to the body with gasketed retaining screw
- Variety of fittings allow runs which can change directions, size, junction and terminate, as well as, expansion and contraction
- Wireway connectors (sold separately) have a gate feature which can swing completely open allowing for lay-in of wire and cable
- Wireway connectors have a locking feature for optional pad-locking
- Removable hinge cover construction
- Z-slots for quick-connect connection method
- Wireways 120" (3048mm) in length have two overlapping covers

Discount Schedule: A2

Subclass: RHS

Notes: We can provide special sizes, finishes and other modifications. Consult the factory for your special requirements.

Lay-In Wireway Type 3R EnviroShield™ System Illustration Sheet and Catalog Number

Wireway Section

Lengths from 12.00" to 120.00".
Wireway exceeding 72.00" has two covers.

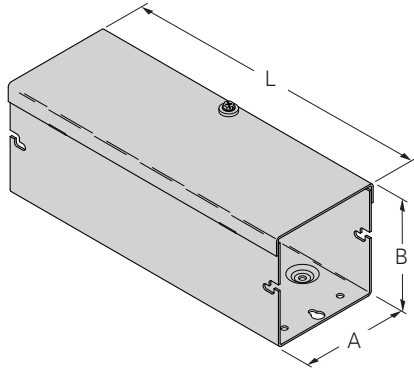

Subclass: RHS

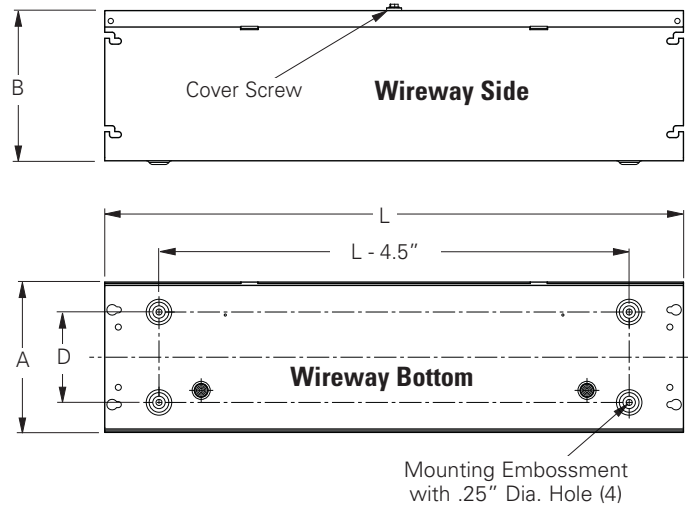

Wireway Catalog Number		Wireway Size Height x Depth x Length		Mounting Hole Spacing		Material Thickness			
Steel	Aluminum	A x B x C		D		Steel		Aluminum	
		in.	mm	in.	mm	Gauge	mm	In.	mm
4412-3RHS NK	4412-3RAHS NK	4.00 x 4.00 x 12.00	101 x 101 x 305	2.25	57.1	16	1.52	0.080	2.03
4460-3RHS NK	4460-3RAHS NK	4.00 x 4.00 x 60.00	101 x 101 x 1524	2.25	57.1	16	1.52	0.080	2.03
44120-3RHS NK	44120-3RAHS NK	4.00 x 4.00 x 120.00	101 x 101 x 3048	2.25	57.1	16	1.52	0.080	2.03
6612-3RHS NK	6612-3RAHS NK	6.00 x 6.00 x 12.00	152 x 152 x 305	3.75	95.2	16	1.52	0.080	2.03
6660-3RHS NK	6660-3RAHS NK	6.00 x 6.00 x 60.00	152 x 152 x 1524	3.75	95.2	16	1.52	0.080	2.03
66120-3RHS NK	66120-3RAHS NK	6.00 x 6.00 x 120.00	152 x 152 x 3048	3.75	95.2	16	1.52	0.080	2.03
8812-3RHS NK	8812-3RAHS NK	8.00 x 8.00 x 12.00	203 x 203 x 305	5.75	146.0	16	1.52	0.080	2.03
8860-3RHS NK	8860-3RAHS NK	8.00 x 8.00 x 60.00	203 x 203 x 1524	5.75	146.0	16	1.52	0.080	2.03
88120-3RHS NK	88120-3RAHS NK	8.00 x 8.00 x 120.00	203 x 203 x 3048	5.75	146.0	16	1.52	0.080	2.03

NK = No Knockouts

Wireway Connectors

Swing gate allows for lay-in installation of wire and cable.
Wrap-around connector provides Type 3R rating and padlocking provision.

Connector Catalog Number		A		B	
Steel	Aluminum	in.	mm	in.	mm
44-3RHSC	44-3RAHSC	4.00	101	4.00	101
66-3RHSC	66-3RAHSC	6.00	152	6.00	152
88-3RHSC	88-3RAHSC	8.00	203	8.00	203

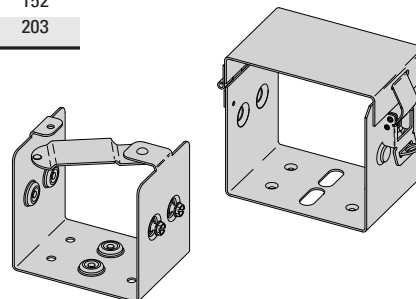
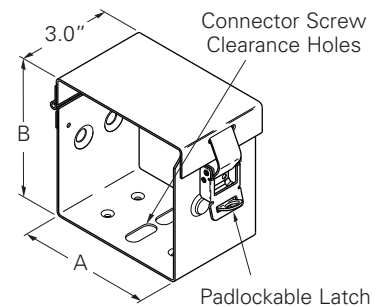

Notes: Dimensions are in inches. Millimeters shown are for reference only. Data subject to change without notice.

Lay-In Wireway Type 3R EnviroShield™ System Illustration Sheet and Catalog Number

Subclass: RHS

Wireway End

Used to terminate wireway or fitting.

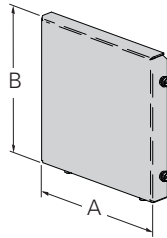

Wireway End Catalog Number		A		B	
Steel	Aluminum	in.	mm	in.	mm
44-3RHSE NK	44-3RAHSE NK	4.00	101	4.00	101
66-3RHSE NK	66-3RAHSE NK	6.00	152	6.00	152
88-3RHSE NK	88-3RAHSE NK	8.00	203	8.00	203

Wireway End Flange

Allows for a secure connection of wireway or fitting to an adjoining enclosure or wall.

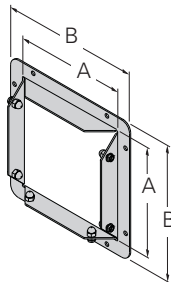

Wireway End Flange Catalog Number		A		B	
Steel	Aluminum	in.	mm	in.	mm
44-3RHSE NK	44-3RAHSE NK	4.00	101	4.00	101
66-3RHSE NK	66-3RAHSE NK	6.00	152	6.00	152
88-3RHSE NK	88-3RAHSE NK	8.00	203	8.00	203

Wireway 90° Elbow

Side opening hinge cover design for applications where 90° turn is necessary.

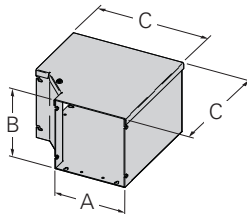

Wireway 90° Elbow Catalog Number		A		B		C	
Steel	Aluminum	in.	mm	in.	mm	in.	mm
44-3RHSL SIDE	44-3RAHSL SIDE	4.00	101	4.00	101	8.84	224
66-3RHSL SIDE	66-3RAHSL SIDE	6.00	152	6.00	152	10.84	275
88-3RHSL SIDE	88-3RAHSL SIDE	8.00	203	8.00	203	12.84	326

Wireway Tee

Side opening hinge cover design for applications where a tee junction is necessary.

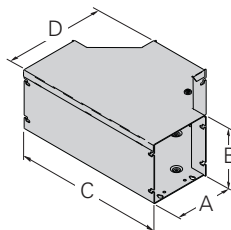
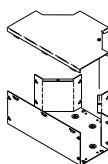

Wireway Tee Catalog Number		A		B		C		D	
Steel	Aluminum	in.	mm	in.	mm	in.	mm	in.	mm
44-3RHST	44-3RAHST	4.00	101	4.00	101	13.84	351	9.04	229
66-3RHST	66-3RAHST	6.00	152	6.00	152	15.84	402	11.04	280
88-3RHST	88-3RAHST	8.00	203	8.00	203	17.84	453	13.04	331

Notes: Dimensions are in inches. Millimeters shown are for reference only. Data subject to change without notice.

Cable & Wire Management

Lay-In Wireway Type 3R EnviroShield™ System Illustration Sheet and Catalog Number

Subclass: RHS

Wireway Cross

Side opening cover design for applications where a cross junction is necessary.

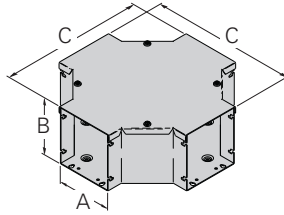

Wireway Cross Catalog Number		A		B		C	
Steel	Aluminum	in.	mm	in.	mm	in.	mm
44-3RSCX	44-3RASCX	4.00	101	4.00	101	13.84	351
66-3RSCX	66-3RASCX	6.00	152	6.00	152	15.84	402
88-3RSCX	88-3RASCX	8.00	203	8.00	203	17.84	453

Wireway Reducer

Screw opening cover design for applications where a change in wireway cross-section (height x width) is necessary.

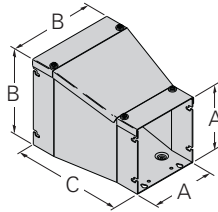
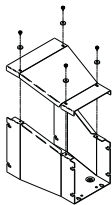

Wireway Reducer Catalog Number		A		B		C	
Steel	Aluminum	in.	mm	in.	mm	in.	mm
4466-3RSCR	4466-3RASCRCR	4.00	101	6.00	152	10.00	254
4488-3RSCR	4488-3RASCRCR	4.00	101	8.00	203	10.00	254
6688-3RSCR	6688-3RASCRCR	6.00	152	8.00	203	10.00	254

Bolt-On Barrier

For installations that require separated wiring compartments. An ideal solution for separating power from communication cables.

* Not UL or CSA listed fitting

Wireway Catalog Number		Wireway Size Height x Depth		Length L		Height H	
Steel	Aluminum	in.	mm	in.	mm	in.	mm
44-12BK*	44-3RBKA*	4.00 x 4.00	101 x 101	60.00	1524	3.00	76.2
66-12BK*	66-3RBKA*	6.00 x 6.00	152 x 152	60.00	1524	4.50	114.3
88-12BK*	88-3RBKA*	8.00 x 8.00	203 x 203	60.00	1524	6.00	152.4

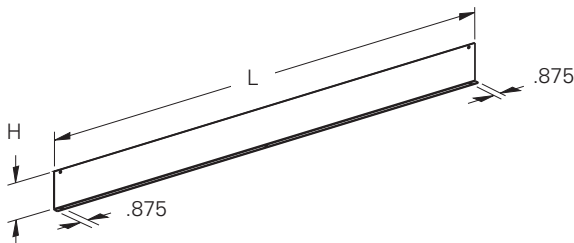

Notes: Dimensions are in inches. Millimeters shown are for reference only. Data subject to change without notice.

Lay-In Wireway Type 12 Data Sheet



Application

- Houses runs of control and power cable
- Protects against circulating dust, falling dirt and dripping noncorrosive liquids

Standards

- UL 870 listed, unless noted
- CSA C22.2 No. 26 certified, unless noted
- Conforms to NEMA standard for Type 12

Finish

- Wash and phosphate undercoat
- ANSI 61 gray painted finish
- Hardware and latches are zinc plated

Accessories

- Touch-up paint
- See Accessories section

Construction

- Wireway body and cover are fabricated from (14) gauge steel
- Flanges are (10) gauge steel
- All continuous welded seams are finished smooth
- External and internal edges are rounded to prevent injury or damage to cable
- Covers are secured to the wireway and fitting body with heavy duty butt hinges and quick-release latches
- Covers have a fixed, oil-resistant gasket
- An oil-resistant gasket is provided for installation between flanges
- All covers and sealing plates can be hinged completely open or removed to allow for continuous lay-in cable feed
- All straight sections and fittings are furnished with sealing plate kits (see pages 26-30)

Discount Schedule: C2

Subclass: D90

Notes: We can provide special sizes, finishes and other modifications. Consult the factory for your special requirements.

Lay-In Wireway Type 12 Illustration Sheet

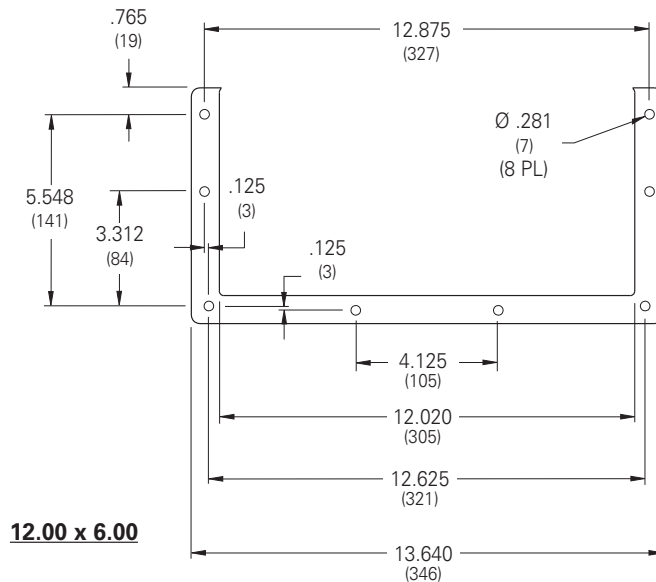
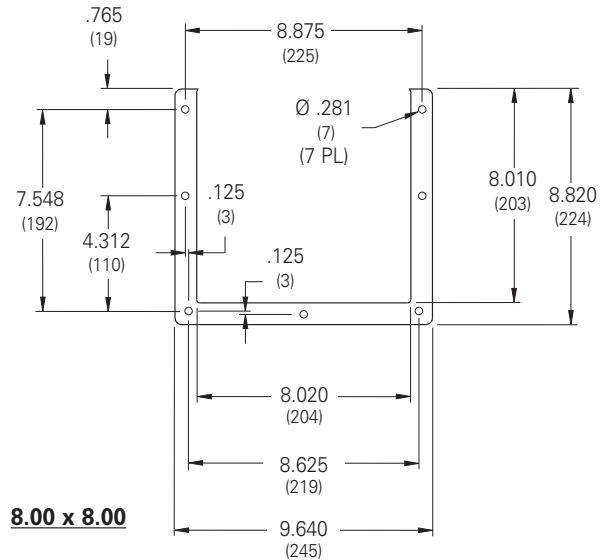
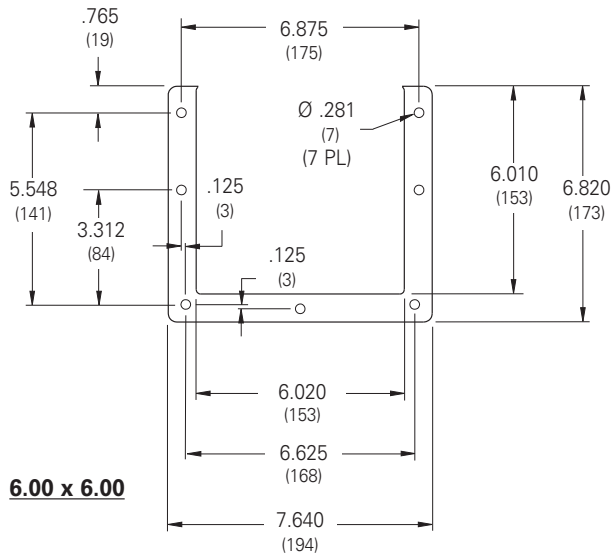
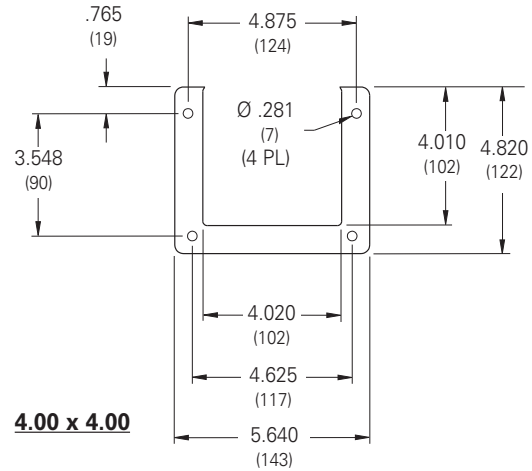
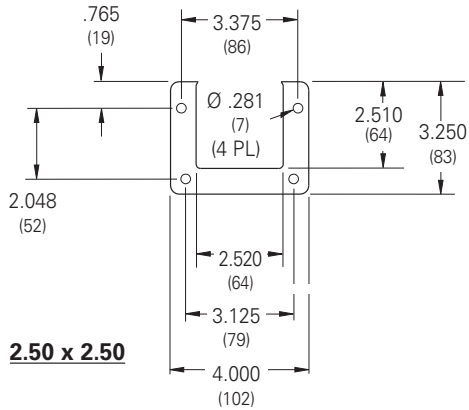

Flange Details

Notes: Dimensions are in inches. Millimeters shown are for reference only. Data subject to change without notice.

Lay-In Wireway Type 12

Illustration Sheet and Catalog Number

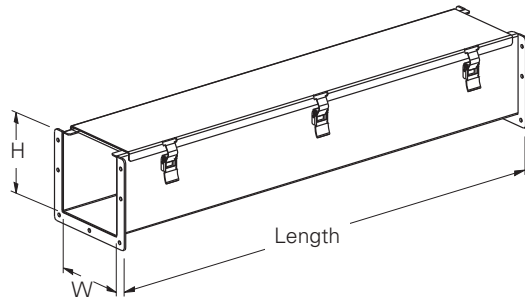

Straight Section

- Includes (1) sealing plate kit

Catalog Number	Size	H		W	
		in.	mm	in.	mm
22(*)-12LW	2.5 x 2.5	2.50	64	2.50	64
44(*)-12LW	4 x 4	4.00	102	4.00	102
66(*)-12LW	6 x 6	6.00	152	6.00	152
88(*)-12LW	8 x 8	8.00	203	8.00	203
126(*)-12LW	12 x 6	6.00	152	12.00	305

(*) Insert for length **04** = 4", **06** = 6", **12** = 12", **24** = 24", **36** = 36", **48** = 48", **60** = 60", **120** = 120".

For	Actual Length	
	in.	mm
4	3.94	100
6	5.94	151
12	11.94	303
24	23.94	608
36	35.94	913
48	47.94	1218
60	59.94	1522
120	119.94	3046

Subclass: D90

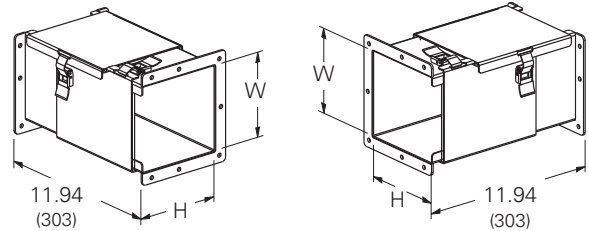

Transposition Wireway Sections

Clockwise (C)

- Includes (1) sealing plate kit

Counterclockwise (CC)

- Includes (1) sealing plate kit

Catalog Number	Size	H		W	
		in.	mm	in.	mm
22-12LTS(*)	2.5 x 2.5	2.50	64	2.50	64
44-12LTS(*)	4 x 4	4.00	102	4.00	102
66-12LTS(*)	6 x 6	6.00	152	6.00	152
88-12LTS(*)	8 x 8	8.00	203	8.00	203

(*) Insert **C** for Clockwise

Insert **CC** for Counterclockwise

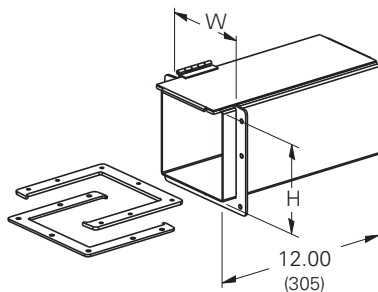

Telescopic Fitting, Lay-In

- Adjustable length from 1" to 7"
- Includes hardware
- No cutting or welding required

Catalog Number	Size	H		W	
		in.	mm	in.	mm
22-12LTF	2.5 x 2.5	2.32	59	2.32	59
44-12LTF	4 x 4	3.82	97	3.82	97
66-12LTF	6 x 6	5.82	148	5.82	148
88-12LTF	8 x 8	7.82	199	7.82	199
126-12LTF	12 x 6	5.82	148	11.82	300

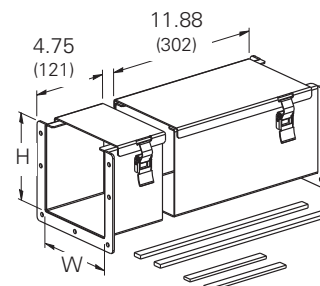

Cut-Off Fitting, Lay-In

- Includes (1) sealing plate kit
- Shorten body and cover to desired length and weld together, 9.50" minimum length

Catalog Number	Size	H		W	
		in.	mm	in.	mm
22-12LCF	2.5 x 2.5	2.50	64	2.50	64
44-12LCF	4 x 4	4.00	102	4.00	102
66-12LCF	6 x 6	6.00	152	6.00	152
88-12LCF	8 x 8	8.00	203	8.00	203
126-12LCF	12 x 6	6.00	152	12.00	305

Notes: Dimensions are in inches. Millimeters shown are for reference only. Data subject to change without notice.

Cable & Wire Management

Lay-In Wireway Type 12

Illustration Sheet and Catalog Number

Subclass: D90

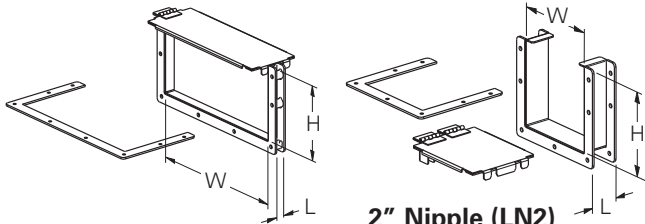

1" Nipple (LN1)

- Includes hardware

2" Nipple (LN2)

3" Nipple (LN3)

- Includes hardware

Catalog Number	Size	H		W	
		in.	mm	in.	mm
22-12LN(*)	2.5 x 2.5	2.50	64	2.50	64
44-12LN(*)	4 x 4	4.00	102	4.00	102
66-12LN(*)	6 x 6	6.00	152	6.00	152
88-12LN(*)	8 x 8	8.00	203	8.00	203
126-12LN(*)	12 x 6	6.00	152	12.00	305

(*) Insert **1** for 1" nipple (L=.938")
 Insert **2** for 2" nipple (L=1.938")
 Insert **3** for 3" nipple (L=2.938")

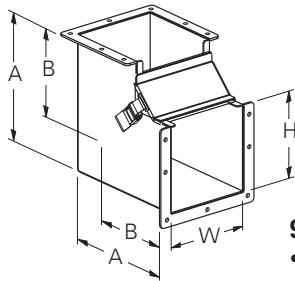

90° Elbow, Inside Opening

- Includes (1) sealing plate kit

Catalog Number	Size	H		W		A		B	
		in.	mm	in.	mm	in.	mm	in.	mm
22-12LE9B	2.5 x 2.5	2.50	64	2.50	64	5.94	151	4.69	119
44-12LE9B	4 x 4	4.00	102	4.00	102	7.44	189	5.44	138
66-12LE9B	6 x 6	6.00	152	6.00	152	9.44	240	6.44	164
88-12LE9B	8 x 8	8.00	203	8.00	203	11.44	291	7.44	189
126-12LE9B	12 x 6	6.00	152	12.00	305	9.44	240	6.44	164

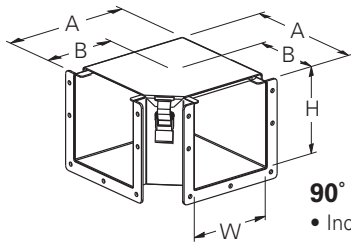

90° Elbow, Top Opening

- Includes (1) sealing plate kit

Catalog Number	Size	H		W		A		B	
		in.	mm	in.	mm	in.	mm	in.	mm
22-12LE9A	2.5 x 2.5	2.50	64	2.50	64	5.25	133	4.00	102
44-12LE9A	4 x 4	4.00	102	4.00	102	6.75	171	4.75	121
66-12LE9A	6 x 6	6.00	152	6.00	152	8.75	222	5.75	146
88-12LE9A	8 x 8	8.00	203	8.00	203	10.75	273	6.75	171
126-12LE9A	12 x 6	6.00	152	12.00	305	14.75	375	8.75	222

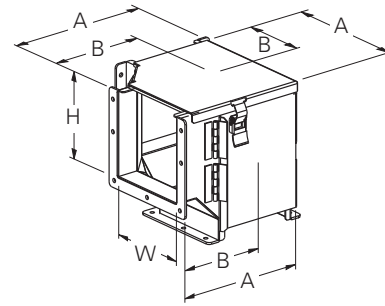

90° Elbow, Outside-Top Opening

- Includes (2) sealing plate kits

Catalog Number	Size	H		W		A		B	
		in.	mm	in.	mm	in.	mm	in.	mm
22-12LE9AC	2.5 x 2.5	2.50	64	2.50	64	5.94	151	4.69	119
44-12LE9AC	4 x 4	4.00	102	4.00	102	7.44	189	5.44	138
66-12LE9AC	6 x 6	6.00	152	6.00	152	9.44	240	6.44	164
88-12LE9AC	8 x 8	8.00	203	8.00	203	11.44	291	7.44	189

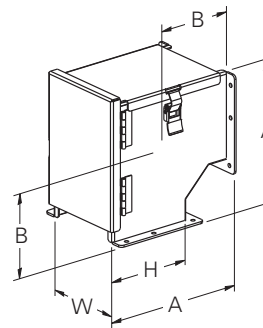

90° Elbow, Outside Opening

- Includes (1) sealing plate kit

Catalog Number	Size	H		W		A		B	
		in.	mm	in.	mm	in.	mm	in.	mm
22-12LE9C	2.5 x 2.5	2.50	64	2.50	64	5.94	151	4.69	119
44-12LE9C	4 x 4	4.00	102	4.00	102	7.44	189	5.44	138
66-12LE9C	6 x 6	6.00	152	6.00	152	9.44	240	6.44	164
88-12LE9C	8 x 8	8.00	203	8.00	203	11.44	291	7.44	189
126-12LE9C	12 x 6	6.00	152	12.00	305	9.44	240	6.44	164

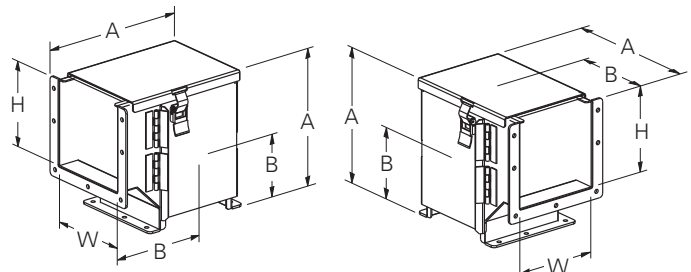

90° Transposition Elbows

Clockwise (C)

- Includes (1) sealing plate kit

Counterclockwise (CC)

- Includes (1) sealing plate kit

Catalog Number	Size	H		W		A		B	
		in.	mm	in.	mm	in.	mm	in.	mm
22-12LE9T(*)	2.5 x 2.5	2.50	64	2.50	64	5.94	151	4.69	119
44-12LE9T(*)	4 x 4	4.00	102	4.00	102	7.44	189	5.44	138
66-12LE9T(*)	6 x 6	6.00	152	6.00	152	9.44	240	6.44	164
88-12LE9T(*)	8 x 8	8.00	203	8.00	203	11.44	291	7.44	189

(*) Insert **C** for Clockwise, Insert **CC** for Counterclockwise

Notes: Dimensions are in inches. Millimeters shown are for reference only. Data subject to change without notice.

Lay-In Wireway Type 12

Illustration Sheet and Catalog Number

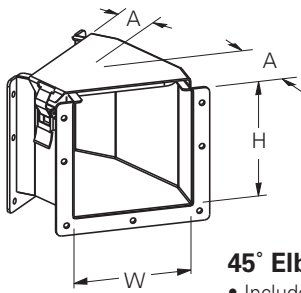

45° Elbow, Top Opening

• Includes (1) sealing plate kit

Catalog Number	Size	H		W		A	
		in.	mm	in.	mm	in.	mm
22-12LE45A	2.5 x 2.5	2.50	64	2.50	64	3.12	79
44-12LE45A	4 x 4	4.00	102	4.00	102	3.70	94
66-12LE45A	6 x 6	6.00	152	6.00	152	4.46	113
88-12LE45A	8 x 8	8.00	203	8.00	203	5.23	133
126-12LE45A	12 x 6	6.00	152	12.00	305	6.76	172

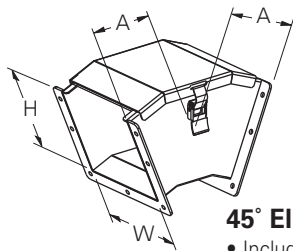

45° Elbow, Outside Opening

• Includes (1) sealing plate kit

Catalog Number	Size	H		W		A	
		in.	mm	in.	mm	in.	mm
22-12LE45C	2.5 x 2.5	2.50	64	2.50	64	2.65	67
44-12LE45C	4 x 4	4.00	102	4.00	102	3.51	89
66-12LE45C	6 x 6	6.00	152	6.00	152	3.91	99
88-12LE45C	8 x 8	8.00	203	8.00	203	4.24	108
126-12LE45C	12 x 6	6.00	152	12.00	305	3.91	89

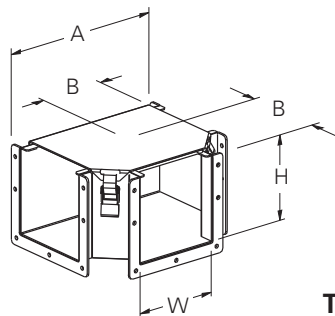

Tee, Top Opening

• Includes (2) sealing plate kits

Catalog Number	Size	H		W		A		B	
		in.	mm	in.	mm	in.	mm	in.	mm
22-12LTA	2.5 x 2.5	2.50	64	2.50	64	8.00	203	4.00	102
44-12LTA	4 x 4	4.00	102	4.00	102	9.50	241	4.75	121
66-12LTA	6 x 6	6.00	152	6.00	152	11.50	292	5.75	146
88-12LTA	8 x 8	8.00	203	8.00	203	13.50	343	6.75	171
126-12LTA	12 x 6	6.00	152	12.00	305	17.50	445	8.75	222

Subclass: D90

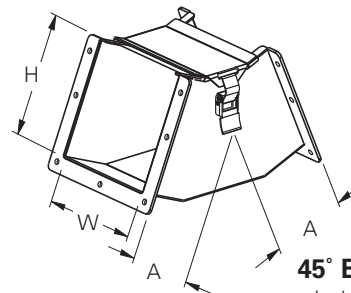

45° Elbow, Inside Opening

• Includes (1) sealing plate kit

Catalog Number	Size	H		W		A	
		in.	mm	in.	mm	in.	mm
22-12LE45B	2.5 x 2.5	2.50	64	2.50	64	3.70	94
44-12LE45B	4 x 4	4.00	102	4.00	102	4.28	109
66-12LE45B	6 x 6	6.00	152	6.00	152	5.04	128
88-12LE45B	8 x 8	8.00	203	8.00	203	5.81	148
126-12LE45B	12 x 6	6.00	152	12.00	305	5.04	128

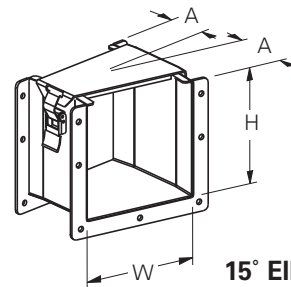

15° Elbow, Top Opening

• Includes (1) sealing plate kit

Catalog Number	Size	H		W		A	
		in.	mm	in.	mm	in.	mm
22-12LE15A	2.5 x 2.5	2.50	64	2.50	64	2.57	65
44-12LE15A	4 x 4	4.00	102	4.00	102	2.77	70
66-12LE15A	6 x 6	6.00	152	6.00	152	3.03	77
88-12LE15A	8 x 8	8.00	203	8.00	203	3.29	84
126-12LE15A	12 x 6	6.00	152	12.00	305	3.81	97

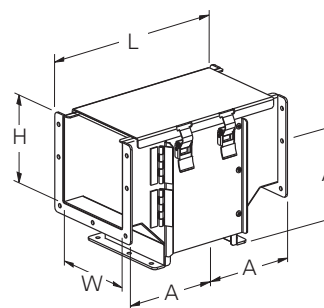

Tee, Outside Opening

• Includes (2) sealing plate kits

Catalog Number	Size	H		W		A		L	
		in.	mm	in.	mm	in.	mm	in.	mm
22-12LTC	2.5 x 2.5	2.50	64	2.50	64	4.69	119	9.38	238
44-12LTC	4 x 4	4.00	102	4.00	102	5.44	138	10.88	264
66-12LTC	6 x 6	6.00	152	6.00	152	6.44	164	12.88	314
88-12LTC	8 x 8	8.00	203	8.00	203	7.44	189	14.88	365

Notes: Dimensions are in inches. Millimeters shown are for reference only. Data subject to change without notice.

Lay-In Wireway Type 12

Illustration Sheet and Catalog Number

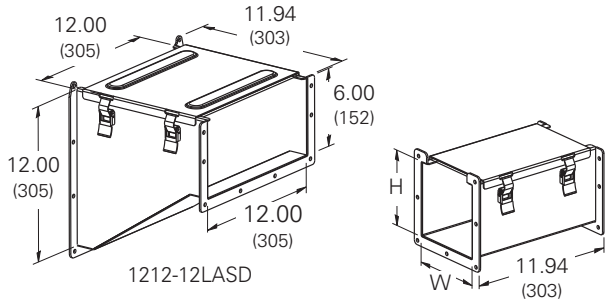

Adapters

- Includes (2) sealing plate kits

Catalog Number	Size	Competitor	H		W	
			in.	mm	in.	mm
22-12LAHW	2.5 x 2.5	Hoffman®† or Wiegmann®†	2.50	64	2.50	64
44-12LAHW	4 x 4		4.00	102	4.00	102
66-12LAHW	6 x 6		6.00	152	6.00	152
88-12LAHW	8 x 8		8.00	203	8.00	203
126-12LAHW	12 x 6		6.00	152	12.00	305
22-12LASD	2.5 x 2.5	Square D®†	2.50	64	2.50	64
44-12LASD	4 x 4		4.00	102	4.00	102
66-12LASD	6 x 6		6.00	152	6.00	152
88-12LASD	8 x 8		8.00	203	8.00	203
126-12LASD	12 x 6		6.00	152	12.00	305
22-12LAHM	2.5 x 2.5	Hammond Mfg.™†	2.50	64	2.50	64
44-12LAHM	4 x 4		4.00	102	4.00	102
66-12LAHM	6 x 6		6.00	152	6.00	152
88-12LAHM	8 x 8		8.00	203	8.00	203
126-12LAHM	12 x 6		6.00	152	12.00	305

† Marks are the property of their respective owners.

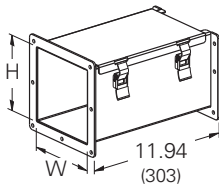

Lay-In to Feed Through Adapter

- Includes (1) sealing plate kit and (1) gasket kit

Catalog Number	Size	H		W	
		in.	mm	in.	mm
44-12LAFW	4 x 4	4.00	102	4.00	102
66-12LAFW	6 x 6	6.00	152	6.00	152
88-12LAFW	8 x 8	8.00	203	8.00	203

Subclass: D90

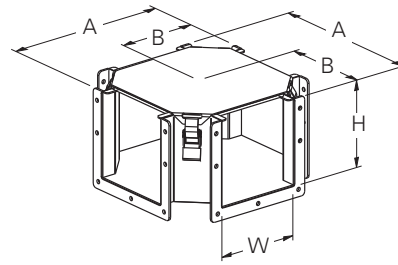

Cross, Top Opening

- Includes (3) sealing plate kits

Catalog Number	Size	H		W		A		B	
		in.	mm	in.	mm	in.	mm	in.	mm
22-12LC	2.5 x 2.5	2.50	64	2.50	64	8.00	203	4.00	102
44-12LC	4 x 4	4.00	102	4.00	102	9.50	241	4.75	121
66-12LC	6 x 6	6.00	152	6.00	152	11.50	292	5.75	146
88-12LC	8 x 8	8.00	203	8.00	203	13.50	343	6.75	171
126-12LC	12 x 6	6.00	152	12.00	152	17.50	445	8.75	222

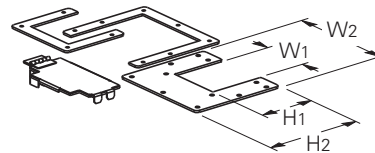

Reducer

- Includes hardware

Catalog Number	Size	H1		H2		W1		W2	
		in.	mm	in.	mm	in.	mm	in.	mm
4422-12LR	4 x 4 to 2.5 x 2.5	2.44	62	4.82	122	2.38	60	5.64	143
6644-12LR	6 x 6 to 4 x 4	3.94	100	6.82	173	3.88	99	7.64	194
8866-12LR	8 x 8 to 6 x 6	5.94	151	8.82	224	5.88	149	9.64	245
12644-12LR	12 x 6 to 4 x 4	3.94	100	6.82	173	3.88	99	13.64	346
12666-12LR	12 x 6 to 6 x 6	5.94	151	6.82	173	5.88	149	13.64	346

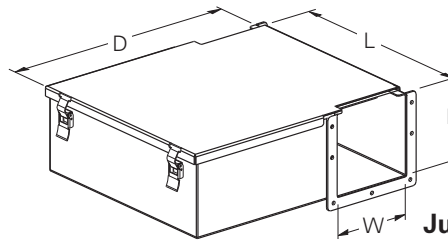

Junction Box

- Includes (1) junction box sealing plate kit and (1) of the following removable panels:
 22-12LJB = AW108P
 44-12LJB = AW1210P
 66-12LJB = AW1412P
 88-12LJB = AW1614P

Catalog Number	Size	H		W		L		D	
		in.	mm	in.	mm	in.	mm	in.	mm
22-12LJB	2.5 x 2.5	2.50	64	2.50	64	11.59	294	10.25	260
44-12LJB	4 x 4	4.00	102	4.00	102	13.59	345	14.00	356
66-12LJB	6 x 6	6.00	152	6.00	152	15.59	396	18.00	457
88-12LJB	8 x 8	8.00	203	8.00	203	17.59	447	22.00	559

Notes: Dimensions are in inches. Millimeters shown are for reference only. Data subject to change without notice.

Lay-In Wireway Type 12

Illustration Sheet and Catalog Number

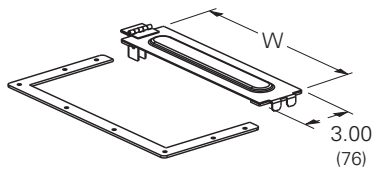

Sealing Plate, Flat

- Includes hardware

Catalog Number	Size	W	H
		in.	mm
22-12LSP	2.5 x 2.5	2.50	64
44-12LSP	4 x 4	4.00	102
66-12LSP	6 x 6	6.00	152
88-12LSP	8 x 8	8.00	203
126-12LSP	12 x 6	12.00	305

Subclass: D90

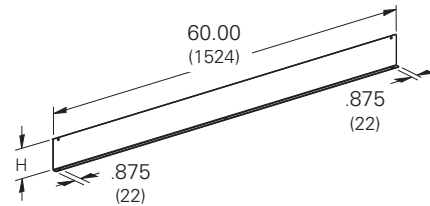

Barrier, Bolt-On

- Includes hardware

Catalog Number	Size	H	W
		in.	mm
22-12BK	2.5 x 2.5	1.88	48
44-12BK	4 x 4	3.00	76
66-12BK	6 x 6	4.50	114
88-12BK	8 x 8	6.00	152
66-12BK	12 x 6	4.50	114

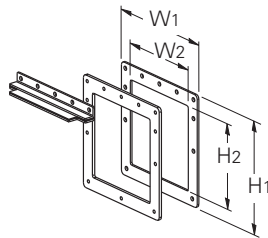

Box Connector

- Includes hardware

Catalog Number	Size	H1	H2	W1	W2
		in.	mm	in.	mm
22-12LBC	2.5 x 2.5	4.10	104	2.35	60
44-12LBC	4 x 4	5.74	146	3.85	72
66-12LBC	6 x 6	7.74	197	5.85	123
88-12LBC	8 x 8	9.74	247	7.85	174
126-12LBC	12 x 6	7.74	197	13.74	301

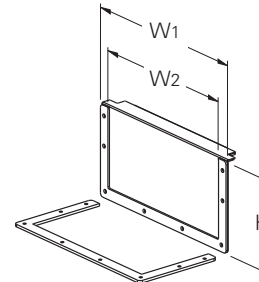

Closure Plate

- Includes hardware

Catalog Number	Size	H	W1	W2	
		in.	mm	in.	mm
22-12LCP	2.5 x 2.5	2.50	64	4.00	102
44-12LCP	4 x 4	4.00	102	5.64	143
66-12LCP	6 x 6	6.00	152	7.64	194
88-12LCP	8 x 8	8.00	203	9.64	245
126-12LCP	12 x 6	6.00	152	13.64	346

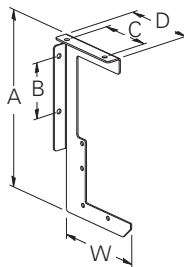

Drop

Catalog Number	Size	W	A	B	C	D	
		in.	mm	in.	mm	in.	mm
22-12LDH	2.5 x 2.5	4.50	114	8.75	222	1.50	38
44-12LDH	4 x 4	6.00	152	11.75	298	3.00	76
66-12LDH	6 x 6	8.50	216	16.00	406	5.00	127
88-12LDH	8 x 8	10.50	267	20.00	508	7.00	178

Wireway Hangers

- Includes wireway to bracket mounting hardware
- Anchors not included

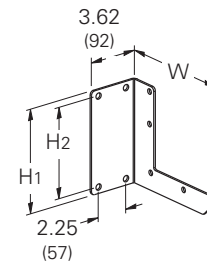

Bracket

Catalog Number	Size	H1	H2	W	
		in.	mm	in.	mm
22-12LBH	2.5 x 2.5	3.38	86	2.50	64
44-12LBH	4 x 4	4.88	124	4.00	102
66-12LBH	6 x 6	7.13	181	6.25	159
88-12LBH	8 x 8	9.13	232	8.25	210

Notes: Dimensions are in inches. Millimeters shown are for reference only. Data subject to change without notice.