

Wiring Troughs Type 1 Screw Cover Data Sheet

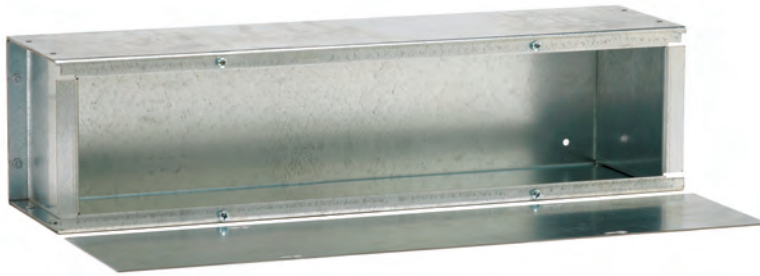
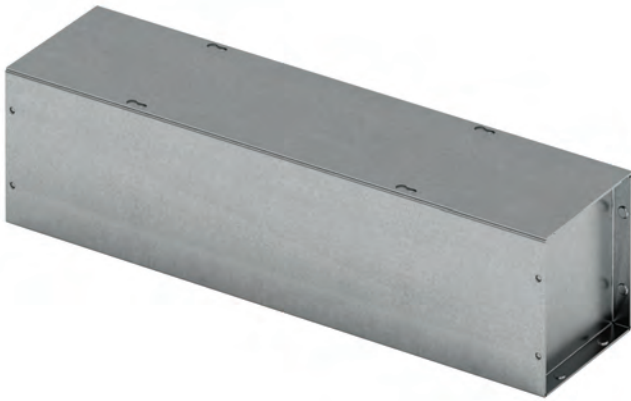

Application

- Used for indoor cable and wire junction, distribution, and termination applications where dirt, dust, oil, and water are not serious problems

Standards

- UL 870 listed, Type 1
- CSA C22.2 No. 26 certified, Type 1
- Conforms to NEMA standard for Type 1

Finish

- Galvanized Steel

Accessories

- See Accessories section

Construction

- Covers and bodies are fabricated from code gauge galvanized steel (see table, page 41)
- Bodies have mounting holes on the back
- Cover is held secure to the body by plated screws
- Keyhole slots on the trough cover allow removal of cover without removing screws
- Shipped complete with permanently connected ends

Discount Schedule: A2

Subclass: AN1

Notes: We can provide special sizes, finishes and other modifications. Consult the factory for your special requirements.

Wiring Troughs Type 1 Screw Cover Illustration Sheet and Catalog Number

Subclass: AN1

Catalog Number	Height x Depth x Length A x B x C		D		Gauge	
	in.	mm	in.	mm	in.	mm
4412 GTGV NK	4.00 x 4.00 x 12.00	102 x 102 x 305	2.75	69.8	16	1.4
4424 GTGV NK	4.00 x 4.00 x 24.00	102 x 102 x 610	2.75	69.8	16	1.4
4436 GTGV NK	4.00 x 4.00 x 36.00	102 x 102 x 914	2.75	69.8	16	1.4
4448 GTGV NK	4.00 x 4.00 x 48.00	102 x 102 x 1219	2.75	69.8	16	1.4
4460 GTGV NK	4.00 x 4.00 x 60.00	102 x 102 x 1524	2.75	69.8	16	1.4
4472 GTGV NK	4.00 x 4.00 x 72.00	102 x 102 x 1829	2.75	69.8	16	1.4
6612 GTGV NK	6.00 x 6.00 x 12.00	152 x 152 x 305	4.25	107.9	16	1.4
6624 GTGV NK	6.00 x 6.00 x 24.00	152 x 152 x 610	4.25	107.9	16	1.4
6636 GTGV NK	6.00 x 6.00 x 36.00	152 x 152 x 914	4.25	107.9	16	1.4
6648 GTGV NK	6.00 x 6.00 x 48.00	152 x 152 x 1219	4.25	107.9	16	1.4
6660 GTGV NK	6.00 x 6.00 x 60.00	152 x 152 x 1524	4.25	107.9	16	1.4
6672 GTGV NK	6.00 x 6.00 x 72.00	152 x 152 x 1829	4.25	107.9	16	1.4
8824 GTGV NK	8.00 x 8.00 x 24.00	203 x 203 x 610	6.00	152.4	14	1.9
8836 GTGV NK	8.00 x 8.00 x 36.00	203 x 203 x 914	6.00	152.4	14	1.9
8848 GTGV NK	8.00 x 8.00 x 48.00	203 x 203 x 1219	6.00	152.4	14	1.9
8860 GTGV NK	8.00 x 8.00 x 60.00	203 x 203 x 1524	6.00	152.4	14	1.9
8872 GTGV NK	8.00 x 8.00 x 72.00	203 x 203 x 1829	6.00	152.4	14	1.9
101048 GTGV NK	10.00 x 10.00 x 48.00	254 x 254 x 1219	8.00	203.2	14	1.9
121224 GTGV NK	12.00 x 12.00 x 24.00	305 x 305 x 610	10.00	254.0	14	1.9
121236 GTGV NK	12.00 x 12.00 x 36.00	305 x 305 x 914	10.00	254.0	14	1.9
121248 GTGV NK	12.00 x 12.00 x 48.00	305 x 305 x 1219	10.00	254.0	14	1.9

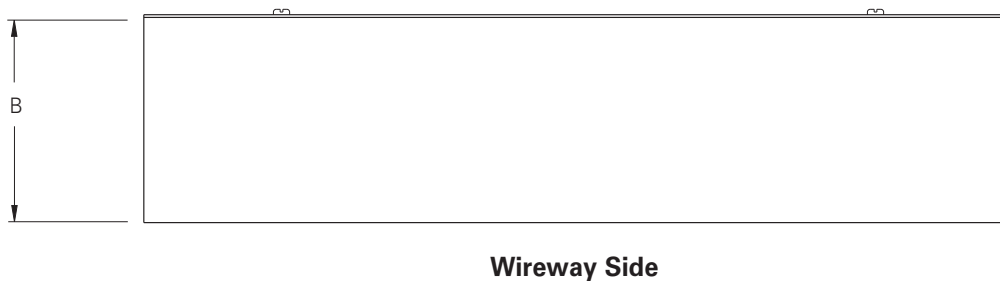
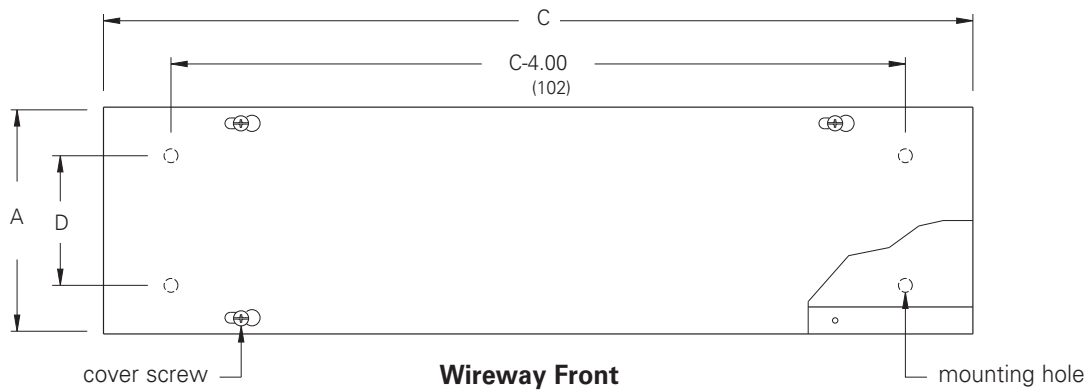

Notes: Dimensions are in inches. Millimeters shown are for reference only. Data subject to change without notice.

Wiring Troughs Type 3R Screw Cover, Painted & Galvanized Data and Illustration Sheet

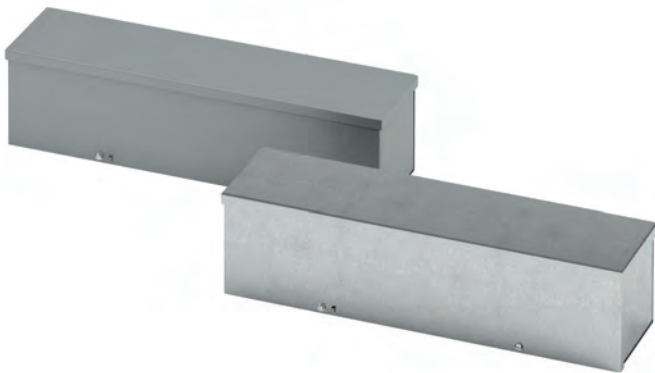

Finish

- Wash and phosphate undercoat or galvanized steel
- ANSI 61 gray acrylic electrocoat finish

Accessories

- Sealing devices
- Touch-up paint
- See Accessories section

Construction

- Wireway body and cover are fabricated from (16) gauge galvaneal steel for painted or galvanized steel
- Wireway body has embossed mounting holes on the back
- Wireway is available with or without knockouts on the bottom end only, (see drawing)
- Cover is held secure by sliding it under the top end flange and fastening it with plated screws on the bottom end flange
- Sealing screws and lances are located at each end of the wireway cover
- Wireway exceeding 72 inches in length has two covers, a removable center channel and body supports

Application

- Houses runs of control and power cable
- Used for cable and wire junction, distribution and termination

Standards

- UL 870 listed, Type 3R
- CSA C22.2 No. 26 certified, Type 3R
- Conforms to NEMA standard for Type 3R

Discount Schedule: A2

Subclass: AM1 - Painted & Z50 - Galvanized

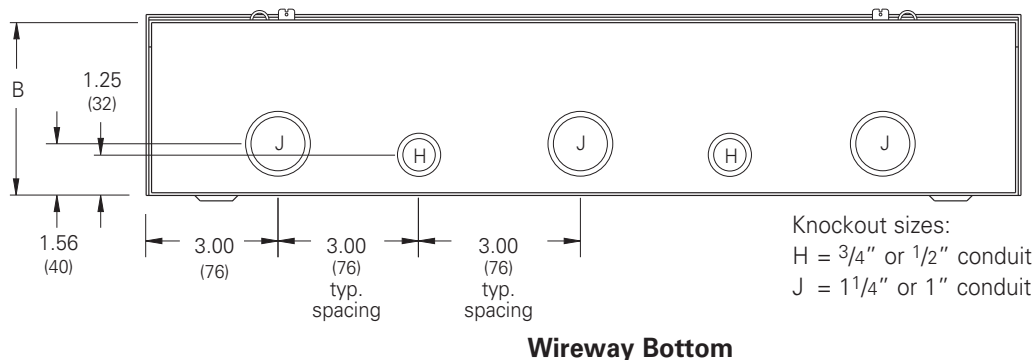
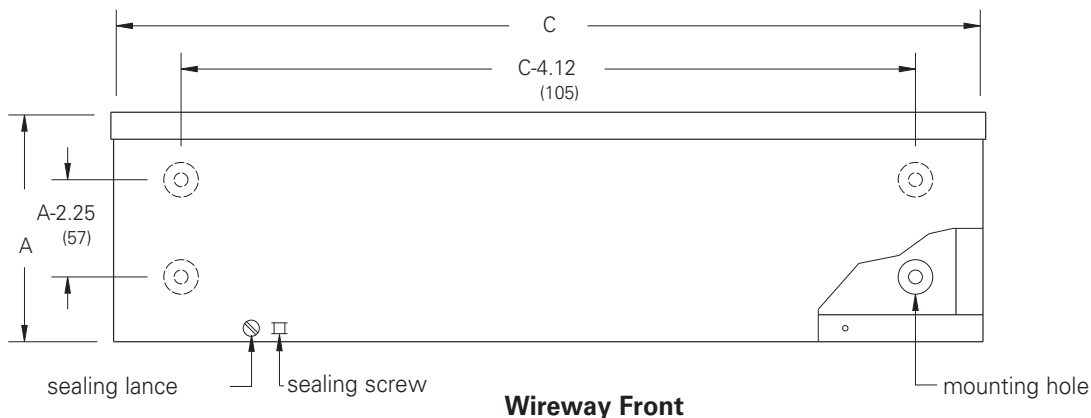

Notes: We can provide special sizes, finishes and other modifications. Consult the factory for your special requirements.

Wiring Troughs Type 3R Screw Cover, Painted & Galvanized Catalog Number

Subclass: AM1 - Painted & Z50 - Galvanized

Wireway Catalog Number				Wireway Size		Knockout Quantity
Painted		Galvanized		Height x Depth x Length		
KO	No KO	KO	No KO	A x B x C		
				in.	mm	Bottom
4412 GRT	4412 GRT NK	--	4412 GRTGV NK	4.00 x 4.00 x 12.00	102 x 102 x 305	3
4418 GRT	4418 GRT NK	--	--	4.00 x 4.00 x 18.00	102 x 102 x 457	5
4424 GRT	4424 GRT NK	--	4424 GRTGV NK	4.00 x 4.00 x 24.00	102 x 102 x 610	7
4436 GRT	4436 GRT NK	--	4436 GRTGV NK	4.00 x 4.00 x 36.00	102 x 102 x 914	11
4448 GRT	4448 GRT NK	--	4448 GRTGV NK	4.00 x 4.00 x 48.00	102 x 102 x 1219	15
4460 GRT	4460 GRT NK	--	4460 GRTGV NK	4.00 x 4.00 x 60.00	102 x 102 x 1524	19
4472 GRT	4472 GRT NK	--	4472 GRTGV NK	4.00 x 4.00 x 72.00	102 x 102 x 1829	23
--	4496 GRT NK	--	--	4.00 x 4.00 x 96.00	102 x 102 x 2438	31
--	44120 GRT NK	--	44120 GRTGV NK	4.00 x 4.00 x 120.00	102 x 102 x 3048	35
6612 GRT	6612 GRT NK	--	6612 GRTGV NK	6.00 x 6.00 x 12.00	152 x 152 x 305	3
6618 GRT	6618 GRT NK	--	6618 GRTGV NK	6.00 x 6.00 x 18.00	1152 x 152 x 457	5
6624 GRT	6624 GRT NK	--	6624 GRTGV NK	6.00 x 6.00 x 24.00	152 x 152 x 610	7
6636 GRT	6636 GRT NK	--	6636 GRTGV NK	6.00 x 6.00 x 36.00	152 x 152 x 914	11
6648 GRT	6648 GRT NK	--	6648 GRTGV NK	6.00 x 6.00 x 48.00	152 x 152 x 1219	15
6660 GRT	6660 GRT NK	--	6660 GRTGV NK	6.00 x 6.00 x 60.00	152 x 152 x 1524	19
6672 GRT	6672 GRT NK	--	6672 GRTGV NK	6.00 x 6.00 x 72.00	152 x 152 x 1829	23
--	6696 GRT NK	--	--	6.00 x 6.00 x 96.00	152 x 152 x 2438	31
--	66120 GRT NK	--	66120 GRTGV NK	6.00 x 6.00 x 120.00	152 x 152 x 3048	35
8812 GRT	8812 GRT NK	--	8812 GRTGV NK	8.00 x 8.00 x 12.00	203 x 203 x 305	3
8818 GRT	8818 GRT NK	--	--	8.00 x 8.00 x 18.00	203 x 203 x 457	5
8824 GRT	8824 GRT NK	--	8824 GRTGV NK	8.00 x 8.00 x 24.00	203 x 203 x 610	7
8836 GRT	8836 GRT NK	--	8836 GRTGV NK	8.00 x 8.00 x 36.00	203 x 203 x 914	11
8848 GRT	8848 GRT NK	--	8848 GRTGV NK	8.00 x 8.00 x 48.00	203 x 203 x 1219	15
8860 GRT	8860 GRT NK	--	8860 GRTGV NK	8.00 x 8.00 x 60.00	203 x 203 x 1524	19
8872 GRT	8872 GRT NK	--	8872 GRTGV NK	8.00 x 8.00 x 72.00	203 x 203 x 1829	23
--	8896 GRT NK	--	8896 GRTGV NK	8.00 x 8.00 x 96.00	203 x 203 x 2438	-
--	88120 GRT NK	--	88120 GRTGV NK	8.00 x 8.00 x 120.00	203 x 203 x 3048	-
--	101024 GRT NK	--	101024 GRTGV NK	10.00 x 10.00 x 24.00	254 x 254 x 610	-
--	101036 GRT NK	--	101036 GRTGV NK	10.00 x 10.00 x 36.00	254 x 254 x 914	-
--	101048 GRT NK	--	101048 GRTGV NK	10.00 x 10.00 x 48.00	254 x 254 x 1219	-
--	101060 GRT NK	--	101060 GRTGV NK	10.00 x 10.00 x 60.00	254 x 254 x 1524	-
--	101072 GRT NK	--	101072 GRTGV NK	10.00 x 10.00 x 72.00	254 x 254 x 1829	-
--	101096 GRT NK	--	101096 GRTGV NK	10.00 x 10.00 x 96.00	254 x 254 x 2438	-
--	1010120 GRT NK	--	1010120 GRTGV NK	10.00 x 10.00 x 120.00	254 x 254 x 3048	-
--	121224 GRT NK	--	121224 GRTGV NK	12.00 x 12.00 x 24.00	305 x 305 x 610	-
--	121236 GRT NK	--	121236 GRTGV NK	12.00 x 12.00 x 36.00	305 x 305 x 914	-
--	121248 GRT NK	--	121248 GRTGV NK	12.00 x 12.00 x 48.00	305 x 305 x 1219	-
--	121260 GRT NK	--	121260 GRTGV NK	12.00 x 12.00 x 60.00	305 x 305 x 1524	-
--	121272 GRT NK	--	121272 GRTGV NK	12.00 x 12.00 x 72.00	305 x 305 x 1829	-
--	121296 GRT NK	--	121296 GRTGV NK	12.00 x 12.00 x 96.00	305 x 305 x 2438	-
--	1212120 GRT NK	--	1212120 GRTGV NK	12.00 x 12.00 x 120.00	355 x 355 x 3048	-
--	141448 GRT NK	--	141448 GRTGV NK	14.00 x 14.00 x 48.00	355 x 355 x 1219	-
--	141472 GRT NK	--	141472 GRTGV NK	14.00 x 14.00 x 72.00	355 x 355 x 1829	-
--	141496 GRT NK	--	141496 GRTGV NK	14.00 x 14.00 x 96.00	355 x 355 x 2438	-
--	1414120 GRT NK	--	1414120 GRTGV NK	14.00 x 14.00 x 120.00	355 x 355 x 3048	-

Notes: Dimensions are in inches. Millimeters shown are for reference only. Data subject to change without notice.

Wiring Troughs Type 12 Lift-Off Cover Data Sheet



Application

- Houses runs of control and power cable
- Protects against circulating dust, falling dirt and dripping noncorrosive liquids

Standards

- UL 870 listed
- CSA C22.2 No. 26 certified
- Conforms to NEMA standard for Type 12

Finish

- Wash and phosphate undercoat
- ANSI 61 gray polyester powder finish
- Hardware and latches are zinc plated

Accessories

- Touch-up paint
- See Accessories section

Construction

- Wireway body and cover are fabricated from (14) gauge steel
- All continuous welded seams are finished smooth
- Cover is secured to the wireway body with semi-hinges on one side and easy-to-operate screw clamps mounted to the opposite side
- Two chains hold cover to the body when screw clamps are released
- Cover has a seamless poured in-place gasket
- External mounting feet are provided for wall mounting

Discount Schedule: C2

Subclass: DB0

Notes: We can provide special sizes, finishes and other modifications. Consult the factory for your special requirements.

Wiring Troughs Type 12 Lift-Off Cover Illustration Sheet and Catalog Number

Subclass: DB0

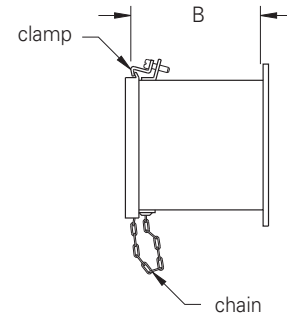
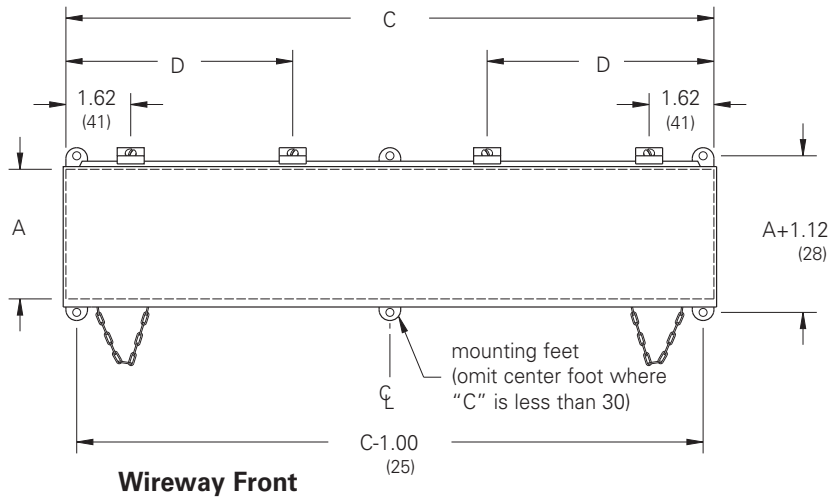

Trough Catalog Number	Trough Size Width x Depth x Length A x B x C		D	
	in.	mm	in.	mm
4412-12WT	4.00 x 4.00 x 12.00	102 x 102 x 305	-	-
4418-12WT	4.00 x 4.00 x 18.00	102 x 102 x 457	-	-
4424-12WT	4.00 x 4.00 x 24.00	102 x 102 x 610	-	-
4430-12WT	4.00 x 4.00 x 30.00	102 x 102 x 762	15.00	381
4436-12WT	4.00 x 4.00 x 36.00	102 x 102 x 914	18.00	457
4448-12WT	4.00 x 4.00 x 48.00	102 x 102 x 1219	24.00	610
4460-12WT	4.00 x 4.00 x 60.00	102 x 102 x 1524	20.25	514
4472-12WT	4.00 x 4.00 x 72.00	102 x 102 x 1829	24.25	616
6612-12WT	6.00 x 6.00 x 12.00	152 x 152 x 305	-	-
6618-12WT	6.00 x 6.00 x 18.00	152 x 152 x 457	-	-
6624-12WT	6.00 x 6.00 x 24.00	152 x 152 x 610	-	-
6636-12WT	6.00 x 6.00 x 36.00	152 x 152 x 914	18.00	457
6648-12WT	6.00 x 6.00 x 48.00	152 x 152 x 1219	24.00	610
6660-12WT	6.00 x 6.00 x 60.00	152 x 152 x 1524	20.25	514
6672-12WT	6.00 x 6.00 x 72.00	152 x 152 x 1829	24.25	616
8812-12WT	8.00 x 8.00 x 12.00	203 x 203 x 305	-	-
8824-12WT	8.00 x 8.00 x 24.00	203 x 203 x 610	-	-
8836-12WT	8.00 x 8.00 x 36.00	203 x 203 x 914	18.00	457
8848-12WT	8.00 x 8.00 x 48.00	203 x 203 x 1219	24.00	610
8860-12WT	8.00 x 8.00 x 60.00	203 x 203 x 1524	20.25	514
8872-12WT	8.00 x 8.00 x 72.00	203 x 203 x 1829	24.25	616



XX12-12WT
XX18-12WT
XX24-12WT

XX30-12WT
XX36-12WT
XX48-12WT

XX60-12WT
XX72-12WT

Cover Clamp Layout

Notes: Dimensions are in inches. Millimeters shown are for reference only. Data subject to change without notice.

Wiring Troughs Type 4X Lift-Off Cover Data Sheet



Application

- Houses runs of control and power cable
- Protects against corrosion, windblown dust and rain, splashing water and hose-directed water

Standards

- UL 870 listed
- CSA C22.2 No. 26 certified
- Conforms to NEMA standard for Type 4X

Finish

- Outer surface of wireway body and cover has a smooth brushed finish

Accessories

- Bracket hanger
- Drop hanger

Construction

- Wireway body and cover are fabricated from (14) gauge Type 304 stainless steel
- All continuous welded seams are finished smooth
- Cover is secured to the wireway body with semi-hinges on one side and easy-to-operate screw clamps mounted to the opposite side
- Two chains hold cover to the body when screw clamps are released
- Cover has a seamless poured in-place gasket
- External mounting feet are provided for wall mounting

Discount Schedule: C2

Subclass: U10

Notes: We can provide special sizes, finishes and other modifications. Consult the factory for your special requirements.

Wiring Troughs Type 4X Lift-Off Cover Illustration Sheet and Catalog Number

Subclass: U10

Trough Catalog Number	Trough Size Width x Depth x Length A x B x C		D	
	in.	mm	in.	mm
4412-4XSWT	4.00 x 4.00 x 12.00	102 x 102 x 305	-	-
4418-4XSWT	4.00 x 4.00 x 18.00	102 x 102 x 457	-	-
4424-4XSWT	4.00 x 4.00 x 24.00	102 x 102 x 610	-	-
4430-4XSWT	4.00 x 4.00 x 30.00	102 x 102 x 762	15.00	381
4436-4XSWT	4.00 x 4.00 x 36.00	102 x 102 x 914	18.00	457
4448-4XSWT	4.00 x 4.00 x 48.00	102 x 102 x 1219	24.00	610
4460-4XSWT	4.00 x 4.00 x 60.00	102 x 102 x 1524	20.25	514
4472-4XSWT	4.00 x 4.00 x 72.00	102 x 102 x 1829	24.25	616
6612-4XSWT	6.00 x 6.00 x 12.00	152 x 152 x 305	-	-
6618-4XSWT	6.00 x 6.00 x 18.00	152 x 152 x 457	-	-
6624-4XSWT	6.00 x 6.00 x 24.00	152 x 152 x 610	-	-
6636-4XSWT	6.00 x 6.00 x 36.00	152 x 152 x 914	18.00	457
6648-4XSWT	6.00 x 6.00 x 48.00	152 x 152 x 1219	24.00	610
6660-4XSWT	6.00 x 6.00 x 60.00	152 x 152 x 1524	20.25	514
6672-4XSWT	6.00 x 6.00 x 72.00	152 x 152 x 1829	24.25	616

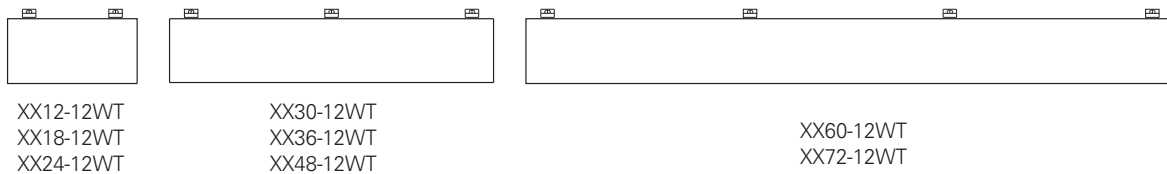
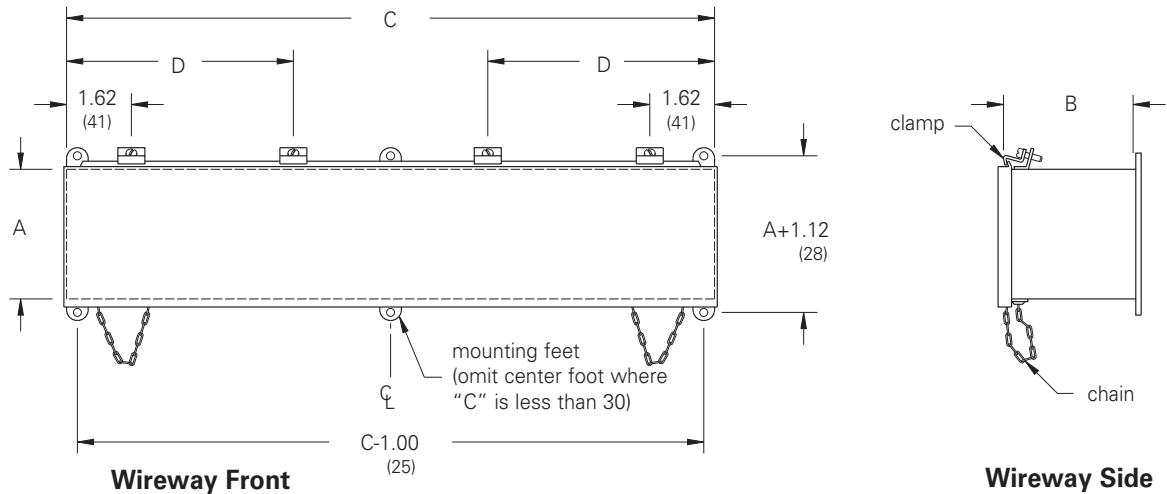

Cover Clamp Layout

Notes: Dimensions are in inches. Millimeters shown are for reference only. Data subject to change without notice.