

VMTM

RUBBER



YOUR ORIGINAL CHOICE





RETREADING



TIRE WORKSHOP



CONVEYOR TOOLS



BLADDERS



CHUCK RE-BELTING



EXTRUDER REPAIR



BUFFERS REPAIR



SOLID TIRES



R 115-25 SJ
Cod.10025



R 105-22 Regular J
Cod. 10019



R 115-16 SJ
Cod. 10023

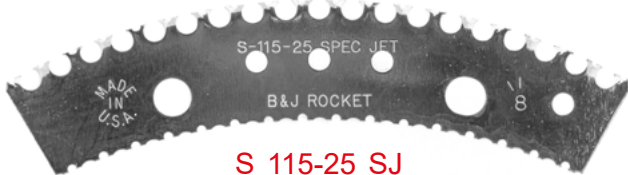

S 115-25 SJ
Cod.10027



R 4-25 SC
Cod. 10029



R 4-25 SJ
Cod. 10022



R 115-25 SC
Cod. 10031



Apollo II
Cod. 10038

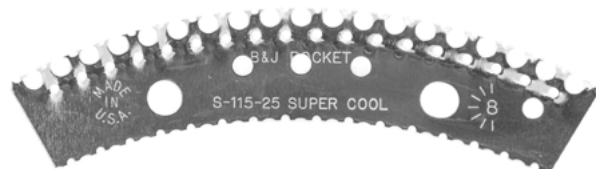

S 115-25 SC
Cod. 10033



Apollo III
Cod. 10040



10075

Code	Spacers
10075	VR 115 1/4" I-Beam
10076	VR 115 3/8" I-Beam
10085	VR 4 1/4" I-Beam
10086	VR 4 3/8" I-Beam
10087	VS 115 1/4" I-Beam
10088	VS 115 3/8" I-Beam



COMPLETE RASP AVAILABLE



10465



10464



10466



10467

FOR OTR TIRES



10469



10468



10470
(conical)

Code	Size	Hole
10464	Ø 30	3/8"
10465	Ø 50	3/8"
10466	Ø 50	1/2"
10467	Ø 50	3/8"
10468	Ø 30	1/2" UNF
10469	Ø 50	1/2" UNF
10470	Ø 50	1/2" UNF
10519	3/8" x16 mm	-
10536	1/2" x16 mm	-
10560	1/2"	-



10519



10536



10560



10481



10476



10478



10477

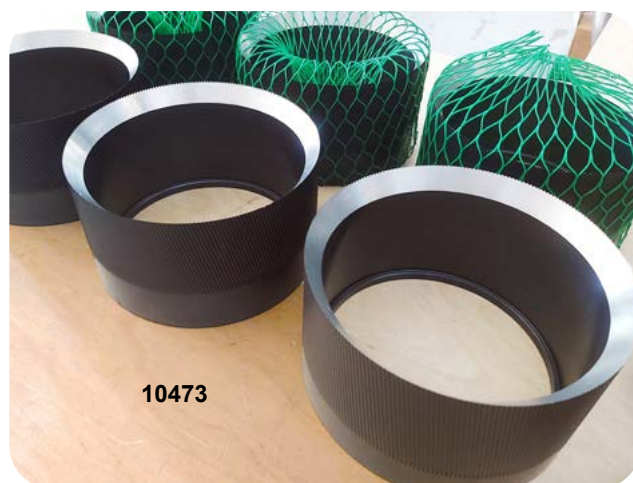

10473

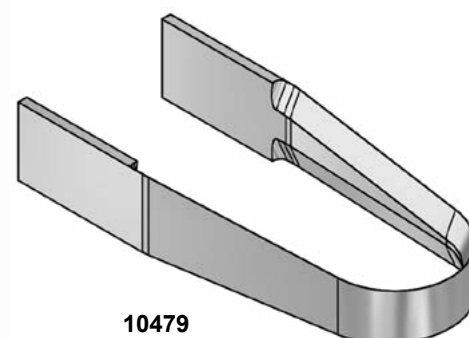
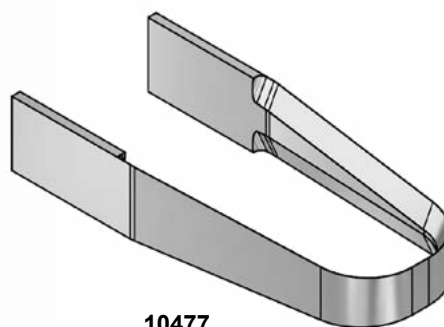
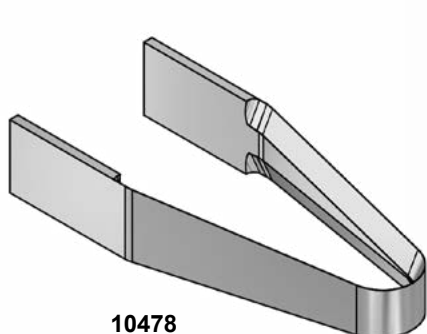

10479

Code	Model	Size	Machine
10473	Scorticatore profilo dentato / Gouges with toothed profile	Ø 160 x 65 - H 90 mm	Marangoni
10474	Scorticatore conico / Conical gouge	Ø 130 x 55 - H 115 mm	Staico / MGT
10476	Scorticatore speciale a mezzaluna / Special half-moon gouge	Ø 95 x 60 mm	-
10481	Scorticatore Cilindrico / Cylindrical gouge	Ø 100 - H 45 mm	-
10477	Coltello scolpitore R25 / Grooving knife R25	210 x 90 x 40 mm R25	MGT / Italmatic
10479	Coltello scolpitore R30 / Grooving knife R30	210 x 90 x 40 mm R30	MGT / Italmatic
10478	Coltello scolpitore R15 / Grooving knife R15	210 x 90 x 40 mm R15	MGT / Italmatic



10111



10112



10113



10114



10115



10116



10117



10118



10119



10120



10127



10132



10136



10142



10143



10144



10145



10146



10147



10148

Code	MFG	Size	Hole	Grit
10111	22 - 01	Ø 65 x 15	3/8"	60
10112	22 - 03	Ø 50 x 5	3/8"	36
10113	22 - 04	Ø 50 x 5	3/8"	16
10114	22 - 05	Ø 50 x 10	3/8"	36
10115	22 - 06	Ø 50 x 10	3/8"	16
10116	22 - 07	Ø 50 x 12	3/8"	36
10117	22 - 08	Ø 50 x 12	3/8"	16
10118	22 - 09	Ø 50 x 19	3/8"	36
10119	22 - 10	Ø 50 x 19	3/8"	16
10120	TCW 210	Ø 50 x 25	3/8"	16
10121	TCW 210	Ø 50 x 25	3/8"	36
10124	TCW 310	Ø 76 x 25	3/8"	16
10125	TCW 310	Ø 76 x 25	3/8"	36
10127	TCW 315	Ø 76 x 38	3/8"	16
10128	TCW 315	Ø 76 x 38	3/8"	36
10132	TCW 415	Ø 102 x 38	3/8"	16
10133	TCW 415	Ø 102 x 38	3/8"	36
10136	TFW 310	Ø 75 x 25	3/8"	16
10137	TFW 310	Ø 75 x 25	3/8"	36

Code	MFG	Shaft	Lenght	Hole	Grit
10141	22 - 11	Ø 20	50	3/8"	36
10142	22 - 12	Ø 20	50	3/8"	16
10143	22 - 13	Ø 20	102	3/8"	36
10144	22 - 14	Ø 20	102	3/8"	16
10145	22 - 15	Ø 6	65	-	36
10146	22 - 16	Ø 6	65	-	16
10147	22 - 17	Ø 6	102	-	36
10148	22 - 18	Ø 6	102	-	16



10268



10287 - 10286



Code	Size	Hole	Grit
10268	200 x 38	60	18
10269	200 x 38	60	36
10270	225 x 38	60	18
10271	225 x 38	60	36
10286	225 x 38	60	16
10287	225 x 38	60	36



10248



10254



10273



10246

Code	Size	Hole	Grit
10254	102 x 38	14	16
10255	102 x 38	14	36
10246	30 x 15	3/8	18
10247	30 x 15	3/8	36
10248	50 x 25	3/8	16
10249	50 x 25	3/8	36
10251	76 x 32	14	16
10252	76 x 32	14	18
10253	76 x 32	14	36
*10273	50 x 25	3/8	36
*10275	65 x 25	3/8	36
*10277	76 x 32	14	36

* PATRIOT



Code	Size	Hole	Grit
10308-1	50 x 5	3/8	16
10309	50 x 7	3/8	16
10309-0	50 x 10	3/8	16
10309-1	50 x 13	3/8	16



10308-1



10309



10309-0



10309-1



Code	Size	Hole	Grit
10238	102 x 19	14	16
10239	102 x 19	14	18
10240	102 x 19	14	36
10241	105 x 13	14	14
10242	105 x 13	14	16
10243	105 x 13	14	18
10244	150 x 32	60	14
10245	150 x 32	60	16
10235	76 x 16	14	14
10236	76 x 16	14	16
10237	76 x 16	14	18



10235



10238



10244

Code	Size	Hole	Grit
10208	50 x 3,5	3/8"	16
10209	50 x 3,5	3/8"	36
10211	50 x 5	3/8"	16
10212	50 x 5	3/8"	36
10214	50 x 7	3/8"	16
10215	50 x 7	3/8"	36
10217	50 x 10	3/8"	16
10218	50 x 10	3/8"	36
10220	50 x 13	3/8"	16
10221	50 x 13	3/8"	36
10223	50 x 19	3/8"	16
10224	50 x 19	3/8"	36
10204	70 x 3,5	3/8"	16
10205	100 x 4	3/8"	16



10208/10209



10211/10212



10214/10215



10217/10218



10220/10221



10223/10224



10204

Code	Size	Shaft	Grit
10225	50 x 3	6	18
10226	20 x 55	6	18
10228	50 x 50	8	18



10225



10226



10228



10175



10174



10171



10173



10172



10183



10182



10181



10180



10179



10178



10177



10176

Code	MFG	Size	Shaft/AH	Grit
10175	635	Ø 25 x 3	Ø 3	390/16
10174	619	Ø 35 x 6	Ø 6	330/24
10171	605	Ø 28	Ø 6	330/24
10173	603	Ø 22	Ø 6	330/24
10172	601	Ø 16	Ø 6	330/24
10183	314	Ø 51 x 19	3/8"	390/16
10182	312	Ø 51 x 19	3/8"	230/36
10181	310	Ø 51 x 13	3/8"	390/16
10180	308	Ø 51 x 13	3/8"	230/36
10179	306	Ø 51 x 10	3/8"	390/16
10178	304	Ø 51 x 10	3/8"	230/36
10177	302	Ø 51 x 6	3/8"	390/16
10176	300	Ø 51 x 6	3/8"	230/36



10155



10162



10159



10167



10161



10163



10164



10165



10297



10187



20109



10188

Code	MFG	Size	Hole	Grit
10167	140	Ø 32 x 18	3/8"	170/60
10157	130	Ø 51 x 19	3/8"	170/60
10166	122	Ø 89 x 38	3/8"	390/16
10165	120	Ø 89 x 38	3/8"	230/36
10164	118	Ø 89 x 38	3/8"	170/60
10163	116	Ø 76 x 32	3/8"	390/16
10162	114	Ø 76 x 32	3/8"	230/36
10161	112	Ø 76 x 32	3/8"	170/60
10160	110	Ø 64 x 25	3/8"	390/16
10159	109	Ø 64 x 25	3/8"	230/36
10158	106	Ø 64 x 25	3/8"	170/60
10156	102	Ø 44 x 19	3/8"	230/36
10155	100	Ø 44 x 19	3/8"	170/60
10187	114X	Ø 76 x 32	3/8"	70 MCM
10188	120X	Ø 89 x 38	3/8"	70 MCM
10297	116X	Ø 76 x 32	3/8"	90 MCM
20109	122X	Ø 89 x 38	3/8"	90 MCM

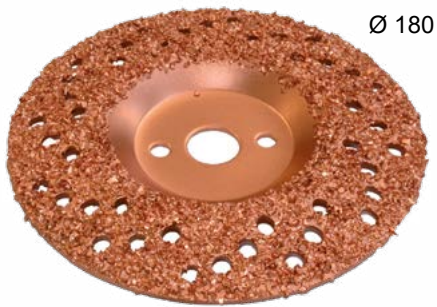

10937/10938

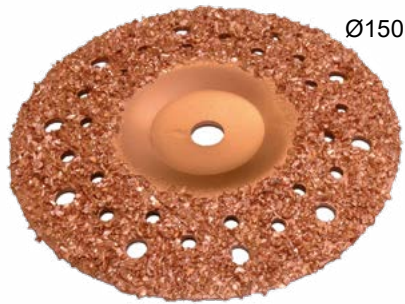

10935/10936

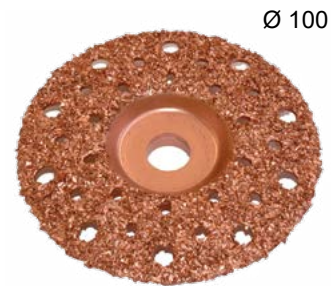

10931/10932



10933/10934

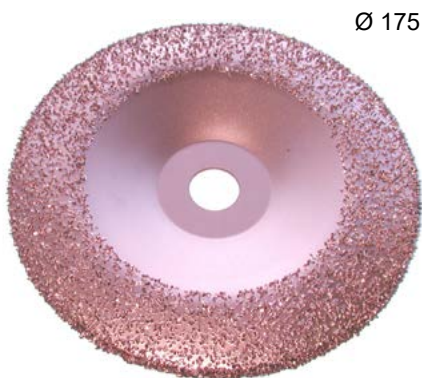

10939/10940

Code	Size	Hole	Grit
10931	Ø 100 x 2	16	18
10932	Ø 100 x 2	16	36
10933	Ø 125 x 2	22	16
10934	Ø 125 x 2	22	36
10935	Ø 150 x 2	13	18
10936	Ø 150 x 2	13	36
10937-1	Ø 180 x 2	22	16
10937	Ø 180 x 2	22	18
10938	Ø 180 x 2	22	36
10939	Ø 175 x 2	22	16
10940	Ø 175 x 2	22	36



10941



10942

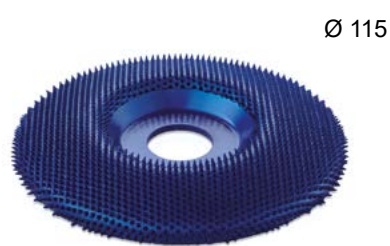

10943

Code	MCM	Size	Hole
10941	120	Ø 170mm	Ø 22
10942	70	Ø 115mm	Ø 22
10943	90	Ø 115mm	Ø 22



10301



10300



10184



10185

Code	MFG	Size	Hole	Grit
10184	711	Ø 200 x 30	60mm	390/16
10185	708	Ø 152 x 35	1½"	390/16
10186	708	Ø 152 x 35	50mm	390/16
10301	711X	Ø 200 x 30	60mm	120 MCM
10300	708X	Ø 152 x 35	50mm	90 MCM



10256 - 10257

Code	Size	Hole	Grit
10257	Ø 150	51mm	80
10256	Ø 150	51mm	60
10259	Ø 180	32mm	80

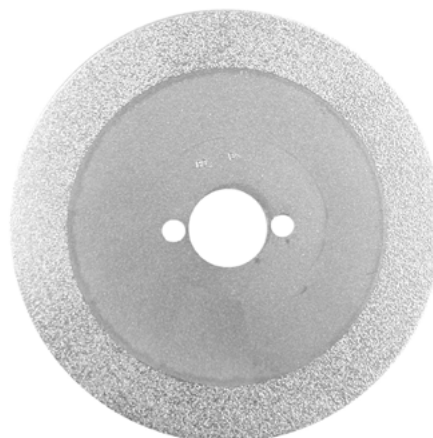

10259



11454

Code	Size	Thickness	Shaft
11452	Ø 40	15	Ø 6
11453	Ø 50	15	Ø 6
11454	Ø 60	20	Ø 6
11455	Ø 40	10	Ø 6



10537



11578

Code	Model	Size	Pin	AH
11578	Concave rasp	Ø 75 x 35	1,5 x 12	-
11576	Spherical rasp	Ø 35	1,5 x 10	-
10280	Tack rasp bands (OX2-R)	Ø 64 x 25	-	-
10281	Tack rasp bands (OX3-R)	Ø 38 x 16	-	-
10282	Rubber flange (HU2)	Ø 64 x 25	-	3/8"
10283	Rubber flange (HU3)	Ø 38 x 16	-	3/8"
10282-1	Rasp Complete	Ø 64 x 25	-	3/8"
10283-1	Rasp Complete	Ø 38 x 16	-	3/8"
10017	B&J R-5	-	-	-
10018	B&J R-6	-	-	-

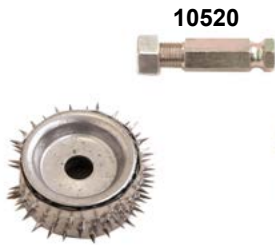

10283-1



10282-1



10280

10282



11576

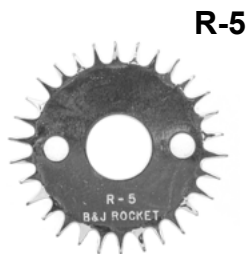

10017



10018



11472

11461

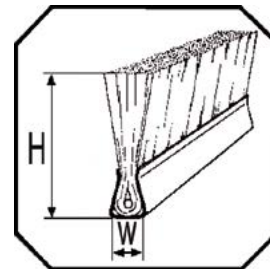

Code	Model
11472	Brush for rubber, made of horsehair, H80 mm W 10 mm sold by meter
11461	Brass brush for rubber, H35 mm W 5 mm sold by half meter



10580 RPM 2.800



10578 RPM 4.500



10588 RPM 3.000



10579 RPM 4.500



10568 RPM 22.000



10566 RPM 22.000



10569 RPM 21.000



10611 RPM 1.200-2.500
Battery-operated



15906



10583 RPM 7.200



10584 RPM 14.600

Code	Model	Rpm	Weight kg
10580	CP 873 Chicago	2.800	0,90
10578	GP 0681	4.500	0,80
10588	ATLAS LSF29 S030	3.000	0,55
10579	GP-0681 (manual torque)	4.500	0,80
10568	CP 872 Chicago	22.000	0,60
10566	GP 0546	22.000	0,57
10569	GP 2751X-2	21.000	0,88
10583	UG 1250L 72	7.200	3,20
10584	UG 65 EBR	14.600	1,5
10611	M12 FUEL - FTB	1.200 - 2.500	1,10
15906	Impact wrench 1" CP 7782-6 2900 Nm		



12647



12622



12623



12625



12666



12650



12654



12655



12651

Code	Model
12622	Pistola spruzzapara 1.8" / Rubber spray gun 1.8"
12629	Silicone liquido / Concentrated liquid silicone 25 kg
12647	Pompa Graco per soluzione / Graco pump for solution
12666	Silicone spray antiadesivo/ Non-stick silicone spay 500 ml
12617	Vernice nera 26Lt / 26Lt Black finishing coat
12650	Graffatrice / Stapler
12651	Punti metallici / Steel staples 12x6 mm
12654	Graffatrice manuale / Manual stapler
12655	Punti per graffatrice manuale / Staples for manual stapler
12623	Pistola airless con ugello / Airless gun with nozzle
12625	Ugello per #12623 / Nozzle for #12623



12617



12629



10390

Code	Model	Rpm	Weight
10390	CP9286	600	1,8kg

Code	Model
10363	Ø 3 x 70
10375	Ø 6 x 90
10376	Ø 8 x 90
10378	Ø 10 x 100
10364	Ø 6 x 90
10366	Ø 4.5 x 90

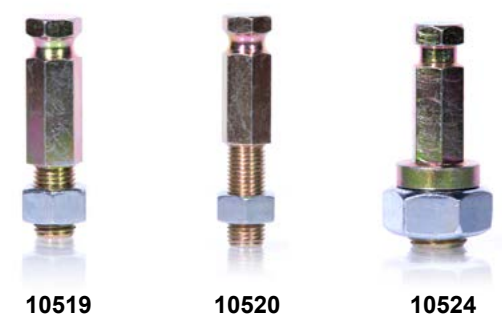
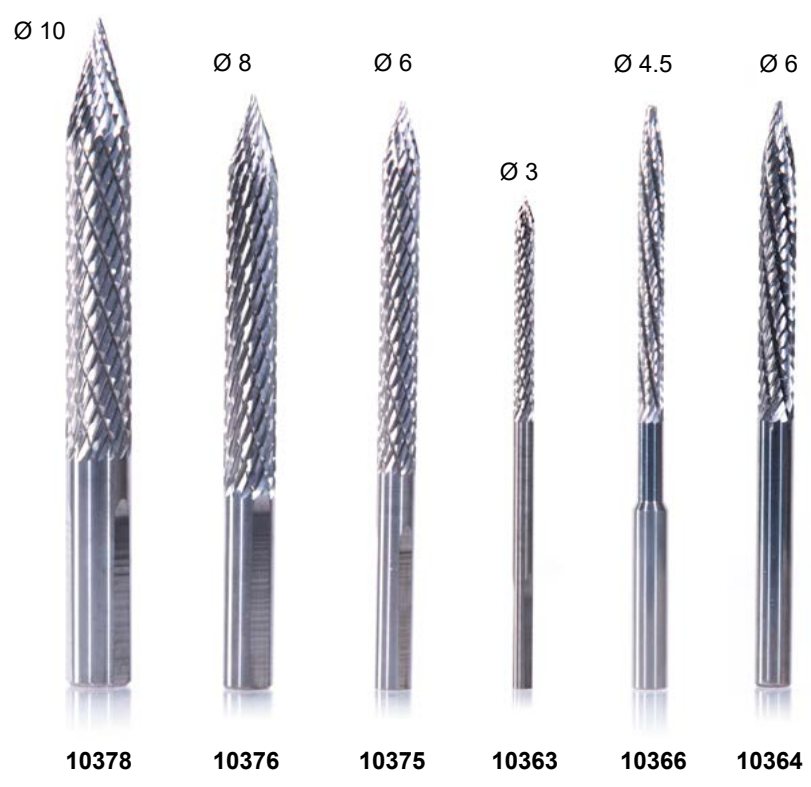

Code	Adapters and chuck
10519	3/8" UNF x 16 mm
10520	3/8" UNF x 25 mm
10530	Ø 3 mm
10531	Ø 5 mm
10532	Ø 6 mm
10533	Ø 8 mm
10534	Ø 10 mm
10524	Ø 14 x 15 mm
10537	Ø 12 x 25 mm for rasp 11578
10550	Ø 6 - 3/8" UNF x 10 mm
10551	Ø 6 - 3/8" UNF x 25 mm
10516	Quick change chuck 3/8" UNF x 24 mm

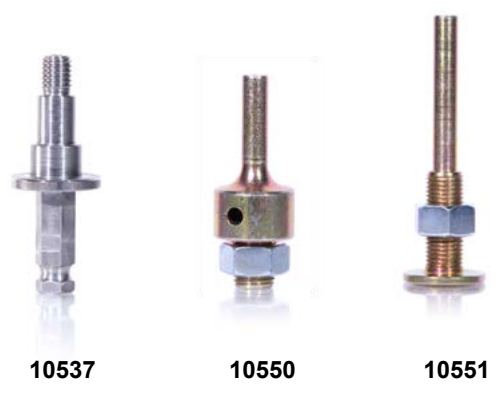



10316
A-1W

10335

10317
A-1B

10355

Ø 8 Ø 8 Ø 10 Ø 10 Ø 10

Ø 20

Ø 15

Ø 20

Ø 10

10315
A-15B

10314
A-15W

10313

10312

10356



10318
Ø 38



10331
Ø 35



10334
Ø 20

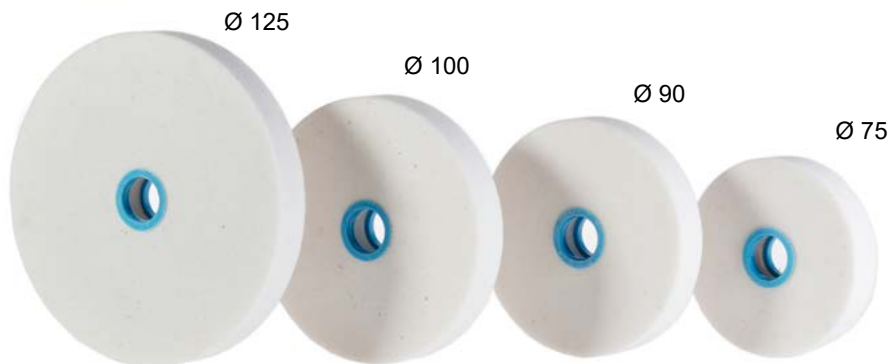

Ø 125

Ø 100

Ø 90

Ø 75

10349

10346

10348

10347

Code	Model	Size	Shaft/AH	Grit
10316	A-1W	Ø 20 x 65	Ø 6	80
10335	-	Ø 15 x 40	Ø 6	80
10317	A-1B	Ø 20 x 65	Ø 6	80
10314	A-15W	Ø 8 x 25	Ø 6	80
10315	A-15B	Ø 8 x 25	Ø 6	80
10313	-	Ø 10 x 30	Ø 6	46
10312	-	Ø 10 x 30	Ø 6	80
10356	-	Ø 10 x 30	Ø 6	60
10318	-	Ø 38	Ø 6	46
10331	-	Ø 35	Ø 6	24
10334	-	Ø 20	Ø 6	80
10355	-	Ø 10 x 30	Ø 6	60
10350	-	Ø 75 x 7	Ø 9,53	80
10330	-	Ø 100 x 10	Ø 10	80
10349	-	Ø 125 x 16	Ø 16	80
10347	-	Ø 75 x 16	Ø 16	80
10348	-	Ø 90 x 16	Ø 16	80
10346	-	Ø 100 x 16	Ø 16	80
10352	-	Ø 100 x 10	Ø 14	24



Ø 75

10350



Ø 100

10352



Code	Model	Size	Shaft	Grit
10322	-	Ø 25 x 8	Ø 6	46
10320	A-37B	Ø 30 x 8	Ø 6	46
10321	A-37W	Ø 30 x 8	Ø 6	80
10357	-	Ø 30 x 8	Ø 6	60
10323	A-36B	Ø 35 x 8	Ø 6	46
10324	A-36W	Ø 35 x 8	Ø 6	80
10325	-	Ø 35 x 8	Ø 6	46
10358	-	Ø 35 x 8	Ø 6	60
10345	-	Ø 25 x 6	Ø 6	80
10326	-	Ø 34 x 6	Ø 6	80
10327	A-36W	Ø 40 x 10	Ø 6	80
10353	-	Ø 40 x 10	Ø 6	60
10336	-	Ø 40 x 10	Ø 6	60
10319	-	Ø 50 x 12	Ø 6	80
10328	-	Ø 40 x 30	Ø 6	80
10354	-	Ø 20 x 40	Ø 6	80
10359	-	150 x 22 x 50	-	60

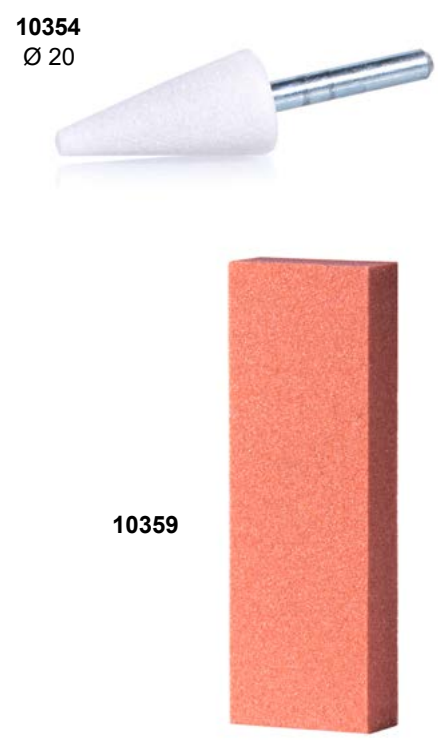

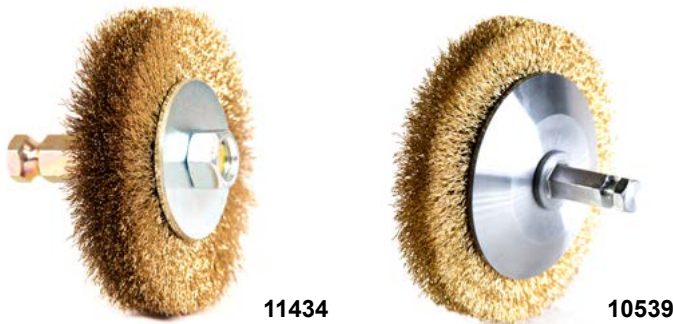

Code	Size	Wire	Hole
11431	Ø 50 x 6	0,25	Ø 3/8"
11432	Ø 76 x 6	0,25	Ø 3/8"
11433	Ø 76 x 6	0,17	Ø 3/8"
11434	Ø 76 x 18	0,17	Ø 3/8"
11437	Ø 90	0,15	Ø 14
11438	Ø 90	0,35	Ø 14
11435	Ø 100	0,30	Ø 30
11436	Ø 100	0,17	Ø 30
11523	Ø 50	14	Ø 6
11473	Ø 50	18	Ø 6
11456	Ø 8x80	0,15	-
10540	Adapter for brushes 11437 and 11438		
10541	Chuck with flange - Recamic style		
10539	Adapter for brushes 11435 and 11436		

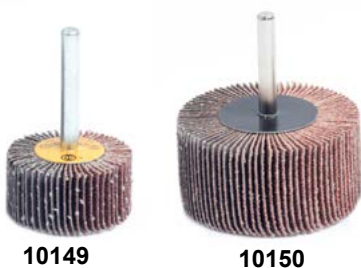

Code	Size	Lenght	Shaft	Grit
10149	Ø 40	20	Ø 6	60
10150	Ø 60	30	Ø 6	60



11451



11450



11444



Code	MFG	Size	Thickness	AH
11442	R8154	Ø 150	43	Ø 77
11444	R8165	Ø 160	45	Ø 77
11447	R8185	Ø 180	45	Ø 77
11448	R8237	Ø 230	60	Ø 77
11449	R8153	Ø 150	30	Ø 80
11451	R82371	Ø 230	60	Ø 100
11450	R8186	Ø 200	40	Ø 100
11445	R8166	Ø 160	50	Ø 77
11446	R8167	Ø 160	60	Ø 77
11465	B8400	Ø 200	38	Ø 50.8
11441	R6153	Ø 150	30	Ø 58
11443	R6152	Ø 150	18	Ø 58
11237	R4103	Ø 100	23	Ø 38/14

11465
BANDAG 8400



11237



11514



11512



11521-1



11519



11521



11518

Code	Size	Thickness	Hole/Shaft	Wire
11512	Ø 50	6	Ø 12.7	-
11514	Ø 75	6	Ø 12.7	-
11521	Ø 50	8	Ø 3/8"	0,15
11518	Ø 80	7	Ø 13	0,15
11519	Ø 65	6	Ø 6	0,15
11521-1	Ø 50	8	Ø 3/8"	0,30
10523	13 mm	20 mm	-	-



10523



11557



11558



11559



11560



11582

Code	Size	Model
11557	Ø 52 x 18	Pin 1,5 x 12
11558	Ø 52 x 27	Pin 1,5 x 12
11559	Ø 52 x 46	Pin 1,5 x 12
11560	Ø 52 x 76	Pin 1,5 x 12
11582	Ø 1,5 x 12	3.000 pcs/box
11604	Ø 1,5 x 12	9.000 pcs/box



11571



11572



11573



11570

Code	Smooth/Liscio
11570	40 x 10 mm
11571	40 x 12 mm
11572	40 x 18 mm
11573	40 x 46 mm



11562



11565



11564



11563



11561



11566



11567



11568



11569

Code	Knurled/Zigrinato
11561	40 x 2,5 mm
11562	50 x 4 mm
11563	38 x 3 mm
11564	38 x 7 mm
11565	25 x 2 mm
11566	40 x 10 mm
11567	40 x 18 mm
11568	40 x 46 mm
11569	40 x 76 mm



11779 - 230V
11780 - 110V



Estrusore Tubeless VMR / VMR Nailhole Extruder Gun

Potenza Trapano / Drill Power	400W
Potenza Elettrica / Electric Power	350W - 230/110V
Temperatura max / Max temperature	120°
Peso / Weight	6,8 kg



11833 - 230V
11834 - 110V

Estrusore VMR 15 kg / VMR Extruder Gun 15 kg

Potenza Trapano / Drill Power	400W
Potenza Elettrica / Electric Power	350W - 230/110V
Temperatura max / Max temperature	120°
Peso / Weight	3,8 kg
Produzione gomma / Rubber production	15kg/h



11870 - 230V
11874 - 110V

Estrusore Bosch VMR / VMR Bosch Extruder

Potenza Trapano / Drill Power	400W
Potenza Elettrica / Electric Power	350W - 230/110V
Temperatura massima / Max temperature	120°
Peso / Weight	3,5 kg
Produzione gomma / Rubber production	17kg/h



11875 - 230V
11876 - 110V

Estrusore VMR OTR / VMR OTR Extruder

Potenza Trapano / Drill Power	400W
Potenza Elettrica / Electric Power	350W - 230/110V
Temperatura max / Max temperature	120°
Peso / Weight	4,5 kg
Produzione gomma / Rubber production	25kg/h



11832

Estrusore Elettrico VMR / VMR Electrical Extruder Gun

Potenza Trapano / Drill Power	780 W
Potenza Elettrica / Electric Power	350W - 230 V
Temperatura Max / Max Temperature	120°
Peso / Weight	5 kg
Produzione di gomma / Rubber Production	18kg/h



11954

Estrusore Elettrico VMR Plus40 / VMR Plus40 Electrical Extruder Gun

Potenza Trapano / Drill Power	780 W
Potenza Elettrica / Electric Power	350W - 230 V
Temperatura Max / Max Temperature	120°
Peso / Weight	6 kg
Produzione di gomma / Rubber Production	40kg/h



11953 - 230V
11953-1 - 110V

Estrusore VMR HD / VMR HD Extruder

Potenza Trapano / Drill Power	680 W
Potenza Elettrica / Electric Power	350W - 230 / 110V
Temperatura Max / Max Temperature	120°
Peso / Weight	3,90 kg
Produzione di gomma / Rubber Production	18kg/h



11950 - 230V
11951 - 230V

Estrusore CP 15 kg / CP Extruder 15 kg

Potenza Trapano / Drill Power	400 W
Potenza Elettrica / Electric Power	350W - 230 / 110V
Temperatura Max / Max Temperature	120°
Peso / Weight	3,85 kg
Produzione di gomma / Rubber Production	15kg/h

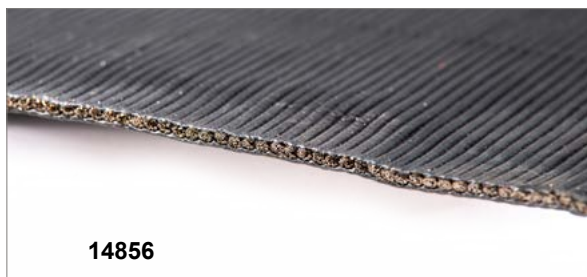

14856

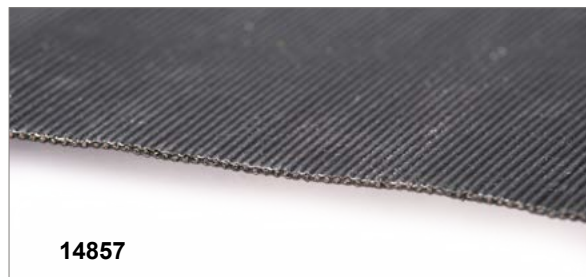

14857

Code	Tessuto in gomma / Rubber Textile / Textile en caoutchouc
14856	Steel cable textile Ø 1,4 mm THK 2,6 mm H 780 mm x 1mt
14857	Steel cable textile THK 1 mm H 850 mm x 1mt
14858	Nylon THK 1 mm H 1400 mm x 1mt
14859	Ryon THK 1 mm H 1430 mm x 1mt
14860	Aramid/Kevlar THK 1 mm H 1400 mm x 1mt
14861	Aramid/Kevlar THK 0,75 mm H 1400 mm x 1mt
14866	Cushion gum THK 1,2 mm L=800 mm Kg 20

Code	Model/Modello	Loading capacity/Capacità di carico	Cable lenght/Lunghezza del cavo
11781	3 - 6A	3 - 6 Kg	2,3 mt
11782	8 - 11A	8 -1 1 Kg	2,3 mt



11754-1



11754



11753



Code	Model
11753	Trafilatore in gomma per riempimento crateri Ø 10 mm - 5 kg / Hole filler strip Ø 10 mm - 5 kg
11754	Gomma per la pulizia dell'estrusore 3x18x300 mm / Cleaning rubber for extruders 3x18x300 mm - 1 box/5 rolls
11754-1	Trafilatore in gomma per riempimento crateri OTR 4X22 mm - 5 kg / Hole filler strip for OTR 4X22 mm - 5 kg

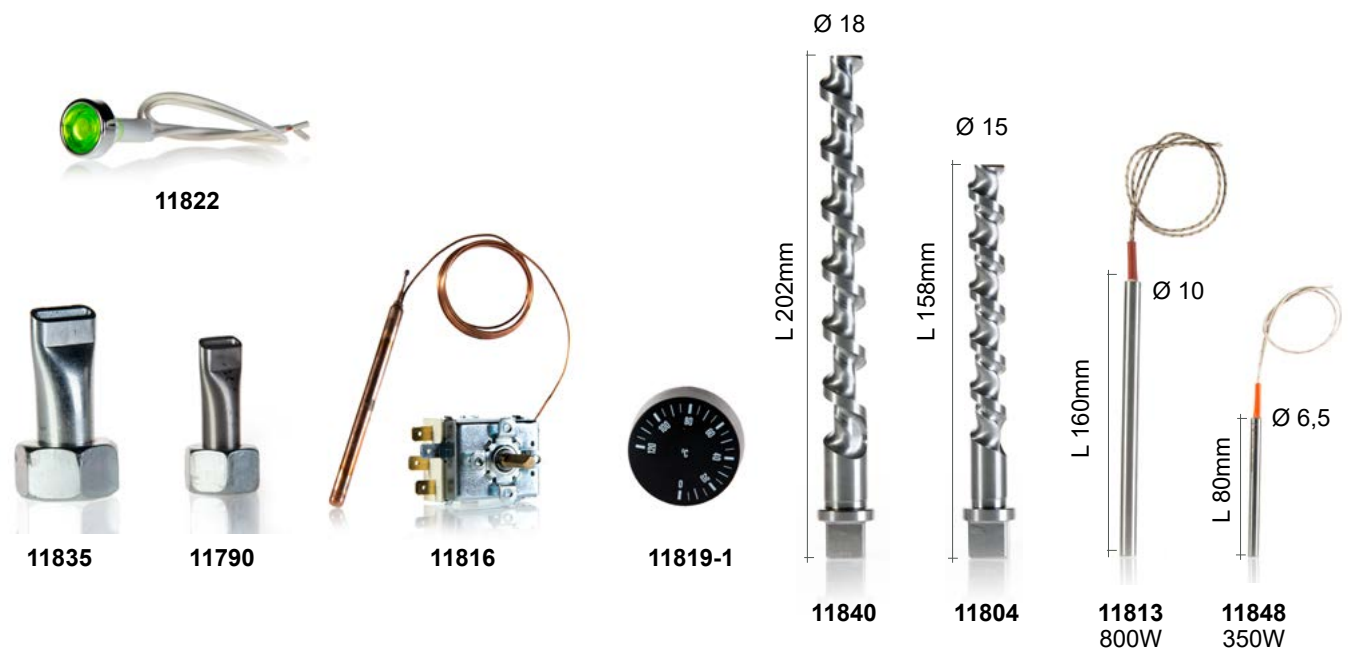

Code	Ricambi / Spare parts (Parte frontale / Barrel)	Suitable for the following extruder models
11804	Vite estrusore / Extruder screw "N"	Mini Bosch - Bosch 400W - Chicago - VMR 15 Kg - VMR Electrical
11840	Vite estrusore / Extruder screw "G"	EM - Giant Bosch - VMR Giant - VMR Plus40
11816	Termostato 0-120 C° / Thermostat 0-120 C°	All models
11819-1	Manopola termostato gradi 0 - 120 °C / Thermostat knob 0-120 °c	All models
11822	Lampada Verde 230V - Pilot light 230V	All models
11848	Resistenza 230V ("N") - Heat Element 230V ("N")	Mini Bosch - Bosch 400W - Chicago - VMR 15 Kg - VMR Electrical - VMR Giant - VMR Plus40
11813	Resistenza 230V ("G") - Heat Element 230V ("G")	EM - Giant Bosch
11790	Ugello "N" / Nozzle "N"	Mini Bosch - Bosch 400W - Chicago - VMR 15 Kg - VMR Electrical
11835	Ugello "G" / Nozzle "G"	EM - Giant Bosch - VMR Giant - VMR Plus40

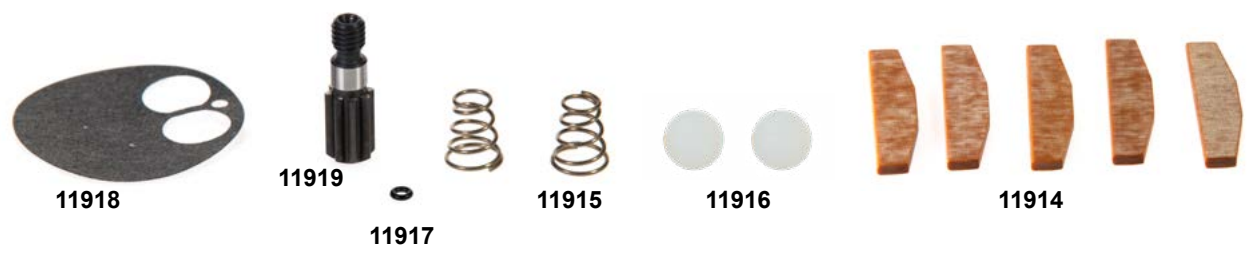

Code	Bosch Spare parts (550W)	Posizione / Position
11919	Pignone	26
11914	Kit Palette	04
11915	Molla / Spring	69
11916	Sfera / Sphere	68
11917	Anello / Ring	79
11918	Piastra di tenuta / Bearing Plate	13



10867



*HANGING SYSTEM ALSO AVAILABLE



10870



10871



10872

Code	Model
10867	Flexible shaft buffers Ø 10 - 1,1 Kw - 380V - 50Hz
10868	Flexible shaft buffers Ø 12 - 1,1 Kw - 380V - 50Hz
10869	Hanging flexible shaft buffers Ø 10 - 1,1 Kw - 380V - 50Hz
10869-1	Hanging flexible shaft buffers Ø 12 - 1,1 Kw - 380V - 50Hz
10870	Metal cover Ø 10
10871	Spare inner shaft Ø 10
10872	Metal cover Ø 12
10873	Spare inner shaft Ø 12

Code	Gessi / Crayons / Craies/ Tizas
11651	Bianco / White / Blanc Ø 13 x 115 box 12Pcs
11652	Giallo / Yellow / Jaune Ø 13 x 115 box 12Pcs



11652



11651



12536



12541



12540



12550



12543



12546



12547

Code	Portalamette/ Bladeholder/ Porte Lame à Èbarber/ Cortador
12540	Portalamete economico / Curved bladeholder / Porte Lame à Èbarber Courbe
12541	Portalamete gigante e regolabile / Giant and adjustable bladeholder / Porte Lame à Èbarber poids-lourds et réglable
12536	Portalamete piatto / Flat bladeholder / Porte Lame à Èbarber plat
12543	Lama 9 denti / Blade 9 teeth / Lame 9 dents
12547	Lama gigante 14 denti curvi / Giant blade 14 curved teeth / Lame géant 14 dents courbe
12550	Trincetto 1 dente / Paring knife 1 tooth / Tranchet 1 dent
12546	Lama gigante 14 denti / Giant blade 14 teeth / Lame géant 14 dents



14862



12612



12613













10586



10587

Code	Tools
12612	Contenitore per colle / Glue boxes / Pot de colle
12613	Spazzola e coperchio per contenitore / Spare lid and brush for glue box / Couvercle et brosse pour le pot de colle 12612
10586	Martello pneumatico/ Pneumatic hammer/ Marteau pneumatique
14862	Talco / Tire talc / Talc / Talco
10587	Martello pneumatico per pneumatici MT / Heavy duty pneumatic hammer / Marteau pneumatique pour pneu GC

Attacchi rapidi con ritegno F Quick Coupler with chech valve F	Attacchi rapidi con ritegno M Quick Coupler with chech valve M	Riduzioni per attacchi rapidi Adapter for quick coupler	Valvole per envelopes Valve for envelopes
<p>BH1-60Y-4FP</p>  <p>1/4" F</p> <p>12919</p>	<p>BH61-711</p>  <p>F 12x1</p> <p>12918</p>		 <p>M 12x1</p> <p>12902</p>
 <p>1/4" F</p> <p>12911</p>	 <p>1/4" F</p> <p>12910</p>	 <p>1/4" M</p> <p>F 12x1</p> <p>12907</p>	 <p>M 12x1</p> <p>12902</p>
 <p>1/4" F</p> <p>12909</p>	 <p>1/4" F</p> <p>12908</p>	 <p>1/4" M</p> <p>F 5/16 UNC</p> <p>12906</p>	 <p>5/16 UNC</p> <p>12901</p>



12792
12793



12795



12834



12836



12838

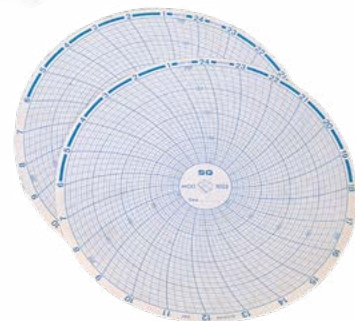

12824



12807

Code	Accessories
12792	Poly roll 1000 m x 350 mm
12793	Poly roll 1000 m x 450 mm
12795	Tubo per autoclave con molla di protezione 1/4" Autoclave hose with protection spring 1/4" Autoclave tuyau avec ressort de protection 1/4"
12802	Tubo per autoclave 1/4" / Autoclave hose 1/4" / Autoclave tuyau 1/4"
12834	Pennino piccolo blu / Small blue pen / Pointe bleu petite
12835	Pennino piccolo rosso / Small red pen / Pointe rouge petite
12836	Pennino medio blu / Medium blue pen / Pointe moyenne bleu
12837	Pennino medio rosso / Medium red pen / Pointe moyenne rouge
12838	Pennino grande verde / Big green pen / Pointe grande vert
12824	Diagrammi mod.6009 / mod.6009 Diagrams / Diagrammes mod.6009
12807	Guarnizione IROP / IROP gasket / Boucle IROP

* Other diagrams and gaskets available



Cod. 12405
230V - 600W



Mod. R	Code	Shape	Width	Depth	Box
	12409	R1	mm 3 - 4	7	20 pcs
	12410	R2	mm 5 - 6	8	20 pcs
	12411	R3	mm 6 - 8	10	20 pcs
	12412	R4	mm 9 - 10	14	20 pcs
	12413	R5	mm 10 - 14	16	20 pcs
	12419	R6	mm 16 - 22	16	10 pcs
Mod. W-C					
	12414	W1	mm 3 - 4	7	20 pcs
	12415	W2	mm 5 - 6	8	20 pcs
	12416	W3	mm 6 - 8	10	20 pcs
	12417	W4	mm 9 - 10	14	20 pcs
	12418	W5	mm 10 - 14	16	20 pcs
	12420	W6	mm 20 - 28	16	10 pcs
	12421	C7	mm 20 - 26	20	10 pcs
	12422	C8	mm 22 - 28	22	10 pcs
	12423	C9	mm 22 - 38	30	10 pcs



12254

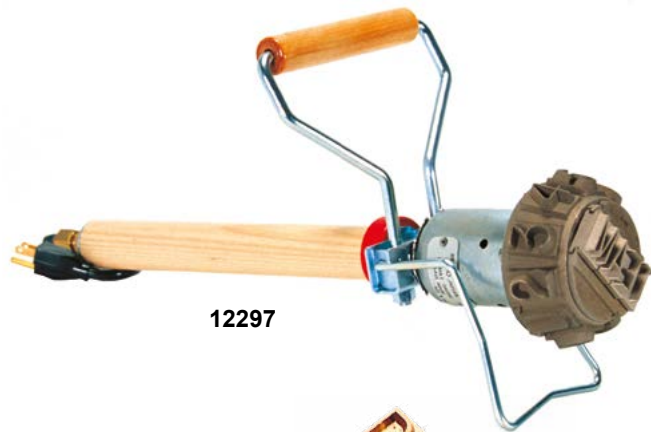

12297

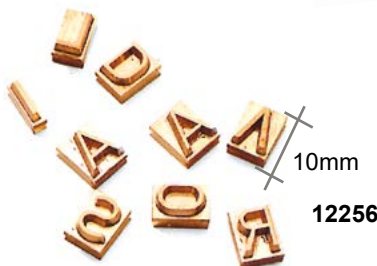

12256



12255



12299

Code	Model
12254	Marcatore 300W / Tire brander 300W / Marqueur 300W
12255	Resistenza per marcatore / Heater for tire brander / Résistance pour marqueur
12256	Alfabeto completo / Complete alphabet / Alphabet complet (10mm)
12257	Numeri / Numbers / Numéros 0-9 (10mm)
12297	Marcatore Helrick #32A / Helrick #32A Tire brander / Marqueur
12299	Alfabeto completo/ Complete alphabet/ Alphabet complet (25mm)

OUTER ENVELOPES

Code	Model	Out. diam. x bead/bead	Size of suggested tires
13246	VMR CMT OUTER-21	mm 1280x650	315/75 R24.5 - 305/80 R24.5 - 295/80 R24.5 - 285/80 R24.5 - 275/80 R24.5 - 12R24.5 - 435/50 R22.5 - 385/65 R22.5 - 315/80 R22.5 - 315/80 R22.5 - 15R22.5 - 13R22.5 - 10/11.00R22 - 365/80 R20 - 335/80 R20 - 12.00R20 - 13/80R20 - 14/80R20 - 445/55 R19.5 - 445/45 R19.5 - 435/50 R19.5 - 425/55 R19.5
13248	VMR CMT OUTER-19	mm 1230x670	305/75 R24.5 - 295/75 R24.5 - 285/75 R 24.5 - 385/65 R22.5 - 315/80 R22.5 - 295/80 R22.5 - 315/75 R22.5 - 315/70 R22.5 - 305/70 R22.5 - 315/60 R22.5 - 305/60 R22.5 - 12R22.5 - 12/70R22.5 - 13/70R22.5 - 13/75R22.5 - 13R22.5 - 11-00R20 - 11R24.5
13250	VMR CMT OUTER-17	mm 1130x617	295/80 R22.5 - 295/75 R22.5 - 275/80 R22.5 - 255/80 R22.5 - 75/70 R22.5 - 255/70 R22.5 - 295/60 R22.5 - 285/60 R22.5 - 12R22.5 - 11/70 R22.5 - 11R22.5 - 10R22.5 - 10.00 R20 - 9.00 R20 - 305/70 R19.5 - 285/70 R19.5
13252	VMR CMT OUTER-15	mm 1030x520	9R22.5 - 8R22.5 - 8.25R20 - 7.50R20 - 7.00R20 - 6.50R20 - 215/75 R 19.5 - 265/70 R19.5 - 245/70 R19.5 - 235/70 R19.5 - 225/70 R19.5 - 9.5R19.5 - 9R19.5 - 8R19.5 - 7R19.5 - 10.5R15 - 10R15
13254	VMR CMT OUTER-13	mm 930x500	235/75 R17.5 - 225/75 R17.5 - 215/75 R17.5 - 205/75 R17.5 - 10R17.5 - 9.5R17.5 - 9R17.5 - 8.5R17.5 - 8R17.5 - 225/74 R16 - 215/75 R16 - 8.25R16 - 8.25R15
13256	VMR CMT OUTER-10	mm 870x420	205/75 R16 - 195/75 R16 - 185/75 R16 - 175/75 R16 - 215R16 - 205R16 - 195R16 - 185R16 - 175R16 - 7.50R16 - 7.00R16 - 6.50R16 - 6.00R16 - 7.50R15 - 7.00R15



Code	Model
13362	Rubber wicking pad 1390 x 170 (1136)
13363	Rubber wicking pad 1300 x 180 (1138)
13364	Rubber wicking pad 850 x 150 (1144)

INNER ENVELOPES

Code	Model	Out. diam. x bead/bead	Size of suggested tires
13231	VMR CMT INNER-41	mm 1300x950x500	445/65 R22.5 – 425/65 R22.5 – 18R22.5 – 16.5R22.5
13234	VMR CMT INNER-39	mm 1200x940x560	305/80 R24.5 – 295/80 R24.5 – 275/80 R25.4 - 285/75 R24.5 - 315/75 R24.5 - 305/75 R24.5 - 295/75 R24.5 – 285/75 R24.5 – 12R 24.5 – 11R24.5 - 12.00R24 – 11.00R24
13235	VMR CMT INNER-38	mm 1150x930x480	385/80 R22.5 – 315/80R22.5 – 15R22.5 – 13R22.5 – 10/11R22 - 365/80 R20 – 14/80R20 – 14.00R20 - 13/80R20 – 13.00R20 - 12.00R20 – 445/65 R19.5 – 18R19.5 – 16.6R19.5 – 15R19.5
13236	VMR CMT INNER-37	mm 1080x900x480	13R22.5 – 13/17R22.5 – 12R22.5 – 11R22.5 - 295/80 R22.5 – 75/80 R 22.5 – 315/75 R22.5 – 13/75R22.5 - 315/70 R22.5 – 305/70 R22.5 - 455/45 R22.5 – 385/55 R22.5 - 11.0R20 – 10.00R20 – 425/55 R19.5
13239	VMR CMT INNER-34	mm 950x465x720	295/60 R22.5 – 285/60 R22.5 – 9R22.5 – 8R22.5 - 8.25R20 – 7.50R20 – 7.00R20 – 6.50R20 - 215/75 R19.5 - 285/70 R19.5 – 265/70 R19.5 - 245/70 R19.5 – 235/70 R19.5 – 225/70 R19.5 - 9.5R19.5 – 9R19.5 – 8R19.5 – 7R19.5
13240	VMR CMT INNER-35	mm 1030x850x480	12/70R22.5 - 11/70R22.5 – 11/R22.5 – 10R22.5 - 275/80 R22.5 – 255/80 R22.5 – 295/75 R22.5 - 305/70 R22.5 – 285/70 R22.5 – 275/70 R22.5 - 255/70 R22.5- 315/60 R22.5 – 305/60 R22.5 - 435/50 R22.5 – 9.00R20 – 10.00R20 – 8.25R20 - 305/70 R19.5 – 285/70 R19.5 – 12R16.5
13242	VMR CMT INNER-33	mm 880x380x700	10R17.5 – 9.5R17.5 – 8.25R16 – 7.50R16 – 7.00R16 - 8.25R15 – 7.50R15 – 7.00R15
13243	VMR CMT INNER-32	mm 800x670x380	9R17.5 – 8.5R17.5 – 8R17.5 – 235/75 R17.5 - 225/75 R17.7 – 215/75 R17.5 - 205/75 R17.5 - 225/75 R16 – 215/75 R16 – 215R16 – 205R16 - 205/75 R16 – 10.5R15 – 10R15
13244	VMR CMT INNER-31	mm 700x315x600	10R16.5 – 205/75 R16 - 195/75 R16 – 185/75 R16 - 650R16 – 600R16 – 250/70 R15 – 700R15 - 205R14 - 195R14





Code	MFG	Size*	Recommended Tires
13184	6299	C1	135-13; 145-13
13185	6228	C2	155-13; 165-13
13186	6297	C3	LIGHT VAN (16/17.5)
13187	6390	C4	LIGHT VAN (14"; 15"; 16"; 17")
13191	2895	C28	TRUCK 20"; 22.5" LARGE
13206	RP20/5	M20/5	TRUCK 20"; 22.5" LARGE



12928
MFG-1121



12929
MFG-1120



12930
MFG-1119

Code	Ø	Size*
12982	-	Piastrella grande per camera di cottura / Rubber base protectors - large type
12983	-	Piastrella piccola per camera di cottura / Rubber base protectors - small type
CURING TUBES - S TYPE		
12994	13	150-13; 155-13; 615-13; 165/70-13; 165/65-13
13002	14	185/60-14; 195/60-14; 185/65-14; 195/65-14; 195/50-15
13009	15	175-15; 185-15; 700-15
13010	15	185/60-15; 195/60-15; 185/65-15; 195/65-15; 205/55-15; 235/75-15; 205/60-15; 205/60-15; 195/50-15
13011	15	205-15; 215-15; 205/70-15; 215/70-15; 205/50-16; 215/55-16; 750-15; 31.10/50-15; 235/75-15; 225/60-16
13014	16	185-16; 185/70-16; 195-16; 195/75-16; 650-16; 19x400; 7-17.5
13016	16	205/55-16
13017	16	750-16; 825-15; 205/75-17.5; 10-16.5; 235/70-16
13018	16	825-16; 825-15; 12-16.5; 37x16; 265/70-16; 265/60-16
13020	17.5	8-17.5; 8.5-17.5; 205/75-17.5; 215/75-17.5; 225/75-17.5; 235/75-17.5; 255/55-18; 235/60-18
13028	22.5	11-22.5; 12-22.5; 295/75-22.5; 275/80-22.5; 295/80-22.5; 1100-22
13029	22.5	315/80-22.5; 315/70-22.5; 13-22.5; 15-22.5; 16.5-22.5
CURING TUBES - R TYPE		
13036	16	185-16; 185/70-16; 195-16; 195/75-16; 650-16; 19X400; 7-17.5
13040	19.5	265/70-19.5; 285/70-19.5; 10.5-18; 12.5-18
13041	19.5	305/70-19.5
13048	22.5	11-22.5; 12-22.5; 295/75-22.5; 275/80-22.5; 295/80-22.5; 1100-22
13049	22.5	315/80-22.5; 315/70-22.5; 13-22.5; 15-22.5; 16.5-22.5
BUTYL FLAPS		
13057	P-22.5	315/80-22.5; 11/12/13-22.5



TRACTOR CURING TUBES - DOBERMANN

Code	Ø	SIZE*
13077	24	11.2/12.4 R24
13079	28	14.9/16.9/18.4 R28
13080	30	14.9/16.9/18.4 R 30
13082	34	14.9/16.9/18.4 R 34

* Su richiesta sono disponibili altre misure / Other sizes available on request



12526

12528



12515

12530



11459



12664



12521



12522



12509



12508



12507



12510



12513

Code	Tools	Size
11459	Spazzola 595 4553 / Brush 595 4553/ Brosse 595 4553	-
12526	Punteruolo conico/ Conical awl / Poinçon conique	8x95mm
12528	Punteruolo punta fine / Fine pointed awl/ Poinçon point fin	Ø 6x90 mm
12530	Forbice per gomma / Shears for rubber/ Ciseaux pour caoutchouc	8" 220 mm
12531	Forbice per gomma / Shears for rubber/ Ciseaux our caoutchouc	10" 290mm
12557	Forbice per gomma / Shears for rubber/ Ciseaux our caoutchouc	12" 305mm
12521	Coltello / knife / Couteau	4 7/8" 120 mm
12522	Coltello / knife / Couteau	4" 100 mm
12508	Coltello / knife / Couteau	6" 150 mm
12509	Coltello / knife / Couteau	8" 220 mm
12507	Coltello / knife / Couteau	4" 100 mm
12510	Scimitarra / Scimitar / Cimenterre	8" 220mm
12511	Scimitarra / Scimitar / Cimenterre	10" 250mm
12512	Coltello / Knife / Couteau	9" 230mm
12513	Trincetto / Shoemaker knife	5" 130mm
12515	Pietra affilalame / Sharpening stone/ Pierre aiguiser	-
12664	Lama di ricambio per tagliarotoli/ Spare blade for roller cutter	250mm



12555

Code	Model	Max. Temperature
12555	Scalda coltelli 230 V - 10" Knife heater 230 V - Knife size 10"	240°



NATIONAL BELTS

Code	Diameter	Width
13620-2	14" - 17"	6 ½" - 165 mm
13625-1	14" - 17"	7 ½" - 190 mm
13622-1	14" - 17"	185 mm
13624-1	14" - 17"	180 mm
13656-1	17" - 20"	8 ¼" - 210 mm
13652-1	17" - 20"	6 ½" - 165 mm
13661-1	20" - 22.5"	8 ¼" - 210 mm
13662-1	20" - 22.5"	9" - 230 mm
13663-1	20" - 22.5"	11 ¾" - 300 mm
13666-1	22" - 24.5"	8 ¼" - 210 mm
13667-1	22" - 24.5"	9" - 230 mm



SERVIZIO SOSTITUZIONE FASCE - EXPANDING CHUCK RE-BELTING

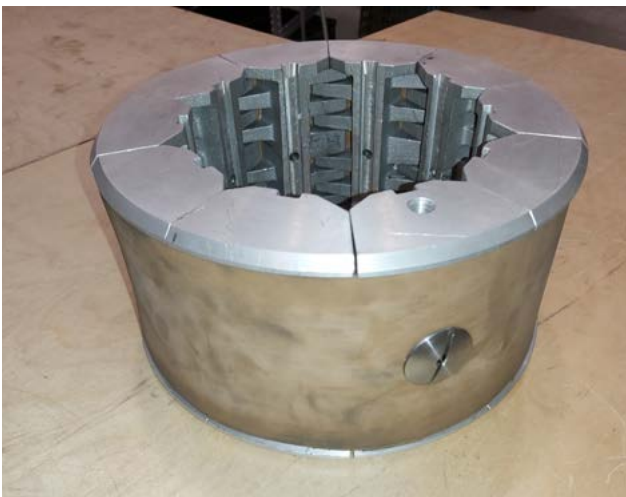

TRM/MARANGONI BELTS

Code	Diameter	Width
13672-1	20" - 22.5"	300 mm
13672-2	20" - 22.5"	230 mm
13672-3	20" - 22.5"	210 mm
13736-2	18" - 20" (19.5"-22.5")	210 mm
13736-3	18" - 20" (19.5"-22.5")	230 mm
13736-4	18" - 20" (19.5"-22.5")	300 mm
13773-1	13" - 15"	170 mm
13773-2	13" - 15"	130 mm
13773-3	13" - 15"	160 mm



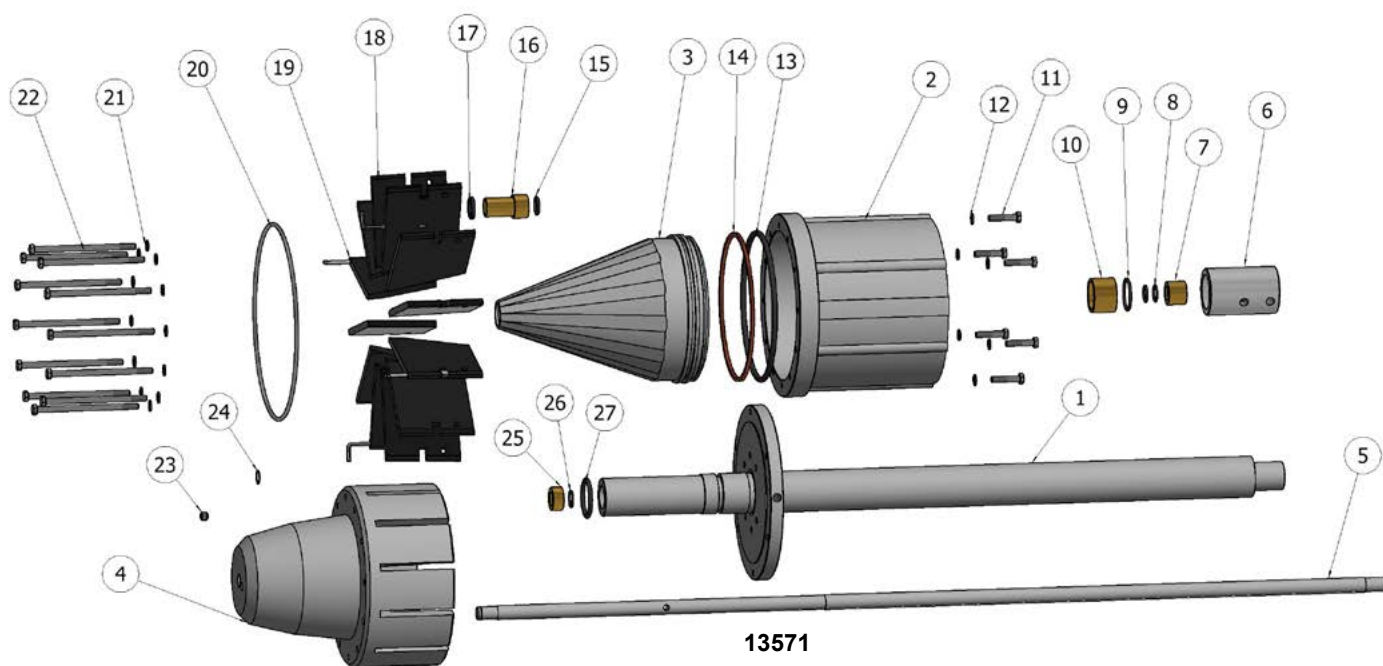

13573

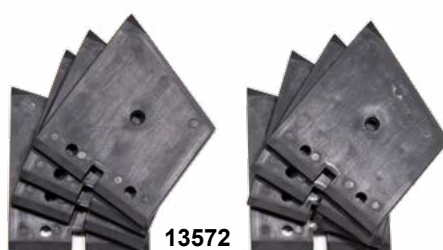

13572



13574



13576

Code	Accessories for Hubs
13572	Aletta senza serraggio 8 pezzi / Stems no lock 8 pcs / Ailettes sans serrage 8 pcs
13573	Aletta con serraggio 4 pezzi / Locking stems 4 pcs / Ailettes avec serrage 4 pcs
13576	Aletta in bronzo 12 pezzi / Brass stems 12 pcs / Ailettes en bronze 12 pcs
13574	Molla di tenuta / Spring / Ressort de fixation
13575	Kit guarnizioni per mandrino National / Gasket set for National chuck

SISTEMA TRDD / TRDD SYSTEM



- Per pneumatici AUTOCARRO da 8.25 fino a 12.00×24 e per pneumatici AGRICOLI da 9.5-32 fino a 12.4-38
- Disponibili anche il sistema di riparazione fianchi (SRS) e il sistema di riparazione talloni (BRS)
- Consigliato per postazioni fisse il sistema TRM copre tutte le misure autocarro e agricolo fino a pneumatici OTR di piccole dimensioni

- For TRUCK tire sizes from 8.25 to 12.00×24 and for AGRI tire sizes from 9.5-32 to 12.4-38
- Available the sidewall system (SRS) and the bead repair system (BRS)
- Suggested for fixed positions, the TRM system covers all the truck and agri sizes up to small OTR tires

Code	Model
TRRS D	Pannello di controllo / Control panel
TRR2213H (220V)	Resistenza interna (tessili) / Inner heat pad (Bias)
TRR2210H (220V)	Resistenza interna (radiali) / Inner heat pad (Radial)
TR911/13W	Cylinder air bag (cuscino)
TR1315/15W	Cylinder air bag (super single)
TRR2213H (220V)	Resistenza esterna / Outside heat pad
TRR2213E (4 Strap)	Cuscino piatto / Flat bag
TROC4	Cinghie / Straps



TRDD Application Chart

TRACTOR/ SECTION WIDTH	TRUCK TYRE SECTION WIDTH	CYLINDER BAG	INSIDE HEAT PAD		OUTSIDE HEAT PAD	OUTSIDE AIRBAG EXTERNAL PACK WITH FLAT BAG & STRAPS	
			BIAS	RADIAL			
9.5 TO 12.4 INCHES	8.25 TO 12.00"	TR911/13W	TRR2213H	TRR2210H	TRR2213H	TRR2213E	TROC 4
260/70R TO 320/85R MM	235 TO 295 MM		TRR2213H	TRR2210H	TRR2213H	TRR2213E	TROC 4
SUPER SINGLE/ WIDE BASE	365/80-22.5 TO 445/65-22.5	TR1315/15W	TRR2213H	TRR2210H	TRR2213H	TRR2213E	TROC 4
THE TRDD SYSTEM CAN BE EXTENDED UPWARDS TO COVER OTR TYRES UP TO 21.00 SECTION WIDTH							
OTR	13.00 TO 17.5" TYRE EXTENSION 330 TO 445 MM	TR1315/20W	MR2519H	MR3015H	MR2621H	TRR2621E	TROC5XL
	18.00 TO 21.00" TYRE EXTENSION 455 TO 530 MM	M1721/24W	MR2519H	MR3015H	MR2621H	TRR621E	TROC5XL

SISTEMA OTR / OTR SYSTEM

- Per pneumatici OTR da 13.00 a 70/70-63
 - Per pneumatici radiali e convenzionali (agricoli)
 - Per fianchi, spalle e battistrada
 - Pannello di controllo consigliato M100 (R-type)
- For OTR tire sizes from 13.00 to 70/70-63
 - For radial and bias tires
 - For sidewall, shoulder and crown
 - Suggested control panel M100 (R-type)

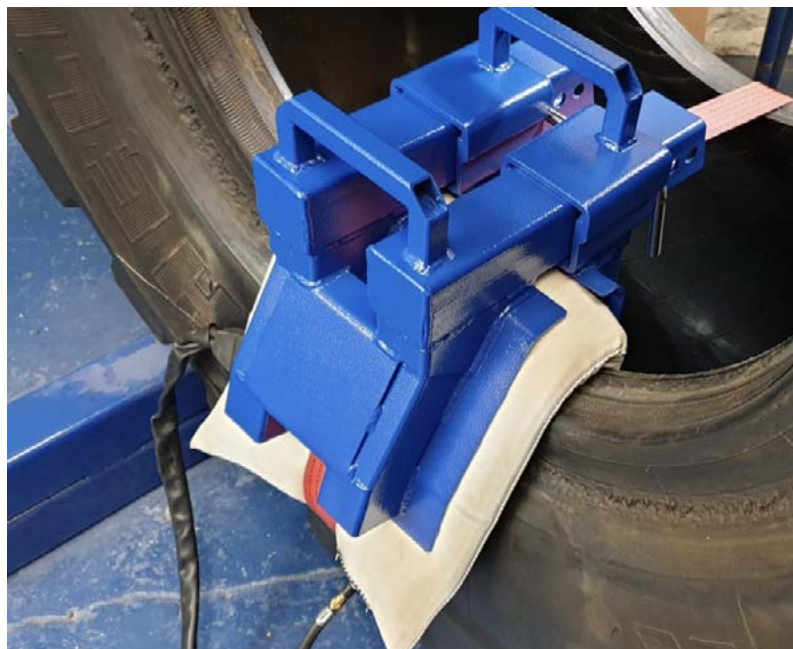

Sistema per fianchi / Sidewall system OTRS
(14.00-24 to 29.5-29) MOTRS (27.00R49 to 45/65R45)

Sistema per talloni / Bead repair system MBRS
(mid-range 18.00R25 to 45/65R45)



Sistema per talloni /
Bead repair system XLBRS (giant OTR 40.00 R57 and 59/85R63)

SISTEMA OTR E RICAMBI

OTR SYSTEM AND REPLACEMENT PARTS



14693

RESISTENZE / HEAT PADS



14702

COPERTURE AIRBAGS / AIRBAG COVERS



14719

Our Application Chart

WIDE BASE	TYRE SECTION (INCHES)	CYLINDER BAG	INSIDE FLAT BAG	INSIDE HEAT PAD		OUTSIDE HEAT PAD	EXTERNAL PACK WITH FLAT BAG & STRAPS
				BIAS	RADIAL		
14.4-24 TO 16.9-38	13.00 TO 17.5	TR1315/20W		MR2519H	MR3015H	TRR2621H	TRR2621E WITH TROC5XL STRAPS
18.4-34 TO 20.8-42	18.00 TO 21.00	M1721/24W		MR2519H OR MR2626H	MR3015H	TRR2621H	TRR2621E WITH TROC5XL STRAPS
23.1-26 TO 30.5-32	23.5 TO 26.5	M1721/24W	MR4824	MR2519H OR MR2626H	MR3015H	TRR2621H	TRR2621E WITH TROC5XL STRAPS
25/65-25	27.00 TO 29.5	M1721/24W	MR4824 MR5432*	MR2519H OR MR2626H	MR3015H OR MR4220H	TRR2621H	TRR2621E WITH TROC5XL STRAPS
35/65-33 TO 45/65-45	30.00 TO 37.5	M2732/32W	MR5432	MR3132H OR MR2626H	MR4220H OR MR4224H	MR2626H OR MR3132H	MR4832E WITH M45/6/7 (1HG) 6 STRAPS
49.5/85-57 TO 50/65-51	40.00	M3842/32W		MR3132H OR MR2626H	MR4220H OR MR4224H OR MR4824H OR MR5224H	MR2626H OR MR3132H	MR4832E WITH M45/6/7 (1HG) 6 STRAPS
46/90-57		M3842/32W	MR5432*		MR4220H OR MR4224H OR MR4824H OR MR5224H		
50/80-57 TO 55/80-57		M4447/32W		MR3132H OR MR2626H	MR4220H OR MR4224H OR MR4824H OR MR5224H	MR2626H OR MR3132H	MR4832E WITH M45/6/7 (1HG) 6 STRAPS
53.5/85-57 53.5/85-63 55.5/80-57 55.5/85-57 55.5/85-63		M4447/32W	MR7532 OR MR9032	MR3132H OR MR2626H	MR4220H OR MR4224H OR MR4824H OR MR5224H	MR2626H OR MR3132H	MR4832E WITH M45/6/7 (1HG) 6 STRAPS
59/80-63 60/80-57 70/70-57		M5054/32W	MR9032	MR3132H OR MR2626H	MR4220H OR MR4224H OR MR4824H OR MR5224H	MR2626H OR MR3132H	MR4832E WITH M45/6/7 (1HG) 6 STRAPS

*When repairing 27.00" through 29.5" section widths in Bias tyres, it may be necessary to use a MR5432 to fully cover the patch.
For certain brands of 46/90-57 tyres, it may be necessary to also use an MR5432 inside Flat Airbag to fully fill the section void.



11703



11709



11708



11706



11712



11713



11707

Code	Model
11703	Misuratore di profondità per battistrada base 70 mm profondità 50mm / Tread depth gauge, 70 mm base 50mm depth Calibre pour chape de pneu avec 70 mm de base profondeur 50 mm
11709	Misuratore di profondità a quadrante per battistrada / Tread depth dial gauge Calibre avec cadran pour chape de pneu
11706	Misuratore profondità battistrada base 200 mm / Tread depth gauge, 200 mm base
11707	Metro in acciaio 3m / 3m steel tape
11708	Nastro in fibra di vetro 10 m / 10 m fiber glass tape / Ruban fibre de verre 10 mètres
11712	Durometro 0-100 shore A / Durometer 0-100 shore A / Duromètre 0-100 shore A
11713	Durometro digitale 0-100 shore A / Digital durometer 0-100 shore A / Duromètre numérique 0-100 shore A



12641



*

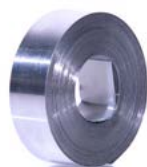

12642



12646

12645

Code	Model
12641	Incisore di etichette in alluminio e acciaio / Steel and aluminum engraver
12642	Nastro in alluminio 12,7 mm x 3,66 m / Aluminium Tape / Bande en aluminium / Cinta en aluminio
12643	Nastro in acciaio 12 mm x 6,40m/Steel Tape / Bande en acier/Cinta en acero
12645	Raschiatore per numeri di serie / Serial number remover / Raclette pour numéros de série
12646	Lama ricambio per raschiatore per numeri di serie / Spare blade for serial number remover/ Lame de rechange pour raclette

* Targhette in alluminio per marcatura su richiesta / Aluminium labels on request



13895

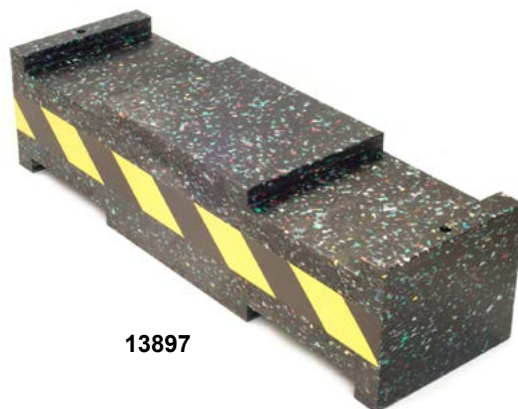

13897

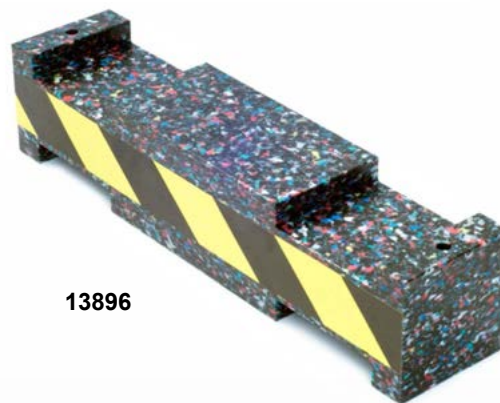

13896

Code	Size	Load rate
13896	100 x 100 L=460 mm	1 block = 50 t 6 blocks = 240 t
13897	150 x 177 L= 600 mm	1 block = 80 t
13895	300 x 300 x 40 mm	6 blocks = 420 t



14636

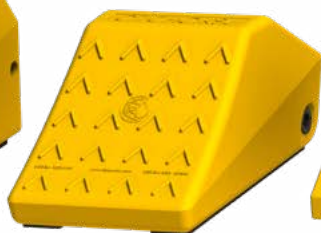

14635

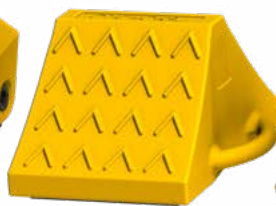

24606

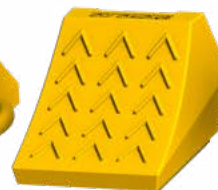

24605



14634

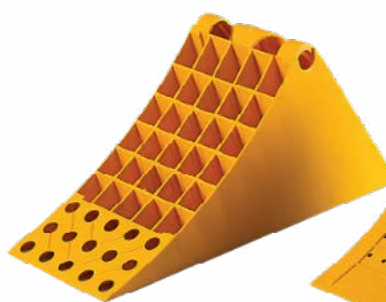

14609



14608

Code	Model	Size	Weight
14634	HD-055	170H x 290L x 210W	1,2 KG
24605	HD-065	230H x 380L x 280W	4 KG
24606	HD-075	260H x 560L x 390W	8 KG
14635	HD-105	280H x 560L x 380W	16 KG
14636	HD-155	410H x 660L x 420W	18 KG
14608	Medium yellow	190H x 380L x 160W	1,07 KG
14609	Big yellow	230H x 470L x 200W	1,45 KG



12659
 13mm / 340mm (Max)
 (1/2" - 13 1/2")



14416



12658
 90mm / 360mm (Max)
 (3 1/2" - 14")

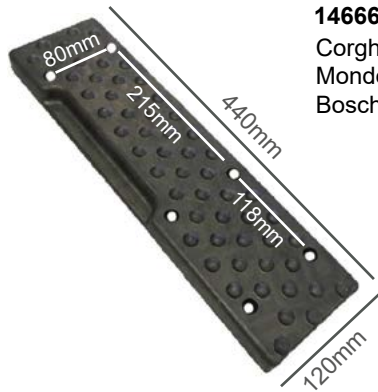

14666
 Corghi/Sicam/Sice
 Mondolfo ferro
 Bosch/Giuliano

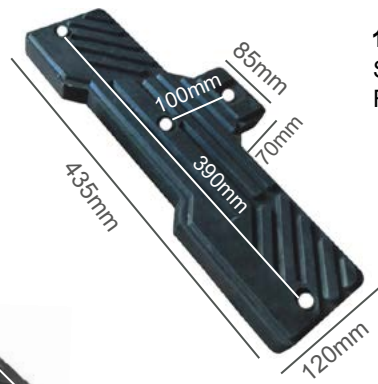

14667
 Sice / Werther
 RP Tools / Cemb

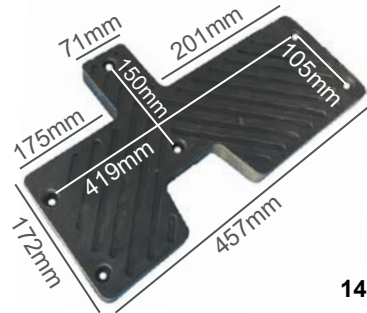

14670
 Ravaglioli/Space
 Butler/Sirio



14668
 Ravaglioli/Butler
 Sirio/Hunter
 Space



14669
 Ravaglioli/Butler
 Sirio/Hunter
 Space





14656



10542



14657

Code	Model
12659	Divaricatore manuale / Manual tire spreader / Ouvre-pneus / Abridor 13-340 mm
12658	Divaricatore/Tire spreader/Ouvre-pneus/Abridor 90-360 mm
14666	
14667	Tamponi in gomma per smontagomme
14668	Rubber pads for tire changers
14669	Appui en caoutchouc pour démonte pneus
14670	Tacos de goma para desmontadoras de neumáticos
14327	Anello di gonfiaggio 22.5" / Pump ring 22.5" / Anneaux de gonflage 22.5" / Aro de cierre 22.5"
14416	Premi talloni / Rim clamp / Pince pour jantes / Cuñas presiona talones
14671	Bazooka bead booster / Canon pour pneus tubless / Calderines talonadores 6L
14672	Bazooka bead booster / Canon pour pneus tubless / Calderines talonadores 9L
14673	Bazooka bead booster / Canon pour pneus tubless / Calderines talonadores 12L
13727	Aspiratore per pneumatici / Tire vacuum / Aspirateur pour pneus / Aspirador para neumáticos
14656	Mola in gomma rimuovi adesivi / Removing tape rubber wheel / Meule pour enlever les adhésif / Eliminador adhesivo
14657	Mola dentata in gomma rimuovi adesivi / Removing tape cogged rubber wheel / Meule dentée pour enlever les adhésif / Eliminador adhesivo dentado
10542	Gambo esagonale per ruota in gomma 14656/14657 / Hexagonal adapter for rubber wheels / Tige hexagonal pour meule / Adaptadore hexagonal para eliminador adhesivo 14656/14657
14660	Pistola di gonfiaggio Eurodainu Wonder / Inflating gun Eurodainu Wonder / Contrôleurs de pression Eurodainu Wonder / Manometro Eurodainu Wonder



14660



14327



14671

14672

14673

Cod. 14069

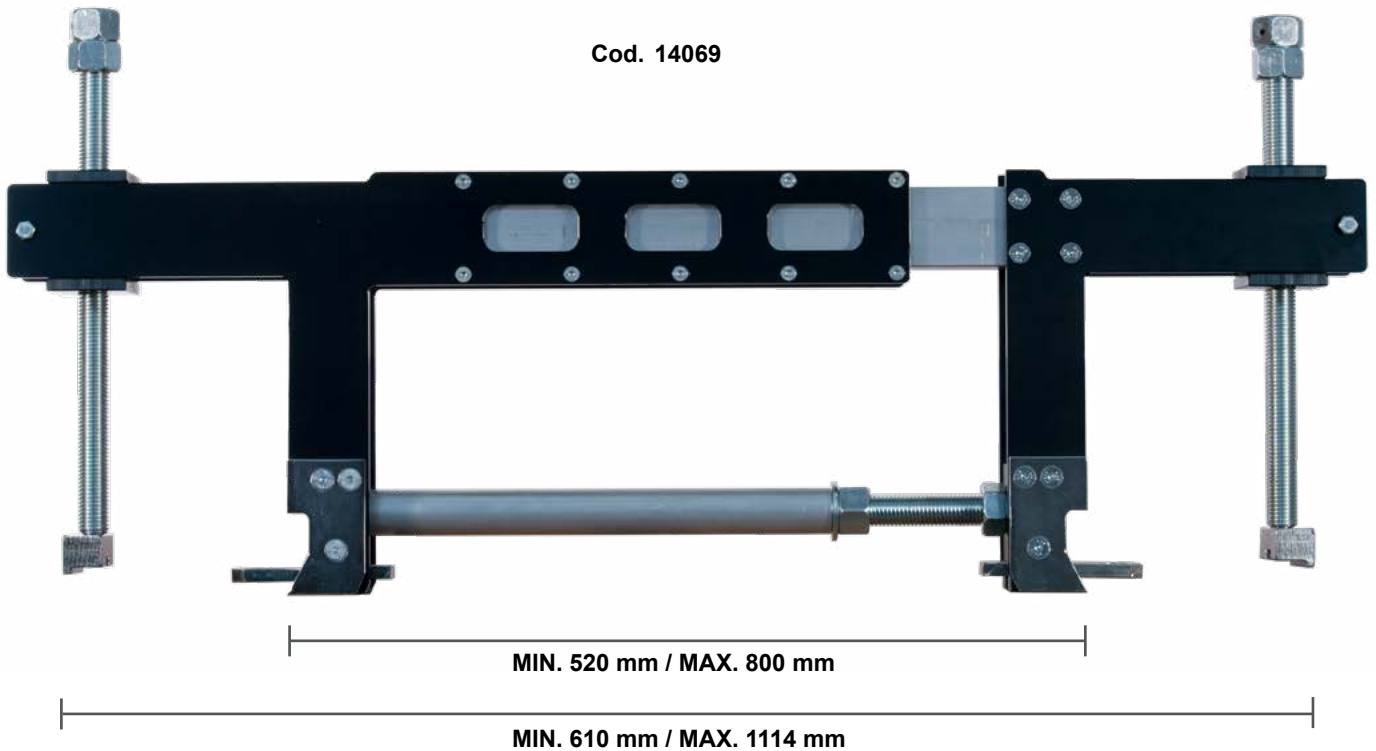

STALLONATORE MANUALE VMR / VMR O-RING INSTALLER

Peso / Weight	16,75 kg
Materiale / Material	Alluminio / aluminium
Corsa / Stroke	610 - 1.114 mm
Cerchi / Rim sizes	25" - 51"

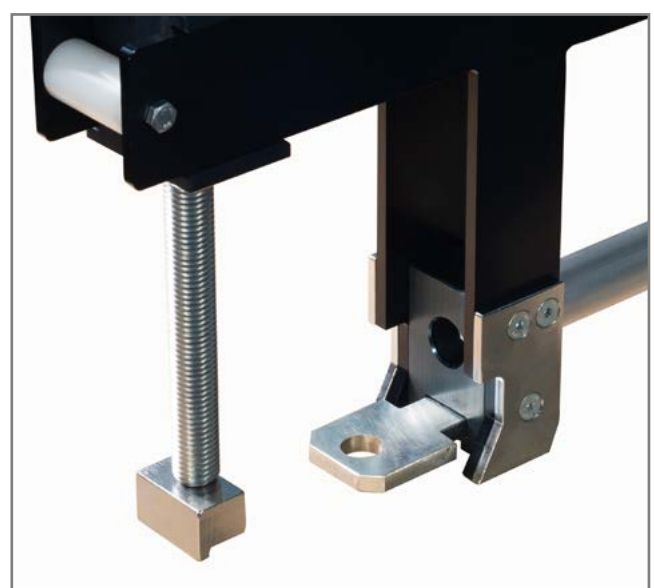



13884



18000

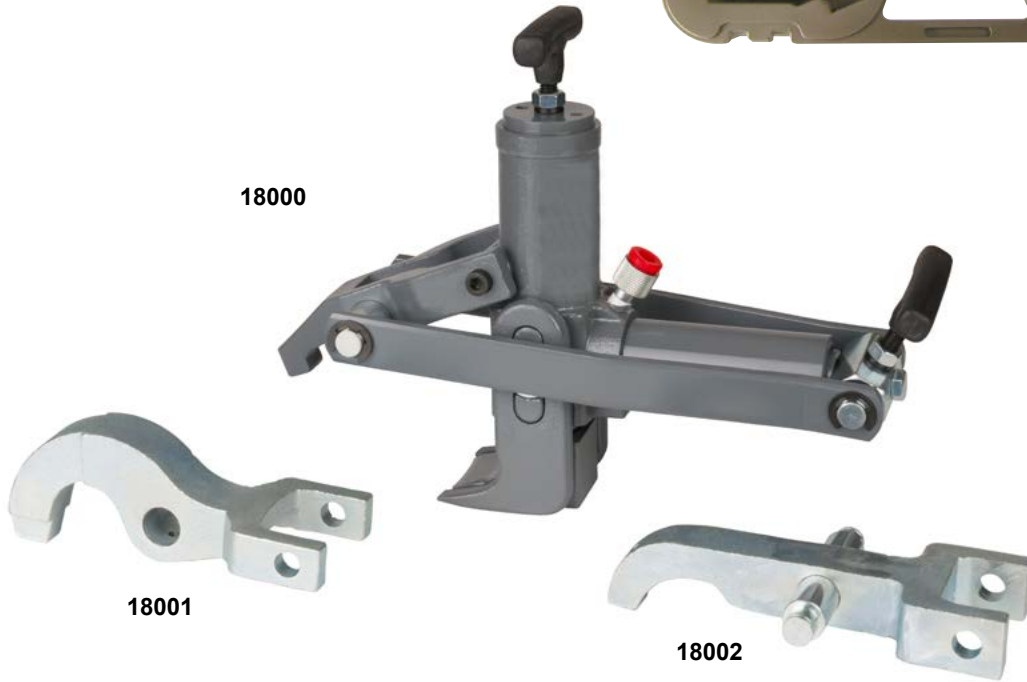

18001

18002

17200



Code	Model
13884	Stallonatore agricolo / Agricultural Bead Breaker
18000	Stallontore agricolo-OTR cerchio 3 pezzi potenza 5000Kg/ AGRI-OTR 3 piece 5000 Kg force bead breaker
18001	Unghia per interni raggiata / Special radial long claw
18002	Unghia per interni diritta / Special straight long claw
17200	Stallonatore MAXI LEM F potenza 4536 Kg/ Hydraulic bead breakers MAXI-LEM F force 4536 Kg



Code	Model
14337	Anelli in gomma o-ring 14-16.5" / Tire bead seaters o-ring 14-16.5"
14338	Anelli in gomma o-ring 16.5-17.5" / Tire bead seaters o-ring 16.5-17.5"
14340	Anelli in gomma o-ring 22.5"-24.5" / Tire bead seaters o-ring 22.5"-24.5"



Code	Model
13897-1	O-Ring Haltec 24" Ø 6.60 mm / Ø 0.26" (OR-224-TG)
13898	O-Ring Haltec 25" Ø 6.60 mm / Ø 0.26" (OR-25-T)
13898-1	O-Ring Haltec 25" Ø 6.60 mm / Ø 0.26" (OR-225-T GRADER)
13899	O-Ring Haltec 25" Ø 9.52 mm / Ø 0.375" (OR-325-T)
13900	O-Ring Haltec 29" Ø 9.52 mm / Ø 0.375" (OR-329-T)
13901	O-Ring Haltec 33" Ø 9.52 mm / Ø 0.375" (OR-333-T)
13902	O-Ring Haltec 35" Ø 9.52 mm / Ø 0.375" (OR-335-T)
13903	O-Ring Haltec 39" Ø 9.52 mm / Ø 0.375" (OR-339-T)
13904	O-Ring Haltec 45" Ø 9.52 mm / Ø 0.375" (OR-345-T)
13905	O-Ring Haltec 49" Ø 9.52 mm / Ø 0.375" (OR-349-T)
13906	O-Ring Haltec 51" Ø 12.7 mm / Ø 0.50" (OR-451-T)
13907	O-Ring Haltec 57" Ø 12.7 mm / Ø 0.50" (OR-457-T)



13886
(1,4l.)



13887



13889



13888
(5l.)



13890



13891



17900

17901

Code	Model
13886	Centralina idraulica hp 700 bar - 1,4 l / Pompe hydraulique hp 700 bar - 1,4 l / Air hydraulic pump hp 700 bar - 1,4 l - 1,4 l / Bomba Hidraulica hp 700 bar - 1,4 l
13887	Tubo flessibile per centralina idraulica l= 2000 mm / Flexible l= 2000 mm/ Flexible hose l=2000 mm / Latiguillo l= 2000 mm
13888	Centralina idraulica hp 700 bar - 5 l / Pompe hydraulique hp 700 bar - 5 l / Air hydraulic pump hp 700 bar - 5 l - 1,4 l / Bomba Hidraulica hp 700 bar - 5 l
13889	Pompa idraulica manuale 700 bar / Pompe manuelle a piess 700 bar/ Manual hydraulic pump 700 bar / Bomba manual 700 bar
13890	Innesto femmina / Femâle raccord Female quick coupler / Enchufe hembra
13891	Innesto maschio / Mâle raccord Male quick coupler / Enchufe macho
17900	Spessore antiscivolo cu/3/4 / "Anti-slip" wedges cu/3/4
17901	Spessore antiscivolo cu/1/4 / "Anti-slip" wedges cu/1/4

Code	Model		
14610	Adatto per / Suitable for: RAVAGLIOLI/SIRIO/SPACE OD = 100 mm ID = 85 mm THK = 8,5 mm		
14611	Adatto per / Suitable for: RAVAGLIOLI/WERTHER OD = 123 mm ID = 108 mm THK = 10 mm		
14612	Adatto per / Suitable for: RAVAGLIOLI/WERTHER OD = 123 mm ID = 108 mm THK = 10 mm		
14613	Adatto per / Suitable for: RAVAGLIOLI/SIRIO/SPACE OD = 130 mm ID = 125 mm THK = 10 mm		
14614	Adatto per / Suitable for: OMNC OD = 145 mm HØ = 12 mm THK = 25 mm		
14615	Adatto per / Suitable for: RAVAGLIOLI OD = 150 mm ID = 135 mm THK = 10 mm		
14616	Adatto per / Suitable for: RAVAGLIOLI OD = 120 mm ID = 110 mm THK = 27 mm		
14617	Adatto per / Suitable for: OMNC OD = 140 mm ID = 133 mm HØ = 12 mm THK = 27 mm		
14618	Adatto per / Suitable for: RAVAGLIOLI OD = 145 mm ID = 135 mm THK = 26 mm		
14619	Adatto per / Suitable for: LAUNCH/TWIN BUSCH/RP TOOLS OD = 120 mm ID = 108 mm HØ = 9 mm H DIST. = 70 mm THK = 32 mm		

Code	Model		
14620	Adatto per / Suitable for: J.A.B.BECKER/ATH/HOFMANN/HERMANN OD= 120 mm ID = 110 mm HØ= 9 mm THK = 4 mm		
14621	Adatto per / Suitable for: J.A.B.BECKER/ATH/HOFMANN/HERMANN OD= 120 mm ID = 110 mm HØ= 9 mm THK = 4 mm		
14622	Adatto per / Suitable for: J.A.B.BECKER/ATH/HOFMANN/HERMANN OD= 120 mm ID = 110 mm HØ= 6 mm THK = 8 mm		
14623	Adatto per / Suitable for: MAHA OD= 120 mm ID = 113 mm HØ = 9 mm H DIST. = 83 mm THK = 8 mm		
14624	Adatto per / Suitable for: MAHA OD= 120 mm ID = 113 mm THK = 8 mm HØ = 9 mm H DIST. = 83 mm		
14625	Adatto per / Suitable for: NUSSBAUM /AMI OD= 125 mm ID = 120 mm HØ = 8 mm H DIST. = 90 mm THK = 24 mm		
14626	Adatto per / Suitable for: SLIFT/IME OD= 125 mm ID = 120 mm HØ = 8 mm H DIST. = 90 mm THK = 24 mm		
14627	Adatto per / Suitable for: KONI/ROMERICO CAR-O-LINER OD= 160 mm ID = 153 mm THK = 10 mm		
14628	Adatto per / Suitable for: TWIN BUSH OD = 120 mm ID = 105 mm L = 100 mm s = 8.50 mm THK = 30 mm H DIST.= 66 mm		

Code	Model		
14629	Adatto per / Suitable for: TWIN BUSH OD = 140 mm ID = 130 mm L = 120 mm THK = 25 mm		
14630	Adatto per / Suitable for: TWIN BUSH OD= 140 mm ID = 125 mm L = 118 mm THK = 30 mm HØ = 8 mm H DIST. = 66 mm		
14631	Adatto per / Suitable for: PONTE CASCOS OD= 138 mm ID = 130 mm L = 140 mm THK = 25 mm		
14632	Adatto per / Suitable for: ISTOBAL/VELYEN OD= 155 mm ID = 147 mm L = 140 mm THK = 24 mm		
14633	Adatto per / Suitable for: ISTOBAL/VELYEN OD= 145 mm H DIST. = 60 mm HØ = 8 mm THK = 10 mm		



14661



14662



14663

Code	Model
14661	Tamponi in gomma per ponti sollevatori 160 x 120 h= 20 Rubber pads for auto lift 160 x 120 h= 20
14662	Tamponi in gomma per ponti sollevatori 160 x 120 h= 40 Rubber pads for auto lift 160 x 120 h= 40
14663	Tamponi in gomma per ponti sollevatori 160 x 120 h= 60 Rubber pads for auto lift 160 x 120 h= 60
14664	Tamponi in gomma per ponti sollevatori 160 x 120 h= 80 Rubber pads for auto lift 160 x 120 h= 80
14665	Tamponi in gomma per ponti sollevatori 160 x 120 h= 100 Rubber pads for auto lift 160 x 120 h= 100

Indicatori di serraggio / Loose nut indicators



CHECKLINK



DUSTITE



DUSTITE LR



CHECKPOINT



CHECKLOCK SQ



Disponibili in diversi colori e misure/ Available in different sizes and colors



Code	Model	Max.Load	Tire quantity	Weight
14760	Carrello per trasporto pneumatici/VMR tire car	90Kg	8	19Kg



11464



10989

Code	Model
14686	Pasta di montaggio universale bianca 5 kg / White universal tire mounting paste 5 kg
14687	Pasta di montaggio universale gialla 4 kg / Yellow universal tire mounting paste 4 kg
14688	Pasta di montaggio universale blu 5 kg / Blue universal tire mounting paste 5 kg
14689	Pasta di montaggio universale nera 5 kg / Black universal tire mounting paste 5 kg
14690	Pasta di montaggio special vmr 4 kg / Vmr special tire mounting paste 5 kg
14691	Lubrificante di montaggio pneumatici 3 litri / Sprint-lube mounting liquid
11464	Pennello Ø 50 / Brush Ø 50
10989	Pennello Ø 36 (595 0186) / Brush Ø 36



Code	Model
14402	Levacopertoni face 530mm / Tire irons face 530 mm
14403	Levacopertoni belzer 670mm / Tire irons belzer 670 mm
14412	Levacopertoni hyoca 920mm / Tire irons hyoca 920 mm
14413	Levacopertoni hyude 990mm / Tire irons hyude 990 mm
14414	Levacopertoni sayam 900mm / Tire irons sayam 900 mm
14419	Levacopertoni standard 400mm / Tire irons standard 400 mm
14421	Levacopertoni standard 600mm / Tire irons standard 600 mm
14422	Levacopertoni halte 800mm / Tire irons halte 800 mm
14424	Levacopertone trilex 1400mm / Tire irons trilex 1400 mm
14425	Levacopertoni standard 500mm con copertura in plastica / Tire irons standard 500 mm (with boot)
14434	Coprileva lungo 390 x 30 mm / Tire irons boot long-black
14745	Protezione leva smonta cerchi in lega / Tire lever boot short
14406	Kit leve per gomme piene / Solid tire lock ring set

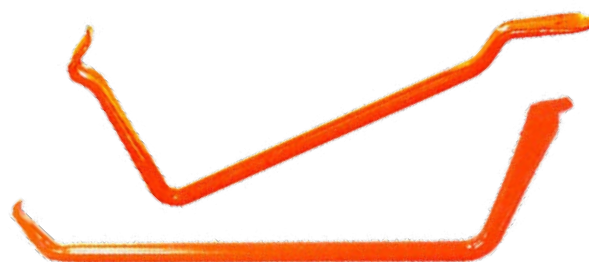

14406



14674



14678



14680



14682



14703



14685



14679



14712



14713



14675



14714



12534



14676



14705

Code	Model
14674	Utensile in plastica per montaggio / Smontaggio valvole Plastic tool to mount / Demount valves
14675	Fresa manuale a spirale 4" / 4" Passenger car reamer screw
14676	Salva cerchi in Nylon / Nylon rim protector
14678	Utensile in acciaio per montaggio / Smontaggio valvole Steel tool to mount / Demount valves
14679	Pinze multiuso per contrappesi / PVC Wheel weight plier
14680	Spatola rimuovi contrappesi l=272 mm Adhesive balance weight remover size 272 mm
14682	Proteggi talloni per smontagomme / Bead protection tool for Tire Changers
14685	Pinza per rimuovere pesi adesivi / Adhesive weight removing plier
14703	Svita valvole standard / Standard valve core screw driver
14705	Salva cerchi in poliuretano / Polyurethane rim protector
14712	Pinza multiuso per contrappesi con protezione / Wheel weights plier with protection
14713	Punteruolo diametro foro 3-15 mm / Tire injury measuring tool 3-15 mm
14714	Punteruolo per mastice / Spiral cement awl
12534	Spatola per interno gomma / Hoe style inner liner scraper



Code	Model
14677	Torretta in plastica / Tire mount / Demount tool
14681	Torretta in plastica / Tire mount / Demount tool
14683	Inserto triangolare in plastica (set 10 pz) / Triangular plastic insert for Tire Changers (10 pcs)
14684	Inserto rettangolare in plastica (set 10 pz) / Rectangular plastic insert for Tire Changers (10 pcs)
14704	Premi talloni per cerchi in lega / Rim clamp for alloy rims
14706	Protezione in plastica per paletta stallonatrice / Bead breaker blade protection
14707	Protezione in plastica per paletta stallonatrice / Bead breaker blade protection
14708	Protezione in plastica per paletta stallonatrice / Bead breaker blade protection
14709	Protezione in plastica per paletta stallonatrice / Bead breaker blade protection
14710	Cono di protezione ø 40-125 mm / Cone cover ø 40-125 mm
14711	Cono di protezione ø 28-120 mm / Cone cover ø 28-120 mm
14654	Tendicamera con apri-talloni / Stretching tool for inner tubes with bead-spreader





14653



14650-1



14646



14650



13732

Code	Model
14653	Termo pressa universale / Universal thermopress
14651	Sacchetto compensatore 200 mm x 200 mm / Adjusting bag 200 mm x 200 mm
14650	Coppia di piastre scaldante per termo pressa potenziata 170°c 150 x 220 Heating plats pair for 170 thermopress
14650-1	Supporto orientabile / Swinging support
14649	Sacchetto compensatore 200 mm x 300 mm / Adjusting bag 200 mm x 300 mm
14648	Sacchetto compensatore 170 mm x 140 mm / Adjusting bag 170 mm x 140 mm
14646	Piastra scaldante per termo pressa 150 c° 180 x 100 / Heating plate 150 c° 180 x 100
13732	Ispezionatrice vettura - autocarro 14"- 24" / Car and Truck tire spreader 14"- 24"



Code	Tire model	Rim size	Weight kg
15571	Superelastic 4.00-8	-	-
15573	Superelastic 5.00-8	3.00-8	15
15575	Superelastic (15x4,5x8) 125/75-8	3.00-8	10
15577	Superelastic (16x6x8) 150/75-8	4.33-8	15
15579	Superelastic (18x7x8) 180/70-8	4.33-8	20
15581	Superelastic 140/55-9	4.00-9	14
15583	Superelastic 6.00-9	4.00-9	25
15585	Superelastic 200/75-9 (21x8x9)	6.00-9	31
15587	Superelastic 6.50-10	5.00-10	34
15589	Superelastic 7.50-10	5.50-10	49
15591	Superelastic 200/50-10	6.50-10	23
15593	Superelastic (23x9x10) 225/75-10	6.50-10	41
15595	Superelastic 7.00-12	5.00-12	47
15597	Superelastic 23x10-12	8.00-12	43
15599	Superelastic (27x10x12) 250/75-12	8.00-12	68
15601	Superelastic 7.00-15	5.5-15	60
15603	Superelastic 7.50-15	5.5-15 6.5-15	64
15605	Superelastic 8.25-15	5.5-15 6.5-15	88
15607	Superelastic (28x9x15) 225/75-15	-	-
15609	Superelastic 28x12.50-15	9.75-15	94
15611	Superelastic 200-15	-	-
15613	Superelastic 250/70-15(250-15)	7.00-15	64
15615	Superelastic 315/70-15 (3.00x15)	8.0-15	103
15617	Superelastic 355/65-15 (3.5x15)	9.75-15	124
15619	Superelastic 8.25-20	-	-
15620	Superelastic 9.00-20	-	-
15621	Superelastic 10.00-20	7.50-20 8.00-20	124
15622	Superelastic 12.00-20	8.00-20 8.5-20	160

* Disponibili su richiesta ne modello FIX/SIT - FIX/SIT models available upon request



info@vmrubber.com +39 0464 1940003
Viale Giovanni Caproni 17/A 38068 Rovereto (Tn) Italy
www.vmrubber.com

