

TIRE • REPAIR • MANUAL



INTRODUCTION



This technical repair manual is intended to present practical procedures and recommendations to repair inner tubes and tyres/tires. The manual is intended to retreaders and tyre/tire repair professionals, offering them detailed information to prepare the damage, choose the repair, and perform the application. The person responsible for carrying out the repair will perform the control and assure the repair process quality. This process includes inspection and the decision to repair, material selection, selection of the most appropriate repair procedure, correct repair execution, and final inspection that will ensure the result has no flaws that may compromise the tyre/tire life. Vipal Rubber certifies that their products intended to tyre/tire repair follow the required features and conditions demanded by European regulations ECE-R108 (passenger vehicle tyres/tires) / ECE-R109 (load vehicle tyres/tires), if correctly applied. This formal statement is valid considering that products, technical information, and application are according to Vipal's application tables and instructions, respecting the maximum limits and damage sizes, including tyre/tire repairable areas.

INDEX



CHAPTER 1 - INNER TUBE REPAIRS

Presentation of repairs to the inner tube.....	5
How to apply repairs to inner tubes?.....	6
How to change the valve reinforcement?.....	10

CHAPTER 2 - VF, VFP AND RT3 REPAIRS

VF hot repair presentation.....	19
VF and VFP cold repairs presentation.....	20
RT-3 repair presentation.....	21
How to apply VF, VFP and RT-3 repairs?.....	22

CHAPTER 3 - MC REPAIRS

MC repairs presentation.....	28
How to apply MC repairs?.....	29

CHAPTER 4 - VIPSTEM

Products used in application.....	37
How to apply Vipstem?.....	39

CHAPTER 5 - RAC - RA - RS PATCHES

How to choose RAC, RA, and RS patches?.....	45
How to apply RAC, RA, and RS patches?.....	49

CHAPTER 6 – VD AND VDL PATCHES

How to choose VD and VDL patches?.....	54
How to apply VD and VDL patches?.....	59

CHAPTER 7 - MA PATCH

MA patch selection.....	65
How to apply the MA patch?.....	67

CHAPTER 8 - VT AND VTL PATCH

How to choose VT and VTL patch?.....	72
--------------------------------------	----

CHAPTER 9 - RAC - OTR PATCH

How to choose the RAC - OTR patch?.....	87
How to apply RAC - OTR patches?.....	90

CHAPTER 10 - RAC PATCH - AGRICULTURAL

How to choose the RAC - Agricultural patch?.....	95
How to apply RAC - Agricultural patches?.....	98

CHAPTER 11 - REMOPAT

Remopat repairs presentation.....	103
How to apply Remopat?.....	104

CHAPTER 12 - VIPASEAL

Vipaseal repairs presentation.....	109
How to apply Vipaseal?.....	110

NOTES	115
--------------------	-----

INNER TUBE REPAIRS

PRESENTATION OF REPAIRS TO THE INNER TUBE

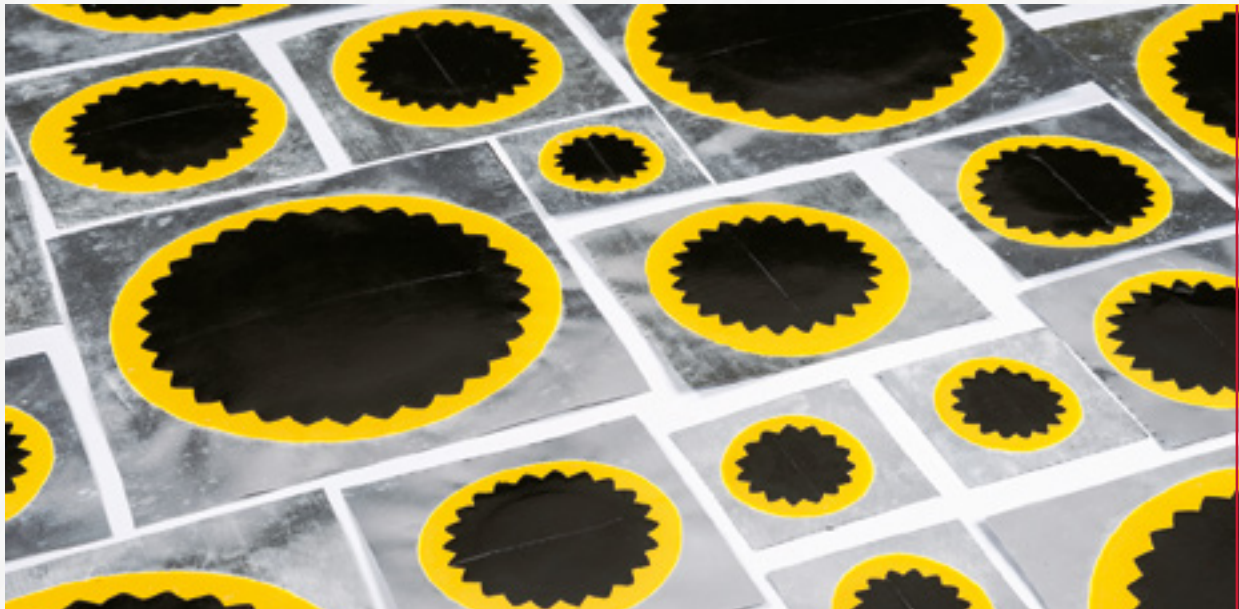

The inner tube's repairs and reinforcement use a cold vulcanization system that does not subject the inner tubes to any heat, extending its life. Additionally, its extra-fine thickness and its expansion power match the inner tube's elasticity, not forming lumps.

HOW TO APPLY REPAIRS TO INNER TUBES?

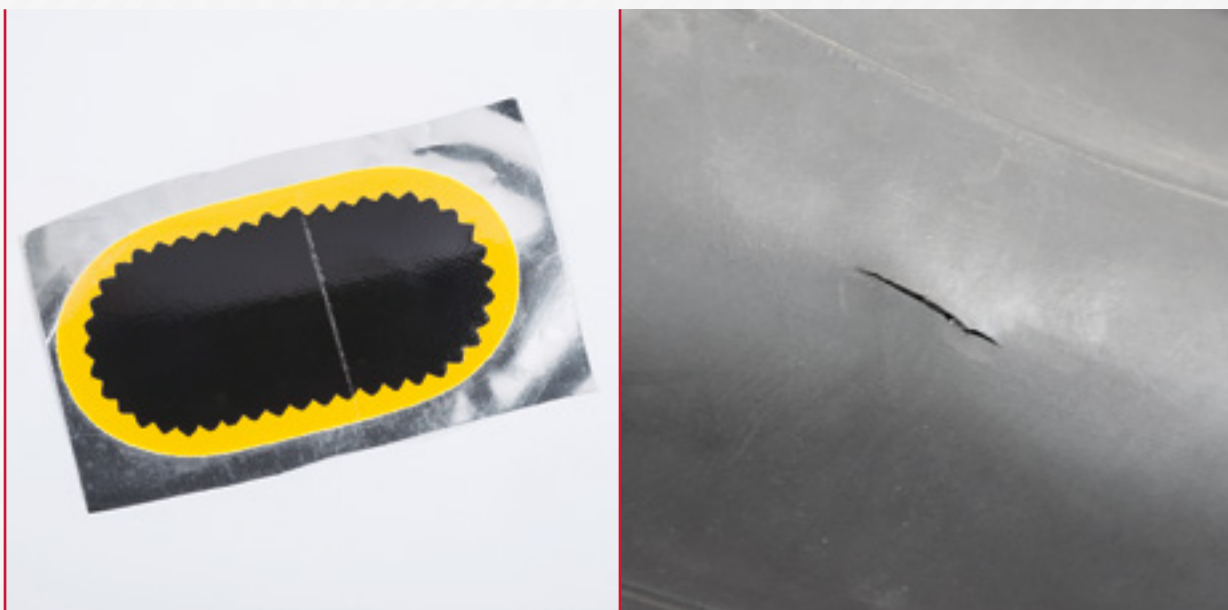

Locate the damage or hole in the inner tube.

In case of a tear, use the oval repair. The repair must be at least three times bigger than the damage.



After identifying the tear, round off the damage ends with the aid of scissors.



For round holes, use round repairs. The patch must be 10 times bigger than the hole.



Apply Bufpal surface activator in the damage surroundings. Using a sandpaper, a grinder or similar tool, texturize the damage area.



Apply vulcanizing cement in circular motions.

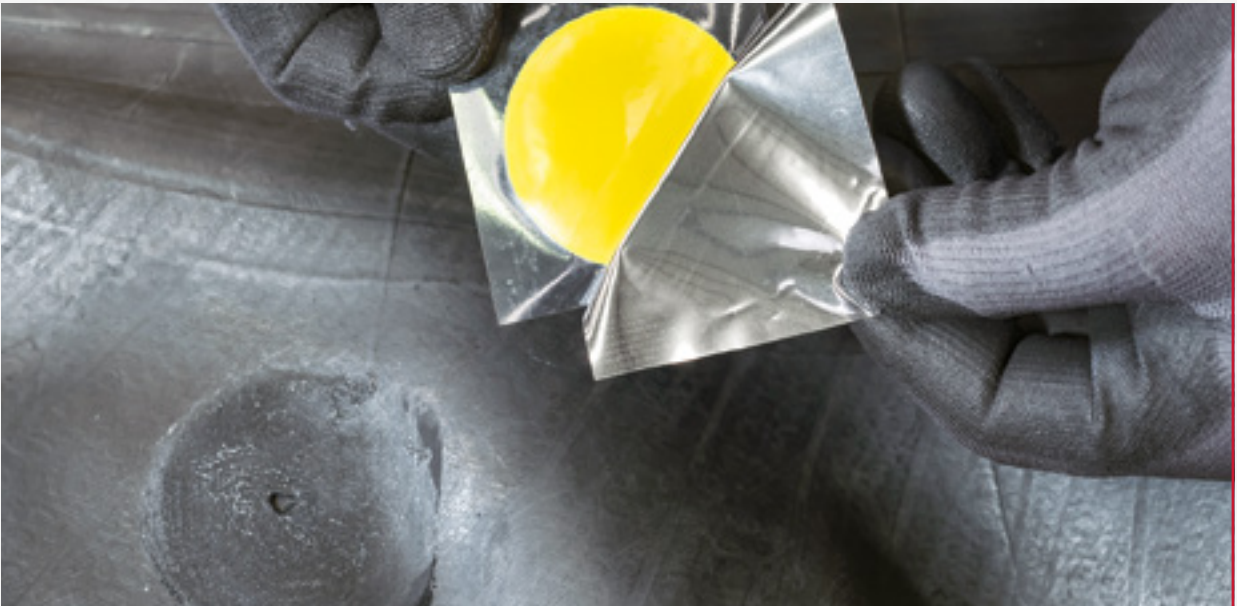

Remove the metalized film from the repair and apply it in the area.



Make light pressure on the spot.



Firmly roll the repair over the inner tube.



Then, remove the protective plastic and perform a test to check the seal or to find other unrepaired holes.

In case there aren't any other unrepaired holes, the air chamber will be ready for use.

HOW TO CHANGE THE VALVE REINFORCEMENT?



The reinforcement is intended to replace valves in inner tubes for cargo, agricultural, and OTR tyres/tires using the cold method.



Remove the valve using a stylus.



Remove the nut and the washer and place the new valve completely inside the inner tube.

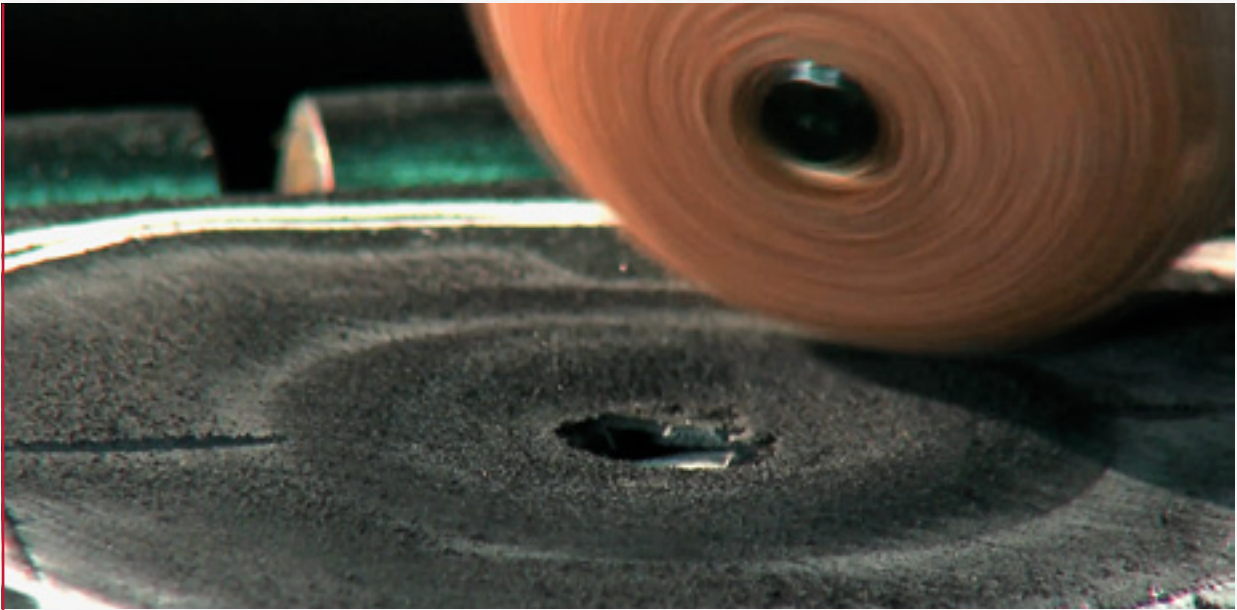

Scrape the area with a grain 36 carbide according to the size of the repair required to close the damage.



Apply Bufpal surface activator to the marked area removing impurities.



Apply vulcanizing cement in circular motions.

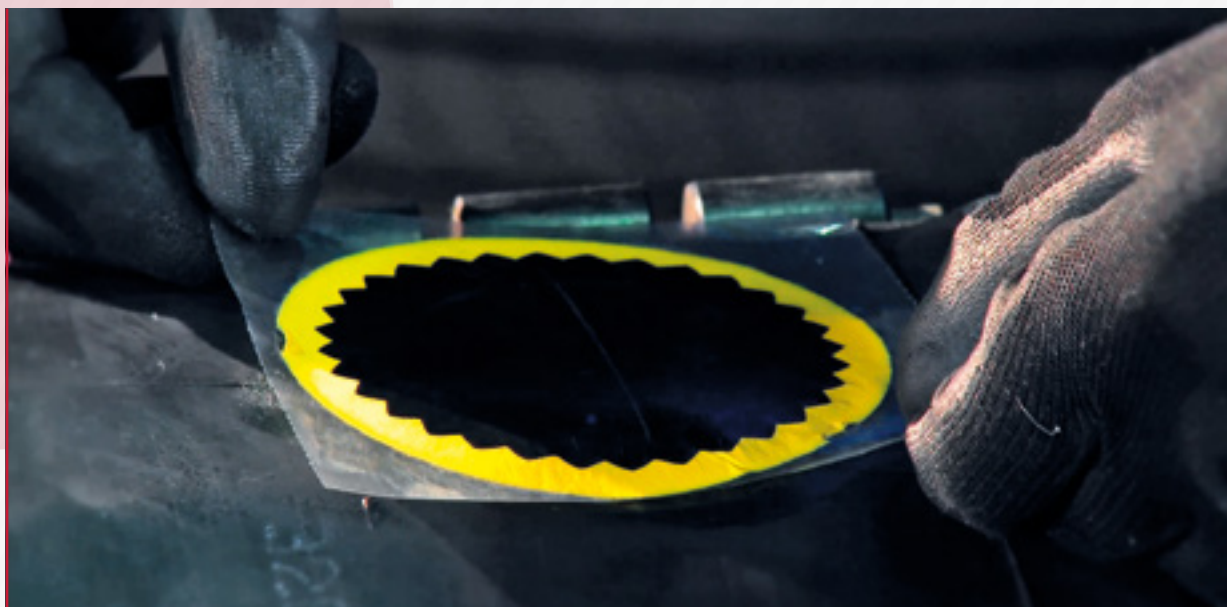

Place the repair centered to the hole.

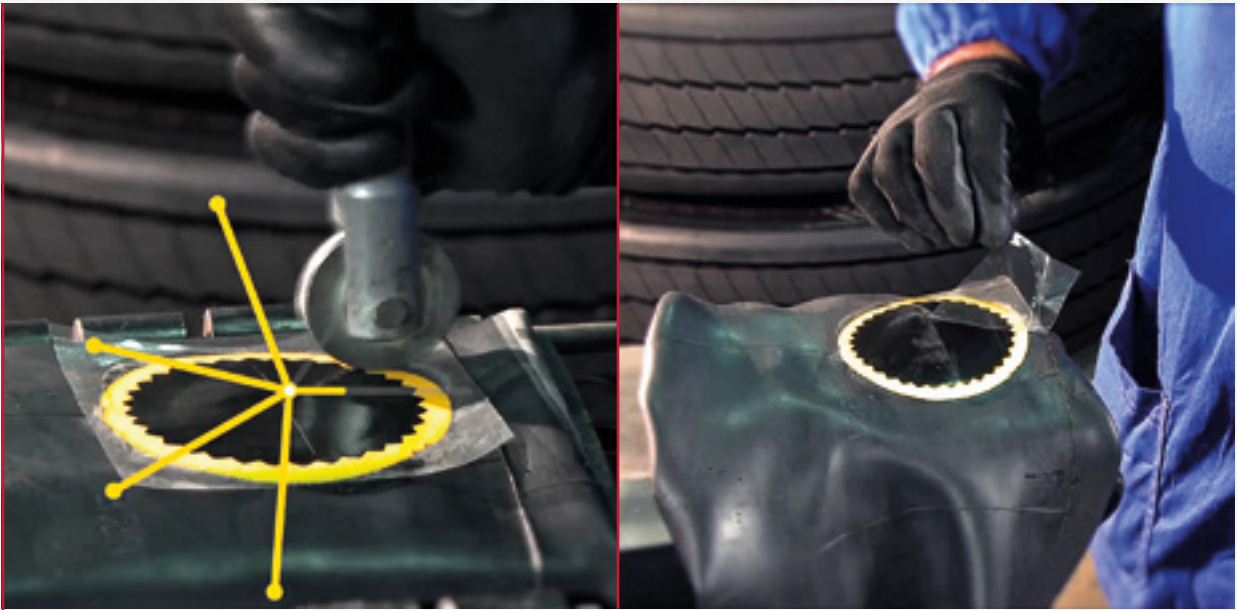

Roll firmly from the center of the repair and remove the protective film.

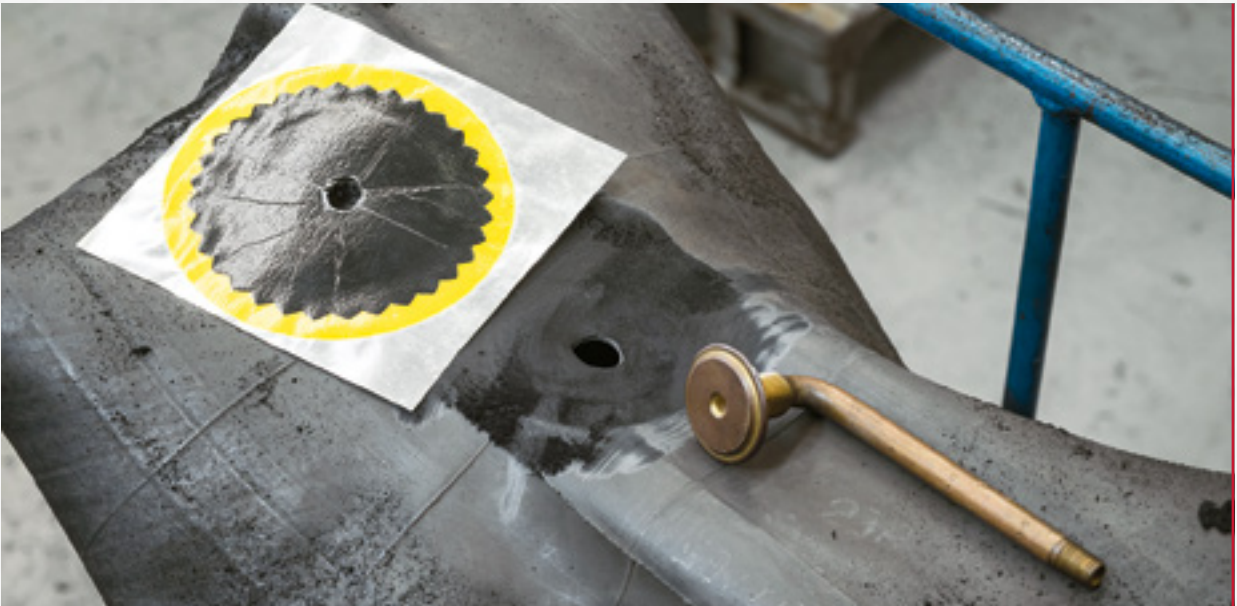

Select the area to apply the new reinforcement, preferably at 180°
from the original location.

If possible, a new valve can be applied to the original location.
Note the original valve position alignment ensuring that it properly fits to the wheel.



Mark the new valve application area.



Prepare the area where the new valve will be placed with a grain 36 Carbide.



Apply Vipal surface activator to the prepared area removing impurities.

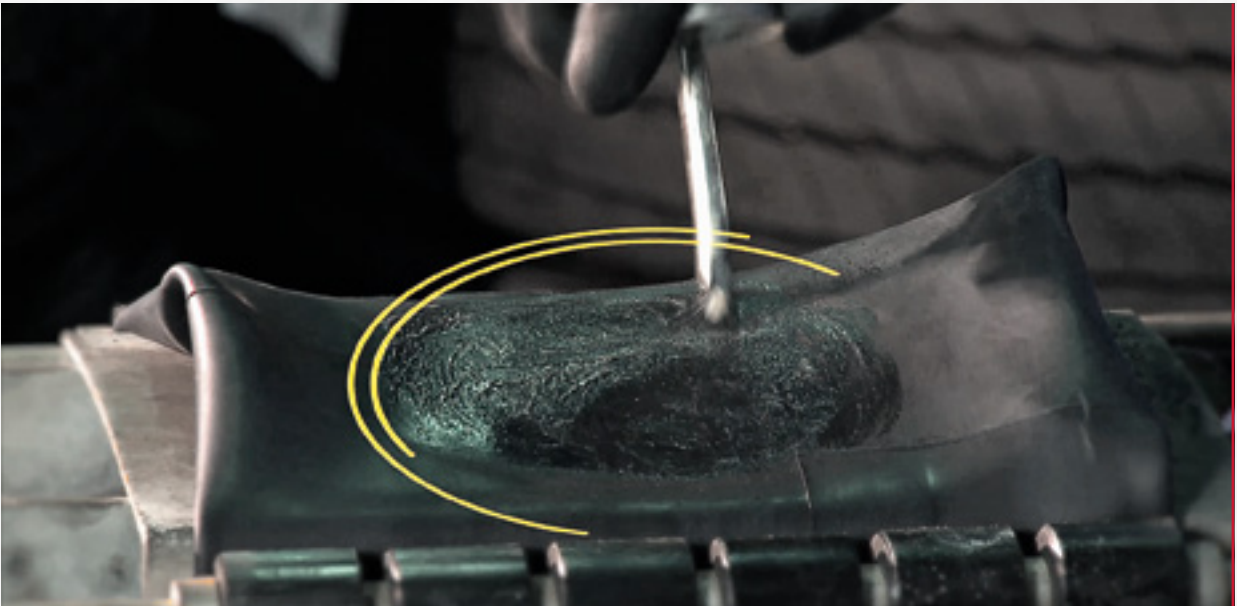

Apply vulcanizing cement in circular motions and wait for it to dry completely.

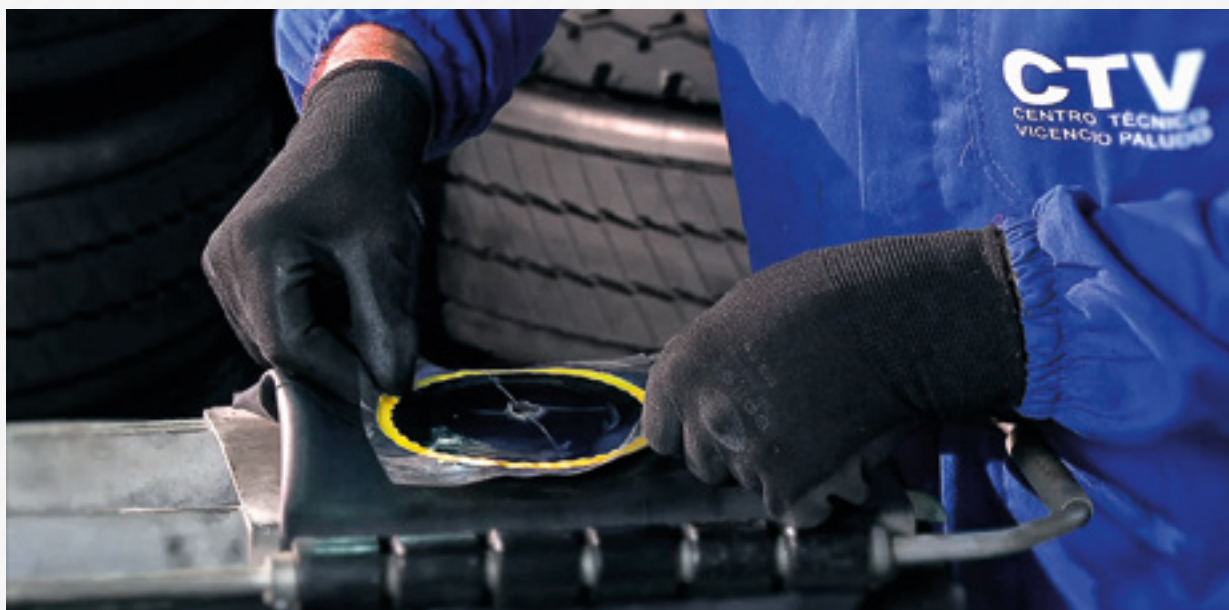

Place the reinforcement on the prepared areas.

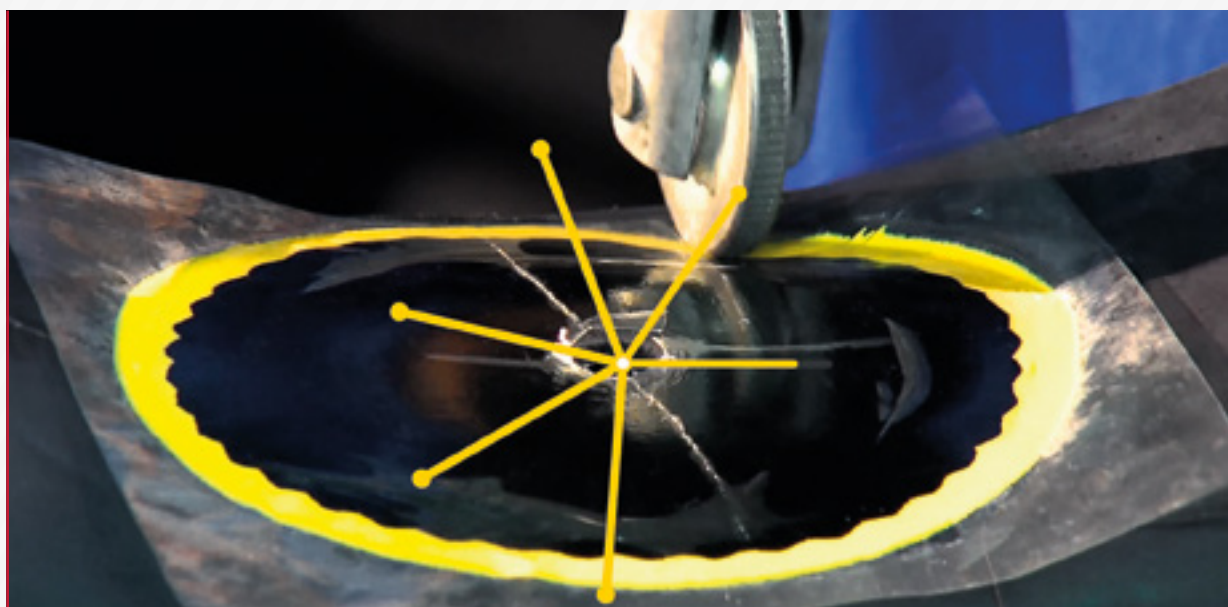

Roll firmly from the center of the repair.



Place the valve inside the inner tube at the center of the reinforcement and cut using a stylus.



Place the fixation plate, then the nut and tighten, being careful so that it doesn't get too tight, deforming the inner tube.

Carry out a leak test; if negative, the inner tube is ready to be used.

VF, VFP AND RT3 REPAIRS

VF and VFP are rubber repairs for repairing car, van, and truck tyres/tires, on radial and bias ply tyres/tires in the tread region using the **hot method** and the **cold method**.

VF HOT REPAIR PRESENTATION



Rubber repair for repairing minor damage using the hot vulcanization method in tyres/tires with and without radial and bias-ply inner tubes.

The VF (Vipal Hole) repair makes it possible to repair damages of 3, 6, and 8 mm.

VF AND VFP COLD REPAIRS PRESENTATION

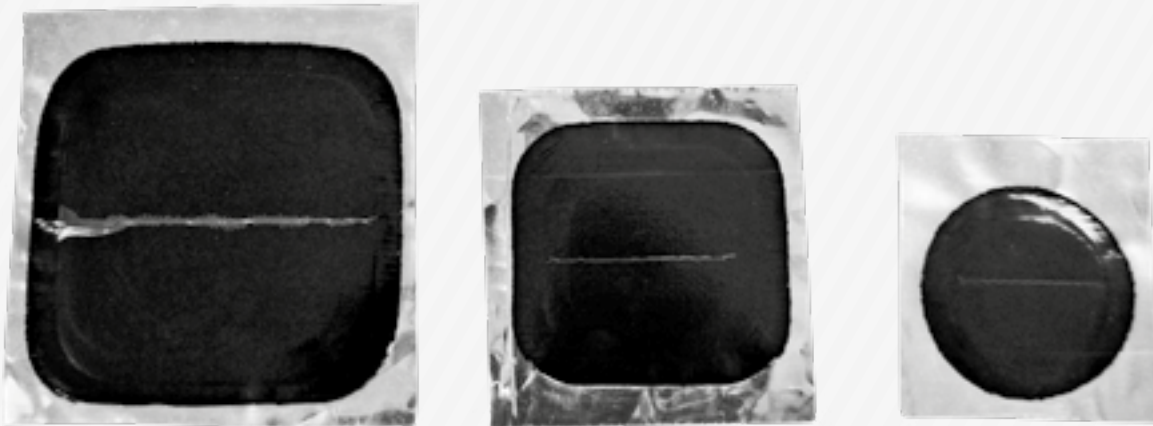

Rubber repair for repairing minor damage using the cold vulcanization method in tyres/ tires with and without radial and bias-ply inner tubes.

The VF (Vipal Hole) and VFP (Vipal black hole) enable the repair of 3, 6, and 8 mm damages.

RT-3 REPAIR PRESENTATION



RT-3 is intended to repair minor damages of up to 3 mm using the cold vulcanization method in car and trucks tubeless radial tyres/tires.

HOW TO APPLY VF, VFP AND RT-3 REPAIRS?

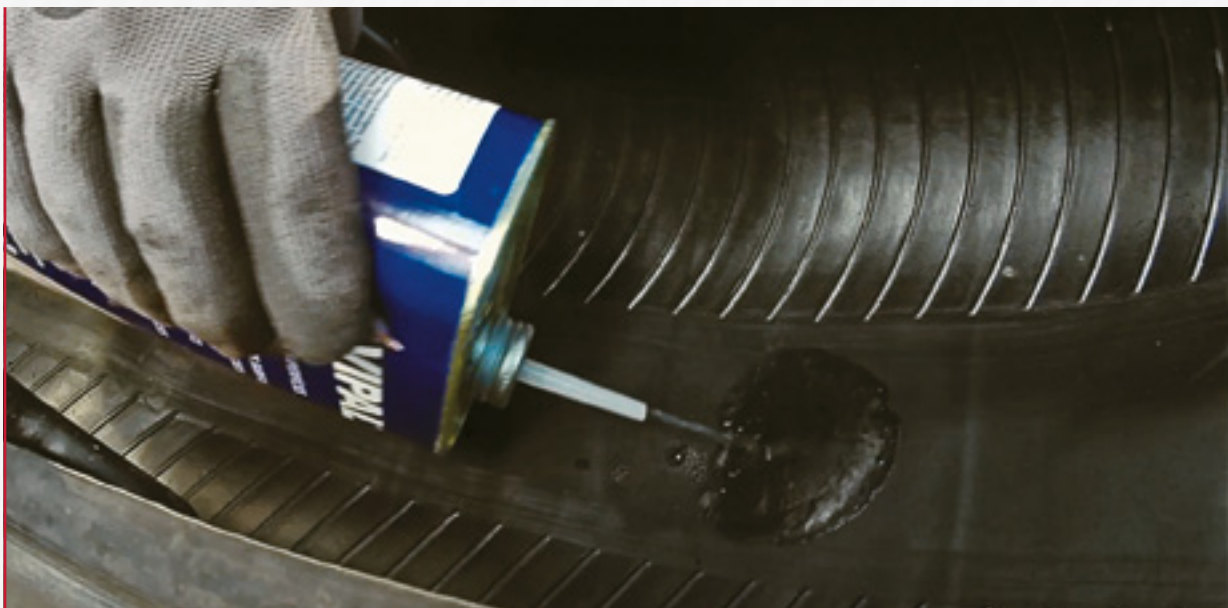

Use the Bufpal surface activator to clean the area to be scraped.
Don't use compressed air for cleaning and drying.



With the beads open similarly to the aperture provided by the used wheel, center the VF, VFP, or RT-3 repairs and mark the area to be scraped. The following instructions use the VF repair as an example, but the application methodology is the same for VFP and RT-3.



Scrape the area by obtaining an RMA1 or RMA2 texture pattern. Use a grinder with fine grain carbide between 2500 rpm and 3500 rpm.



Use the Bufpal surface activator to clean the scraped area. Don't use compressed air for cleaning and drying.



Correctly apply the vulcanizing cement to the scraped area. Allow the glue to dry for the recommended time, which may change according to temperature and relative air humidity. Do not use another air source to accelerate drying.

For hot repairs apply vulk glue following the same procedures.

Attention:

DO NOT USE flammable cement near flame, spark or another ignition source.

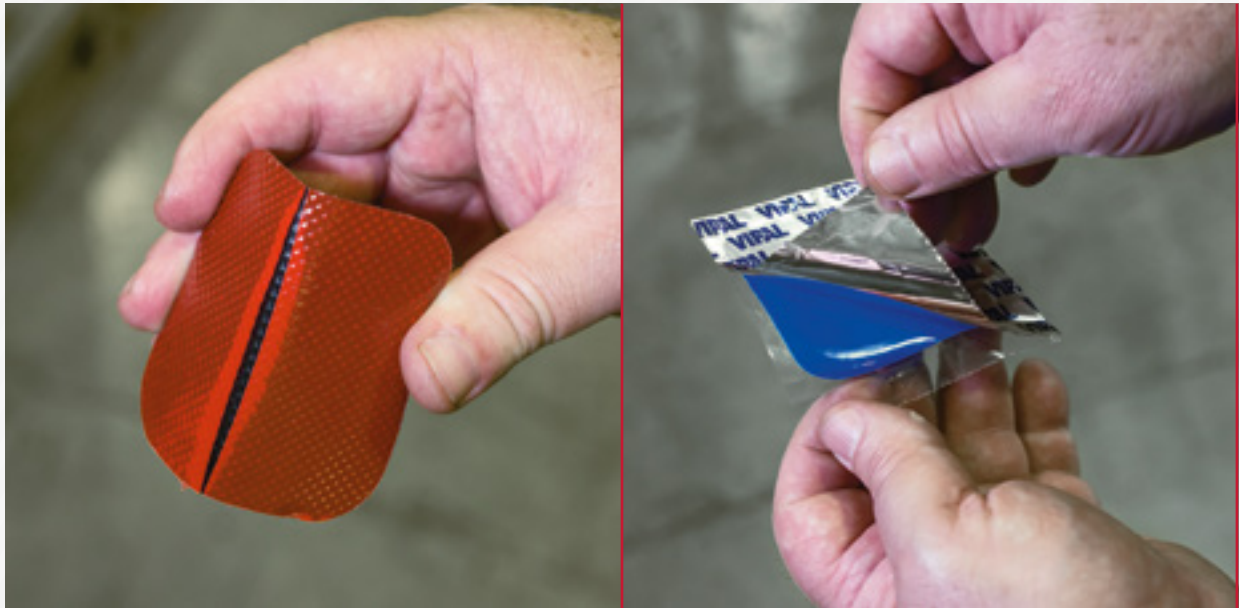

Remove the protective film from the repair base by avoiding direct contact with the connection. If there is contamination to the base, apply cement for cold repair or vulk glue for hot repair.

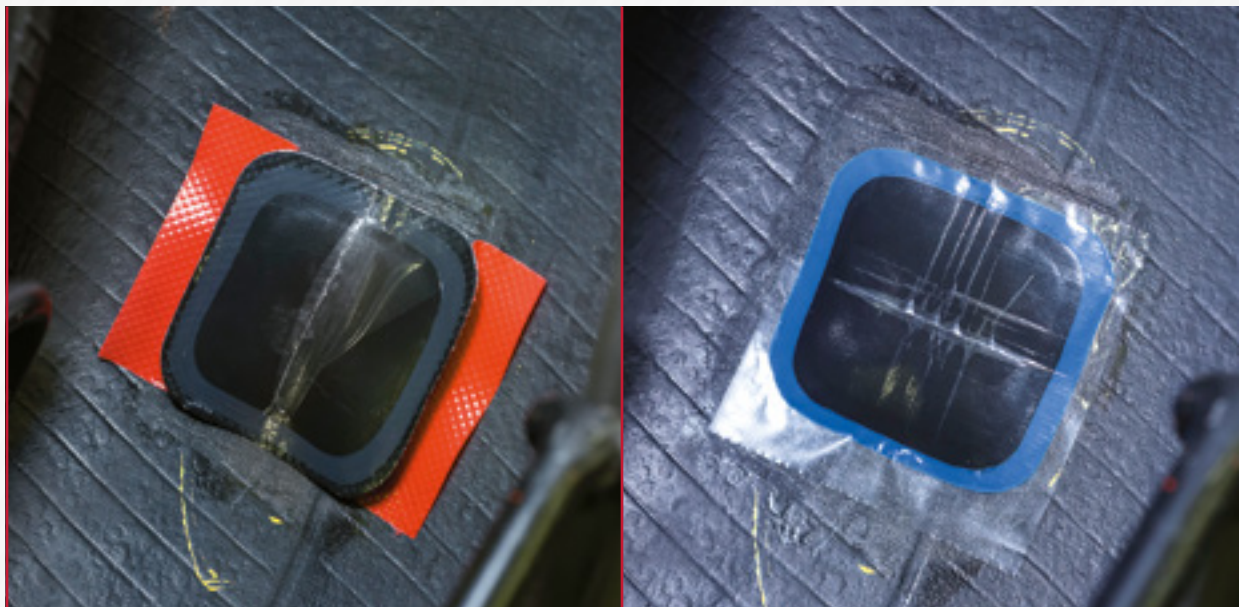

Place it centrally on the hole and remove the remaining plastic.
The repair application should be made with the beads open similarly to the aperture provided by the usage wheel. Align the repair according to the demarcated area.



Roll the repair correctly from the hump to the edges, ensuring better adhesion and preventing air occlusion.



Remove the top plastic. The tyre/tire with a cold VF repair may be inflated 10 minutes after application. Tyre/tire with hot VF repair should be vulcanized.



Apply sealant at the edges of the patch, covering the buffed area and protecting the patch from possible infiltration.

MC REPAIRS

MC (conjugated patches) repairs are recommended for repairing 3, 6, 8, and 10mm damages to the tread in radial tires.

MC REPAIRS PRESENTATION



Disk with vulcanized rubber rod that should be applied only to the tread area from inside out. Disk and rod perform the dual role of sealing and filling the damage. In order to correctly select the repairs, check Vipal Repairs table. MC is available to the cold vulcanizing process.

Attention:

There is an usage restriction for rubber repairs above 8 mm in some countries, please check the applicable law.

HOW TO APPLY MC REPAIRS?



Identify the damaged area assessing the damage size.



After location the hole, pierce the damage with a low-speed electric grinder between 2,500 rpm and 3,500 rpm, properly equipped with a steel cutter, always following the drilling angle. The tools used should remove the damaged cables and produce a round surface. Repeat this procedure at least three times from the tyre/tire's inside out to ensure complete removal of damaged cables, being careful not to increase the damaged area. Use the awl to identify possible separations in belts near the damage.



Identify the repair corresponding to the damage/hole diameter according to the MC measurements.



Use the Bufpal surface activator to clean the area to be scraped.
Don't use compressed air for cleaning and drying.



Using a school chalk, mark the area to be prepared with the MC disk itself.

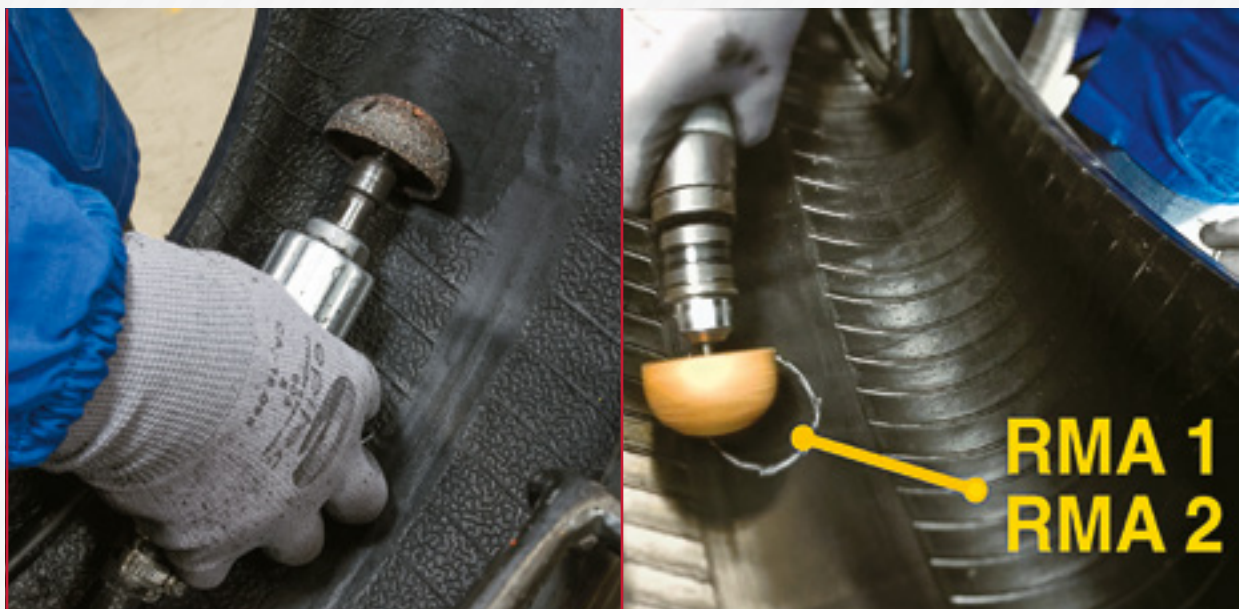

To prevent contamination and preserve the liner, carefully scrape only the marked area and always using a fine grain carbide grinder from 2,500 to 3,500 rpm. Be careful not to expose the tyre/tire structure belts.

The texture of the buffed area should be RMA1 or RMA2.



Remove the rubber powder in the scraped area with a fine brush and/or vacuum cleaner to obtain a clean and dry surface.



Use the Vipal surface activator to clean the scraped area.
Don't use compressed air for cleaning and drying.



Open the MC package and apply a uniform layer of vulcanizing cement to the disk and rod, as shown in the picture.



Correctly apply the cement to the scraped area. Allow the glue to dry for the recommended time, which may change according to temperature and relative air humidity. Do not use another air source to accelerate drying.

Attention:

DO NOT USE flammable cement near flame, spark or another ignition source.



Insert the brass stick from inside out enough to cross the casing.

With aid of a plier, completely pull the repair by the rod. This will cause an elongation and, as consequence, a momentary thinning of the rod, making the introduction easier.



It is enough to level the disk to the casing without sinking it.



Once loose, the rod recovers its original thickness, pressuring the hole walls and providing a sealing effect.



Inside, roll the MC disk from the center to the edges and apply sealant to the edges.



On the outside, cut **without trailing the rod**, just above the tread.



The tyre/tire is ready to be assembled, inspected, and put into use.

VIPSTEM

The Vipstem repair is intended to fill rounded (cylindrical) damages up to 15 mm located in the tread of tyres/tires with radial construction by the cold vulcanization process.

IMPORTANT:

Oval damages or cuts cannot be repaired with this product.

PRODUCTS USED IN APPLICATION



Vipstem:

Vulcanized rubber rod that should be used with the relevant patch or rubber repair. In order to correctly select the repairs, check Vipal Repairs table; Vipstem is available to the cold vulcanizing process.



Steel milling cutter:

This is used to prepare the damaged area to apply the repair.

HOW TO APPLY VIPSTEM?



After location the hole, prepare the damage with a low-speed electric grinder between 2,500 rpm and 3,500 rpm, properly equipped with a steel cutter, always following the drilling angle. The tools used should remove the damaged cables and produce a round surface. Repeat this procedure approximately three times from the tyre/tire's inside out to ensure complete removal of damaged cables, being careful not to increase the damaged area. With an awl, make sure there are no possible separations in the belts near the damage. If necessary, use a steel cutter with a larger diameter.

IMPORTANT:

Use a steel cutter slightly larger than the damaged area and of the same size of the Vipstem repair to be used.

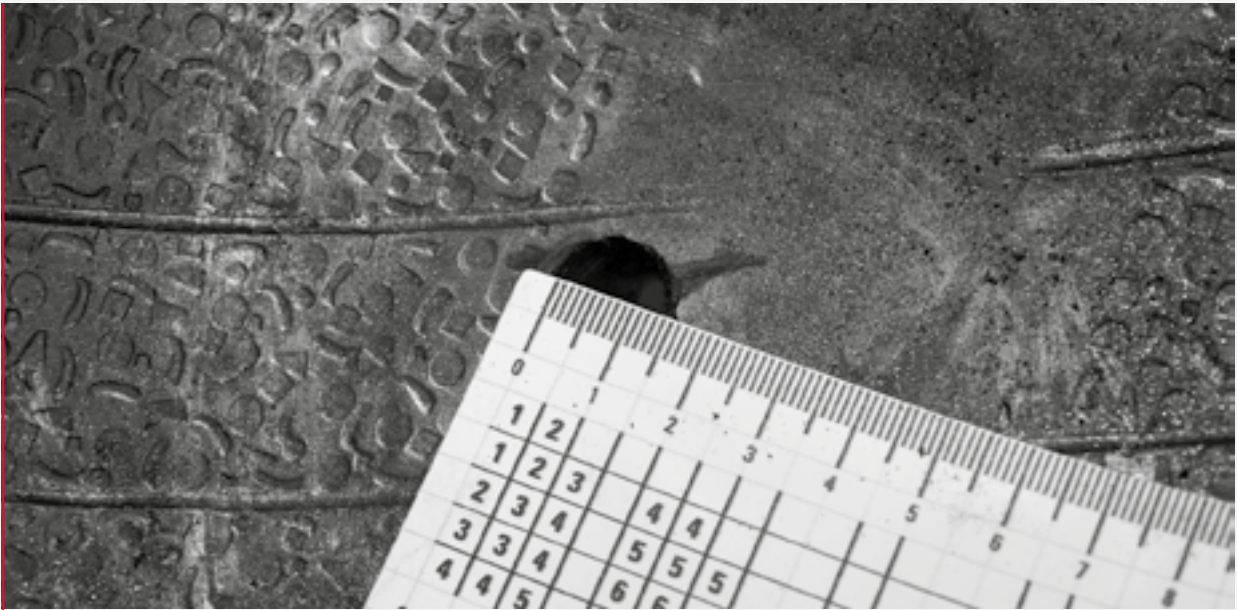

Identify the Vipstem repair corresponding to the same diameter of the damage according to the available measurements.

Denomination	Dimensions		Damages up to (mm)
	Ø (mm)	Length (mm)	
Vipstem 6	6	50	6
Vipstem 8	8	50	8
Vipstem 10	10	50	10
Vipstem 13	13	50	13
Vipstem 15	15	50	15



Remove Vipstem from the package and avoid contamination.



Use an auxiliary needle to apply Vipstem to the properly prepared damaged area.



Apply vulcanizing cement in the repair waiting for the cement's proper drying. Do not use another air source to accelerate drying, avoid direct contact with the repair previous prepared.



In the already properly prepared damaged area, apply vulcanizing cement and wait for a complete drying.



Apply the Vipstem repair from the inside out, leaving the repair end on the same level as the tyre/tire liner.

RAC - RA - RS PATCHES



RAC (Radial Centralized), RA (Radial Aramid), and RS (Radial Steel) patches are intended to radial tyres/tires internal repairs.

These patches are built with inner plies that follow the same manufacturing direction as radial tyre/tire casing plies. RAC has a nylon internal structure. RA has an aramid internal structure. RS has a steel internal structure.



Next, we'll see how to choose the appropriate patch considering the tyre/tire and the damage size.

HOW TO CHOOSE RAC, RA, AND RS PATCHES?

PATCH SELECTION FOR SPECIFIED TREAD DAMAGE

For interpreting the table and consequently choosing the correct patch, we will use an example to better demonstrate the selection operation logic.



Let's consider a 295/80R22,5 tyre/tire with a 15 mm damage on the tread.

	8.25 - 14.75 9R - 13R 205 - 285 295 - 385					
			ØB (mm)	RAC	RA	RS
		4	10	-	-	
		6	12	-	-	
		8	14	-	-	
		10	15	29	-	
		12	20	-	-	
		15	22	31	31	
18	-	-	25B			

Tyre/tire measures:
295/80 R 22,5

Check tyre/tire measure.



1

	8.25 - 14.75 9R - 13R 205 - 285 295 - 385					
			ØB (mm)	RAC	RA	RS
		4	10	-	-	
		6	12	-	-	
		8	14	-	-	
		10	15	29	-	
		12	20	-	-	
		15	22	31	31	
18	-	-	25B			

Damage position:
Tread

Identify the position of the damage on the tyre/tire.

2



	8.25 - 14.75 9R - 13R 205 - 285 295 - 385				
		ØB (mm)	RAC	RA	RS
		4	10	-	-
		6	12	-	-
		8	14	-	-
		10	15	29	-
		12	20	-	-
		15	22	31	31
18	-	-	25B		

3

Damage size:

Ø = 15 mm

Measure the damage dimension and identify it in the table.

	8.25 - 14.75 9R - 13R 205 - 285 295 - 385				
		ØB (mm)	RAC	RA	RS
		4	10	-	-
		6	12	-	-
		8	14	-	-
		10	15	29	-
		12	20	-	-
		15	22	31	31
18	-	-	25B		

4



Then identifying the options of patches indicated for the damage.

Indicated patches: RAC 22, RA 31, and RS 31.

Now we'll use another example of a damage that is different from the one presented in the table, i.e., a non-rated damage.

Let's consider a 275/80R22,5 tyre/tire with a 11 mm damage on the tread.

CHOOSING A PATCH – TREAD – NON-NOMINAL DAMAGES

	8.25 - 14.75 9R - 13R 205 - 285 295 - 385				
		ØB (mm)	RAC	RA	RS
		4	10	-	-
		6	12	-	-
		8	14	-	-
		10	15	29	-
		12	20	-	-
		15	22	31	31
18	-	-	25B		

1

Tyre/tire measures:

275/80 R 22,5

Check tyre/tire measure.

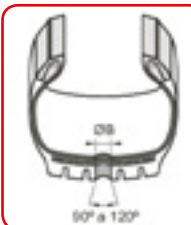
	8.25 - 14.75 9R - 13R 205 - 285 295 - 385				
		ØB (mm)	RAC	RA	RS
		4	10	-	-
		6	12	-	-
		8	14	-	-
		10	15	29	-
		12	20	-	-
		15	22	31	31
18	-	-	25B		

2



Damage position:

Tread

Identify the position of the damage on the tyre/tire.

IMPORTANT:

The patch should be selected for the larger damage closest to the measurement.



	8.25 - 14.75 9R - 13R 205 - 285 295 - 385				
		ØB (mm)	RAC	RA	RS
		4	10	-	-
		6	12	-	-
		8	14	-	-
		10	15	29	-
		12	20	-	-
		15	22	31	31
		18	-	-	25B

3

Damage size:

Ø = 11 mm

Measure the damage dimension and identify it in the table. The repair should be selected according to the immediately upper rated size.

	8.25 - 14.75 9R - 13R 205 - 285 295 - 385				
		ØB (mm)	RAC	RA	RS
		4	10	-	-
		6	12	-	-
		8	14	-	-
		10	15	29	-
		12	20	-	-
		15	22	31	31
		18	-	-	25B

4

Then identifying the options of patches indicated for the damage.

Indicated patches: RAC 20, RA 31, and RS 31.

HOW TO APPLY RAC, RA, AND RS PATCHES?



Use the Bufpal surface activator to clean the area to be scraped.
Don't use compressed air for cleaning and drying.



Keep the tyre/tire in normal position opening the beads similarly as the opening provided by the usage wheel. Position the template at the center of the damage and mark the outline with chalk or unlock the template so the damage is kept inside the repairable area, avoiding that the patch end is the tyre/tire flexing area.



To prevent contamination and preserve the liner, only the demarcated area should be carefully trimmed using a fine grain carbide grinder from 2,500 to 3,500 rpm. Be careful when scraping in order not to expose the tyre/tire structure belts.

The texture of the buffed area should be RMA1 or RMA2.



Remove the rubber powder in the scraped area with a fine brush and/or vacuum cleaner to obtain a clean and dry surface.



Use the Bufpal surface activator to clean the scraped area.
Don't use compressed air to clean areas to be repaired.



Apply vulcanizing cement to the scraped area and wait for it to dry completely.
Do not use another air source to accelerate drying.

Attention:

DO NOT USE flammable cement near flame, spark or another ignition source.

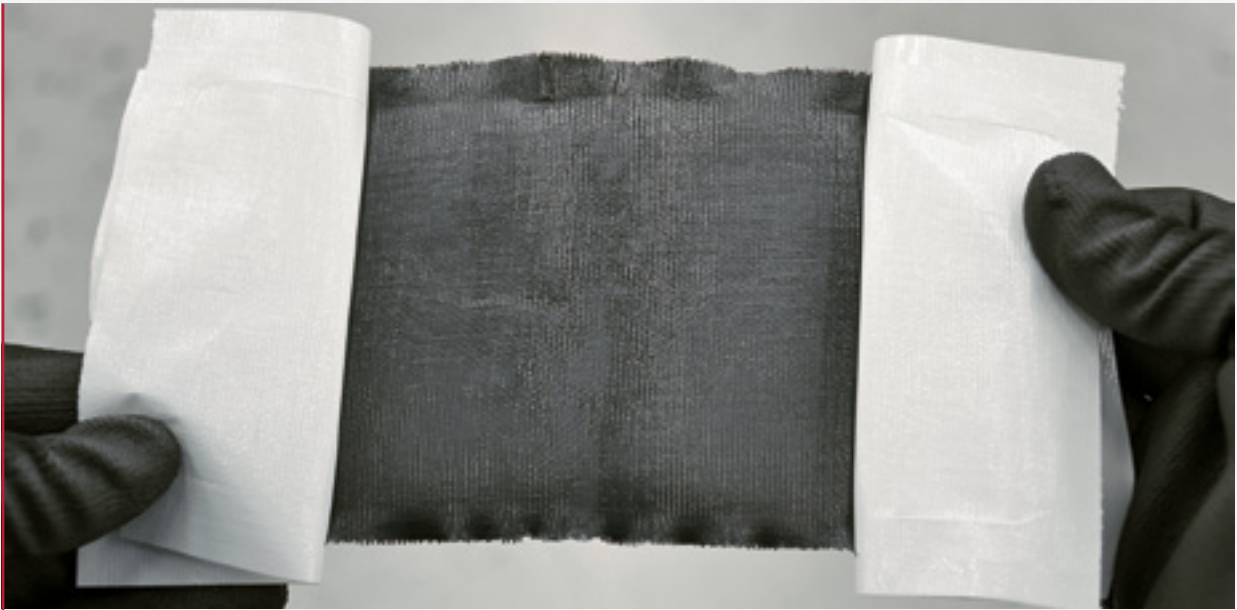

Remove the protective film from the patch from the hump to the edges, leaving room to hold the repair and preventing contamination of the base.



The repair application should be made with the beads open similarly to the aperture provided by the usage wheel. Align the repair according to the demarcated area.



Roll the repair correctly from the hump to the edges, ensuring better adhesion and preventing air occlusion

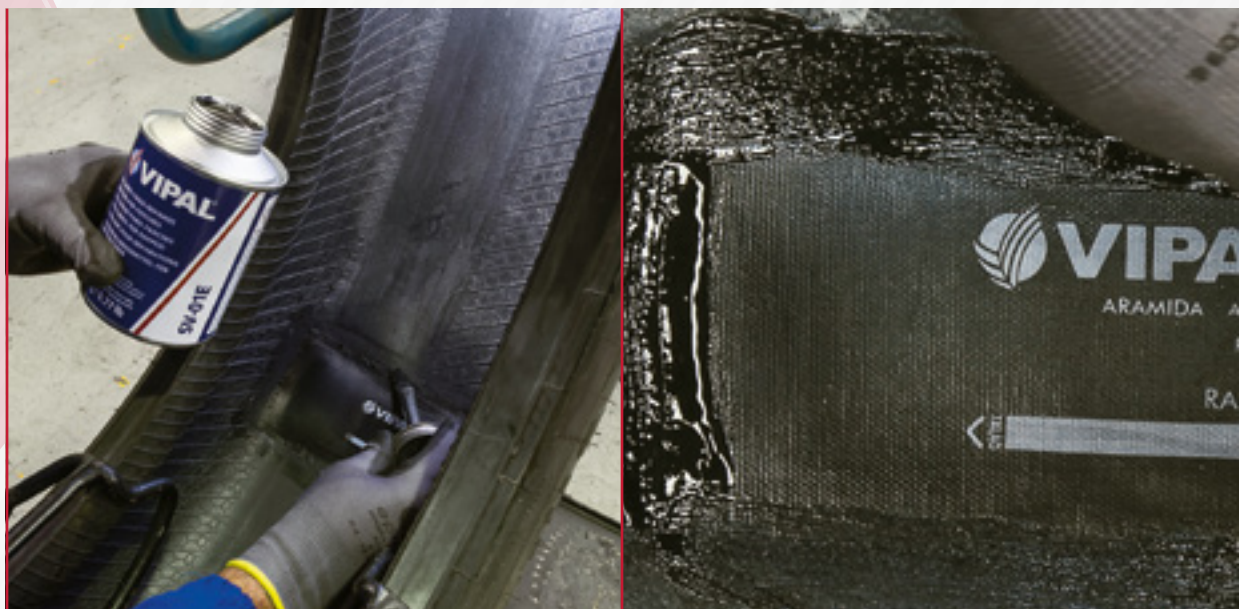

Apply sealant at the edges of the patch, covering the buffed area and protecting the patch from possible infiltration.

VD AND VDL PATCHES



Vipal bias-ply tyres/tires (VD) is specifically recommended for the internal repair of bias-ply tyres/tires tread region. Vipal side bias-ply tyres/tires (VDL) is specifically recommended for the internal repair of bias-ply tyres/tires sidewall region.

Next, we'll see how to choose the appropriate patch considering the tyre/tire and the damage size.

HOW TO CHOOSE VD AND VDL PATCHES?

For interpreting the table and consequently choosing the correct patch, we will use an example to better illustrate the selection operation logic.

Let's consider a 11.00-22 tyre/tire with a 35mm damage on the tread.

PATCH SELECTION FOR PIERCING DAMAGE

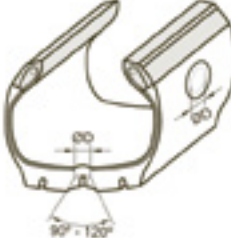



Ply Capacity	THROUGH THE TYRE PENETRATION						
	D (max.)						
	5mm	10mm	15mm	25mm	30mm	35mm	50mm
_4	1	2	3	3	4	4	5
6_8	1	2	3	4	4	4	5
10_12	2	3	4	5	5	5	6
14_16	3	3	4	6	6	6	7
18_20	4	4	5	6	7	7	8
22_24	4	4	5	6	7	7	8

1

11.00-22
Capacity 16 plies

Check the capacity of the tyre's plies.

Ply Capacity	THROUGH THE TYRE PENETRATION						
	D (max.)						
	5mm	10mm	15mm	25mm	30mm	35mm	50mm
_4	1	2	3	3	4	4	5
6_8	1	2	3	4	4	4	5
10_12	2	3	4	5	5	5	6
14_16	3	3	4	6	6	6	7
18_20	4	4	5	6	7	7	8
22_24	4	4	5	6	7	7	8

2

Through-the-tyre penetration

Check if the damage is a through-the-tyre penetration or partial penetration.

IMPORTANT:

For sidewall damages, use the VDL patch line, following the same procedure for selecting a VD patch.



Ply Capacity	D (max.)						
	5mm	10mm	15mm	25mm	30mm	35mm	50mm
_4	1	2	3	3	4	4	5
6_8	1	2	3	4	4	4	5
10_12	2	3	4	5	5	5	6
14_16	3	3	4	6	6	6	7
18_20	4	4	5	6	7	7	8
22_24	4	4	5	6	7	7	8

3

Dimension of damage

35 mm

Identify the value in the table.



Ply Capacity	D (max.)						
	5mm	10mm	15mm	25mm	30mm	35mm	50mm
_4	1	2	3	3	4	4	5
6_8	1	2	3	4	4	4	5
10_12	2	3	4	5	5	5	6
14_16	3	3	4	6	6	6	7
18_20	4	4	5	6	7	7	8
22_24	4	4	5	6	7	7	8



4

Then, identify the patch option indicated for the damage.

Indicated patch: VD 6

PATCH SELECTION FOR NON-PIERCING DAMAGE

Let's consider a 10.00-20 tyre/tire with a 32mm damage on the tread.





Ply Capacity	D (max.)						
	5mm	10mm	15mm	25mm	30mm	35mm	50mm
10_12	1	2	2	3	3	3	4
14_16	2	2	3	3	4	4	4
18_20	3	3	4	4	5	5	5
22_24	3	4	4	5	5	5	6

1

10.00-20
Capacity 14 plies

Check the capacity of the tyre's plies.





Ply Capacity	D (max.)						
	5mm	10mm	15mm	25mm	30mm	35mm	50mm
10_12	1	2	2	3	3	3	4
14_16	2	2	3	3	4	4	4
18_20	3	3	4	4	5	5	5
22_24	3	4	4	5	5	5	6

2

Partial penetration

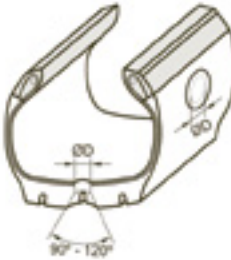
Check if the damage is a through-the-tyre penetration or partial penetration.

DAMAGES THAT DO NOT GO THROUGH THE TYRE



Ply Capacity	D (max.)							
	5mm	10mm	15mm	25mm	30mm	35mm	50mm	
10_12	1	2	2	3	3	3	4	
14_16	2	2	3	3	4	4	4	
18_20	3	3	4	4	5	5	5	
22_24	3	4	4	5	5	5	6	

3

Dimension of damage

32 mm

Identify the immediately upper damage in the table.

DAMAGES THAT DO NOT GO THROUGH THE TYRE

Ply Capacity	D (max.)							
	5mm	10mm	15mm	25mm	30mm	35mm	50mm	
10_12	1	2	2	3	3	3	4	
14_16	2	2	3	3	4	4	4	
18_20	3	3	4	4	5	5	5	
22_24	3	4	4	5	5	5	6	

4

Then, identify the patch option indicated for the damage.

Indicated patch: VD 4

HOW TO APPLY VD AND VDL PATCHES?



Position the template at the center of the damage and mark the outline with chalk or unlock the template so the damage is kept inside the repairable area, avoiding that the patch end is the tyre/tire flexing area.

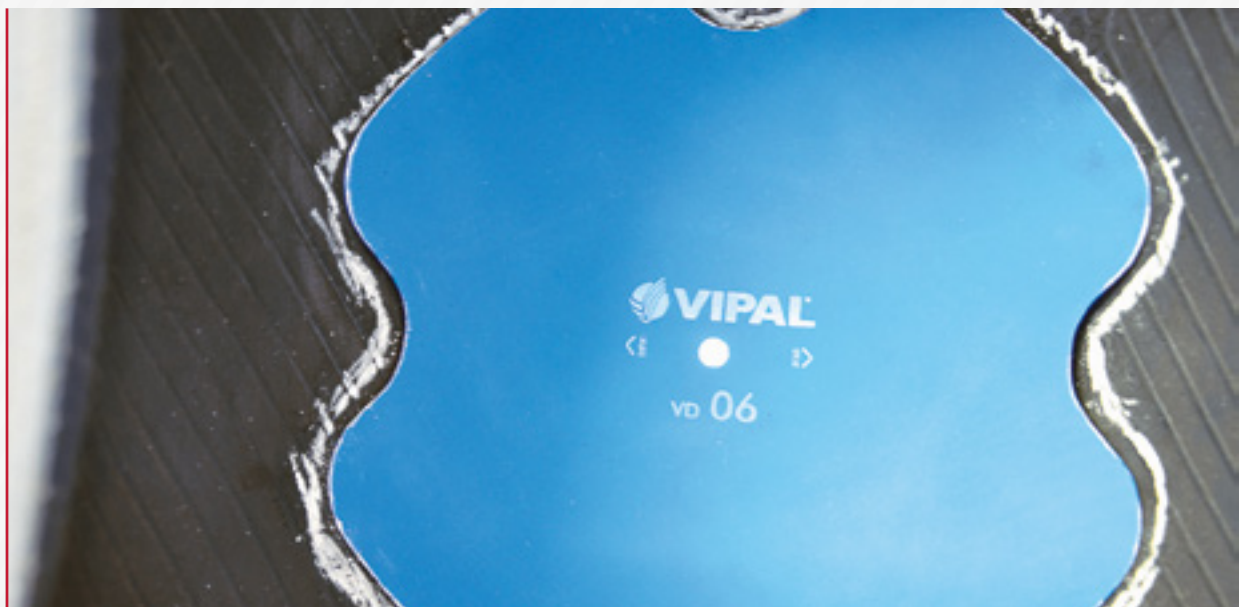

Position the template at the center of the damage and mark the outline with chalk.



To prevent contamination and preserve the inner ply, only the demarcated area should be carefully trimmed using a fine grain carbide grinder from 2,500 to 3,500 rpm. The texture of the buffed area should be RMA1 or RMA2.



Remove the rubber powder in the scraped area with a fine brush and/or vacuum cleaner to obtain a clean and dry surface.



Use the Bufpal surface activator to clean the scraped area.
Don't use compressed air for cleaning and drying.



Apply vulcanizing cement to the scraped area and wait for it to dry completely.
Do not use another air source to accelerate drying.

Attention:

DO NOT USE flammable cement near flame, spark or another ignition source.



Remove the protective film from the patch from the hump to the edges, leaving room to hold the repair and preventing contamination of the base.



The repair application should be made with the beads open similarly to the aperture provided by the usage wheel. Align the repair according to the demarcated area.



Roll the repair correctly from the hump to the edges, ensuring better adhesion and preventing air occlusion.



Apply sealant at the edges of the patch, covering the buffed area and protecting the patch from possible infiltration.

MA PATCH



The agricultural patch (MA) is specifically recommended for internal repairs of agricultural bias-ply tyres/tires on the tread region.

MA PATCH SELECTION



Ply capacity identification:

To select a patch, you have to know the tyre/tire's ply capacity.



Damage measurement site:

Damages should be measured on the first outer ply, disregarding the protective plies.

For interpreting the table and consequently choosing the correct patch, we will use an example to better demonstrate the selection operation logic. Let's consider a 14.9-24 tyre/tire with a 75 mm damage on the tread.

Bias-ply agricultural tires		D (max.) mm								
		25	50	75	100	125	150	175	200	
	Plies Capacity	99	100	100	101	102	103	104	105	
	4_8	99	100	101	102	103	104	105	106	
	10_12	100	101	102	103	104	105	106	107	
	14_16	101	102	103	104	105	106	107	-	
	18_20	101	102	103	104	105	106	107	-	

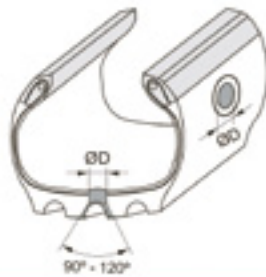

1

Tyre/tire measures:

Tyre/tire 14.9-24

Capacity 8 plies

Bias-ply agricultural tires		D (max.) mm								
		25	50	75	100	125	150	175	200	
	Plies Capacity	99	100	100	101	102	103	104	105	
	4_8	99	100	101	102	103	104	105	106	
	10_12	100	101	102	103	104	105	106	107	
	14_16	101	102	103	104	105	106	107	-	
	18_20	101	102	103	104	105	106	107	-	

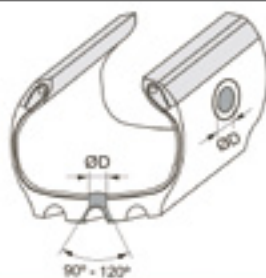

2

Damage diameter:

Ø - 75 mm

Measure the damage size and identify it on the table.

Bias-ply agricultural tires

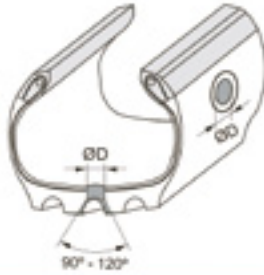

3

Then identifying the options of patches indicated for the damage.

Indicated patches:
MA 100

	Plies Capacity	D (max.) mm							
		25	50	75	100	125	150	175	200
	4_8	99	100	100	101	102	103	104	105
	10_12	99	100	101	102	103	104	105	106
	14_16	100	101	102	103	104	105	106	107
	18_20	101	102	103	104	105	106	107	-

HOW TO APPLY THE MA PATCH?



Clean the area with Bufpal surface activator.



Keep the tyre/tire in normal position, without opening the beads. Position the template or the patch itself at the center of the damage and mark the outline with school chalk.



To prevent contamination and preserve the inner ply, only the demarcated area should be carefully trimmed using a fine grain carbide grinder from 2,500 to 3,500 rpm. The texture of the buffed area should be RMA1 or RMA2. Remove the rubber powder in the scraped area with a fine brush and/or vacuum cleaner to obtain a clean and dry surface.



Use the Bufpal surface activator to clean the scraped area.
Don't use compressed air for cleaning and drying.



Apply vulcanizing cement to the area to be repaired, waiting for the cement to dry properly. Do not use another air source to accelerate drying.

Attention:

DO NOT USE flammable cement near flame, spark or another ignition source.

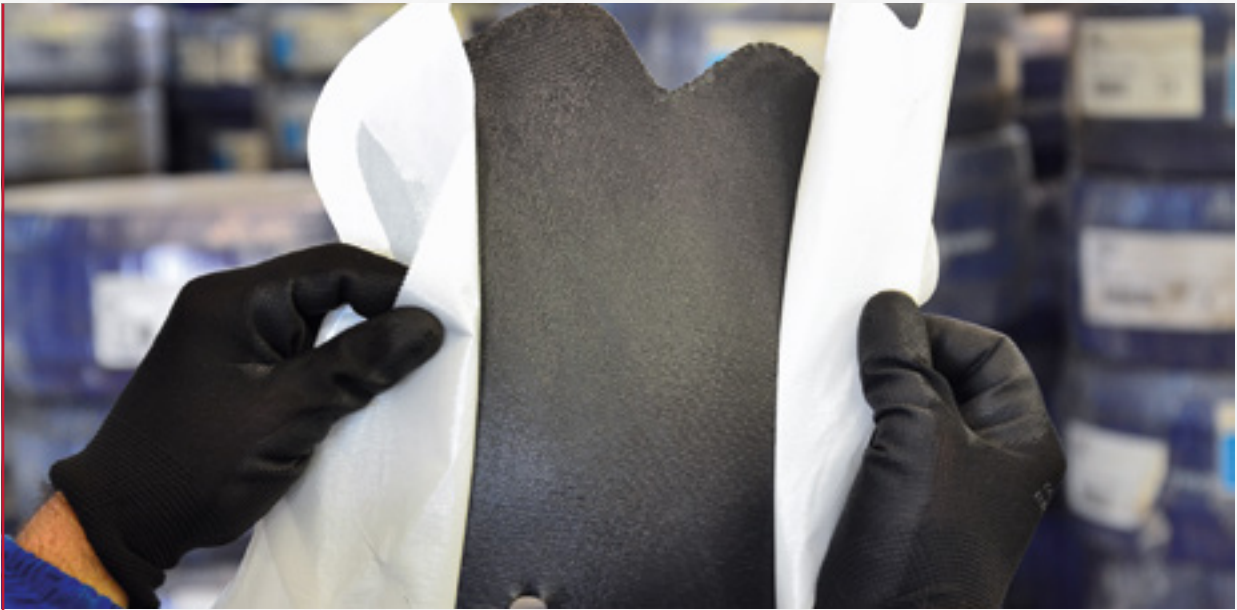

Remove the protective film from the patch from the hump to the edges, leaving room to hold the repair and preventing contamination of the base.



The repair application should be made with the beads open similarly to the aperture provided by the usage wheel. Align the repair according to the demarcated area.



Roll the repair correctly from the hump to the edges, ensuring better adhesion and preventing air occlusion.
Apply sealant at the edges of the patch, covering the buffed area and protecting the patch from possible infiltration.

VT AND VTL PATCH



Vipal Earthwork Patch (VT) is specifically recommended for internal repairs of bias-ply earthwork tyres/tires tread area using the cold method. Vipal Side Earthwork Patch (VTL) is specifically recommended for internal repairs of bias-ply earthwork tyres/tires sidewall using the cold method.

HOW TO CHOOSE VT AND VTL PATCH?

For interpreting the table and consequently choosing the correct patch, we will use an example to better demonstrate the selection operation logic. Let's consider a 17.5-25 tyre/tire with a 100 mm damage on the tread.

Bias ply landscaping tires		PIERCING DAMAGES										
		D (max.) mm										
Pliers capacity	15	25	50	75	100	125	150	175	200	225	250	
												10 94
16 20	250	250	250	251	252	253	254	254	254	-	-	
22 26	250	250	250	252	252	253	254	254	256	256	256	
28 32	250	251	251	252	253	254	255	255	257	257	257	
34 38	251	251	252	252	254	255	255	257	259	259	260(252)	
40 44	251	251	252	253	255	257	256(252)	257(252)	257(252)	258(254)	258(254)	
46 50	251	251	253	254	256(253)	256(253)	257(254)	258(254)	258(256)	259(256)	260(256)	
52 58	251	252	254	255	256(253)	257(254)	257(254)	258(254)	259(256)	260(256)	260(258)	
60	251	252	254	256	256(253)	257(255)	258(256)	258(256)	260(257)	260(257)	260(258)	

1

Tyre/tire measures:

Tyre/tire 17.5-25

Capacity 12 plies

Bias ply landscaping tires		PIERCING DAMAGES										
		D (max.) mm										
Pliers capacity	15	25	50	75	100	125	150	175	200	225	250	
												10 94
16 20	250	250	250	251	252	253	254	254	254	-	-	
22 26	250	250	250	252	252	253	254	254	256	256	256	
28 32	250	251	251	252	253	254	255	255	257	257	257	
34 38	251	251	252	252	254	255	255	257	259	259	260(252)	
40 44	251	251	252	253	255	257	256(252)	257(252)	257(252)	258(254)	258(254)	
46 50	251	251	253	254	256(253)	256(253)	257(254)	258(254)	258(256)	259(256)	260(256)	
52 58	251	252	254	255	256(253)	257(254)	257(254)	258(254)	259(256)	260(256)	260(258)	
60	251	252	254	256	256(253)	257(255)	258(256)	258(256)	260(257)	260(257)	260(258)	

2

Type of damage:

Piercing damage

Bias ply landscaping tires

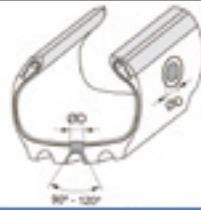

PIERCING DAMAGES

Pliers capacity	D (max.) mm										
	15	25	50	75	100	125	150	175	200	225	250
10 94	250	250	250	250	252	252	254	254	-	-	-
16 20	250	250	250	251	252	253	254	254	254	-	-
22 26	250	250	250	252	252	253	254	254	256	256	256
28 32	250	251	251	252	253	254	255	255	257	257	257
34 38	251	251	252	252	254	255	255	257	259	259	260(252)
40 44	251	251	252	253	255	257	256(252)	257(252)	257(252)	258(254)	258(254)
46 50	251	251	253	254	256(252)	256(252)	257(254)	258(254)	258(256)	259(256)	260(256)
52 58	251	252	254	255	256(252)	257(254)	257(254)	258(254)	259(256)	260(256)	260(256)
60	251	252	254	256	256(252)	257(255)	258(256)	258(256)	260(257)	260(257)	260(258)

3

Damage size:

Ø - 100 mm

Measure the damage dimension and identify it in the table.

Bias ply landscaping tires



PIERCING DAMAGES

Pliers capacity	D (max.) mm										
	15	25	50	75	100	125	150	175	200	225	250
10 94	250	250	250	250	252	252	254	254	-	-	-
16 20	250	250	250	251	252	253	254	254	254	-	-
22 26	250	250	250	252	252	253	254	254	256	256	256
28 32	250	251	251	252	253	254	255	255	257	257	257
34 38	251	251	252	252	254	255	255	257	259	259	260(252)
40 44	251	251	252	253	255	257	256(252)	257(252)	257(252)	258(254)	258(254)
46 50	251	251	253	254	256(252)	256(252)	257(254)	258(254)	258(256)	259(256)	260(256)
52 58	251	252	254	255	256(252)	257(254)	257(254)	258(254)	259(256)	260(256)	260(256)
60	251	252	254	256	256(252)	257(255)	258(256)	258(256)	260(257)	260(257)	260(258)

4

Then identifying the options of patches indicated for the damage.

Indicated patches:

VT 252

For tyres/tires with a load capacity above 40 plies with damages to the tread, Vipal Rubber recommends a modular application of patches (overlap). The main benefits of this process are a broader option of types of damages to be repaired, fast troubleshooting, and eliminating the need for manufacturing handcrafted patches.

Bias ply landscaping tires		PIERCING DAMAGES										
		D (max.) mm										
	Plies capacity	15	25	50	75	100	125	150	175	200	225	250
	10_16	250	250	250	250	252	252	254	254	-	-	-
	16_20	250	250	250	251	252	253	254	254	254	-	-
	22_26	250	250	250	252	252	253	254	254	256	256	256
	28_32	250	251	251	252	253	254	255	255	257	257	257
	34_38	251	251	252	252	254	255	255	257	259	259	258/257
	40_44	251	251	252	253	255	257	256/252	257/252	257/252	258/254	258/254
	46_50	251	251	253	254	256/253	256/253	257/254	258/254	258/256	259/256	260/256
	52_58	251	252	254	255	256/253	257/254	257/254	258/254	258/256	260/256	260/257
	60	251	252	254	256	256/253	257/255	258/256	258/256	260/257	260/257	260/257

1

Tyre/tire measures:

Tyre/tire 24.00-35

Capacity 42 plies

Bias ply landscaping tires		PIERCING DAMAGES										
		D (max.) mm										
	Plies capacity	15	25	50	75	100	125	150	175	200	225	250
	10_16	250	250	250	250	252	252	254	254	-	-	-
	16_20	250	250	250	251	252	253	254	254	254	-	-
	22_26	250	250	250	252	252	253	254	254	256	256	256
	28_32	250	251	251	252	253	254	255	255	257	257	257
	34_38	251	251	252	252	254	255	255	257	259	259	258/257
	40_44	251	251	252	253	255	257	256/252	257/252	257/252	258/254	258/254
	46_50	251	251	253	254	256/253	256/253	257/254	258/254	258/256	259/256	260/256
	52_58	251	252	254	255	256/253	257/254	257/254	258/254	258/256	260/256	260/257
	60	251	252	254	256	256/253	257/255	258/256	258/256	260/257	260/257	260/257

2

Type of damage:

Piercing damage

Bias ply landscaping tires		PIERCING DAMAGES										
		D (max.) mm										
Pliers capacity	15	25	50	75	100	125	150	175	200	225	250	
	10 94	250	250	250	250	252	252	254	254	-	-	-
16 20	250	250	250	251	252	253	254	254	254	-	-	
22 26	250	250	250	252	252	253	254	254	256	256	256	
28 32	250	251	251	252	253	254	255	255	257	257	257	
34 38	251	251	252	252	254	255	255	257	259	259	260/251	
40 44	251	251	252	253	255	257	256/252	257/252	257/252	258/254	258/254	
46 50	251	251	253	254	256/253	256/253	257/254	258/254	258/256	259/256	260/256	
52 58	251	252	254	255	256/253	257/254	257/254	258/254	259/256	260/256	260/251	
60	251	252	254	256	256/253	257/255	258/256	258/256	260/257	260/257	260/253	

3

Damage size:
Ø - 150 mm

Measure the damage dimension and identify it in the table.

Bias ply landscaping tires		PIERCING DAMAGES										
		D (max.) mm										
Pliers capacity	15	25	50	75	100	125	150	175	200	225	250	
	10 94	250	250	250	250	252	252	254	254	-	-	-
16 20	250	250	250	251	252	253	254	254	254	-	-	
22 26	250	250	250	252	252	253	254	254	256	256	256	
28 32	250	251	251	252	253	254	255	255	257	257	257	
34 38	251	251	252	252	254	255	255	257	259	259	260/251	
40 44	251	251	252	253	255	257	256/252	257/252	257/252	258/254	258/254	
46 50	251	251	253	254	256/253	256/253	257/254	258/254	258/256	259/256	260/256	
52 58	251	252	254	255	256/253	257/254	257/254	258/254	259/256	260/256	260/251	
60	251	252	254	256	256/253	257/255	258/256	258/256	260/257	260/257	260/253	

4

Then identifying the options of patches indicated for the damage.

Indicated patches:
VT 256 e 252



Clean the area with Bufpal surface activator.

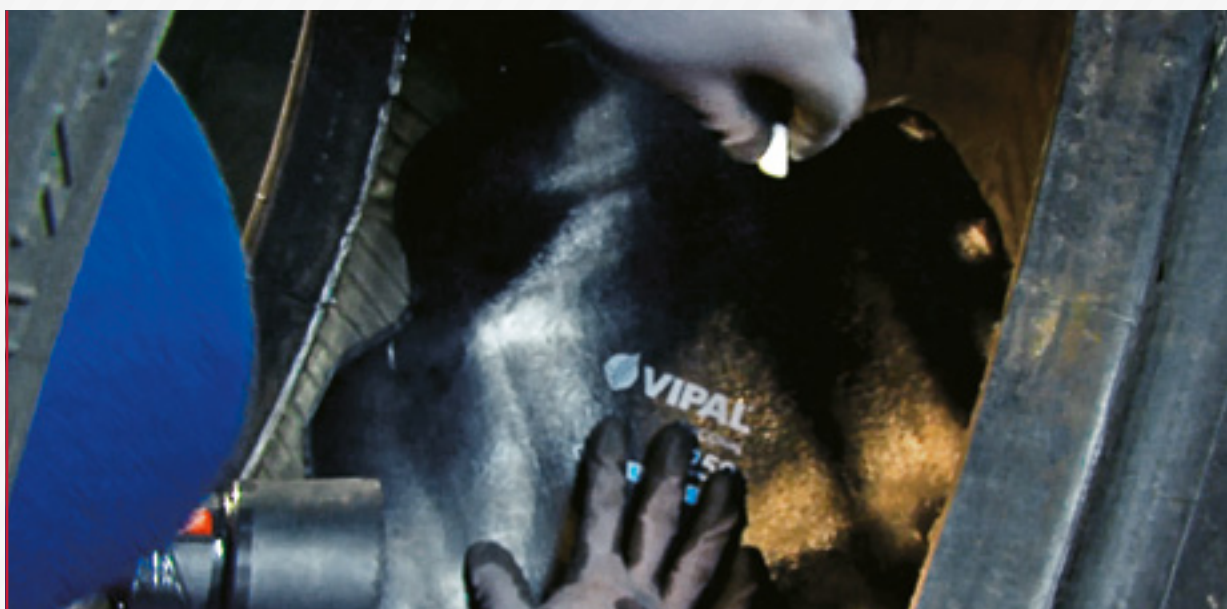

Keep the tyre/tire in normal position, without opening the beads. Position the template or the patch itself at the center of the damage and mark the outline with school chalk.

Note:

The marking of vulcanized repairs in direct vapor autoclave should extend beyond 10 mm after the patch size.



To prevent contamination and preserve the inner ply, only the demarcated area should be carefully trimmed using a fine grain carbide grinder from 2,500 to 3,500 rpm. The texture of the buffed area should be RMA1 or RMA2.



Remove the rubber powder in the scraped area by suction to obtain a clean and dry surface.



Use the Bufpal surface activator to clean the scraped area.
Don't use compressed air for cleaning and drying.



Apply vulcanizing cement to the area to be repaired, waiting for the cement to dry properly. Do not use another air source to accelerate drying.

Attention:

DO NOT USE flammable cement near flame, spark or another ignition source.



Remove the protective film from the patch from the hump to the edges, leaving room to hold the repair and preventing contamination of the base.



The repair should be applied with the beads at the normal position. The repair should be applied with the beads at the normal position. Align the repair according to the demarcated area.



Roll the repair correctly from the hump to the edges, ensuring better adhesion and preventing air occlusion.



Important:

For repairs that will be vulcanized in direct vapor autoclave, we recommend using a bulk or common connection on the patch edges.



Apply sealant at the edges of the patch, covering the buffed area and protecting the patch from possible infiltration.

When repairs are vulcanized in direct vapor autoclave, the sealant application is performed after vulcanization.

When VT patches have to be overlapped, first apply the larger patch following the previous process. To apply the overlap, from the smaller patch, follow instructions below:

This process should always be performed using the hot method.



After applying the larger patch, centralize the smaller patch on the patch already applied, marking with a chalk.



Scrape the larger patch according to the marked area.



Aspirate the residues and apply Bufpal Rubber Surfaces Activator to properly clean the area.



Apply vulk cement on the scraped area.

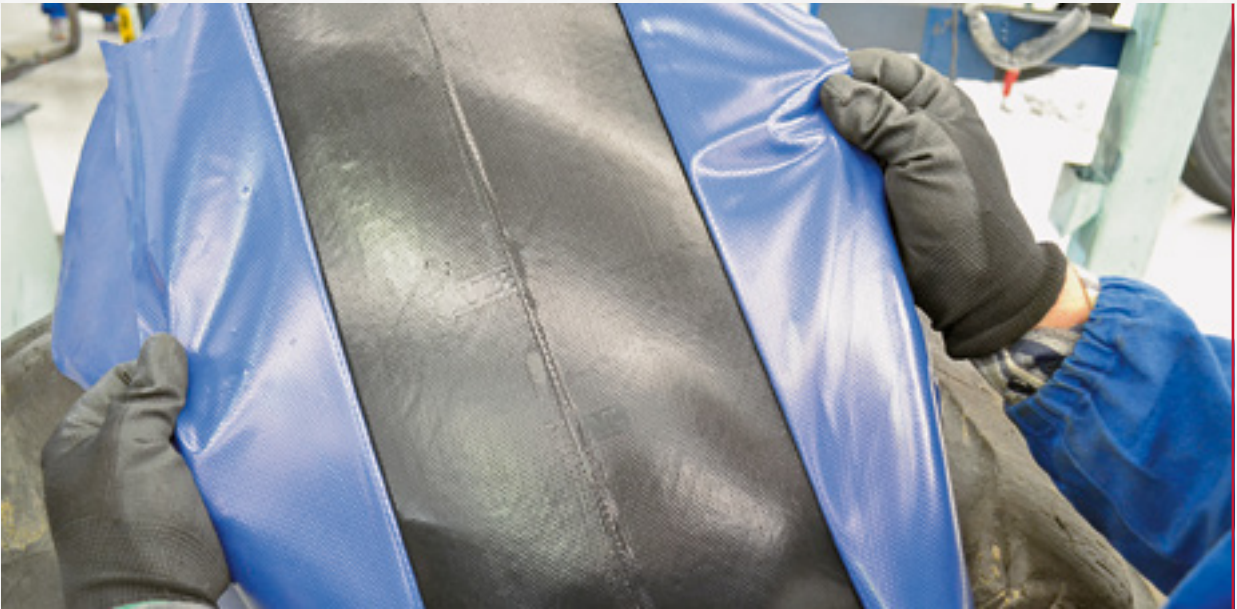

With the patch duly prepared, remove the plastic from the center to the edges.



Centralize the patch in the scraped area.



With aid of a rubber hammer, fix the patch on the center.



Roll the upper patch from the center to the edges. For repairs that will be vulcanized in direct vapor autoclave, we recommend using a bulk or common connection on the patch edges.



Apply sealant to the patches edges. When repairs are vulcanized in direct vapor autoclave, the sealant application is performed after vulcanization.

RAC - OTR PATCH



RAC (Radial Centralized) patches are intended to OTR radial tyres/tires internal repairs. These patches are built with layers of nylon fibers that follow the same manufacturing direction as OTR radial tyre/tire casing plies.

HOW TO CHOOSE THE RAC - OTR PATCH?

For interpreting the table and consequently choosing the correct patch, we will use an example to better demonstrate the selection operation logic. Let's consider a 24.00 R 35 tyre/tire with a 90 mm damage on the tread.



Rim 29 to 35



RADIAL TIRES



Ø B (mm)	RAC
8	20
25	44
35	35
40	46
55	50
65	55
80	52
90	65
105	56
120	75

1

**Tyre/tire
measures:**
24.00 R 35



Aro 29 a 35



PNEUS RADIAIS



Ø B (mm)	RAC
8	20
25	44
35	35
40	46
55	50
65	55
80	52
90	65
105	56
120	75

2

Damage position:
Tread



Aro 29 a 35



PNEUS RADIAIS



Ø B (mm)	RAC
8	20
25	44
35	35
40	46
55	50
65	55
80	52
90	65
105	56
120	75

3

Damage size:

Ø - 90 mm

Measure the damage dimension and identify it in the table.



Aro 29 a 35



PNEUS RADIAIS



Ø B (mm)	RAC
8	20
25	44
35	35
40	46
55	50
65	55
80	52
90	65
105	56
120	75

4

Then identifying the options of patches indicated for the damage.

Indicated patches:

RAC 65

HOW TO APPLY RAC - OTR PATCHES?



Clean the area with Bufpal surface activator.



Keep the tyre/tire in normal position, without opening the beads. Position the template or the patch itself at the center of the damage and mark the outline with school chalk.



To prevent contamination and preserve the inner ply, only the demarcated area should be carefully trimmed using a fine grain carbide grinder from 2,500 to 3,500 rpm. The texture of the buffed area should be RMA1 or RMA2.



Remove the rubber powder in the scraped area by suction to obtain a clean and dry surface.



Use the Bufpal surface activator to clean the scraped area.
Don't use compressed air for cleaning and drying.



Apply vulcanizing cement to the area to be repaired, waiting for the cement to dry properly. Do not use another air source to accelerate drying.

Attention:

DO NOT USE flammable cement near flame, spark or another ignition source.



Remove the protective film from the patch from the hump to the edges, leaving room to hold the repair and preventing contamination of the base.



Align the patch according to the demarcated area, keeping the indication arrows toward the beads.



Roll the repair correctly from the hump to the edges, ensuring better adhesion and preventing air occlusion.



Apply sealant at the edges of the patch, covering the buffed area and protecting the patch from possible infiltration.



RAC PATCH - AGRICULTURAL



RAC (Radial Centralized) patches are intended to agricultural radial tyres/tires internal repairs. These patches are built with layers of nylon fibers that follow the same manufacturing direction as agricultural radial tire casing plies.



HOW TO CHOOSE THE RAC - AGRICULTURAL PATCH?

For interpreting the table and consequently choosing the correct patch, we will use an example to better demonstrate the selection operation logic. Let's consider a 710/70 R 38 tyre/tire with a 40 mm damage on the tread.

		
		
20.8 - 30.5 420/ - 1050/	Ø B (mm)	RAC
	10	20
	10	24
	25	80
	40	82
	70	84
	85	86



**Tyre/tire
measures:**
710/70 R 38

1

		
		
20.8 - 30.5 420/ - 1050/	Ø B (mm)	RAC
	10	20
	10	24
	25	80
	40	82
	70	84
	85	86

Damage position:
Tread

2



		
		
20.8 - 30.5 420/ - 1050/	Ø B (mm)	RAC
	10	20
	10	24
	25	80
	40	82
	70	84
	85	86

3

Damage size:

Ø - 40 mm

Measure the damage dimension and identify it in the table.

		
		
20.8 - 30.5 420/ - 1050/	Ø B (mm)	RAC
	10	20
	10	24
	25	80
	40	82
	70	84
	85	86

4

Then identifying the options of patches indicated for the damage.

Indicated patches:

RAC 82

HOW TO APPLY RAC - AGRICULTURAL PATCHES?



Clean the area with Bufpal surface activator.



Keep the tire in normal position, without opening the beads. Position the template or the patch itself at the center of the damage and mark the outline with school chalk.



To prevent contamination and preserve the inner ply, only the demarcated area should be carefully trimmed using a fine grain carbide grinder from 2,500 to 3,500 rpm. The texture of the buffed area should be RMA1 or RMA2.



Remove the rubber powder in the scraped area by suction to obtain a clean and dry surface.



Use the Bufpal surface activator to clean the scraped area.
Don't use compressed air for cleaning and drying.



Apply vulcanizing cement to the area to be repaired, waiting for the cement to dry properly. Do not use another air source to accelerate drying.

Attention:

DO NOT USE flammable cement near flame, spark or another ignition source.



Remove the protective film from the patch from the hump to the edges, leaving room to hold the repair and preventing contamination of the base.



Align the patch according to the demarcated area, keeping the indication arrows toward the beads.



Roll the repair correctly from the hump to the edges, ensuring better adhesion and preventing air occlusion.



Apply sealant at the edges of the patch, covering the buffed area and protecting the patch from possible infiltration.

REMOPAT

Remopat is intended to repair damages of up to 3mm in radial tires when they are being retreaded using the reshaping process. Its feature is to become almost invisible after vulcanized.

Remopat repairs presentation

REMOPAT REPAIRS PRESENTATION

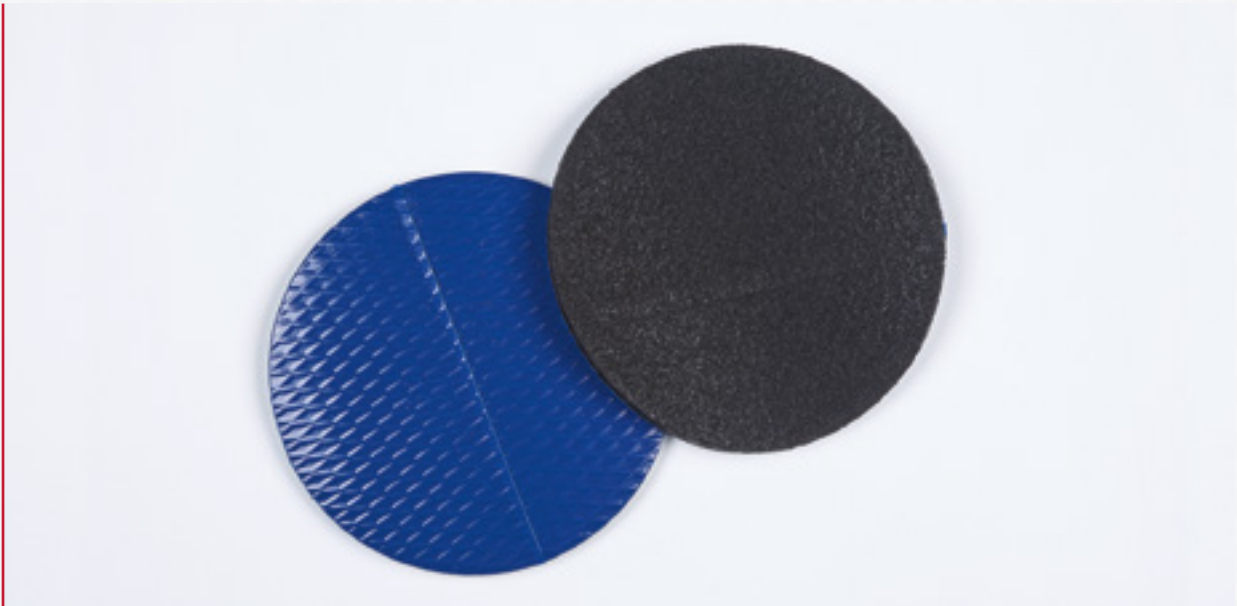

These are round, oval, or square non-vulcanized parts with the base protected by a polyethylene film and the surface with a light rubber dust layer.

Code	Denomination	Dimensions (mm) +2	Thickness (mm) +0,1	Quantity/Box
348322	Remopat 01	Ø 25	2,0	100
348323	Remopat 50	Ø 50	2,0	40
348324	Remopat 02	60 x 25	2,0	60
348325	Remopat 36	Ø 36	2,0	70
348326	Remopat with poli 36	Ø 36	2,0	70
348327	Remopat with poli 01	Ø 25	2,0	100
348328	Remopat 20 x 20 with ply	20 x 20	3,1	100
348329	Remopat 35 x 35 with ply	35 x 35	3,1	60

HOW TO APPLY REMOPAT?



While retreading passenger vehicles tires, if you detect a minor hole or imperfection inside the tire, this should be marked and sent to the repair process.

Select the Remopat shape according to the damage to be repaired in order to correct the imperfection.



Use the repair itself to mark the area to be repaired.



Scrape and prepare the marked area leaving a RMA1 or RMA2 texture, taking care not to make it too deep nor burning the rubber.

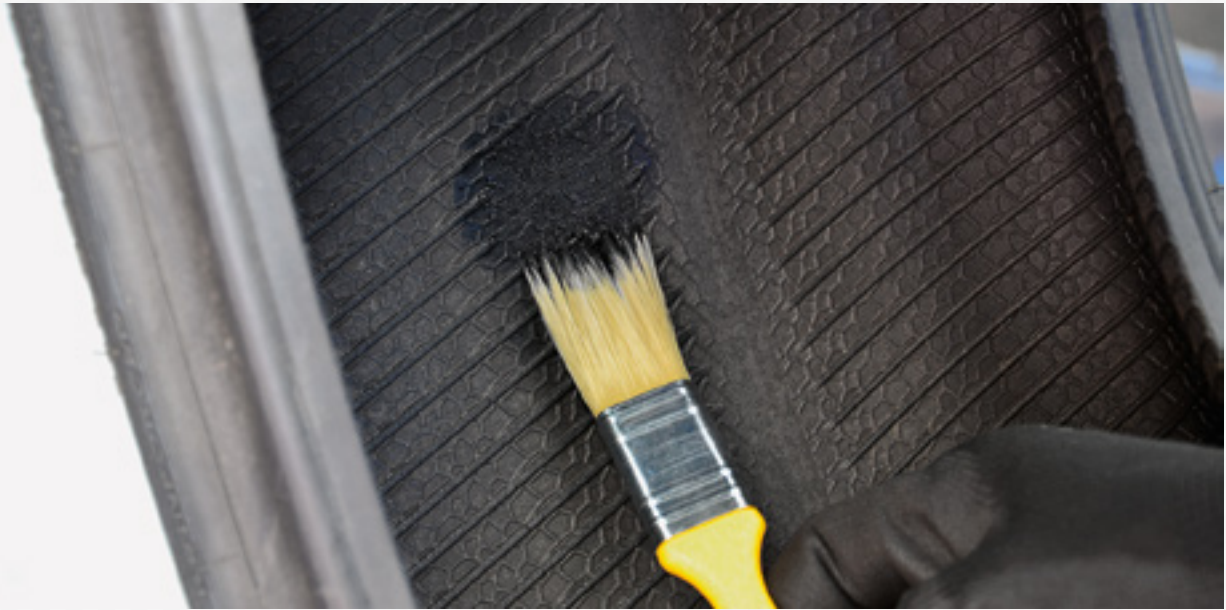

Making circular movements, apply vulk cement and wait for it to dry completely.



Remove the protective plastic from the Remopat base.



Apply the patch firmly over the damage and roll it firmly from the center to the edges, then vulcanize the tire.

After vulcanization, apply sealant to the repair and scraped areas.

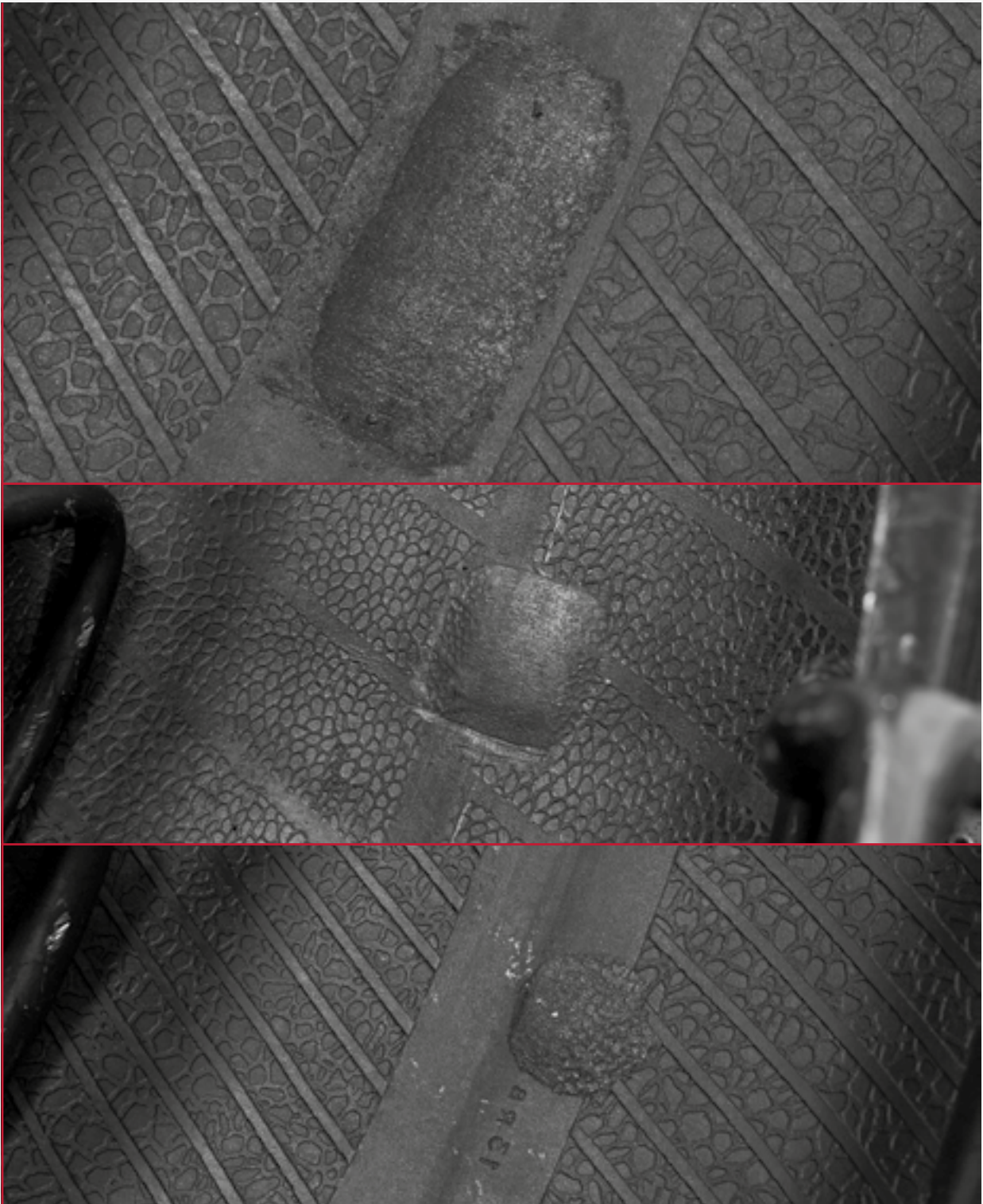

Above we have pictures of the result after vulcanization.

VIPASEAL

Vipaseal is intended to emergency repairs of damages up to 6mm to the tread area of tubeless tyres/tires.

VIPASEAL REPAIRS PRESENTATION



Made of nylon threads impregnated with high stickiness and low permeability elastomers.

Code	Denomination	Dimensions (mm) +5	Quantity/Box
351119	Vipaseal 100	100	60
351120	Vipaseal 200	200	30

HOW TO APPLY VIPASEAL?



Select the proper tools to apply Vipaseal.



Locate and remove the object that caused the hole.



Inflate the tyre/tire mounted to its own wheel at a pressure above the indicated for driving. Approximately 10% more.



Using a manual milling cutter, clean the hole with circular movements.



Select Vipaseal with enough length so that, when bended, it passes through the casing leaving a piece to be cut after application.

Put the Vipaseal in the tool slot as the picture shows.



Put the Vipaseal on the tool rod as the picture shows.



With the tyre/tire still inflated, insert the tool in the damage making pressure until you notice it crossed the casing.



Make an ¼ turn and carefully return the tool so that Vipaseal remains on the damage.



Using a knife, cut the excess of repair.



Calibrate the tyre/tire at operating pressure and perform a leak test, then the tyre/tire will be ready for use.

IMPORTANT NOTE::

Since this is an emergency repair, as soon as possible, a definitive repair should be carried out.



NOTES



Ruled lines for taking notes.



Lined writing area consisting of 25 horizontal red lines.

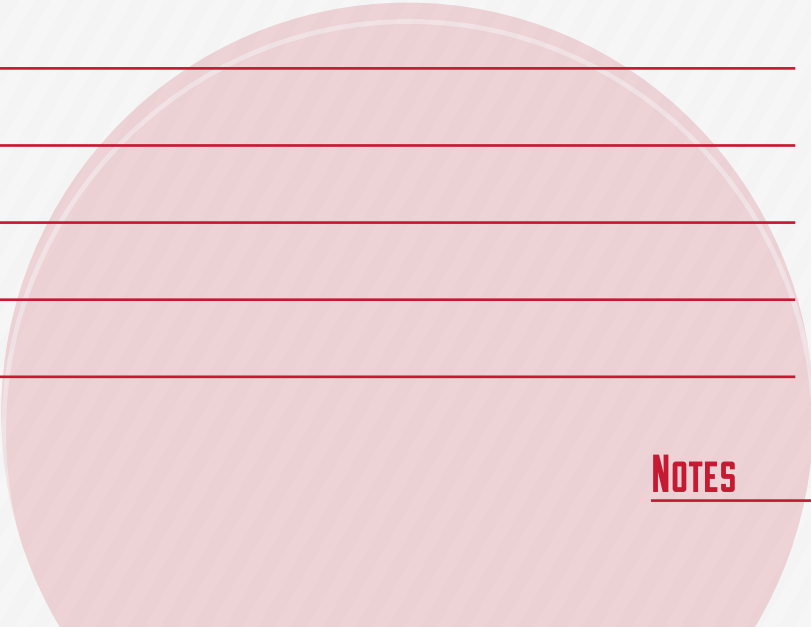

Vipal Borrachas

Central de Atendimento Vipal Borrachas

Av. Severo Dulus, 1395 | 8º andar
Bairro São João | Porto Alegre / RS | CEP 90200-310
Tel.: Para Capitais: 3004-0505 - Demais Localidades: 0800 707-0505
www.vipal.com.br | vipal@vipal.com.br

Regional Nordeste: regionalnordeste@vipal.com.br

Regional Norte: regionalnorte@vipal.com.br

Regional Centro-Oeste: regionalcentrooeste@vipal.com.br

Regional Sul: regionalsul@vipal.com.br

Regional Sudeste: regionalsudeste@vipal.com.br

Departamento de Negócios Internacionais

Tel.: +55 51 3205.3050 | Fax: +55 51 3205.3051
www.vipal.com | sales@vipal.com