

FactoryDirect



8888 Keystone Crossing, Suite 1300
Indianapolis, IN 46240
www.FactoryDirect4Homes.com

• OFFICE •

317-228-3300

• TOLL FREE •

800-380-4522

888-317-2288



FactoryDirect

Factory Direct, established in 1991 right here Indianapolis consisted of several crews who installed for several popular window companies exclusively. We were able to work with customers and go over the final project...We were able to develop our knowledge of what customers really desire in a great home improvement company.

In the mid 90's Factory Direct decided to offer their services to the public. We found that customers wanted to be helped not sold. We educated customers, brought new ideas, and listened to what customers wanted...OPTIONS. With the top manufacturers in America to choose from, customers really enjoyed the one stop shop. We go into each home asking ourselves, how we can be of help to improve each and every home.

Our customers really enjoy the factory direct pricing, certified factory installation, and our secret ingredient which is GREAT PRODUCTS and exceptional service.

Factory Direct has 8 crews. Our Window Installers only install windows, the same for our roofing crews, they only replace roofs, and of course our Siding Installers only install siding. Here at Factory Direct in Indianapolis each installer has 15 years or more of experience which makes a huge difference, and some of our installers have over 30 years of experience.

We believe installers should be compensated very well...After all they are the ones taking the extra time and effort to complete each and every project. Happy Installers make for Happy Customers. Keep in mind we were established in this industry as installers not "middle men".

ABOUT US



QUALIFIES *for* MOST EFFICIENT 2019

Triple Pane

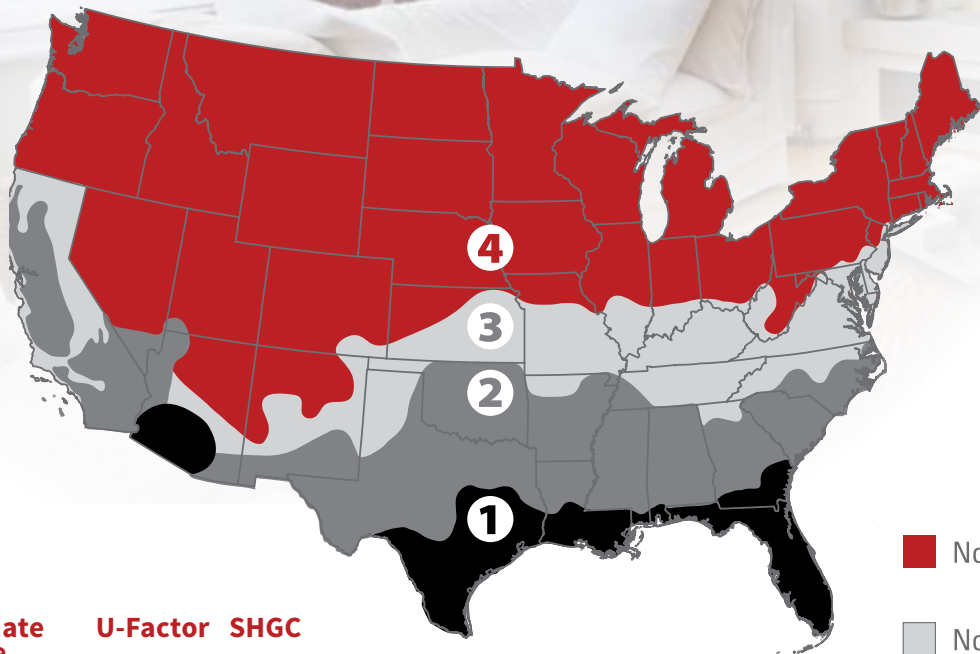
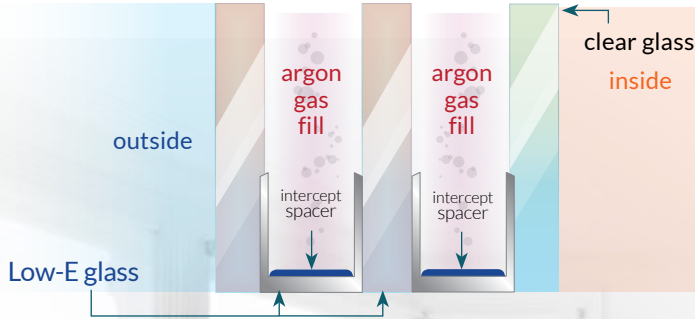

Climate Zone	U-Factor	SHGC
Northern	0.27	ANY
North-Central	0.30	≤0.40
South-Central	0.30	≤0.25
South	0.40	≤0.25

- Northern
- North-Central
- South-Central
- Southern



THE PERFORMANCE MANAGER

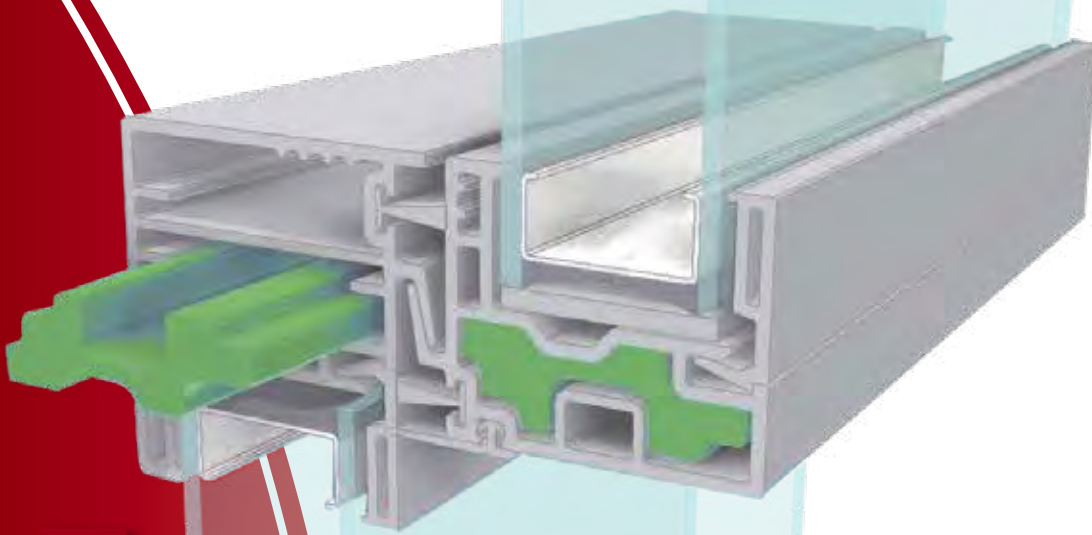

Innergy Sash Frame*

INNERGY™
Rigid Thermal Reinforcements

Innergy is the innovative, energy-efficient alternative to aluminum. Rigid Thermal Reinforcements are advanced fiberglass reinforced resin inserts, designed to slide easily into window and door frame chambers for greater support and insulation.

Better Thermal Performance

Up to 700 times better than aluminum in material-to-material comparisons.

Better protection against condensation

Helps prevent staining that can occur with metal reinforcements.

Better Thermal Break

Impervious to cold or heat.

Better flexibility

Will not permanently set when impacted.

**E
N
E
R
G
Y**
EFFICIENT



OUR WINDOW

THEIR WINDOW

Continuous Interlock

Meeting rails join with a continuous over & under interlock.

Condensation and air infiltration are reduced. Many competitors notch-out lock area, sacrificing performance.

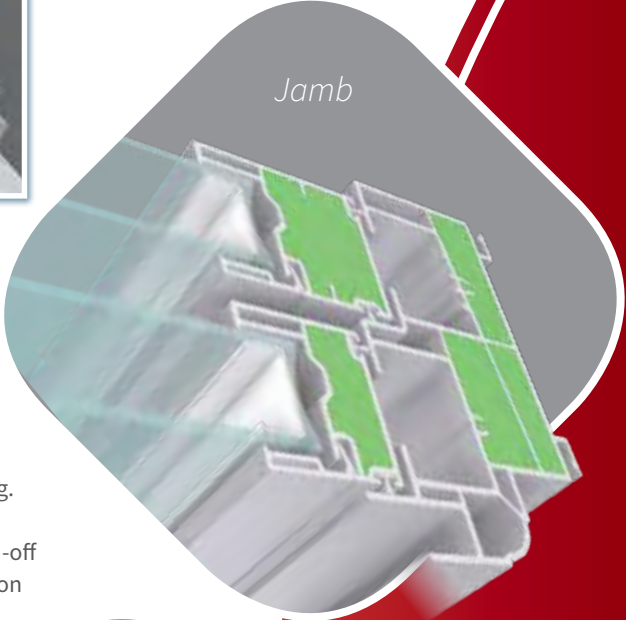

Jamb

OUR WINDOW

THEIR WINDOW

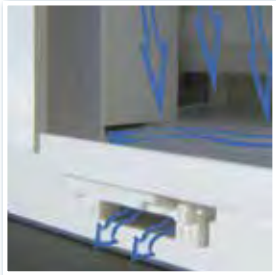

True Sloped Sill

Rain runs straight off the sloped sill away from the home. No weep holes to clog.

A poor design filters rain run-off through the window extrusion and out weep holes. Weep holes may clog.



Head

OUR WINDOW

THEIR WINDOW



Separate extrusion for Head of Window

Twice as much sash & frame overlap when closed.

Reduced air infiltration.

Insulating Green Foam
Increases your energy savings. Lowers the U-Value thus adding comfort to the home.



Sill

VINYL

Our maintenance-free vinyl retains its color and smooth surface. Vinyl is not a thermal conductor.

Multi-chamber extrusions are strong and provide additional insulation. Fusion

Welded Vinyl Corners create strong, seamless frame and sash units.

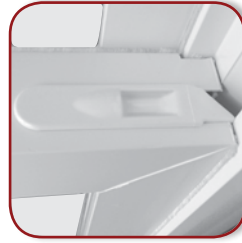

Tilt Latches have an updated look. Smoother operation, and better performance.



Higher sill dam (1/4") Groove in bottom of sash for vinyl "fin" (just inside inner sill dam) to lock into. Creating a secure fit.

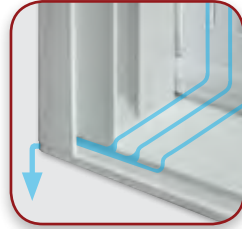

True Sloped Sill water moves away from home, no external weep holes to clog.

DOUBLE HUNG

Lift Rails are part of the sash extrusion. They will not snap off. Innergy reinforced meeting rail is standard.



GLIDER • 2 & 3 LITE

Sash removes from the inside for easy cleaning. Sash with full length pull rails glide easily on brass rollers. Sash rails meet with continuous interlock which reduces air infiltration. Innergy reinforced interlock is standard.



CASEMENT

Casement multi-point lock secures in up to four places. Clean casements from inside your home. Hinged side of sash slides away from frame when opened 90°.

CASEMENT & AWNING

Handle folds into operator cover of casement and awning. Awning and casement stop air infiltration with triple seal.

8000 SERIES



4 Lite Bay with casing,
stain & lighting options.

FEATURES

Timberstrand® engineered wood support system between windows is stronger than ordinary wood.

Maintenance-free clad exterior white or tan vinyl or painted aluminum. Standard birch, optional oak interior. Hanging cable system, optional knee braces.

Bay - picture window flanked by two operable windows: double-hung or casement.

Bow - all windows same size picture windows flanked by two operable windows, usually casement



OPTIONS

- Hip roof to accept shingles
- Hip or concave aluminum roof in 29 colors
- Hip or concave copper roof
- Stain & lacquer interior to match oak wood grain windows
- White or beige paint & lacquer interior
- White or beige plastic laminate seat
- Insulated seat
- 1-3 recessed lights, clear or frosted lenses white or brushed nickel trim rings



5 Lite Bow with Hip Roof option.

RECESSED LIGHTING

Standard clear lens • 1, 2 or 3 lights, low voltage halogen bulb[s] & transformer included

Polished brass, brushed nickel or white



BAY & BOW

All Color & Glass Options



3 Lite Bay with Concave Copper Roof option.



Bay with Hip Copper Roof option.

PATENTED



Solid-steel, zinc-plated tandem rollers glide smoothly. Corrosion resistant Iridium coating.

3 Point, Multi-Point Lock Security Upgrade

When door contacts frame, steel hooks automatically lock at two additional points along the frame.



Foot-operated lock provides an extra lock point allowing for partial opening for secure ventilation.

FEATURES & BENEFITS

Fusion-welded door panel corners and frame top for a strong, seamless door.

Our vinyl formulation retains its color and smooth surface.

Vertical main frame and door panel reinforced with aluminum.

Foam filled, vertical main frame adds strength and insulating performance.

Over/Under interlock and double weather-stripping where door panels meet.

Sliding door panel and main frame meet with triple weather-stripping.

Sloped, aluminum-reinforced sill guides rain water outside and away.

Safety glass.

Sturdy, extruded, aluminum screen frame in white, tan or brown.

Standard fiberglass mesh.

Optional aluminum or pet mesh.

Foam Filled Main Frame



Jamb Standard



Main Frame

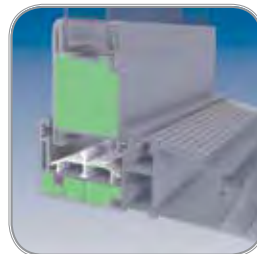

Sill

Morticed Hook Locks



Two point*

Standard single point

Morticed Screen Handle

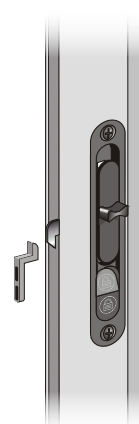

1580 lock standard

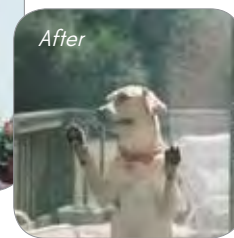

Pet Screen

- Resists damage by dogs and cats
- Excellent outward visibility
- Made of strong vinyl-coated polyester
- Not harmful to pets
- Easy to install



Handle Sets



Satin Nickel

Polished Brass*

Antique Brass*

Aged Bronze*

Tan*

White*

Coppertone

Standard on Woodgrains

Vinyl Colors



Exterior Paint*

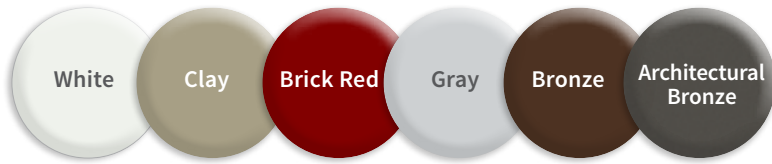

Interior Woodgrains*

20 YEAR WARRANTY AGAINST FADING • PEELING • CRACKING



N/A Brown Vinyl

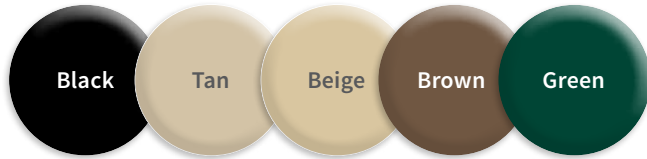

Internal Grids & Decorative Glass*

Colonial, Prairie, Double Prairie: Flat, Contour, Brasses, View glass
Diamond: Flat & View glass only



Internal Mini Blinds*

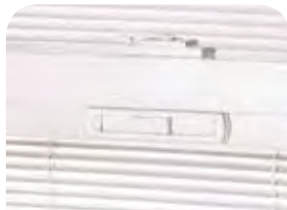

Plated Lock Finishes*

Available in the Double Hung, Slider, Three-Lite Slider and Casement Windows.

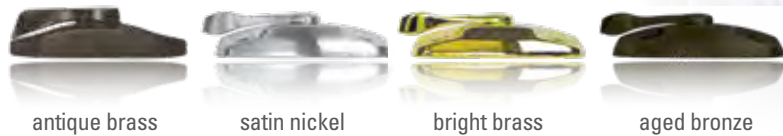

80-000 OPTIONS

Screen Options



**BetterVUE® Screen Mesh
Better Insect Screen**

- 10% Better Insect Protection
- 20% Better Airflow
- 20% Clearer View



Standard Screen Mesh

- Slight more obstructed
- Less Airflow than BetterVue Screens
- Proven and Reliable

*Also available in Pet Screen

ENTRY DOORS

ENERGY EFFICIENCY

Our entry doors start with a strong, rigid polyurethane foam core that meets environmental guidelines and offers maximum thermal protection and dimensional stability.

Perimeter weather-stripping forms a weather tight seal.

The adjustable threshold achieves a proper seal with a few turns from a screw driver.

High-performance weather-stripping and bottom sweep upgrades further strengthen this weather barrier of your home.

OPTIONS

- Available in smooth or wood grain finish.
- Over a dozen decorative glass styles.
- Composite block inside the door for improved insulation and security.
- 27 factory applied paint and stain options.

FIBERGLASS

Fiberglass resists dents, dings and splinters. Composite interior framing seals and insulates. Your door is impervious to water and will not warp or rot.

STEEL

The 22 gauge galvanized steel sheeting. The patented adjustable hinge system.

DECORATIVE DOOR GLASS OPTIONS



Harlow

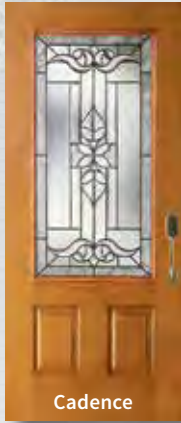

Cadence



Auburn



Banter



Grace

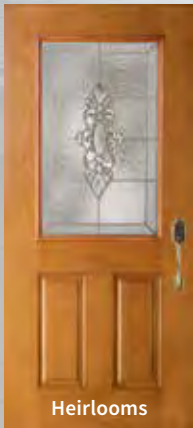

Heirlooms



Renewed Impressions
Coming subject to change



Everton



Majestic



Monterey



Nouveau



Oak Park

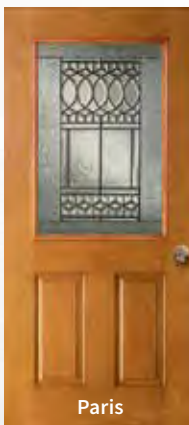

Paris



Topaz

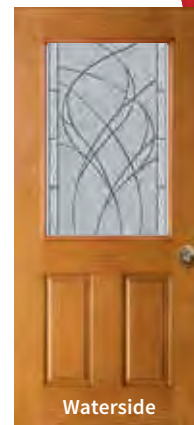

Waterside

Beauty • Quality • Energy Efficiency



FactoryDirect

OFFICE (317) 228-3300 TOLL FREE (800) 380-4522

8888 Keystone Crossing, Suite 1300
Indianapolis, IN 46240
www.FactoryDirect4Homes.com