

**CREATIVE
DYNAMIC
RELIABLE**

WELCOME

TO THE FASCINATING WORLD OF LED LIGHTING

Discover extraordinary lighting and reliable control.

Dynamic visuals, colorful effects, or static elegance — A creative vision and stunning lighting design ultimately require the right solutions.

The MADRIX range of software and hardware solutions includes state-of-the-art tools for easy configuration, automatic health monitoring, and creative lighting control.

All around the world amazing LED projects are brought to life in entertainment, live productions, and archtainment thanks to our high-quality, professional products made in Germany.

5 Years of Warranty
Reliability you can count on.

eco Sustainability
Global awareness.

Made in Germany
Excellence in engineering.

Worldwide Community
Join the MADRIX Family of lighting designers, VJs, operators, engineers, and dealers who support each other all around the globe.

Ease Of Use
You can start creatively right away since we focus on being able to get results fast and products that work out of the box.



Flexible Integration
Support for a wide variety of industry standards makes it easy to integrate MADRIX into your current and future projects.

World-Class Support
Countless projects have been completed successfully thanks to our helpful and dedicated technical-support team.

Vast Experience
Benefit from years of experience and industry knowledge. inoage develops lighting software since 2005.

Regular Free Updates
We regularly update our softwares and hardware firmwares, often for free, with new features and useful improvements.

Download Catalog

 @MADRIX.DE
 @madrix_team
 @MADRIX
 @MADRIX_Team
 @MADRIX
 @MADRIX_Team

News
Projects
Inspiration



LET'S MAKE YOUR PROJECT



AURORA CREATIVE STUDIOS / PROJECT INTERNATIONAL / VIDELIO / BREAKFAST

MADRIX 5

CONTROL // PIXEL MAPPING



Ultimate Flexibility

From the smallest projects to the biggest ones — get the best out of your LEDs. MADRIX 5 can produce a complete LED light show from a normal computer or laptop. Still, it can drive tens of thousands of LEDs without problems. This powerful software will not only allow you to control nearly any 2D LED display in every possible way, but real 3D LED applications as well. This makes it the ideal solution for your LED project.

Ultimate Control

MADRIX 5 is the ultimate control software for your LED lighting. All-new features such as timelines, the TRI effect category, audio playback for videos, the CSV fixture list import, a fresh user interface with two themes that is even easier to use, unprecedented performance and speed thanks to the powerful new 64-bit render engine, and many more allow you to produce amazing results right from the start. Cutting-edge technologies provide you with all the tools you need for modern LED control.



Ultimate Creativity

Bring your LED design to life with beautiful colors, stunning visuals, and spectacular effects. MADRIX 5 adapts to your needs. Use it as LED lighting controller, VJ software, 2D pixel mapper, 3D voxel mapper, media server, or media creator. This software is very easy to use with a VJ-like operation, 2 decks and a crossfader, plus 3 real-time previews to show your effects in advance.

Audio-Reactive Visuals

MADRIX 5 features a state-of-the-art audio analysis. It can process any live audio signal and create stunning real-time lighting visuals. These live effects will create a light show that runs in sync with your music. And thanks to the integrated effects generator, you can also create many lighting patterns without audio input. You can always customize everything, such as speed, color, shape, direction, size, movement, position, brightness, and much more.

The award-winning LED lighting controller for ultimate pixel mapping in 2D or 3D.

Technical Specifications

Made in Germany

User-Interface Languages	Deutsch (German) English Español (Spanish) Français (French) Bahasa Indonesia (Indonesian) Italiano (Italian)	日本語 (Japanese) 한국어 (Korean) Português brasileiro (Brazilian Portuguese) русский (Russian) Türkçe (Turkish) 简体中文 (Simplified Chinese)
Industry Standards For Output	DMX-Based Art-Net (I, II, 3, 4) (Unicast & Broadcast) DMX512 Color Kinetics KiNET (v1 / v2 / v3) Philips hue SPI (Via MADRIX NEBULA) Streaming ACN (sACN / E1.31) (Unicast & Multicast)	DVI-Based ColourSmart Link Colorlight A8 Colorlight 5A Colorlight T9 DVI (VGA, HDMI, and more) Eurolite T9
Industry Standards For Input, Interoperability, Remote Control, And Audio	Art-Net (I, II, 3, 4) ASIO Blackmagic Design (DeckLink, Intensity, and more) CAST Software BlackTrax CITP DMX512 GamePort MA-Net 1 / MA-Net 2 MADRIX I/O	MADRIX ORION (Analog Input) Media (Images, Pictures, Logos, Videos, Text, Live-Signal Capturing, Screen Capturing) MIDI NewTek NDI (Send & Receive) Remote HTTP (Web Server) Spout (Send & Receive) Streaming ACN (sACN / E1.31) Time Code (Art-Net / MIDI / SMPTE / System Time) WDM
Supported Operating Systems	Microsoft Windows 11 64 bit only	
License Requirements	MADRIX 5 licenses require a valid, metallic MADRIX KEY	
Demo Version	Download MADRIX 5 from www.madrix.com	

Even more options are available via converters or bridging tools for input as well as output.



LIVE DESIGN
PRODUCTS
2013-2014 OF THE YEAR

8th edition
PALM SOUND &
LIGHT AWARDS

MADRIX 5



Enjoy
state-of-the-art
features for unique 2D
and real 3D.

2D Pixel Mapping

The MADRIX 5 Software makes it possible to control numerous LED fixtures; also of different kinds. Position them according to your needs in nearly any form or shape. Map pixel by pixel and achieve pixel-perfect results, even with the lowest of pixel resolutions. The result are crisp and sharp visuals on your LEDs.



Combine 2D + 3D

Combine any 2D project with 3D elements in order to create even more spectacular attractions for your audience, customers, and clients. MADRIX 5 is a powerful tool that will help you realize the projects you want to build. Mapping LEDs is fast, creative, and fun. MADRIX 5 certainly takes your LED display to the next level.



3D Voxel Mapping In X + Y + Z

MADRIX 5 provides a leading-edge feature set to fully control real 3D LED matrices. MADRIX 5 supports volume rendering (voxel mapping). This approach is fundamentally different to the 3D projections or the physical layout of 2D surface areas that are widely known nowadays. It makes your installation state-of-the-art.

MADRIX 5

Different licenses are available for different needs and project sizes.

MADRIX 5 License	start	entry	basic	professional
DMX Channels	1,024	6,144	16,384	65,536
DMX Universes (Example)	(2)	(12)	(32)	(128)
RGB Voxels (Example)	(341)	(2,048)	(5,461)	(21,845)
DVI Pixels	16,384	262,144	1,048,576	2,097,152
Render Resolution (Example)	(128 x 128)	(512 x 512)	(1,024 x 1,024)	(2,048 x 1,024)
Upgradable	✓	✓	✓	✓
Validity	Lifetime	Lifetime	Lifetime	Lifetime

MADRIX 5 License	ultimate	maximum	preprogrammer
DMX Channels	262,144	1,048,576	
DMX Universes (Example)	(512)	(2,048)	MADRIX 5 preprogrammer is a special license available for project preparation.
RGB Voxels (Example)	(87,381)	(349,525)	It provides no output for MADRIX 5, but removes major limitations of the demo mode.
DVI Pixels	2,097,152	2,097,152	
Render Resolution (Example)	(2,048 x 1,024)	(2,048 x 1,024)	
Upgradable	✓	—	—
Validity	Lifetime	Lifetime	Lifetime

MADRIX 5 License Upgrades

You can easily upgrade the license on your MADRIX KEY to any higher license at any time in order to increase the available output. MADRIX 5 License Upgrades can simply be processed online. Please contact your dealer for more information.



RADAR

MONITORING // CONFIGURATION // RDM



Management. Manage all of your devices the remote way. Manage them the smart way.

Everywhere, lighting designs beautifully light up the world all around us. And clients expect them to do so without failure, each and every day. Behind the scenes, the lighting industry faces the complex aspects of modern technologies. Increasingly large projects become increasingly difficult to manage and maintain.



That is why today's DMX lighting fixtures are equipped with Remote Device Management. It is a two-way communication for receiving instructions as well as sending out feedback. When devices report back data, you gain access to a whole new level of available information, insights, and control. MADRIX RADAR is the complete toolbox to make the most of this data; automatically and efficiently.

Supervise all of your lighting fixtures in a single software. Handle large amounts of RDM devices. It is a new kind of application that opens up entirely new possibilities for you and your clients. MADRIX RADAR includes automatic fixture patching, fully automatic 24/7 device monitoring, automatic e-mail notifications, and much more.

Transform how you work with luminaires. Easily configure settings remotely. Let the software monitor devices automatically for you. Quickly see the results in graphical overviews at a single glance. That means that your setup and maintenance processes are much faster, much easier, and much more cost-efficient than ever before.

Build a database of past sensor data and see the progression of device parameters, such as temperature and operating hours. Exchange devices that are likely to fail soon, before they do. Make your maintenance costs much more predictable by planning them more effectively in advance.



Simply monitor parameters that are supported by RDM devices, such as temperature and supply of power. Overheating and overvoltage are among the most likely reasons that LED lighting fixtures mounted on media facades fail.

RADAR

Fully automatic 24/7 device monitoring.

Automatic e-mail notifications.

Unleash the full potential of RDM.

MADRIX
LIGHTING CONTROL

MADRIX RADAR

Overview. Visualize how it works.

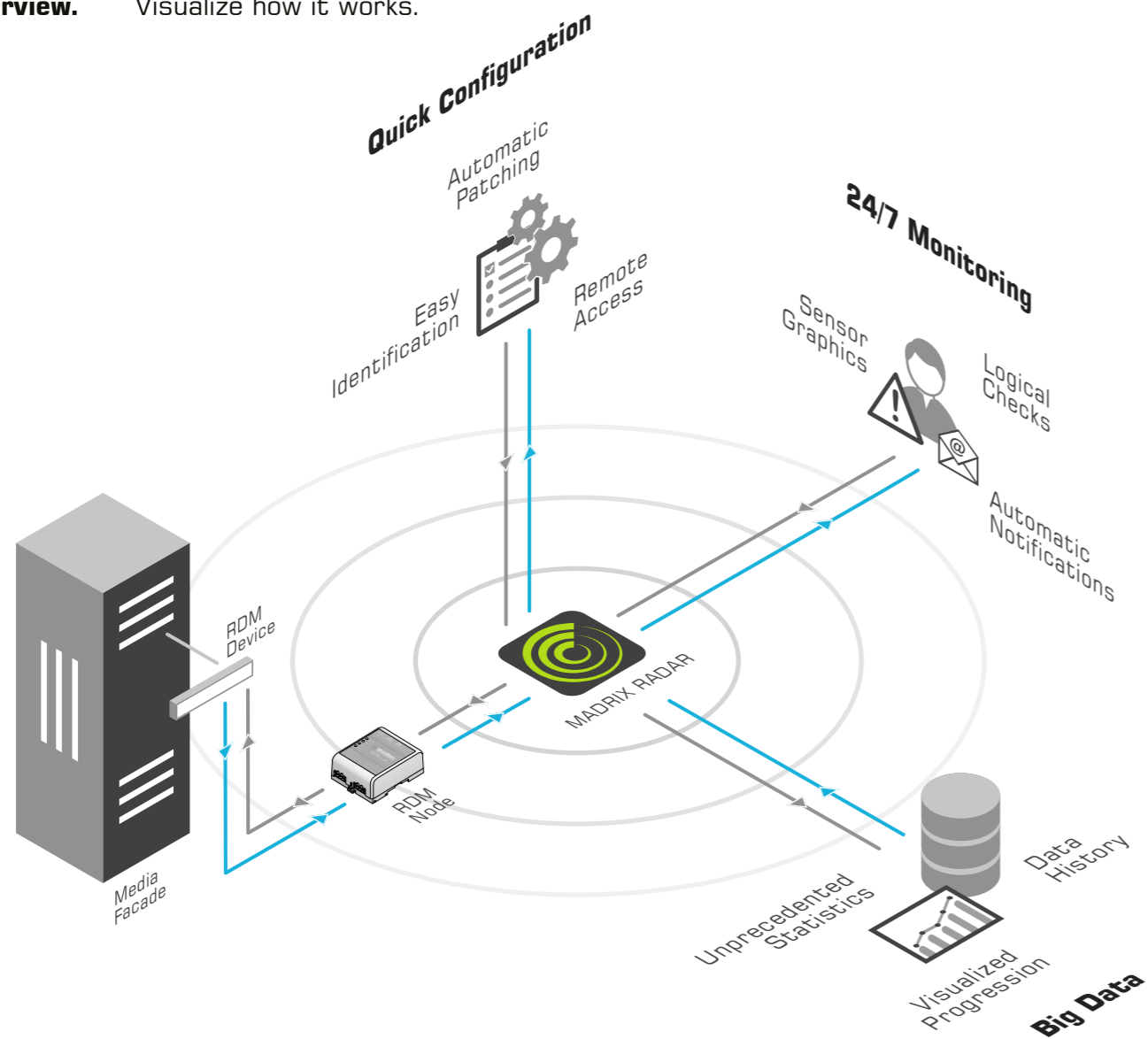

Provide unparalleled support for each installation.
Start offering all-new benefits to your clients.
Unleash the full potential of RDM.



MADRIX RADAR

Configuration. Meet your favorite new addressing tool.

Convenient Remote Access

Easily set up your RDM devices remotely. This means you can perform any configuration conveniently from your computer; instead of requiring direct access to the devices themselves in the truss, in the ceiling, or on the facade.

Simplified Fixture Addressing

Avoid the complicated procedure to manually set up all of a project's lighting fixtures by hand before they can be mounted. Freely modify their settings, such as the important DMX start address, after any installation has taken place.

Incredibly Fast Workflows

Drastically reduce the time-consuming process of configuring a large number of devices. Use the built-in search function and change settings of a single device or select several entries to quickly make multiple changes at once.

Incredibly Powerful Automation

Let the software automatically patch all fixtures in a single DMX universe or across the entire range of addresses. Simply use drag and drop to put them in the correct order. Setting up DMX addresses has never been faster.

Useful Fixture Discovery

Use the built-in highlight mode to let a fixture flash with full-on white for quick identification of fixtures in your installation. See if a device correctly responds to DMX commands or if the lighting fixtures are addressed correctly in a row.

Full Support

MADRIX RADAR supports all RDM parameters detailed in the official protocol specifications of ANSI E1.20 and ANSI E1.37-1 over Art-Net (including the ArtRdm package). All fixed parameters (PIDs for Set and Get) and manufacturer-specific parameters are included.



Monitoring. Fully automatic 24/7 device monitoring with automatic notifications.

Continuous Monitoring

Let the software monitor all of your devices 365 days a year, 7 days a week, 24 hours a day. It does so fully automatically without any required supervision. This simply wasn't possible before.

Making Sensor Data Understandable

MADRIX RADAR checks the status of devices, such as voltage, temperature, status, power cycle, life cycle, and more. Graphical overviews allow you to quickly see if a sensor value is within its specified limits or out of its valid range.

Event Reports

In addition to merely requesting and receiving information, the software will apply its own logical routines in order to create events for you. By probing and validating incoming data, MADRIX RADAR provides actionable reports for you.

Automatic Notifications

If MADRIX RADAR detects any irregularities, you can receive automatic status updates within the software, run a PowerShell script, or let the system conveniently send you e-mails. In short, you are always up to date.



MADRIX RADAR



The MADRIX System. Take advantage of high-quality software and high-quality hardware.

MADRIX RADAR is an independent software that allows you to choose compatible RDM nodes.

You gain the enormous advantage with MADRIX RDM nodes of running a fully integrated system.

Our MADRIX hardware processes RDM data packages in a way that does not result in interference with DMX data packages during full and live operation, which could lead to visual flickering or other signal interruptions. MADRIX interfaces manage these data streams highly efficiently and intelligently.

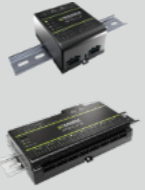
License Model. Integrate flexibly into your projects.

License Name	Free Software Licenses			Paid Software Licenses			
	demo	MADRIX RDM Nodes	fragment	core	fusion small	fusion medium	fusion large
RDM Nodes	Third Party	MADRIX (STELLA & STELLA 8)	Third Party	Third Party	Third Party	Third Party	Third Party
Unlocked RDM Devices & Sub-Devices	2	All Devices Connected To The Nodes	All	All	64	512	4,096
Parameters	✓	✓	✓	✓	✓	✓	✓
Snapshots	✓	✓		✓	✓	✓	✓
Sensors	✓	✓		✓	✓	✓	✓
Status Messages	✓	✓		✓	✓	✓	✓
Event Monitoring	✓	✓			✓	✓	✓
Option To Use big data License		Yes		Partially	Yes	Yes	Yes
License Provided By	Automatically Available		Digital License [Only Quick Switch-On Manually Required]	 MADRIX KEY Required			



MADRIX RADAR

Big Data. Access historical device data you never knew was obtainable.

Invaluable Data History

Leverage the valuable information that a device's data history can provide. See individual time series graphically over time. Access data records in order to see the progression, find trend lines, or spot probable issues.

Smart Data Management

Present comprehensive statistics to your clients based on the data that MADRIX RADAR is collecting. Replace failing devices and avoid replacing the ones that need no immediate replacement.

Convenient Features

You can freely enable or disable if data points are recorded, for example during setup and construction times, or change the time intervals at which data is recorded.

License Model. Unlock the above features optionally and benefit even more.

**MADRIX RADAR
big data
License**

Free For Purchasers Of
MADRIX RDM Nodes Or
MADRIX RADAR fusion Licenses



MADRIX KEY Required

Technical Specifications



User-Interface Languages	Deutsch (German) English Español (Spanish) Français (French) Bahasa Indonesia (Indonesian) Italiano (Italian) हिन्दी (Hindi)	日本語 (Japanese) 한국어 (Korean) Português brasileiro (Brazilian Portuguese) русский (Russian) Türkçe (Turkish) 简体中文 (Simplified Chinese)
Supported Operating Systems	Microsoft Windows 11 64 bit only	
Technical Standards	Art-Net (I, II, 3, 4, incl. ArtRdm), RDM (ANSI E1.20, ANSI E1.37-1)	
RDM Role	Sends commands and data requests to RDM Responders via ArtRdm (Manager)	
Supported Databases	SQLite In Main Memory, SQLite File, PostgreSQL Server (Via Local Computer Or Remote Server Connections)	
License Requirements	MADRIX RADAR licenses require a valid, metallic MADRIX KEY	
Demo Version	Download MADRIX RADAR from www.madrix.com	

MADRIX KEY

Your key to the world of MADRIX.



Flexible Usage

The MADRIX KEY is a USB dongle that unlocks the features or output for the MADRIX 5 Software or MADRIX RADAR Software by holding the corresponding license. You can freely switch between different PCs as it is not bound to a specific system. It only needs to be activated online once.

What's In The Box

The beautiful, high-quality box includes 1x empty MADRIX KEY, 1x USB flash drive incl. MADRIX 5 Software and MADRIX RADAR Software, 1x lanyard, and 1x quick start guide. All additional software tools and all user manuals are provided digitally.



MUNDORGB

TRAINING

Expand your knowledge.

MADRIX Training includes a variety of seminars to learn directly from the makers of MADRIX. Our courses effectively and quickly teach you how the system works.

See all details at www.madrix.com

In-House



MADRIX
Training

Choose between five different courses or attend all of them in one time block on three consecutive days. Each course is offered in English or German depending on the date and held in person at the MADRIX Headquarters in Dresden, Germany.

Online



MADRIX
Training

Choose between five different courses or attend all of them. Each course is offered in English or German depending on the date. All sessions are held online.

Tutorials

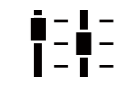

MADRIX

Level up your skills by diving into our extensive user manuals, online tutorials, and video tutorials freely available at help.madrix.com

- 1 **MADRIX 5 Software: Crash Course**
- 2 **MADRIX 5 Software: Patching, Mapping, And Group Control**
- 3 **MADRIX 5 Software: Creating Advanced Effects**

- 4 **MADRIX Hardware And Integration**
- 5 **MADRIX RADAR And RDM**



INTEGRATION

MADRIX interfaces seamlessly integrate with any MADRIX Software to form a fully integrated system.

High Performance

Dynamic and smooth visuals require high frame rates, which MADRIX products deliver constantly and reliably.

Unmatched Reliability

MADRIX hardware products have incredibly low failure rates and return rates.

Easy Scalability

Simply connect several devices to increase the available output.

Custom Development

Our in-house development team uses specialized components and develops fully customized firmware.

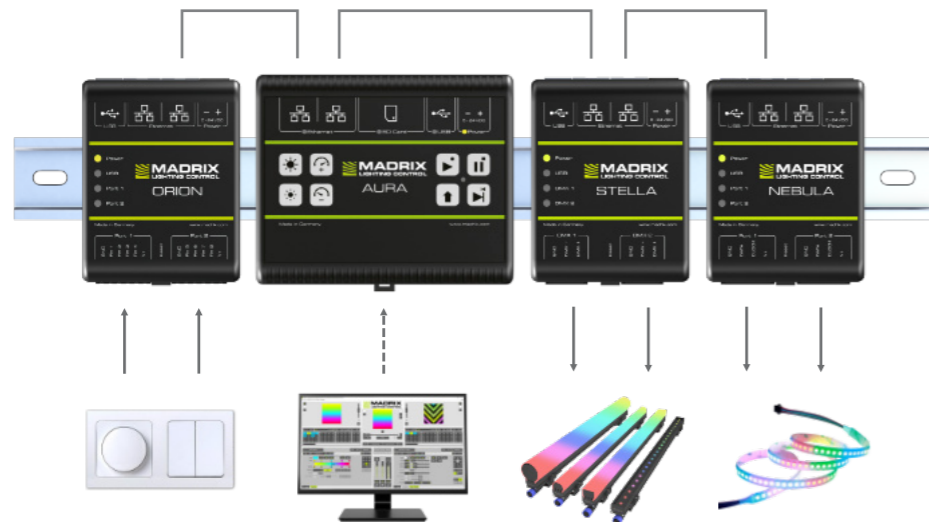

MADRIX RADAR — Example

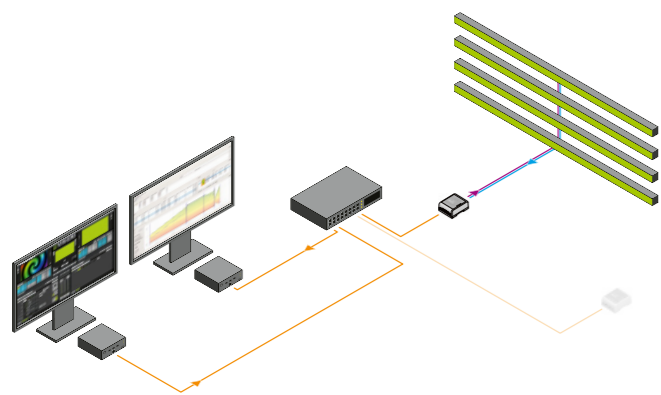

MADRIX AURA — Example

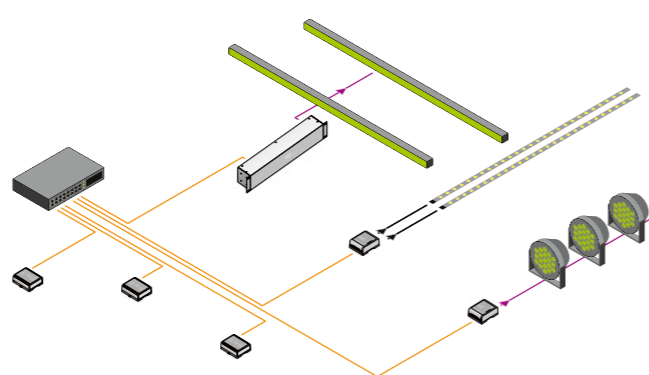

MADRIX STELLA — Example

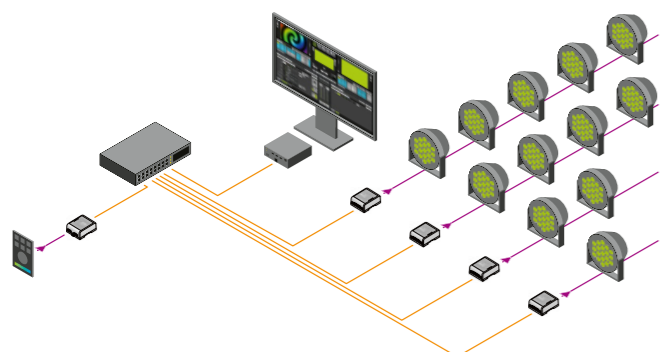

MADRIX ORION — Example

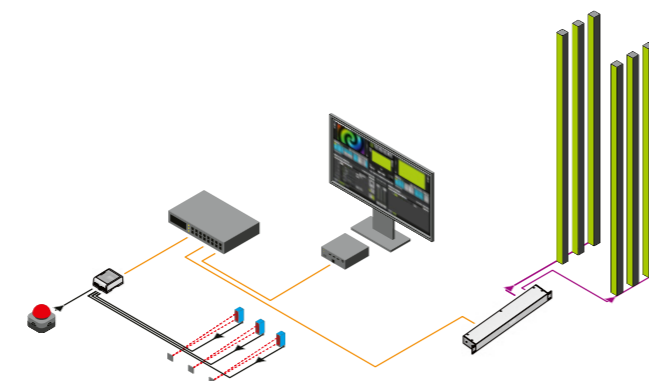

MANAGER

CONFIGURATION // MADRIX HARDWARE

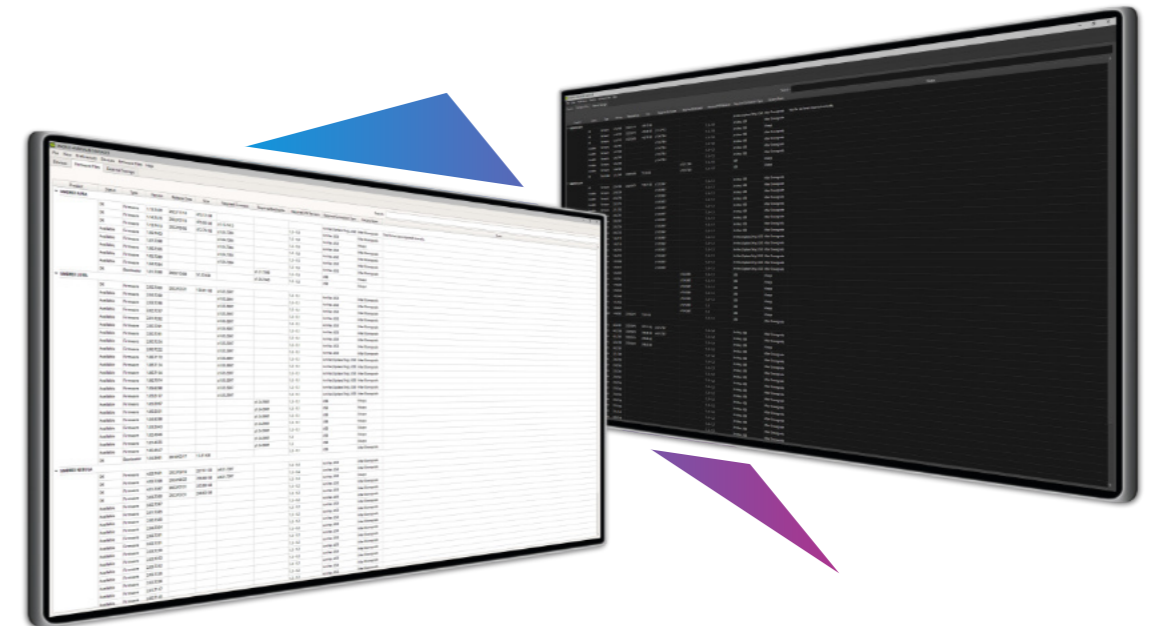

MADRIX HARDWARE MANAGER — The software companion to your MADRIX hardware.

Device Configuration

Easily configure basic device settings, such as the IP address, or perform a reset to factory default settings. Or quickly call up the web configuration of your connected devices.

Documentation

The latest PDF documentation files are also automatically downloaded and made available for you.

Firmware Updates

Quickly update your devices to any firmware version that is available in just a few mouse clicks over USB or Ethernet. New firmware updates are automatically downloaded from our web server.

File Upload

Simply upload or delete scene files on the SD card of your MADRIX AURA stand-alone devices. You only need access to the device itself over USB or Ethernet.



Technical Specifications

User-Interface Languages	English
Supported Operating Systems	Microsoft Windows 11 64 bit only
Available Connection Types	USB, Ethernet
Supported Devices	MADRIX AURA 2, MADRIX AURA 8, MADRIX AURA 12, MADRIX AURA 32, MADRIX LUNA 4, MADRIX LUNA 8, MADRIX LUNA 16, MADRIX NEBULA, MADRIX ORION, MADRIX STELLA, MADRIX STELLA 8
Full Version	Download for free from www.madrix.com

Made in Germany

AURA

CONTROL // STAND-ALONE



3 versions are available:
AURA 2 | AURA 12 | AURA 32

The advanced lighting-control recorder and stand-alone playback unit.

Stand-Alone Playback

Independently run the most sophisticated light shows from this energy-efficient playback unit via Art-Net or Streaming ACN. Easily control up to 2, 12, or 32 universes per device.



Central Hub

Simply connect compatible MADRIX hardware interfaces or third-party nodes to provide the correct output for your lighting fixtures.

Master-Slave Synchronization & Scalability

Manage large projects simply by connecting several units. The entire group is automatically synchronized across all DMX universes for flawless and uninterrupted playback.

Live Control

Encased in a non-conductive design for DIN rails or wall mounting, 8 on-device buttons allow for quick playback and recording control. You can also directly adjust the overall speed and intensity.

Live Recording

Record any Art-Net or Streaming ACN network stream onto the inserted memory card. Unlike any other solution, recording a beautiful light show with MADRIX 5 is as easy as pressing record and play.

Time-Controlled Shows

Run scenes automatically with the help of the internal clock as well as the available sunrise and sunset timers.

Web Configuration

Use the built-in web configuration page to access and change specific device settings, such as the important IP address, universes, playlist settings, and much more.

Remote Control

Trigger MADRIX AURA via user-definable HTTP commands and the built-in web server or use Art-Net/sACN. You can even add MADRIX ORION for interactive installations.

MADRIX AURA is the central stand-alone controller for simple recording and large-scale pixel mapping. It redefines what is possible in a compact unit with exceptional performance.

Technical Specifications

Made in Germany

Supply Of Power	DC 5 V – 24 V; over A) 2-pin, pluggable screw terminal or B) 5 V USB
Power Consumption	2.5 W (500 mA) during normal operation (500 mA max. fused)
BTU/h	8.53 during normal operation
Network Protocols	Art-Net (I, II, 3, 4, incl. ArtSync), Streaming ACN (sACN / ANSI E1.31)
RDM Role	Acts on commands and replies to requests with its own status and sensor data via ArtRdm (RDM Responder)
Output	2x / 12x / 32x 512 DMX channels output over Ethernet network
Recording Input	2x / 12x / 32x 512 DMX channels input over Ethernet network
Remote-Control Input	8x 512 DMX channels received over Ethernet network, or Remote HTTP
SD-Card Slot	Supports SD, SDHC, and SDXC cards (Tested up to 64 GB)
Ethernet	2x RJ45, Auto MDI-X, daisy-chain support, 10/100/1000 MBit/s
Ethernet Switch	Lookup Table (ALU) for 4,096 unicast MAC addresses
USB	1x port, USB 2.0, type-B female socket
Handling	8 control buttons, 6 status LEDs (+ 4 network status LEDs)
Case	Non-conductive, V-0 flammability rating (UL94 test method), designed for 35 mm DIN-rails or wall mounting
Dimensions	86 mm × 105 mm × 49 mm (3.39" × 4.13" × 1.93") (Length × Width × Height)
Weight	148 g (0.33 lb) 154 g (0.34 lb) incl. screw terminal, SD card, and wall mounts
Temperature Range	-10 °C to 70 °C (14 °F to 158 °F) (Operating) -20 °C to 85 °C (-4 °F to 185 °F) (Storage)
Relative Humidity	5 % to 80 %, non-condensing (Operating / Storage)
IP Rating	IP20
Certificates	CE, EAC, FCC, RoHS
Warranty	5 years of limited manufacturer's warranty
0.22 %	Average Hardware Failure And Return Rate (Last Update: August 2025)

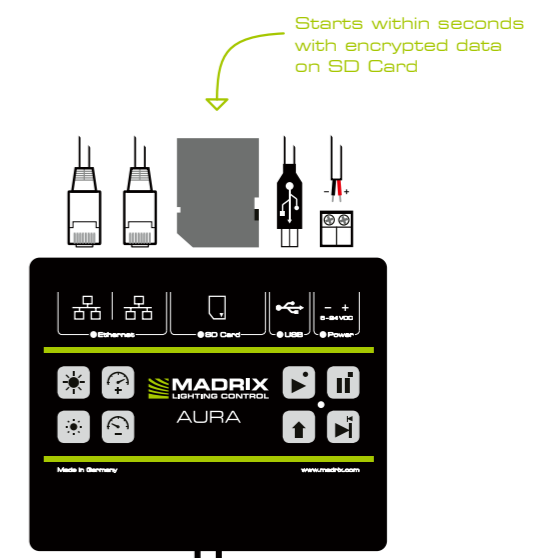

LUNA

CONTROL // OUTPUT // INPUT



3 versions are available:
LUNA 4 | LUNA 8 | LUNA 16

The easy-to-use and reliable network node.

Art-Net / Streaming ACN / USB

Art-Net or Streaming ACN data is directly converted to DMX512. Optimize and decentralize cabling to cover any distance to the device using Ethernet network.

Any small or large project greatly benefits from dependable data distribution and efficient operation. Use any compatible software or hardware controller. In addition, simply connect to MADRIX 5 over USB.

Easy Configuration

MADRIX LUNA offers powerful features, especially in combination with MADRIX 5. Take full advantage of pixel mapping and voxel mapping. The installation of the device is still quick and easy.

Quality Design

Devices are built 19" x 1U or 19" x 2U. They feature a fanless, noiseless, low-energy design, a durable metal case, and NEUTRIK plugs. 2 pre-mounted brackets make rack mounting possible. 5 indicators quickly show the status of a device.

4/8/16 DMX-OUT + 1 DMX-IN

4, 8, or 16 XLR ports (5-pin, female) distribute the equal number of DMX universes per unit. 1 XLR port (5-pin, male) can be used for DMX input. Simply use several units at the same time for larger projects.

Sync Mode

MADRIX 5 and MADRIX hardware allow you to fully synchronize Art-Net data for all output ports and even across multiple devices to get an optimal image on the LEDs without visual interruptions.

3rd-Party Controllers

MADRIX LUNA complies with the official protocol specifications and can be used as a regular node with your other consoles, controllers, or software solutions.

Invaluable Features

The device is ready within seconds after startup. HTP merging is automatically available for two Ethernet sources. Its firmware can be updated for future enhancements. Access and change specific device settings using the built-in web configuration page.

MADRIX LUNA reliably distributes DMX512 data over long or short distances. Its sync mode makes sure that lighting effects look their best on the LEDs.

Technical Specifications



Power Supply	AC 100 V – 240 V, 50-60 Hz, 0.4 A max., IEC C14 inlet
Power Consumption	< 5 W during normal operation
BTU/h	5.50 (LUNA 4) 8.80 (LUNA 8) 10.20 (LUNA 16) during normal operation
Network Protocols	Art-Net (I, II, 3, 4, incl. ArtSync), Streaming ACN (sACN / ANSI E1.31)
DMX512 (OUT)	4x / 8x / 16x 512 DMX channels output
DMX512 (IN)	1x 512 DMX channels input
Ports (OUT)	5-pin, XLR, female, NEUTRIK
Port (IN)	5-pin, XLR, male, NEUTRIK
Ethernet	1x RJ45, Auto MDI-X, NEUTRIK etherCON, 10/100 MBit/s (Compatible with 1 GBit/s)
USB	1x port, USB 2.0, type-B female socket
Handling	6 status LEDs
Case	Metal enclosure (With attached brackets for 19" rack mounting)
Size	19" x 1U (LUNA 4 / LUNA 8) 19" x 2U (LUNA 16)
Dimensions (Body Only)	76 mm x 440 mm x 44 mm (3" x 17.32" x 1.75") (Length x Width x Height)
Dimensions (Total)	76 mm x 482.6 mm x 44 mm (3" x 19" x 1.75") (Length x Width x Height)
Dimensions (LUNA 16 Total)	76 mm x 482.6 mm x 88 mm (3" x 19" x 3.5") (Length x Width x Height)
Weight	1.3 kg (2.87 lb) (LUNA 4) 1.4 kg (3.09 lb) (LUNA 8) 2.0 kg (4.41 lb) (LUNA 16)
Temperature Range	-10 °C to 60 °C (14 °F to 140 °F) (Operating) -20 °C to 70 °C (-4 °F to 158 °F) (Storage)
Relative Humidity	20 % to 80 %, non-condensing (Operating / Storage)
IP Rating	IP20
Certificates	CE, EAC, FCC, RoHS
Warranty	5 years of limited manufacturer's warranty
0.15 %	Average Hardware Failure And Return Rate (Last Update: August 2025)

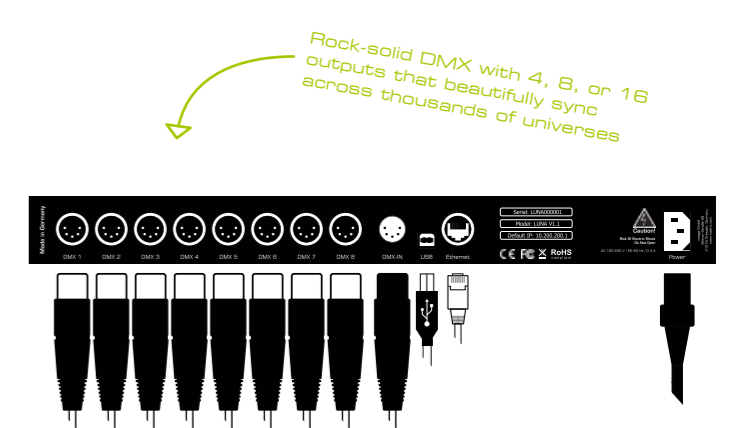
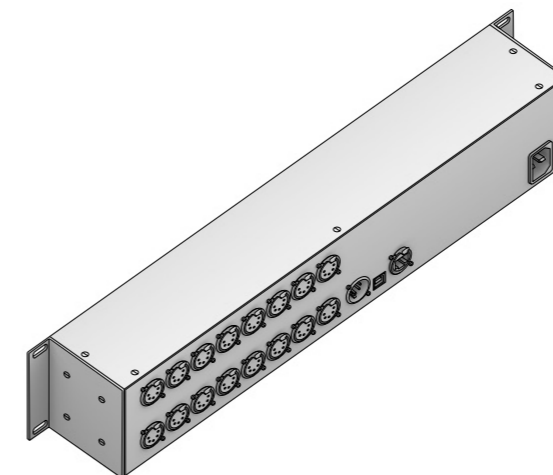

STELLA 8

CONTROL // OUTPUT // INPUT

NEW



MADRIX STELLA 8 combines incredible features for DMX512 and RDM into a single DIN-rail controller that easily copes with high bandwidths in data-intensive lighting-control networks.

Technical Specifications

Made in Germany

Supply Of Power	A) DC 5 V – 24 V over 2-pin, pluggable screw terminal incl. power daisy-chain (1x IN, 1x THRU), B) 5 V USB (2x USB-C), C) PoE (PoE 802.3af-2003) (1x Ethernet Right); Power backups are possible
Power Consumption	≤ 5 W (1,000 mA) during normal operation (1.6 A max. fused)
BTU/h	~17 during normal operation
Network Protocols	Art-Net (I, II, 3, 4, incl. ArtSync), Streaming ACN (sACN / ANSI E1.31)
Other Protocols	RDM (DMX512 Remote Device Management & Art-Net ArtRdm), syslog
RDM Role	A) Transmits commands and requests to RDM Responders and back (Art-Net Node / RDM Controller), B) Acts on commands and replies to requests with its own status and sensor data via ArtRdm (RDM Responder)
RDM Responder Count	170 RDM Responders max. can be discovered per port
DMX512	8x 512 DMX channels, input or output selectable per port
Ports	8x ports (Via 8x 3-pin, pluggable screw terminals)
Ethernet	2x RJ45, Auto MDI-X, daisy-chain support, 1000/100/10 MBit/s (= 1 GBit/s max.), Network over USB (Virtual Link)
Ethernet Switch	Lookup Table (ALU) for 4,096 unicast MAC addresses
USB	2x ports, USB 1.1, USB 2.0, type-C female socket
Handling	12 status LEDs (+ 4 network status LEDs)
Case	Non-conductive, V-0 flammability rating (UL94 test method), designed for 35 mm DIN-rails or wall mounting
Dimensions	86 mm x 156.3 mm x 31.79 mm (3.39" x 6.15" x 1.25") (Length x Width x Height)
Weight	206 g (0.45 lb) 260 g (0.57 lb) incl. screw terminals and wall mounts
Temperature Range	-10 °C to 70 °C (14 °F to 158 °F) (Operating) -20 °C to 85 °C (-4 °F to 185 °F) (Storage)
Relative Humidity	5 % to 80 %, non-condensing (Operating / Storage)
IP Rating	IP20
Certificates	CE, FCC, UL
Warranty	5 years of limited manufacturer's warranty

The 8-port flagship controller with RDM support for ultimate control over DMX.

High-Quality Ethernet Node – eDMX

MADRIX STELLA 8 provides extremely useful features and high performance for complete lighting control.

8 DMX-OUT – Art-Net To DMX / sACN To DMX

Assign control data to the 8 physical ports for DMX output over 3-pin screw terminals. The device supports:

- Art-Net (Unicast, Broadcast, Or Both) (Incl. ArtSync)
- Streaming ACN (sACN) (Unicast Or Multicast)

8 DMX-IN – DMX To Art-Net / DMX To sACN

Receive control data as DMX-IN and send it back out as eDMX (Art-Net, sACN, or both). Each of the 8 ports can automatically or manually be set to receive input.

Customizable Booster / Merger / Splitter

Easily refresh, combine, or duplicate incoming signals.

Ultimate Real-Time Merging

Combine data streams, directly processed with 0 delay, to create a single output signal via a highly adaptable system with automatic or manual HTP/LTP merging from up to 8 sources.

1 GBit/s Network & PoE – Power Over Ethernet

Simply deliver power to the device over Ethernet. On top, the device supports fast 1 GBit/s speeds.

Professional Tools

Take advantage of the following innovations, and more:

- **Modern Web GUI** (Multi-Lingual & Mobile-Friendly Device Configuration)
- **Password Protection** (Web Panel Access Control)
- **Network Settings** (Incl. IP Address, ARP, IGMP, NetBIOS, etc.)
- **Control Adjustments** (Color-Channel Order, Intensity Limits, etc.)
- **Channel-Block Shifting** (Channel Mapping Per Source Or Per Port)
- **Patterns** (Use Built-In Scenes For Quick Tests Or As Backup)
- **Snapshots** (Create 1-Frame Recordings On Device As Source Or Backup)
- **Source Priority System** (For Art-Net, sACN, Patterns, Snapshots)
- **Backup Strategies** (Lost Connection / Rank Sources Based On Priority)
- **Port Watcher** (Live Monitoring Of Data Rates For DMX/RDM/Network)
- **DMX Watcher** (Live Monitoring Per Channel Of Input Data Or Output Data)
- **Device Watcher** (List Of Connected Art-Net Devices In The Same Network)
- **Presets** (Common Configurations To Quickly Get Started)
- **Advanced Mode** (Up To 32x Input Sources & 32x Output Destinations)
- **Protocol Converter** (Art-Net to sACN Or sACN to Art-Net)
- **RDM** (Support As Controller & As Responder Incl. Own Sensor Data And Status)
- **Packet Multitasking** (Send DMX & RDM At The Same Time)
- **MADRIX RADAR Validation** (Unlocks RDM Devices In The Software)
- **syslog** (Support For Logging On A Remote Server)
- **Network Over USB** (For Setup & Data, Incl. Fixed IP Address As Backup)
- **Surge Protection** (Galvanic Isolation & High-Speed Current Limiters)
- **Firmware Updates & Advanced Bootloader** (Future Proofing)

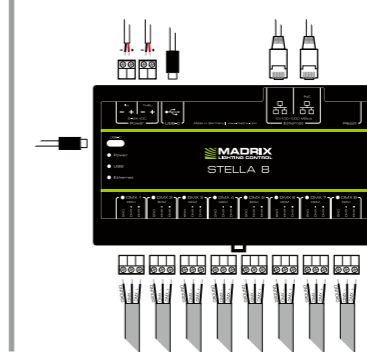
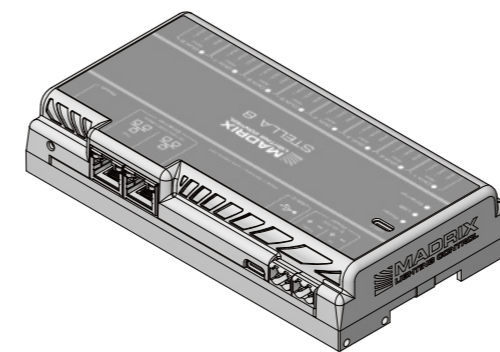

User-Interface Languages:

Deutsch (German), English, Español (Spanish), Français (French), Bahasa Indonesia (Indonesian), Italiano (Italian), हिन्दी (Hindi), 日本語 (Japanese), (Korean), Português brasileiro (Brazilian Portuguese), русский (Russian), Türkçe (Turkish), (Simplified Chinese)

Seamless Integration Of Art-Net & RDM

RDM is fully supported over Art-Net, including ArtRdm, all other required packets, and full and continued discovery of RDM devices.

Use MADRIX STELLA 8 and MADRIX RADAR together for additional benefits:

- 1) All RDM devices/sub-devices connected to STELLA 8 are automatically unlocked in the RADAR Software for free.
- 2) With RADAR, the complete RDM specifications of ANSI E1.20 and ANSI E1.37-1 are available to you over Art-Net.
- 3) Thanks to STELLA 8's Packet Multitasking, RDM and Art-Net can be sent and received at the same time and during live operation.

STELLA

CONTROL // OUTPUT // INPUT



The 2-port network node with RDM support for solid-state projects.

Art-Net / Streaming ACN / USB

Art-Net or Streaming ACN data is directly converted to DMX512. Optimize and decentralize cabling to cover any distance to the device using Ethernet network. In addition, simply connect to MADRIX 5 over USB.

Easy Configuration

MADRIX STELLA offers powerful features. Managing the device is still quick and easy. Supply power over USB or 5 V to 24 V over a 2-pin screw terminal.

3rd-Party Controllers

MADRIX STELLA complies with official protocol specifications and can be used as a regular node with your other consoles, controllers, or software solutions.

Designed For DIN Rails Or Walls

Its non-conductive enclosure and standardized design for 35 mm top-hat rails make mounting quick, easy, and safe. 2 extra brackets are provided for optional wall mounting. 9 indicators quickly show the device status with the option to turn them off.

2 DMX-IN/OUT

Directly connect DMX512 to the two 3-pin screw terminals to distribute 2 DMX universes per unit as input and/or output, eliminating the need for XLR connectors as a result. Simply use several units at the same time for larger projects.

Sync Mode

MADRIX 5 and MADRIX hardware allow you to fully synchronize Art-Net data for all output ports and across multiple devices to get an optimal image on the LEDs without visual interruptions.

RDM & Daisy-Chain Support

2 Ethernet ports allow for separate network connections as well as linearly daisy-chaining several devices together. On top, the device supports the Remote Device Management standard.

Invaluable Features

The device is ready within seconds after startup. HTP merging is automatically available for two Ethernet sources. Its firmware can be updated for future enhancements. Access and change specific device settings using the built-in web configuration page.

MADRIX STELLA is a dedicated control interface for DMX512 and Art-Net/Streaming ACN. It is designed for high quality and practicability in permanent LED installations.

Technical Specifications

Made in Germany

Supply Of Power	DC 5 V – 24 V; over A) 2-pin, pluggable screw terminal or B) 5 V USB
Power Consumption	< 1.5 W (300 mA) during normal operation (500 mA max. fused)
BTU/h	6.55 during normal operation
Network Protocols	Art-Net (I, II, 3, 4, incl. ArtSync), Streaming ACN (sACN / ANSI E1.31)
RDM Role	Transmits commands and requests to RDM Responders and back (Art-Net Node / RDM Controller)
RDM Responder Count	170 RDM Responders max. can be discovered per port
DMX512	2x 512 DMX channels, input and/or output (Automatically set per port)
Ports	2x ports (Via 2x 3-pin, pluggable screw terminals)
Ethernet	2x RJ45, Auto MDI-X, daisy-chain support, 10/100 MBit/s (Compatible with 1 GBit/s)
Ethernet Switch	Lookup Table (ALU) for 1,024 unicast MAC addresses
USB	1x port, USB 2.0, type-B female socket
Handling	5 status LEDs (+ 4 network status LEDs)
Case	Non-conductive, V-0 flammability rating (UL94 test method), designed for 35 mm DIN-rails or wall mounting
Dimensions	90 mm × 70 mm × 46 mm (3.54" × 2.76" × 1.81") (Length × Width × Height)
Weight	108 g (0.24 lb) 125 g (0.28 lb) incl. screw terminals and wall mounts
Temperature Range	-10 °C to 70 °C (14 °F to 158 °F) (Operating) -20 °C to 85 °C (-4 °F to 185 °F) (Storage)
Relative Humidity	5 % to 80 %, non-condensing (Operating / Storage)
IP Rating	IP20
Certificates	CE, EAC, FCC, RoHS
Warranty	5 years of limited manufacturer's warranty
0.07 %	Average Hardware Failure And Return Rate (Last Update: August 2025)

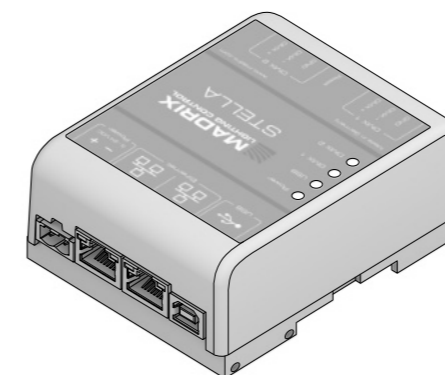

Seamless Integration Of Art-Net & RDM

RDM is fully supported over Art-Net, including ArtRdm, all other required packets, and full and continued discovery of RDM devices. Use MADRIX STELLA and MADRIX RADAR together for additional benefits:

- 1) All RDM devices/sub-devices connected to STELLA are automatically unlocked in the RADAR Software for free.
- 2) With RADAR, the complete RDM specifications of ANSI E1.20 and ANSI E1.37-1 are available to you over Art-Net.
- 3) Thanks to STELLA's Packet Multitasking, RDM and Art-Net can be sent and received at the same time and during live operation.



NEBULA

CONTROL // OUTPUT



MADRIX NEBULA directly connects to your LED pixels. This advanced SPI decoder receives control data over Ethernet network or USB. It is built to provide excellent image quality.

Made in Germany

Technical Specifications

Supply Of Power	DC 5 V – 24 V; over A) 2-pin, pluggable screw terminal (12 A max.), B) 5 V USB, C) Port 1 or 2 sourced from LEDs; 6 A max. load per port when supplying through to LEDs						
Power Consumption	< 1.5 W (300 mA) during normal operation (500 mA max. fused)						
BTU/h	5.73 during normal operation						
Network Protocols	Art-Net (I, II, 3, 4, incl. ArtSync), Streaming ACN (sACN / ANSI E1.31)						
RDM Role	Acts on commands and replies to requests with its own status and sensor data via ArtRdm (RDM Responder)						
Data Output	12x 512 channels SPI TTL (Maximum output per port: 1,020 RGB LEDs / 768 RGBW LEDs / 3,072 1-channel LEDs)						
Supported LEDs	APA101, APA102, APA104, APA106, FW1935, GS8206, GS8207, GS8208, GW6201, GW6205, LB1908,	LPD1882S, LPD6803, LPD8806, MBI6023, MBI6024, MBI6120, MY9291, P9883, SJ1221, SK6112, SK6805,	SK6812, SK6813, SK6822, SK9816, SK9822, SK9826, SM16703, SM16704, SM16716, TLC5973, TLS3001,	TLS3008, TM1803, TM1804, TM1809, TM1812, TM1814, TM1829, SM16704, UCS512B3, UCS1903, UCS2603,	UCS2903, UCS2904, UCS2904B, UCS5603, UCS5603A, UCS7604, UCS8903, UCS8904, UCS9812S, VS17822, WS2801,	WS2803, WS2811, WS2811F, WS2811M, WS2811S, WS2812, WS2812B, WS2812C, WS2813, WS2814, WS2814F,	WS2815, WS2818, WS2818M, WS2821, WS2821, Addressing, WS2822S, WS2822S, Addressing, WS2813, WS2814,
As of December 2024. See www.madrix.com for the latest information.	Multiple frequencies are often available per type.						
Ports	2x ports (Via 2x 4-pin, pluggable screw terminals)						
Ethernet	2x RJ45, Auto MDI-X, daisy-chain support, 10/100 MBit/s (Compatible with 1 GBit/s)						
Ethernet Switch	Lookup Table (ALU) for 1,024 unicast MAC addresses						
USB	1x port, USB 2.0, type-B female socket						
Handling	5 status LEDs (+ 4 network status LEDs)						
Case	Non-conductive, V-0 flammability rating (UL94 test method), designed for 35 mm DIN-rails or wall mounting						
Dimensions	90 mm × 70 mm × 46 mm (3.54" × 2.76" × 1.81") (Length × Width × Height)						
Weight	110 g (0.24 lb) 132 g (0.29 lb) incl. screw terminals and wall mounts						
Temperature Range	-10 °C to 70 °C (14 °F to 158 °F) (Operating) -20 °C to 85 °C (-4 °F to 185 °F) (Storage)						
Relative Humidity	5 % to 80 %, non-condensing (Operating / Storage)						
IP Rating	IP20						
Certificates	CE, EAC, FCC, RoHS						
Warranty	5 years of limited manufacturer's warranty						
0.09 %	Average Hardware Failure And Return Rate (Last Update: August 2025)						

The versatile LED pixel-tape driver to directly control a wide range of digital LEDs.

SPI Converter & Direct Connection

Directly connect to a wide range of supported LEDs via two 4-pin screw terminals. A signal frequency of up to 24 MHz is available. Supply power over USB or 5 V to 24 V over a 2-pin screw terminal.

Art-Net / Streaming ACN / USB

Network data is directly converted to SPI without the need for an additional interface. Reliably distribute data from any compatible software or hardware controller. In addition, simply connect to MADRIX 5 over USB.

Designed For DIN Rails Or Walls

Its non-conductive enclosure and standardized design for 35 mm top-hat rails make mounting quick, easy, and safe. 2 extra brackets are provided for optional wall mounting. 9 indicators quickly show the device status with the option to turn them off.

Quality Output Of 12 Universes

Each device drives up to 2,040 RGB pixels while ensuring responsive delivery of high-quality signals to each individual LED. You can choose the output protocol separately for each of the two ports.

Sync Mode & Daisy-Chain Support

MADRIX 5 and MADRIX hardware allow you to fully synchronize Art-Net data for all ports and across devices to get an optimal image on the LEDs without visual interruptions. 2 Ethernet ports allow linearly daisy-chaining several devices together.

Invaluable Features

The device is ready within seconds after startup. HTP merging is automatically available for two Ethernet sources. Its firmware can be updated for future enhancements. Access and change specific device settings using the built-in web configuration page.

Over **70** Supported SPI Protocols

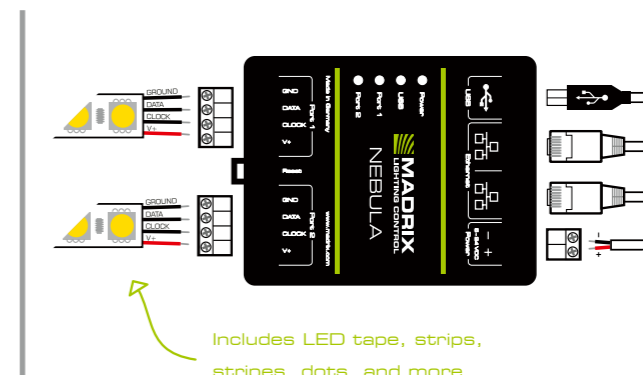
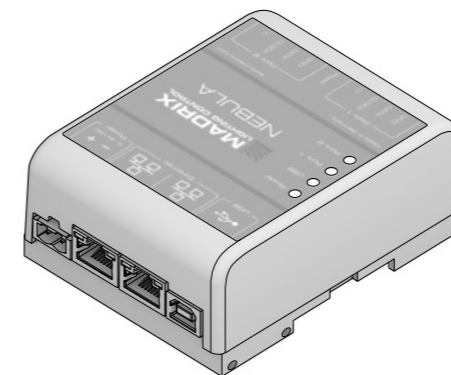

ORION

CONTROL // INPUT



Made in Germany

MADRIX ORION is specifically designed as a general-purpose input device. It is used for analog input and Ethernet-based output for remote control and interactivity.

Technical Specifications

Supply Of Power	DC 5 V – 24 V; over A) 2-pin, pluggable screw terminal with 500 mA max. load per port when supplying through to the ports, B) 5 V USB, C) Port 1 or Port 2
Power Consumption	< 1.5 W (300 mA) during normal operation (500 mA max. fused)
BTU/h	5.73 during normal operation
Network Protocols	Art-Net (I, II, 3, 4), Streaming ACN (sACN / ANSI E1.31)
RDM Role	Acts on commands and replies to requests with its own status and sensor data via ArtRdm (RDM Responder)
Input Signals	Analog 0 V – 12 V (Measurable) / Analog 0 V – 24 V (Permissible)
Ports	2x ports (Via 2x 6-pin pluggable screw terminals)
Input Pins	2x 4 separate pins (8x in total with 72 kΩ input resistance each)
Ethernet	2x RJ45, Auto MDI-X, daisy-chain support, 10/100 MBit/s (Compatible with 1 GBit/s)
Ethernet Switch	Lookup Table (ALU) for 1,024 unicast MAC addresses
USB	1x port, USB 2.0, type-B female socket
Handling	5 status LEDs (+ 4 network status LEDs)
Case	Non-conductive, V-0 flammability rating (UL94 test method), designed for 35 mm DIN-rails or wall mounting
Dimensions	90 mm × 70 mm × 46 mm (3.54" × 2.76" × 1.81") (Length × Width × Height)
Weight	105 g (0.23 lb) 120 g (0.27 lb) incl. screw terminals and wall mounts
Temperature Range	-10 °C to 70 °C (14 °F to 158 °F) (Operating) -20 °C to 85 °C (-4 °F to 185 °F) (Storage)
Relative Humidity	5 % to 80 %, non-condensing (Operating / Storage)
IP Rating	IP20
Certificates	CE, EAC, FCC, RoHS
Warranty	5 years of limited manufacturer's warranty
0.00 %	Average Hardware Failure And Return Rate (Last Update: August 2025)

Adds a whole new level of interaction and control to your project.

Powerful A/D Converter

Easily convert any analog input signal ranging from 0 V – 12 V into an 8-bit or 16-bit digital DMX output signal. Sample incoming signals instantly and map all inputs individually to up to 8 or 16 DMX channels per device.

8 Versatile Inputs

Directly connect to a wide range of compatible sensors, potentiometers, switches, and triggers. Easily create interactive projects using sensors for light, temperature, PIR, and many more.

Direct Connection

2 main 6-pin ports are available with 4 individual pins each as well as GND and V+. Flexibly supply 5 V – 24 V power over the 2-pin screw terminal.

Designed For DIN Rails Or Walls

Its non-conductive enclosure and standardized design for 35 mm top-hat rails make mounting quick, easy, and safe. 2 extra brackets are provided for optional wall mounting. 9 indicators quickly show the device status with the option to turn them off.

Art-Net / Streaming ACN / USB

Send the output signal as Art-Net or Streaming ACN (E1.31) over long or short distances to any compatible software or hardware controller. In addition, simply connect to MADRIX 5 over USB.

Versatile Output

Different input types allow data to be processed and parameterized differently for the output. Each input can be separately set as Analog-IN, Digital-IN, Counter, and other useful functions.

Daisy-Chain Support

2 Ethernet ports allow for separate network connections as well as linearly daisy-chaining several devices together for better cable management.

Invaluable Features

The device is ready within seconds after startup. Its firmware can be updated for future enhancements. Access and change specific device settings using the built-in web configuration page.

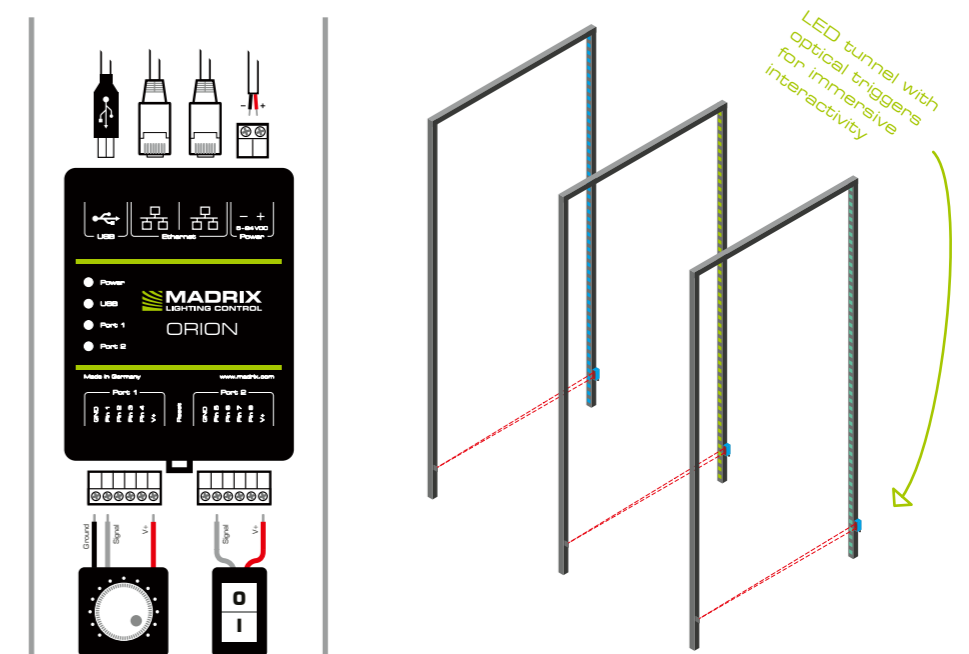

USB ONE

CONTROL // INPUT // OUTPUT



One of the smallest USB interfaces for DMX output or DMX input.

DMX-IN/OUT With 5-Pin NEUTRIK XLR Port

This device allows you to send or receive DMX data over 512 DMX channels using MADRIX 5. A male-to-male, 3-pin or 5-pin XLR Gender Changer is required for DMX-IN.

Hot Swapping & Plug and Play

Devices can be connected to and disconnected from the computer during use and without a reboot.

USB 2.0 Standard

The USB 2.0 standard is fully supported to allow for a higher maximum speed of 480 MBit/s.

Power Over USB

The interface is powered directly via the USB port and does not need an additional power supply.

Remote Control

MADRIX 5 can be controlled remotely using the implemented DMX-IN functions.

Frame Rate Stability

Up to 60 devices can be connected to a USB host controller without having any frame rate problems. (60 DMX512 interfaces amount to 30,720 DMX channels.)

Technical Specifications

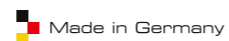

Supply Of Power	DC 5 V, 500 mA, Power over USB
Power Consumption	~ 55 mA during normal operation
BTU/h	1.00 during normal operation
DMX512	512 DMX channels, input or output
Plug	5-pin, XLR, female, NEUTRIK
USB	1x port, USB 2.0, type-A male plug, Plug and Play, 2 m cable
Weight	105 g (0.23 lb)
Temperature Range	10 °C to 50 °C (50 °F to 122 °F) (Operating) -10 °C to 70 °C (14 °F to 158 °F) (Storage)
Relative Humidity	5 % to 80 %, non-condensing (Operating / Storage)
IP Rating	IP20
Certificates	CE, EAC, FCC, RoHS
Warranty	5 years of limited manufacturer's warranty
0.07 %	Average Hardware Failure And Return Rate (Last Update: August 2025)

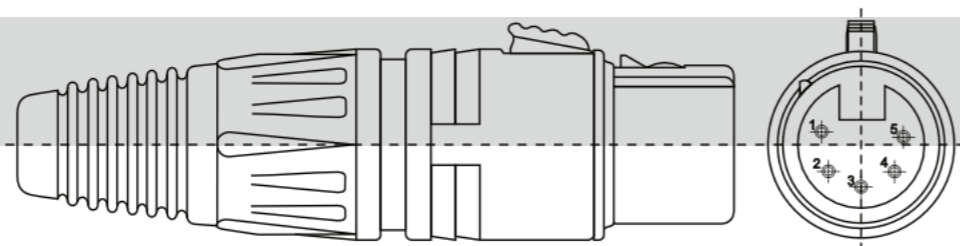

USB SMPTE

CONTROL // INPUT



Simply add time code synchronization to your projects.

MADRIX I/O

MADRIX I/O products are supplementary input and output devices. External equipment brings additional automation processes and interaction to any project using MADRIX 5.

SMPTE Time Code

This input device allows you to effortlessly use SMPTE time code for time synchronization across your equipment and multiple devices.

Standard Connectors

Data is received via the 3-pin, female XLR connector. The device can simply be connected to any USB 2.0 port.

Example Of Use

Synchronize the automated playback of scenes and effects in MADRIX 5 by using the Cue List.

Technical Specifications



Supply Of Power	DC 5 V, 500 mA, Power over USB
Power Consumption	~ 50 mA during normal operation
BTU/h	0.34 during normal operation
Plug	3-pin, XLR, female, NEUTRIK
USB	1x port, USB 2.0, type-A male plug, Plug and Play, 2 m cable
Weight	110 g (0.24 lb)
Temperature Range	10 °C to 50 °C (50 °F to 122 °F) (Operating) -10 °C to 70 °C (14 °F to 158 °F) (Storage)
Relative Humidity	5 % to 80 %, non-condensing (Operating / Storage)
IP Rating	IP20
Certificates	CE, EAC, RoHS
Warranty	5 years of limited manufacturer's warranty
0.00 %	Average Hardware Failure And Return Rate (Last Update: August 2025)



SOFTWARE

MADRIX 5 License	start	entry	basic	professional
DMX Channels	1,024	6,144	16,384	65,536
DMX Universes (Example)	(2)	(12)	(32)	(128)
RGB Voxels (Example)	(341)	(2,048)	(5,461)	(21,845)
DVI Pixels	16,384	262,144	1,048,576	2,097,152
Render Resolution (Example)	(128 x 128)	(512 x 512)	(1,024 x 1,024)	(2,048 x 1,024)
Upgradable	✓	✓	✓	✓
Validity	Lifetime	Lifetime	Lifetime	Lifetime

MADRIX 5 License	ultimate	maximum	preprogrammer
DMX Channels	262,144	1,048,576	Is a special license available for project preparation. It provides no output for MADRIX 5, but removes major limitations of the demo mode.
DMX Universes (Example)	(512)	(2,048)	
RGB Voxels (Example)	(87,381)	(349,525)	
DVI Pixels	2,097,152	2,097,152	
Render Resolution (Example)	(2,048 x 1,024)	(2,048 x 1,024)	
Upgradable	✓	—	—
Validity	Lifetime	Lifetime	Lifetime



MADRIX RADAR License	fragment	core	fusion small	fusion medium	fusion large	big data
RDM Nodes	MADRIX	Third Party	Third Party	Third Party	Third Party	All
RDM Devices / Sub-Devices	All Connected	All	All	64	512	4,096
Parameters	✓	✓	✓	✓	✓	Free For Purchasers Of
Snapshots	✓	✓	✓	✓	✓	MADRIX RDM
Sensors	✓	✓	✓	✓	✓	Nodes Or
Status Messages	✓	✓	✓	✓	✓	MADRIX RADAR Licenses
Event Monitoring	✓	—	✓	✓	✓	—
Upgradable	—	—	✓	✓	—	—
Validity	—	Lifetime	Lifetime	Lifetime	Lifetime	Lifetime

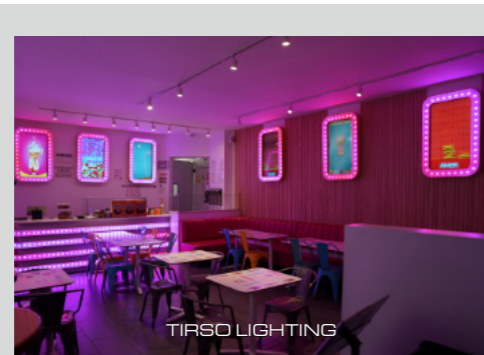

HARDWARE

	LUNA 4 / 8 / 16	STELLA 8	STELLA	NEBULA
Output (Channels)	4x / 8x / 16x 512 DMX And	1x To 8x 512 DMX And / Or	1x Or 2x 512 DMX And / Or	12x 512 SPI
Input (Channels)	1x 512 DMX	1x To 8x 512 DMX	1x Or 2x 512 DMX	—
Ethernet	1x RJ45 100 MBit/s	2x RJ45 1 GBit/s	2x RJ45 100 MBit/s	2x RJ45 100 MBit/s
USB	✓	✓	✓	✓
Art-Net	✓	✓	✓	✓
Streaming ACN	✓	✓	✓	✓
RDM Controller	—	✓	✓	—
Stand-Alone	—	Patterns & Snapshots	—	—
Mounting	19" Rack	DIN-Rail Or Wall	DIN-Rail Or Wall	DIN-Rail Or Wall

AURA 2 / 12 / 32



ORION



USB ONE



USB SMPTE



Output (Channels)	2x / 12x / 32x 512 eDMX And	8x / 16x	1x 512 DMX Or	—
Input (Channels)	8x 512 eDMX	8x Analog Inputs	1x 512 DMX	1x Analog Input
Ethernet	2x RJ45 1 GBit/s	2x RJ45 100 MBit/s	—	—
USB	✓	✓	✓	✓
Art-Net	✓	✓	—	—
Streaming ACN	✓	✓	—	Use SMPTE time code for time synchronization across multiple devices.
RDM Controller	—	—	—	Example of use: Cue List
Stand-Alone	✓	—	—	—
Mounting	DIN-Rail Or Wall	DIN-Rail Or Wall	—	—



OVERVIEW

Software Product

MADRIX KEY

MADRIX KEY

MADRIX 5 Licenses

MADRIX 5 preprogrammer

MADRIX 5 start

MADRIX 5 entry

MADRIX 5 basic

MADRIX 5 professional

MADRIX 5 ultimate

MADRIX 5 maximum

MADRIX 5 License Upgrades

MADRIX 5 start > entry

MADRIX 5 start > basic

MADRIX 5 start > professional

MADRIX 5 start > ultimate

MADRIX 5 start > maximum

MADRIX 5 entry > basic

MADRIX 5 entry > professional

MADRIX 5 entry > ultimate

MADRIX 5 entry > maximum

MADRIX 5 basic > professional

MADRIX 5 basic > ultimate

MADRIX 5 basic > maximum

MADRIX 5 professional > ultimate

MADRIX 5 professional > maximum

MADRIX 5 ultimate > maximum

MADRIX 5 Software Updates

MADRIX 5 Software Update start

MADRIX 5 Software Update entry

MADRIX 5 Software Update basic

MADRIX 5 Software Update professional

MADRIX 5 Software Update ultimate

Software Product

MADRIX RADAR Licenses

MADRIX RADAR fragment

MADRIX RADAR core

MADRIX RADAR fusion small

MADRIX RADAR fusion medium

MADRIX RADAR fusion large

MADRIX RADAR big data

MADRIX RADAR fusion License Upgrades

MADRIX RADAR fusion small > fusion medium

MADRIX RADAR fusion small > fusion large

MADRIX RADAR fusion medium > fusion large

- For prices and more information, please contact your local dealer.
- Online activation initially required one time for any software license, license upgrade, or update.
- Only one MADRIX 5 License is possible per MADRIX KEY.
- MADRIX 5 License Upgrades and MADRIX RADAR fusion License Upgrades to higher licenses are possible several times per MADRIX KEY.
- The MADRIX 5 Software Update is free of charge if you have bought MADRIX 3 Software on April 01, 2017 or any later date.
- It is possible to have a MADRIX RADAR fusion license and a MADRIX RADAR big data license on a single MADRIX KEY.



OVERVIEW

Hardware Product

MADRIX Network Nodes

MADRIX AURA 2

MADRIX AURA 12

MADRIX AURA 32

MADRIX LUNA 4

MADRIX LUNA 8

MADRIX LUNA 16

MADRIX STELLA

MADRIX STELLA 8

MADRIX NEBULA

MADRIX I/O

MADRIX ORION

MADRIX USB ONE

MADRIX USB SMPTE

Hardware Product

Accessories

XLR Gender Changer

XLR Adapter Silver

XLR Adapter Black (Premium Quality)

AURA Accessory Replacement Set

STELLA Accessory Replacement Set

STELLA 8 Accessory Replacement Set

NEBULA Accessory Replacement Set

ORION Accessory Replacement Set

DIN-Rail Power Supply 24 V

DIN-Rail Power Supply 12 V

All information in this catalog is subject to change and provided without guarantee.



© 2001 – 2026 inoage GmbH
MADRIX® is a registered trademark

inoage GmbH
Wiener Straße 56
01219 Dresden
Germany

Web www.madrix.com
E-mail info@madrix.com
Phone +49 351 862 6869 0

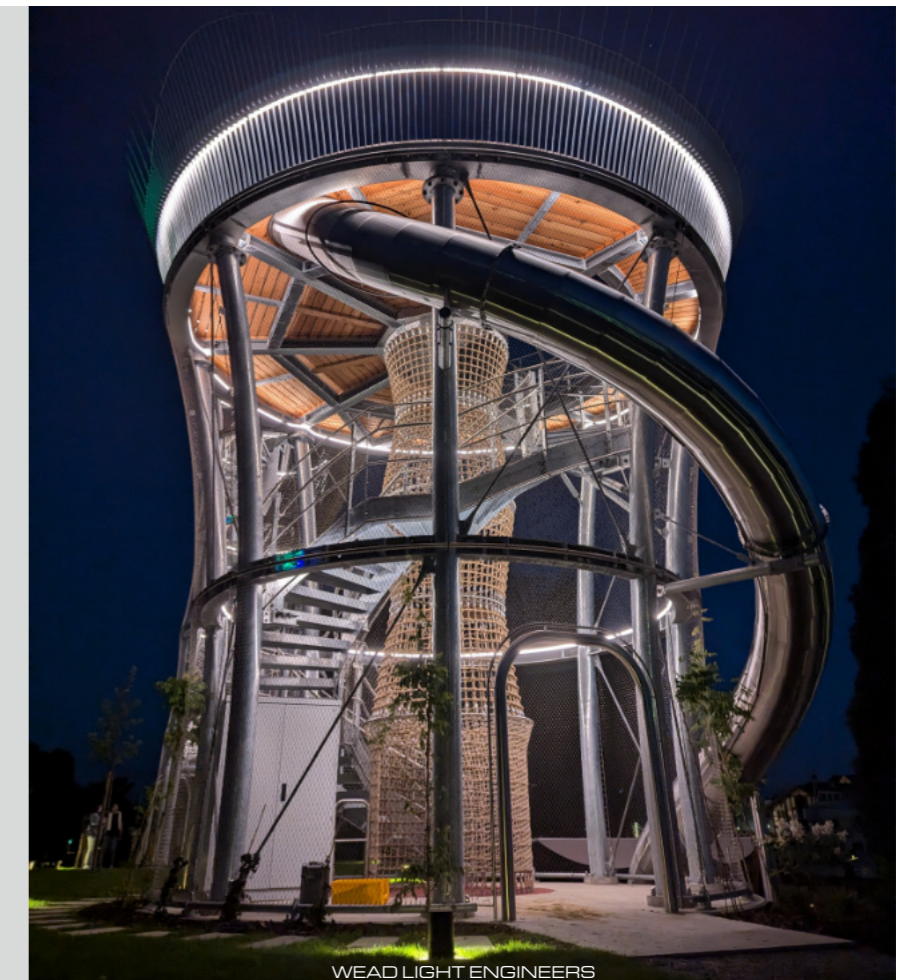



Made in Germany

www.madrix.com

February 2026

