

**JIM WIEBE'S**

1<sup>st</sup> EDITION

*Illustrated Guide and Catalog of Custom Saddlery*

# ILLUSTRATED GUIDE

FOR PURCHASERS OF

## Horse Furnishing Goods

CUSTOM AND STOCK, IMPORTED AND DOMESTIC

## NOVELTIES

And

## STABLE

## APPOINTMENTS

J. B. Wiebe III, LLC *Bennett's Hunter*<sup>®</sup> Fine Bridles



429 E. Commerce Street, #112, Hernando, Mississippi 38632

Email: [FineBridle@aol.com](mailto:FineBridle@aol.com)

Website and Online Catalog: <https://jbwiebe3.com/shop>

## A personal message from our managing director, Jim Wiebe

Dear Family, Friends, Founder's Club Members, and Customers,

Thank you for letting me introduce you to our company, J. B. Wiebe III, LLC.

Do you have a question? Are you looking for something for that special horse, rider, trainer, or a groom that always goes above and beyond - always exceeding expectations? Looking for the very best quality? Want to complete "the picture" you present in the show ring by showing your horse at their very best?

We are an internet-based business located in northwest Mississippi, near Memphis, TN.

The best way to reach us is by email to [FineBridle@aol.com](mailto:FineBridle@aol.com)

### **Our Wiebe family history in the bridle making and saddlery trades, from 1951 to present day:**

I have spent my entire adult life making bridles and other saddlery and am pleased to offer this *1<sup>st</sup> Edition* of my **Illustrated Guide**, a product catalog of fine English equestrian themed products including horse furnishing goods, novelties, and stable appointments, mostly custom and made to order.

I design and manufacture fine quality hand crafted executive accessories for the home and office, and specialize in custom bridles, saddles, other saddlery, fine pleasure driving harness, show hunter and jumper training harness and training aids, show stable fixtures, and other finely handcrafted products. Much of what we offer is of our own original novel design. After the product catalog sections, we include order forms, measuring instructions, and business policies.

This catalog does not include current pricing that is subject to change and is available online at <https://jbwiebe3.com/shop/ols/products>

The contents of this Illustrated Guide are offered to preserve what our Wiebe family has done in the English saddlery trades from the founding of **Jimmy's Saddlery** by my Dad, James B. Wiebe Jr. (Jimmy Wiebe "The Stitcher"), in 1951, **Bennett's Saddlery, Ltd.** founded by me in 1983, and **J. B. Wiebe III, LLC** from January 2020 to the present day: making our products to Old-World standards of the finest quality craftsmanship and doing it "*The Wiebe Way*".

*The Wiebe Way* was something I was taught by my grandfather, James Bennett Wiebe Sr. We called him "Pa". Pa was a master craftsman, mostly of German and Irish lineage, and his work was exquisitely hand crafted. He was a master machinist, patternmaker, toolmaker, woodcarver, and industrial arts teacher. When I was a very young boy, he taught me that when I was in his workshop, I had to do things his way, *The Wiebe Way*. I was taught to do the job right or not at all. I loved working in Pa's workshop. This was the start of my life-long education in doing things *The Wiebe Way*.

I grew up around hunter and jumper show horses and ponies. My Dad and my mother, Nancy Clapp Wiebe, trained, showed, and sold hunter and jumper show horses. I spent time on our Wiebe family farm on Fox Hill Road near Oldwick, New Jersey, and in my Dad's workshops at **Jimmy's Saddlery** in Oldwick and Pottersville, New Jersey in the early 1960's and 1970's. I made my first bridle leather project in my Dad's workshop in Oldwick. My Dad, James Bennett Wiebe Jr., well known throughout the USA as *Jimmy Wiebe*, "*The Stitcher*," made me a small stitching horse out of a wooden milk crate and a set of small stitching jaws. I pulled my first stitches on that little stitching horse in the mid-1960's. Dad showed me how to rub and crease edges, punch holes, and sew in a buckle and keepers to make myself a belt. I was 7 years old. I worked full time in my Dad's **Jimmy's [20<sup>th</sup> Century<sup>®</sup>] Saddlery** workshop from 1979 through 1981, mostly in Phoenix, Arizona, and briefly in Skowhegan, Maine, apprenticing as a bridle maker and saddler. My Dad taught me the

basics and then more about the making and use of his bridles, training aids, and other saddlery, saddle design, saddle making and repair, fine harness making, and a lot about bits. My Dad was the most disruptively innovative professional horseman-saddler in the USA throughout his 65-year career. His knowledge of training and showing hunter and jumper show horses was extensive. He was the most knowledgeable professional horseman/saddler in the bridle making, saddle making, and harness making trades. I was fortunate to have grown up around my Dad and Pa. They taught me a lot about working with my hands, and hand crafting leather, wood, and metal, doing it *The Wiebe Way*.

In the Spring of 1983, I established my own company, **Bennett's Saddlery**, in Weston, Connecticut. I developed a complete product line of bridles, custom saddles, and other saddlery in the mid-1980's, and displayed our products at horse shows in the eastern USA. We moved to Charlottesville, Virginia in 1990, where I continued making and selling bridles and studied at the University of Virginia, earning a degree in Mechanical Engineering in 1998. In December 2019, after working for 21 years as a product development engineer, I returned to my Wiebe family roots making custom bridles and other saddlery full time for our Wiebe family-owned company, **J. B. Wiebe III, LLC**.

Today, **J. B. Wiebe III, LLC** is based in northwest Mississippi USA, with me as its managing director. I make our **Wiebe Heirloom Quality**<sup>®</sup> custom products in our workshop, mostly to special custom order. I do this *The Wiebe Way*.

After my Dad passed away in December 2016, my stepmother continued to sell my Dad's products, and in 2020, my Dad's company, **Jimmy's [21<sup>st</sup> Century**<sup>®</sup> **Saddlery**, joined us at **J. B. Wiebe III, LLC** in northwest Mississippi USA. Today we are the exclusive sellers of my Dad's product lines: **20<sup>th</sup> Century**<sup>®</sup> **Custom** and **21<sup>st</sup> Century**<sup>®</sup> imported bridles, saddles, and other saddlery, including strap goods, horse boots, and my Dad's extensive collection of bits.

We welcome retail customer inquiries. We only sell retail to end users that are in good standing with our company including individuals, professional equestrians, amateurs, and junior exhibitors, farms, and show stables.

We do not sell to saddlery businesses, tack shop trailer horse show vendors, or equestrian boutiques.

If you have special design requirements, we can help you. If you are looking for the finest quality hand-crafted custom bridle, we believe you will find ours to be of the finest quality available today. If you are looking for one of my Dad's classic designs: a saddle, bridle, or other saddlery, made to my Dad's own Custom Quality design specifications, we are the only ones trained by my Dad, to make and supply it.

We offer only the finest quality hand-crafted products done *The Wiebe Way*. Let us know how we can help you.

Sincerely,

*Jim Wiebe*

Managing Director

**J. B. Wiebe III, LLC**

429 E. Commerce St., #112  
Hernando, MS 38632

Email: [FineBridle@aol.com](mailto:FineBridle@aol.com)

Website and online catalog: <https://jbiebe3.com/shop>

**NOTE FOR THIS 1<sup>st</sup> EDITION OF JIM WIEBE'S ILLUSTRATED GUIDE:**

A PDF copy of this **1<sup>st</sup> EDITION** of Jim Wiebe's Illustrated Guide is available for download from our website at <https://jbiebe3.com/reference-documents-forms>

This edition focuses on our finest **Wiebe Heirloom Quality**<sup>®</sup> custom bridles, saddlery strap goods, home office accessories, and my Dad's **20<sup>th</sup> Century**<sup>®</sup> and **21<sup>st</sup> Century**<sup>®</sup> saddles.

This **1<sup>st</sup> EDITION** of Jim Wiebe's Illustrated Guide is © 2024 by James B. Wiebe III, Coldwater, Mississippi USA, and published by J. B. Wiebe III, LLC, Hernando, Mississippi USA, all rights reserved by James B. Wiebe III. No part of this publication may be reproduced in any form without written permission from the author.

Please send inquiries to:        James B. Wiebe III  
   J. B. Wiebe III, LLC  
   429 E. Commerce St., #112  
   Hernando, MS 38632  
   Email: [FineBridle@aol.com](mailto:FineBridle@aol.com)

**COPYRIGHT NOTICE:**

All content including text, photos, files, and any other information in this illustrated catalog is © 2024 by **James B. Wiebe III**, all rights reserved.

# Table of Contents

	Page(s)
i. A personal message from Jim Wiebe	2 - 4
ii. Table Of Contents	5
iii. J. B. Wiebe III, LLC and <i>Wiebe Heirloom Quality</i> <sup>®</sup> : Committed to Quality	6 - 10

## Product Catalog: Chapter list

1) <i>Bennett's Hunter</i> <sup>®</sup> Belts, Pet Collars, and Leashes	11
2) <i>Bennett's Hunter</i> <sup>®</sup> Executive Accessory Collections: equestrian themed accessories	12 – 15
3) <i>Jimmy Wiebe Memorial</i> <sup>®</sup> Special Collections: Custom Bridles, Reins, and Martingales	16 - 18
4) <i>Jimmy's 20<sup>th</sup> Century</i> <sup>®</sup> Saddlery: Jimmy Wiebe's <i>20<sup>th</sup> Century</i> <sup>®</sup> and <i>21<sup>st</sup> Century</i> <sup>®</sup> saddles	19 - 21
5) <i>Bennett's Hunter</i> <sup>®</sup> Fine Bridles: Custom Bridles, Strap Goods, Horse Boots, and Training Aids	22 - 39
a) <i>Bennett's Hunter</i> <sup>®</sup> Custom Bridles, Special Collections:	22 - 24
i) Hunter and Jumper Show Bridles	22 - 23
ii) Gag Show Bridles	24
iii) Flat Hunter Bridles and Round Racing Bridles	24
b) <i>Bennett's Hunter</i> <sup>®</sup> Custom Reins	25 - 26
c) <i>Bennett's Hunter</i> <sup>®</sup> Custom Martingales and Breastplates	27 - 28
d) <i>Bennett's Hunter</i> <sup>®</sup> Custom Girths and Stirrup Leathers	29
e) <i>Bennett's Hunter</i> <sup>®</sup> Custom Horse Boots	30
f) <i>Bennett's Hunter</i> <sup>®</sup> Custom Halters and Lead Shanks	31
g) <i>Bennett's Hunter</i> <sup>®</sup> Custom Training Aids, Biting Rigs and Harnesses	32
h) <i>Bennett's Hunter</i> <sup>®</sup> Custom Training Aids, Rollers and Harness Parts	33
i) <i>Bennett's Hunter</i> <sup>®</sup> Custom Training Aids	34 - 35
j) <i>Bennett's Hunter</i> <sup>®</sup> Custom Bridle Parts	36 - 38
k) <b>Bit, Stirrup, and Spur Accessories:</b>	39
6) <b>Show Stable Tools and Supplies:</b> leather care, tools, grooming supplies, and stable fixtures	40 - 41

## Unbound Catalog Inserts:

A. <b>Retail Business Policies:</b> how we do business and how to place an order.	A-1, A-2
B. <b>Measuring/Order Forms</b>	B-1, B-2, B-3, B-4
C. <b>Leather Care Instructions</b>	C-1, C-2, C-3
D. <b>Fancy Stitch Designs</b>	D-1, D-2

Back Cover	52
------------	----

## Committed to Quality

### **Some background on our company, who we are and what we do, written by Jim Wiebe.**

I am Jim Wiebe, founder of **J. B. Wiebe III, LLC**. We welcome your interest in our custom bridles and saddlery.

Our *Wiebe* family-owned company, **J. B. Wiebe III, LLC**, has its origins with the founding of **Jimmy's Saddlery** in 1951, in Parsippany, New Jersey. My Dad, James B. Wiebe Jr., a.k.a. *Jimmy Wiebe*, "*The Stitcher*," founded **Jimmy's Saddlery**. Dad and I built reputations for the finest hand-crafted custom bridles, saddles, and other saddlery, fine harness for show and pleasure driving, an extensive collection of bits, and training aids for training hunter and jumper show horses. Today, **Jimmy's Saddlery** is part of **J. B. Wiebe III, LLC**.

I am continuing our *Wiebe* family traditions and commitments to the saddlery trade and fine craftsmanship as managing director of **J. B. Wiebe III, LLC**. I continue to make our finest *Wiebe Heirloom Quality*<sup>®</sup> bridles, saddlery strap goods, training aids, and leather accessories for the home office, executives, and other professionals, and show stables.

I am responsible for all aspects of our product designs and engineering consulting services that we offer. I earned a Bachelor of Science degree in mechanical engineering from the University of Virginia, School of Engineering and Applied Science in 1998.

I am an inventor for a range of patents, mostly in knee implant systems and heavy duty orthopedic surgical power instruments, as part of my work over 25 years as an engineering professional in product development and product sustainability. I have product development and product sustainability experience with English saddlery and harness, naval nuclear propulsion system valve sustainability, electrical connector manufacturing progressive dies, heavy duty and micro surgical power instruments, knee orthopedic systems including knee implants, patient specific solutions in knee orthopedics, reusable and single use knee orthopedic instruments, and knee implant bone fit algorithm and prototype software system development.

**J. B. Wiebe III, LLC** is an internet-based company located in northwest Mississippi near Memphis, Tennessee. We do not operate a brick-and-mortar store or public showroom for onsite selling. We sell by mail order through our website, <https://jbwiebe3.com/shop>

We specialize in finely hand-crafted English bridles, saddlery, and accessories for show horses, equestrians, and other horse enthusiasts in the USA. I design and make most of what we sell to special custom order in our workshop in the USA. We use the finest English equestrian leather, hardware, thread, and textiles in our saddlery products: only the best.

The best way to initiate an order is by using our Online Catalog. I may be reached by email to [FineBridle@aol.com](mailto:FineBridle@aol.com)

### **COPYRIGHT NOTICE:**

All content including text, photos, files, and any other information in this illustrated guide and catalog are © 2023 by James B. Wiebe III, all rights reserved.

## Handcrafted Designs and 5 Generations of Master Craftsmen

I established **Bennett's Hunter® Fine Bridles** and saddlery designs in 1983. Many of the bridles we sell are custom fitted to the horse and rider. Finely hand crafted and made to last, some of my custom bridles have been in service for over 40 years.

I was trained by my Dad, founder of **Jimmy's Saddlery**, and also my grandfather, *James B. Wiebe Sr.*, a.k.a. *Pa*. I have been immersed in the saddlery trade since the early 1960's, when as a small boy in Dad's workshop in Oldwick, New Jersey, I made my first leather belt under my Dad's supervision. Other projects followed. From 1979 through 1981, I apprenticed in Dad's workshop in Phoenix, Arizona. In 1983, I established **Bennett's Saddlery** in Weston, Connecticut, and in 1990, moved to Charlottesville, Virginia. Today, **J. B. Wiebe III, LLC** is located in northwest Mississippi near Memphis, Tennessee in the USA.

Our *Wiebe* family legacy includes a line of master craftsman that goes back at least 5 generations. I am keeping alive this family legacy as managing director of **J. B. Wiebe III, LLC**.

### Who may shop with us

We sell to individual equestrians, professional trainers and riders, farms, and show stables that are in good standing with our company.

We do not sell to other saddlery businesses, tack trailer horse show vendors, boutiques, feed stores, or any other retail or wholesale seller of saddlery. We only sell directly to end users of our products who are in good standing with our company.

- For more information on who may purchase from us, and how to place an order, see our business policies in the appendices following the products chapters.

### Want to see more information about our products?

Products are presented in the product chapters below this section. To see more specific product information and to shop using our **Online Catalog**, see <https://jbwiebe3.com/shop/> Product searches may be refined by selecting a category under the "ALL PRODUCTS" link in our **Online Catalog**.

- The best and most reliable way to place an order is using our website and **Online Catalog**.

Questions may be sent by email to [FineBridle@aol.com](mailto:FineBridle@aol.com)

Please provide an email and cell phone number when placing an order. We follow up with help measuring for custom orders and answers questions.

## **J. B. Wiebe III, LLC and *Wiebe Heirloom Quality*<sup>®</sup>: Committed to Quality**

*Wiebe Heirloom Quality*<sup>®</sup> is a trademark of *James B. Wiebe III*, all rights reserved. I place this trademark on all custom leather goods that I makes in our workshop in northwest Mississippi in the USA. Only our finest special custom products made-to-order by me receive this exclusive trademark.

Our quality design specifications originated in our **Jimmy's Saddlery** workshops in New Jersey from the 1950's through 1974. Dad relocated to Skowhegan, Maine, in 1974, and moved to Phoenix, Arizona, in 1978.

Today, our finest custom saddlery products are the finest quality in the English saddlery industry in the USA. Our finest quality custom work far exceeds the quality of English and European saddlery that is manufactured in England, the EU, and in Asia.

Don't take our word for it: look and compare our custom work quality to others made in the USA and overseas.

To see the best, look closely at the photographs in our custom product chapters below and on our website's "SHOP" page to see the detail that I put into our finest *Wiebe Heirloom Quality*<sup>®</sup> custom work, a **J. B. Wiebe III, LLC** exclusive only available directly from our company.

When you order a *Wiebe Heirloom Quality*<sup>®</sup> custom bridle or other custom saddlery made to order especially for you, it is made in our workshop by me.

Our custom bridles and other custom saddlery are not imported from a mass producer in Walsall, England - **that would not be custom made**, nor are our custom orders delegated to an apprentice or other journeyman bridle maker in our workshop or elsewhere. They are made 100% by me in our **J. B. Wiebe III, LLC** workshop in Mississippi, USA.

### ***Bennett's Hunter*<sup>®</sup> and *Jimmy Wiebe Memorial*<sup>®</sup> bridles:**

- *Bennett's Hunter*<sup>®</sup> and *Jimmy Wiebe Memorial*<sup>®</sup> are trademarks of *James B. Wiebe III*, all rights reserved.

Our finest custom products are our *Bennett's Hunter*<sup>®</sup> and *Jimmy Wiebe Memorial*<sup>®</sup> products. *Bennett's Hunter*<sup>®</sup> and *Jimmy Wiebe Memorial*<sup>®</sup> show bridles and other saddlery are finely stitched 11 to 14 stitches per inch, with all fancy stitching and stress points stitched finely by hand. Edges are shaved, burnished, and creased by hand. The finest Number 1 Select bridle leather, harness leather, and other equestrian leather we import from England and source in the USA are used in our equestrian products.

Since the 1950's, the *Wiebe* family has developed a broad range of the best World Class leather sources for our saddles, custom bridles, other custom saddlery, and executive leather accessories for the home office and stable. We use the **Best Quality Cupro-Nickel Alloy (BQNA)**, stainless steel, and solid brass hardware from the finest global suppliers. We personally select the best saddlery threads and textiles from the finest global sources.

### ***Jimmy Wiebe Memorial*<sup>®</sup> Special Collections:**

In memory of my Dad, we offer special collections that carry our exclusive trademark, *Jimmy Wiebe Memorial*<sup>®</sup>. Saddles in this special collection are in stock and ready to ship. *Jimmy Wiebe Memorial*<sup>®</sup> bridles and other saddlery strap goods in this special collection are by custom order only.



Our *Wiebe Heirloom Quality*<sup>®</sup> products are made to order in our workshop in the USA. Because these products are custom made to order exclusively by me, lead times are longer than other products we have in stock and ready to ship.

### **Our standard saddlery product lines by *Jimmy Wiebe*, in stock and ready to ship:**

If you need something faster than our special custom-made *Wiebe Heirloom Quality*<sup>®</sup> custom products, we recommend you request our *20th Century*<sup>®</sup> and *21st Century*<sup>®</sup> products which are usually in stock and ready to ship.

*20th Century*<sup>®</sup> and *21st Century*<sup>®</sup> are trademarks of *James B. Wiebe III*, all rights reserved.

Genuine *20th Century*<sup>®</sup> **Custom** saddlery was designed by my Dad and is exclusively manufactured, imported, and sold by **J. B. Wiebe III, LLC**. *20th Century*<sup>®</sup> and *21st Century*<sup>®</sup> trademarks with the **Custom** stamp placed on strap goods were made by Dad prior to 2020, and in **J. B. Wiebe III, LLC**'s workshop from 2020 to present day.

*20th Century*<sup>®</sup> and *21st Century*<sup>®</sup> trademarks without the **Custom** stamp were made to Dad's strict quality specifications and imported by my Dad and **Jimmy's [20th Century<sup>®</sup>] Saddlery** prior to 2020, and by **J. B. Wiebe III, LLC** from 2020 to present day. These products are imported and not made-to-order.

### **Our Saddlery Hardware Collection:**

Our bit collection includes many genuine original John Drewsbury pattern *Kangaroo*<sup>™</sup> BQNA and the finest *Eldonian*<sup>™</sup> stainless steel bits imported from England by **Bennett's Saddlery** and **Jimmy's Saddlery** prior to calendar year 2000.

**BUYER BEWARE:** Do not be misled by bits recently rebranded on the internet by manufacturers in England that are using reprints of John Drewsbury "Kangaroo<sup>™</sup>" and "Eldonian<sup>™</sup>" brand tags, labels, or packaging.

All of our *Eldonian*<sup>™</sup> stainless steel and *Kangaroo*<sup>™</sup> BQNA bits and much of our BQNA specially manufactured stout finely finished bridle hardware were imported from England by the Wiebe family before previous manufacturers of these bits shut down their saddlery hardware manufacturing operations in England.

Some of these English companies off-shored their manufacturing to China. Some of these manufacturers in England went out of business years ago and their brand names were sold to other lesser quality manufacturers and wholesalers in England. What resulted was production of lesser quality saddlery hardware to present day.

Our genuine best quality English saddlery hardware is more finely finished and made from the original patterns no longer in production in England. It is in limited supply and only available from **J. B. Wiebe III, LLC**.

## **Custom tailored to meet the needs of every equestrian: Professionals, amateurs, juniors, and show stables**

**J. B. Wiebe III, LLC** makes much of what we sell to the specialized requirements of our customers. Whether a custom fitted bridle, a new fancy stitch pattern, hand stitched monogram, or a new original training aid design, we can support your special needs. We can work from a cell phone photo of a rough sketch on a napkin or a detailed specification drawing. We will walk you through any measuring required for custom orders. Delivery times vary, and custom orders may have long lead times. We may provide lead time estimates at the time of order that are subject to change.

See our business policies at the bottom of our website homepage at <https://jbwiebe3.com> and in this Illustrated Guide in the appendices after the product catalog chapters for more information on how to place an order.

## **You can trust us to deliver the finest quality bridles and other saddlery from our Wiebe family-owned business.**

**No other business has our permission to use our trademarks or business tradenames (DBA's).** Beware of false claims in advertising, on other's websites, and misleading product tags on products not offered directly from us. Beware of false claims in person or online, in other tack shops, feed stores, saddlery boutiques, and tack trailer horse show vendors that claim to sell our products. They do not represent us and do not have our permission to claim any affiliation with us.

**We do not sell to other tack shops, horse show tack trailer vendors, feed stores, or saddlery boutiques.** Please do not accept lesser quality imitations, fakes, or false claims that another store has our products.

We only sell directly to individuals, equestrians, show stables, and farms in the USA. **No exceptions.**

## **World class quality, specializing in custom requirements**

Do you have a question? Are you looking for something for that special horse, rider, trainer, or a groom that always goes above and beyond - always exceeding expectations? Looking for the very best quality? Want to complete "the picture" you present in the show ring by showing your horse at their very best?

We are an internet-based business located in northwest Mississippi, near Memphis, TN. Contact us via email and we will get back to you with answers!

## **J. B. Wiebe III, LLC**

Mailing address:

429 E. Commerce St., #112  
Hernando, MS 38632

Email: [FineBridle@aol.com](mailto:FineBridle@aol.com)

# Product Catalog: Chapter 1

## Bennett's Hunter® Custom Belts, Watchbands, Pet Collars, and Leashes

Jim Wiebe offers special collections under our exclusive trademark, *Wiebe Heirloom Quality*®. These belts, watchbands, pet collars, and leashes are completely custom made by Jim in our Mississippi USA workshop, and only available from J. B. Wiebe III, LLC.

### Belts:



**Bennett's Hunter® ½ Round Fancy Laced Belt, with monogram and fancy stitching stitched by hand.**

LIGHT HAVANA color. Belt SKU: BHC\_105 3 letter monogram, hand stitched, priced per letter, 1 to 4 letters SKU: BHC\_120\_04  
5 - 7 letters, priced per name SKU: BHC\_120\_07 8 - 10 letters, priced per name SKU: BHC\_120\_10 11 - 14 letters, priced per name SKU: BHC\_120\_14

**Bennett's Hunter® ½ Round Fancy Belt without lacing** SKU: BHC\_102

**Bennett's Hunter® ½ Round Plain Belt** SKU: BHC\_101

**Bennett's Hunter® Flat Leather Plain Belt** SKU: BHC\_100

### Watchbands, Dog Collars and Pet Leads:

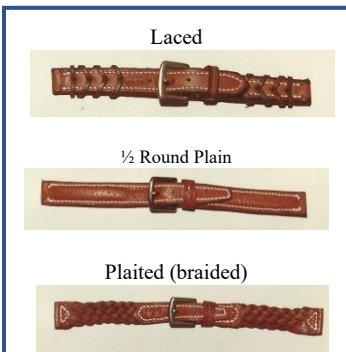

Laced

½ Round Plain

Plaited (braided)

#### Bennett's Hunter® Watchbands

LIGHT HAVANA color.  
Double Stitched SKU: BHC\_130  
Laced SKU: BHC\_131  
½ Round Plain SKU: BHC\_132  
Plaited (braided) SKU: BHC\_133



½ Round Fancy Dog Collar

½ Round Fancy Dog Collar and Flat leather Pet Leash with Breastplate Style hand loop



½ Round Fancy Pet Leash with Flat leather hand loop

#### Bennett's Hunter® Dog Collars and Pet Leashes LIGHT HAVANA color.

½ Round Fancy Dog Collar SKU: BHC\_152  
Double Stitched Breastplate Style Dog Collar SKU: BHC\_160  
Nameplate (sold separately) SKU: NMPLT\_168\_Medium  
Flat leather Pet Leash SKU: BHC\_160 Flat leather Pet Leash with Breastplate Style hand loop SKU: BHC\_160\_BP  
½ Round Fancy Pet Leash with Flat leather hand loop SKU: BHC\_470  
½ Round Fancy Pet Leash with Breastplate Style hand loop SKU: BHC\_470\_BH

## Product Catalog: Chapter 2

### *Bennett's Hunter® Executive Accessory Collections: Equestrian themed accessories*

Wiebe Heirloom Quality® equestrian themed accessories designed by Jim Wiebe and exclusively manufactured, imported, and sold by J. B. Wiebe III, LLC, made to special custom order.

### *Bennett's Hunter® Special Collections*

These accessories are made in our Mississippi USA workshop by Jim Wiebe.



***Bennett's Hunter® Attaché Brief Case***, Hard Shell, with custom deluxe interior details. **Special CUSTOM ORDER ONLY.**

Designs vary, with customer's special requests considered. Corners stitched by hand. The 1/2 round fancy stitched breastplate style handle is hand stitched in **Light Havana** or **Newmarket** light brown leather color with a **London** tan color panel hide padded backing.

Light Havana SKU: BHC\_500\_LH

Nut Brown SKU: BHC\_500\_NB

Black SKU: BHC\_500\_BLK

Personalize with a brass nameplate or hand stitched fancy stitching and monogram or name.

# Bennett's Hunter® Special Collections

These accessories are made in our Mississippi USA workshop by Jim Wiebe.

Other custom document and artist's cases and Flap Over Soft Shell Legal Brief Cases:



## **Bennett's Hunter® Artist's Case, Deluxe Pattern, Hard Shell, with custom deluxe interior details.**

**Special CUSTOM ORDER ONLY.** Photos show our standard attaché case. This artist's case is hand crafted in our J. B. Wiebe III, LLC workshop in northwest Mississippi by Jim Wiebe and made to special custom order.

Designs vary, with customer's special requests considered. Corners stitched by hand. A 1/2 round fancy stitched breastplate style handle is hand stitched in **Light Havana** or **Newmarket** light brown leather color with a **London** tan color panel hide padded backing. A shoulder strap is included in this special design. These cases are made to order and are larger than our attaché cases to carry a 17 x 22 inch artist's sketch pad.

The designs include custom trays and boxes for artist's supplies, an 18 X 24 inch drawing board, art and drawing supplies.

Light Havana SKU: BHC-502-LH

Personalize with a brass nameplate or hand stitched fancy stitching and monogram or name.

## **Bennett's Hunter® Soft Shell Flap Over Legal Brief Case,**

with custom interior details, 2 folder dividers, and pockets for pens, pencils, writing supplies, a smart phone, and tablet.

**Special CUSTOM ORDER ONLY.**

Designs vary, with customer's special requests considered. The 1/2 round fancy stitched breastplate style handle is hand stitched in **Light Havana** or **Newmarket** light brown leather color with a **London** tan color panel hide padded backing. A shoulder strap is included in the design.

Light Havana/Newmarket color SKU: BHC-517-LH

Personalize with a brass nameplate or hand stitched fancy stitching and monogram or name.



## **Bennett's Hunter® Portfolios**

Burgundy or Black leather color, Natural Belgian Linen lining, brass hardware.

### **Audition/Interview Portfolio, 8-1/2 X 11 Letter Size**

Burgundy color SKU: BHC\_535\_BGY

Black color SKU: BHC\_535\_BLK

### **Writer's Trifold Portfolio, 8-1/2 X 11 Letter Size**

Burgundy color SKU: BHC\_533\_BGY

Black color SKU: BHC\_533\_BLK

## **Bennett's Hunter® Orchestra/Band Director's Folder**

To fit 9 X 12 inch music

Burgundy leather color SKU: BHC\_545\_BGY

Black color SKU: BHC\_545\_BLK



## **Bennett's Hunter® Custom Wallets**

**CUSTOM ORDER ONLY.**

Designs vary, with customer's special requests considered. Lined internally with Belgian linen. Burgundy or Black leather color.

**Breast Pocket, Bi-fold SKU: BHC\_550**

**Tri-fold Pants Pocket SKU: BHC\_551**

## **Bennett's Hunter® Instrumental Musician's Folder:**

To fit 9 X 12 inch music

Burgundy leather color SKU: BHC\_546\_BGY

Black color SKU: BHC\_546\_BLK

**Traveler's Pouch, for passport, credit cards, driver's license, cash while traveling by air/train/mass transit SKU: BHC\_552**

Select Brown, Burgundy or Black leather color.

# Bennett's Hunter® Special Collections

Custom Purses and Bags, Overnight Bags, Backpacks, and Duffles

## **Bennett's Hunter® Custom Purses and Bags** Special CUSTOM ORDER ONLY.

Designs vary, with customer's special requests considered. A shoulder strap is included in the design. Lined internally with Belgian linen or other fine textiles. Light Havana/Newmarket leather color.

**Small Cutch Purse** SKU: BHC\_560

**Small Leather Purse** with shoulder strap SKU: BHC\_561

**Small leather and fabric purse** with shoulder strap SKU: BHC\_562

**Shoulder Tote Bag**, Soft-Shell, Linen w/ Leather Accents  
SKU: BHC\_565

**Shoulder Tote Bag**, Soft-Shell, Linen w/ Leather Accents, internal pockets, and divider, SKU: BHC\_566

**Shoulder Tote Bag**, Soft-Shell, Linen w/ Leather Accents, internal pockets, and divider, zipper closure, SKU: BHC\_567

## **Bennett's Hunter® Custom Overnight Bags** Special CUSTOM ORDER ONLY.

Designs vary, with customer's special requests considered. A shoulder strap is included in some designs. Lined internally with Belgian linen or other fine textiles with leather accents and trim. Light Havana/Newmarket leather color.

**Overnight Bag**, Baghide outer semi-soft shell, Top "outback" folding closures, brass fittings, Dbl BP shoulder strap, 1/2 R F BH logo handle, linen lining, Leather Accents. SKU: BHC\_568

**Overnight Backpack Bag**, Baghide outer semi-soft shell, Flap-over outer closures, brass fittings, Dbl BP shoulder straps, 1/2 R F BH logo handle, linen or panel hide lining, medium size. SKU: BHC\_569

**Overnight Backpack Bag**, Baghide outer semi-soft shell, Flap-over outer closures, brass fittings, 2 Dbl BP shoulder straps, heavy 1/2 R F BH logo handle, linen fabric lining, small size. SKU: BHC\_570

**Overnight Duffle Bag**, Baghide outer semi-soft shell, zipper outer closures, brass fittings, 2 Dbl BP shoulder straps, 1/2 R F BH logo handle, linen or panel hide lining, large/medium size. SKU: BHC\_571

## **Bennett's Hunter® Desk Sets**

Light Havana/Newmarket, Burgundy or Black leather color,  
Natural Belgian Linen linings, brass hardware.

**In/Out Box** 8-1/2 X 11 Letter Size, **Pencil Box**, **Desk Organizer**  
SKU: BHC\_575

**Desk Blotter**, 17" X 22" Size  
SKU: BHC\_576

Specify a leather color: Light Havana/Newmarket, Burgundy or

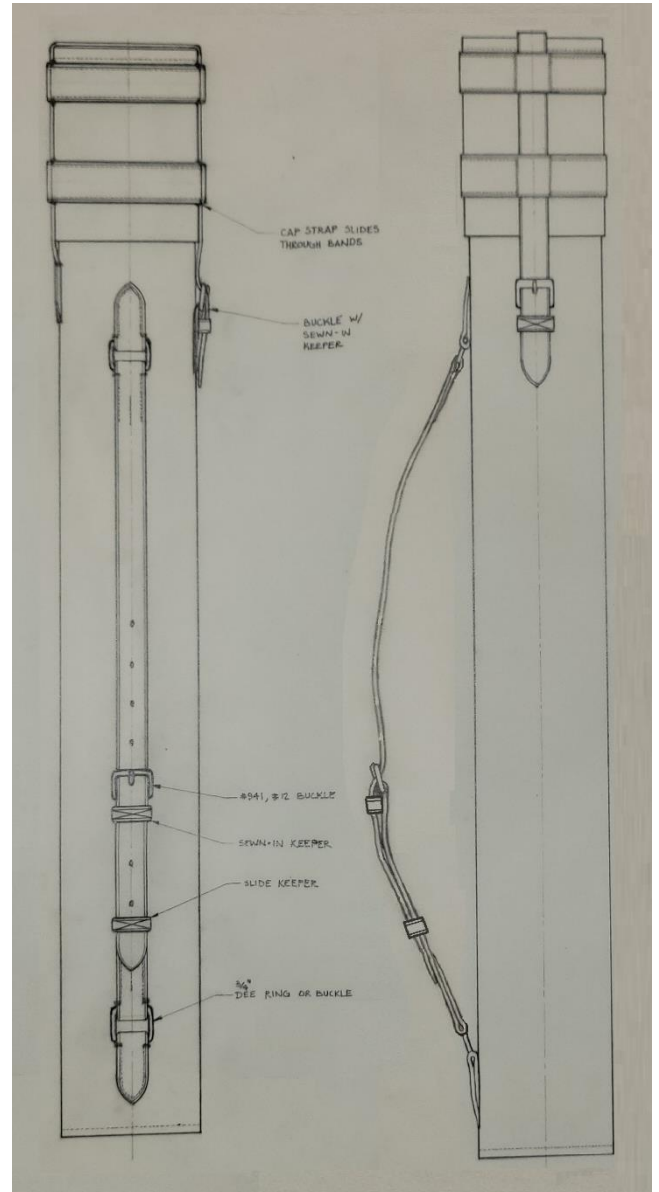

## **Bennett's Hunter® Custom Drawing Tubes**, for rolled drawings and artwork. **Special CUSTOM ORDER ONLY.**

Designs vary, with customer's special requests considered. A shoulder strap is included in the design. Lined internally with a cotton duck canvas sleeve. Light Havana/Newmarket color.

Drawing Tube 2" X 19" SKU: BHC\_580

Drawing Tube 2-1/2" X 22" SKU: BHC\_581

Drawing Tube 3" X 24" SKU: BHC\_582

Personalize with a brass nameplate.

# Bennett's Hunter® Special Collections



## **Bennett's Hunter® Stitching Horse Lamp**

These lamps are made by Jim in our J. B. Wiebe III, LLC workshop. Patterned after the stitching horse Jim's father, Jimmy Wiebe "The Stitcher", used for much of his 65+ years in the saddlery trade making world class bridles and saddlery. This approximate 1/3 scale design is a functional model of an American designed bridle maker's mainstay.

Lamp shades may vary. Available wood stain finishes include Colonial Maple, Cherry, Walnut, and light antique pine. Made of pine, maple, and/or walnut with brass and leather details. Comes fully assembled. 60W light bulb not included. Specify wood finish. SKU: BHC\_585

**Bennett's Hunter® Key Ring**  
LIGHT HAVANA color.

**Made to Order**  
SKU: BHC\_590

**Bennett's Hunter® Pen/Pencil Holder**  
Holds 2 pencils or pens.  
Pigskin or Bridle Leather. **Made to Order**  
LIGHT HAVANA color. SKU: BHC\_591

**Bennett's Hunter® Leather Envelope** Holds note cards or stationary for letter writing. Pigskin or Bridle Leather. Various sizes. **Made to Order**  
LIGHT HAVANA color. SKU: BHC\_592

**Bennett's Hunter® Leather Pencil Case**  
(holds pencils, erasers, pens, small stapler, and paper clips for letter writing). Pigskin or Bridle Leather covered, linen or leather lined. Various sizes and styles.  
**Made to Order**  
LIGHT HAVANA color. SKU: BHC\_593

**Bennett's Hunter® Leather Lap Desk**  
For letter writing. Pigskin or Bridle Leather covered, linen or leather lined. Various sizes and styles.  
**Made to Order**  
LIGHT HAVANA color. SKU: BHC\_594

**Bennett's Hunter® Leather Writer's Case**  
For letter writing materials. Pigskin or Bridle Leather covered, Belgian linen lining with leather accents and trim interior. Various sizes and styles.  
**Made to Order**  
LIGHT HAVANA/NEWMARKET color. SKU: BHC\_595

**Bennett's Hunter® Traveler's Organizer Case**  
Pigskin or Bridle Leather covered, Belgian linen lining with leather accent and trim interior, internal trays and pockets for organizing various sized items, pencils, pens, paper clips, leather file folders, and sleeves. Various sizes and styles.  
**Made to Order**  
LIGHT HAVANA/NEWMARKET color. SKU: BHC\_596



**Bennett's Hunter® Custom Sleigh Bell Strap** Buckle and billet strap ends, 5 solid brass cast and polished sleigh bells in the 7/8" or 1" diameter size

**Made to Order.**  
Designs vary, with customer's special requests considered. Light Havana/Newmarket or Black leather color.

SKU: BHC\_586  
Select Light Havana/Newmarket or Black leather color.

# Product Catalog: Chapter 3

## Jimmy Wiebe Memorial® Custom Bridles, Reins, and Martingales, Special Collections:

In memory of Jim's Dad, Jim Wiebe offers special collections under our exclusive trademark, *Jimmy Wiebe Memorial*®. These bridles are completely custom made by Jim in our Mississippi USA workshop, and only available from J. B. Wiebe III, LLC.

### Bridles:



**Jimmy Wiebe Memorial®**  
Jay Rene - JK/AAF™ sewn-in Pelham bridle with round noseband, Flat browband and cheeks, Flat Laced Reins, Flat Plain Curb Reins, and snaffle bit sewn-in. This bridle is stitched completely by hand. Made to measure.  
LIGHT HAVANA color.  
SKU: JWM\_001  
Photo by Lynn Earl Gola McLanahan



**Jimmy Wiebe Memorial®**  
JK/AAF™ sewn-in snaffle bridle Flat brow, 1/2 R F noseband, flat laced reins, snaffle bit sewn-in. LIGHT HAVANA color.  
SKU: JWM\_002

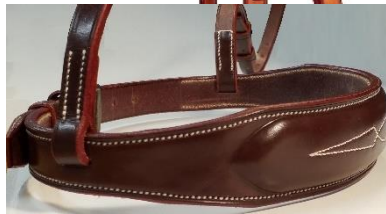

**Jimmy Wiebe Memorial®**  
JK/AAF™ sewn-in pelham bridle Flat brow, 1/2 R F noseband, flat snaffle reins with laced grips and flat curb reins with plain grips, sewn-in pelham bit. LIGHT HAVANA color.  
SKU: JWM\_003

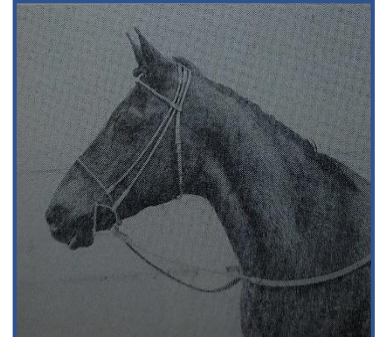

**Jimmy Wiebe Memorial®**  
**Round Bridle**  
Buckle billet bit attachment, round 5/8" laced grip snaffle reins, and round 1/2" plain grip curb reins with buckle billets.  
**This bridle is stitched completely by hand. Made to measure.**

**Custom Order Only**  
LIGHT HAVANA color.  
SKU: JWM\_004

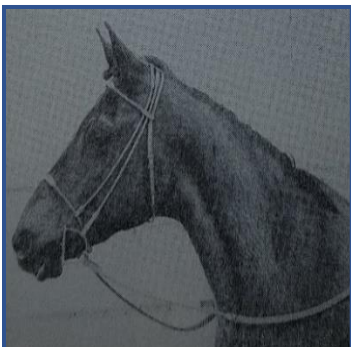

**Jimmy Wiebe Memorial®**  
**Round Bridle with 1/2 R F inserts in Noseband and Browband.**  
Buckle billets, includes round 5/8" laced grip snaffle reins and round 1/2" plain grip curb reins with buckle billets. This bridle is stitched completely by hand. Made to measure.  
LIGHT HAVANA color.  
SKU: JWM\_005



**Jimmy wiebe Memorial®**  
**The Stitcher™ Jumper Bridle**  
1/2 R F figure-8 noseband, flat browband, 5/8" or 3/4" round leather gag cheeks and slip head strap, 5/8" rubber grip reins with hook stud billets. Gag cheeks with sewn-in nylon rope inserts may be substituted for round leather gag cheeks for no additional charge. Includes Gag bit. LIGHT HAVANA color.  
SKU: JWM\_006



**Jimmy Wiebe Memorial®**  
**The Stitcher's Helper™ Jumper Hackamore Bridle**  
Round leather Hackamore noseband in jumper bridle, 3/4" cheeks split to two 3/8" sewn to hackamore round nose. Includes 5/8" or 3/4" rubber grip reins with hook stud billets, buckle closures, or 1" slip keeper closures.  
LIGHT HAVANA color.  
SKU: JWM\_007



**Jimmy Wiebe Memorial®**  
**Round Jumping Hackamore Noseband Attachment**  
Rings for use with Hook stud bridle. This bridle is stitched completely by hand. Made to measure.  
LIGHT HAVANA color.  
**3/4" Round Front.**  
SKU: JWM\_012  
**1" Round Front.**  
SKU: JWM\_013



**Jimmy Wiebe Memorial® Custom Bridles, Reins, and Martingales Special Collections:**

*Wiebe Heirloom Quality®* saddlery designed by Jimmy Wiebe, exclusively made to special custom order by Jim Wiebe in our J. B. Wiebe III, LLC workshop.

Made to order in our standard sizes or made to measure. These bridles are made and assembled in our Mississippi USA workshop by Jim Wiebe.

**Jimmy Wiebe Memorial® 1/2 Round Fancy Bridle**  
1-3/8" or 1-1/2" wide noseband



**Special CUSTOM ORDER ONLY, and made to measure.**

Includes one 1/2 Round Fancy Noseband, 1/2 Round Fancy Browband, Flat leather Crownpiece, 1 pair of Cheeks, and 1 pair of Full Cheek Keepers. Does not include bits or reins which are sold separately.

**Nut Brown color** is shown in the photos.

**Light Havana color** in the following standard sizes, or made to measure for an additional charge: Full Size [F], XFull Size [XF], and Oversize [O] or made to measure. The noseband in the photos is 1-1/2 inches wide.

**NUT BROWN**  
HORSE SIZES  
SKU: JWM\_605-H

**LIGHT HAVANA**  
HORSE SIZES  
SKU: JWM\_606-H

**Optional features:**

- 1/2 Round Fancy crownpiece for an additional charge.
- Personalized 1/2 Round Fancy Stitched crownpiece or noseband with name or monogram in center of fancy stitching for an additional charge.



**Jimmy Wiebe Memorial® 1/2 Round Fancy**  
noseband up to 1-1/4" wide



**Special CUSTOM ORDER ONLY, and made to measure.**

Includes noseband, browband, crownpiece, one pair of cheeks, and one pair of full cheek keepers. Does not include bit or reins which are sold separately.

Jimmy Wiebe first made this design especially for Junie Kulp and All Around Farm in 1961.

Stitching is 11 to 14 stitches per inch. The 1/2 round fancy stitched noseband has a pronounced 1/2 round front.

**LIGHT HAVANA**  
HORSE SIZES  
SKU: JWM\_607-H

**LIGHT HAVANA**  
PONY SIZES  
SKU: JWM\_607-P

Jimmy Wiebe's classic fancy stitching designs, with or without diamond center.

**Light Havana color** is shown in the photos.

**NUT BROWN**  
HORSE SIZES  
SKU: JWM\_608-H

**NUT BROWN**  
PONY SIZES  
SKU: JWM\_607-P



**Jimmy Wiebe Memorial® Custom Bridles, Reins, and Martingales, Special Collections:**

**Jimmy Wiebe Memorial® Custom Reins & Martingales**

Show hunter and jumper rein standard sizes: 36" Shetland [S], 38" Small Pony [SP], 41" Medium Pony [MP], 45" Large Pony [LP], 48" Cob [C], 51" XCob [XC], 54" Full Size [F], 57" XFull Size [XF], and 60" Warmblood [W]. Made in our J. B. Wiebe III, LLC workshop by Jim Wiebe. Reins and martingales may be made to measure.



**Jimmy Wiebe Memorial®**  
**½ Round Fancy Laced Reins**  
Standard Widths: 5/8", ¾"  
Custom Order Only  
LIGHT HAVANA color.  
  
Standard Lengths: 48, 51, 54"  
SKU: JWM\_653-42-54  
  
Longer Lengths 57", 60"  
SKU: JWM\_655-57-60



**Jimmy Wiebe Memorial®**  
**½ Round Fancy Laced Reins**  
Standard Widths: 5/8", ¾"  
Custom Order Only  
NUT BROWN color.  
  
Standard Lengths: 48, 51, 54"  
SKU: JWM\_654-42-54  
  
Longer Lengths 57", 60"  
SKU: JWM\_656-57-60



**Jimmy Wiebe Memorial®**  
**½ Round Fancy Standing Martingale**  
Custom Order Only  
LIGHT HAVANA color.  
  
SKU: JWM\_672

**Jimmy Wiebe Memorial®**  
**½ Round Fancy Standing Martingale**  
Custom Order Only  
NUT BROWN color (shown in photo).  
  
SKU: JWM\_673

## Product Catalog: Chapter 4

# Jimmy Wiebe's 20<sup>th</sup> Century<sup>®</sup> and 21<sup>st</sup> Century<sup>®</sup> Saddles:

In memory of Jim's Dad, Jim Wiebe offers these saddles as part of his *Jimmy Wiebe Memorial*<sup>®</sup> special collections. These saddles were imported by Jimmy Wiebe, and are only available from J. B. Wiebe III, LLC.



## 20<sup>th</sup> Century<sup>®</sup> and 21<sup>st</sup> Century<sup>®</sup> Close Contact Jumping Saddles

Made in England, and imported by Jimmy Wiebe. In stock and ready to ship

Seat sizes: 15 inch to 18 inch LIGHT HAVANA color.

20<sup>th</sup> Century<sup>®</sup> and 21<sup>st</sup> Century<sup>®</sup> Close Contact Jumping Saddles, designed and first introduced by Jimmy Wiebe in 1966, these saddles are light weight show jumping saddles, made on light exercise ply mold trees completely steel reinforced with hand forged recessed stirrup bars, 2-1/2 inch dip, rubber lined pigskin seats, solid butt skirts and flaps. Panels are lined with Plasticsote and covered with the finest English panel hide. Saddle billets are doubled Red Buffalo and Oak Bark leather sewn to the finest linen strain web.

Regular Flap, Seat Sizes: 15, 15-1/2, 16, 17, 18 inch

Deep Flap, Seat sizes: 15, 15-1/2, 16, 17-1/2 inch

These items are new unused genuine 20<sup>th</sup> Century<sup>®</sup> and 21<sup>st</sup> Century<sup>®</sup> saddles in mint condition and imported by Jimmy Wiebe. Offered as part of our *Jimmy Wiebe Memorial*<sup>®</sup> Special Collections, these are **special limited-edition** items, only available from J. B. Wiebe III, LLC.

A Regular Flap is for a rider with average hip-to-knee measurements.

A Deep Flap is for a rider with longer hip-to-knee measurements.

Custom balancing and fitting to your horse are available for an additional charge. Call Jim for custom fitting options.

All 20<sup>th</sup> Century<sup>®</sup> and 21<sup>st</sup> Century<sup>®</sup> Close Contact Jumping Saddles have a serial number in 1/2 inch numbers.

Only available from J. B. Wiebe III, LLC.

Regular Flap SKU: JWM\_2000RF Deep Flap SKU: JWM\_2000DF

# Jimmy Wiebe's 21<sup>st</sup> Century<sup>®</sup> Flapless Saddles:



## 21<sup>st</sup> Century<sup>®</sup> Flapless Close Contact Jumping Saddles

Designed and first introduced by Jimmy Wiebe in 1981, Jimmy's unique design eliminates the heavy inner sweat flap and other leather under the rider's leg in more traditional show jumping saddles and places the rider's leg much closer to the horse. The saddle design is balanced to place the rider over the horse's center of gravity, with foam lined seat for a very comfortable ride.

Color is **Light Havana/Newmarket** light brown seat and flaps, and **London** tan panels.

This saddle is a light weight show jumping saddle, made on a light exercise ply mold tree completely steel reinforced with hand forged recessed stirrup bars, 2-1/2 inch dip, rubber lined pigskin seat, solid butt skirt and flaps. Panels are lined with Plasticsote and covered with the finest English panel hide. Saddle billets are doubled Red Buffalo and Oak Bark leather sewn to the finest linen or nylon strain web.

Regular Flap is for riders with average hip-to-knee measurements.  
Deep Flap is for riders with longer hip-to-knee measurements.

This item is a new genuine 21<sup>st</sup> Century<sup>®</sup> saddle in mint condition and imported by Jimmy Wiebe. Offered as part of our **Jimmy Wiebe Memorial<sup>®</sup> Special Collections**, this is a **special limited edition** item, only available from **J. B. Wiebe III, LLC**.

All 21<sup>st</sup> Century<sup>®</sup> Flapless saddles have a serial number in 1/2 inch numbers.

Custom balancing and fitting to your horse may be available for an additional charge. Call Jim for custom fitting options.  
Only available from **J. B. Wiebe III, LLC**.

**Made in England, and imported by Jimmy Wiebe. LIGHT HAVANA color. In stock and ready to ship**

Seat Sizes: 16, 17 inch  
Regular Flap SKU: JWM\_2100RF      Deep Flap:  
JWM\_2100DF

## Jimmy Wiebe Memorial<sup>®</sup> Jumper Weight Pad

**For grand prix jumper and cross country endurance training.**

**2, 4, or 6 pockets to carry up to 60 Pounds of lead. Made to Order.**  
LIGHT HAVANA color.

**Made To Order**

2 forward pockets SKU: JWM\_008-2  
2 forward & 2 rear pockets SKU: JWM\_008-4  
6 pockets SKU: JWM\_008-6

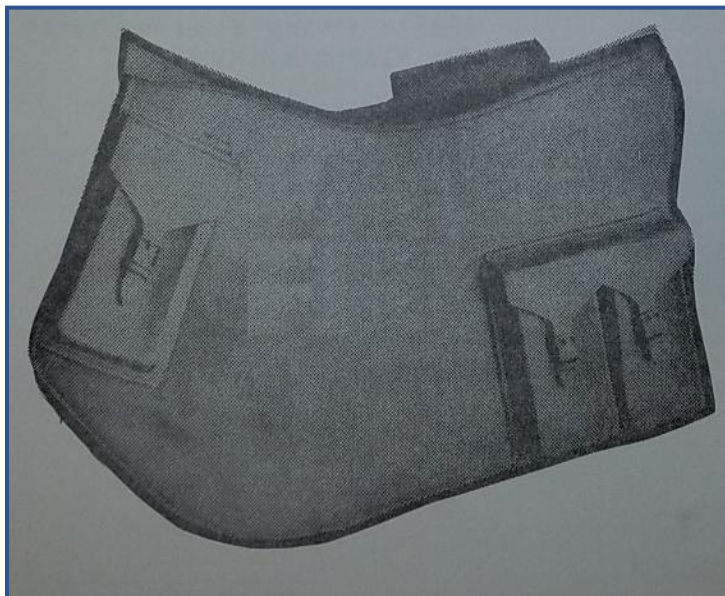

# Jimmy Wiebe's *21<sup>st</sup> Century*<sup>®</sup> Flapless Saddles:



## *21<sup>st</sup> Century Flapless*<sup>®</sup> Dressage Saddle

Designed and first introduced by Jimmy Wiebe in 1981, Jimmy's unique design eliminates the heavy inner sweat flap and other leather in more traditional dressage saddles and places the rider's leg much closer to the horse. The design includes a deep seat, round cantle, and knee rolls. The saddle design is balanced to place the rider over the horse's center of gravity, with a foam lined seat for a very comfortable ride. Color is black.

This item is a new genuine *21<sup>st</sup> Century*<sup>®</sup> saddle in mint condition, designed and imported by Jimmy Wiebe. Offered as part of our *Jimmy Wiebe Memorial*<sup>®</sup> Special Collections, this is a **special limited edition** item, only available from **J. B. Wiebe III, LLC**.

Custom balancing and fitting to your horse may be available for an additional charge. Call Jim for custom fitting options. All *21<sup>st</sup> Century*<sup>®</sup> Flapless saddles have a serial number in 1/2 inch numbers. Only available from **J. B. Wiebe III, LLC**.

**Made in England, and imported by Jimmy Wiebe. In stock and ready to ship**

Seat sizes: 15, 16, 17, and 18 inch. BLACK color. SKU: JWM 2001

## *21<sup>st</sup> Century*<sup>®</sup> Flapless Wonderland Dressage Saddle

**Made in England, and imported by Jimmy Wiebe. In stock and ready to ship**

Seat sizes: 16 and 17 inch BLACK color. SKU: JWM\_2101W

## Product Catalog: Chapter 5

# Bennett's Hunter<sup>®</sup> Custom Fine Bridles, Strap Goods, Saddlery, Horse Boots, and Training Aids:

Wiebe Heirloom Quality<sup>®</sup> saddlery designed by Jim Wiebe and exclusively manufactured, imported, and sold by J. B. Wiebe III, LLC.

## Bennett's Hunter<sup>®</sup> Custom Fine Bridles, Special Collections

Made to order in our standard sizes or made to measure, these bridles are made and assembled in our Mississippi USA workshop by Jim Wiebe.

### Bennett's Hunter<sup>®</sup> 1/2 Round Fancy Breastplate Style Bridle with Flat Brow Band



**Special CUSTOM ORDER ONLY, and made to measure.**

Includes noseband, browband, crownpiece, one pair of cheeks, and one pair of full cheek keepers. Does not include bit or reins which are sold separately.

Jim first made this design especially for Cynthia Williams and New England Farm when Jim was establishing the **Bennett's Hunter<sup>®</sup>** product line in the early 1980's.

All stitching is done by hand 11 to 14 stitches per inch. The 1/2 round fancy stitched breastplate style noseband has a very pronounced 1/2 round front in **Light Havana** or **Newmarket** light brown leather color with a **London** tan color panel hide padded backing.

**This bridle is stitched completely by hand.**  
SKU: BHC\_600

Same bridle, with a 1/2 Round Fancy Breastplate Style Browband:  
SKU: BHC\_601

### Bennett's Hunter<sup>®</sup> 1/2 Round Fancy Bridle 1-3/8" or 1-1/2" wide noseband, Nut Brown color



Includes one 1/2 Round Fancy Noseband, 1/2 Round Fancy Browband, Flat leather Crownpiece, 1 pair of Cheeks, and 1 pair of Full Cheek Keepers. Does not include bits or reins which are sold separately.

**Nut Brown** color shown in the photos is made to measure and **CUSTOM ORDER ONLY.**

**Light Havana** color in the following standard sizes, or made to measure for an additional charge: Full Size [F], XFull Size [XF], and Oversize [O] or made to measure. The noseband in the photos is 1-1/2 inches wide.

NUT BROWN  
SKU: BHC\_605

LIGHT HAVANA  
SKU: BHC\_606

**Optional features:**

- Can be made to measure for an additional charge quoted at time of order.
- 1/2 Round Fancy crownpiece for an additional charge.
- Personalized 1/2 Round Fancy Stitched crownpiece or noseband with name or monogram in center of fancy stitching for an additional charge.



# Bennett's Hunter® Custom Fine Bridles, Special Collections

Show hunter and jumper bridles **made to order**. Standard sizes: Small Shetland [SS], Shetland [S], Small Pony [SP], Medium Pony [MP], Large Pony [LP], Cob [C], XCob [XC], Full Size [F], XFull Size [XF], Over Size [O/S], and Warmblood [W], or made to measure. Figure 8 noseband bridle sizes: Full Size [F], XFull Size [XF], Over Size [O/S], and Warmblood [W], or made to measure. These bridles are made to order, completely custom, regardless of size.



**Bennett's Hunter®**  
**1/2 Round Fancy Bridle**  
 3/4 inch to 1-1/4 inch wide  
 noseband.  
 LIGHT HAVANA color.  
 SKU: BHC\_607



**Bennett's Hunter®**  
**1/2 Round Fancy Bridle**  
 3/4 inch to 1-1/4 inch wide  
 noseband.  
 NUT BROWN color.  
 SKU: BHC\_608



**Bennett's Hunter®**  
**1/2 Round Fancy Bridle**  
 1-3/4 inch Extra Wide  
 noseband.  
 LIGHT HAVANA color.  
 SKU: BHC\_609

NUT BROWN color:  
 SKU: BHC\_610



**Bennett's Hunter®**  
**1/2 Round Fancy Bridle**  
 Grakle Figure 8 noseband (no rings),  
 Dbl BP Ergonomic Crown.  
 LIGHT HAVANA color.  
 SKU: BHC\_614

Same with 1/2 Round Fancy Grakle  
 Figure 8 Noseband **with rings**:  
 SKU: BHC\_615



### **Bennett's Hunter® Bridle Details:**

Detail views of near side buckles, 1/2 Round Fancy noseband, hook studs, and full cheek keepers. Note the finely hand stitched details, keepers blocked square and cross-creased, and edges finished by hand. Fancy stitches are stitched completely by hand.



### **Bennett's Hunter® Bridle Options:**

Personalize a specially hand crafted custom 1/2 Round Fancy noseband or 1/2 Round Fancy crownpiece with a monogram, horse name, or show stable name.



**Bennett's Hunter®**  
**Double Stitched Breastplate Style  
 Bridle**

Bridle leather nose front up to 7/8"  
 width, panel hide backing up to  
 1-1/4 inch wide noseband.  
 LIGHT HAVANA color bridle  
 leather, London Tan backing.  
 SKU: BHC\_619

# Bennett's Hunter® Custom Fine Bridles, Special Collections

**Gag Bridles:** Made to Order, Standard sizes: Full Size [F], XFull Size [XF], Over Size [O/S], and Warmblood [W], or made to measure, these bridles are completely custom, regardless of size. When substituting alternative gag bits in these Gag Bridles, please request prices. Special customer requirements are welcome. We can specially design alternative gag bridles and other jumper show bridles. Please let us know your special needs and we will help you.

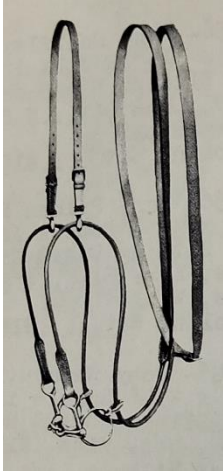

**Bennett's Hunter®** Special Collection  
Hitchcock Gag Bridle  
Hand stitched, round cheeks, pulleys, slip head strap, and Flat Plain Reins and Bit sewn-in. Browband and noseband sold separately. Custom Order Only  
LIGHT HAVANA color.  
SKU: BHC\_622

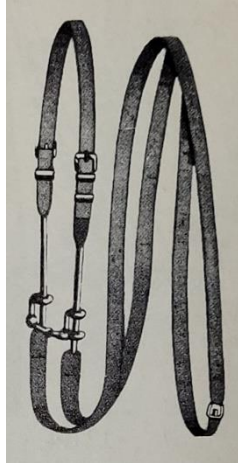

**Bennett's Hunter®** Special Collection  
Duncan Gag Bridle  
Hand stitched, round cheeks, slip head strap, and Flat Plain Reins and Bit sewn-in. Browband and noseband sold separately. Custom Order Only  
LIGHT HAVANA color.  
SKU: BHC\_623

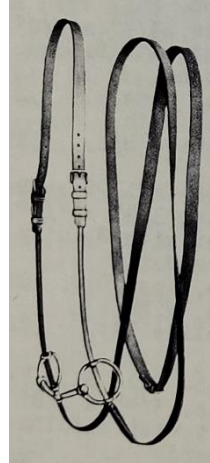

**Bennett's Hunter®** Special Collection  
Shrewsbury Gag Bridle  
Hand stitched, round cheeks, slip head strap, and Flat Plain Reins and Bit sewn-in. Browband and noseband sold separately. Custom Order Only  
LIGHT HAVANA color.  
SKU: BHC\_624

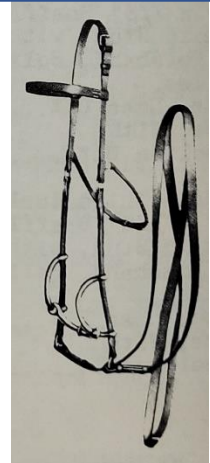

**Bennett's Hunter®** Special Collection  
Balding Gag Bridle  
Hand stitched, round cheeks adjust at poll, integral throat latch, Flat Plain Reins and Bit sewn-in, and Browband. Noseband sold separately. Custom Order Only  
LIGHT HAVANA color.  
SKU: BHC\_625

## Bennett's Hunter® Custom Flat Hunter Bridles and Round Racing Bridles:

Made to Order: Standard sizes - Cob [C], XCob [XC], Full Size [F], XFull Size [XF], and Over Size [O/S], Warmblood [W], or made to measure.



**Bennett's Hunter®** Special Collection  
Fine Flat Snaffle Bridle  
Hand stitched, includes ½" cheeks, crownpiece, ½" browband and noseband up to 1" wide. Reins and bit sold separately.  
LIGHT HAVANA color.  
SKU: BHC\_630



**Bennett's Hunter®** Special Collection  
Heavy Flat Snaffle Bridle  
Hand stitched, includes 5/8" or ¾" cheeks, crownpiece, 5/8" browband and noseband up to 1-1/2" wide. Reins and bit sold separately.  
LIGHT HAVANA color.  
SKU: BHC\_631



**Bennett's Hunter®** Special Collection  
Flat Sewn-in Full Bridle  
Hand stitched, includes cheeks, slip head, browband, noseband, plain reins and sewn-in Weymouth bit set. Custom Order Only  
LIGHT HAVANA or BLACK color.  
SKU: BHC\_633



**Bennett's Hunter®** Special Collection  
Round Racing Bridle  
Hand stitched, round headstall with buckle billet bit attachment, 1" wide Rubber Reins with wide slip keeper bit attachment, Racing Dee Bit, Chin strap, and Browband. Does not include noseband. Custom Order Only  
LIGHT HAVANA color.  
SKU: BHC\_634



# Bennett's Hunter<sup>®</sup> Custom Reins

Show hunter and jumper rein standard sizes: 36" Shetland [S], 38" Small Pony [SP], 41" Medium Pony [MP], 45" Large Pony [LP], 48" Cob [C], 51" XCob [XC], 54" Full Size [F], 57" XFull Size [XF], and 60" Warmblood [W]. Made in our J. B. Wiebe III, LLC workshop by Jim Wiebe, all reins are made to order. Wider widths and longer lengths for an additional charge.



**Bennett's Hunter<sup>®</sup>**  
Reins may be done to special order with buckle billet bit attachment.



**Bennett's Hunter<sup>®</sup>**  
Flat Plain Reins  
Standard Widths: 3/8", 1/2", 5/8"  
Hook stud or buckle bit attachment, buckle and point or hand stitched end at grips. Custom Order Only  
LIGHT HAVANA color.  
Standard Lengths: 42, 45, 48, 51, 54"  
SKU: BHC\_650-42-54  
Lengths 57", 60"  
SKU: BHC\_650-57-60



**Bennett's Hunter<sup>®</sup>**  
Flat Laced Reins  
Standard Widths: 5/8", 3/4"  
Custom Order Only  
LIGHT HAVANA color.  
Standard Lengths: 42, 45, 48, 51, 54"  
SKU: BHC\_651-42-54  
Lengths 57", 60"  
SKU: BHC\_651-57-60



**Bennett's Hunter<sup>®</sup>**  
1/2 Round Plain Laced Reins  
Standard Widths: 5/8", 3/4"  
Custom Order Only  
LIGHT HAVANA color.  
Standard Lengths: 42, 45, 48, 51, 54"  
SKU: BHC\_652-42-54  
Lengths 57", 60"  
SKU: BHC\_652-57-60



**Bennett's Hunter<sup>®</sup>**  
1/2 Round Fancy Laced Reins  
Standard Widths: 5/8", 3/4"  
Custom Order Only  
LIGHT HAVANA color.  
Standard Lengths: 42, 45, 48, 51, 54"  
SKU: BHC\_653-42-54  
NUT BROWN SKU: 654-42-54  
Lengths 57", 60"  
LIGHT HAVANA  
SKU: BHC\_655-57-60  
NUT BROWN SKU: BHC\_656-42-54



**Bennett's Hunter<sup>®</sup>**  
Flat Plaited Snaffle Reins  
Standard Widths: 5/8", 3/4"  
Custom Order Only  
LIGHT HAVANA color.  
Standard Lengths: 42, 45, 48, 51, 54"  
SKU: BHC\_657-42-54  
Lengths 57", 60"  
SKU: BHC\_657-57-60



**Bennett's Hunter<sup>®</sup>**  
Flat Plaited Narrow Curb Reins  
Standard Widths: 3/8", 1/2"  
Custom Order Only  
LIGHT HAVANA color.  
Standard Lengths: 42, 45, 48, 51, 54"  
SKU: BHC\_658-42-54  
Lengths 57", 60"  
SKU: BHC\_658-57-60



**Bennett's Hunter<sup>®</sup>**  
1/2 Round Plain Plaited Snaffle Reins  
Width at bit end: 5/8"  
Custom Order Only  
LIGHT HAVANA color.  
Standard Lengths: 42, 45, 48, 51, 54"  
SKU: BHC\_659-42-54  
Lengths 57", 60"  
SKU: BHC\_659-57-60



**Bennett's Hunter<sup>®</sup>**  
1/2 Round Fancy Plaited Snaffle Reins  
Width at bit end: 5/8"  
Custom Order Only  
LIGHT HAVANA color.  
Standard Lengths: 42, 45, 48, 51, 54"  
SKU: BHC\_660-42-54  
Lengths 57", 60"  
SKU: BHC\_660-57-60

# Bennett's Hunter® Custom Reins

Show hunter and jumper rein standard sizes: 36" Shetland [S], 38" Small Pony [SP], 41" Medium Pony [MP], 45" Large Pony [LP], 48" Cob [C], 51" XCob [XC], 54" Full Size [F], 57" XFull Size [XF], and 60" Warmblood [W]. Made in our J. B. Wiebe III, LLC workshop by Jim Wiebe, all our custom reins are made to order. Wider widths and longer lengths for an additional charge.



**Bennett's Hunter®**  
**Flat Rubber Reins**  
 Standard Widths: 5/8", 3/4"  
 Custom Order Only  
 LIGHT HAVANA color.  
 Grip colors: White, Brown, Red  
 Standard Lengths: 48, 51, 54"  
 SKU: BHC\_661-42-54  
 Lengths 57", 60"  
 SKU: BHC\_661-57-60

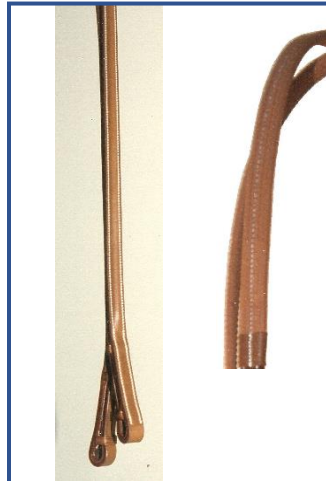

**Bennett's Hunter®**  
**1/2 Round Plain Rubber Reins**  
 Standard Widths: 5/8", 3/4"  
 Custom Order Only  
 LIGHT HAVANA color.  
 Grip colors: White, Brown, Red  
 Standard Lengths: 48, 51, 54"  
 SKU: BHC\_662-42-54  
 Lengths 57", 60"  
 SKU: BHC\_662-57-60

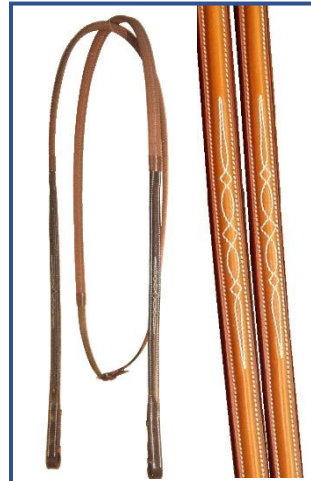

**Bennett's Hunter®**  
**1/2 Round Fancy Rubber Reins**  
 Standard Widths: 5/8", 3/4"  
 Custom Order Only  
 LIGHT HAVANA color.  
 Grip colors: White, Brown, Red  
 Standard Lengths: 48, 51, 54"  
 SKU: BHC\_663-42-54  
 Lengths 57", 60"  
 SKU: BHC\_663-57-60



**Bennett's Hunter®**  
**Flat Cotton Webb Reins**  
 Standard Widths: 5/8" or 3/4" at bit,  
 3/4" Webbing  
 Custom Order Only  
 LIGHT HAVANA color.  
 Grip color: Brown  
 Standard Lengths: 48, 51, 54"  
 SKU: BHC\_664-42-54  
 Lengths 57", 60"  
 SKU: BHC\_664-57-60



**Bennett's Hunter®**  
**1/2 Round Fancy Cotton Webb Reins**  
 1 ply or 2 ply web grips.  
 Standard Widths: 5/8" or 3/4" at bit,  
 3/4" Webbing. Martingale stops sold  
 separately. Custom Order Only  
 LIGHT HAVANA color.  
 Grip color: Brown  
 Standard Lengths: 48, 51, 54"  
 SKU: BHC\_665-42-54  
 Lengths 57", 60"  
 SKU: BHC\_665-57-60



**Bennett's Hunter®**  
**Flat Rubberized Webb Reins:**  
 1 ply or 2 ply web grips.  
 Standard Widths: 5/8" or 3/4" at bit, 3/4"  
 Webbing. Martingale stops sold  
 separately. Custom Order Only  
 LIGHT HAVANA color.  
 Grip color: Brown  
 Standard Lengths: 48, 51, 54"  
 SKU: BHC\_666-42-54  
 Lengths 57", 60"  
 SKU: BHC\_666-57-60



**Bennett's Hunter®**  
**1/2 Round Fancy Rubberized Webb  
 Reins:** 1 ply or 2 ply web grips.  
 Standard Widths: 5/8" or 3/4" at bit, 3/4"  
 Webbing. Martingale stops sold  
 separately. Custom Order Only  
 LIGHT HAVANA color.  
 Grip color: Brown  
 Standard Lengths: 48, 51, 54"  
 SKU: BHC\_667-42-54  
 Lengths 57", 60"  
 SKU: BHC\_667-57-60

**Bennett's Hunter® Rein Accessories:**  
**Bennett's Hunter® Reins:**  
**German Martingale Dees**  
 sewn-in to our Flat reins



3 dee rings per rein, between hook studs  
 and grips  
 Custom Order Only  
 SKU: BHC\_668

**Bennett's Hunter® Leather Running  
 Martingale Stops** for our reins:  
 Hand stitched, 1/2" width, pairs  
 Custom Order Only  
 SKU: BHC\_668

# Bennett's Hunter® Custom Martingales and Breastplates

Standing martingale standard sizes: Small Pony [SP], Medium Pony [MP], Large Pony [LP], Cob [C], XCob [XC], Full Size [F], XFull Size [XF], Over Size [O/S], and Warmblood [W]. Running martingale standard sizes: Full Size [F], XFull Size [XF], Over Size [O/S], and Warmblood [W]. All martingales are made to order and may be made to measure, wider widths and larger sizes for an additional charge. Hunt Breastplates, Show Breastplates, and Breastcollars are made to order.



**Bennett's Hunter®**  
Flat Standing Martingale  
LIGHT HAVANA color.  
SKU: BHC\_670

**Bennett's Hunter®**  
Standing Martingale Attachment  
LIGHT HAVANA color.  
Flat Leather:  
SKU: BHC\_674  
½ Round Plain:  
SKU: BHC\_675  
½ Round Fancy:  
SKU: BHC\_676



**Bennett's Hunter®**  
½ Round Plain Standing Martingale  
LIGHT HAVANA color.  
SKU: BHC\_671



**Bennett's Hunter®**  
½ Round Fancy Standing Martingale  
LIGHT HAVANA color.  
SKU: BHC\_672  
NUT BROWN  
SKU: BHC\_673

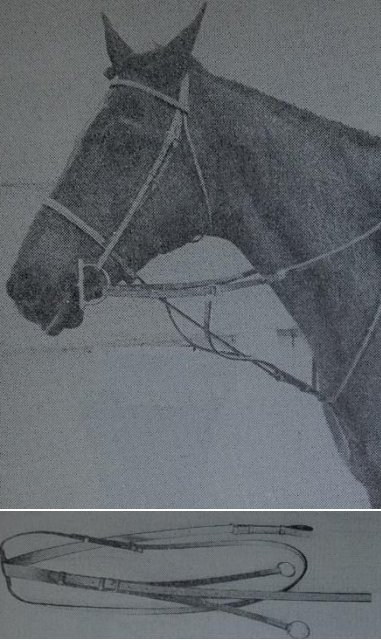

**Bennett's Hunter®**  
Flat Standing-Running Combination Martingale Custom Order Only  
LIGHT HAVANA color. SKU: BHC\_677



**Bennett's Hunter®**  
Flat Polo Martingale Custom Order Only  
LIGHT HAVANA color.  
SKU: BHC\_678



**Bennett's Hunter®**  
Flat Running Martingale  
LIGHT HAVANA color.  
SKU: BHC\_679  
NUT BROWN color.  
SKU: BHC\_680

**Bennett's Hunter®**  
½ Round Plain Running Martingale  
LIGHT HAVANA color.  
SKU: BHC\_681

**Bennett's Hunter®**  
½ Round Fancy Running Martingale  
LIGHT HAVANA color.  
SKU: BHC\_682  
NUT BROWN color.  
SKU: BHC\_683



**Bennett's Hunter®**  
Running Martingale Attachment  
LIGHT HAVANA color.  
Flat SKU: BHC\_684  
½ R P SKU: BHC\_685  
½ R F SKU: BHC\_686



**Bennett's Hunter®**  
Flat Bib Running Martingale Attachment Custom Order Only  
LIGHT HAVANA color.  
SKU: BHC\_687

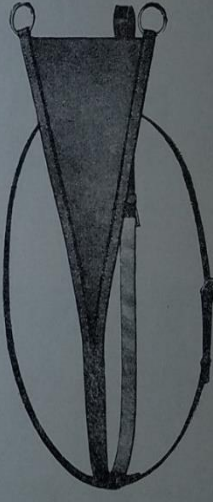

**Bennett's Hunter®**  
Flat Bib Running Martingale Custom Order Only  
LIGHT HAVANA color.  
SKU: BHC\_688



**Bennett's Hunter®**  
Flat Irish Martingale with throatlatch loop Custom Order Only  
LIGHT HAVANA color.  
SKU: BHC\_689



**Rubber Martingale Stop**  
BROWN color.  
SKU: JBW\_967



**Rubber Rein Stops**  
BROWN color.  
SKU: JBW\_967



**Bennett's Hunter®**  
German Martingale or Market Harbrough and Reins Set  
Includes martingale and rubber reins with 3 dees per rein LIGHT HAVANA color.  
SKU: BHC\_690

**Bennett's Hunter®**  
German Martingale less reins:  
SKU: BHC\_691

**Add 6 dees to a pair of Bennett's Hunter® reins (3 dees per rein)**  
SKU: BHC\_668

# Bennett's Hunter® Custom Martingales and Breastplates



**Bennett's Hunter®  
Drawrein Martingale  
Custom Order Only**  
LIGHT HAVANA color.  
SKU: BHC\_855

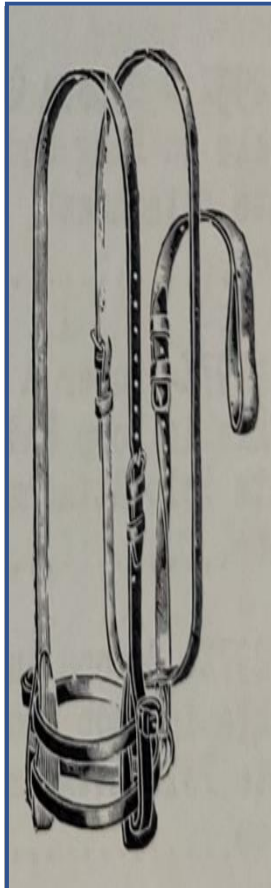

**Bennett's Hunter®  
Indian Martingale  
Custom Order Only**  
LIGHT HAVANA color.  
SKU: BHC\_690

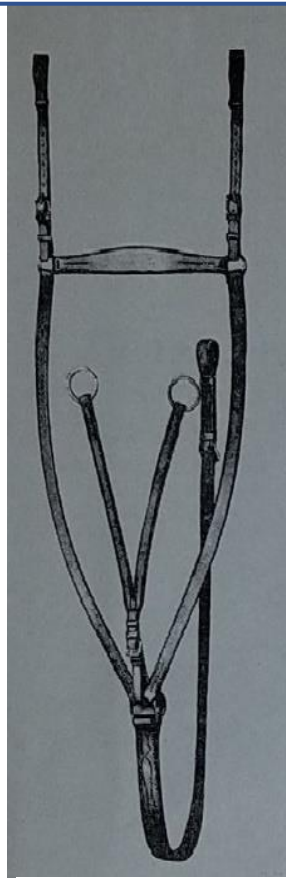

**Flat Hunt Breastplate**  
SKU: BHC\_694

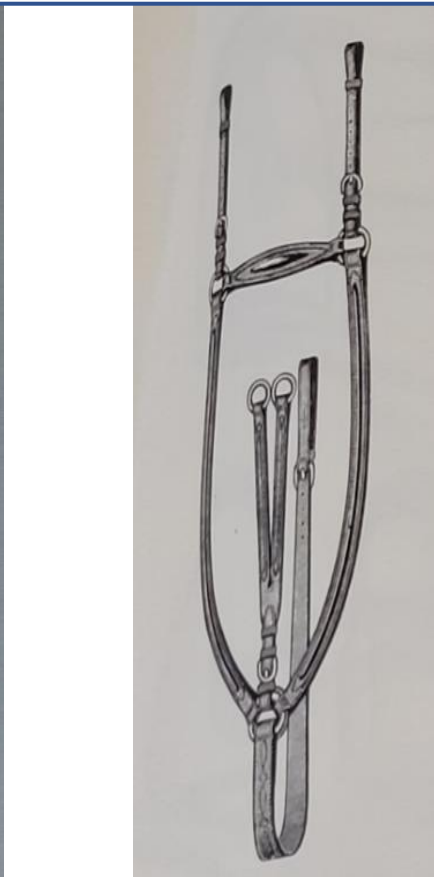

**1/2 Round Plain Hunt Breastplate**  
SKU: BHC\_695

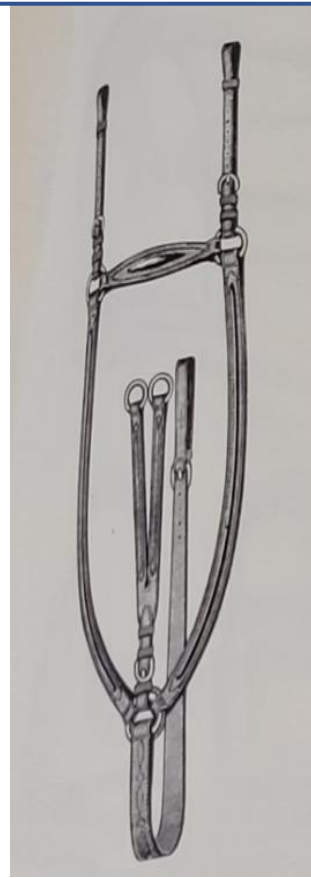

**1/2 Round Fancy Hunt Breastplate**  
SKU: BHC\_696

**Bennett's Hunter® Hunt Breastplates: Custom Order Only**  
LIGHT HAVANA color. Running Martingale Attachment sold separately  
LIGHT HAVANA color.

## **Bennett's Hunter® Custom Breastplate options:**

**Hunt Breastplate adjustable neck straps with buckles for an additional charge.**

LIGHT HAVANA color. SKU: BHC\_697

**Hunt Breastplate neck strap elastic inserts for an additional charge.**

LIGHT HAVANA color. SKU: BHC\_698

**Hunt Breastplate Whither Straps** LIGHT HAVANA color. SKU: BHC\_699

**Jumper Show Breastplate sheepskin fleece cover.**

LIGHT HAVANA color. SKU: BHC\_697

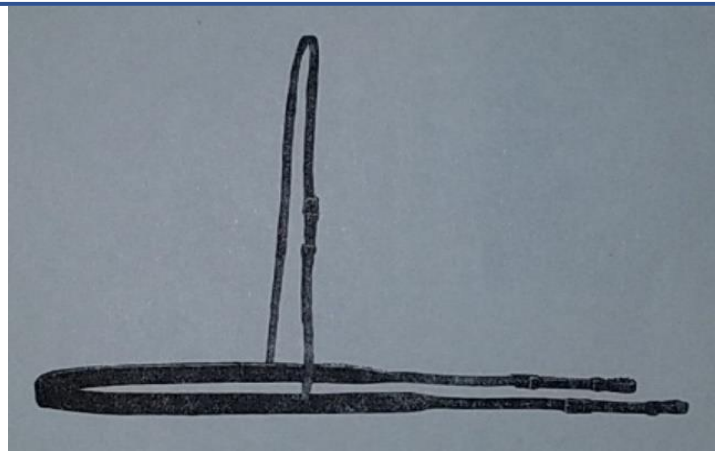

**Bennett's Hunter® Custom Flat Jumper Show Breastplate**  
LIGHT HAVANA color. SKU: BHC\_700

**Bennett's Hunter® Custom 1/2 Round Fancy Jumper Show Breastplate**  
LIGHT HAVANA color. SKU: BHC\_701

**Bennett's Hunter® Custom Flat Jumper Show Breastplate with 2" Elastic**  
LIGHT HAVANA color. SKU: BHC\_702

# Bennett's Hunter® Custom Girths and Stirrup Leathers



**Bennett's Hunter®**  
Atherstone Fitted Girth  
7/8" center strap,  
English baghide,  
Triple Elastic One End,  
Sizes: 36"-56"  
LIGHT HAVANA color.  
SKU: BHC\_720



**Bennett's Hunter®**  
Atherstone Fitted Girth:  
Wide fitted bridle  
leather overlay  
English baghide,  
Triple Elastic One End,  
Sizes: 36"-56"  
LIGHT HAVANA color.  
SKU: BHC\_722



**Bennett's Hunter®**  
Balding Girth  
Hand stitched, plain  
ends  
LIGHT HAVANA or  
BLACK color.  
CUSTOM ORDER  
ONLY  
4 buckles  
Sizes: 42"-56"  
SKU: BHC\_727\_4  
6 buckles  
Sizes: 42"-56"  
SKU: BHC\_727\_6



**Bennett's Hunter®**  
3-Fold Short Girth,  
for our Jimmy's 21<sup>st</sup>  
Century™ Flapless  
Close Contact  
Jumping Saddles  
and Dressage  
Saddles with long  
billets.  
Triple Elastic One  
End  
Sizes: 22"-30"  
LIGHT HAVANA  
color.  
SKU: BHC\_728



**Bennett's Hunter®**  
3-Fold Girth,  
English baghide,  
LIGHT HAVANA  
color. Plain Ends  
Sizes: 36"-54"  
SKU: BHC\_729



**Bennett's Hunter®**  
3-Fold Girth,  
Sizes: 36"-56"  
LIGHT HAVANA  
color. Triple Elastic  
One End, Sizes:  
36"-56"  
SKU: BHC\_730

**Bennett's Hunter®**  
Racing Surcingle: May also be used  
as an Overgirth with a jumping  
saddle. Webbing, hand stitched  
buckle and billet, made to measure.  
2 inch or 3 inch webbing.  
Without Elastic: SKU: BHC\_731  
With Elastic insert  
SKU: BHC\_732



**Bennett's Hunter®**  
Racing Girth:  
Webbing, hand  
stitched buckle and  
billet.  
Made to measure.  
2 inch or 3 inch  
webbing.  
CUSTOM ORDER  
ONLY  
Without Elastic:  
SKU: BHC\_735  
With Elastic insert  
SKU: BHC\_736



**Bennett's Hunter®**  
3-Fold Fitzwilliams Girth  
for Appointments & Ladies  
Side Saddle, 6 buckles, 4  
inches wide, made to  
measure, English baghide,  
Plain Ends  
Sizes: 42"-56"  
LIGHT HAVANA color.  
SKU: BHC\_739



**Bennett's Hunter®**  
Side Saddle Balance Girth  
for Ladies Side Saddle  
Two 1 inch barred girth  
buckles, English bridle  
leather, made to measure,  
up to 60" long x 1-3/4" or  
2" wide.  
LIGHT HAVANA color.  
SKU: BHC\_740

**Bennett's Hunter® 3-Fold Fitzwilliams Girth for Appointments & Ladies Side Saddle Set**  
6 buckles, 4 inches wide, made to measure,  
English baghide, Plain Ends. Sizes: 42"-56"  
LIGHT HAVANA color.  
SKU: BHC\_741



**Bennett's Hunter®** Racing Surcingle:  
May also be used as an Overgirth with a jumping saddle.  
2" Linen Straining Webbing or 3" Cotton Webbing.  
Hand stitched buckle and billet. CUSTOM ORDER  
ONLY  
Without Elastic: SKU: BHC\_733  
With Elastic insert  
SKU: BHC\_734



**Bennett's Hunter®** Racing Girth:  
Linen Straining Webbing or Tubular Cotton  
Webbing, hand stitched buckle and billet.  
CUSTOM ORDER ONLY  
Without Elastic: SKU: BHC\_737  
With Elastic insert  
SKU: BHC\_738



**Bennett's Hunter®** Oakbark Stirrup Leathers,  
4.8 – 5.0 MM English stirrup leather, triple stitched by hand.  
English Best Quality Nickel Alloy or Stainless Steel buckles.  
12 numbered holes. LIGHT HAVANA or NUT BROWN color.  
Custom Order Only  
3/4 X 36 (LEAD LINE) SKU: BHC\_750  
3/4 X 40 (SHORT STIRRUP) SKU: BHC\_751  
3/4 X 44 (JUNIORS) SKU: BHC\_752  
3/4 X 48 (LARGE JUNIORS) SKU: BHC\_753  
3/4 X 54 (Ladies) SKU: BHC\_755  
7/8 X 54 SKU: BHC\_756  
1 X 54 SKU: BHC\_757  
1 X 60 SKU: BHC\_758  
1-1/8 X 54, CUSTOM ORDER ONLY SKU: BHC\_759  
1-1/8 X 60, CUSTOM ORDER ONLY SKU: BHC\_760  
1-1/4 X 54, CUSTOM ORDER ONLY SKU: BHC\_761  
1-1/4 X 60, CUSTOM ORDER ONLY SKU: BHC\_762



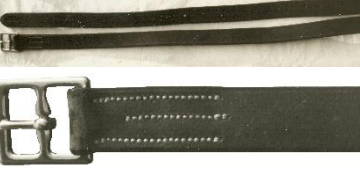

**Bennett's Hunter®** Saddle Billet Guards  
Protects saddle flap from girth buckle gouging.  
LIGHT HAVANA color.  
SKU: BHC\_742



**Bennett's Hunter®** Chrome Red Buffalo  
Stirrup Leathers,  
4.8 – 5.0 MM chrome tanned Red Buffalo  
leather, triple stitched by hand.  
English Best Quality Nickel Alloy or  
Stainless Steel buckles.  
12 numbered holes. DARK RED color.  
Custom Order Only  
3/4 X 54 (Ladies) SKU: BHC\_763  
1 X 54 SKU: BHC\_764  
1 X 60 SKU: BHC\_765

# Bennett's Hunter® Custom Horse Boots

Made to order in standard sizes. Custom patterns and sizes on request.

 <p><b>Bennett's Hunter® Open Front Shin Boots</b></p> <p>3 straps, panel hide, fleece, or felt lined.</p> <p>Sizes: M, L, XL LIGHT HAVANA color. SKU: BHC_770</p>	 <p><b>Bennett's Hunter® Open Front Shin Boots</b></p> <p>4 straps, panel hide, fleece, or felt lined.</p> <p>Size: O/S LIGHT HAVANA color. SKU: BHC_771</p>	 <p><b>Bennett's Hunter® Galloping Boots</b></p> <p>3 straps, panel hide, fleece, or felt lined</p> <p>Sizes: M, L, XL LIGHT HAVANA color. SKU: BHC_772</p>	 <p><b>Bennett's Hunter® Galloping Boots</b></p> <p>4 straps, panel hide, fleece, or felt lined.</p> <p>Size: O/S LIGHT HAVANA color. SKU: BHC_773</p>	
 <p><b>Bennett's Hunter® Ankle Boots, panel hide lined.</b></p> <p>Sizes: L, XL, O/S LIGHT HAVANA color. SKU: BHC_774</p>	 <p><b>Bennett's Hunter® Ankle Boots</b> Fleece or box cloth felt lined.</p> <p>Sizes: L, XL, O/S (sizes 3, 4, 5) LIGHT HAVANA color. SKU: BHC_775</p>	 <p><b>Bennett's Hunter® Yorkshire Boots, Ankle Cuffs</b> Box cloth/felt Webbing strap tie closure</p> <p>SKU: BHC_776</p>	 <p><b>Bennett's Hunter® Polo Boots, Wool felt,</b></p> <p>3-straps with elastic. Size: M SKU: BHC_778</p> <p>4-straps with elastic. Size: L, XL, O/S SKU: BHC_779</p>	 <p><b>Bennett's Hunter® Polo Boots</b> Wool felt with leather ankle cap.</p> <p>3-straps with elastic. Size: M SKU: BHC_780</p> <p>4-straps with elastic. Size: L, XL, O/S SKU: BHC_781</p>
 <p><b>Bennett's Hunter® Knee Cap Boots</b></p> <p>Box cloth felt lined, with leather cap and outer shell, 2 straps, no elastic</p> <p>SKU: BHC_782</p>	 <p><b>Bennett's Hunter® Front Shin and Ankle Boot</b></p> <p>Box cloth, with leather cap 3-straps, Sizes: M, L SKU: BHC_784</p> <p>4-strap, Sizes: XL, OS SKU: BHC_785</p>	 <p><b>Bennett's Hunter® Hind Boots</b> panel hide, fleece, box cloth, or felt lined, baghide outer shell</p> <p>3-strap, Sizes: M, L SKU: BHC_788</p> <p>4-strap, Sizes: XL, O/S SKU: BHC_789</p>	 <p><b>Bennett's Hunter® Hind Shin and Ankle Boot with Heel Extension</b></p> <p>Boxcloth or panel hide lined, bridle leather cap, and straps, buckles with elastic.</p> <p>3-straps with elastic Size: M, L SKU: BHC_792</p> <p>4-strap with elastic Size: XL, O/S SKU: BHC_793</p>	 <p><b>Bennett's Hunter® Heavy Hock Shipping Boots</b> 3 straps.</p> <p>SKU: BHC_794</p>
 <p><b>Bennett's Hunter® Knee Cap Boots</b></p> <p>Box cloth lined, with leather cap and outer shell, 2 straps, with elastic</p> <p>LIGHT HAVANA color. SKU: BHC_783</p>	 <p><b>Bennett's Hunter® Front Shin and Ankle Boot</b> Box cloth or panel hide lining, with bridle leather cap</p> <p>3-straps with elastic, Sizes: M, L SKU: BHC_786</p> <p>4-strap with elastic, Sizes: XL, OS SKU: BHC_787</p>	 <p><b>Bennett's Hunter® Hock Boots</b> 3 straps.</p> <p>SKU: BHC_791</p>	 <p><b>Bennett's Hunter® Heavy Hock Shipping Boots</b> 3 straps.</p> <p>SKU: BHC_794</p>	

# Bennett's Hunter® Custom Halters and Lead Shanks



**Bennett's Hunter®**  
**½ Round Fancy Show Halter**  
 Includes 3 letter hand stitched monogram on nose front. 1/2 round fancy nose front, cheeks, and crown, rolled throat, S.B. hardware  
 SKU: BHC\_800



**Bennett's Hunter®**  
**½ Round Fancy Slip Show Halter**  
 1/2 Round Fancy stitched nose front, double stitched cheek and head strap over poll, adjustable chin strap, no throat or offside cheek, S.B. hardware  
 SKU: BHC\_801  
 Nameplate sold separately.

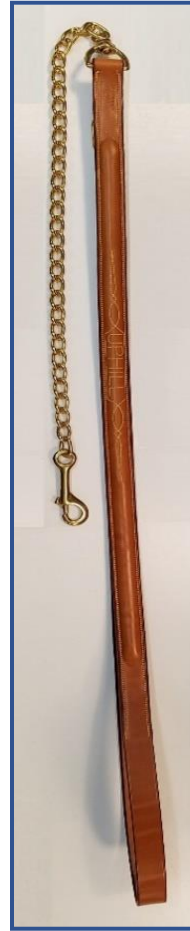

**Bennett's Hunter®**  
**½ Round Fancy Horse Lead Shank**  
 1 snap, S.B. Chain, Buckle  
 3/4 X 72 finished leather length unbuckled.  
 SKU: BHC\_805  
 1 X 72 finished leather length unbuckled  
 SKU: BHC\_807  
 Hand stitched monogram, show stable name, or groom's name in center of fancy stitching for an additional charge.

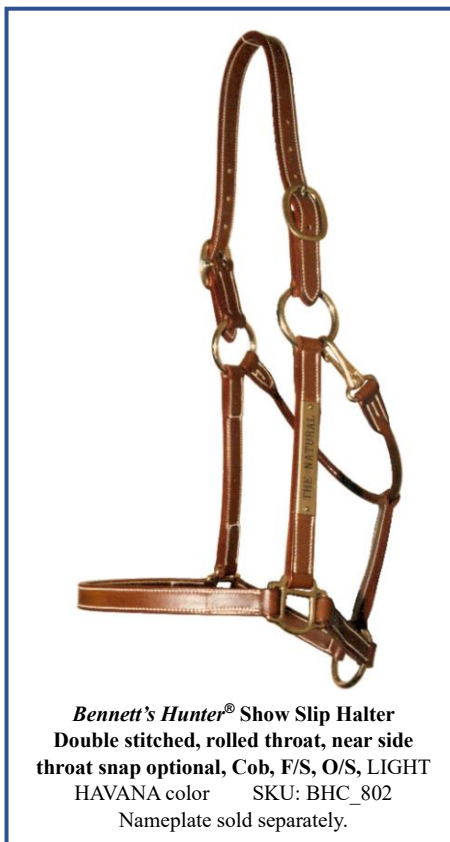

**Bennett's Hunter® Show Slip Halter**  
 Double stitched, rolled throat, near side throat snap optional, Cob, F/S, O/S, LIGHT HAVANA color  
 SKU: BHC\_802  
 Nameplate sold separately.



**English Shipping Halter**  
 Triple stitched mostly by hand  
 Cob, F/S, O/S, LIGHT HAVANA color  
 SKU: JBW\_803



**Bennett's Hunter® Foal Halter**  
 Stitched by hand, Foal size  
 LIGHT HAVANA color.  
 SKU: BHC\_804



**Bennett's Hunter®**  
**Flat Pony Lead Shank - 1 snap, S.B.**  
 Chain, 3/4 X 66 finished leather length (no buckle)  
 SKU: 42BHC\_805

**Bennett's Hunter®**  
**Flat Horse Lead Shank - 1 snap, S.B.**  
 Chain, 1 X 66 finished leather length (no buckle)  
 SKU: BHC\_806



**Bennett's Hunter®**  
**Flat Pony Lead Shank - 1 snap, S.B. Chain, Buckle,**  
 3/4 X 72 finished leather length unbuckled.  
 SKU: BHC\_811

**Bennett's Hunter®**  
**Flat Horse Lead Shank - 1 snap, S.B. Chain, Buckle,**  
 1 X 72 finished leather length unbuckled.  
 SKU: BHC\_812

# Bennett's Hunter® Custom Training Aids: Biting Rigs and Harnesses



## **Bennett's Hunter® Biting Roller**

Cu-Ni/SST hardware, Light Havana bridle leather color is standard. Back pad panel lining is London Tan panel hide. Specify either Pony-XCob or XCob-O/S Horse.  
SKU: BHC\_820



## **Bennett's Hunter® Complete Biting Rig**

Cu-Ni/SST Hardware. Training Bridle with overcheck rings at poll (DeGogue Rollers for an additional charge) with buckles bit attachment, Sidecheck, Biting Roller (surcingle), Crupper, and Side Reins. Specify size Pony/Xcob or XCob-O/S Horse. Light Havana bridle leather color. Back pad panel lining is London Tan panel hide.  
SKU: BHC\_822

<p><b>Bennett's Hunter®</b> Biting Harness Training Bridle Custom Order Only SKU: BHC_824</p>	<p><b>Bennett's Hunter®</b> Biting Harness Sidecheck Includes Chambon Crown with rings, Cu-Ni/SST hardware Custom Order Only SKU: BHC_828</p>
<p><b>Bennett's Hunter®</b> Biting Harness Side Reins Double elastic, 3/4 width, Cu-Ni/SST hardware Custom Order Only SKU: BHC_826</p>	<p><b>Bennett's Hunter®</b> Biting Harness Crupper Cu-Ni/SST hardware. Custom Order Only SKU: BHC_830</p>

Specify either Pony-XCob or XCob-O/S Horse.

**Bennett's Hunter®**  
**Hock Hobble Harness:**  
Cu-Ni/SST hardware, webbing roller/backpad with straps and pulleys to run hobble lines through and dee rings at center of backpad for crupper attachment. 2 fleece covered hobbles, crupper, and two 9 ft Hock-to-Bit Nylon braided cord lines with safety snaps both ends.  
Does NOT include training bridle.  
**Complete training harness**  
SKU: BHC\_834

**2 Fleece Covered Hobbles**  
SKU: BHC\_834\_A

**Bennett's Hunter®**  
**Hock Hobbles and Roller:**  
Cu-Ni/SST hardware, webbing roller/backpad, 2 fleece covered hobbles, and two 9 ft Hock-to-Bit Nylon braided cord lines with safety snaps both ends.  
Does NOT include crupper or training bridle

**Hock Hobbles with roller and lines only**  
SKU: BHC\_835



# Bennett's Hunter<sup>®</sup> Custom Training Aids: Rollers and Harness Parts

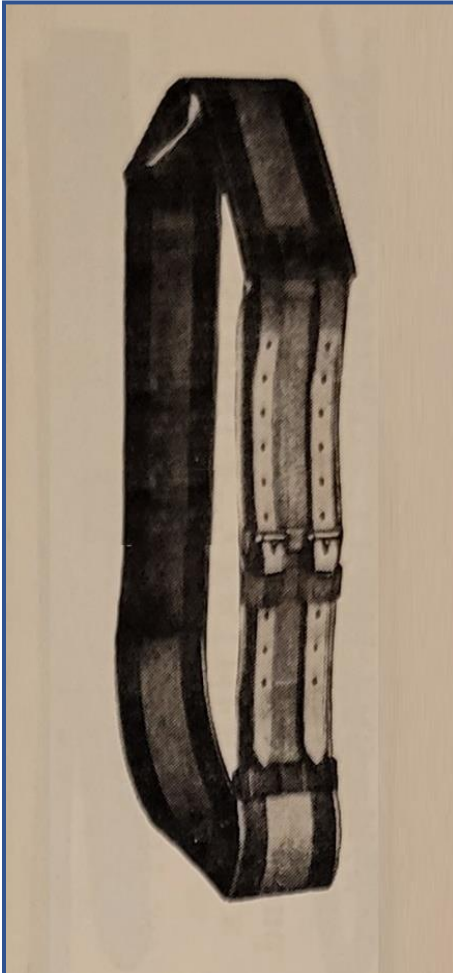

### **Bennett's Hunter<sup>®</sup> Box Pad Roller**

4" White Cotton Webbing  
NP/SST hardware, Light Havana and Newmarket leather color is standard. Box pad panel linings are London Tan panel hide and cotton webbing or cotton-linen duck canvas.

Sizes: Pony-Cob [P-C] or Full-Over Size-Warmblood [F-O-W]  
MADE TO ORDER

2-Strap SKU: BHC\_836  
4-Strap SKU: BHC\_837

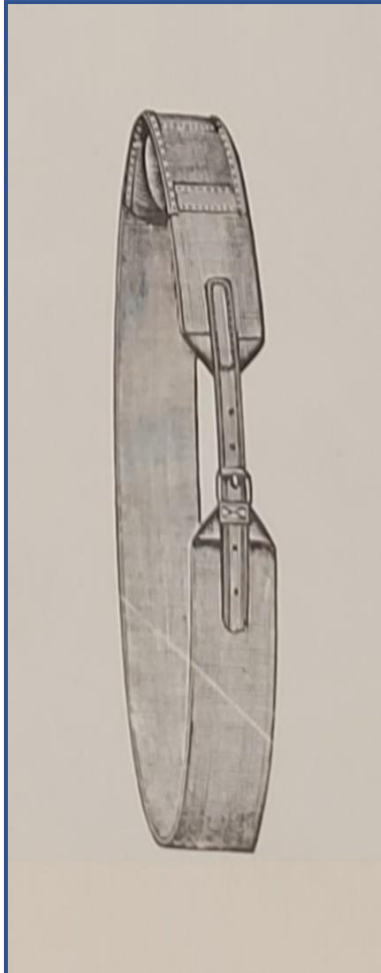

### **Bennett's Hunter<sup>®</sup> Surcingle**

3" White Cotton Webbing, 1 Strap  
NP/SST hardware, Light Havana and Newmarket leather color is standard. Box pad panel linings are London Tan panel hide and cotton webbing or cotton-linen duck canvas.

Sizes: Pony [P], Cob [C], Full [F], Over Size [O/S], Warmblood [W]  
MADE TO ORDER

1-Strap SKU: BHC\_838

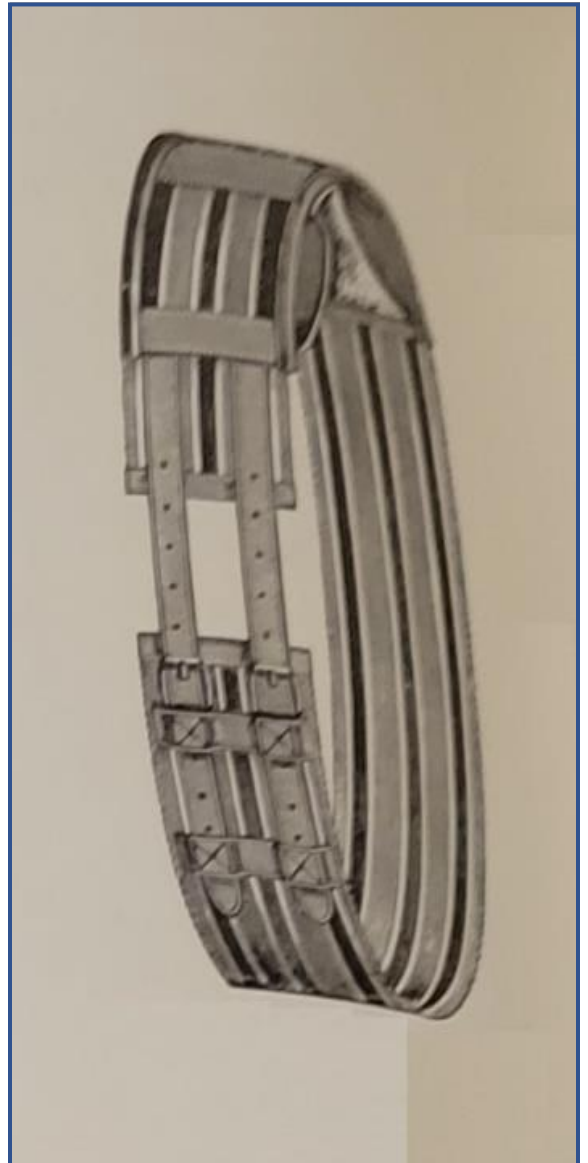

### **Box Pad Roller:**

2 Straps, 5" Woven Webbing  
Schooling Quality, NP Hardware.

Size: Full [F]. Unbranded, stock item  
SKU: BHC\_839

# Bennett's Hunter<sup>®</sup> Custom Training Aids



**Bennett's Hunter<sup>®</sup> Carlburg Mouching Tackle**  
Cu-Ni/SST hardware, webbing straps

SKU: BHC\_840



**Bennett's Hunter<sup>®</sup> Chambon Buckle-on Crown**  
Cu-Ni/SST hardware, rings at poll (DeGogue Rollers available for an additional charge)

SKU: BHC\_841



**Bennett's Hunter<sup>®</sup> Training Yoke**

Cu-Ni/SST hardware, for Martingale Attachment, Snap Draw Reins, Chambon, or De Gogue

SKU: BHC\_842

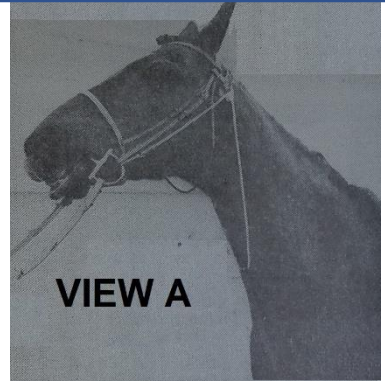

**VIEW A**

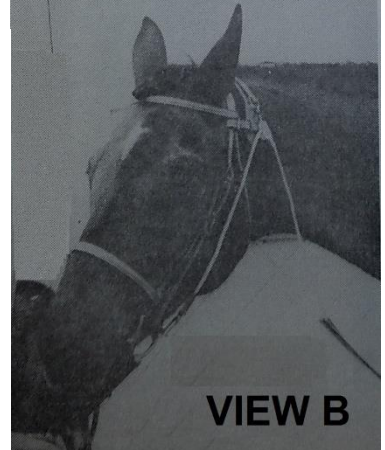

**VIEW B**



**VIEW A**

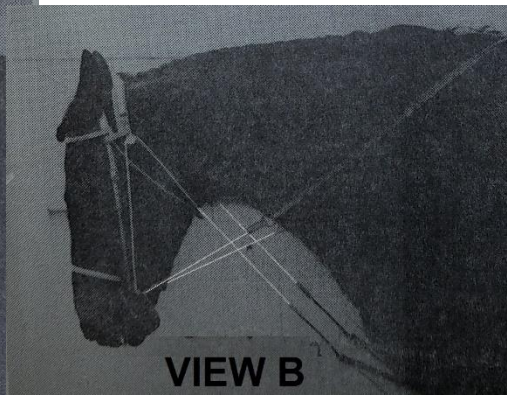

**VIEW B**

**Bennett's Hunter<sup>®</sup> DeGogue Training Aid**  
with buckle-on chambon crown with rings  
(DeGogue Rollers available for an additional charge)

SKU: BHC\_843

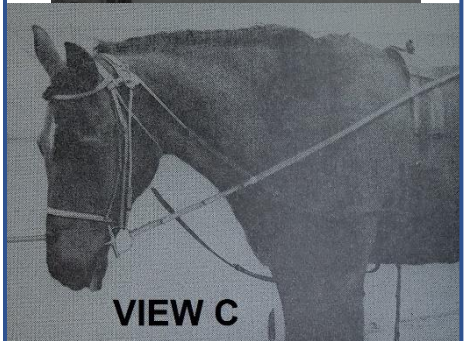

**VIEW C**

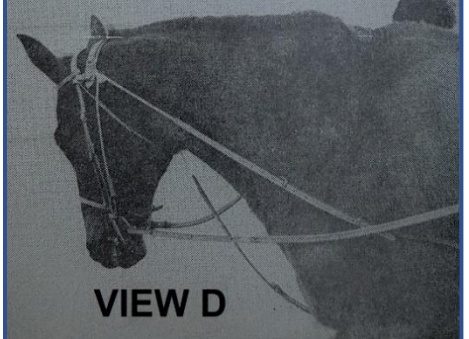

**VIEW D**

**Bennett's Hunter<sup>®</sup> Chambon Training Aid**  
with buckle-on chambon crown with rings  
(DeGogue Rollers available for an additional charge)

SKU: BHC\_844

# Bennett's Hunter® Custom Training Aids

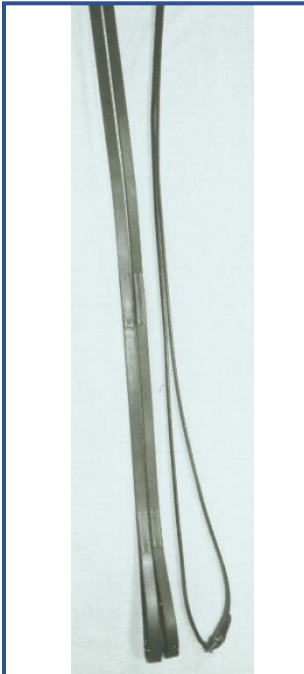

**Bennett's Hunter® Draw Reins -**  
Flat, closed loops, prs.  
Cu-Ni/SST hardware  
1/2" X 9 ft, SKU: BHC\_847  
5/8" X 9 ft, SKU: BHC\_848

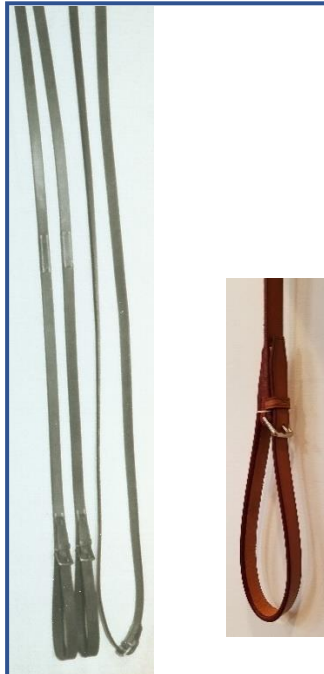

**Bennett's Hunter® Draw Reins -**  
Flat, buckle billets, prs.  
Cu-Ni/SST hardware  
1/2" X 9 ft, SKU: BHC\_849  
5/8" X 9 ft, SKU: BHC\_850

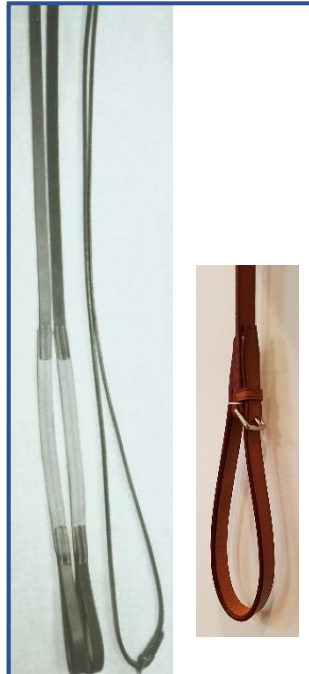

**Bennett's Hunter® Draw Reins -**  
Flat, Draw Reins - flat, dbl elastic,  
5/8" X 9 ft, buckle billets, prs.  
Cu-Ni/SST hardware  
SKU: BHC\_853

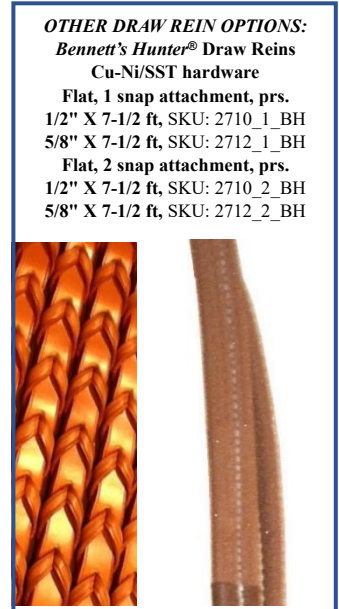

**OTHER DRAW REIN OPTIONS:**  
**Bennett's Hunter® Draw Reins**  
Cu-Ni/SST hardware  
Flat, 1 snap attachment, prs.  
1/2" X 7-1/2 ft, SKU: 2710\_1\_BH  
5/8" X 7-1/2 ft, SKU: 2712\_1\_BH  
Flat, 2 snap attachment, prs.  
1/2" X 7-1/2 ft, SKU: 2710\_2\_BH  
5/8" X 7-1/2 ft, SKU: 2712\_2\_BH

**Bennett's Hunter® Draw Reins**  
Add laced grips or rubber grips to  
5/8" wide draw reins, 28" to 30"  
long grips start 8" from buckle end  
of grips.  
Cu-Ni/SST hardware,  
Custom Order Only  
SKU: BHC\_854



**Bennett's Hunter®**  
**Draw Rein Martingale**  
Flat leather, 1" belly split  
to two 1/2" flat leather  
plain grips X 9 ft overall  
with martingale adjustment  
at the belly end, 1/2" flat  
neck strap with additional  
holes for more adjustment.

Fits our standard X Cob to  
O/S sizes.

**Cu-Ni/SST hardware,**  
**Custom Order Only**  
SKU: BHC\_855

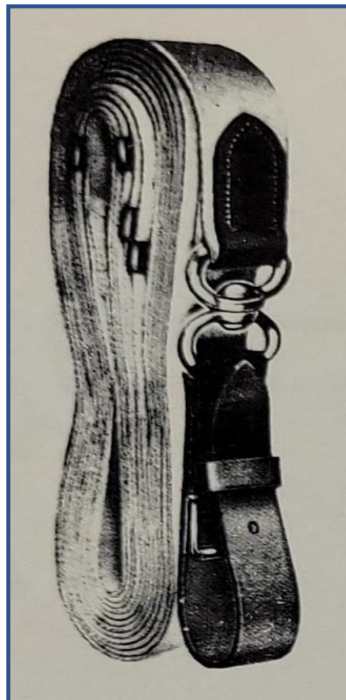

**Bennett's Hunter®**  
**Lunge Line**  
Cotton tubular web, 25 ft,  
Schooling Quality  
Nickel alloy/SST hardware

SKU: BHC\_856

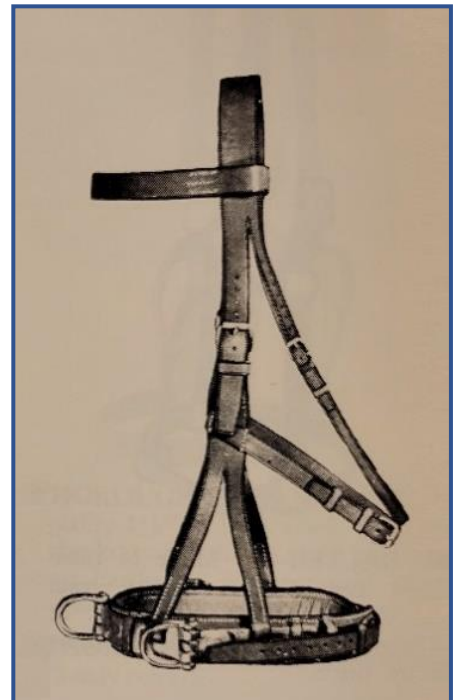

**Bennett's Hunter®**  
**Breaking or Lunging Halter**  
Flexible padded nose with hinged steel  
reinforcement and dee rings.  
Schooling Quality

SKU: BHC\_857

# Bennett's Hunter® Custom Bridle Parts

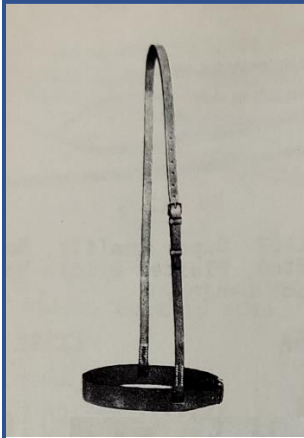

**Bennett's Hunter®  
Noseband - Flat cavesson**

Sizes: SS, S, SP, MP, LP, Cob, XCob, Full, XFull, O/S, W, or Made To Measure

LIGHT HAVANA color.

SKU: BHC\_920

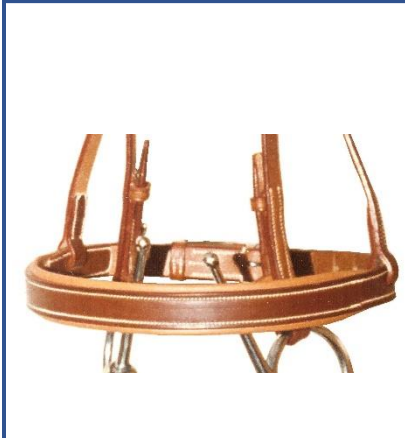

**Bennett's Hunter® Noseband  
Double Stitched Breastplate Style**

Sizes: Cob, Full, XFull, O/S, W, or Made To Measure

LIGHT HAVANA

SKU: BHC\_921



**Bennett's Hunter®  
Noseband - 1/2 Round Plain  
up to 1-1/4 wide**

Sizes: SS, S, SP, MP, LP, Cob, XCob, Full, XFull, O/S, W, or Made To Measure

LIGHT HAVANA color.

SKU: BHC\_922



**Bennett's Hunter® Noseband  
1/2 Round Fancy up to 1-1/4 wide**

Sizes: SS, S, SP, MP, LP, Cob, XCob, Full, XFull, O/S, W, or Made To Measure

LIGHT HAVANA

SKU: BHC\_923



**Bennett's Hunter® Noseband 1/2 Round Fancy  
1-3/8 to 1-1/2 wide, Made To Measure**

LIGHT HAVANA SKU: BHC\_926-LH



NUT BROWN SKU: BHC\_926-LH



Add sewn in Rivets to any of our 1/2 Round or Breastplate Style nosebands.

**Made To Measure**

Sewn into noseband: SKU: BHC\_924\_SI

Removable from noseband: SKU: BHC\_924\_RMV



Add sewn in Chain to any of our 1/2 Round or Breastplate Style nosebands.

**Made To Measure**

Sewn into noseband: SKU: BHC\_925\_SI

Removable from noseband: SKU: BHC\_925\_RMV



**Bennett's Hunter® 1/2 Round Fancy Noseband  
with Jimmy Wiebe's Continuous Crank Chin**

Up to 1-1/4 wide, Made To Measure

LIGHT HAVANA SKU: BHC\_929-LH

NUT BROWN SKU: BHC\_929-BH

1-3/8 to 1-1/2 wide, Made To Measure

LIGHT HAVANA SKU: BHC\_930-LH

NUT BROWN SKU: BHC\_930-NB

# Bennett's Hunter® Custom Bridle Parts



**Bennett's Hunter®**

**Kinton Noseband**

1" nose front, 1/2" head/cheek.  
Triple-adjustable, one size.

**Made To Order**  
LIGHT HAVANA color.  
SKU: BHC\_931

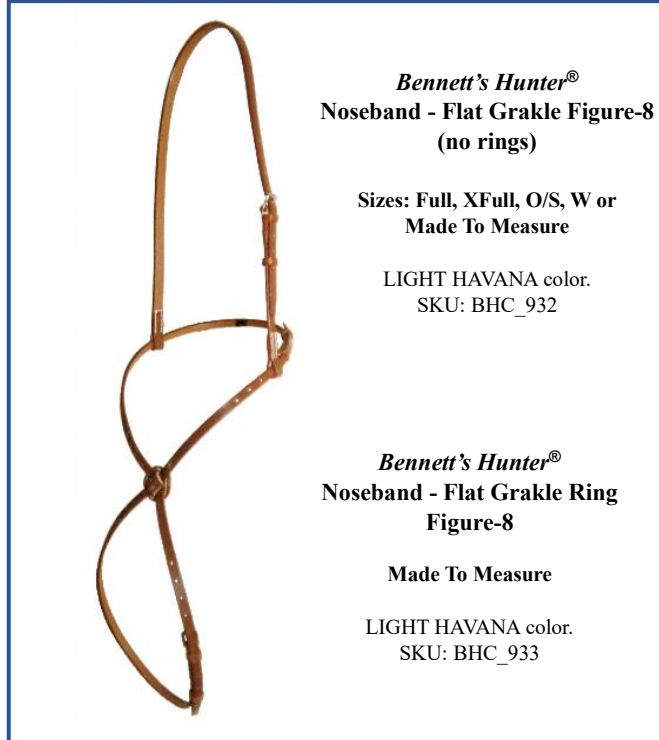

**Bennett's Hunter®**  
**Noseband - Flat Grakle Figure-8**  
(no rings)

Sizes: Full, XFull, O/S, W or  
Made To Measure

LIGHT HAVANA color.  
SKU: BHC\_932

**Bennett's Hunter®**  
**Noseband - Flat Grakle Ring**  
**Figure-8**

**Made To Measure**

LIGHT HAVANA color.  
SKU: BHC\_933



**Bennett's Hunter®**  
**Noseband - 1/2 Round Plain**  
**Grakle Ring Figure-8**

**Made To Measure**  
LIGHT HAVANA color.  
SKU: BHC\_934

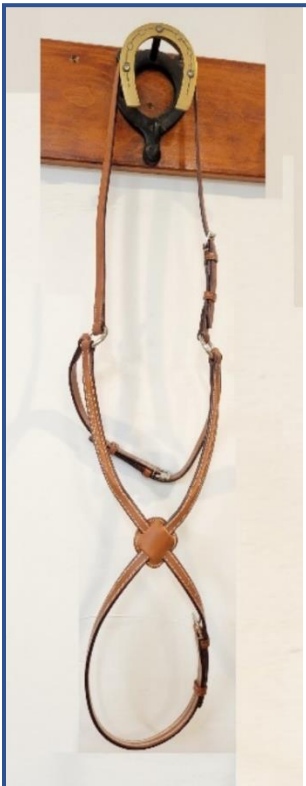

**Bennett's Hunter®**  
**Noseband - 1/2**  
**Round Fancy Grakle Ring Figure-8**

**Made To Measure**  
LIGHT HAVANA color.  
SKU: BHC\_935



**Bennett's Hunter®**  
**Noseband - Flat Drop**  
**Attachment**

Sizes: Full, XFull, O/S

LIGHT HAVANA color.  
SKU: BHC\_936



**Bennett's Hunter®**  
**Noseband - Flat Flash**  
**Attachment**

Sizes: Full, XFull, O/S  
Made To Order

LIGHT HAVANA color.  
SKU: BHC\_937



**Bennett's Hunter®**  
**Browband - Flat, sizes: SS, S, SP,**  
**MP, LP, Cob, XCob, Full, XFull,**  
**O/S, W, or Made To Measure**  
LIGHT HAVANA color.  
SKU: BHC\_938

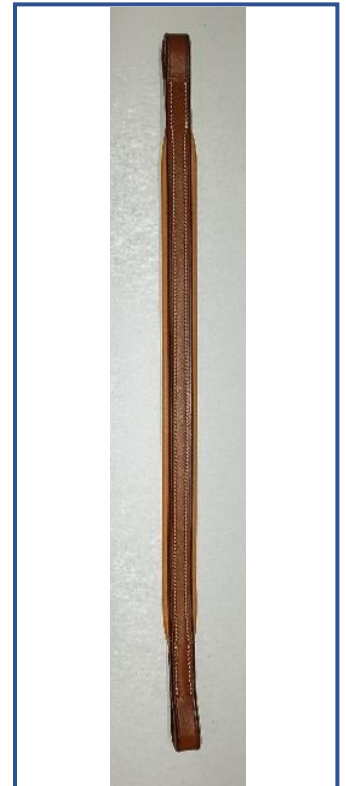

**Bennett's Hunter®**  
**Browband - Double Stitched**  
**Breastplate Style**  
Sizes: Cob, Full, XFull, O/S, W, or  
**Made To Measure**  
SKU: BHC\_939

# Bennett's Hunter® Custom Bridle Parts



**Bennett's Hunter® Browband**  
½ Round Plain

Sizes: SS, S, SP, MP, LP, Cob, XCob, Full, XFull, O/S, W, or Made To Measure  
LIGHT HAVANA  
SKU: BHC\_940



**Bennett's Hunter® Browband**  
½ Round Fancy

Sizes: SS, S, SP, MP, LP, Cob, XCob, Full, XFull, O/S, W, or Made To Measure  
LIGHT HAVANA  
SKU: BHC\_941



**Bennett's Hunter® Crownpiece – Flat**

Sizes: SS, S, SP, MP, LP, Cob, Xcob, Full, XFull, O/S, W, or Made To Measure

LIGHT HAVANA SKU: BHC\_942



**Bennett's Hunter® Crownpiece**  
½ Round Fancy

Made To Measure  
LIGHT HAVANA SKU: BHC\_943

**Bennett's Hunter® Bridle Option:**

Personalize a specially hand crafted custom ½ Round Fancy noseband or ½ Round Fancy crownpiece with a monogram, horse name, or show stable name.

1 – 4 letters, priced per letter:  
SKU: BHC\_120\_04

5 – 7 letters, SKU: BHC\_120\_07  
8 – 10 letters, SKU: BHC\_120\_10  
11 – 14 letters, SKU: BHC\_120\_14  
(maximum 14 letters)



8" X 1/2"  
9" X 1/2"  
10" X 1/2"  
11" X 1/2"

**Bennett's Hunter® Cheeks:**

flat leather, hook stud billets.  
per pair, widths: 1/2", 5/8",  
lengths: 6" through 11-1/2" in 1/2"  
increments. 3/4" x 10", 3/4" x 11".

LIGHT HAVANA SKU: BHC\_944

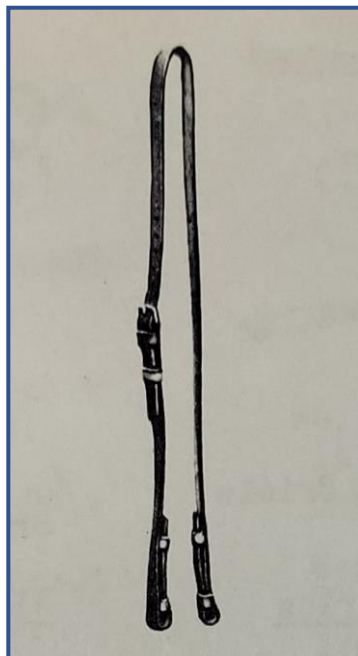

**Bennett's Hunter® Slip Head**  
**Weymouth Full Bridle:**  
with hook stud billets

LIGHT HAVANA SKU: BHC\_945

**Bennett's Hunter® Gag Round Cheeks: Made To Order**  
Rolled leather, 5/8" or 3/4" buckles, sewn-in to gag bit with rings to attach to reins, bits sold separately. Standard finished length 15"  
LIGHT HAVANA SKU: BHC\_947

**Bennett's Hunter® Gag Cheeks**  
Braided nylon cord inserts, 5/8" or 3/4" buckles, sewn-in to gag bit, bits sold separately. Standard finished length 15"  
LIGHT HAVANA color SKU: BHC\_948

**Bennett's Hunter® Gag Slip Head Strap**  
5/8" or 3/4" width, holes and points both ends, for attaching Gag Round Cheeks in a Gag Bridle, XCob, Full, XFull, O/S, W  
LIGHT HAVANA SKU: BHC\_949

**Bennett's Hunter® Bridle, Auxiliary Headstall:**  
Crownpiece, 1 pair cheeks, and browband. Flat leather.  
LIGHT HAVANA SKU: BHC\_950

**Bennett's Hunter® Snaffle to Gag Cheeks and Reins Converter Set**  
5/8" or 3/4" width, with Laced or Rubber Grips, converts a loose ring, full cheek, or Dee snaffle bridle to a Gag Bridle. Made To Order  
LIGHT HAVANA SKU: BHC\_951

**Bennett's Hunter® Snaffle to Gag Cheek and Rubberized Webb Reins Converter Set**  
5/8" or 3/4" width, with Rubberized Cotton Webb Grips, converts a loose ring, full cheek, or Dee snaffle bridle to a Gag Bridle, Made To Order  
LIGHT HAVANA SKU: BHC\_952

# Bit, Stirrup, and Spur Accessories:



**Bennett's Hunter® Full Cheek Keepers**  
Hand stitched in J. B. Wiebe III, LLC Workshop, per pair  
LIGHT HAVANA SKU: BHC\_953



**Bennett's Hunter® Bit Lip Strap, flat leather**  
LIGHT HAVANA SKU: BHC\_954



**Bennett's Hunter® Lip Strap, Round leather**  
LIGHT HAVANA SKU: BHC\_955

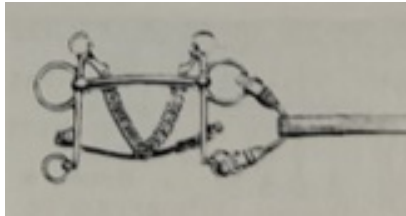

**Bennett's Hunter® Pelham Bit Converters: Round Leather**  
LIGHT HAVANA SKU: BHC\_956



**Bennett's Hunter® Balancing Bit Curb Rounds, LIGHT HAVANA**  
SKU: BHC\_956A-CurbRnds



**Bennett's Hunter® Curb Chain, Leather** SKU: BHC\_957



**Bennett's Hunter® Curb Strap, Leather, 1/2" width** SKU: BHC\_958

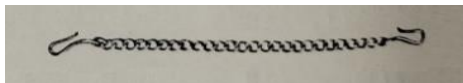

**Lip Chain, spring hook ends** SKU: JBW\_960

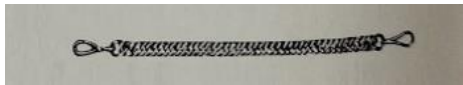

**Lip Chain, snap ends** SKU: JBW\_961

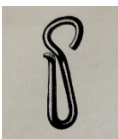

**Curb Hooks, Spring Pattern, pair**  
SKU: JBW\_962



**Stout Polo Curb Hooks pair**  
SKU: JBW\_963



**Curb Chain**

**Stainless Steel or Kangaroo® Best Quality Cupro-Nickle Alloy:**  
Longer length SKU: JBW\_959 Shorter length SKU: JBW\_964



**Jodphur Curb Riser with single links**  
SKU: JBW\_965



**Jodphur Curb Riser, 6 links each side**  
SKU: JBW\_966

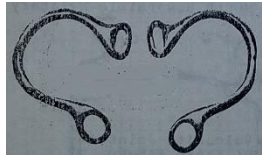

**Kineton Loops, per pair**  
SKU: JBW\_967



**Rubber Rein Stops: per pair**  
Brown color SKU: JBW\_968



**Rubber Bit Guards: per pair**  
brown color SKU: JBW\_969



**Leather Bit Burr: each**  
SKU: JBW\_970



**Tongue Grid, SKU: JBW\_971**



**Butterfly Clip Bit, SKU: JBW\_972**



**Burn Overcheck, SKU: JBW\_973**

**Stirrup Pads: White rubber, plain, SKU: JBW\_974**  
**White rubber - abrasive pad inserts, SKU: JBW\_975**  
**Black rubber - plain, SKU: JBW\_976**

**Bennett's Hunter® Custom Spur Straps, 3/8", 1/2", 5/8", Child, Ladies, Men's sizes, slide keeper and center bar spur strap buckle, Black or Brown**  
SKU: BHC\_977

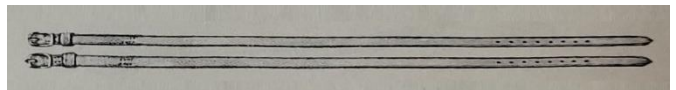

**Bennett's Hunter® Jodphur Straps, Childs, Ladies, and Gents sizes**  
SKU: BHC\_978



# Product Catalog: Chapter 6

## Farm and Show Stable Tools and Supplies:

Farm and Show Stable Tools and Supplies manufactured, imported, and sold by J. B. Wiebe III, LLC.



**Fiebing's Yellow Paste Saddle Soap**  
3.5 Oz  
SKU: JBW\_1000

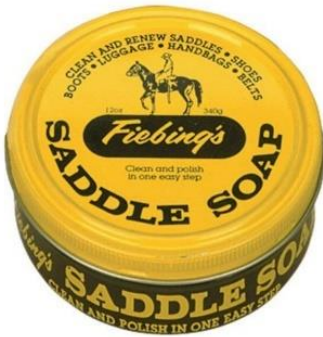

**Fiebing's Yellow Paste Saddle Soap**  
12 Oz  
SKU: JBW\_1001



**Neatfoot Oil Compound**

1 Pint  
SKU: JBW\_1003

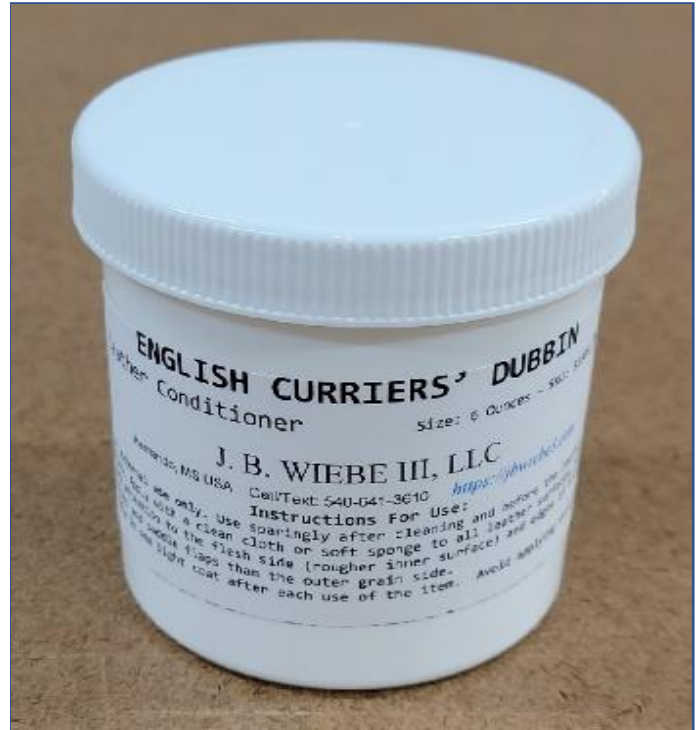

**J. B. Wiebe III, LLC English Currier's Dubbin - Leather Care Conditioner**

A mixture of natural animal tallows and beeswax for the conditioning of our fine English bridle leather.

**Small size (approximately 6 Oz)**  
SKU: JBW\_1008

**Medium size (approximately 8 Oz)**  
SKU: JBW\_1009



**John Heffner's English Bridle Leather Cleaner**

A proprietary formulation for the cleaning of our fine English bridle leather. This special leather cleaner is specifically for restoring old bridle leather. It cleans and removes dirt and built up old saddle soap from our fine English bridle leather. It will brighten old stitching to an off-white light yellow color and help restore old dry leather.

**Medium size (approximately 6 Oz)**  
SKU: JBW\_1011



**Wenol Metal Polish Paste - tube**  
SKU: JBW\_1013

**Metal Polish wadding**

**Medium size can**  
SKU: JBW\_1014

**Large size can**  
SKU: JBW1015



# Farm and Show Stable Tools and Supplies:

Farm and Show Stable Tools and Supplies manufactured, imported, and sold by J. B. Wiebe III, LLC.

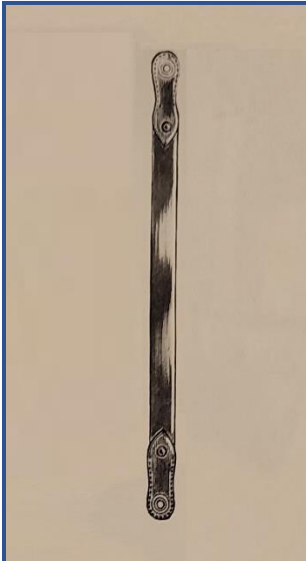

**Bennett's Hunter® Sweat Scraper**  
Spring brass, with leather handles and grommet. Made in our workshop. Best quality.

SKU: BHC\_1027



**6 Tube Rotary Hole Punch**  
Forged steel, best quality

SKU: JBW\_1028



**Hoof Pick**  
Aluminum

SKU: JBW\_1030

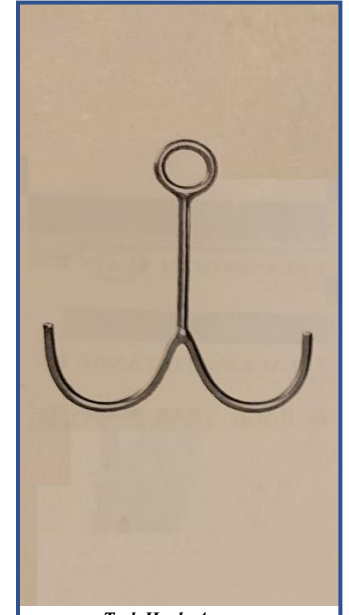

**Tack Hook: 4 prong**  
SKU: JBW\_1033

**Tack Hook: 2 prong (shown above)**  
SKU: JBW\_1034

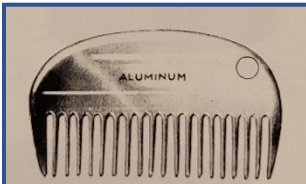

**Mane Comb, Aluminum**  
SKU: JBW\_1035



**Pulling Comb, Aluminum**  
SKU: JBW\_1036



**Braider's Needle**  
Extra Large size - for braiding show horse manes, Quantity of 2  
SKU: JBW\_1037



**Braider's Thread, Irish/English linen**  
Black color, 50 gram spool  
SKU: JBW\_1038



**Braider's Thread, Irish/English linen**  
Natural White color, 50 gram spool  
SKU: JBW\_1039

# APPENDICES

## **Retail Business Policies:**

In general, our business policies for accepting orders, terms of payment, fulfilling orders, returns, and credits for returns are as follows, subject to change without notice.

1. We reserve the right to refuse to sell to someone at our sole discretion. In 2022, we found it necessary to add this to our business policies due to what we saw as a breakdown in civility in social media and other forms of electronic communications, including instant messages, emails, and social media posts.

We work very hard to present our products professionally and invest a great deal of time, work, and cost in creating our finest custom work. We simply do not have the bandwidth to deal with excessive drama or unprofessional behavior. To keep our business sustainable, we cannot tolerate business policy noncompliance or conflicts of interest.

Violation of our business policies, problems with timely payment of invoices, hostile communications or social media posts directed toward our company, employees, or managers, and conflicts of interest such as brand ambassadors representing competitor products and individuals with ownership interests in competitor saddlery businesses may result in denial of purchasing privileges.

This is similar to the "Right To Work" philosophy, common standards of professional behavior, and general conflict of interest provisions seen in businesses in the USA. Customers get to choose where they buy products and sellers get to choose whom they will sell to, as permitted by law.

We offer our products for sale to all individuals in good standing with our company based on our interactions with them, their compliance with our business policies, and where there is no known conflict of interest.

**2. Special Orders, Items Made-To-Order, and other Special Custom Orders:** Items Made-To-Order regardless of size, items specially custom Made-To-Measure, and items with a hand stitched monogram or name or otherwise personalized with nameplates or tags including our **Bennett's Hunter®** and **Jimmy Wiebe Memorial®** items, and some **20th Century® Custom** items are Final Sale and require full payment to place the order. Once paid, these orders are final and cannot be canceled except by J. B. Wiebe III, LLC.

We may estimate an approximate delivery date when we send an invoice for payment. **Estimated dates are not guaranteed.** We try to complete orders as promptly as possible, but we always put quality first and this takes time. Special or Custom orders may take longer than expected, sometimes significantly longer than expected. We guarantee the quality of our custom work, but we do not guarantee delivery dates on items Made-To-Order in our workshop.

**Once the customer agrees to our Made-To-Order item policies, terms, and conditions, and payment is accepted by J. B. Wiebe III, LLC, the order cannot be canceled by the customer and payment will not be refunded.**

**3. Stock item orders:** Orders for items we have in stock prior to order that are not discounted, or on sale as part of a special promotion may be returned for a store credit provided the item(s) returned are in new saleable condition and are not oiled, stained, conditioned, used, blemished by handling, or damaged in any way. Stock items altered in size, oiled, conditioned, blemished, or used cannot be returned and are final sale.

Stock items may be exchanged for alternative Stock items of same or lesser value provided returned parts are in new saleable condition and are not oiled, stained, used, blemished by handling, or damaged in any way. This allows a near custom fit at a stock size price which is lower than our special custom made-to-order, made-to-measure, or monogrammed personalized item pricing.

We charge return shipping and handling. We do not charge a restocking fee for accepted returns and exchanges. Other charges may apply.

**4. Returns, Store Credits, and Refunds:** Returned items are subject to our own receipt inspection before we will accept them for a store credit.

### **We do not give refunds.**

If an item is verified by us to be defective in materials or workmanship, we may, at our sole discretion, opt to repair or replace a defective item or give a store credit once we confirm the returned item is defective. Rejected returns will be returned to the customer upon receipt of customer's payment of return shipping and handling charges.

**5. Stock Items that have been altered in size, oiled, stained, conditioned, blemished by handling, or otherwise used cannot be returned.**

**6. We are an internet based business** located in northwest Mississippi near Memphis, Tennessee. We collect 7% sales tax for all items delivered to addresses in Mississippi.

We do not maintain a "brick and mortar" store for face-to-face retail selling. We may elect to display and sell our products at horse shows, trade shows, and other public facing events in the USA. Otherwise, all of our business is conducted by internet, cell phone, or USPS mail.

**7. Shipping methods and responsibilities:** We do not pay transportation charges because we cannot be responsible for goods that are in shipment and out of our hands. We insure goods for full value for our customer's protection. Shipments may require a signature by the customer at time of delivery. The customer is responsible for ensuring their availability to securely receive and sign for packages and for the accuracy of their shipping address.

FedEx Ground and UPS Ground are our usual methods of delivery. We may ship by DHL or USPS First Class Parcel Post. **We only ship to addresses in the continental USA.** Our average shipping and handling charge in early 2024 for a bridle, reins, and martingale was \$35.00 to \$40.00 (this may change). Rush shipping charges by FedEx, UPS, and other carriers can be significantly higher. Shipping charges are not credited or refundable to the customer once an order is paid. The customer is responsible for paying shipping charges to and from J. B. Wiebe III, LLC.

**8. Special orders:** We can make personalized products with monograms and custom sizing made to measure. We can also make special designs on request. Special orders cannot be canceled once paid and payments accepted by J. B. Wiebe III, LLC will not be refunded.

**9. Website and online catalog:** <https://jbwiebe3.com/shop/>

**10. FaceBook pages:**

- a. [www.facebook.com/jbwiebe3](http://www.facebook.com/jbwiebe3)
- b. [www.facebook.com/FineBridle](http://www.facebook.com/FineBridle)
- c. [www.facebook.com/Jimmys20thCentury](http://www.facebook.com/Jimmys20thCentury)
- d. [www.facebook.com/Jimmys21stCentury](http://www.facebook.com/Jimmys21stCentury)

**11. How to place an order and pay:**

An order may be initiated using the SHOP page on our website (see link above). Otherwise, to place an order, contact us via email to [FineBridle@aol.com](mailto:FineBridle@aol.com). We may provide measuring instructions and ask for measurements to determine sizes. When we have sufficient information to price the order, we will request payment and provide an estimated delivery date. To complete placing the order, send payment by bank check, cashier's check, bank draft, or postal money order. Paying the order secures a place in our order book. We do not start work on orders until they are paid.

We accept bank checks, cashier's checks, bank drafts, and postal money orders.

- We do not accept orders for C.O.D. delivery.
- Orders are dated when paid and usually completed and shipped in the order paid.
- We do not offer a rush service for a higher price.
- We do not offer in-store credit accounts or "open accounts" to customers.
- We do not sell wholesale to other saddlery businesses or tack shops. We only sell retail directly to individuals and equestrian show stables/farms. To avoid delays when ordering, except for payments by show stable or farm bank checks, please do not pay using a saddlery business check or Tack Shop business check.

**Bank checks and money orders:**

Before paying by bank check, cashier's check, bank draft, and postal money order, please confirm the total amount due with us by email to [FineBridle@aol.com](mailto:FineBridle@aol.com)

Please make checks and money orders payable in US Dollars (\$) to:

**J. B. Wiebe III, LLC**  
429 E. Commerce St., #112  
Hernando, MS 38632

## Agreement:

Customer Agrees to all terms and conditions as stated in the policies above. Customer is purchasing for their own use and agrees not to resell J. B. Wiebe III, LLC's products through any other wholesale or retail business.

Customer understands and agrees that:

- Orders cannot be cancelled once paid and that payment(s) are non-refundable.
- Delivery dates and estimated lead times may change and are not guaranteed.

Customer's Name (printed): \_\_\_\_\_ Customer's Signature: \_\_\_\_\_

Date signed: \_\_\_\_\_

**Ship to:**

Name: \_\_\_\_\_

Street: \_\_\_\_\_

City: \_\_\_\_\_ State: \_\_\_\_\_ Zipcode: \_\_\_\_\_

cell: \_\_\_\_ - \_\_\_\_ - \_\_\_\_\_ Email: \_\_\_\_\_

**How to pay:**

**Please pay by bank check, cashier's check, bank draft, or postal money order:**

Please make your check, draft, or money order payable to:

**J. B. Wiebe III, LLC**  
429 E. Commerce Street, St. #112  
Hernando, MS 38632  
Email: [FineBridle@aol.com](mailto:FineBridle@aol.com)

See our business policies on page 3 and page 4 below.

Thank you for the order.

Sincerely,

*Jim Wiebe*

Managing Director, J. B. Wiebe III, LLC

List your order below, one item per row. Catalog numbers and descriptions are listed in Jim's Wiebe Illustrated Guide.

Prices are listed in our online catalog at <https://jbiebe3.com/shop/>

Catalog Number	Item Description	Quantity	Item price	Total items price
	Shipping/handling - UPS Ground	1		
<b>Add additional sheets if more space is needed.</b>			<b>Total:</b>	

Measuring: The figure below is a diagram for measuring a bridle.

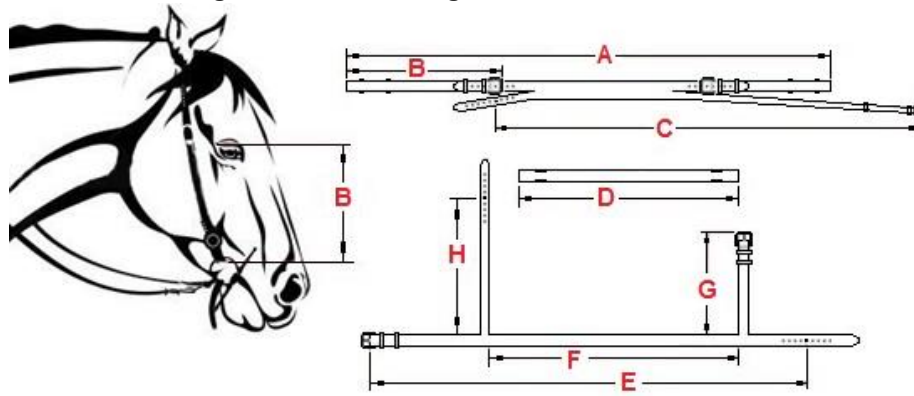

A = Bit-to-Bit B = Cheek C = Throat D = Browband

E = Nose F = Between nose hd-ck G = Nose cheek H = Head strap

- A. **Bit-to-Bit:** From end of cheek piece attached to bit over the poll to end of other cheek piece.
- B. **Cheek:** Length of cheek piece so buckle is lined up with the rear corner of the eye or just slightly above the rear corner of the eye.
- C. **Throat:** from buckle **all the way around the neck at the poll to the hole buckled in.** Place a couple fingers of slack under the gullet. Verify the "C" measurement is taken all the way around the neck at the poll as shown in the diagram above.
- D. **Browband:** find one that fits snug without pinching at the ears, lay out flat on a surface and measure from one end to the other.
- E. **Noseband:** from buckle all the way around the nose **to the hole buckled in.** Measure about 1/2 inch below the cheek bones.
- F. **Between nose head and nose cheek:** across the front of nose, start and stop about 1/2 inch behind cheek bones.
- G. **Nose cheek:** from noseband to rear corner of the eye.
- H. **Nose head:** from the noseband on the far side, over the poll to the rear corner of the eye on the near side.

Bit-to-Bit: \_\_\_\_\_ Cheek: \_\_\_\_\_ Throat: \_\_\_\_\_

Browband: \_\_\_\_\_ Noseband: \_\_\_\_\_ Nose cheek: \_\_\_\_\_

Between nose head and nose cheek: \_\_\_\_\_ Nose head: \_\_\_\_\_

**Standing Martingale:**

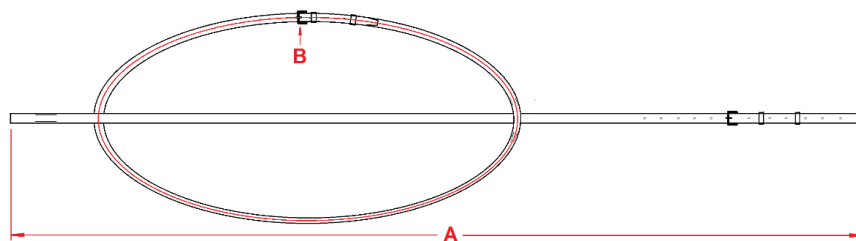

A. Belly Strap: measure adjusted length \_\_\_\_\_

B. Neck Strap: measure adjusted length \_\_\_\_\_

## APPENDIX C-1

THANK YOU FOR ORDERING SADDLERY FROM J. B. WIEBE III, LLC.

**BEFORE DOING ANYTHING WITH YOUR ORDER, PLEASE CONFIRM THE FIT.**

Please do not fold or bend new unconditioned straps back on themselves, especially the ½ Round and Fancy stitched straps as this can cause irreparable damage to new unconditioned straps.

Do not oil or condition the leather until fit is confirmed. Oiled or conditioned leather cannot be returned.

**WARNING: DO NOT PLACE LEATHER IN HOT OIL OR HOT STAIN.**

**THIS WILL DESTROY THE LEATHER.**

You may exchange new unused standard size stock **21<sup>st</sup> Century**® strap good items that are not Made To Order that have not been oiled, stained, soaped or otherwise conditioned, or blemished from handling for alternative sizes of equivalent value to give a nearly custom “made-to-measure” fit. Please return any new unused and unblemished **21<sup>st</sup> Century**® stock parts that were not made to order for exchange within 2 weeks of delivery. We do not charge a restocking fee. We charge for shipping and handling on exchanges.

Items made to order regardless of size, including **Bennett’s Hunter**®, **Jimmy Wiebe Memorial**®, and **20<sup>th</sup> Century**® **Custom** items, are **Final Sale** and may not be returned or canceled.

**CAUTION: I do not recommend oiling our leather**, but if you must oil it, please use as little oil as possible. Oiling can cause the aniline dye we use to stain the edges to bleed into stitching and this may also stain your hands. Wear rubber gloves when oiling and avoid drawing edge stain into the stitching, especially the ½ round fancy stitching.

Begin by applying **no more than 3 very light coats** of Fiebing’s™ Neatsfoot Oil Compound with a new clean paintbrush.

**Do not use Pure Neatsfoot Oil.** Only oil in moderation. Do not soak, dip, or otherwise overoil the leather. Excessive oiling can damage the leather resulting in more stretching, shorter leather life, and can damage the leather.

**Do not use colored stain which will ruin the appearance of the fine hand stitching.**

Light oiling will help start to darken our Light Havana and Newmarket color English equestrian leather and will begin the conditioning and breaking in process. Using Fiebing’s Yellow Paste Saddle Soap will also help start to darken the leather.

**Oiling will not change our darker Nut Brown color much at all and we do not recommend oiling it.**

After initial oiling and conditioning with Fiebing’s yellow paste saddle soap, do not oil the leather again. Continue to condition your saddlery as noted on the next page with regular use. This will give the best long-term results.

Sincerely,

*Jim Wiebe*

Managing Director

J. B. Wiebe III, LLC

429 E. Commerce St., #112

Hernando, MS 38632

Email: [FineBridle@aol.com](mailto:FineBridle@aol.com)

Website and online catalog: <https://jbiebe3.com/shop>

© 2020 by J. B. Wiebe III, LLC. All rights reserved.

## APPENDIX C-2

### J. B. Wiebe III LLC's fine quality English equestrian leather care instructions

We do not recommend oiling the leather, but if you must oil the leather, begin by applying 2 or 3 **very light coats** of **Fiebing's™ Neatsfoot Oil Compound** using a new clean paintbrush. **Do not use Pure Neatsfoot Oil.** Do not soak or dip the leather in oil. Excessive oiling can result in more stretching as the parts break in and reduce the durability and life of the leather. Excessive oiling can damage the leather.

**CAUTION: oiling may cause the edge stain to bleed into stitching and may stain your hands.** Wear rubber gloves when oiling and use as little oil as possible to begin darkening our lighter leather colors: Light Havana and Newmarket. Do not oil our Nut Brown color leather which will not darken with oiling. **NEVER HEAT THE OIL.**

Next, being careful not to draw edge stain into the stitching, especially the fancy stitching, apply **Fiebing's™ Yellow Paste Saddle Soap** to the grain and flesh sides of the leather as a conditioner with a **dry natural sea sponge** or other **dry** soft sponge. There are fats and greases in this yellow saddle soap that condition the leather, but won't over-oil it or make it too soft. This soap also removes excess grease and wax from the English leather currying process that is laying on the outer surfaces leaving a semi-tacky finish. Continued use of Fiebing's Yellow Paste Saddle Soap will further condition and break in the leather and continue to darken it.

Note that any oiling, conditioning, cleaning, use, and handling will change, soil, or discolor thread appearance somewhat. This is normal wear and should be expected. Avoid handling the stitching, especially the fancy stitching, as much as possible to keep it looking its best and it will last longer.

We don't guarantee darkening of the leather to a specific color. Our intent using Light Havana and Newmarket color English equestrian leather is to give a good starting point. Darkening will take some time.

Clean after every use with mild castile soap and a little warm water (**don't soak leather in water**). For cleaning, **unscented Ivory™ white hand bar soap** works well or mild Belvoir Castile Glycerin Soap. We do not recommend using other glycerin or "one step" soap-conditioner which will build up a black slime of soap, dirt, and sweat on the leather and thread.

After each cleaning, use **Fiebing's™ Yellow Paste Saddle Soap** with a **dry** sponge **before the leather dries**. Pull from the middle of the strap towards the strap ends with the sponge and finish up with a clean linen stable rubber or soft cotton cloth in the same direction to keep edges and flesh side of the straps smooth. This will do the best job conditioning the leather and setting you up to have it last the longest with a firm supple feel and minimal wear.

To restore old leather or leather that was in storage and is dry, hard, or brittle, several light coats of our **J. B. Wiebe III, LLC, English Currier's Dubbin** (tallows, greases, and wax) is the best option. We sell small jars of this premium leather conditioner. It is the best on the market, sourced from our English equestrian leather curriers in England and is only available from J. B. Wiebe III, LLC.

**A word regarding repairs:** We repair what we sell. We strongly encourage our customers to send our finely hand stitched custom bridles and other saddlery to us for any needed repairs. We have had customers send our custom bridles to us for repair after trying to get them repaired at a local tack shop or horse show tack trailer vendor for repair, and the parts repaired were damaged by tools too large for our finest hand stitching. This kind of damage is often not restorable, so please return any items requiring repair to us to repair.

We hear from customers that are still using Jimmy Wiebe's bridles sold over 60 years ago, and my bridles sold in the mid-1980's. A customer contacted me in 2016, to let me know she was taking a custom monogrammed lead shank I made for her in the early 1980's to the 2016 Olympic games for use with the US Olympic team. She was still using that lead shank in 2021. Another lifelong friend contacted me in 2024 to tell me she was still using a bridle I made her in 1983.

The quality craftsmanship together with consistent care and regular use will give many years of service. Thank you for your order. We wish you many years of use with our handcrafted **Wiebe Heirloom Quality®** bridle work.

Sincerely,

*Jim Wiebe*

Managing Director

J. B. Wiebe III LLC

429 E. Commerce St., #112, Hernando, MS 38632

[FineBridle@aol.com](mailto:FineBridle@aol.com)

<https://jbwiebe3.com/shop>

© 2020 by J. B. Wiebe III, LLC. All rights reserved.



## APPENDIX C-3

# SADDLERY HORROR STORIES

(What **not** to do if you want your tack to be safe, to last, and look its best.)

Told by Jimmy Wiebe, “*The Stitcher*,” and his son, Jim Wiebe, of J. B. Wiebe III, LLC

What follows are true accounts of what some of our past customers did to their tack.  
We saw the results first hand.

**DO NOT DO ANY OF THIS! SOME OF THESE POOR CHOICES ARE DANGEROUS AND CAN LEAD TO INJURY OR DEATH AT HOME ON YOUR FARM OR IN A SHOW RING!**

1. French frying a new bridle in hot oil
2. Staining a bridle with gasoline. **This is a fire hazard** and can damage leather.
3. Soaking a new bridle in Pure Neatsfoot Oil or Neatsfoot Oil Compound
4. Soaking a new bridle in olive oil
5. Soaking a new bridle in mineral oil
6. Dipping a new saddle in oil
7. Cleaning and conditioning tack with vegetable oil based “one-step” Murphy’s Soap
8. Conditioning and cleaning with a “one-step” cleaner/conditioner
9. Leaving bridles under the rear window of a closed car on a hot summer day in central Arizona
10. Bending raised or half round straps 180° back on themselves and splitting at the center of a hand sewn fancy stitch
11. Scrubbing a bridle with an Emory sandpaper dish washing pad and damaging thread and leather’s grain surface
12. Washing a bridle with soapy water and leaving it to dry without conditioning the leather
13. Riding in the rain, soaking the bridle in water, and leaving it on a tack hook to dry without conditioning the leather
14. Placing wet tack in a closed tack trunk and leaving it to grow mold
15. Using an open flame to burn back the end of a loose thread – and burning the leather
16. Attempting to repair loose saddle billets without the tools or skill to do so
17. Punching more holes in a stirrup leather or bridle strap using a pocket knife, heavy nail, or ice pick and tearing the leather
18. Putting away tack dirty, covered with mud, manure, sweat, sand, and other filth

© 2020 by J. B. Wiebe III, LLC. All rights reserved.

# BENNETT'S HUNTER® CUSTOM

3 DIAMONDS



2 DIAMONDS WITH 3 LETTER MONOGRAM



2 DIAMONDS WITH 4 TO 14 LETTER NAMES



**JIMMY WIEBE MEMORIAL® CUSTOM**

DIAMOND CENTER



NO DIAMOND



NO DIAMOND WITH 4 TO 14 LETTER NAMES





Photo courtesy of Ann Huberth

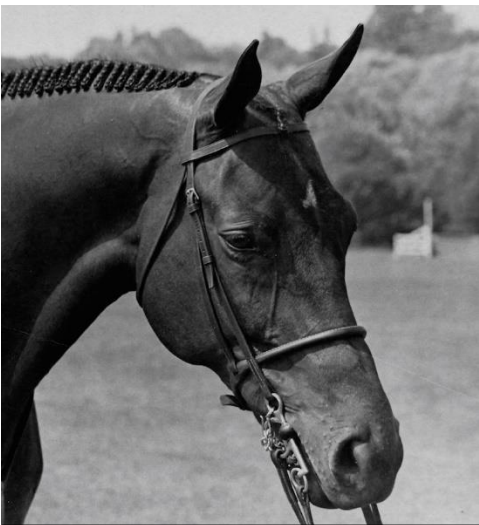

Photo courtesy of Lynn Earl Gola McLanahan

**WIEBE HEIRLOOM QUALITY®**  
**CUSTOM SADDLERY**

**BENNETT'S HUNTER® AND**  
**JIMMY WIEBE MEMORIAL®**  
**CUSTOM BRIDLES, SADDLERY, AND**  
**LEATHER ACCESSORIES FOR THE**  
**HOME AND STABLE OFFICE**



© 2023 by J. B. Wiebe III, LLC.  
 All rights reserved.